

TM 9-867

WAR DEPARTMENT TECHNICAL MANUAL

MAINTENANCE AND CARE OF HAND TOOLS

WAR DEPARTMENT •

APRIL 1945

WAR DEPARTMENT TECHNICAL MANUAL
TM 9-867

MAINTENANCE
AND CARE OF
HAND TOOLS



WAR DEPARTMENT

APRIL 1945

WAR DEPARTMENT
Washington 25, D. C., 19 April 1945

TM 9-867, Maintenance and Care of Hand Tools, is published for the information and guidance of all concerned.

[A.G. 300.7 (20 Nov 43)]
[O.O. 461/60440 Raritan]

BY ORDER OF THE SECRETARY OF WAR:

G. C. MARSHALL,
Chief of Staff.

OFFICIAL:

J. A. ULIO,
Major General,
The Adjutant General.

DISTRIBUTION: AAF (10); AGF (5); ASF (2); Dept (10); AAF Comd (2); Arm & Sv Bd (1); S Div ASF (1); Tech Sv (2); SvC (10); PC&S (1); PE (Ord O) (5); Dist O 9 (5); Dist Br O 9 (3); Reg O 9 (3); Establishments 9 (5); Decentralized Sub O 9 (3); Gen & Sp Sv Sch (10); USMA (20); A (10); CHQ (10); D (2); B 2, 4-8, 18, 44 (1); R 2, 4-11, 17-19, 44, 55 (1); Bn 2-11, 17-19, 44, 55 (1); C 2-11, 17-19, 44, 55 (1); AF (2); W (1); G (1); S (1); F (1).

Refer to FM 21-6 for explanation of distribution formula.

CONTENTS

<i>Section</i>	<i>Page</i>
I Introduction	2
II Abrasive Wheels and Oilstones	5
III Awls	11
IV Bits and Boring Tools	14
V Braces and Hand Drills	24
VI Brushes	26
VII Calipers	29
VIII Chisels	33
IX Clamps	39
X Dividers	42
XI Files and Rasps	44
XII Hammers, Mallets, Mauls, and Sledges	47
XIII Hand Grinders	51
XIV Hatchets, Axes, Mattocks, Adzes, and Shovels	53
XV Hydrometers	58
XVI Knives	59
XVII Levels	62
XVIII Nippers and Pliers	64
XIX Planes	67
XX Punches	74
XXI Reamers	77
XXII Saws	79
XXIII Scrapers	89
XXIV Screwdrivers	92
XXV Shears	96
XXVI Soldering Irons	100
XXVII Taps and Dies	103
XXVIII Vises	107
XXIX Wrenches	109
XXX References	112

INTRODUCTION

PURPOSE AND SCOPE

This manual is published for the information of arms and services charged with care of hand tools. It is intended to serve as a guide and ready source of definite information for personnel having some previous knowledge in the operations covered. Insofar as practicable, descriptive and use-of-tools information is omitted in order to devote more space to care of tools. The efficiency of a mechanic and the tools he uses are determined to a great extent by the condition in which that mechanic keeps the tools. Likewise a mechanic can be judged by the manner in which he handles and cares for tools. Micrometers, or any other precision tool, must be handled with a careful, delicate touch and precision, commensurate with the extreme accuracy with which these tools are capable of measuring. It is with joy and great interest that everyone watches a skilled mechanic at his work, and this is largely due to the care and precision with which he uses the tools of his trade. There is a place for every tool and he keeps each tool in its place. He carefully wipes his tools clean and dry before he places them in the tool box. If he does not expect to use a tool again for some time he lubricates it to prevent rusting.

NOTE: When storing tools under conditions of extreme humidity, moisture or salt air, it may be desirable to use preservative lubricating oil (medium) instead of the preservative lubricating oil (special) or engine oil (SAE 10) prescribed in this manual for normal conditions.

LIST OF TOOLS

Abrasive Wheels and Oilstones Abrasive wheels Oilstones	Braces and Hand Drills Braces Breast drills Hand drills
Awls Handled seat awl Brad awl Saddler's sewing awl	Brushes Painter's dust Sash tool Steel wire Stencil Varnish
Bits and Boring Tools Auger bits Countersink bits Expansive bits Screwdriver bits Twist drills	

Calipers

- Firm joint
- Inside and outside micrometers
- Inside and outside spring

Chisels

- Blacksmith's
- Machinist's
- Woodworker's

Clamps

- C-type
- Hand screw
- Hydraulic brake cylinder
- Toolmaker's

Dividers

- Spring
- Wing

Files and Rasps

- Round
- Half round rasp
- Flat
- Taper

Hammers, Mallets, Mauls, and Sledges

- Hammers
 - Bell faced claw
 - Blacksmith's cross peen
 - Blacksmith's straight peen
 - Ding weight
 - Machinist's ball peen
 - Plain faced claw
 - Riveting
 - Soft face (copper, lead, leather, plastic, rawhide, rubber)
 - Trimmer's
- Mallets
- Mauls
- Sledges
 - Blacksmith's cross peen
 - Blacksmith's straight peen

Hand Grinders

Hatchets, Axes, Mattocks, Adzes, and Shovels

Hydrometers

Knives

- Draw
- Pocket
- Putty

Levels

Nippers and Pliers

- Nippers
 - Diagonal side cutting
 - Heavy type
 - Light type

Pliers

- Adjustable combination
- Brake spring
- Flat-nosed
- Half round-nosed
- Round-nosed
- Side cutting
- Tire chain repair

Planes

- Bench
 - Fore
 - Jack
 - Smooth
- Block

Punches

- Hollow
- Solid
 - Center
 - Pin
 - Prick
 - Taper

TM 9-867

Reamers

- Hand reamers
 - Straight
 - Taper
 - Expansion
 - Adjustable
- Power reamers
 - Straight
 - Taper

Saws

- Back
- Bead
- Compass
- Coping
- Crosscut
- Dovetail
- Hack
- Keyhole
- Miter box
- Nested
- Patternmaker's
- Rip
- Stairbuilder's
- Veneer

Scrapers

- Bearing
- Carbon
- Flat
- Three-cornered

Screwdrivers

- Clutch-head
- Offset
- Phillips type
- Spiral ratchet
- Standard

Shears

- Bench
- Bolt cutters
- Curved blade tinner's
- Scroll pivoter snips
- Straight blade tinner's

Soldering Irons

- Electric
- Nonelectric

Taps and Dies

- Taps
 - National series hand taps
 - Pipe
- Dies
 - National series round dies
 - Pipe dies
 - Square
 - Four piece

Vises

- Blacksmith's
- Machinist's
- Pipe
- Utility bench

Wrenches

- Adjustable
- Box
- Open end
- Pipe
- Socket
- Socket head set screw

Section II

ABRASIVE WHEELS AND OILSTONES

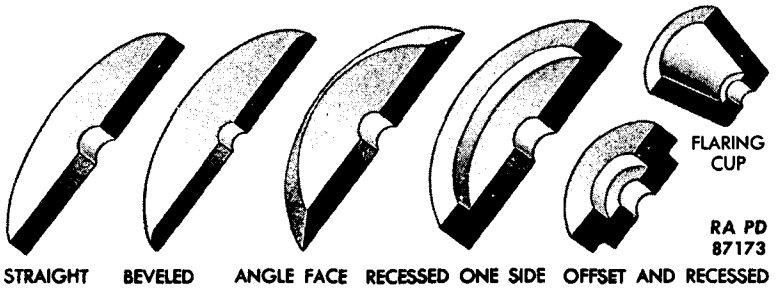

ABRASIVE WHEELS

Maintenance

- Handle wheels with care at all times; they break easily.
- Do not grind on sides or corners of wheel, unless it is impossible to grind the job at hand on the face of the wheel. This rule should be observed, due to the difficulty of dressing the sides of the wheel.
- When mounting wheel on spindle observe the following precautions:

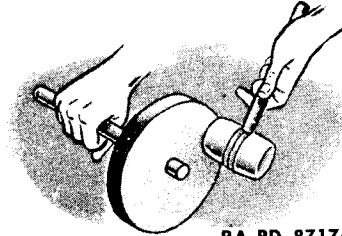

RA PD 87174

Test wheel by tapping with a cellulose face or rubber face hammer or mallet. A ringing sound indicates a satisfactory wheel. A dull thudding sound indicates a cracked wheel. Do NOT use a cracked wheel.

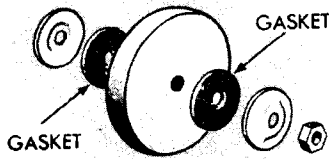

RA PD 87175

Be sure wheel is equipped with blotter paper gaskets or safety washers on each side. If safety washers are used, remove paper from wheel and fit rubber sides next to wheel.

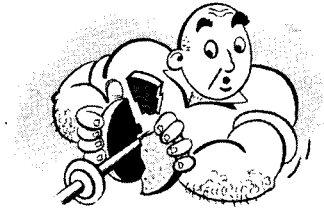

RA PD 87176

Do not force wheel onto spindle. It must slide on easily with 0.003- to 0.005-inch clearance.

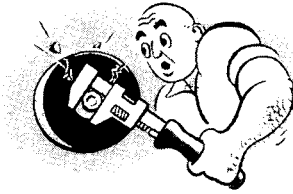

RA PD 87177

Tighten spindle nut just tight enough so flanges hold wheel firmly. Overtightening may crack wheel.

After installing, test wheel for breakage by starting. **CAUTION:** Stand clear!

- If wheel glazes easily (cutting particles become dull), decrease its speed or use softer wheel.
- If wheel loads easily (pores or spaces between cutting particles clog with material being ground), increase its speed or use softer wheel.

Truing

Removal of material from cutting face of a wheel so surface runs true.

Dressing

Restoring sharpness of a wheel face which is "loaded" or dulled.

• • •

On grinding machines, these operations are best done with a diamond dressing tool rigidly supported in a fixed tool post. Abrasive wheel dressers and abrasive type dressers are used on bench or pedestal grinders.

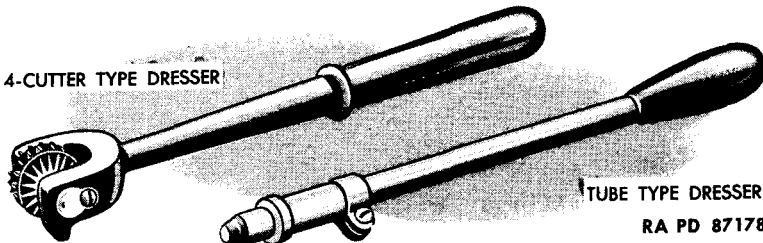

RA PD 87178

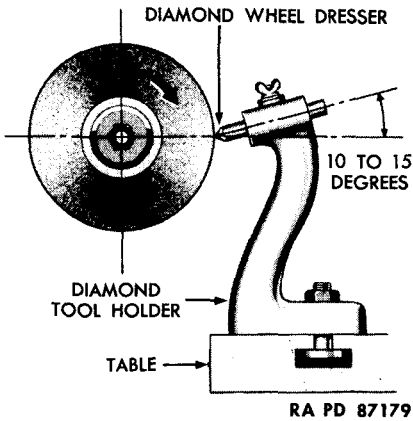

1. Set tool as shown, almost in contact with high point of wheel.

2. Start wheel rotating. Start tool traversing and feed into wheel 0.001 to 0.002 inch at end of each pass until contact is made.

3. Traverse cutter back and forth across wheel face, using 0.001-inch feed until sound indicates dresser is cutting all around the wheel.

NOTE: For wet grinding, dress wet. For dry grinding, dress dry.

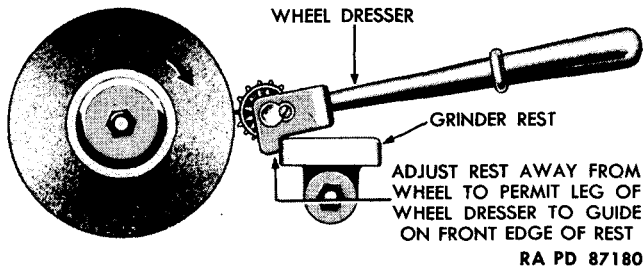

1. Adjust tool rest to permit wheel dresser to contact abrasive wheel on centerline of wheel as illustrated.

2. Start wheel revolving, then support the dresser on tool rest with handle tilted upward at angle shown in illustration.

3. Slowly press the wheel dresser against face of revolving wheel until it "bites," then move dresser from side to side across wheel to obtain a straight surface on the wheel. **CAUTION:** Hold the dresser rigidly enough on tool rest to prevent vibration.

4. Smooth wheel by passing an abrasive type dresser back and forth over the face of the wheel as shown below, smoothing with a very light pressure.

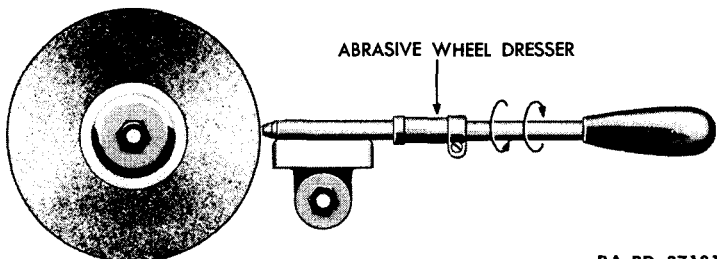

Common Misuses and Abuses

Do not operate wheel which has worn to a small diameter at same revolutions per minute as when new. This causes wheel to act excessively soft and wear fast because of the much reduced speed of grinding surface. Increase revolutions per minute to make up for smaller size.

Wheels not in use must be stowed in racks. If left on the floor they are apt to get broken.

Storage

Suspend wheels through their spindle holes in racks in a dry place, or store them in individual boxes.

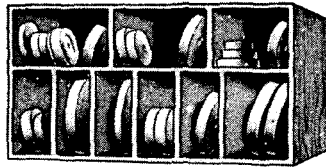

RA PD 87182

OILSTONES



SQUARE



TRIANGULAR

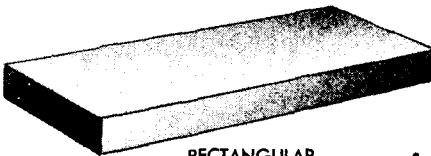

RECTANGULAR



ROUND

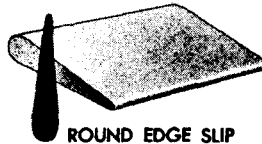

ROUND EDGE SLIP

RA PD 87183

Maintenance

- Soak new oilstone in engine oil (SAE 10) before using.
- Prevent glazing by application of engine oil (SAE 10) during use of stone.
- Wipe stone clean with wiping cloth or cotton waste after each use.



● SOAK IN OIL

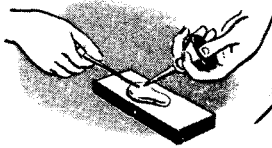

● USE LUBRICANT

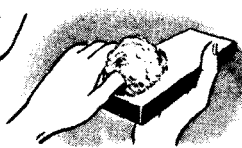

● WIPE AFTER USE

RA PD 87184

Cleaning

Wash glazed or "gummed up" stone with dry-cleaning solvent or aqua ammonia. If this treatment fails to completely clean stone, scour it with aluminum oxide abrasive cloth or flint paper attached to a flat block.

Dressing

True uneven surfaces on coarse, medium, or fine oilstones on side of an old grinding wheel, a grindstone, or as follows: Cover a smooth cast-iron block with waterproof artificial abrasive paper. Place stone on surface and lap in with water until true.

NOTE: Special shape stones can be formed by making a groove of mating shape in a cast-iron block. Use waterproof artificial abrasive paper and water and draw stone through groove.

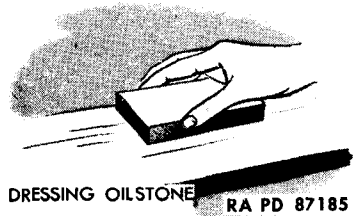

Repairing Broken Oilstone

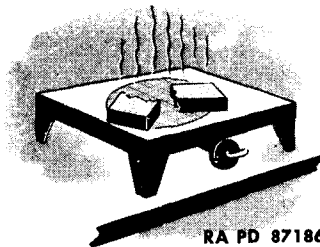

Heat pieces on a hot plate to drive all oil from inside stone.

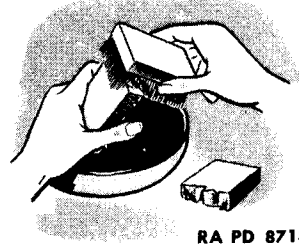

Scrub pieces with dry-cleaning solvent or aqua ammonia to remove gum and dirt.

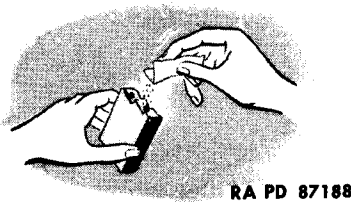

Dust broken edges thickly with flake or ground orange shellac. Carefully work shellac into all cracks and openings.

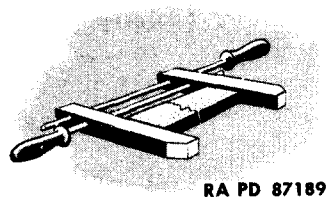

Reheat pieces to melt shellac, and clamp together until cooled. Dress stone if joints are uneven.

TM 9-867

If shellac is not available, mount broken pieces in wooden block. Cut recess in block, exact size of stone, depth about one-half the thickness of stone. Assemble pieces of stone and force into recess in block.

Common Misuses and Abuses

Do not use stone dry. This causes glazing and clogging of stone. Apply engine oil (SAE 10) (or water in an emergency) before using stone.

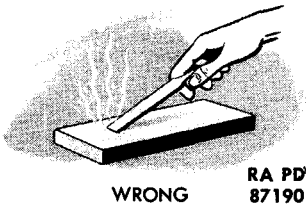

RA PD
87190

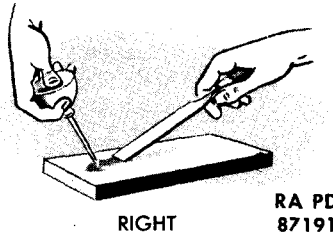

RA PD
87191

Do not store stone in a hot place. Heat will cause oil to form a gummy residue on stone. Store in a cool, moist place.

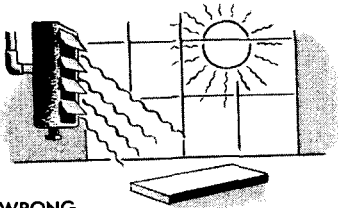

RA PD 87192

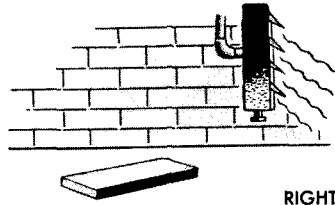

RA PD 87193

Do not attempt to do a honing job with the wrong stone. Such procedure wastes time and energy and causes unnecessary stone wear. Use stones as follows:

STONE	USE
Coarse	To sharpen large and very dull or nicked tools.
Medium	To sharpen ordinary mechanics' tools not requiring finished edge such as tools for working soft wood, cloth, leather, and rubber.
Fine	To sharpen tools requiring a very fine edge such as machinists', engravers', instrument workers', and cabinet makers' tools.

Storage

Keep stone clean and moistened with engine oil (SAE 10). If stored in a dry place, keep stone enclosed in a covered box.

Section III

AWLS

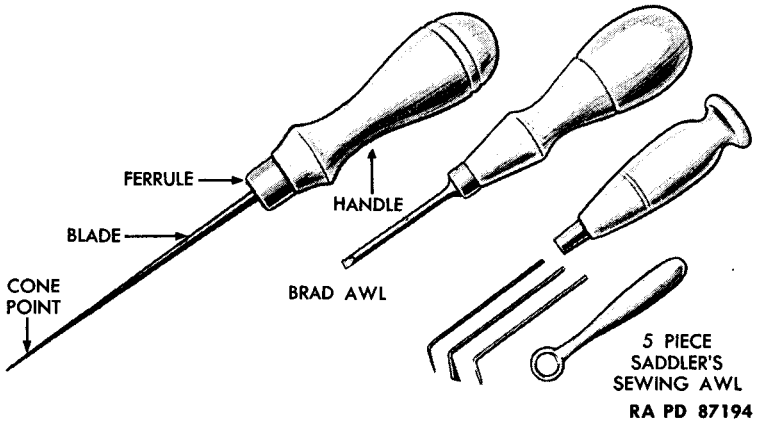

GRINDING AND TEMPERING

General

Normal order for reconditioning an awl blade is to harden, grind, and sharpen. Usually all three operations are not needed. Harden and temper only if tempered part has been broken off, worn, or ground away, or if tool has been overheated. Grind after hardening and tempering, or if blade has lost its shape from repeated sharpening.

Hardening and Tempering

Heat about one and one-half inches of tip of blade to cherry red. Use a gasoline torch, gas furnace, or charcoal fire. Do not overheat. Quench about 3/4 inch of heated tip in clean, cold water to harden.

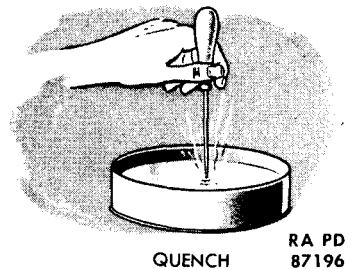
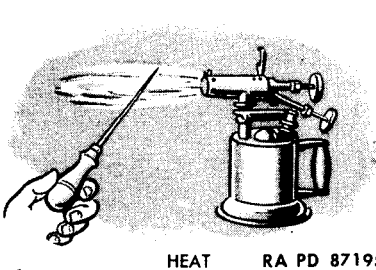

Quickly rub hardened end with aluminum oxide abrasive cloth or oilstone to brighten it. Watch color return to tip from heated portion of blade and quench when light straw color arrives at point. Polish blade with aluminum oxide abrasive cloth and crocus cloth.

Grinding

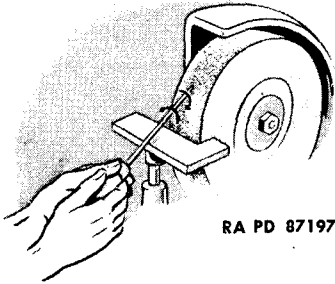

RA PD 87197

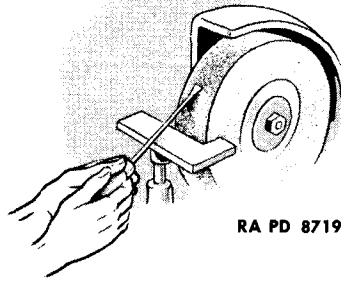

RA PD 87198

Grind blade of cone-pointed awl to point. Rotate awl during grinding to keep point centered. Be careful that the revolving wheel does not catch the point and cause damage. Dip blade frequently in water or wet grind it.

If grinding a flat-pointed or special shaped awl blade, hold blade against abrasive wheel in positions to preserve or restore original shape.

Sharpening

Keep point sharp by frequently giving it a few strokes on an oil-stone. Rotate cone-pointed awl slightly before each stroke. Do not use too much pressure on the tool, to avoid ridge marks on the surface of the stone.

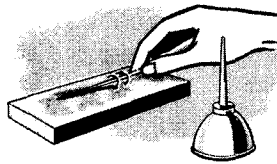

RA PD 87199

Replacing Handles

- Clamp blade in soft-jawed vise and pull or tap old handle from shank of blade. Pry ferrule from handle.
- Tap ferrule onto new handle. Prick punch ferrule to handle.
- Tap handle onto shank of blade and remove blade from vise.

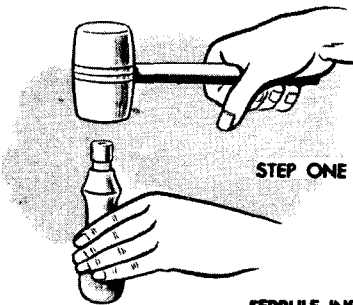

STEP ONE

FERRULE INSTALLATION

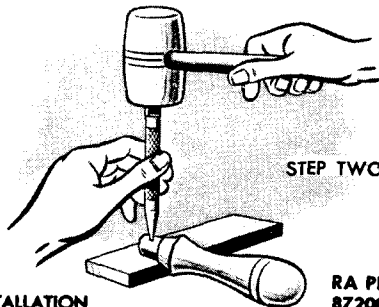

STEP TWO

RA PD 87200

Common Misuses

- Do not use an awl with a loose handle.
This often results in injury to the user.
Make sure the handle is tight, thus preventing the tang from injuring the user's hand.
- Do not use the awl with a prying or lever action.
This results in breakage.
Exert force toward the point or cutting edge.

Storage

Dip awl in rust preventive compound (thin film). To protect the point of the awl, insert the point into a small cork, a small, short twig from a tree, or a soft wood block. Store in a dry place. Protect blade from contact with metals. Upon removal from storage, wash metal parts with dry cleaning solvent to remove rust preventive compound.

Section IV

BITS AND BORING TOOLS

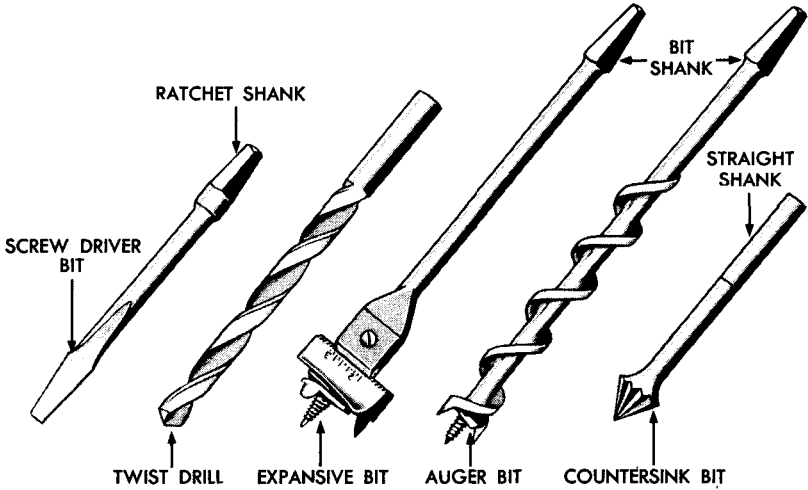

RA PD 87201

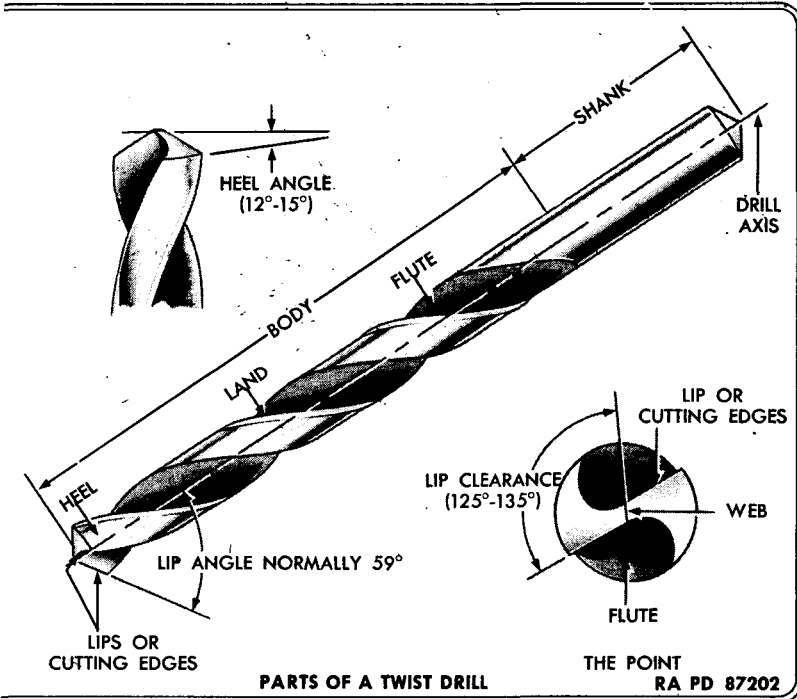

GRINDING TWIST DRILLS

General

Twist drills may be ground in a drill holder fixture or free hand. Use fixture if available. Both methods are given in the following pages.

Grind drill lips or cutting edges at an angle of 59 degrees, as illustrated below (50 to 60 degrees for drilling brass or bronze, 68 degrees for extremely hard material). Both cutting edges must make same angle with drill axis, and both cutting edges must be of same length.

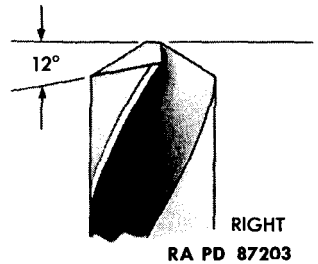
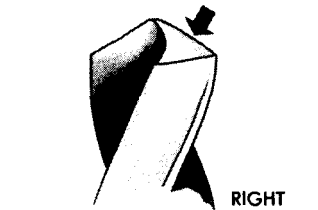
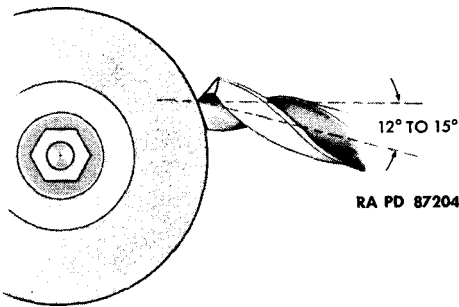
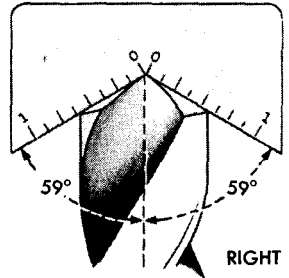

Grind heel to an angle of 12 to 15 degrees (9 degrees for drilling extremely hard material). Failure to provide sufficient clearance is the principal cause of drills splitting up the web.

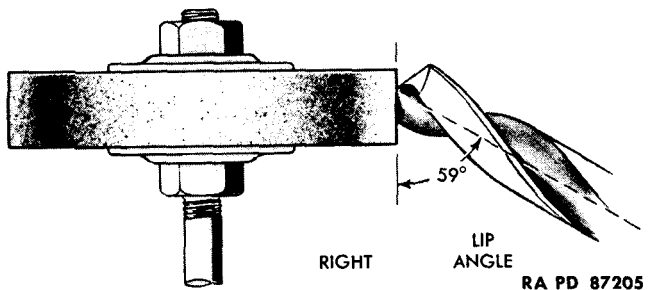

Some Common Grinding Faults to Guard Against:

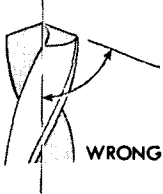
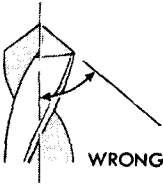
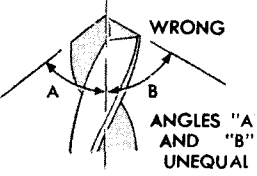
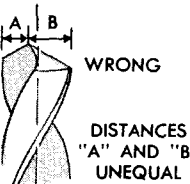
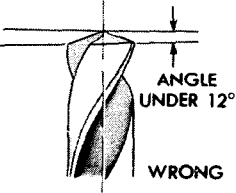
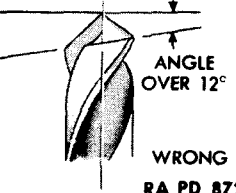
FAULT		RESULT
Lip angle excessive.	 <p>WRONG</p>	Drill will not center properly because cone-shaped point is too flat.
Lip angle too small.	 <p>WRONG</p>	Drills slower and requires more power because of longer length of cutting edges, and requires frequent sharpening.
Point on center but cutting edges ground to different angles.	 <p>WRONG</p> <p>ANGLES "A" AND "B" UNEQUAL</p>	Only one cutting edge will do work. This results in rapid drill wear and causes hole to be larger than drill.
Cutting edge angles are equal but lips are of different lengths.	 <p>WRONG</p> <p>DISTANCES "A" AND "B" UNEQUAL</p>	This throws point and lip off center, causing strain on drill, machine, and work, and causing hole to be much larger than drill.
Insufficient heel angle or clearance.	 <p>ANGLE UNDER 12°</p> <p>WRONG</p>	Cutting edges lose effectiveness. Drill won't drill and may split up center when pressure is applied.
Excessive heel angle or clearance.	 <p>ANGLE OVER 12°</p> <p>WRONG</p>	Cutting edges likely to break down due to excessive bite with insufficient support.

RA PD 87206

Using Drill Holder Fixture

Exact procedure for grinding will vary with make of drill grinding machine used. General procedure, which applies to conventional type machines, is given in the following steps:

Adjust machine to desired cutting edge and heel angles. Refer to illustrations of lip angle and heel angle (page 15).

Place drill in V-blocks of holder. Turn so cutting edge will contact abrasive wheel as drill is fed into wheel.

Start motor and advance tailstock until drill makes contact with wheel.

Hold drill in place in V-blocks and swing holder spindle slowly through its arc. Without changing tailstock adjustment, revolve drill one-half turn in V-blocks and sharpen other lip of drill in same manner.

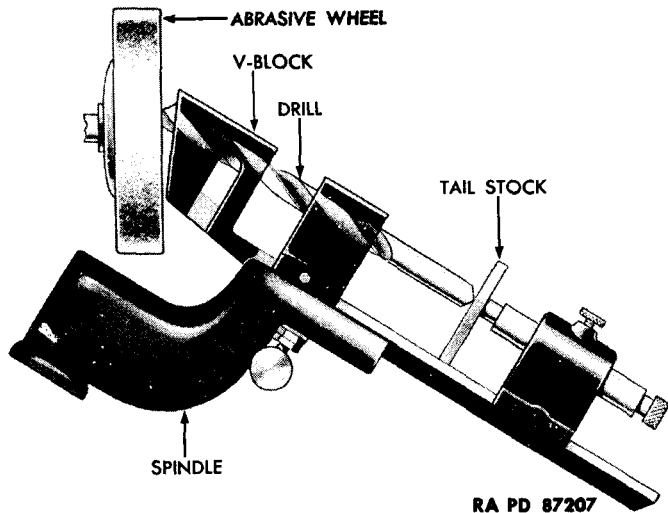

Inspect drill point to see if it has been ground back far enough to eliminate all nicks. Repeat grinding and inspection operations until perfect appearing points are obtained.

Free Hand Grinding

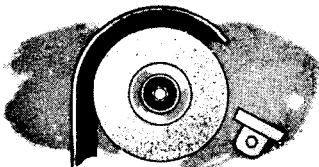

1. Adjust tool rest to a convenient height for resting back of forearm on it while grinding.

TM 9-867

2. Hold drill between thumb and index finger of right or left hand. Grasp body of drill near shank with other hand.

3. Place forehand on drill rest with centerline of drill making desired angle with cutting face of wheel and slightly lower shank end of drill as illustrated.

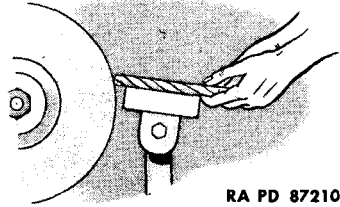
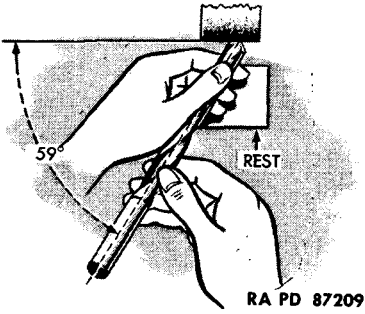

4. Slowly place heel of drill against grinding wheel. Then gradually raise shank end of drill and twist drill in fingers in a counterclockwise direction while grinding wheel approaches the cutting edge. Exert only enough pressure to grind the drill without overheating. Frequently cool drill in water while grinding.

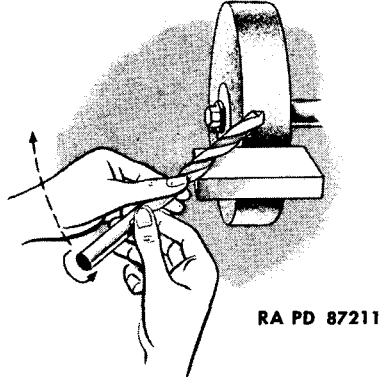

5. Check results of grinding with a gage to determine if cutting edges are same length and at desired angle and if heel is ground to angle of 12 to 15 degrees.

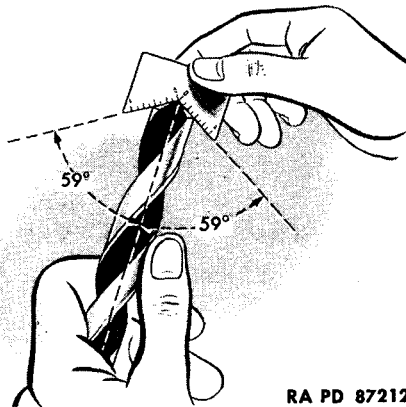
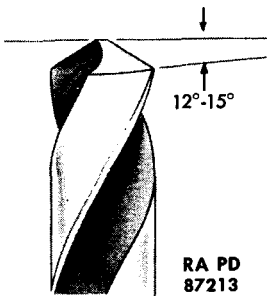

Thinning Web

To strengthen a drill, the thickness of web is increased as flute approaches shank. As point is ground back, the web becomes thicker. Ordinarily a web at the point of greater than $\frac{1}{32}$ to $\frac{1}{16}$ of an inch is objectionable. Grind down web on a thin round or bevel edge wheel to obtain web thickness of a new drill of same size. Use care to remove the same amount of metal from each flute. A coarse handstone may be used to obtain the dimension when a grinding wheel of the proper width is not available. Hold drill flat on bench and stroke flute away from point. Use care to keep from stoning away drill land.

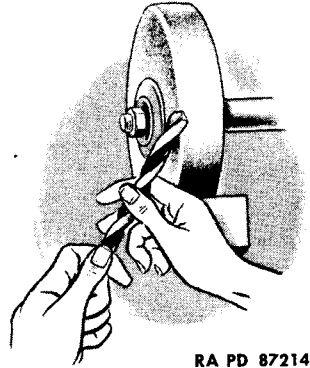

RA PD 87214

Sharpening Expansive Bits

Sharpen spurs and cutters on expansive bit per instructions given for auger bit, below.

Grinding Screwdriver Bits

For method of grinding screwdriver bits, see section 24, "Screwdrivers."

Sharpening Countersink Bits

Use a taper file to sharpen cutting edges of rose countersink bits as illustrated. Use extreme care to retain original shape of cutters.

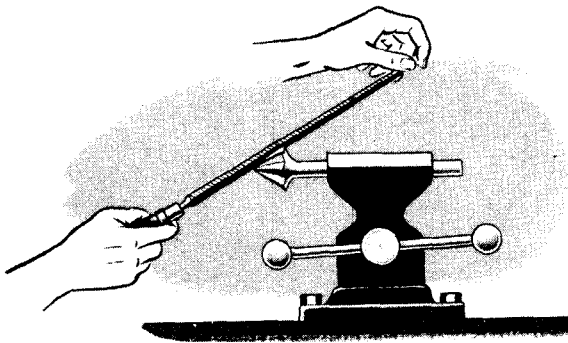

RA PD 87215

SHARPENING AUGER BITS

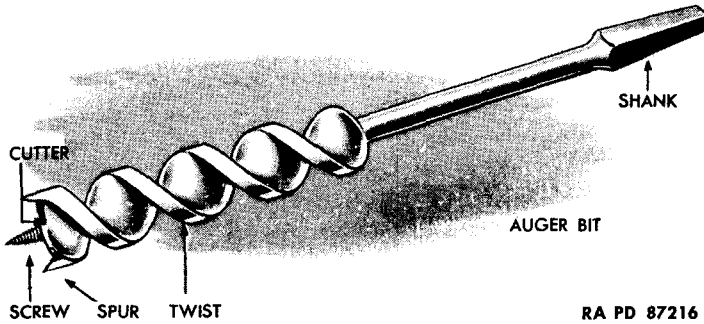

RA PD 87216

Sharpening Spurs

Select an auger bit file or a small mill file.

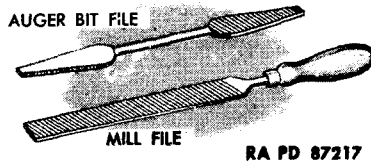

RA PD 87217

Hold auger bit against a solid surface with shank down as illustrated.

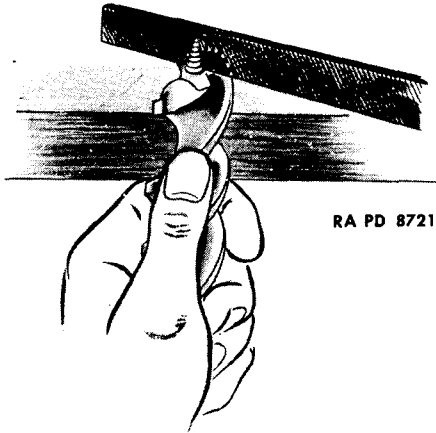

RA PD 87218

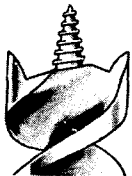

RA PD 87219

Lightly file inside surface of spurs, using care to retain original shape of spur. Stop filing when a fine bur appears on cutting edge of spur. Check to determine if spurs are equal in length.

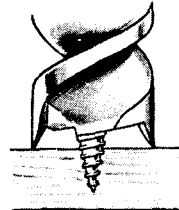

RA PD 87220

Remove bur from spurs with a light touch of file.

Sharpening Cutters

Hold auger bit against a solid surface with screw of auger bit pointing down.

Lightly file each cutter on top side. Use care to maintain original chisel-like shape of cutting edge.

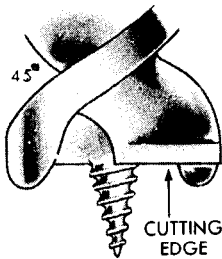

RA PD 87222

Stop filing when a fine bur appears on cutting edge.

Check to determine if cutting edges contact surface of a board at same level.

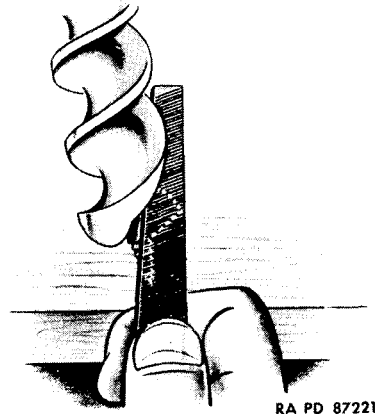

RA PD 87221

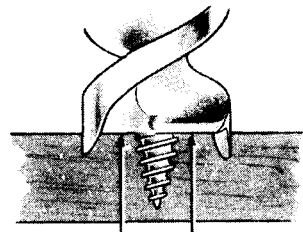

RA PD 87223

Common Misuses to Avoid

Never attempt to enlarge a hole by tipping drill sidwise. You are likely to break or bend the drill or hurt yourself. Use a larger drill or reamer to enlarge hole.

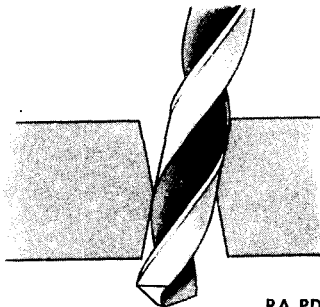

WRONG RA PD 87224

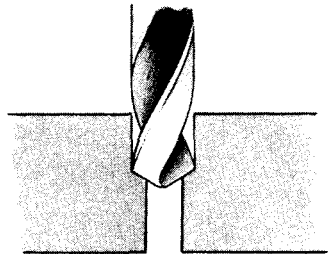

RIGHT RA PD 87224A

TM 9-867

Do not allow drills to overheat while in use or being sharpened. Heating destroys temper and makes tool worthless. Use proper cutting oil or compound when drilling metal other than cast iron. Wet grind drills when sharpening.

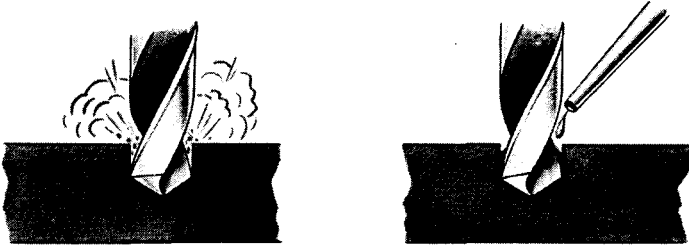

WRONG

RIGHT

RA PD
87225

To drive a drill into a socket or sleeve, do not use a steel hammer or other hard object. This would damage cutting edges. First make certain socket or sleeve and drill shank are clean, then tap drill to seat with a lead or brass mallet.

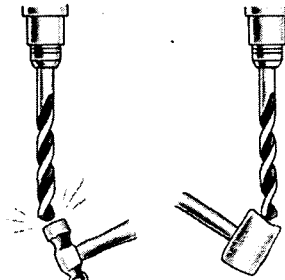

WRONG

RIGHT

RA PD 87225A

Do not place work-supporting blocks far from drill. "Springiness" of work will snap off drill. Support work near drill and clamp securely to prevent turning.

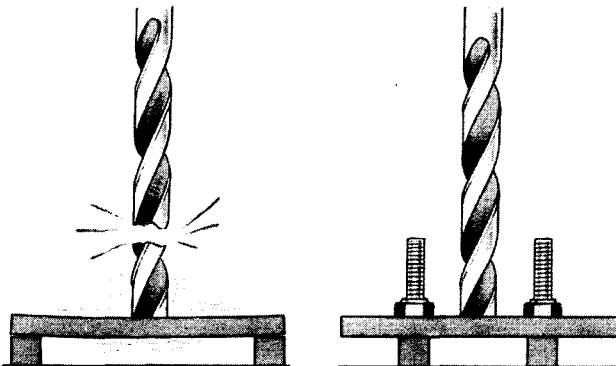

WRONG

RIGHT

RA PD 87226

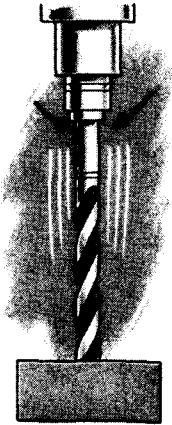

WRONG
RA PD 87227

Do not allow drill to work loose in chuck. This will cause "chucking" and will bur or break drill. Keep drill tight in chuck.

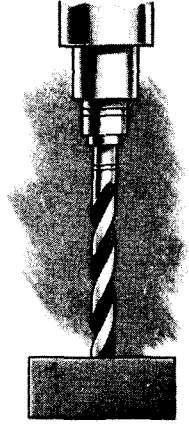

RIGHT
RA PD 87228

Never keep drills loose in tool boxes. This practice causes unnecessary dulling of cutting edges. Keep in a rack or divided box when not in use.

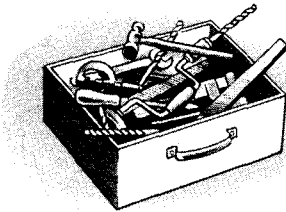

WRONG

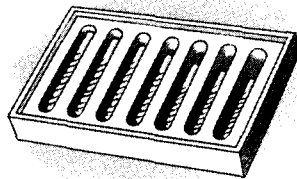

RIGHT

RA PD
87229

Storage

Coat bits and drills with rust preventive compound (thin film) and store in a dry place. Use racks or divided boxes to protect cutting edges from contact with metal. Upon removal from storage, wash with dry cleaning solvent to remove rust preventive compound.

Section V

BRACES AND HAND DRILLS

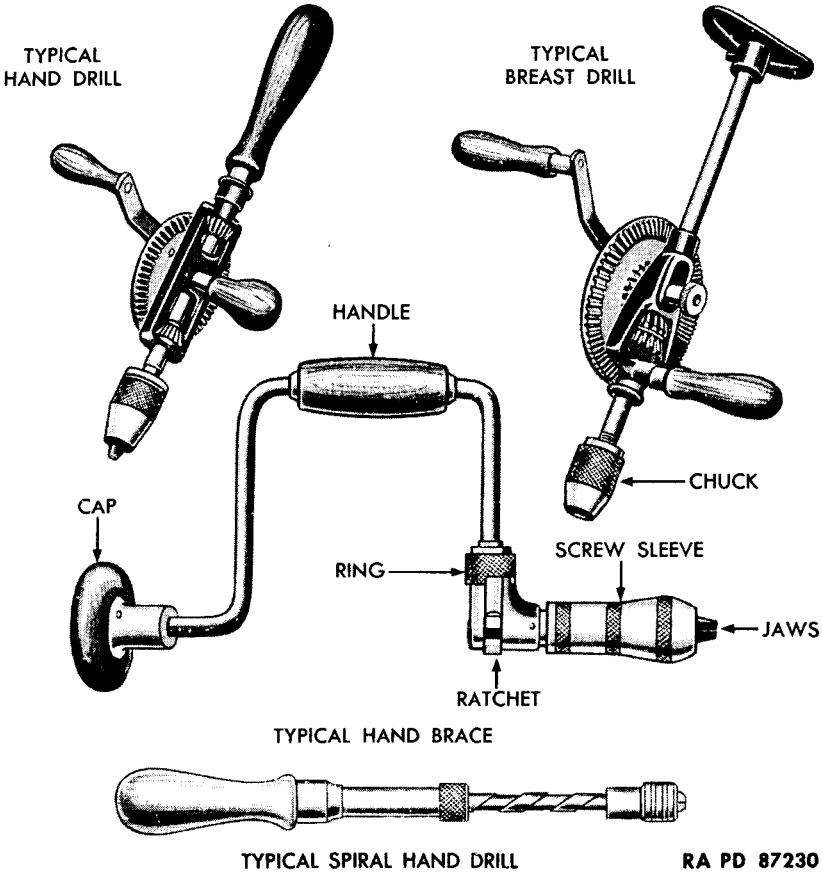

CARE

Keep holding screws tight at all times. Loose screws may permit loose meshing of gears. This causes teeth to break.

Do not disassemble chuck except when necessary to make repairs, because of danger of losing springs.

Do not let tool rust. Scour off rust with crocus cloth or fine aluminum oxide abrasive cloth. Apply lubricating preservative oil (special) or engine oil (SAE 10) lightly to surfaces which tend to rust.

Keep tool lubricated at all times, in accordance with following instructions:

LUBRICATION DATA

TOOL	PART	LUBRICANT
Brace	Cap bearings	GREASE, general purpose, No. 0, or GREASE, O.D., No. 0
	Handle bearings	OIL, engine, SAE 10, or OIL, lubricating, preservative, special
	Ring and ratchet mechanism	
	Sleeve and jaw mechanism	
Breast and hand drills	Gear teeth	OIL, engine, SAE 10, or OIL, lubricating, preservative, special
	Handle bearings	
	Drill chuck mechanism	
	Spirals (push type hand drills)	GREASE, general purpose, No. 0, or GREASE, O.D., No. 0

Common Misuses and Abuses

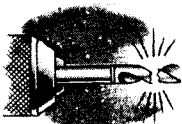

WRONG
RA PD 87231

Do not use tool with bit not fully inserted into chuck. This places a strain on jaws of chuck and may break drill. Insert bit fully into chuck.

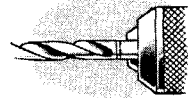

RIGHT
RA PD 87232

Do not use a "squeaking" brace or hand drill. A squeak means tool is wearing. Lubricate before using.

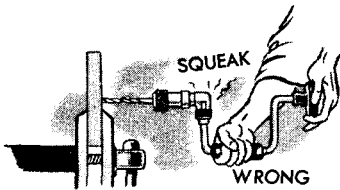

WRONG

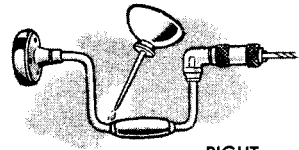

RIGHT
RA PD 87233

Storage

For permanent storage, wash tool in dry cleaning solvent to remove lubricants. Coat all metal parts of tools with rust preventive compound (thin film) and store in a dry place where tool will be safe from accident.

Upon removal from storage, remove rust preventive compound from metal parts by washing with dry cleaning solvent.

Section VI

BRUSHES

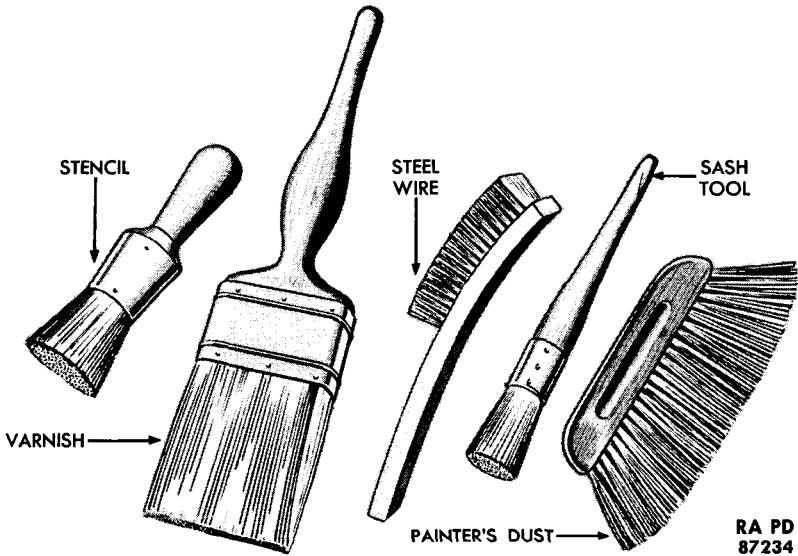

PAINT AND VARNISH BRUSHES

Cleaning Brush After Using

After using brush, squeeze paint or varnish from brush by pressing brush against inside of container. Do not rub brush across edge of can, as that wears and breaks bristles.

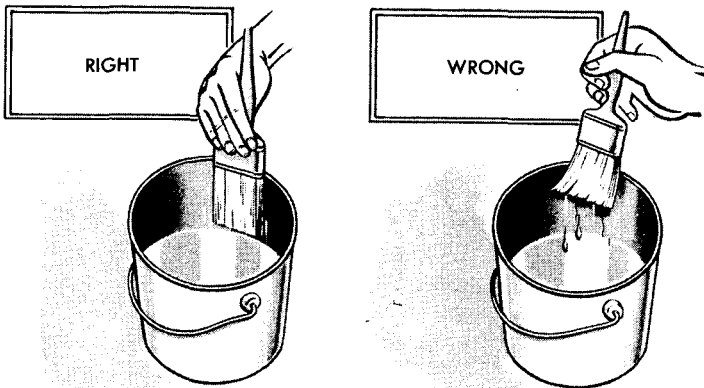

RA PD 87235

Pour small quantity of thinner as prescribed for thinning the particular paint, enamel, varnish or shellac with which the brush has been saturated, into a shallow, wide-mouthed container. Work thinner thoroughly into brush, making certain the base of bristles or hair in setting has been thoroughly immersed.

When brush appears clean, discard the thinner and refill container with clean thinner. Work brush in this until all traces of pigment disappear from brush and until bristles are soft and pliable. Dry cleaning solvent may be used in an emergency in place of synthetic enamel or volatile mineral spirits paint thinner.



RA PD
87236

Cleaning Hardened Paint from Brush

NOTE: Never allow paint to harden on brush. Cleaning is often impossible and always shortens brush life.

1. Scrape paint from bristles with a putty knife.
2. Soak bristles several hours in linseed oil (clear lacquer thinner for lacquer brushes, alcohol for shellac varnish brushes), and clean as above.

Miscellaneous Notes on Brush Care

1. Before using a new brush, tap bristles across edge of a board. Remove all loose bristles which will appear at end of brush.
2. Never stand brushes, wet or dry, on their bristles; once its bristles "set" in a curve a brush is ruined.
3. In charging a brush with paint, do not rub bristles over edge of container to remove excess paint. Tap bristles lightly against inside of container.
4. "Break in" new brushes on first coats. This will increase their pliability and elasticity.
5. Always clean brushes after each use.
6. Always store brushes properly.

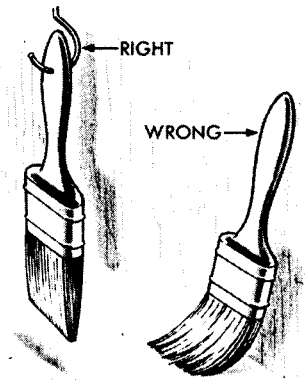

RA PD 87237

Overnight Storage

1. Drill small hole in handle of brush.
2. Suspend paint and enamel brushes in linseed oil "keeper" so that bristles and setting are completely submerged, but do not allow bristles to touch bottom of container.
3. Brushes used with shellac varnish will be cleaned immediately after use, wrapped in paper and kept flat, pending further use.

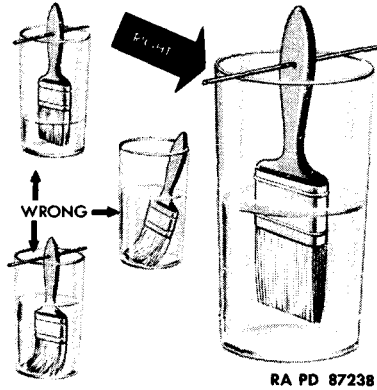

Indefinite Storage

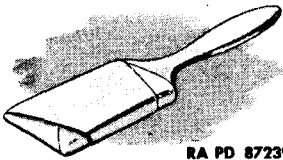

1. Clean brush thoroughly and immerse in linseed oil. Press out most, but not all, of linseed oil.
2. Wrap in oiled paper or brown wrapping paper and store flat.
3. Once every six months, unwrap brush and treat with linseed oil.

NOTE: Brushes used with lacquer or shellac varnish can be wrapped in paper and stored dry.

Care **DUST BRUSHES**

Blow dust from brush with compressed air.

Clean soiled or stained brushes with dry cleaning solvent. Press solvent from bristles and suspend brush by handle until dry.

Storage

Clean brush and wrap in paper. Store brush in flat position.

Care **WIRE BRUSHES**

Clean brushes in dry cleaning solvent and blow dry with compressed air.

Storage

Apply rust preventive compound (light) to bristles. Wrap in greaseproof wrapping paper and store in a dry place.

Common Misuses and Abuses

Improper cleaning and improper storage are the most common abuses of brushes. Clean and store brushes in accordance with instructions above.

Section VII

CALIPERS

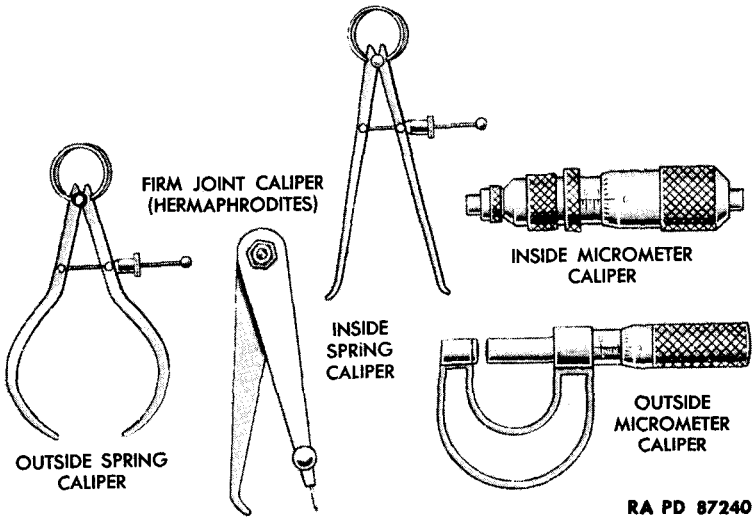

RA PD 87240

General

MAINTENANCE

Calipers are precision instruments and must be used and handled with care at all times. Wipe perspiration and fingerprints from them with a soft cloth; if neglected, this may cause rust. Do not force threaded parts. Use touch measurement. Do not spring or clamp calipers. Keep in case or wrap in soft cloth when not in use.

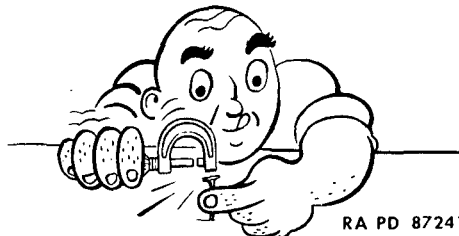

RA PD 87241

HOW NOT TO USE A MICROMETER

Lubrication

Oil threaded and moving parts and friction surfaces (firm joint calipers) with preservative lubricating oil (special). Coat non-operating surfaces with a film of preservative lubricating oil (special).

Cleaning, Inspection, and Repair

1. Disassemble caliper and wash parts in dry cleaning solvent. Dry with a clean, soft cloth.

2. Inspect all threaded parts to be sure all dirt is removed. Scarcely visible particles may cause uneven thread motion and binding.
3. Inspect parts to see if they are rusted, corroded, burred, bent, or worn. Scour with crocus cloth to remove rust or corrosion. Replace parts which are bent, broken, or worn.
4. Lubricate parts as instructed above, and reassemble caliper.

Repair Bent Firm Joint or Spring Caliper

If leg is bent, place caliper on soft metal block. Straighten bent leg to original shape by tapping with brass hammer. Replace bent adjusting screws.

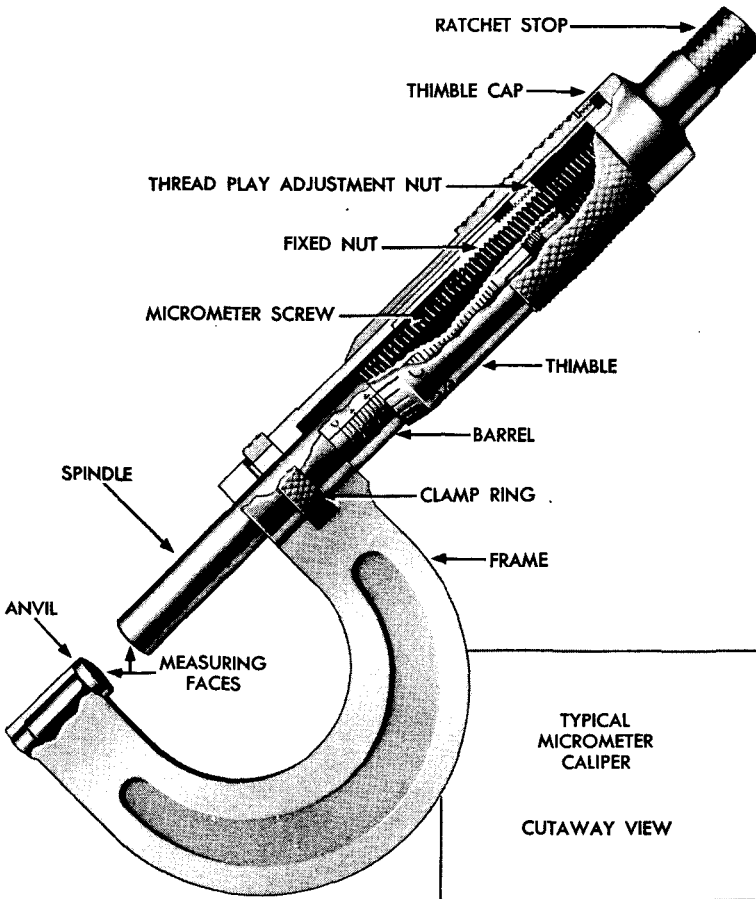

RA PF 87242

Adjustment of Micrometer Caliper

To compensate for thread wear, screw thimble from barrel. Tighten thread play adjustment nut on fixed nut a fraction of a turn at a time. Test fit of micrometer screw in fixed nut. Repeat tightening and test until operation is free from both binding and play.

NOTE: Some micrometers have an automatic spring-controlled thread play adjustment.

Testing Micrometer Caliper

1

Clean measuring faces with a soft cloth. Examine faces after cleaning and remove any lint deposited by cleaning cloth.

2

Measure length of micrometer test gage of same length as minimum capacity of micrometer. Micrometer should read its exact minimum capacity. For 0-1 inch micrometer, screw thimble down until spindle contacts anvil. Do not force thimble. Reading should be 0.000 inch.

3

Measure length of a micrometer test gage of same length as maximum capacity of micrometer. Micrometer should read its exact maximum capacity.

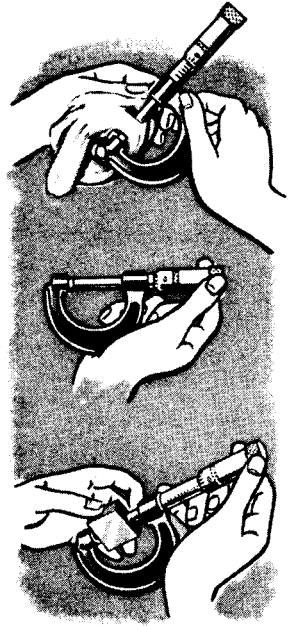

RA PD 87243

Check inside micrometers against outside micrometers or gage blocks.

If in checking it is found that micrometers do not read correctly, refer to proper authority for adjustment.

Never use inaccurate micrometers.

Misuses

Never use micrometers with dirty anvil and/or threads.

Dirt on micrometer anvil gives incorrect readings. Dirty threads cause excessive wear and eventually inaccurate readings.

Do not carry micrometers in a pocket of work clothes, as dirt from the pocket works into the threads.

Keep micrometers in a covered box on the job and wipe anvil and spindle clean with a soft, slightly oiled rag each time after using and before returning them to their places in the box. Keep cover closed to protect micrometers from dirt and grinding dust.

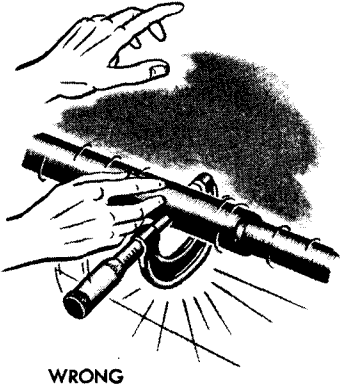

WRONG

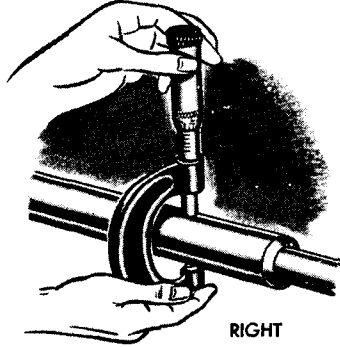

RIGHT
RA PD 87244

Do not check a part that is moving or rotating. Damage to the micrometer and possible injury to the operator will result.



WRONG



RIGHT
RA PD 87245

Storage

Wrap in greaseproof wrapping and enclose in a covered box. Store
oughly and apply a film of preservative lubricating oil (medium).
Wrap in greaseproof wrapping and enclose in a covered box. Store
in a dry place.

Section VIII

CHISELS

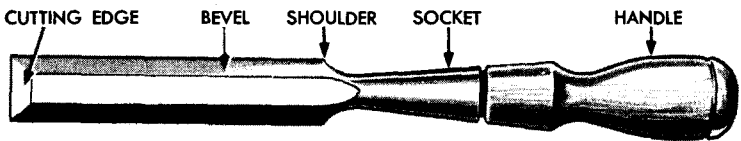
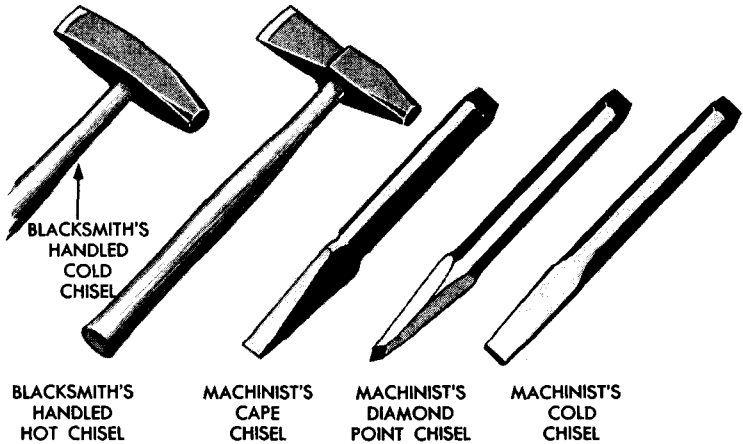

WOODWORKER'S CHISEL (BEVEL EDGE BLADE)

RA PD 87246

CARE (All Types)

Keep chisels properly ground, sharpened, and free from mushroom head at all times. Scour off all rust or corrosion and protect metal surfaces with a film of preservative lubricating oil (special) or engine oil (SAE 10). Keep chisels in a rack or box designed to protect cutting edges from contact with metal.

GRINDING WOODWORKER'S CHISEL

General

Grinding is necessary when cutting edge is nicked, when bevel is worn too blunt to sharpen on an oilstone, or when bevel is rounded out from incorrect sharpening. Before reshaping cutting edge of a chisel by grinding, there are two important things to remember:

1. Bevel may be slightly concave or perfectly straight. It must never be rounded out.

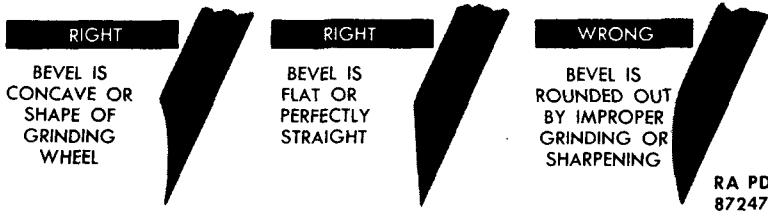

2. Bevel should be about twice the thickness of chisel near cutting edge.

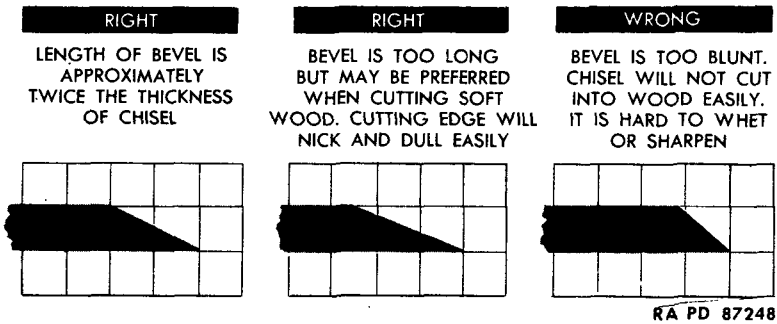

Procedure

CAUTION: While grinding, keep chisel cool by frequently dipping into water to prevent burning or softening of the steel.

1. Square cutting edge and remove nicks if necessary.
2. Adjust rest on grinder to position which will give correct bevel.
3. Reshape bevel by moving chisel from side to side to grind all parts of bevel evenly and to keep grinding wheel true.
4. Check bevel to make sure it is straight across and at right angles to sides of chisel.

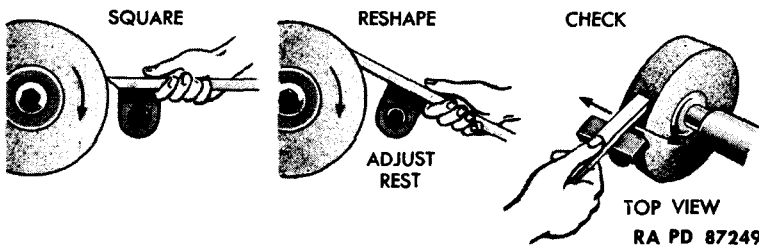

NOTE: Special holding fixtures are available. Their use greatly simplifies grinding of chisel type tools.

SHARPENING WOODWORKER'S CHISEL

Whetting

Always whet chisel after grinding. Once chisel is ground, it can be kept sharpened for a long time by whetting as often as necessary.

1. Clean oilstone and place enough oil on it to wet surface.
2. Place chisel on stone as shown in illustration to obtain correct angle.
3. Hold chisel firmly and move it back and forth along entire length of stone.

CAUTION: Avoid wearing a groove in stone. Move chisel evenly over entire stone.

4. Place flat side of chisel on stone as illustrated and remove wire edge.

5. Repeat stoning of bevel and flat until chisel is sharp.



RA PD 87250

Stropping

For an extremely keen edge, finish with a few strokes on a leather strap, or by stropping first on one side and then on other on a soft wood block.

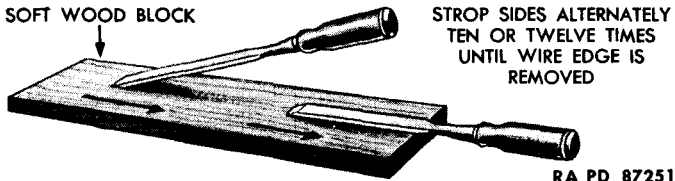

RA PD 87251

REPAIRING MUSHROOMED HEAD (Woodworkers' Chisel)

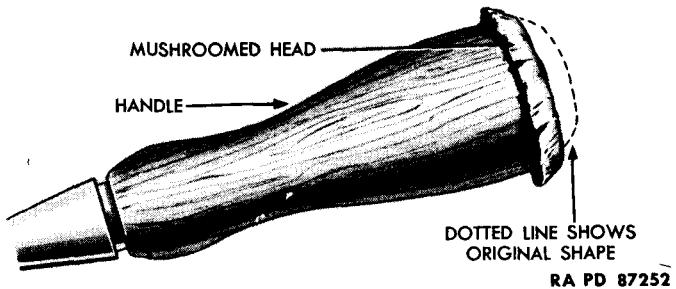

RA PD 87252

Chisel heads become battered or mushroomed after considerable use. To make a permanent repair:

1. Remove handle from chisel. Saw handle off at point of contact with head.
2. Turn end of handle down to about $\frac{7}{16}$ -inch diameter for about $\frac{3}{8}$ inch.
3. Cut leather or fiber washers to fit snugly over tip cut on end of handle. Be sure outside diameter of washers slightly exceeds outside diameter of handle. Cut enough washers so their total thickness equals or slightly exceeds height of tip on end of handle.

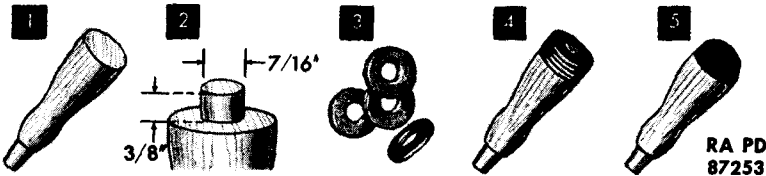

4. Glue washers onto end of handle. Clamp until glue dries.
5. Grind, sand, or cut washers down to conform to shape of handle.

REPLACING HANDLE (Woodworkers' Chisel)

1. Pull old handle from socket. If handle is broken off in socket, drill it out.
2. Shape end of new handle until it is a snug fit in socket.
3. Place blade in soft-jawed vise and tap handle to seat in socket.

MAINTENANCE OF BLACKSMITHS' AND MACHINISTS' CHISELS

Grinding

The cutting angle of a chisel is determined according to the hardness and toughness of the materials being cut. An included cutting edge angle of 70 degrees does well for most work. While chisels used on hard or tough metal require greater strength backing up the cutting edge, an angle up to 90 degrees may be used for this purpose. The cutting angle can be decreased somewhat from 70 degrees for cutting softer metals.

ANGLE "A" IS USUALLY 70°. IT IS SOMETIMES GROUND AT UP TO 90° FOR CUTTING EXTREMELY HARD METAL

CUTTING EDGE SLIGHTLY CURVED

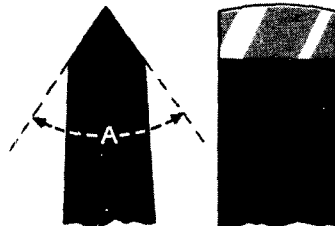

RA PD 87254

Set rest to secure desired bevel angle. Move chisel head from side to side a little during grinding to slightly curve cutting edge. Turn chisel over to grind other bevel. Keep bevels same size or cutting edge will not be centered. Dip chisel frequently in water to preserve temper. **NOTE:** After several grindings, cutting end of chisel may be too thick. Such chisels can be heated and reforged, tempered, and ground.

Hardening and Tempering Machinists' Chisels

Heat whole chisel to cherry red in a gas furnace or charcoal fire. Grasp chisel in center with tongs. Dip cutting end in clear, cold water to a depth of about 1¼ inch. Turn chisel over and dip head end about 1 inch. Quickly polish hardened ends with a file, or aluminum oxide abrasive cloth. Watch color return from heated center section of chisel to ends. Redip cutting end every time end becomes purple. Redip head end every time it becomes blue. When red disappears from chisel, dip whole tool.

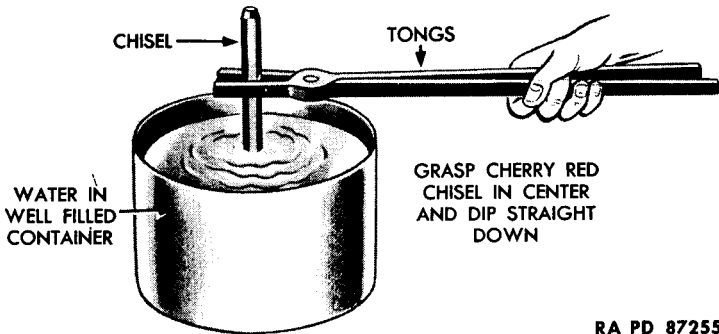

RA PD 87255

Removing Mushroomed End From Machinists' Chisels

It is dangerous to use a metal-cutting chisel with a mushroomed head. Grind head to original shape. Harden chisel after removing mushroom.

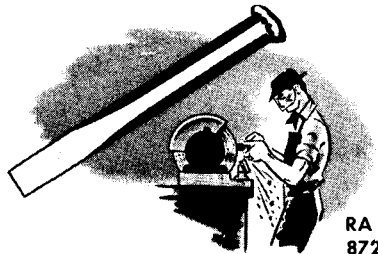

RA PD 87256

Replacing Handles on Blacksmiths' Chisels

Follow procedure given under Hammers, Mallets, Mauls, and Sledges (section 12).

Common Misuses and Abuses

Drawing temper or burning during sharpening.

Exerting too much pressure against the wheel during sharpening

causes excess heat at the cutting edge of the chisel. When and if the temperature of the cutting edge goes above the temper drawing heat, it causes the cutting edge to lose the hardness required for cutting edges. If the cutting edge of the chisel colors to blue or pale blue, the loss of temper has taken place. Exerting light pressure and frequent cooling in water while grinding is the proper preventive maintenance. If the cutting edge becomes too soft due to too much heat in grinding or too frequent grinding, the chisel must be hardened and the temper drawn in order to restore the proper hardness.

Storage (All Types of Chisels)

Apply rust preventive compound (thin film) to chisels before storage and protect cutting edge from contact with metal or abrasives. Store in a dry place. After removal from storage, wash metal parts with dry cleaning solvent to remove rust preventive compound.

Section IX

CLAMPS

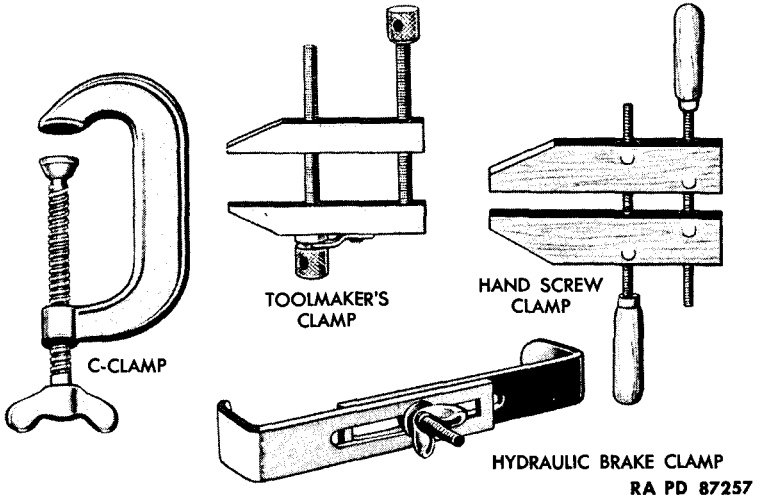

MAINTENANCE

General—All Clamps

These are relatively heavy-duty but simple tools. Maintenance requirements are few:

Keep screws lubricated with small quantity of preventive lubricating oil (special) or engine oil (SAE 10). Excessive lubricant interferes with use of tool. Keep metal surfaces free of rust. Scour off rust or corrosion with crocus cloth or aluminum oxide abrasive cloth. Coat surfaces with preservative lubricating oil (special) or engine oil (SAE 10).

Varnish hardwood jaws of hand screw clamps whenever finish becomes damaged extensively enough to leave wood without protective coating.

Replace all parts broken or damaged beyond repair.

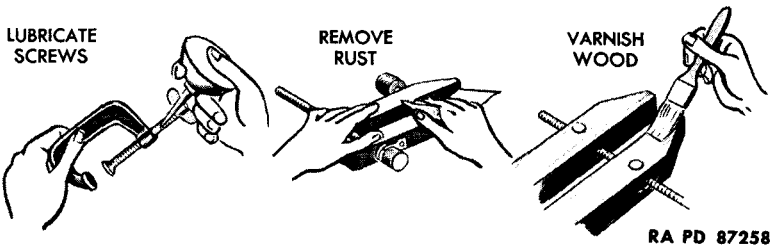

Replace C-Clamp Screw or Jaw

1. Pry open crimped portion of swivel head and remove head from ball on end of screw. Turn the screw out of jaw.

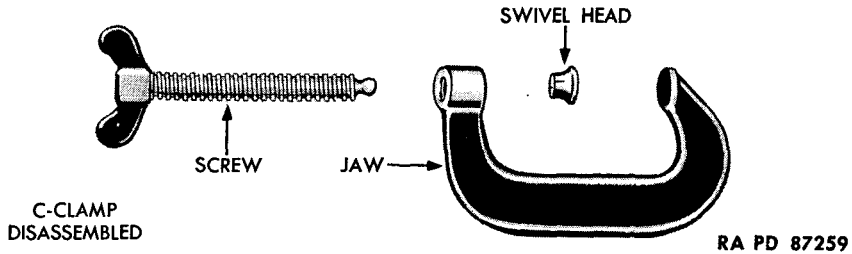

2. Using new parts as needed, turn the screw into position through its boss at end of jaw. Slip swivel head onto ball on end of screw and crimp head sufficiently to hold it on ball.

Replace Handle on Hand Screw Clamp or Toolmaker's Clamp

File off peened ends of pin which attaches handle to screw. Drive out pin. Unscrew or drive handle from screw. Screw new handle in position on screw with pinholes in handle and in screw aligned. Tap in and peen pin.

Replace Jaw, Screw or Insert on Hand Screw Clamp or Toolmaker's Clamp

1. Remove handles in accordance with instructions above. Turn both screws from the two jaws. Lift inserts (if any) from jaws.

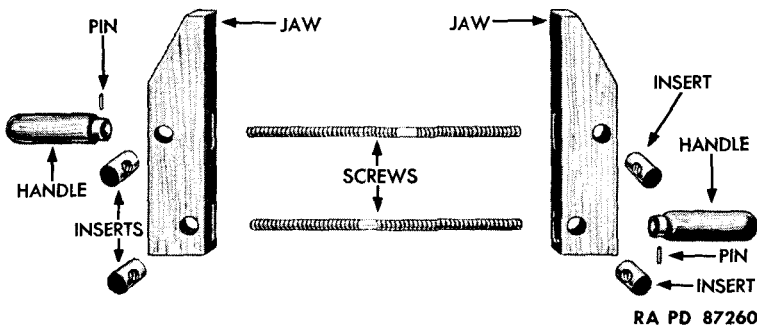

2. Using new parts as necessary, place inserts (if any) in position in jaws. Turn both screws into position in the two jaws. Install handles on screws.

Common Misuses and Abuses

Do not use a wrench or bar in tightening clamps. Too much pressure may warp, bend, or break them. Tighten clamps by hand. When applying great pressure, observe clamps for indication of undue strain.

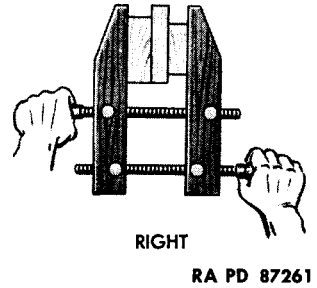
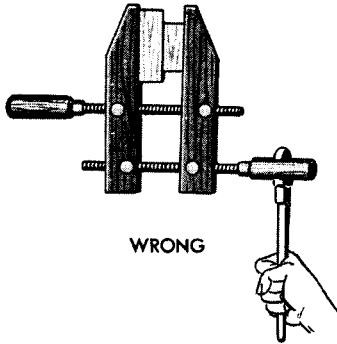

Do not cock clamp to tighten. This procedure may warp, bend, or break clamps. Keep jaws parallel.

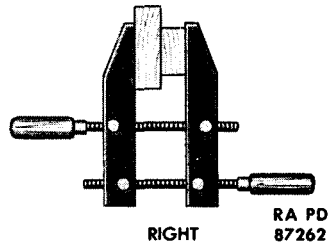
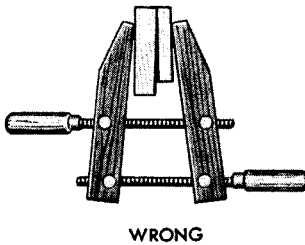

Storage (All Clamps)

Coat clamps with rust preventive compound (thin film) and store in a dry place. After removal from storage, wash metal parts with dry cleaning solvent to remove rust preventive compound.

Section X

DIVIDERS

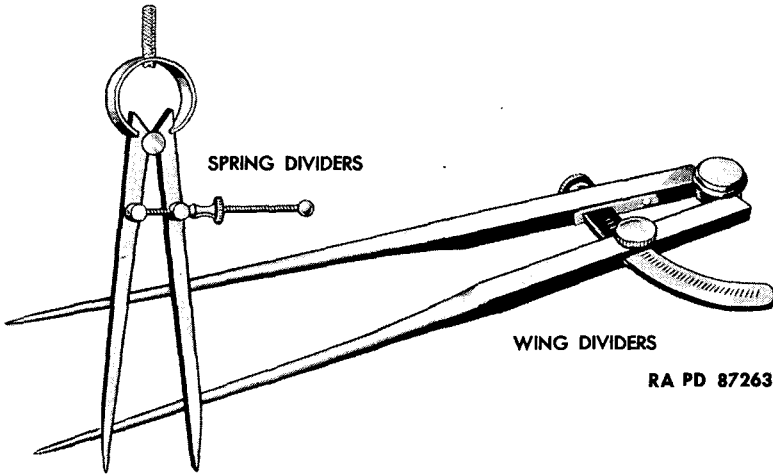

RA PD 87263

MAINTENANCE

General

Wipe fingerprints and moisture from dividers after use to prevent rusting or corroding. Keep in case or wrap in soft cloth when not in use.

Lubrication

Oil threads, pivots, and other surfaces sparingly with preservative lubricating oil (special).

Sharpening Points

Sharpen divider points with a small oilstone moistened with light oil. Keep points toward inside of legs so points will meet when dividers close. Hold dividers stationary and stroke with stone. Give stone a slight rotating movement to prevent flat spots.

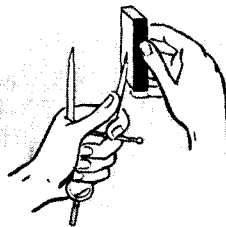

RA PD 87264

Installing Pivot on Spring Dividers

Insert a block between legs above screw. Squeeze legs together to spread spring.

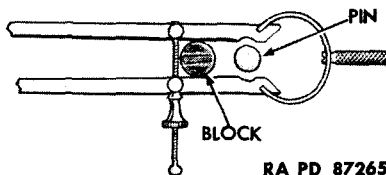

RA PD 87265

Common Misuses and Abuses

Do not use dividers as an awl or for any other purpose than scribing arcs or circles, or for checking measurements. Dividers are precision tools and must be handled and used carefully to preserve their accuracy.

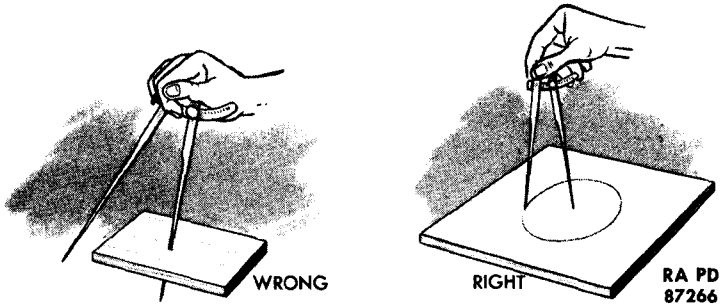

Do not lay dividers on bench when not in use. They may be damaged by other tools. Keep them in case or wrapped in cloth and stored in a safe place.

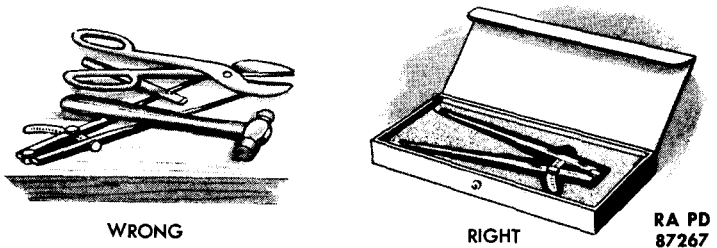

Storage

Apply rust preventive compound (thin film). To protect the points, insert them into small corks, small short twigs, or soft wood block. Store in a dry place. Upon removal from storage, wash with dry cleaning solvent to remove rust preventive compound.

Section XI

FILES AND RASPS

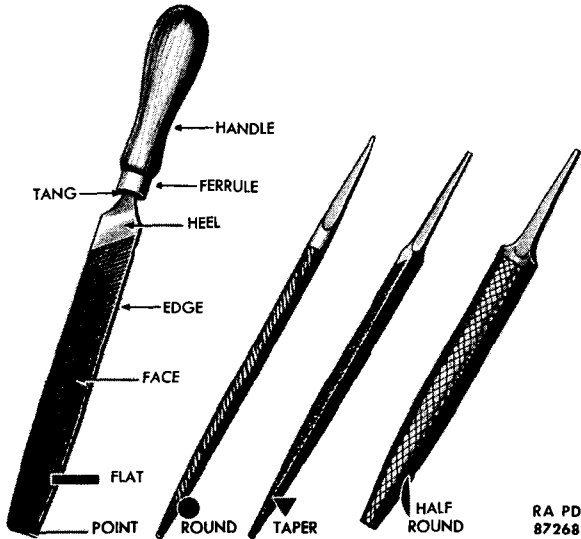

Care

MAINTENANCE

Preserve sharpness of files. Keep them in a rack. If necessary to carry files in a tool box, wrap them individually in cloth or paper. Keep files dry to prevent rusting. Do not use rust preventive compound. Do not abuse files. They are brittle and extremely dangerous if hammered or used as pry bars.

Installing Handle

CAUTION: It is dangerous to use a file without a handle.

1. Select handle to fit tang. If necessary to use handle having hole too small for tang, heat same size tang of an old file and insert in handle to burn hole to proper size (snug fit).
2. Wet tang of file and insert it in handle. Tap back end of handle on a flat surface until file is properly seated. Do not hammer file into the handle.

NOTE: Several types of "screw-on" handles are available. If using handle of this type, install as directed by handle manufacturer.

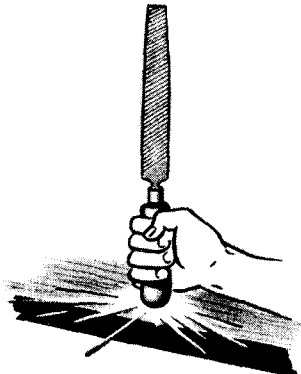

Removing Handle

Hold file with left hand. Hold handle with right hand. Pull file from handle while rapping ferrule end of handle against edge of bench.

NOTE: If removing "screw-on" type handle, remove in accordance with handle manufacturer's instructions.

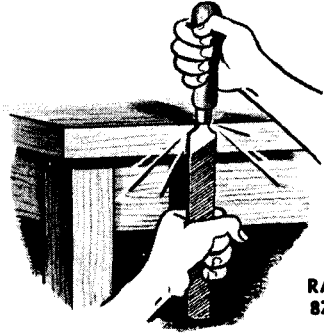

RA PD 87270

Cleaning Files

1. The cutting action of a file produces small particles or chips called filings. These particles frequently wedge between the teeth of file and impair the free cutting action. Frequent cleaning is necessary to obtain maximum efficiency of file.

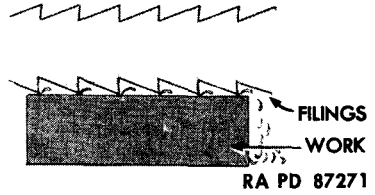

2. Brush filings from between teeth of file with wire brush. Push brush in a direction parallel with teeth.

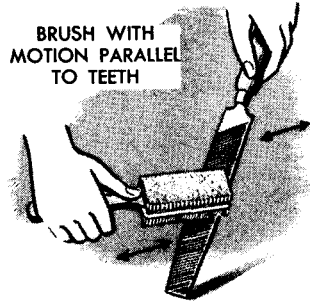

3. Remove remaining particles from teeth by using a narrow strip of soft metal such as brass or copper. A soft metal will not damage teeth.

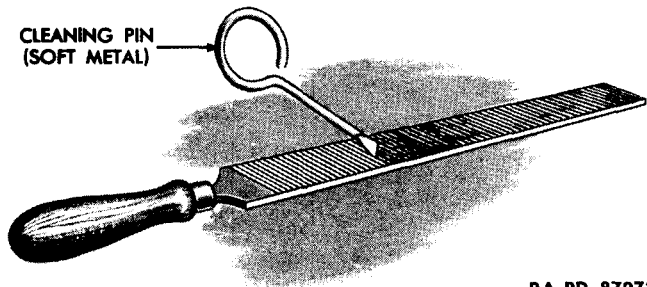

RA PD 87273

Common Misuses and Abuses

Do not strike file against vise or other object to clean it. This practice ruins file teeth and may break file. There is danger from flying particles if file breaks. Clean file with a file card and pin.

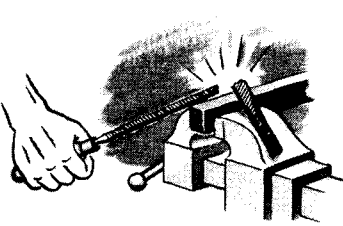

WRONG

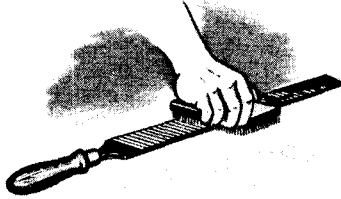

RIGHT

RA PD
87274

Never use a file without a handle. It is dangerous. Install handle before using file for any job, no matter how small.

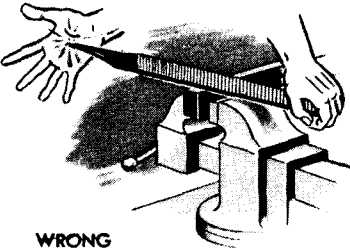

WRONG

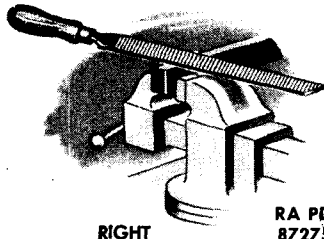

RIGHT

RA PD
87275

Do not use excessive pressure while filing. This results in clogging file and stripping teeth. Use a long, steady, uniform stroke. Hold handle with right hand. Hold end of file between thumb and first finger of left hand.

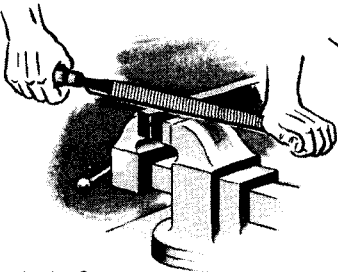

WRONG

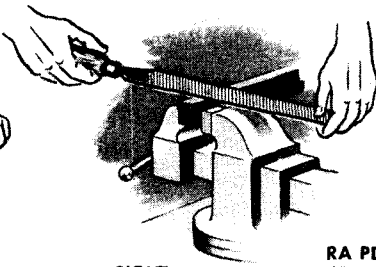

RIGHT

RA PD
87276

Storage

Be sure files and rasps are clean and dry. Do not use lubricants or rust preventive compounds. Wrap them individually in waterproof barrier wrapping paper. Place in racks or box in a manner which will make it impossible for faces or edges of files to contact each other.

Section XII

HAMMERS, MALLETs, MAULs, and SLEDGES

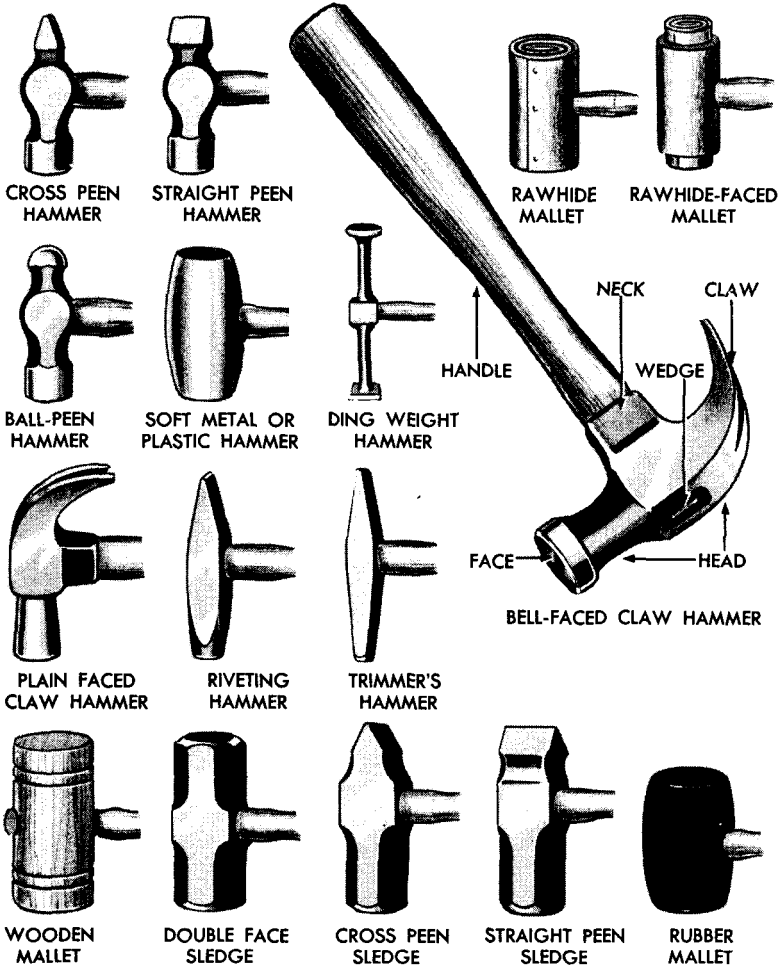

RA PD 87277

CARE OF HEADS

General

Prevent rust formation by carefully wiping steel hammer heads dry after exposure to moisture. When it is known in advance that tool will be exposed to moisture, spread a film of preservative lubricating oil (special) or engine oil (SAE 10) over head.

Frequently inspect hammer type tools to see if handle is tight in head and to see if face is in satisfactory condition.

Replacing Handle

1. Remove old handle from head. If handle is tight, saw off old handle next to neck of hammer head. Do not saw the handle off so close to the head that the saw teeth will touch the head while sawing, thus damaging the set of the saw. A hacksaw may also be used.

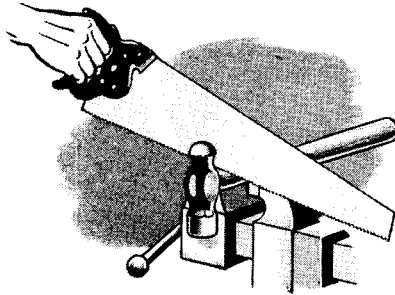

2. Drill a hole in old handle as illustrated.

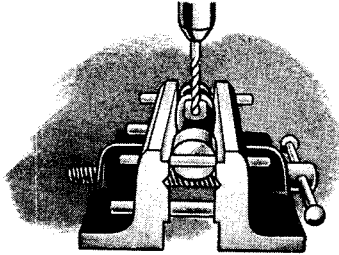

3. Drive old handle from head and secure wedges. (Note position of wedges.)

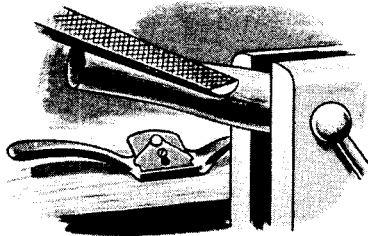

4. Shape new handle to fit head. Use rasp or spoke shave.

5. Insert new handle to head to determine fit.

6. Assemble for tight fit by striking end of handle with mallet to seat head firmly on handle.

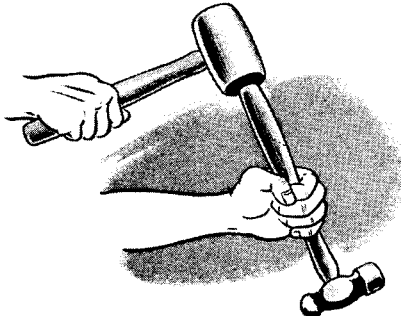

RA PD 87278

7. Check results to determine if handle fits properly.

8. Saw off the projecting portion of handle close to hammer head and cut slits for wedges. Avoid having saw teeth touch the head during sawing.

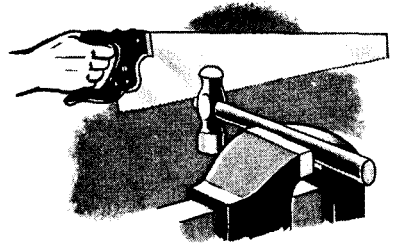

9. Drive wedges into handle. If wooden wedges are used, replace old wedges or make new ones from straight grain soft wood.

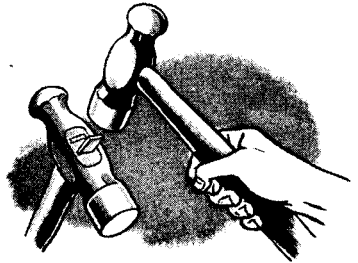

RA PD 87279

10. File or grind end of handle even with head. Use wood rasp if wooden wedges are used. Grinding may be employed if metal wedges are used.

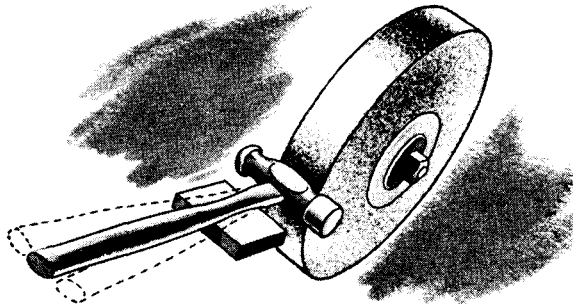

RA PD 87280

Tightening Handle

If wedge comes loose, remove it and install larger wedge. If wedge remains tight in handle, but handle loosens, drive thin hardwood or iron wedge into handle beside original wedge. A loose handle can be temporarily repaired by soaking in water. If unable to tighten, replace handle.

Grinding Face

Incorrect or abusive use of hammer type tools frequently results in uneven face wear. To reshape worn faces:

1

Determine if face should be plain or bell shaped by examining unworn portion of face or by comparing with unworn tool of same type.

2

Grind face to original shape. Frequently immerse head in water to prevent burning. Do not remove more stock than necessary.

3

On mallet type tools, grind equal amount of material from both faces to preserve balance.

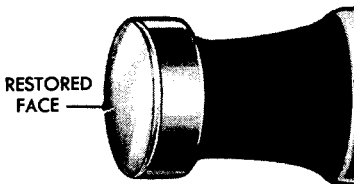
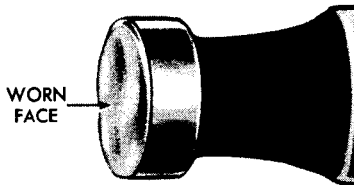

RA PD 87281

Common Misuses

Do not strike a hardened steel surface with a hammer.

This misuse is a serious safety hazard. Small pieces of sharp, hardened steel break from the hammer and also from the hardened steel. This has been responsible for many serious eye injuries. It may also cause damage to the work and/or the hammer.

Use a soft hammer in striking any hardened steel. If a soft hammer is not available, place a piece of copper, brass, fiber, or wood on the hardened steel. Strike the soft material and not the hardened steel.

Storage

Coat steel heads with rust preventive compound (thin film) and store in a dry place. Upon removal from storage, wash metal parts with dry cleaning solvent to remove rust preventive compound.

Section XIII

HAND GRINDERS

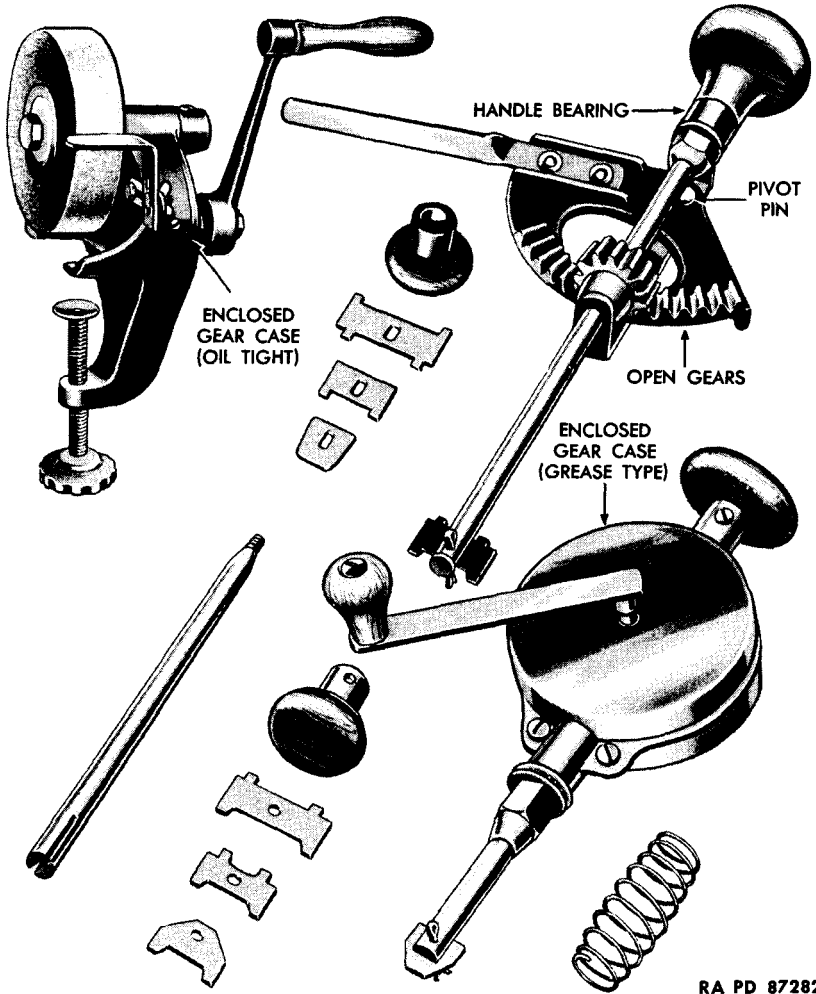

CLEANING

Drain lubricant from enclosed type gear cases. Flush out with dry cleaning solvent. Drain gear case completely after flushing. Refill with correct grade of lubricant as specified.

Wash exterior surfaces and open type gears with dry cleaning solvent. Scour corrosion from surfaces with crocus cloth.

LUBRICATION

Lubricate grinders in accordance with following chart:

PART	LUBRICATION PERIOD	LUBRICANT
Enclosed gear cases (oiltight)	Weekly	OIL, engine, SAE 30
Enclosed gear cases (grease type)	Weekly	GREASE, general purpose, No. 0
Open gears	Daily	OIL, engine, SAE 10, or OIL, lubricating, preservative, special
Handle bearings	Daily	
Pivot pins	Daily	
Exterior nonwearing surfaces		OIL, lubricating, preservative, special

Common Misuses

Careless handling. Tools of this type will not stand rough handling and continue to operate satisfactorily.

Do not strain working parts beyond capacity. Do not throw into box loosely with other tools.

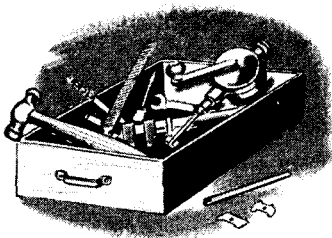

WRONG

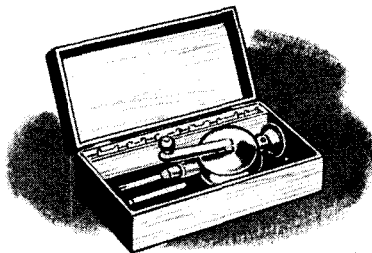

RIGHT

RA PD 87283

Storage

For indefinite storage, drain lubricants and wash tool in dry cleaning solvent. Dry thoroughly, relubricate and fill gear cases, and spread rust preventive compound (thin film) over all parts. Wire small attaching parts to valve grinders to prevent their loss. Store in a dry place. Mobile field units should check tightness of all screws and nuts before and after storing, and should wrap sufficiently to keep out all dust and to protect grinder.

Upon removal from prolonged storage, wash rust preventive compound from grinder with dry cleaning solvent.

Section XIV

HATCHETS, AXES, MATTOCKS, ADZES, and SHOVELS

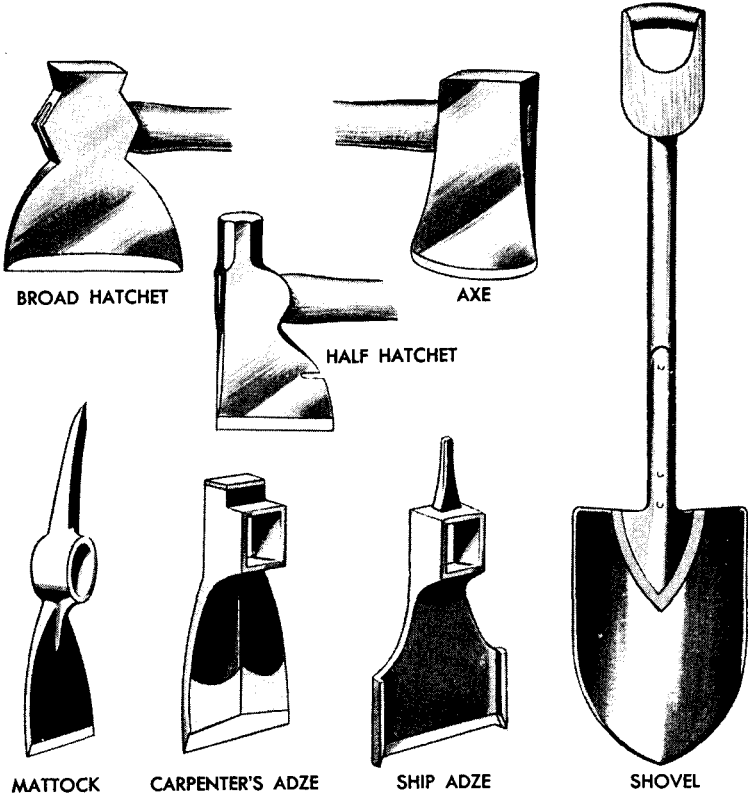

BROAD HATCHET

AXE

HALF HATCHET

MATTOCK

CARPENTER'S ADZE

SHIP ADZE

SHOVEL

RA PD 87284

GRINDING

Hatchets and Axes

1
Remove nicks by holding horizontally against abrasive wheel. Move back and forth across stone.

2
Grind cutting edge of hatchet to bevel indicated. Grind ax as described below. Frequently cool in water to preserve temper. Move from side to side across face of grinding wheel.

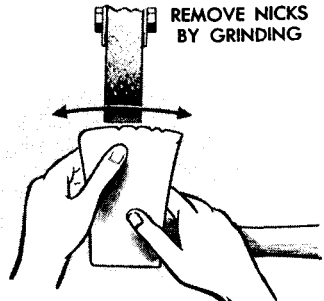

RA PD 87285

Adzes

Remove handle and grind to same level as when grinding a hatchet to hew to a line. Bevel on handle side only.

Mattocks

Follow procedure for grinding hatchet, and grind to original bevel.

Correct Ax Bevels

Careless grinding will ruin any ax by either destroying the temper through heat caused by friction, or by making the edge so thin it will not stand up under the force of a swinging blow. Do not use a high speed dry grinding wheel. An ax ground on a dry wheel will surely be ruined. Grind slowly on a wheel kept very wet.

When regrinding, start to grind from 2 to 3 inches back from the cutting edge and grind to about 1/2 inch from edge. Work for fan-shape effect, leaving reinforcement at corners adequate for sufficient strength. Then "roll off" on a convex bevel as shown in the cross-section illustration of an ax bit at right. This illustration is exact gage "life size" and shape of properly ground cutting edge.

Remove all scratches with whetstone or hone. A scratch on highly tempered steel will frequently cause material to break where it is scratched

CORRECT HATCHET BEVELS

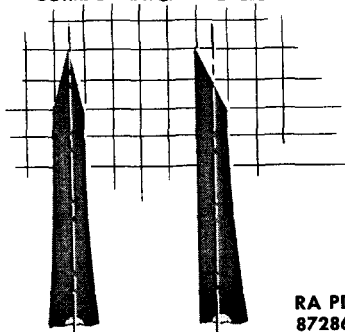

FOR GENERAL USE FOR HEWING TO A LINE

CORRECT AXE BEVELS

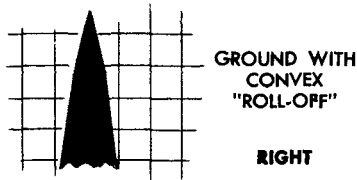

GROUND WITH CONVEX "ROLL-OFF"

RIGHT

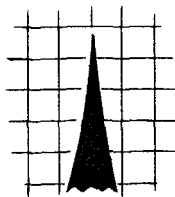

GROUND CONCAVE

WRONG

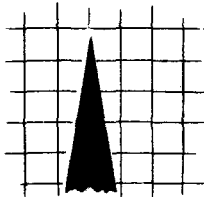

GROUND STRAIGHT

WRONG

RA PD 87287

The illustration above shows the most frequent mistake in regrinding. It is ground concave—the wrong way—leaving insufficient support behind the edge to withstand any ordinary blow. It will break very easily.

This illustration shows the cutting edge ground with a long straight bevel, better than the concave bevel, but still without sufficient reinforcement back of the edge.

Shovels

NOTE: If shovel is bent, hammer it straight on a flat block or anvil before grinding. Do not use heat while straightening a shovel. Hold shovel in a horizontal position against an abrasive wheel and grind to outline indicated in sketch. Grind blunt bevel along cutting edge. Cool shovel in water at frequent intervals during grinding to preserve temper.

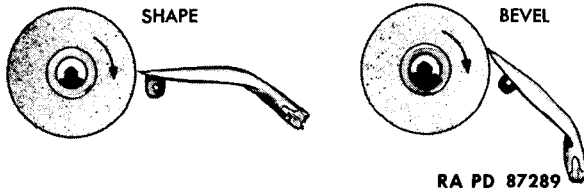
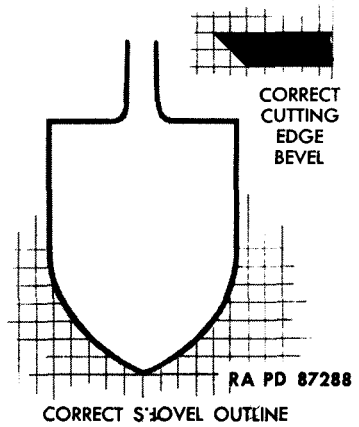

SHARPENING

Straight-edged Hatchet Type Tool

Grasp tool as indicated in sketch and place on a lightly oiled oilstone. Tilt tool so bevel lies flat on stone. Exert slight pressure on tool. Hold right wrist rigid (no sidewise twist), and move tool back and forth on stone a few times. If tool is ground with a double bevel, turn tool over and repeat operation.

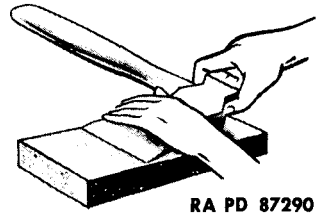

Curved-edged Hatchet Type Tool

1. Hold tool stationary. Place stone flat on bevel. Apply light pressure and move stone with a circular motion.
2. Place stone on other bevel (if any) and repeat operation. If only one bevel is used, place stone flat on other side of tool head and remove wire edge with a circular motion.

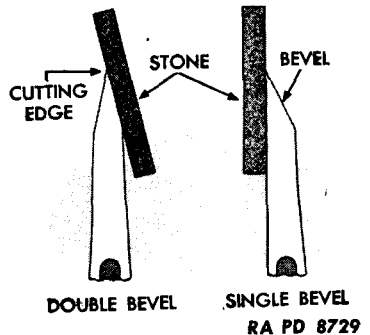

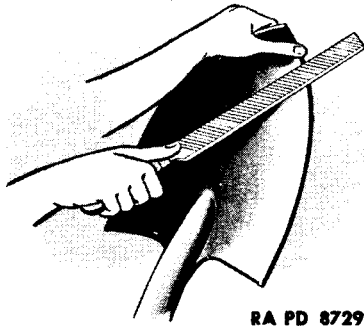

RA PD 87292

Shovels

Place smooth file flat on bevel as illustrated. Apply pressure to file on forward stroke. Lift file clear of shovel on back stroke.

REPLACING HANDLES

Hatchets, Axes, and Adzes

Procedure is identical with that given for hammers, mallets, mauls, and sledges (section 12).

Mattocks

Tap butt of handle on a solid surface to loosen head. Slide head from butt of handle. Insert new handle, butt first, through head and slide into approximate position. Rap head end of handle on floor to tighten head on handle.

Shovels

Cut or grind off peened heads of rivets which attach shovel to handle. Drive out rivets and pull handle from shovel. Insert new handle into position in shovel. Drill rivet holes through handle. Insert and peen rivets.

Common Misuses (Hatchets, Axes, Mattocks, and Adzes)

Do not strike heavy blows when tool is very cold. Breakage may result because frost makes steel brittle. Warm ax before using in cold weather.

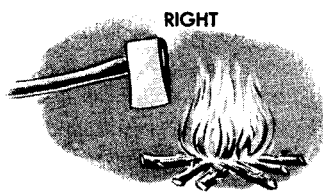
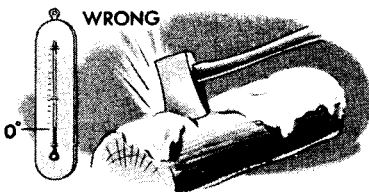

RA PD 87293

Do not use tools as mauls or wedges. Breakage across or under the eye often results. Use tools only for use intended.

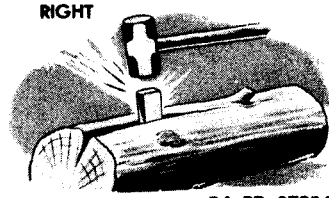
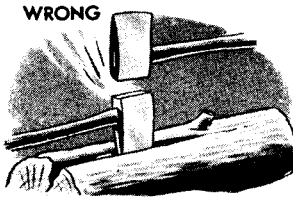

RA PD 87294

Common Misuses (Shovels)

Do not use shovel as a pry bar. Handles break easily. Avoid undue strain on handle.

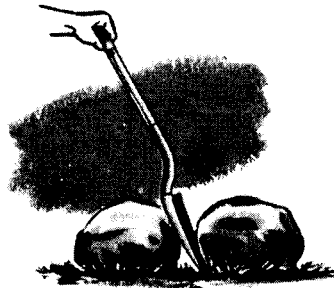

WRONG RA PD 87295

Never return shovel to storage without proper cleaning. Dirt will harden and shovel will rust. Always clean shovels thoroughly after using.

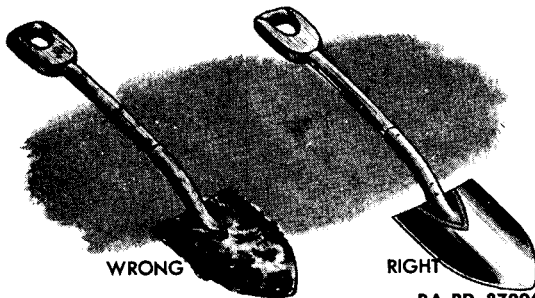

RA PD 87296

Storage

Coat metal surfaces with rust preventive compound (thin film) and store in a dry place in racks or boxes with cutting edges protected. Upon removal from storage, wash rust preventive compound from metal parts with dry cleaning solvent.

Section XV

HYDROMETERS

Cleaning

Wash body and float with soap and water. Use care when washing float to keep from injuring markings. Battery acid deposits which do not yield to soap and water, can be removed with a solution of hot water and soda.

Care in Use

Provide a well-protected container positioned in a handy place near battery bench. Handle with extreme care and replace to storage position when not in use. Clean grease from bulb and tip with carbon tetrachloride or soap and water. Flush with water and wipe dry.

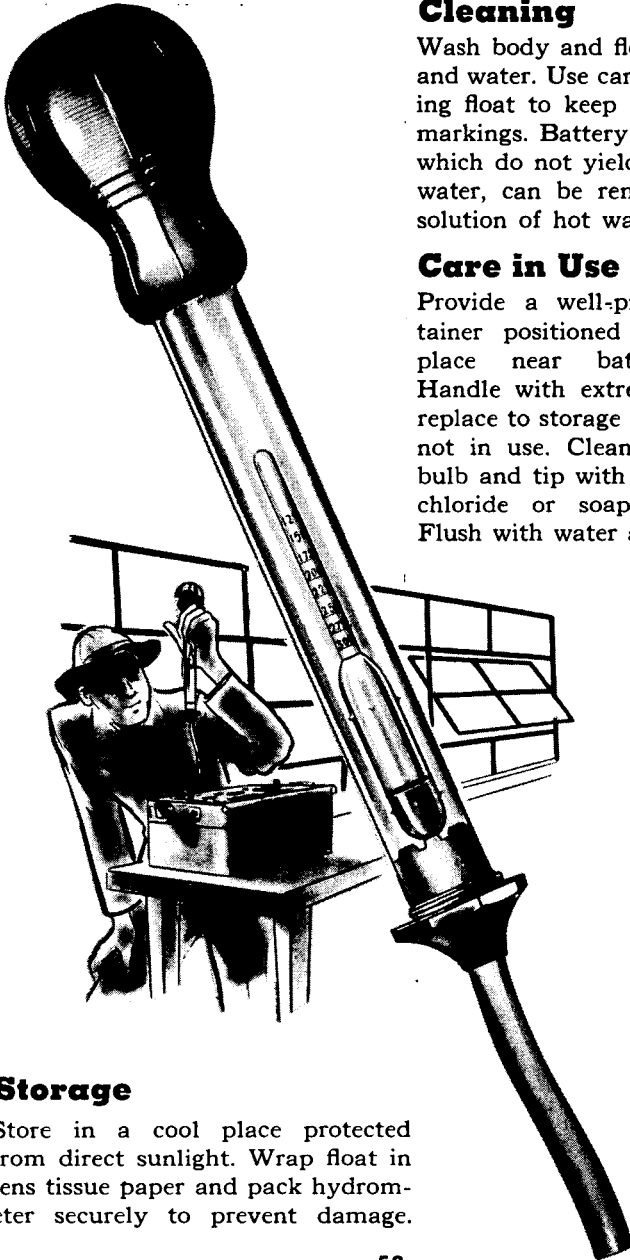

Storage

Store in a cool place protected from direct sunlight. Wrap float in lens tissue paper and pack hydrometer securely to prevent damage.

RA PD
87297

Section XVI

KNIVES

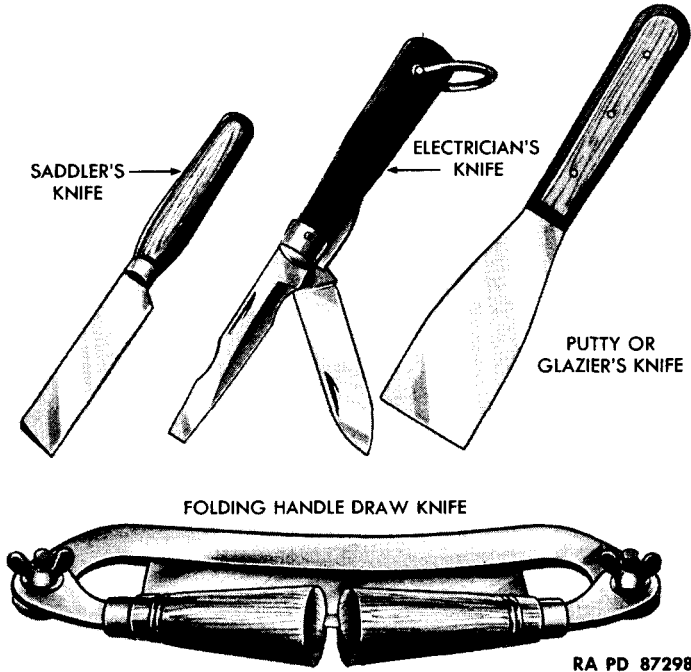

GRINDING

NOTE: Do not grind small knives such as saddler's or electrician's knives except to shape a broken blade. Sharpen them on an oilstone.

Putty Knife

Hold knife perpendicularly against edge of abrasive wheel to "square up" worn blade. Dip in water often to preserve temper. Keep blade at right angles to surface of wheel and move from side to side during grinding.

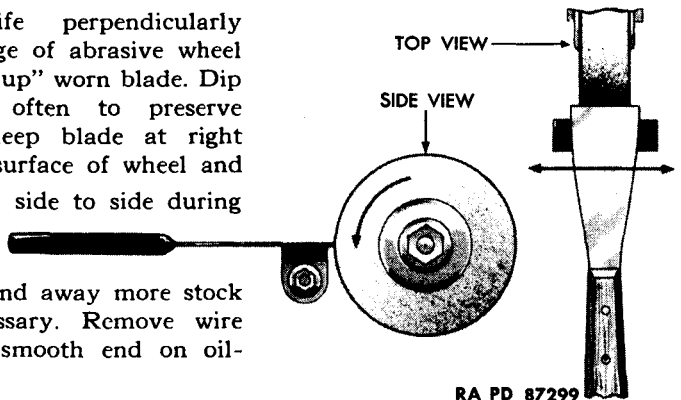

Do not grind away more stock than necessary. Remove wire edge and smooth end on oilstone.

Draw Knife

A draw knife may be ground with a single bevel or a double bevel. Grind to same bevel as originally ground as revealed by inspection of unworn portions at ends of cutting edge. Bevels may be straight or slightly concave. Never grind bevels convex. Make bevel approximately twice the width of blade at point where bevel starts. Grinding procedure follows:

1. Adjust rest at midpoint of wheel. Run knife back and forth full length of blade maintaining original shape, until nicks are removed.
 2. Adjust rest toward top of wheel to provide correct bevel. Run knife back and forth full length of blade until bevel is secured.
 3. If double bevel is sought, turn knife over and grind second bevel.
- CAUTION:** Be sure to dip knife in water frequently to prevent burning and subsequent loss of temper.

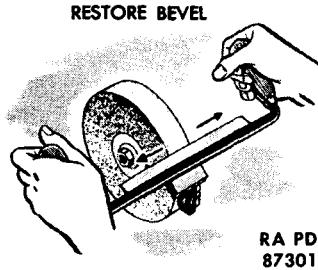
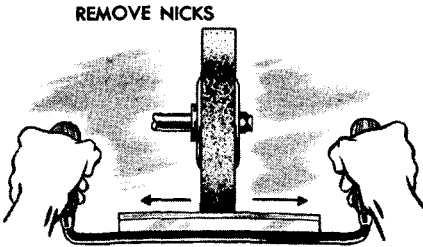
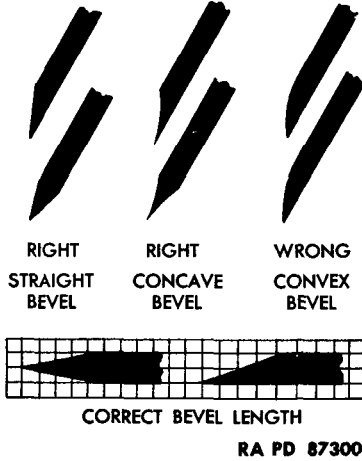

SHARPENING

Small Knives

Sharpen on a medium or fine oil-stone moistened with a few drops of oil. Apply blade to stone with back tilted slightly from stone. Hold blade obliquely across face of stone and rub briskly back and forth. Repeat on other side of blade. Remove wire edge by stropping on a piece of leather or canvas.

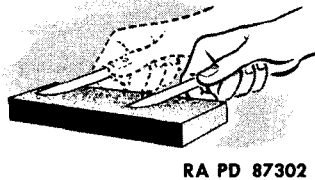

Draw Knife

Place a medium or fine oilstone on a block sufficiently high to cause draw knife's handles to clear bench. Moisten oilstone with a few drops of clean light oil. Place knife blade on stone and tilt knife so bevel lies flat on stone. Rub blade on stone in a circular motion so entire length of bevel contacts stone. If blade has a double bevel, turn knife over and repeat operation. Remove wire edge by stropping on a piece of leather or canvas.

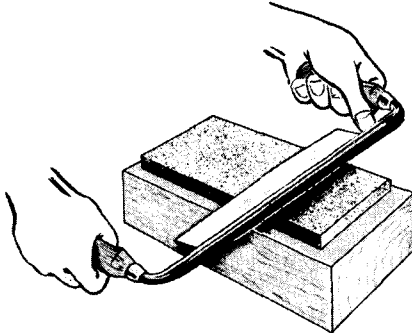

RA PD 87303

Common Misuses

Do not use tool with prying or lever action.

Blade ends and/or sharp thin edges will break if strained beyond breaking point.

Undue straining will loosen rivets and joints.

Handle carefully and use only for purposes intended.

Storage

Coat all metal parts of knives with rust preventive compound (thin film) at time of storing. Store in a dry place with cutting edges protected from contact with metals or abrasives. Upon removal from storage, wash metal parts with dry cleaning solvent to remove rust preventive compound.

Section XVII

LEVELS

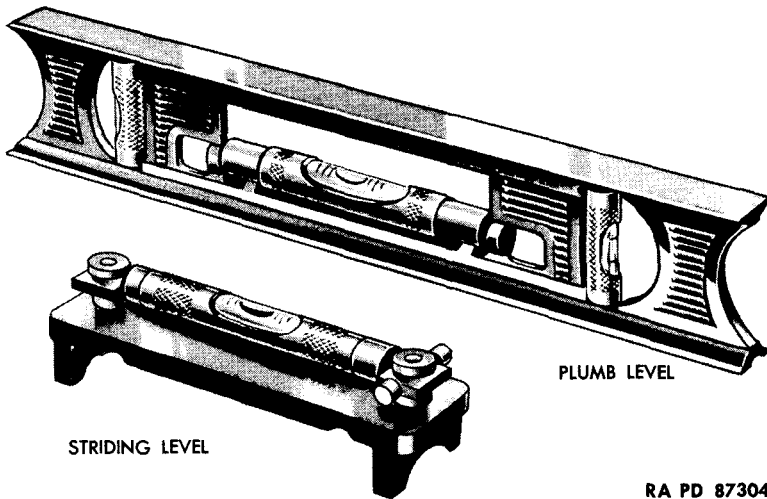

STRIDING LEVEL

PLUMB LEVEL

RA PD 87304

CARE OF LEVELS

Test

1. Place level on a true horizontal surface and note level indication. Reverse level end for end. If bubble appears on one side of hairline on first reading and on other side for second reading, level is out of adjustment.

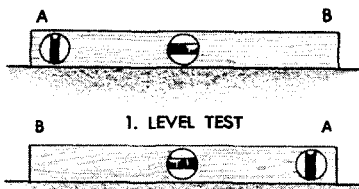

2. Place plumb level against a true vertical surface and note plumb reading. Twist level one-half turn about its vertical axis and again take reading. If bubble appears on opposite sides of hairline in the two readings, plumb level is out of adjustment.

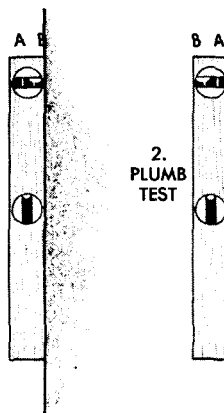

RA PD 87305

Adjustment

ADJUSTABLE LEVELS (METAL OR WOOD CONSTRUCTION): Turn adjustment screw or nut to move spirit tube in direction indicated by test. Repeat adjustment and test until bubble centers on cross hair (single hairline level) or until bubble is centered between cross hairs (double hairline level).

NONADJUSTABLE METAL-FRAMED LEVELS: Remove screw, bolt or rivet which attaches low end (as revealed by tests) of spirit tube to frame. Shim up low end of tube with shim stock and attach tube to frame. Test level. Repeat adjustment and test until fault is corrected.

NONADJUSTABLE WOOD-FRAMED LEVELS: Carefully dig out plaster of paris bed which attaches spirit tube to frame. Place level on a true horizontal or vertical surface (depending on whether level or plumb spirit tube is being adjusted). Using fine calcined gypsum for a tube bed, position spirit tube so bubble centers on hairline. Allow gypsum to set before moving level.

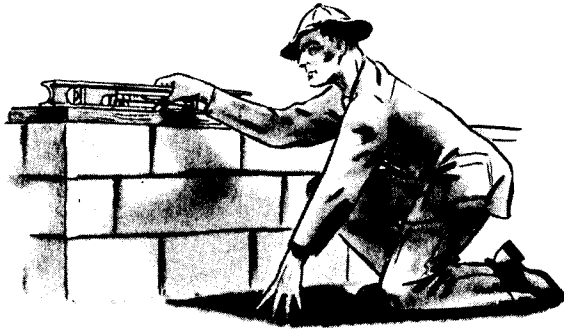

RA PD 87306

Common Misuses

Rough handling. A level is a precision tool, therefore it must be used and handled with extreme care to preserve its accuracy. Do not drop. Do not strike. Place level carefully against work.

Storage

Coat metal parts with rust preventive compound (thin film) at time of storage. Place tool in a rack or box which will protect it from accidental breakage. Store in a dry place. Upon removal from storage wash metal parts with dry cleaning solvent to remove rust preventive compound.

Section XVIII

NIPPERS AND PLIERS



TYPICAL NIPPERS

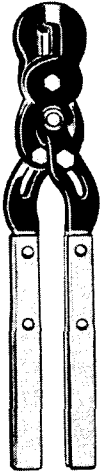

TIRE CHAIN REPAIR PLIERS



ADJUSTABLE COMBINATION PLIERS

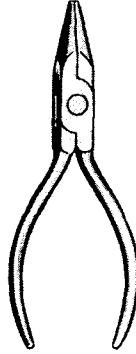

HALF ROUND-NOSE PLIERS

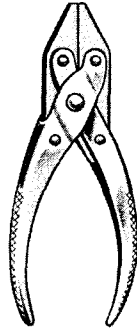

FLAT-NOSED PLIERS



BRAKE SPRING PLIERS

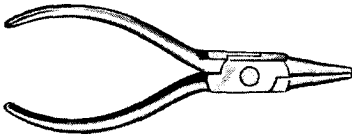

ROUND-NOSED PLIERS



DIAGONAL CUTTING NIPPERS OR PLIERS

RA PD 87307

MAINTENANCE

Grinding and Sharpening

NOTE: Many modern side cutting pliers and nearly all nippers are designed so they can be reground. Some older models will not close if material is ground from cutting edges.

Examine pliers to see if design will permit them to close completely if material is ground from cutting edges. Do not attempt to sharpen pliers not designed to be ground.

Grind cutting edges so ground bevel is at approximately right angles with inside machined bevel. Grind same amount of stock from both jaws but no more than necessary to remove nicks. Cool often in water to preserve temper.

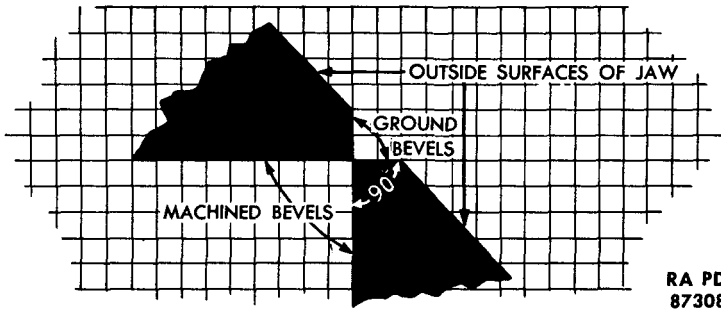

CORRECTLY GROUND CUTTING EDGES

NOTE: Jaws on some pliers will not open wide enough to permit grinding. On such pliers, press out recessed taper pin or remove special bolt and nut which attach the two halves of pliers together and separate jaws for grinding. Peen pin well when assembling pliers which are pinned together.

Cleaning

Wash pliers in dry cleaning solvent and wipe dry with a clean cloth. Clean dirt from serrated jaw faces with a wire brush. When completely dry, lubricate pivot pin with one or two drops of preservative lubricating oil (special) or engine oil (SAE 10).

Renewing Jaw Face Serrations

Place the pliers in a vise protected with soft jaws and renew serration with a four- or five-inch three-cornered file. If the jaws of the pliers can be separated and the mechanic has access to a small surface grinder, new serrations can be ground. Diamond dress a narrow wheel to an included angle of 60 degrees (30 degrees on each side of centerline) and grind the serrations with each jaw held separately in a grinding vise.

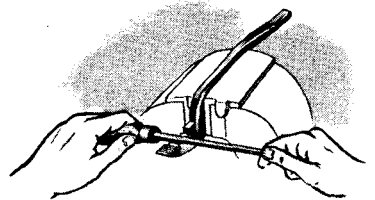

RA PD 87309

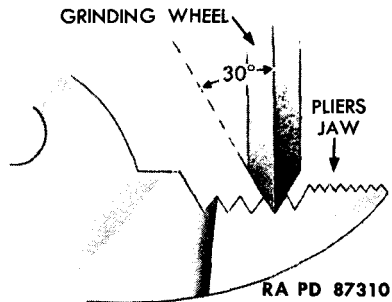
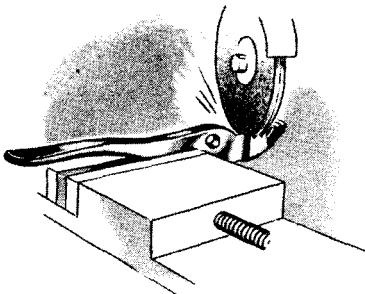

Common Misuses

Do not use pliers on a nut. This batters nut and plier jaw serrations unnecessarily. Use a wrench on nuts.

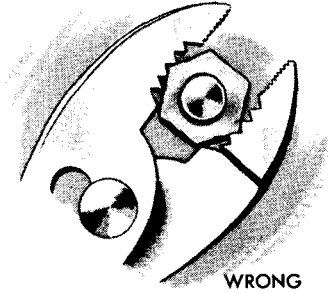

Do not use pliers as a pry bar. Handles may bend or break. Use tools only for purpose for which they are designed.

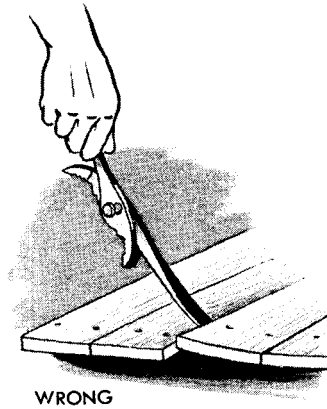

RA PD 87311

Storage

At time of storage, apply rust preventive compound (thin film). Store in a dry place. Upon removal from storage, wash with dry cleaning solvent to remove rust preventive compound.

Section XIX

PLANES

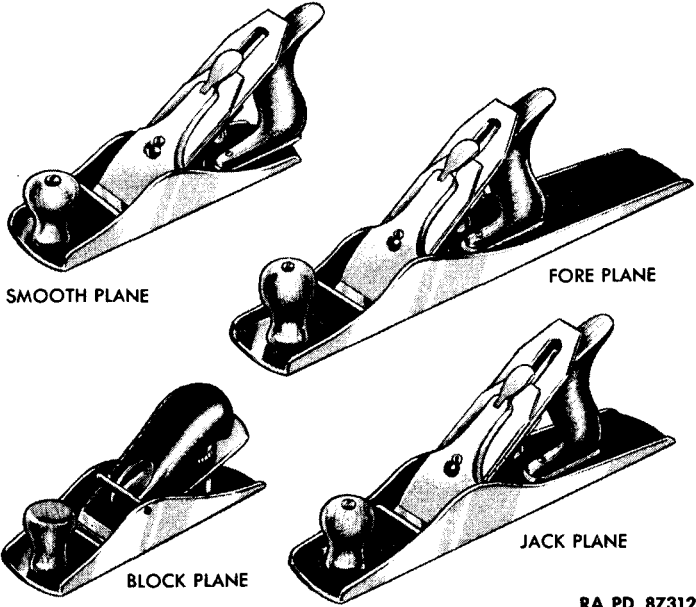

RA PD 87312

GRINDING PLANE IRONS

General

Irons must be ground when cutting edge is nicked, when bevel is worn too blunt, when bevel is rounded out, or when cutting edge is worn to improper shape.

1. Cutting edges should be straight on smooth and block plane irons, slightly curved on jack plane irons, and very slightly curved on fore plane irons.

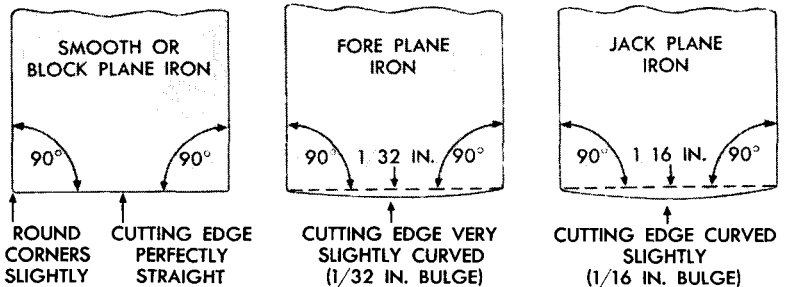

RA PD 87313

TM 9-867

2. Bevel may be straight or slightly concave. It must never be rounded out.



RIGHT
BEVEL IS
CONCAVE OR
SHAPE OF
ABRASIVE
WHEEL



RIGHT
BEVEL IS
FLAT OR
PERFECTLY
STRAIGHT



WRONG
BEVEL IS
ROUNDED OUT
BY INCORRECT
GRINDING OR
SHARPENING

RA PD 87314

3. Bevel should be about twice the thickness of iron near cutting edge.

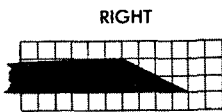

RIGHT

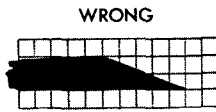

WRONG

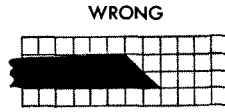

WRONG

RA PD 87315

Procedure

CAUTION: While grinding, keep plane bit cool by frequently dipping into water to prevent burning or softening of the steel. Keep the fingers near the grinding edge while grinding to feel and determine if plane iron is becoming too hot.

1. Square cutting edge, and remove nicks as necessary.
2. Adjust rest on grinder to a position which will give correct bevel.
3. Grind by moving iron from side to side to grind all parts of bevel evenly, and square with the edges.

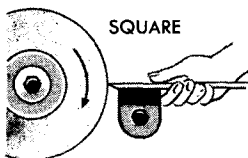

SQUARE

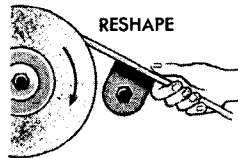

ADJUST
REST

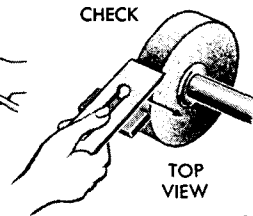

CHECK

TOP
VIEW

RA PD 87316

NOTE: Special holding devices are available for sharpening plane bits. Their use simplifies the grinding.

SHARPENING PLANE IRONS

General

Always sharpen iron after grinding. During use of plane, sharpen iron as often as necessary to keep a keen edge.

Procedure

1. Grasp iron with both hands, palms downward. Place iron bevel on lightly oiled stone with iron at bevel angle.
2. Apply light pressure to iron and rub back and forth over surface of stone. Do not alter angle of iron to stone during process. Round off corners enough to allow for depth of cut.
3. After whetting bevel side, turn iron over and hold perfectly flat on stone. Give it two or three strokes to remove wire edge.

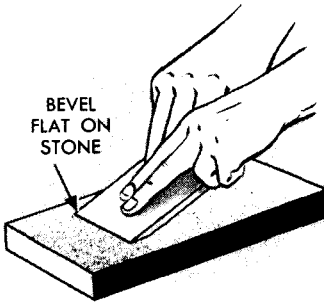

WHETTING BEVEL

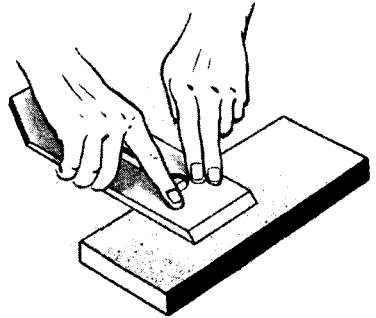

REMOVING WIRE EDGE RA PD 87317

Regrinding Chip Cap

The chip cap is made of soft steel and the sharp edge is easily dented or marred, thus requiring regrinding.

1. Separate the chip cap and plane iron and remove the chip cap screw.
2. Grind the lower surface of the curved end on the side of a grinding wheel.

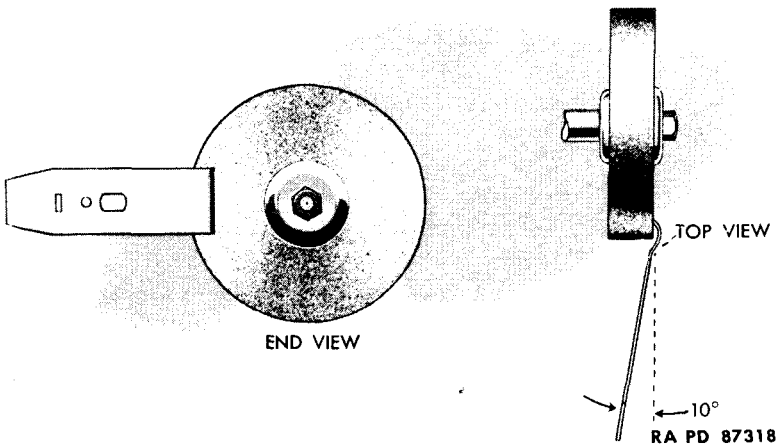

3. Grind only as required to remove nicks.
4. Finish grind surface, and remove wire edge on an oilstone.

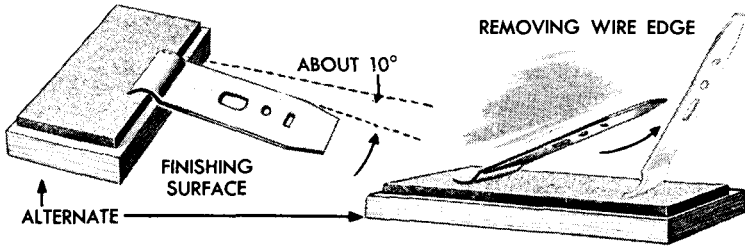

RA PD 87319

SETTING IRON (Jack, Fore, and Smooth Planes)

General

Jack, fore, and smooth planes have double plane irons. A chip cap is secured to iron by a set screw. This chip cap breaks the shaving as soon as possible after it is cut. Depth of cut is regulated by a depth screw. Set chip cap back farther for a coarse chip or shaving than for a fine one. Never allow chip cap corners to extend beyond cutting edge of plane iron; it must always be back of cutting edge. A block plane, having a single plane iron, has no chip cap.

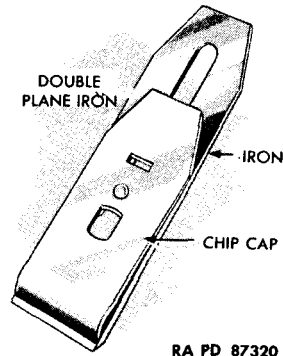

RA PD 87320

Procedure

1. Test fit of chip cap on iron. It must fit without gapping to prevent shavings from forcing themselves between chip cap and iron. If not a close fit, sharpen chip cap on an oilstone. Hold chip cap so as to preserve original angle while sharpening.
2. Enter cap set screw into slot in iron. Adjust cap to $\frac{1}{64}$ inch from cutting edge of iron, and parallel with cutting edge. Tighten set screw.
3. Adjust "set" (distance between cutting edge of iron and edge of chip cap) by lightly tapping end of blade opposite cutting edge. Proper sets are:

Type of Plane	To Work Soft Wood	To Work Hard or Crossgrained Wood
Jack plane	$\frac{1}{16}$ in.	$\frac{1}{32}$ to $\frac{1}{64}$ in.
Fore plane	$\frac{1}{16}$ in.	$\frac{1}{32}$ to $\frac{1}{64}$ in.
Smooth plane	$\frac{1}{32}$ in.	$\frac{1}{32}$ to $\frac{1}{64}$ in.

ADJUSTING FROG

General

Frogs must be set square with plane sides and set forward with sufficient clearance for chips to pass through without clogging.

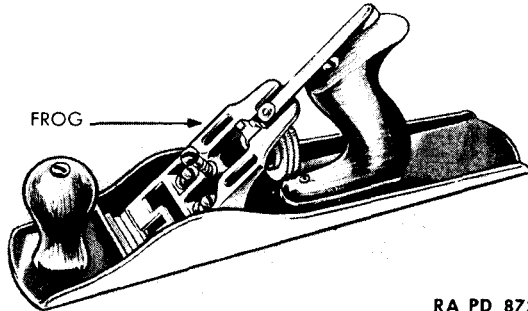

RA PD 87321

Common Misuses to Avoid

Never lay plane face down. The blade may be nicked or dulled. Always lay plane on edge when not in use.

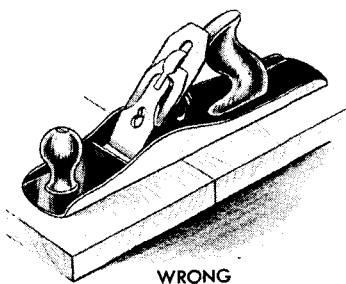

WRONG

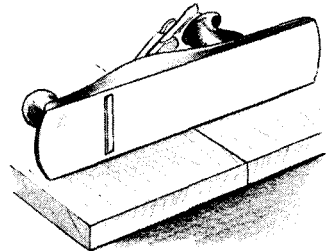

RIGHT

RA PD
87322

Do not plane with grain of wood sloping down. The wood is likely to tear and jam the plane. Always have grain of wood sloping upward in direction of planing stroke.

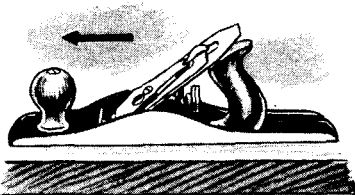

WRONG

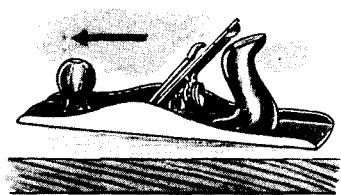

RIGHT

RA PD 87323

TM 9-867

Do not plane "head on." This practice quickly dulls the iron. Place plane on wood at a slight lateral angle.

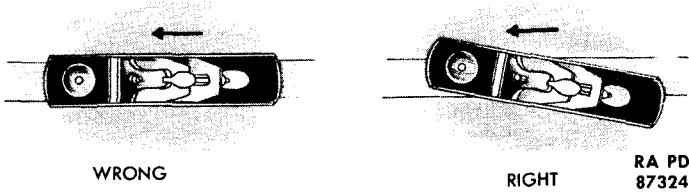

RA PD
87324

Do not drag blade on wood on return stroke. This dulls the blade. Tilt plane at an angle sufficient to cause blade to clear the work, or lift plane completely.

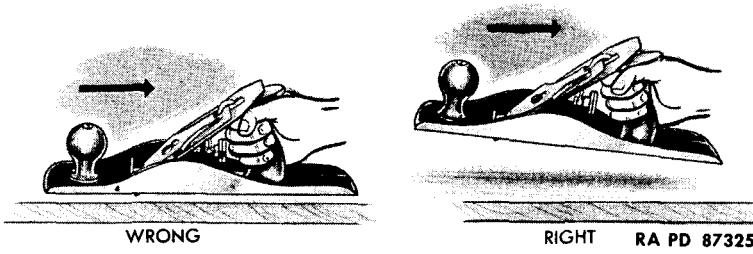

RA PD 87325

Do not attempt to do work with the wrong type plane. Such procedure is wasteful of material, time, and energy. Use planes for purposes indicated in following table:

Plane	Use	Remarks
Fore plane	To true surface or edge o. lumber for accurate work.	Hold plane firmly, right hand on handle, left hand on knob.
Smooth plane	To smooth rough surfaces where straight edges and sides are not required.	Hold plane firmly, right hand on handle, left hand on knob.
Block plane	To make close joints, to cut across the grain or edges of small lumber.	Use with one hand. Make light cuts with short strokes toward center of work. Do not run over edge of work.
Jack plane	A substitute for fore or smooth plane. Does not do as precise work.	Hold plane firmly, right hand on handle, left hand on knob.

Lubrication

Keep irons and screw threads coated with a thin film of preservative lubricating oil (special).

Storage

Plane irons should always be withdrawn fully into the plane bed when tool is stored. Before storing, coat all metal parts of planes with rust preventive compound (thin film). Store planes in boxes or in racks in a manner to protect cutting edges of irons from contact with wood, metals, or abrasives. Store in a dry place. Upon removal from storage, wash metal parts with dry cleaning solvent to remove rust preventive compound.

PUNCHES

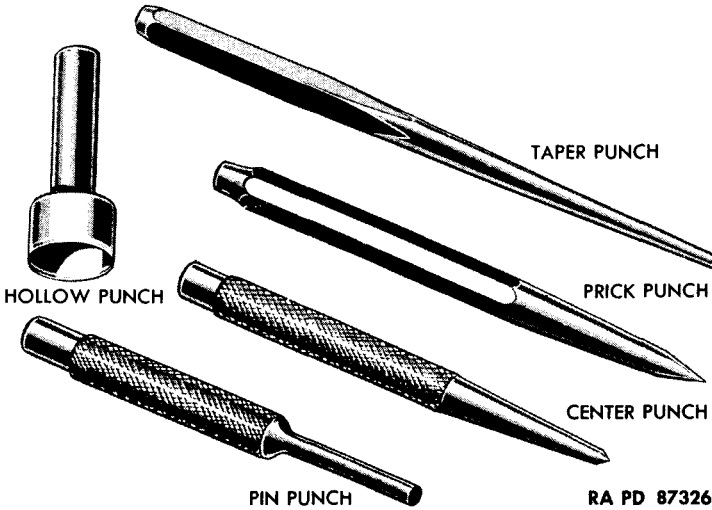

GRINDING AND SHAPING

Blunt End Punches

Grind pin punch, taper punch, or other blunt end punch so end is perfectly flat and at right angles to centerline of punch.

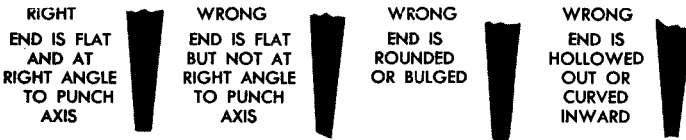

1. Set rest horizontal and at center of grinding wheel.
2. Start wheel and feed punch into grinding surface of wheel at right angles to surface.
3. Twist punch during grinding to get flat end on punch.
4. Cool punch frequently in water to preserve temper.
5. Do not grind away more metal than necessary to get a satisfactory end.

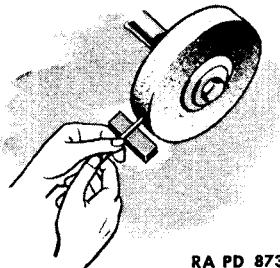

Cone-pointed Punches

Center punches and prick punches are ground to cone points. Correct point angle for center punches is about 90 degrees. Right point angle for prick punch is approximately 30 degrees. These angles may be altered for special work.

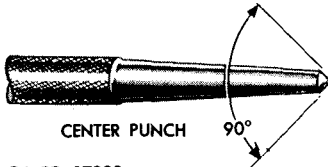

CENTER PUNCH
RA PD 87328

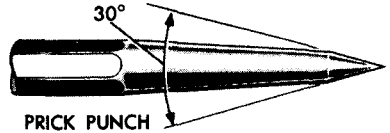

PRICK PUNCH
RA PD 87329

Correct Punch Point Angles

Adjust rest so punch meets face of wheel at desired angle (see illustration). Rotate punch during grinding to make point symmetrical. Dip punch in water at frequent intervals to avoid "burning." Do not grind away more material than necessary to secure satisfactory point.

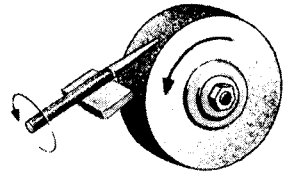

RA PD 87330

Repairing Mushroomed Head

Grind to original shape. Always temper punch after repairing mushroomed head or it will quickly mushroom again.

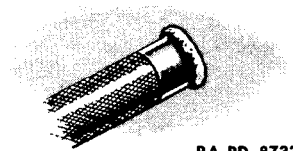

RA PD 87331

Tempering

Punches must be hardened and tempered if point has been ground back past hardened section, if punch has been heated, or if mushroomed head has been removed. Procedure for hardening and tempering is exactly like that described for machinist's chisels (section 8).

Common Misuses to Avoid

Never use a punch which has a mushroomed head. There is danger of injury from flying pieces. Grind head to original shape and temper punch before using.

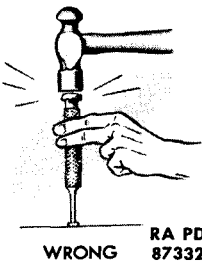

WRONG
RA PD 87332

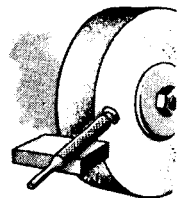

RIGHT
RA PD 87333

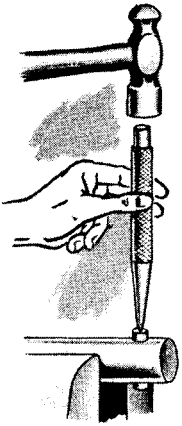

WRONG
RA PD 87334

Do not use a cone-pointed punch to drive out a pin. The punch may spread the pin and ruin the work. Use a pin punch or taper punch to do this work.

Storage

Coat punches with rust preventive compound (thin film), and store in a dry place. Upon removal from storage, wash with dry cleaning solvent to remove compound.

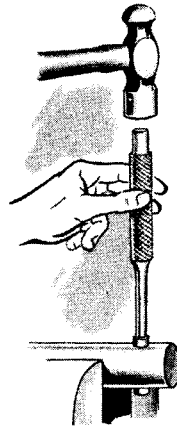

RIGHT
RA PD 87335

Section XXI

REAMERS

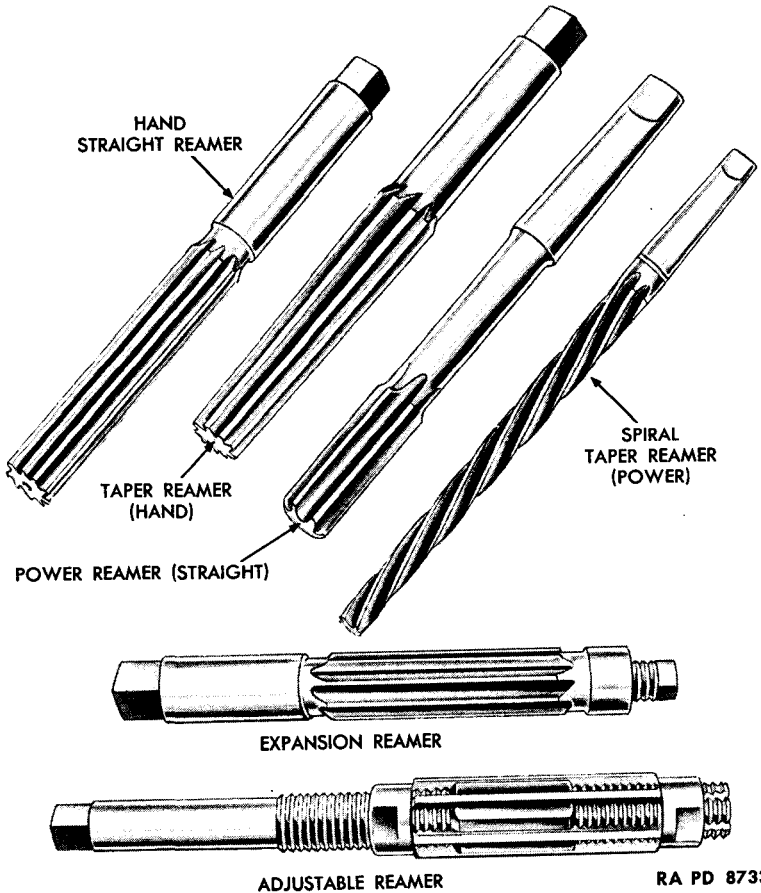

MAINTENANCE

Reamers, being precision cutting tools used for accurate sizing of holes, must be used, handled, and stored with every precaution to prevent denting, marring, or damage to the cutting edges.

Reamers must not be thrown into a tool box or allowed to lie around unprotected on the bench.

Wrap reamers in slightly oiled cloths, using preservative lubricating oil (special), when they are not in use on the bench or in tool crib storage.

Partitioned boxes or drawers make excellent tool crib storage. Each reamer must have its own storage space.

Adjustable Reamer Care

Adjustable reamers should not be adjusted beyond the maximum size for which the reamer was made.

When using removable blade reamers, make sure the adjustment has been properly made. The blades must be properly tightened between the adjusting nuts. Any looseness may cause breakage during use.

Misuses of Reamers

Turning a reamer backward to remove it from the work.

This results in dulling cutting edges, necessitating grinding to resharpen. Grinding reamers makes them cut undersize. Always turn forward (clockwise) with a reamer, using the same rotation for removing as for cutting.

Turning a hand reamer with machine power.

This practice often breaks reamers, due to use of too much power, jamming or fitting, and clogging. Avoid using hand reamers with power.

Cleaning

Blow clean with air, wipe with a clean rag, and wrap in a rag slightly dampened with oil.

Storage

Coat reamers with rust preventive compound (thin film) and store in a dry place. Store in racks or divided boxes to protect cutting edges from contact with metal. Upon removing from storage, wash with dry cleaning solvent to remove rust preventive compound.

Section XXII

SAWS

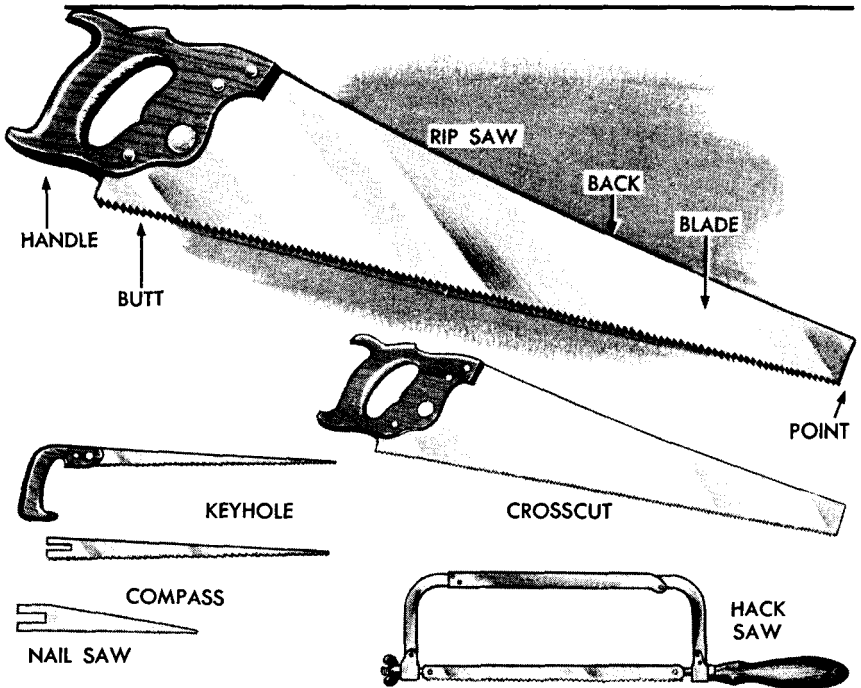

RA PD 87337

CLEANING AND OILING
(All Types of Saws)

Saws should be kept dry at all times. When necessary to use saw under unfavorable weather conditions, wipe moisture from blade after using. Always oil blade with a clean cloth dampened with preservative lubricating oil (special) after using saw. Do not permit blade to rust. Clean off all signs of rust from blade with crocus cloth. Apply oil to blade after cleaning off rust.

SHARPENING WOOD-CUTTING SAWS

General

There are two general types of teeth used on wood-cutting hand saws. Saws having one type of teeth are called rip saws and are used for cutting with the grain of wood. Saws having the other type of teeth are called crosscut saws. They are used to cut across the grain of wood. Before attempting to sharpen saws, a clear picture of the shape of these teeth is necessary.

TOP VIEW OF RIP TEETH



TOP VIEW OF CROSSCUT TEETH



TEETH OF RIP SAW



TEETH OF CROSSCUT SAW

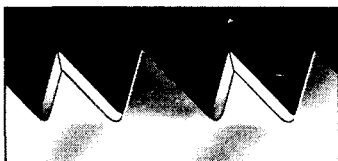

Compare the teeth illustrated and note the difference. Rip saw teeth are shaped and filed to cut like chisels. Crosscut saw teeth are shaped and filed to cut like knives.

Sharpening a saw consists of four steps: jointing, shaping, setting, and filing. These are covered below. Do them in the order given.

Jointing a Saw (Rip or Crosscut)

WHY JOINT A SAW? All teeth of a saw must be the same height. Points or cutting edges must be in a straight line. Low teeth do not cut. High teeth dig in and cause a saw to jump or buckle. A saw is jointed by filing down high teeth so they are same height as low teeth. Note uneven teeth in illustration.

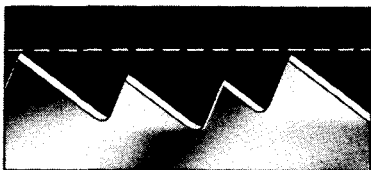

THIS RIP SAW NEEDS JOINTING WHICH IS THE FIRST STEP IN SHARPENING

RA PD 87339

How to Joint a Saw

Place a mill file flat upon teeth with length of file parallel to length of saw. Run file over full length of saw until file touches tops of all teeth.

SHOP-MADE WOODEN GUIDE FOR HOLDING JOINING FILE

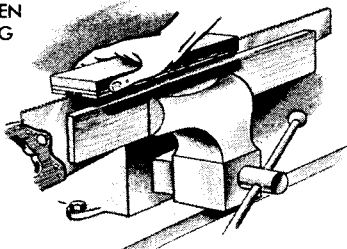
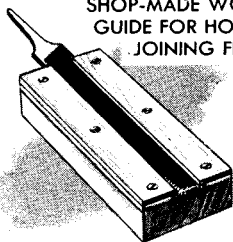

JOINING A HAND SAW

RA PD 87340

CAUTION: Check to see that all teeth are in a straight level line as in following illustration.

Shaping Teeth (Rip or Crosscut)

1. After teeth have been jointed, they must then be evenly spaced and of same size and shape as when saw was new. Determine how teeth look when new by examining unused teeth near butt of saw.

2. Place file well down in gullet and file straight across saw at right angles to blade—never otherwise. If teeth are of unequal size, press file against largest tooth until center of flat top made by jointing is reached. Move to next gullet and file until tooth has been brought to a point. Sometimes width of flat top indicates a new gullet should be carefully filed.

3. It is sometimes necessary to repeat process of jointing and shaping to assure a perfect job. The teeth now shaped and of even height are ready to set.

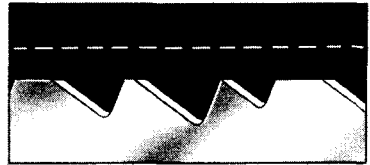

SAME SAW AS ILLUSTRATED ON PREVIOUS PAGE

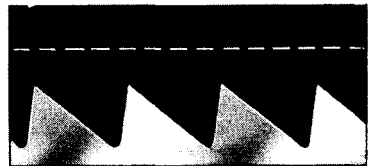
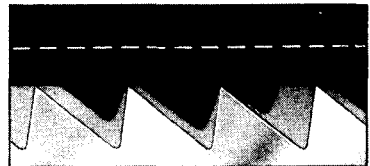

RIP TEETH SHAPED AND READY TO SET

RA PD 87341

Setting Saw Teeth (Rip or Crosscut)

General. Saw teeth must be “set” or bent outward to right and left alternately. This causes saw to cut a kerf sufficiently wide to keep blade from bending or sticking in cut. Never set teeth more than one-half the depth of teeth. Teeth may be set with or without a saw set. Both methods are given below. Use the saw set if available.

Using Saw Set. Place a saw set on saw so guides are over teeth with anvil behind tooth to be set. Adjust anvil in frame to give desired set (not over one-half the depth of teeth). Press the saw set handles together. This causes plunger to press tooth against anvil and bends it to the angle of bevel of the anvil. Similarly set every second tooth. Reverse saw set and set alternate teeth same amount in opposite direction.

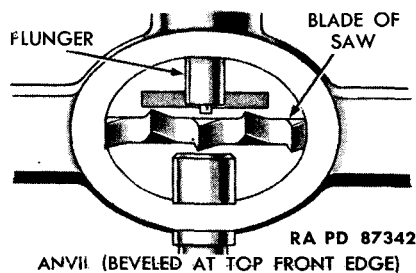

RA PD 87342

TM 9-867

Without Saw Set. Prepare a steel or hardwood block similar to sketch. Dimensions shown are minimum; block may be larger. Angle of the bevel must be determined by examination of the saw to be set; however, angle A must be not less than 146 degrees or saw teeth will break off when set.

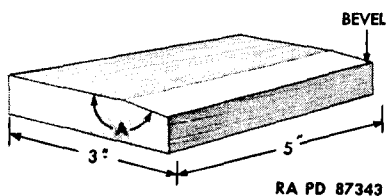

Place saw on block as shown in sketch. Clamp saw and block together. Place a blunt end punch on tooth to be set. Strike punch smartly with a hammer to set tooth. Similarly set every second tooth which is over block. Move block along to set remaining teeth. Apply block to other side of saw to set alternate teeth.

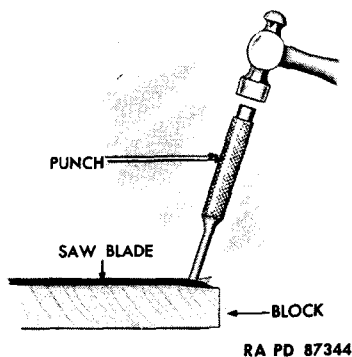

FILING THE RIP SAW

Number of teeth per inch determines point size of saw; for example, a saw having eight teeth per inch of blade is an 8-point saw. For filing $4\frac{1}{2}$ -, 5-, or 6-point saw, use a 7-inch slim taper file; for 9- and 10-point saws, use a 5- or $5\frac{1}{2}$ -inch slim taper file.

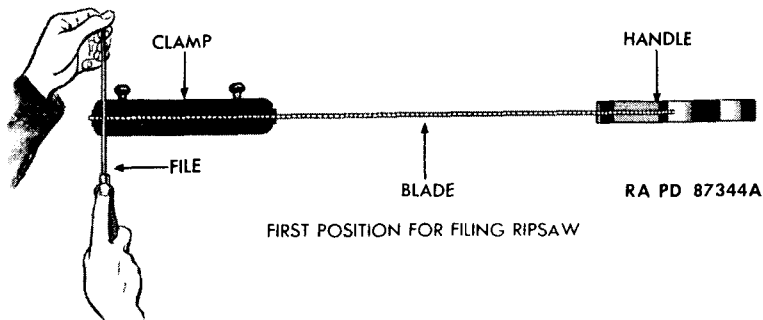

1. Joint saw lightly as an aid to filing.
2. Place saw in filing clamp *with handle at the right*. Bottom of tooth gullets should be $\frac{1}{8}$ inch above jaws of clamp. If more of blade projects, file will chatter or screech. This will dull file quickly. Start at point of rip saw indicated in above illustration. Pick out first tooth set toward you. Place file in gullet to left of this tooth. Hold file level and at angle indicated (right angle). File should set well down in gullet. Study unworn teeth near handle—factory shaped teeth are an excellent guide.

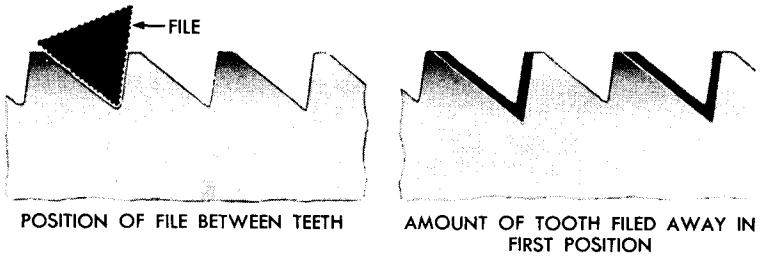

RA PD 87345

File should cut on push stroke. It files back of tooth to left and front of tooth to right at same time. File teeth until one-half of flat tops, made as a guide, are cut away. Lift file from gullet and skip next gullet to right. Place file in second gullet toward handle. Repeat filing operation at same angle as before, and continue skipping one gullet until you reach handle end of saw.

3. Turn saw blade around in clamp, placing handle of saw to *left*. Take position indicated in following figure.

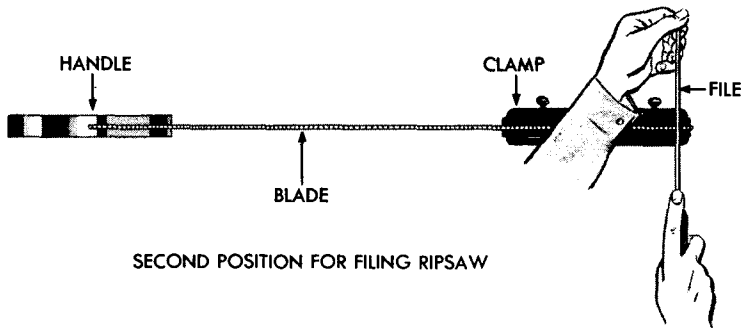

Place file in gullet to *right* of first tooth set toward you. This is the first of gullets you skipped when filing other side of saw. At correct angle (right angle), file until you cut away other half of flat top and teeth are shaped to points. Continue this operation in every second gullet until you reach saw handle. All teeth should be same height and shape.

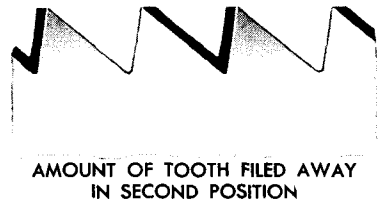

RA PD 87347

FILING CROSSCUT SAW

Crosscut saw filing is exactly the same as rip saw filing with one highly important exception—the angle at which file is held. A crosscut saw is filed so teeth have a 45-degree bevel. Handle end of file is held about 15 degrees below the horizontal. Study following illustrations.

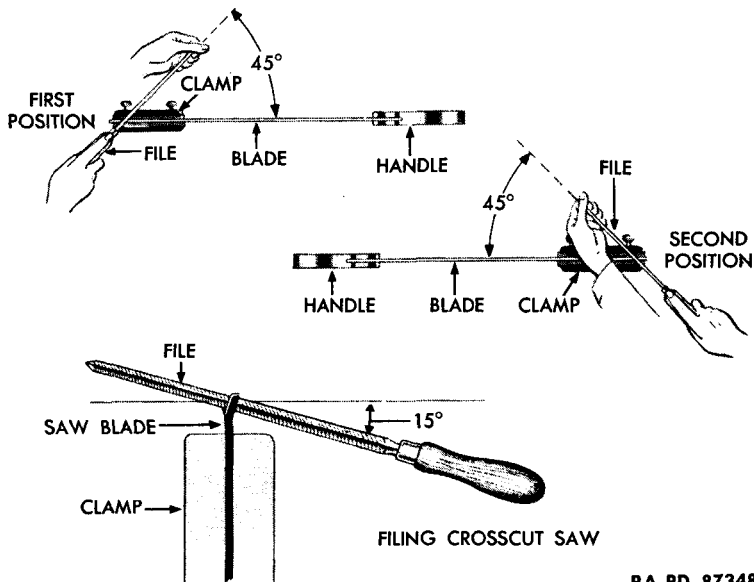

RA PD 87348

After one side of saw is filed, turn it around and file other side. *Never file all teeth from same side, as this causes saw to run to one side.*

NOTE: Variations in bevel in crosscut saw for work on medium or hard woods are desirable, but only experience will indicate what is best.

Additional Filing Hints

1. Tighten clamp securely to reduce vibration.
2. Use file recommended for work.
3. Adjust stroke so file is eased into gullet.
4. File at rate of about 60 strokes per minute—no more.
5. Use long, steady, uniform stroke.
6. Raise file on return stroke.
7. Exert enough pressure on file to keep it cutting on forward stroke. Do not slide file.
8. Shape teeth with a worn file. Sharpen with a new one.

REPLACING HANDLES (Most Types of Saws)

Remove the special screws and nuts which attach handle to blade. Slide handle off blade. Position new handle on butt end of blade with screw holes in handle and blade aligned. Install the special screws and nuts which attach handle to blade.

Common Misuses (Wood-cutting Saws)

Do not lay saws on floor or place loose in a tool box. Such treatment may lead to dulled or bent teeth or sprung blades. Hang saws up when not in use.

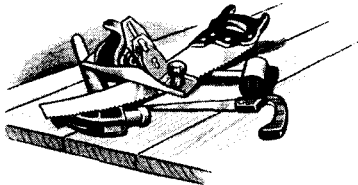

WRONG

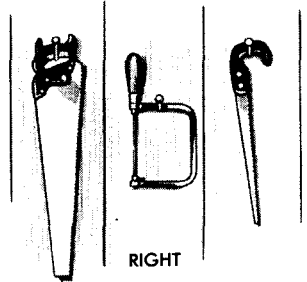

RIGHT

RA PD 87349

Never saw into nails with a wood-cutting saw. This will dull, bend, or break teeth. Remove nails from repair or alteration work before sawing.

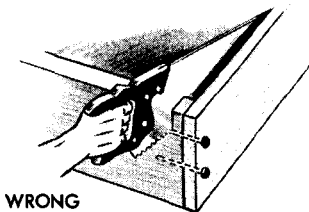

WRONG

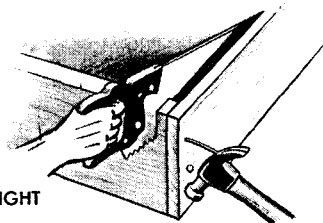

RIGHT

RA PD 87350

Do not twist off strips of waste with blade. This dulls and bends teeth and may spring blade. Break off strips of waste with hand or mallet.

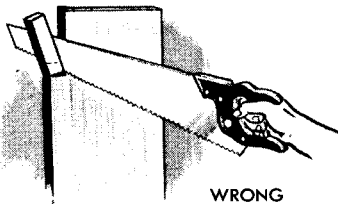

WRONG

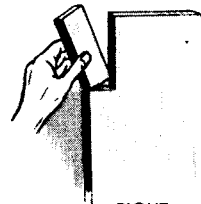

RIGHT

RA PD
87351

TM 9-867

Do not allow waste side of work to break off as cut is made. This practice causes work to split. Support waste side and cut clear through work.

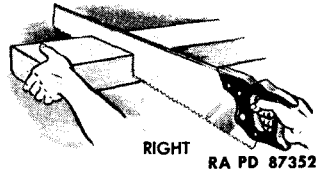
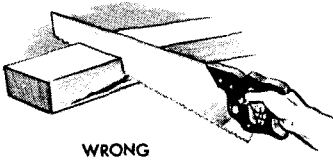

Do not allow end of saw to strike floor. There is danger of springing the blade. Raise work high enough to get clearance. If work cannot be raised, limit the stroke.

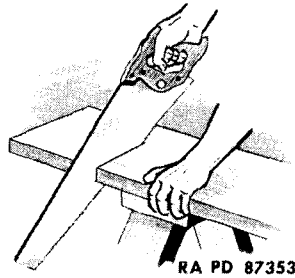
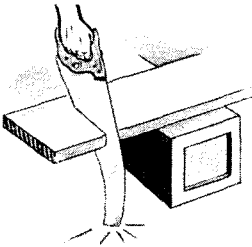

Care and Adjustment of Hacksaws

Select blade with proper number of teeth per inch to handle job at hand. Following table shows blades to use for various jobs to be done with hand hacksaws.

Material	Teeth Per Inch
Aluminum	14
Brass—cast (soft)	18
Brass—cast (hard)	18
Brass tubing	24
Cast iron	18
Copper	14
Cold-rolled steel	18
High-speed steel	18
Iron pipe conduit	24
Steel tubing	24
Structural steel	18
Tool steel	18

Install blade in frame to cut on forward stroke. When in use, make tension of blade great enough so it cannot buckle under pressure

of the stroke. On the other hand, do not strain blade so much that slight canting of the frame will break it.

Relieve blade tension when saw is not in use.

Common Misuses (Hacksaws)

Do not attempt to do job with wrong type blade. It makes work hard to do and results in blade spoilage. Use blade recommended in table under "Care and Adjustment of Hacksaws," on page 86.

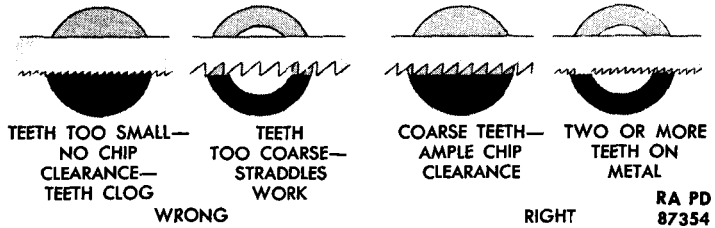

Do not attempt to cut insecurely fastened work. Blade breakage often results. Anchor work securely.

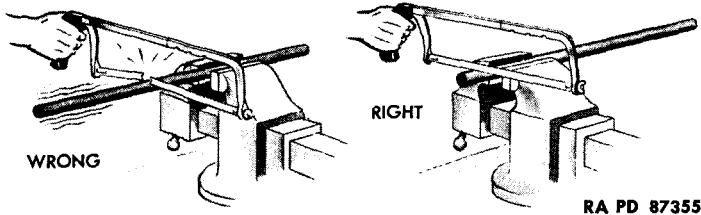

Do not use a new blade in a cut started with another blade. The new blade is likely to wedge and break. Turn work over and start new cut from opposite side.

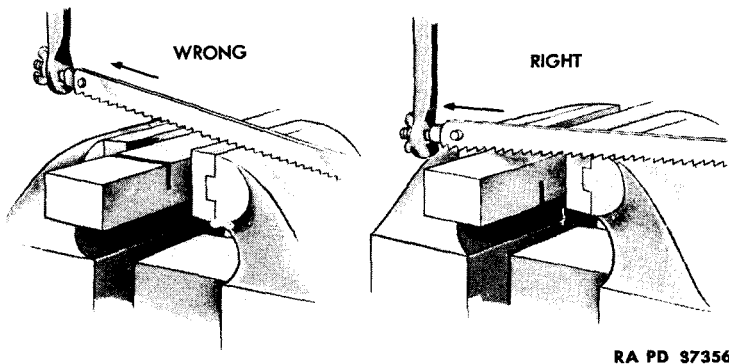

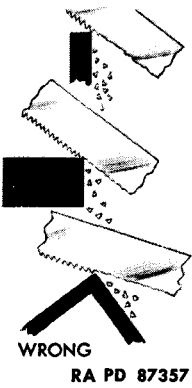

Never start cuts on sharp angles. This practice is likely to strip saw teeth. Start the cut with blade held at a slight angle to the surface.

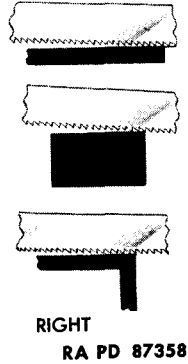

Do not install blade so teeth point toward handle. Blade will not cut properly. Point teeth away from handle, tighten securely, and retighten after first few strokes.

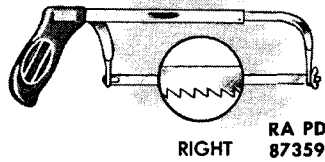
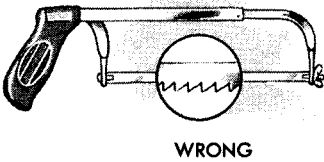

Do not apply too great or insufficient pressure to blade. Either abuse ruins blades. Apply just enough pressure on face stroke to make teeth "bite."

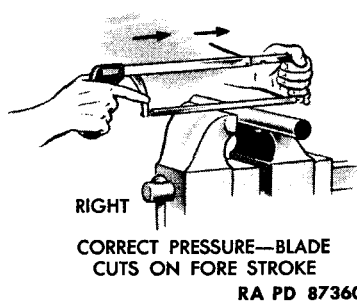
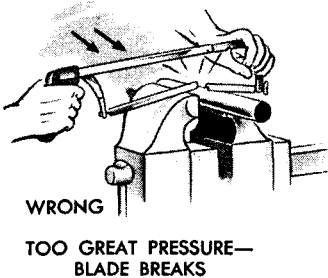

Storage

Apply rust preventive compound (thin film) to blades to prevent rust, and store so teeth will not be dulled by contact with other tools. Upon removal from storage, wash metal parts with dry cleaning solvent to remove compound.

Section XXIII

SCRAPERS

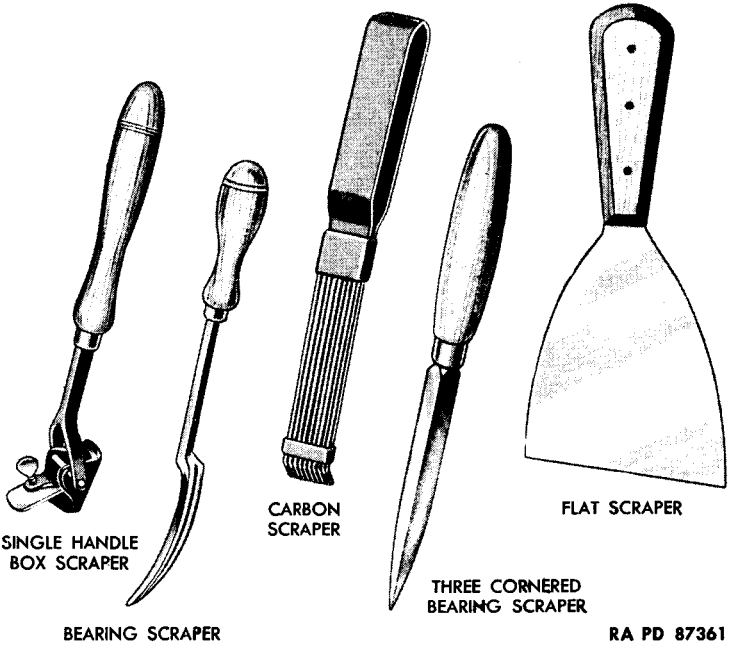

CARE AND CLEANING

Protect cutting edges of bearing scrapers by enclosing blade in a cloth case when not in use.

Keep scrapers clean at all times. Wash them in dry cleaning solvent and wipe them with a clean cloth.

SHARPENING



CROSS SECTIONS OF BEARING SCRAPERS
RA PD 87362

Bearing Scrapers

Select an oilstone "slip" of exactly the right size to fit interior bevel of hollow-ground scraper. Hold scraper firmly on a bench and rub slip back and forth full length of bevel a few times.

Flat Scrapers

Flat scrapers are sharpened with a file or on an oilstone, forming a bevel on one side only.

BOX SCRAPERS

General

Two types of edges are used on box scrapers, square turned edge and bevel turned edge. For fine work, use square turned edge; for fast work, use bevel turned edge.

Square Turned Edge

Adjust guide of a fine abrasive wheel to right angles with face of wheel. Grind tip of scraper blade, as illustrated, until perfectly square.

Clamp blade in vise and smooth off edge with a fine mill file. Use care to keep edge flat and at right angles to sides of blade.

Use a burnishing tool or a smooth piece of steel such as the heel of a file or the side of a chisel blade to rub the scraping edge of tool as illustrated. Use considerable pressure. Stop burnishing as soon as the edges are turned as illustrated.

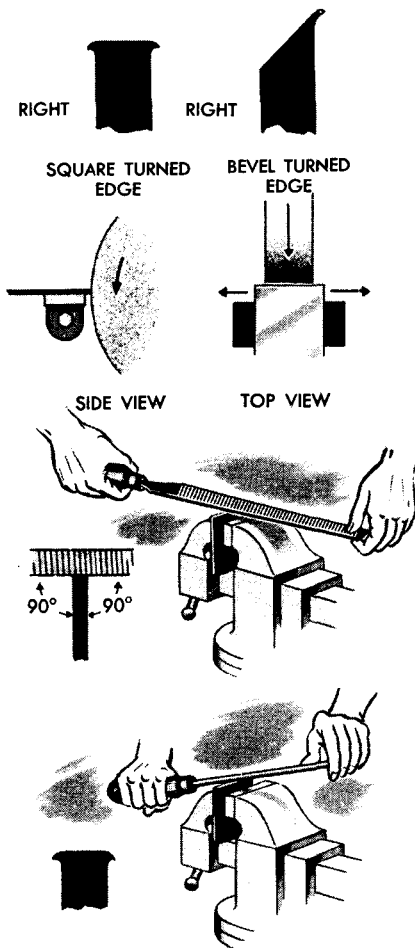

RA PD 87368

Bevel Turned Edge

Adjust rest of an abrasive wheel to get a bevel of about 45 degrees. Grind scraper as illustrated until indicated bend is obtained. Dip frequently in water to prevent burning. Do not grind away more metal than necessary to obtain a nick-free and straight bevel.

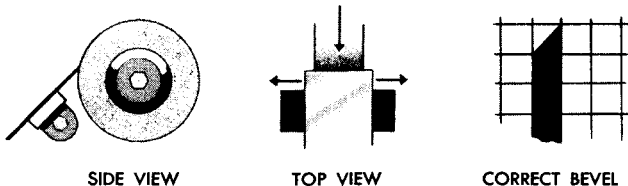

RA PD
87364

Place bevel flat on a fine oilstone. Swaying the entire body from the feet, rub blade (in a figure eight motion) over surface of stone. Brush feather edge from scraper by rubbing flat side of blade lightly over stone.

Clamp blade in vise as illustrated. With a burnishing tool, or other piece of flat smooth steel, rub edge with sufficient pressure to turn it as shown in sketch.

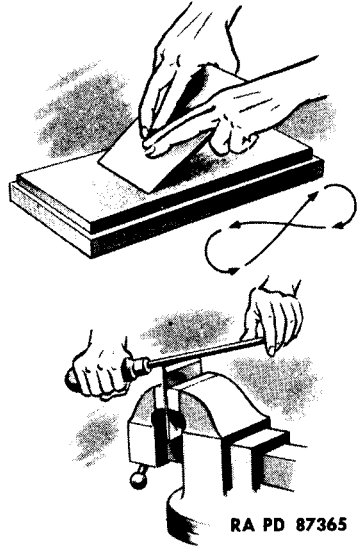

Common Misuses

Do not use scrapers as chisels, screwdrivers, knives, awls, or punches. Such use will dull the

scraper, and may bend or break it. Use tools only for purpose for which they are intended.

Never toss scrapers into boxes or onto other tools when not in use. Their edges will be dulled. Keep scrapers in racks or divided boxes when not in use.

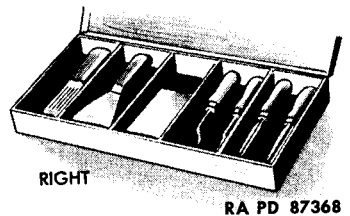
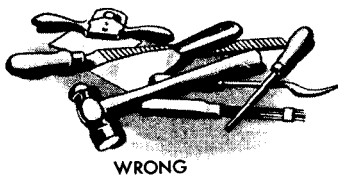
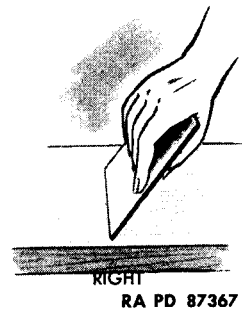
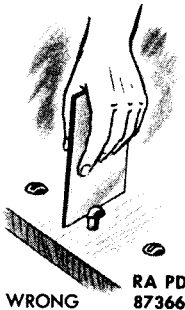

Storage

Coat scrapers with rust preventive compound (thin film) at time of storing, and store in a dry place. Upon removal from storage, wash metal parts with dry cleaning solvent to remove rust preventive compound.

SCREWDRIVERS

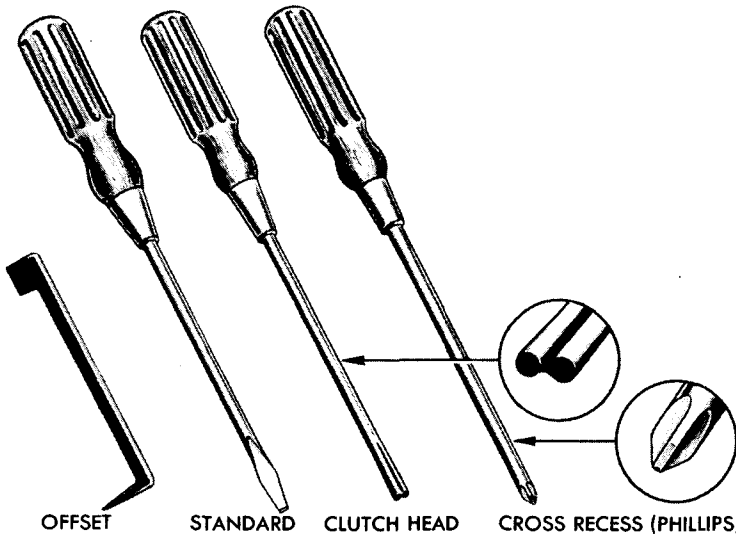

RA PD 87369

CARE AND CLEANING

Wash grease and grime from screwdrivers with dry cleaning solvent. Scour rust from blade with crocus cloth or aluminum oxide abrasive cloth. Keep blade coated with a film of preservative lubricating oil (special) or engine oil (SAE 10). Lubricate spirals and friction surfaces of spiral ratchet screwdrivers with preservative lubricating oil (special) or engine oil (SAE 10).

GRINDING

Standard Type Screwdriver

Screwdriver tips should be ground with sides parallel to keep tool from lifting from screw slot when in use.

CAUTION: Dip screwdriver in water frequently during grinding to prevent loss of temper by overheating.

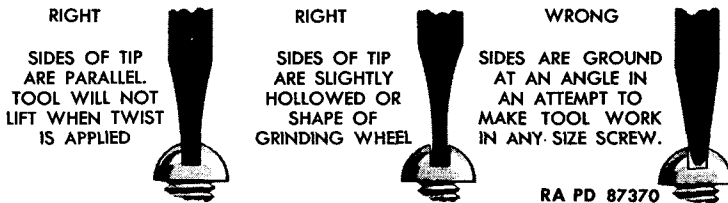

RA PD 87370

1. Adjust rest to hold screwdriver at right angles to grinding surface of wheel. Grind end square. Do not grind away more material than necessary to remove nicks and "square up" end.

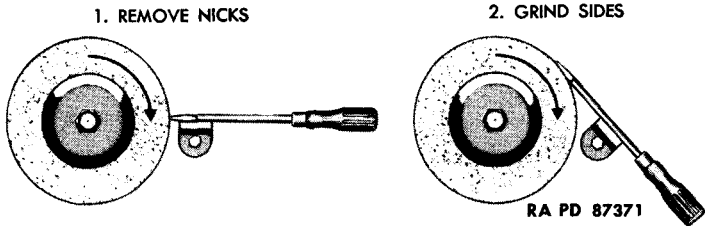

2. Adjust rest to hold screwdriver against wheel to give desired parallel or concave shape. Grind both sides until tip is of required thickness.

Cross Recess and Clutch Head Screwdrivers

Tools of this type require special holding fixtures to grind. In an emergency, these tools can be shaped by grinding or filing. Use care to maintain original angles and bevels.

Tempering

If hardened tip has been broken off or ground away, or if tool has been heated, screwdriver must be hardened and tempered.

Heat about one and one-half inches of tip of blade to cherry red with a gasoline torch, gas furnace, or charcoal fire. Dip about 3/4 inch of tip in clean, cold water. Quickly rub hardened end with aluminum oxide abrasive cloth or oilstone to brighten it. Watch color creep back into tip from heated portion of blade. Quench when light blue color reaches tip.

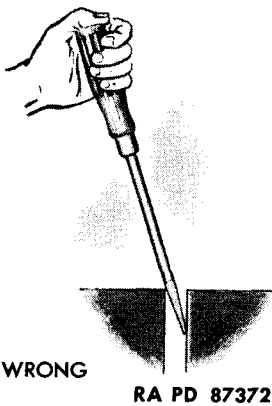

Polish blade with emery cloth and crocus cloth in turn. Grind blade to proper shape.

Common Misuses to Avoid

Do not use a screwdriver as a pry bar. It will bend or break. Use pry bar for prying.

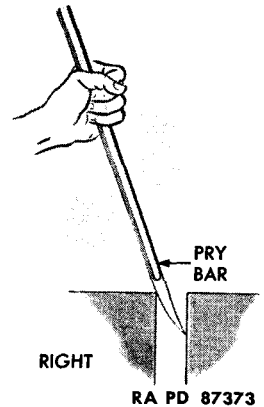

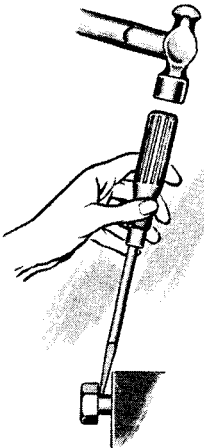

WRONG

Never use a screwdriver for a chisel. Such use may break or bend the screwdriver. Use a chisel for chiseling.

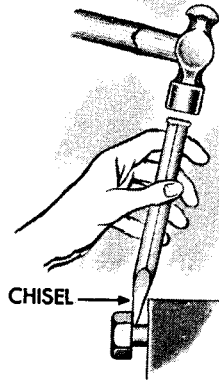

RIGHT



WRONG

Do not use a screwdriver with blade tipped in screwhead. This is likely to break the blade or screwhead. Keep screwdriver shank perpendicular to screwhead.



RIGHT



WRONG

RA PD 87374

Do not attempt to use a wrong size screwdriver. This practice causes battered screwheads and bent and broken screwdriver blades.



RIGHT

RA PD 87375

Never use pliers or wrench on screwdriver blade. Blade is likely to bend or point break off. Apply only what pressure can be put on handle by hand.

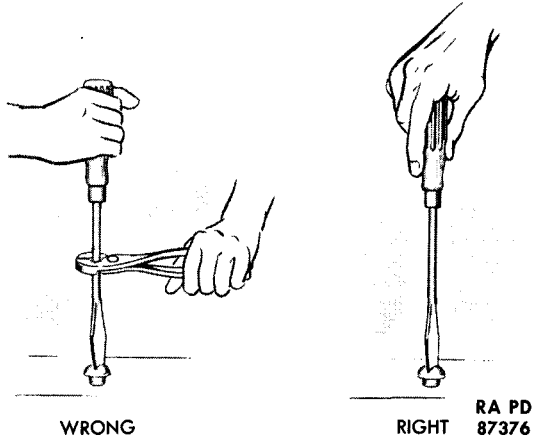

Storage

Spread rust preventive compound (thin film) over metal parts of screwdrivers, and store in a dry place. Upon removal from storage, wash metal parts with dry cleaning solvent to remove rust preventive compound.

SHEARS

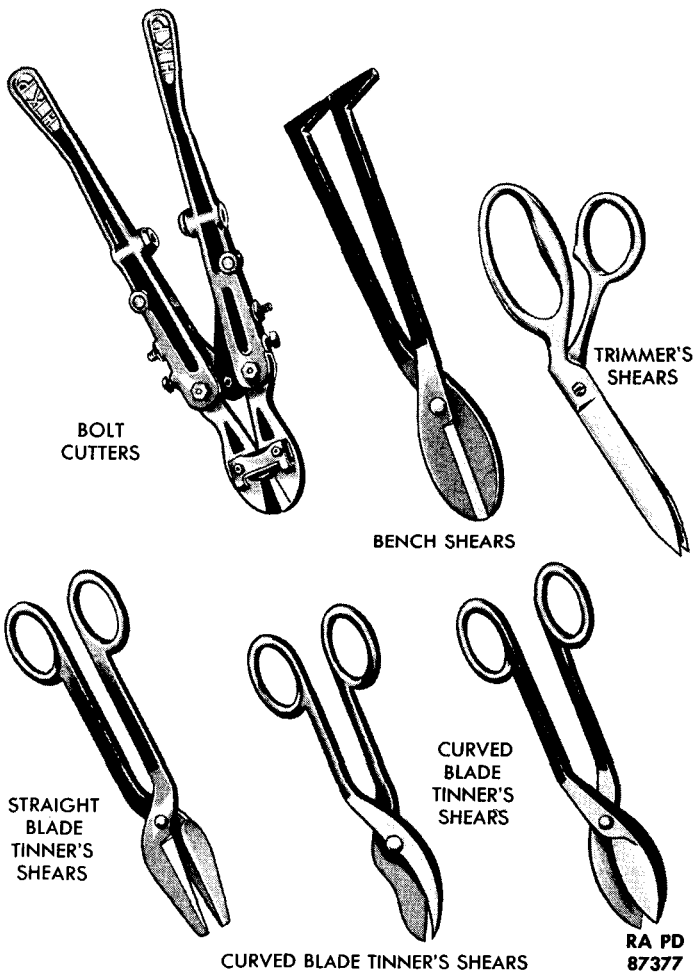

CARE AND CLEANING

Wash grease or other dirt from shears with dry cleaning solvent and dry with a soft cloth. Lubricate pivot screw or bolt with a drop of preservative lubricating oil (special) or engine oil (SAE 10). Scour rust from shears with fine aluminum oxide abrasive cloth. Apply a light film of oil to shears with a cloth to prevent rust. Keep pivot screw or bolt tight enough to prevent side play but not tight enough to cause binding.

General

GRINDING

Shears must be ground if cutting edge is nicked or if bevel is distorted from improper sharpening. Dull shears can usually be sharpened on an oilstone without grinding. Never grind shears if sharpening will suffice; most shears are useless after two or three regrindings. A single bevel is used. It may be flat or concave. It must not be convex. Study the following cross-section views of correct and incorrect bevels.

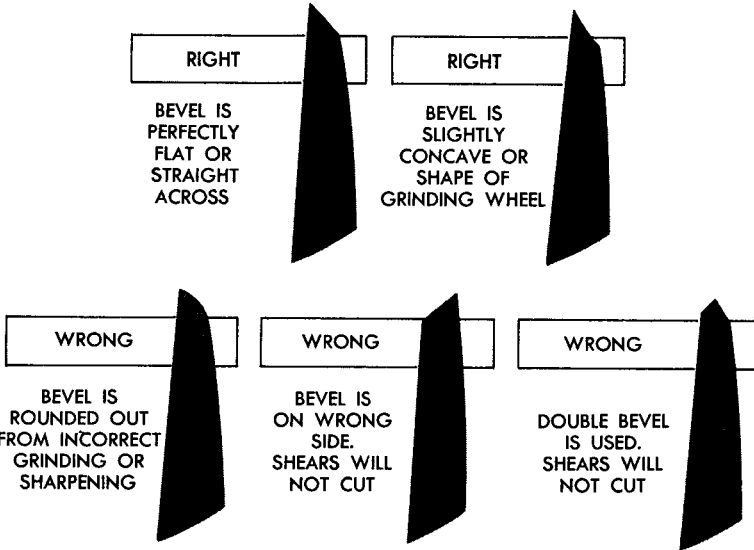

Bevel angles vary with type of work for which shears are used. Bevel usually makes an angle of from 60 to 85 degrees with flat inside surface of blade. Paper-cutting and cloth-cutting shears are usually ground to a 60-degree bevel; tin-cutting shears are usually ground to a bevel of approximately 85 degrees. Bevel angle can usually be determined by examining an undamaged portion of blade. If bevel has been distorted its entire length, examine an undamaged pair of similar type shears to ascertain what correct bevel should be.

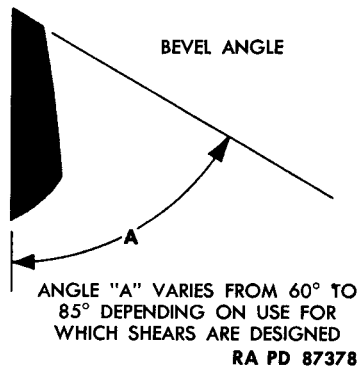

Procedure

CAUTION: Use a fine grain wheel, properly dressed. Dip shears into water frequently during grinding to prevent loss of temper.

1. Adjust rest to position which will give correct bevel.
2. Start wheel and place shears blade on rest, bevel side down. Move blade into contact with wheel. Move shears blade continually from side to side during grinding. Keep motion uniform to ensure straight cutting edge.
3. Turn shears over on rest and grind other blade.

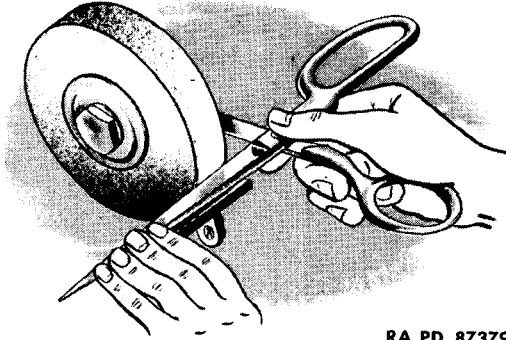

RA PD 87379

Sharpening

Apply blade to lightly oiled oilstone so flat surface lies flat on stone with blade crossing stone at right angles. Draw blade smartly across stone from heel to point, so as to remove wire edge. Start each stroke at heel of blade. Stone other blade in same manner.

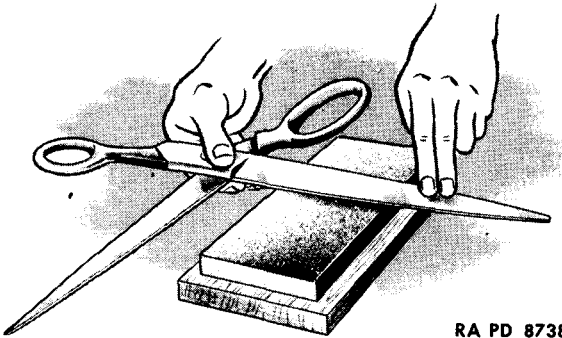

RA PD 87380

Common Misuses

Never use shears as screwdrivers, hammers, or pry bars. They break easily. Use any tool only for the purpose for which it was designed.

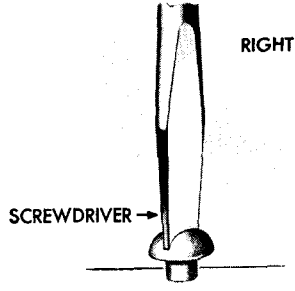
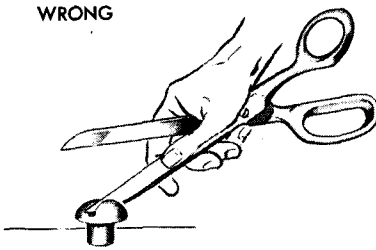

RA PD 87381

Do not attempt to cut heavier materials than shears are meant to handle. It will dull and possibly break the blades. Use shears designed to do the job.

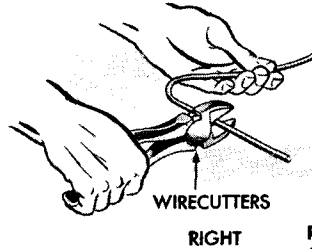
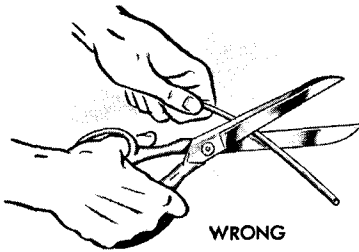

RA PD 87382

Never toss shears into a tool box. They will become dull and are likely to be broken. Hang them on hooks or lay them on an uncrowded shelf when not in use.

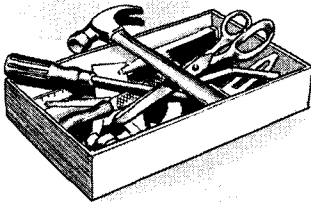

WRONG

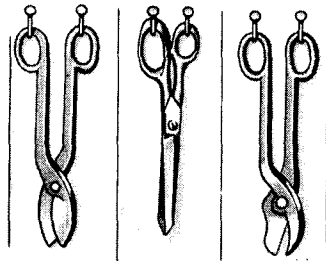

RIGHT

RA PD 87383

Storage

Apply rust preventive compound (thin film) to shears at time of storing. Store in a dry place with cutting edges protected from contact with other objects. Wash off rust preventive compound with dry cleaning solvent upon removal from storage.

SOLDERING IRONS

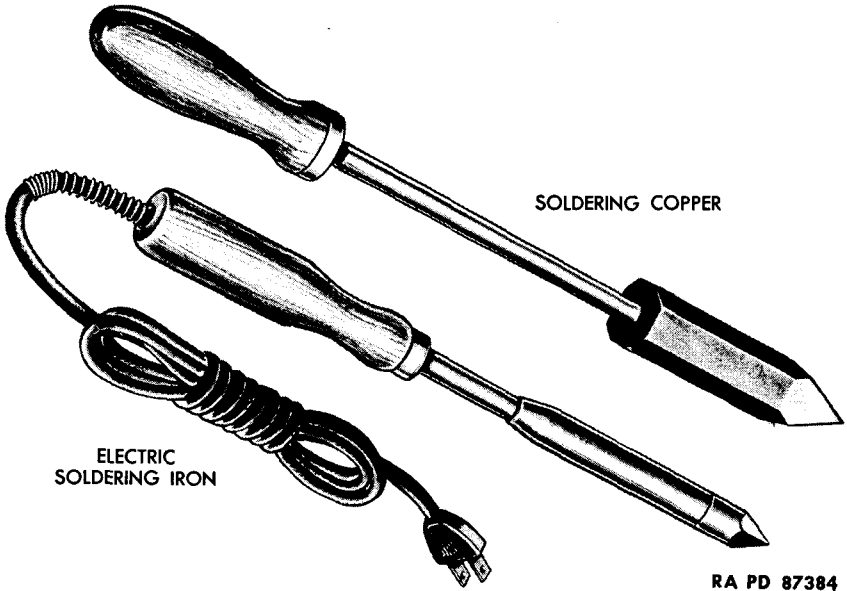

PREPARING FOR USE

Soldering Copper

This involves cleaning, heating, hammering, annealing, filing point, and tinning. Some of these steps are not required every time a copper is conditioned. To perform satisfactorily, a copper must have a well-formed, well-cleaned, and well-tinned point.

1. File all old solder and scale from point end. This is important. If neglected, solder and scale will prevent proper tinning of point.

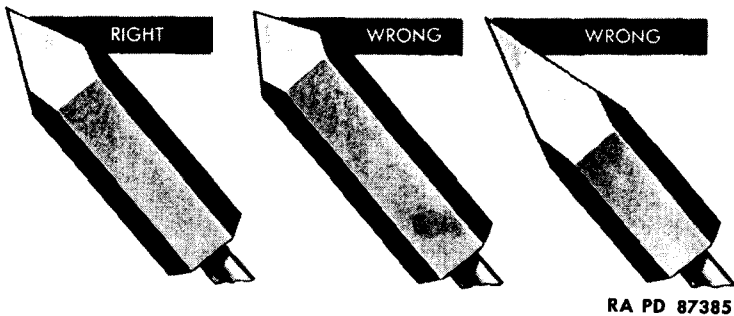

2. Heat copper to a dull red. Do not direct heat at point because of danger of burning it. Use gas flame, blowtorch, or charcoal fire.
3. File point to proper shape. Point should taper back to efficient working angle, depending on size of copper. Point should be slightly rounded.
4. Plunge red-hot copper into cold water. This anneals copper, making it softer for filing, easier to tin, and more efficient at giving off heat.
5. File all rough spots from point end of copper, finishing with a fine file to a flat, smooth surface. This polishing makes tinning last longer.
6. Heat copper so it will just melt solder. Wipe copper on wet rag to clean surfaces. Place a few drops of solder on block of ammonium chloride (sal ammoniac). Rub copper on ammonium chloride and in melted solder until copper acquires a bright tinned surface.

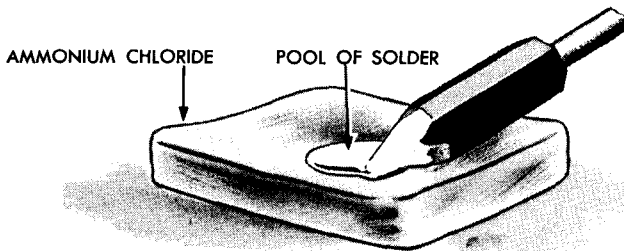

TIN POINT

RA PD 87386

7. Clean tinned point each time it is removed from heater. When pits form on copper back of tinned area, heat copper and dip in water to remove scale.

Electric Soldering Iron

Shape and clean point by filing. Tin point in manner similar to procedure for tinning soldering copper. However, do not use external source of heat and do not dip iron in water.

REPAIR

(Electric Soldering Iron)

1. If iron does not heat with plug installed in a "live" receptacle, an open circuit is indicated in plug, cord, or element. Visually inspect the parts to see if there is a bent plug prong or "pulled" connection. Feel along length of wire for breaks inside insulation. If open circuit cannot be found by visual inspection, disconnect cord from iron. Test cord and element separately with test lamp. Replace faulty part.

TM 9-867

2. If fuse "blows" when iron is plugged into receptacle, a short circuit is indicated in plug, cord, or element. Inspect plug and cord, looking for damaged insulation. If unable to locate short, test cord and element separately, with test lamp. Replace short-circuited parts.

Common Misuses

Do not leave electric soldering iron connected for long periods on the chance it may be wanted. This practice is hard on elements and wasteful of current. Disconnect electric soldering iron when not in use.

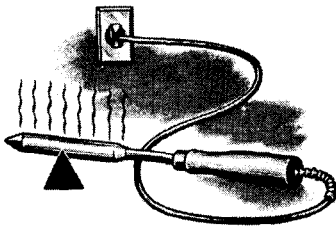

WRONG

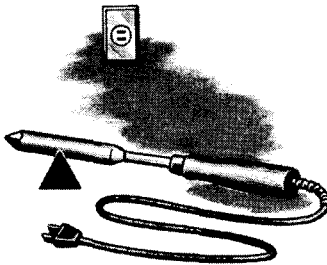

RIGHT RA PD 87387

Do not throw coppers into tool box. There is danger of battering the point. Hang coppers up or place on an uncrowned shelf when not in use.

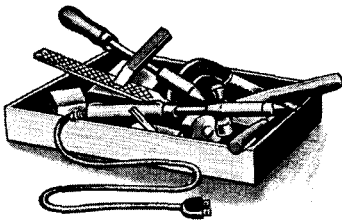

WRONG

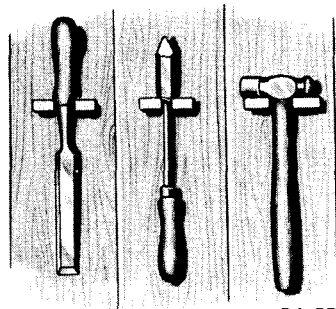

RIGHT

RA PD
87388

Storage

Coat iron shaft and ferrule with rust preventive compound (thin file), and store in a dry place.

Section XXVII

TAPS AND DIES

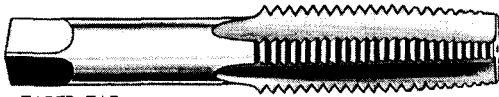

TAPER TAP

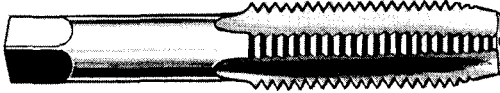

PLUG TAP



BOTTOMING TAP

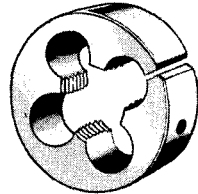
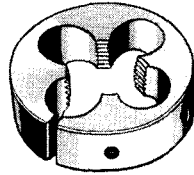

ROUND SPLIT DIE



DIE STOCK



PIPE TAP

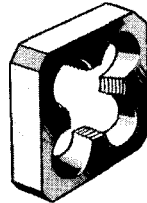
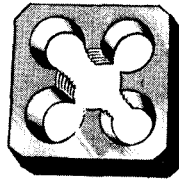

PIPE DIE

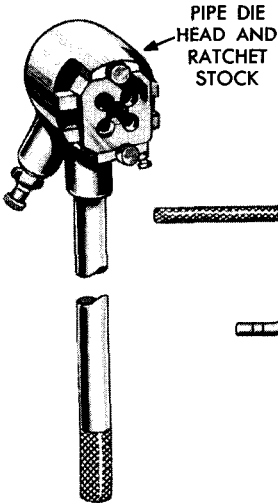

PIPE DIE HEAD AND RATCHET STOCK

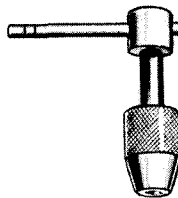

TAP WRENCHES

CARE IN USE

Taps and dies are cutting tools whose use will result in much breakage unless properly handled. This is due to their brittleness and hardness.

Do not attempt to cut threads in hardened material. The result would be a broken, chipped, or dulled tap or die.

Do not attempt to cut a thread with a die when the diameter of the part to be cut exceeds the major diameter of the thread.

Drill tap drill holes to correct size. A hole that is too small will cause the tap to bind and a broken tap will result.

Tap small sizes very carefully. Avoid any jerky motion or over-power, as a broken tap will result.

Aline tap properly with hole, as incorrect alinement will result in a broken or worn tap.

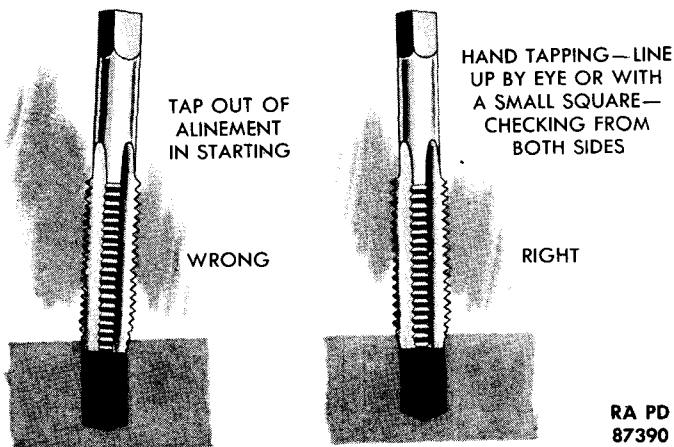

RA PD
87390

Dull taps break easily. Keep taps sharp.

Use of improper lubricant or insufficient lubricant causes undue wear and breakage of taps and dies.

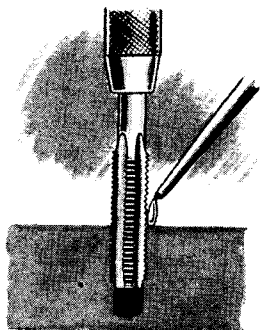

RA PD 87391

Lubricants for Hand Tapping and Die-cutting Threads

Mild steel—Mixture of 75% engine oil (SAE 10) and 25% white lead.

High carbon and alloy steel—Lard oil.

Hard steel—Turpentine.

Brass—Lard oil.

Copper—Lard oil.

Aluminum—Dry cleaning solvent.

Monel metal—Lard oil and white lead.

Cast iron—Dry.

For tapping blind holes, tap drill sufficiently deep so there is ample room for chips, or a broken tap will result.

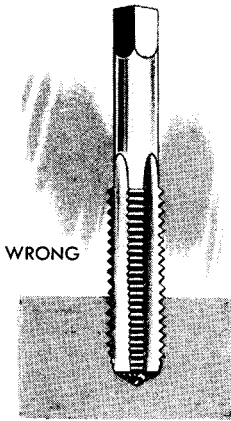

CHIPS BIND TAP—DRILL HOLE DEEPER TO PREVENT BINDING AND RESULTANT TAP BREAKING

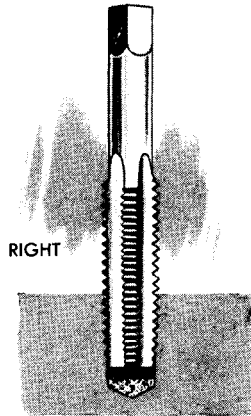

HOLE HAS SUFFICIENT DEPTH TO KEEP CHIPS FROM BINDING
RA PD 87392

Remove all chips from a blind hole before using final bottoming tap. This prevents breakage of bottoming tap.

Select proper size tap wrench. A large wrench on a small tap may cause undue strain and breakage will result.

Taps must be kept in a box, as illustrated, when not in use.

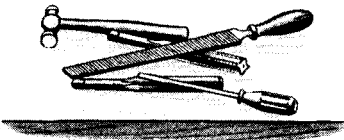

WRONG



RIGHT—HAVE AN ARRANGEMENT SO TAPS AND DIES WILL NOT STRIKE EACH OTHER OR ANY OTHER TOOLS
RA PD 87393

Sharpening Taps

Dull leading or chamfered threads cause much tap breakage. Keep taps sharp by proper grinding.

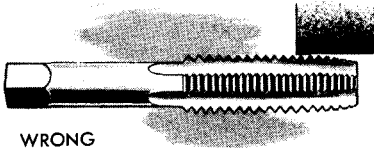

RIGHT

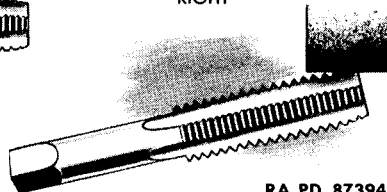

RA PD 87394

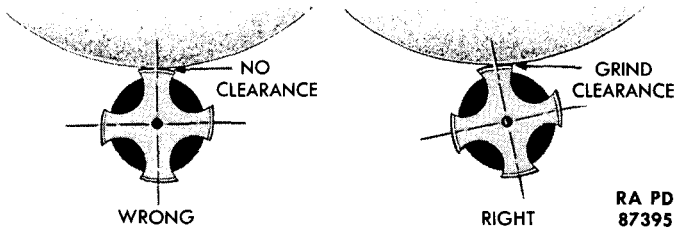

Cleaning

Blow taps and dies clean with air and wipe off excess oil with a clean rag after using. Place in rack or box after cleaning. Pipe die head and ratchet must be partially disassembled before cleaning with air and rags.

Storage

Coat all parts with rust preventive compound (thin film) and store in a dry place. Store in racks or divided boxes to protect cutting edges from contact with metal. Upon removing from storage wash with dry cleaning solvent to remove rust preventive compound.

Section XXVIII

VICES

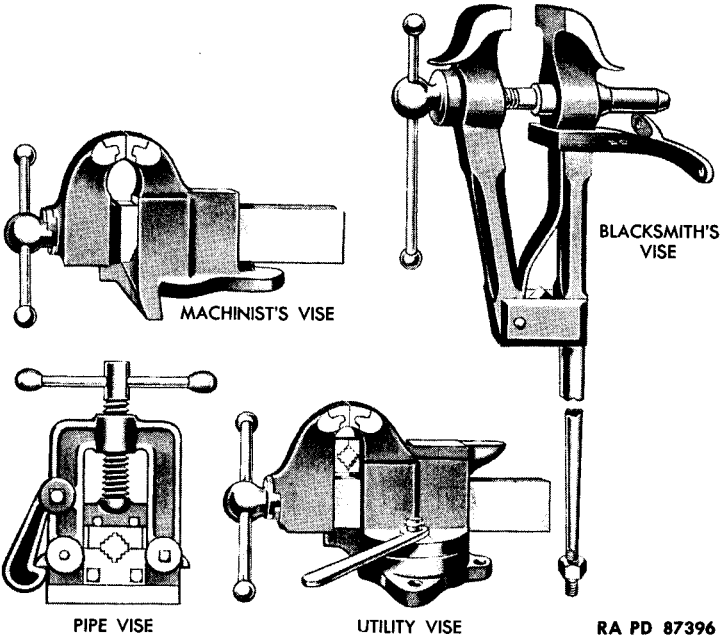

Cleaning

Wash grease and dirt from vise with dry cleaning solvent. Wipe dry with a cloth. Clean jaws with a wire brush. Pick chips from between serrations with a file scorer or a flattened iron wire.

Lubrication

Lubricate slide and worm lightly with preservative lubricating oil (special) or engine oil (SAE 10). Lubricate sparingly; excessive amounts help cause a messy shop.

Common Misuses

Do not use vise jaws as a heavy anvil. There is danger of breaking jaws or battering inserts. Use an anvil for anvil jobs.

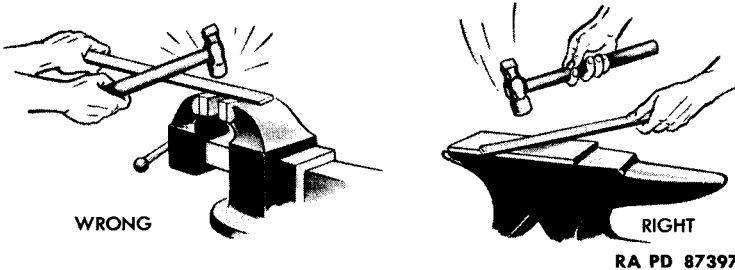

TM 9-867

Never use a pipe to increase handle leverage. There is danger of bending or breaking the handle. Tighten only as tight as can be done without an extension.

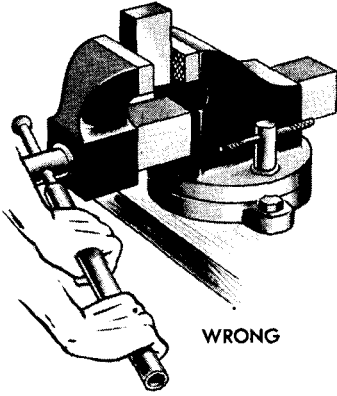

WRONG

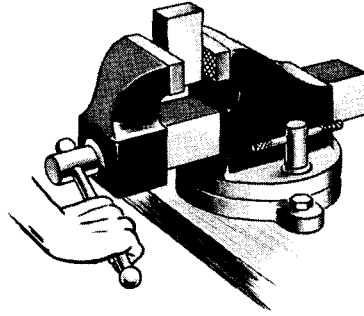

RIGHT

RA PD 87398

Storage

Wash lubricants from vise with dry cleaning solvent. Dry vise thoroughly. Coat all surfaces of vise with rust preventive compound (thin film) and store in a dry place. Upon removal from storage, wash off the rust preventive compound with dry cleaning solvent.

Section XXIX

WRENCHES

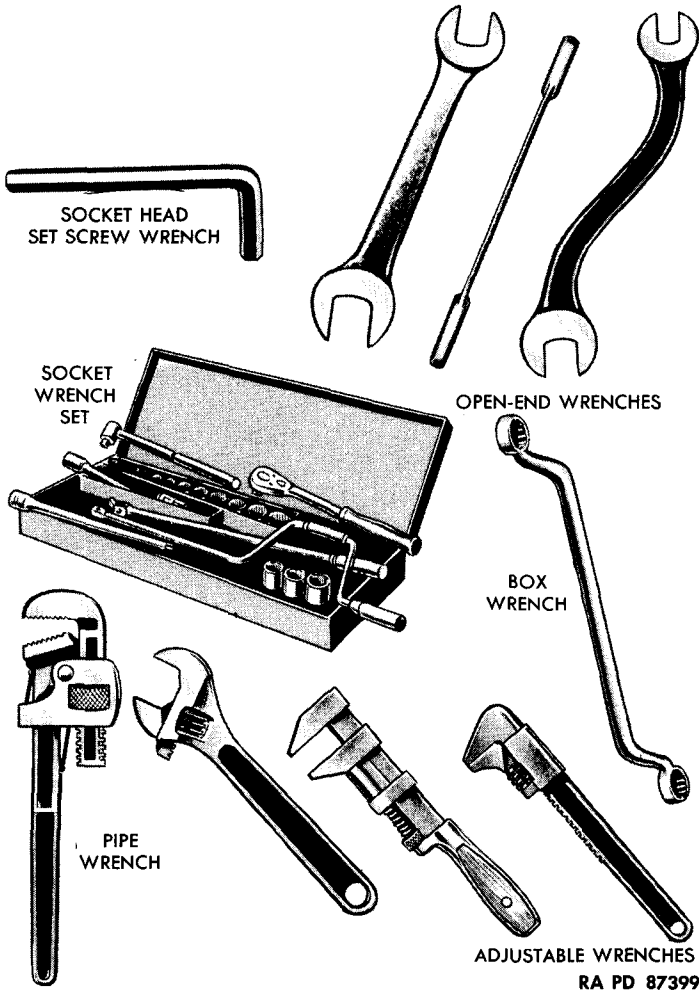

CLEANING AND CARE

Wash grease and dirt from wrenches with dry cleaning solvent. Wipe dry with a clean cloth. Clean chips from jaw serrations with a file scorer or flattened iron wire. Scour rust from wrenches with crocus cloth or fine aluminum oxide abrasive cloth. Lightly coat wrenches which show tendency to rust with preservative lubricating

oil (special) or engine oil (SAE 10). Lubricate slide and worm of adjustable wrenches with a drop or two of the oil.

MAINTENANCE

Grinding and Filing

Open-end and adjustable wrenches with battered, nicked, or spread jaws can sometimes be made serviceable by grinding and/or filing. When attempting this repair, enlarge open-end wrenches to next standard size. Make jaw faces perfectly flat and parallel. Dip wrench in water frequently when grinding to preserve temper.

Removing Play from Adjustable Wrench

1. Remove screw which acts as worm axle from wrench. Lift worm and worm spring from wrench.
2. Stretch worm spring. Insert spring into cupped end of worm and reassemble wrench. Tighten worm axle screw securely.
3. Prick punch wrench adjacent to screw to lock screw in position.

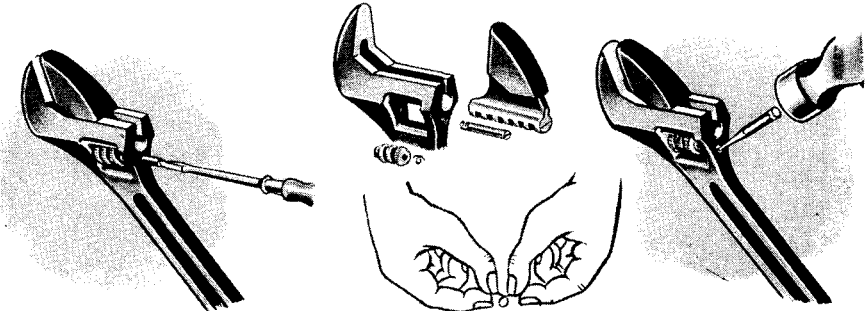

DISASSEMBLE WRENCH

STRETCH WORM SPRING

LOCK SCREW

RA PD 87400

Renewing Pipe Wrench Jaw Serrations

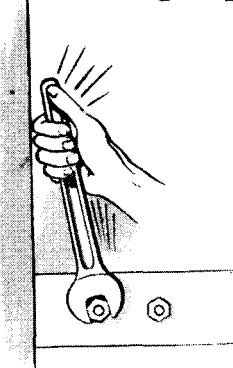

WRONG

RA PD 87401

Using a fine three-cornered or taper file, carefully deepen low points between serrations.

Common Misuses

Do not push on a wrench. It's dangerous. Arrange work so you can pull on wrench.

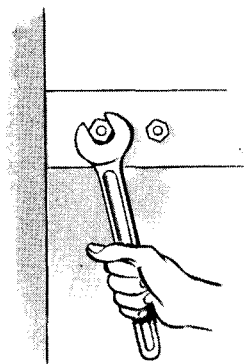

RIGHT

RA PD 87402

Never use a wrench which fits the nut poorly. This practice batters nuts and spreads wrenches. Use correct size wrench.

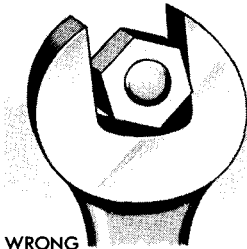

WRONG

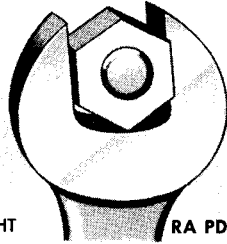

RIGHT

RA PD 87403

Never turn adjustable wrenches so pulling force is applied to adjustable jaw. Wrench is likely to slip or break. Always turn wrench so force is received by stationary jaw.

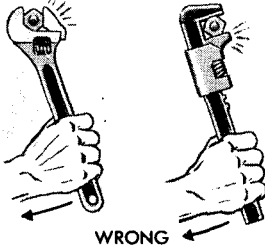

WRONG

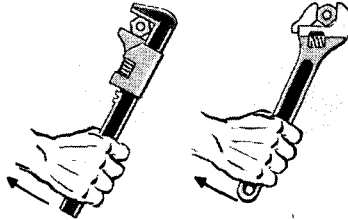

RIGHT

RA PD 87404

Do not use pipe to increase wrench leverage. Wrench may bend or break. Use longer wrench.

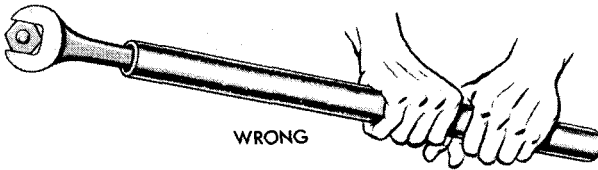

WRONG



RIGHT

RA PD 87405

Storage

Coat wrenches with rust preventive compound (thin film) and store in a dry place. Upon removal from storage, wash with dry cleaning solvent to remove rust preventive compound.

REFERENCES

PUBLICATIONS INDEXES.

The following publications indexes should be consulted frequently for latest changes or revisions of references given in this section and for new publications relating to materiel covered in this manual:

1. Ordnance supply catalog index (index to SNL's) ASF Cat.
ORD 2
2. Ordnance major items and combinations, and pertinent publications SB 9-1
3. List of publications for training (listing CCBP's, FM's, FT's, MTP's, TB's, TM's, TR's, TC's and LO's) FM 21-6
4. List of training films, film strips, and film bulletins FM 21-7
5. Military training aids (listing graphic training aids, models, devices, and displays) FM 21-8
6. List and index of administrative and supply publications (listing new AR's, Cir's, GO's, and WDP's, T/O & E's, T/O's, T/E's, T/S's, T/BA's, MR's, RR's, WDP's, SB's, MWO's, and Forms) WD Pam 12-6

STANDARD NOMENCLATURE LISTS.

1. Common Tool Lists.
 - Abrasion and compression tools (general abrasives, hand grinders, hand presses, sharpening stones, etc.) ASF Cat.
ORD 5 SNL J-1
 - Benches, tool boxes, cabinets, bins, tool chests, tool rolls, etc., of general application ASF Cat.
ORD 5 SNL J-15
 - Cutting, boring, and tweezer tools (saws, shears, planes, files, rasps, chisels, bits, reamers (hand), pliers, pincers, etc.) ASF Cat.
ORD 5 SNL J-2

REFERENCES — Contd.

- Geometrical tools and instruments (squares, compasses, rules, gages, calipers, micrometers, dividers, levels, protractors, scribes, surface plates, etc.) ASF Cat.
ORD 5 SNL J-3
- Hand tool appurtenances (file cleaners, handles, heads, tool checks, tool racks, etc.) ASF Cat.
ORD 5 SNL J-8
- Lifting, holding, and forming tools (bit braces, saw frames, vises, clamps, hoists, block and tackle, molds for castings, anvils, jacks and slings, etc.) ASF Cat.
ORD 5 SNL J-5
- Measuring and testing instruments (electrical, air, liquid, etc.) ASF Cat.
ORD 5 SNL J-9
- Miscellaneous kits and tool-sets ASF Cat.
ORD 5 SNL J-20
- Paint, spraying equipment and related items ASF Cat.
ORD 5 SNL J-14
- Percussion, digging, and wrecking tools (hammers, mallets, mauls, sledges, axes, hatchets, picks, mattocks, shovels, crowbars, pinch bars, etc.) ASF Cat.
ORD 5 SNL J-6
- Punch, drift, fastening, and scraping tools (awls, needles, punches, drifts, screwdrivers, wrenches, scrapers, riveters (hand sets), etc.) ASF Cat.
ORD 5 SNL J-4
- Small tools (twist drills, countersinks, counterbores, cutting-off tool cutters, cutters, etc.) ASF Cat.
ORD 5 SNL J-10
- Tire repair and maintenance tools and equipment ASF Cat.
ORD 5 SNL J-16
- Welding, forging, soldering and brazing equipment (blow-torches, soldering coppers, melting ladles, and welding outfits) ASF Cat.
ORD 5 SNL J-7

REFERENCES — Contd.

2. Maintenance Tool Lists.

- Tools, maintenance, for repair of pack, light and medium field artillery; and armament of these calibers for airplane and combat vehicles. ASF Cat.
ORD 6 SNL C-18
- Tools, maintenance, for repair of small and hand arms, and pyrotechnic projectors. ASF Cat.
ORD 6 SNL B-20
- Tool-sets for maintenance of antiaircraft artillery. ASF Cat.
ORD 6 SNL D-14
Section 2
- Tool-sets for maintenance of antiaircraft materiel (37-mm and 40-mm). ASF Cat.
ORD 6 SNL A-35
Section 2
- Tool-sets (common), specialists' and organizational. ASF Cat.
ORD 6 SNL G-27
Section 2
- Tool-sets for maintenance of heavy field artillery. ASF Cat.
ORD 6 SNL D-14
Section 1
- Tool-sets for maintenance of sighting and fire control equipment. ASF Cat.
ORD 6 SNL F-272
- Tool-sets for maintenance of small and intermediate caliber ground, aircraft, and antiaircraft materiel; cannon and mortars. ASF Cat.
ORD 6 SNL A-35
Section 1
- Tool-sets (special), motor vehicles. ASF Cat.
ORD 6 SNL G-27
Section 1

3. Shop Loads Tool Lists. (truck and railway)

- Car, railway, machine shop, M1 (for ordnance company, maintenance-railway artillery). ASF Cat.
ORD 7 SNL E-53

REFERENCES — Contd.

- Truck, 2½-ton, 6 x 6, small arms repair, M7,
M7A1, and M7A2..... ASF Cat.
ORD 7 SNL G-138
- Truck, 2½-ton, 6 x 6, automotive repair, M8
and M8A1..... ASF Cat.
ORD 7 SNL G-139
- Truck, 2½-ton, 6 x 6, artillery repair, M9
and M9A1..... ASF Cat.
ORD 7 SNL G-140
- Truck, 2½-ton, 6 x 6, instrument repair, M10
and M10A1..... ASF Cat.
ORD 7 SNL G-141
- Truck, 2½-ton, 6 x 6, welding, M12 and
M12A1..... ASF Cat.
ORD 7 SNL G-142
- Truck, 2½-ton, 6 x 6, tool and bench, M13. ASF Cat.
ORD 7 SNL G-143
- Truck, 2½-ton, 6 x 6, machine shop, M16,
M16A1 and M16A2..... ASF Cat.
ORD 7 SNL G-146
- Truck, 2½-ton, 6 x 6, electrical repair, M18,
M18A1, and M18A2..... ASF Cat.
ORD 7 SNL G-149
- Truck, 2½-ton, 6 x 6, instrument bench, M23 ASF Cat.
ORD 7 SNL G-178
- Truck, 2½-ton, 6 x 6, Signal Corps general
repair, M31; Truck, 2½-ton, 6 x 6, small
arms repair (Signal Corps), M7..... ASF Cat.
ORD 7 SNL G-229
- Truck, tire repair, 2½-ton, 6 x 6, M32
(Loads A and B) and Trailer, tire repair,
1-ton, 2-wheel, M25 (Loads A and B)... ASF Cat.
ORD 7 SNL G-234
- Truck, 2½-ton, 6 x 6, Signal Corps repair,
M30..... ASF Cat.
ORD 7 SNL G-235
- Ordnance maintenance sets..... ASF Cat.
ORD 6 SNL N-21
- 4. Organizational Tool Lists.**
- Special ammunition surveillance, testing,
inspection, and renovation tools and
supplies..... ASF Cat.
ORD 5 SNL P-11

REFERENCES — Contd.

- Tool-set, unit equipment, special for posts,
camps and stations..... ASF Cat.
ORD 6 SNL N-23
- Tool-sets, for ordnance service command
automotive shops..... ASF Cat.
ORD 6 SNL N-30

5. Cleaning and Preserving.

- Cleaning, preserving and lubricating materi-
als; recoil fluids, special oils, and miscel-
laneous related items..... ASF Cat.
ORD 5 SNL K-1
- Lubricating equipment, accessories and
related dispensers..... ASF Cat.
ORD 5 SNL K-3
- Soldering, brazing and welding materials,
gases and related items..... ASF Cat.
ORD 5 SNL K-2

EXPLANATORY PUBLICATIONS.

- Basic maintenance manual..... TM 37-250
- Cleaning, preserving, sealing, lubricating and
related materials issued for ordnance
materiel..... TM 9-850
- Dictionary of United States Army terms... TM 20-205
- Ordnance Maintenance: Tire repair and
retread..... TM 9-1868
- Welding, theory and application..... TM 9-2852