

TM 9-821

WAR DEPARTMENT

TECHNICAL MANUAL



**2½-TON 4 x 2 TRUCK
(FEDERAL)**

9 OCTOBER 1943



**MICROFICHE
AVAILABLE**

2½-TON 4 x 2 TRUCK

(FEDERAL)

CONTENTS

PART ONE—VEHICLE OPERATING INSTRUCTIONS

	Paragraphs	Pages
SECTION I Introduction	1	3-6
II Description and tabulated data...	2-4	7-10
III Driving controls and operation...	5-10	11-17
IV Operation under unusual conditions	11-13	18-24
V First echelon preventive maintenance service	14-18	25-34
VI Lubrication	19-20	35-44
VII Tools and equipment stowage on the vehicle	21-22	45-46

PART TWO—VEHICLE MAINTENANCE INSTRUCTIONS

VIII Maintenance allocation	23-24	47-54
IX Second echelon preventive maintenance	25	55-72
X Organization tools and equipment.	26	73
XI Trouble shooting	27-46	74-88
XII Engine—description, data, maintenance, and adjustment in vehicle	47-59	89-100
XIII Engine removal and installation..	60-61	101-103
XIV Clutch	62-65	104-110
XV Fuel system	66-73	111-120
XVI Intake and exhaust systems.....	74-76	121-124
XVII Cooling system	77-82	125-137
XVIII Ignition system	83-91	138-152
XIX Starting and generating systems...	92-96	153-158

2½-TON 4 x 2 TRUCK (FEDERAL)

		Paragraphs	Pages
SECTION XX	Transmission	97-99	159-162
XXI	Propeller shaft	100-102	163-165
XXII	Front axle	103-112	166-172
XXIII	Rear axle	113-117	173-176
XXIV	Brake system	118-135	177-198
XXV	Wheels, hubs, and wheel bearings	136-143	199-209
XXVI	Springs and shock absorbers.....	144-152	210-215
XXVII	Steering gear	153-160	216-219
XXVIII	Body and frame	161-172	220-225
XXIX	Hoist	173-178	226-235
XXX	Battery and lighting system	179-187	236-246
XXXI	Instruments, gages, and switches.	188-199	247-252
XXXII	Power take-off	200-204	253-254
XXXIII	Shipment and temporary storage.	205-207	255-259
REFERENCES		260-261
INDEX		262

PART ONE—VEHICLE OPERATING INSTRUCTIONS**Section I****INTRODUCTION**

	Paragraph
Scope	1

1. SCOPE.

a. This technical manual* is published for the information and guidance of the using arms personnel charged with the operation, maintenance, and minor repair of this materiel.

b. In addition to a description of 2½-ton 4 x 2 truck (Federal) this manual contains technical information required for the identification, use, and care of the materiel. The manual is divided into two parts. Part One, section I through section VII, gives vehicle operating instructions. Part Two, section VIII through section XXXIII, gives vehicle maintenance instructions to using arms personnel charged with the responsibility of doing maintenance work within their jurisdiction.

c. In all cases where the nature of the repair, modifications, or adjustment is beyond the scope or facilities of the unit, the responsible ordnance service should be informed so that trained personnel with suitable tools and equipment may be provided, or proper instructions issued.

*To provide operating instructions with the materiel, this technical manual has been published in advance of complete technical review. Any errors or omissions will be corrected by changes or, if extensive, by an early revision.

2½-TON 4 x 2 TRUCK (FEDERAL)

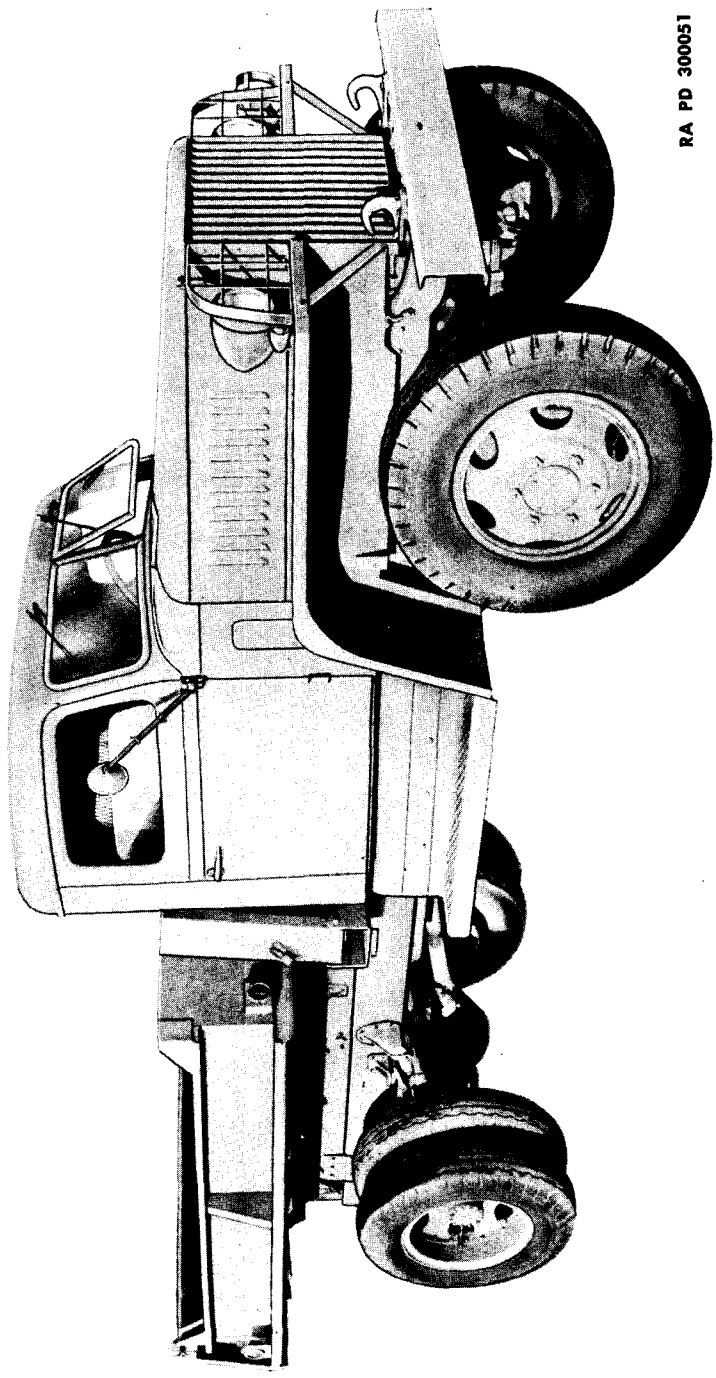

RA PD 300051

Figure 1—2½-Ton 4 x 2 Truck (Right-side View)

INTRODUCTION

RA PD 300102

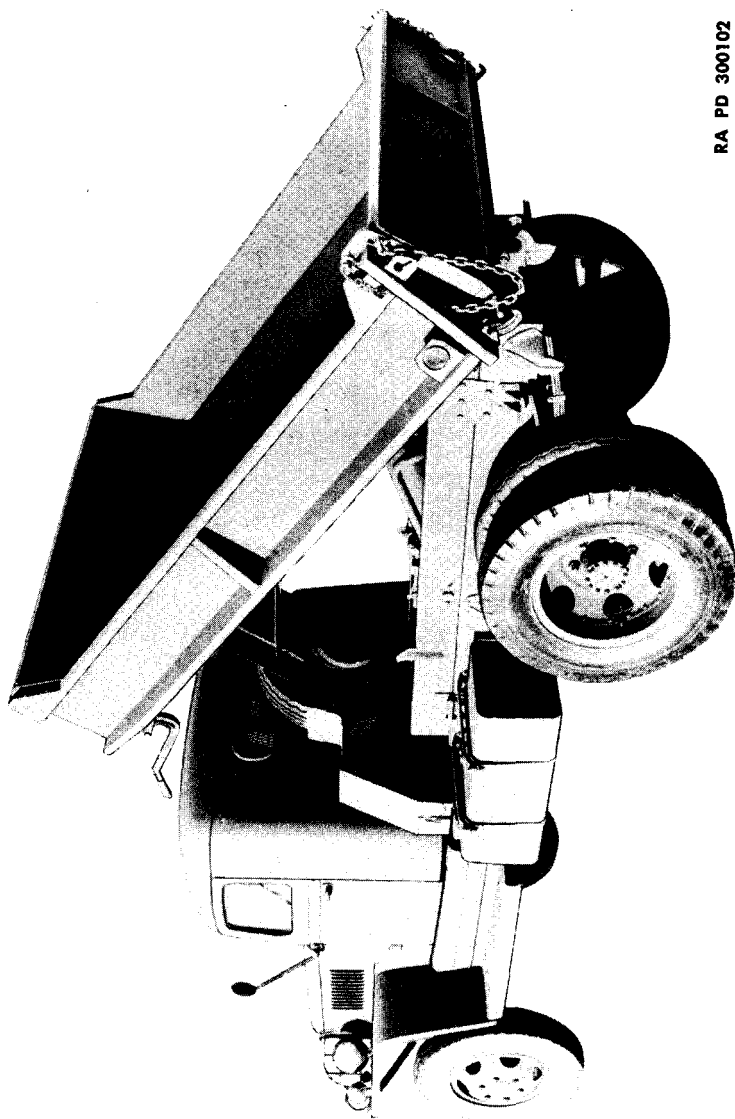
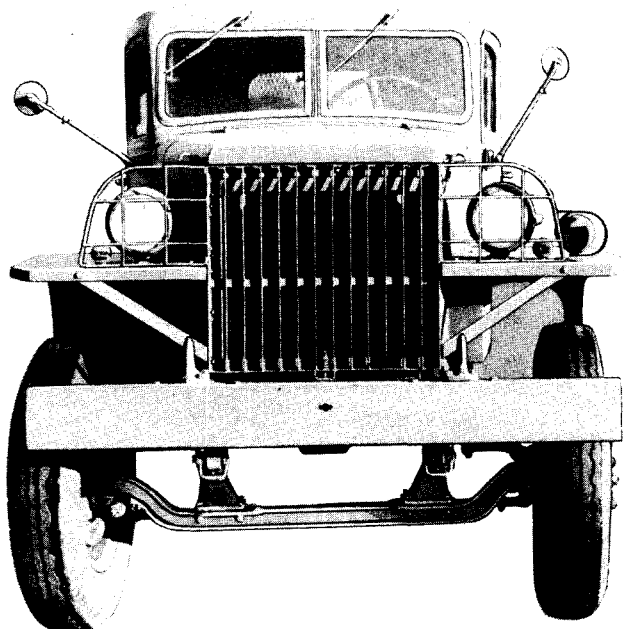

Figure 2—2½-Ton 4 x 2 Truck (Left-side View)

2½-TON 4 x 2 TRUCK (FEDERAL)



RA PD 300103

Figure 3—2½-Ton 4 x 2 Truck (Front View)

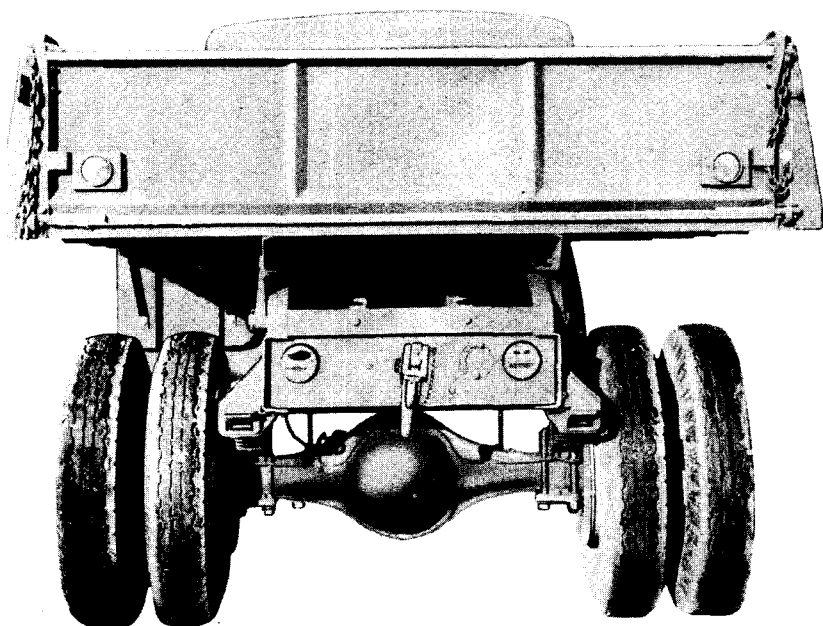

RA PD 300104

Figure 4—2½-Ton 4 x 2 Truck (Rear View)

Section II

DESCRIPTION AND TABULATED DATA

	Paragraph
Description	2
Differences among models	3
Data	4

2. DESCRIPTION.

a. The truck described in this manual is designed for transporting and unloading sand, gravel, coal, and such commodities peculiar to its bulk cargo handling features. The vehicle is equipped with hydraulically operated metal dump body. It is identified by the two driving wheels, the conventional cab, and the conventional dump body of 2-cubic-yard capacity. The identification plate showing the nomenclature, model, and payload ratings, and the publication plate showing the TM number of the technical manuals and the parts lists is mounted on the left-hand riser of the driver's seat.

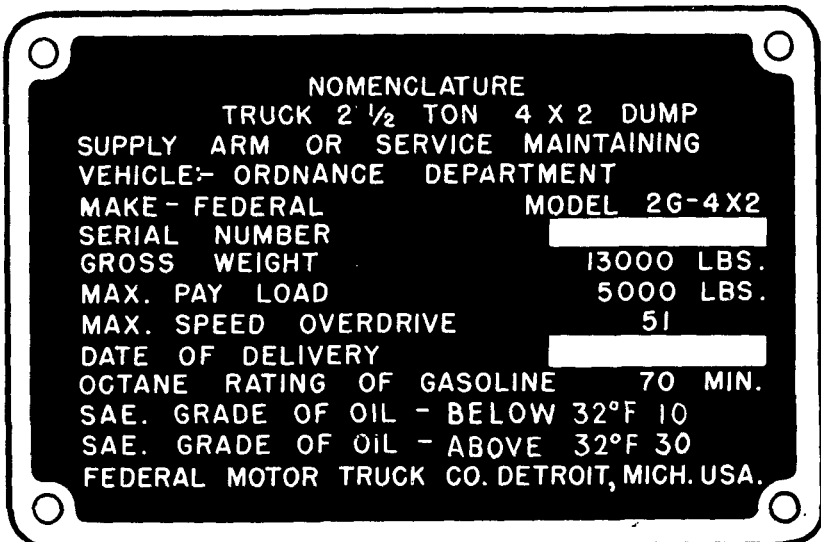

RA PD 300105

Figure 5—Identification Plate**3. DIFFERENCES AMONG MODELS.**

a. **Dump Bodies.** This truck is equipped with two types of all-steel welded dump bodies of 2-cubic-yard capacity, each mounted on an all-steel subframe assembly. These two body types are known as Anthony and Galion and are described and illustrated in detail under their respective headings (par. 173-178).

2½-TON 4 x 2 TRUCK (FEDERAL)

(1) **ANTHONY BODY.** This type of body is attached to subframe by means of two forged sections welded to the body frame. Pivot action is obtained by two large hinge pins fitted at the rear corners of the subframe.

(2) **GALION BODY.** This type of body is attached to the subframe by means of two heavy hinge brackets that bolt to body side and pivot on a cross bar fitted in the subframe.

4. DATA.

a. Vehicle Specifications.

Nominal wheel base	151 in.
Length, over-all	217½ in.
Width, over-all	90 in.
Height, over-all	dump body up, 120 in. dump body down, 89 in.
Wheel size	20 x 7 in.
Tire size	8.25 in. x 20 in.
Tire type	Highway
Tread (center to center)	front, 63 ⁵ / ₁₆ in. rear, 65 ¹³ / ₁₆ in.
Crew	2 men
Weight of vehicle—empty	7,251 lb
Weight of vehicle—loaded	12,975 lb
Ground pressure	57 psi
Ground contact	228 sq
Ground clearance	10 in.
Pintle height	31 in.
Kind of fuel	70 octane

b. Performance.

First speed	6 mph
Second speed	12 mph
Third speed	23 mph
Fourth speed direct	41 mph
Fifth speed overdrive	51 mph
Reverse speed	6 mph
Maximum governed speed	51 mph
Approach angle	61½ degrees
Departure angle	45 degrees
Minimum turning radius (left)	25 ft
(right)	25 ft
Fording depth	24 in.
Towing facilities (front)	Tow hooks
(rear)	Pintle hook
Maximum draw-bar pull (direct drive)	875 lb

DESCRIPTION AND TABULATED DATA

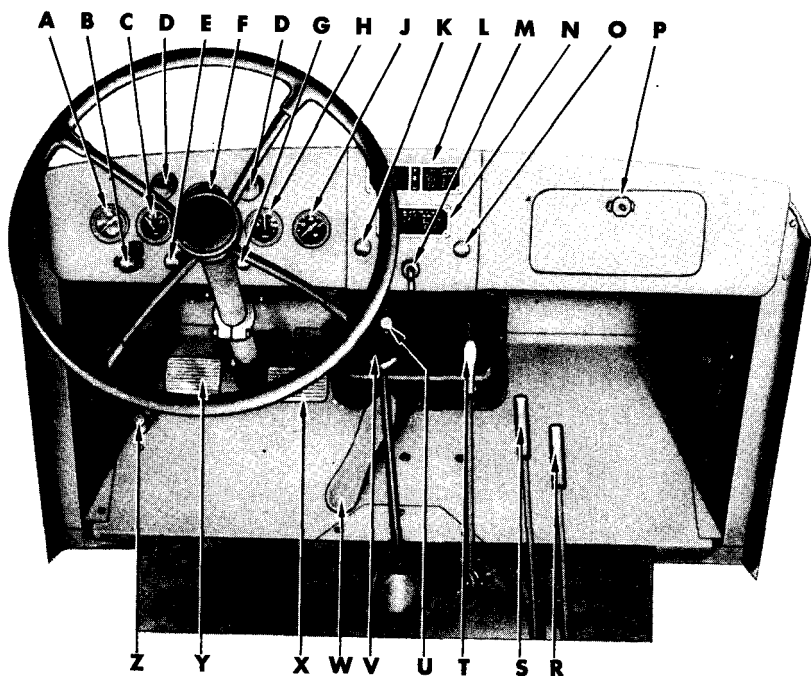

- | | |
|---------------------------------|----------------------------|
| A—TEMPERATURE GAGE | N—CAUTION PLATE |
| B—MAIN LIGHT SWITCH | O—THROTTLE |
| C—FUEL GAGE | P—GLOVE COMPARTMENT |
| D—PANEL LIGHT | R—HOIST CONTROL LEVER |
| E—BLACKOUT DRIVING LIGHT SWITCH | S—POWER TAKE-OFF LEVER |
| F—SPEEDOMETER | T—HAND BRAKE LEVER |
| G—PANEL LIGHT SWITCH | U—CRANKING MOTOR SWITCH |
| H—AMMETER | V—TRANSMISSION SHIFT LEVER |
| J—OIL PRESSURE GAGE | W—ACCELERATOR |
| K—CHOKE | X—BRAKE PEDAL |
| L—SHIFTING DIAGRAM | Y—CLUTCH PEDAL |
| M—IGNITION SWITCH | Z—DIMMER SWITCH |

RA PD 300052

Figure 6—Controls and Instruments

2½-TON 4 x 2 TRUCK (FEDERAL)

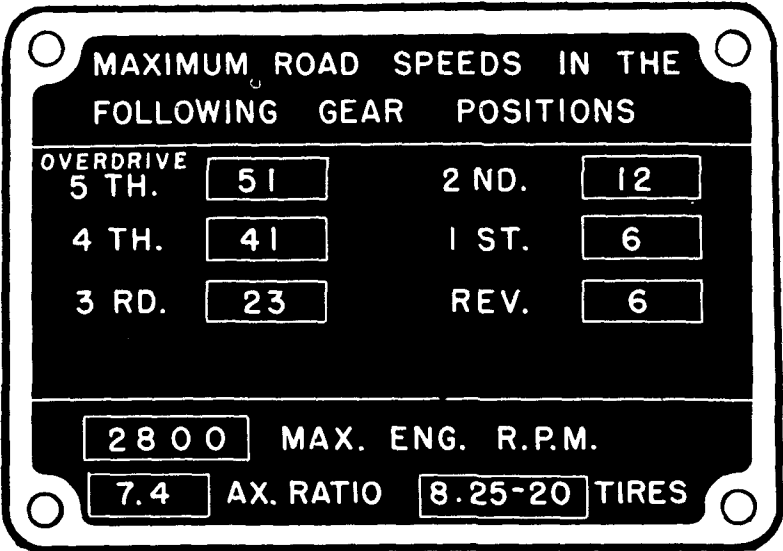

RA PD 300054

Figure 7—Caution Plates

Maximum grade ascending ability (low gear)	45 degrees
Maximum grade descending ability	45 degrees
Cruising range without refueling	
(average road at 30 mph)	12,975 gross weight, 250 miles
Miles per gallon (at 30 mph)	6.25

c. Capacities.

Transmission	14 pt	
Rear axle capacity	15 pt	
Fuel tank capacity	40 gal	
Cooling system	22 qt	
Crankcase capacity	6 qt—dry, 8 qt	
Oil bath air cleaner—carburetor	1 qt	
Oil bath air cleaner—crankcase breather	1/20 pt	
Hoist cylinder	Galion body	13 qt
	Anthony body	12 pt

Section III

DRIVING CONTROLS AND OPERATION

	Paragraph
Controls	5
Instruments	6
Operation of vehicle	7
Anthony dump body operation.....	8
Galion dump body operation.....	9
Towing the vehicle	10

5. CONTROLS.

a. **Oil Supply.** Oil crankcase filler cap is located on left-hand side of the engine near the oil filter. The dip stick is located to the rear of the filler cap, and is graduated to show the depth of the oil in the crankcase. Dip stick should be removed, wiped clean with rag, reinserted and withdrawn, to obtain correct level reading. Dip stick should show between $\frac{3}{4}$ -full and full before engine is operated. This operation can be correctly performed only when the engine is not running.

b. **Gas Supply.** There is no shut-off cock in the fuel line on this vehicle. If fuel gage is inoperative, fuel level may be determined by inserting a clean wooden stick through the gas tank filler hole, and noting the depth indicated when stick is withdrawn.

c. **Water Supply.** It is essential that sufficient coolant, water, or antifreeze compound be in the cooling system at all times. Radiator filler cap is accessible when the engine hood is raised. Caution should be exercised to avoid escaping steam, if engine is overheated.

d. **Accelerator Pedal.** This pedal is located on the floor board, to the extreme right of the pedal cluster. Its purpose is to control the engine and vehicle speed under normal circumstances.

e. **Blackout Driving Light Switch.** This switch is located on the instrument panel to the left of the steering column, and is pulled out to operate the individual blackout driving headlight which is mounted on the left front fender.

f. **Brake Lever.** This lever extends through the floor board to the driver's right side, and to the right of the transmission shift lever. It controls the emergency or parking brake. Pull lever back to set brake, push lever forward to release brake.

g. **Brake Pedal.** This is the right-hand pedal readily accessible to driver's right foot. When pedal is pressed down, it controls application and release of vacuum hydraulic-operated service brake shoes at each wheel.

h. **Choke Control.** This button reduces the amount of air admitted to the engine, and gives a richer, more powerful mixture. It is

2½-TON 4 x 2 TRUCK (FEDERAL)

pulled out when starting engine, and pushed in when engine is warm and running smoothly.

i. Clutch Pedal. This pedal is located to the left of the steering column. When pressed down, it disengages clutch, disconnects power from engine to transmission, and permits the operator to shift transmission and power take-off levers as required. Do not disengage clutch except when necessary. Do not use clutch pedal for a foot rest when driving.

j. Dimmer Switch. This switch is foot-operated, located on toe-board to left of clutch pedal, and permits operator to change driving lights from high to low beam or vice versa.

k. Hoist Lever. This lever, the extreme right-hand lever in the cab, controls the valve on the hydraulic cylinder which operates the dump body. It has three positions: for lowering body, for holding body, and for raising body (fig. 8).

l. Ignition Switch. Located at the center of the instrument panel, this switch is of the lever type, and must be turned to "ON" position before engine will start. Do not allow switch to remain in "ON" position while engine is not running, unless making necessary tests.

m. Main Light Switch. Located at extreme left on instrument panel, this switch is pulled out to turn on blackout lights. To obtain service and headlights, press release button on left and pull switch to second position. For operation in daylight, press release button and pull switch to third position. This permits the stop light to operate when brake pedal is depressed.

n. Panel Light Switch. Located on instrument panel to right of steering column, this switch provides an auxiliary control for instrument lights and is operative only when main light switch is in second position.

o. Power Take-off Lever. Located second lever from right on floor board, it engages power take-off with transmission to provide power for hydraulic pump. It has two positions—forward for "dis-engage," and back for "engage."

p. Cranking Motor Switch. Foot-operated type switch is located above accelerator pedal on engine cover. Press firmly with foot to operate cranking motor. Release immediately when engine starts.

q. Tail Gate Release Lever. Lever is located at the forward left corner of the dump body. It is held in the closed position by a ring and chain. To open tail gate, remove ring from lever shaft and throw lever downward. To lock, pull lever up to top position and secure with ring.

r. Transmission Shift Lever. Located on driver's right, lever is used to select proper gear ratios in the transmission for providing power or speed as required. The position of this lever does not affect the operation of the hoist.

DRIVING CONTROLS AND OPERATION

s. **Throttle Button.** Located on instrument panel to the right of the ignition switch, this button is used to increase or decrease the engine speed; it is usually pulled out about $\frac{1}{2}$ inch when starting, and can be used if necessary as a manual speed-control when driving.

t. **Windshield Wiper Control.** This valve-type control is located above the windshield on the windshield wiper body, and is used to control and regulate the speed of the windshield wiper arm.

6. INSTRUMENTS.

a. **Ammeter.** This instrument indicates rate of flow of electric current being supplied from generator to battery, or rate of discharge from the battery. When engine exceeds idling speed, generator charges the battery if necessary, and needle shows on positive (+) side. At slower speeds, or when all lights are on, needle will show on negative (—) side.

b. **Fuel Gage.** This instrument shows amount of fuel in tank, only when ignition switch is turned on.

c. **Oil Gage.** This instrument indicates engine oil pressure continuously when engine is running. This gage should indicate approximately 26 pounds at average engine speed. If pressure falls, stop engine at once until cause can be determined.

d. **Speedometer.** This instrument indicates vehicle road speed in miles per hour.

e. **Temperature Gage.** This instrument indicates temperature of water in engine cooling system in degrees Fahrenheit. It may vary widely under different operating conditions, but must never be allowed to exceed 212°F. Continuous operation at any temperature over 200°F will result in serious damage to the engine. If excessive temperatures are shown, determine cause and correct.

7. OPERATION OF VEHICLE.

a. Starting the Engine.

(1) **BEFORE-OPERATION INSPECTION.** Perform the inspections described in paragraph 15 before proceeding with the following:

(2) **APPLY BRAKE LEVER.** Pull hand brake lever back and leave secure in applied position.

(3) **MOVE SHIFT LEVER TO NEUTRAL.** Move transmission shift lever to neutral position (fig. 8, Shifting Diagram). At this point lever should move freely from right to left without effort.

(4) **SET THROTTLE CONTROL.** Pull throttle control button out about $\frac{1}{2}$ inch.

(5) **SET CHOKE CONTROL.** Pull choke control button out about half way. This may not be sufficient in cold weather, and will probably be too much in hot weather.

2½-TON 4 x 2 TRUCK (FEDERAL)

(6) **TURN IGNITION SWITCH.** Turn ignition switch lever to "ON" position.

(7) **DEPRESS CLUTCH PEDAL.** Push down clutch pedal and hold down until engine starts. This is very important in cold weather.

(8) **PRESS STARTING SWITCH.** Press firmly on cranking motor switch until engine starts. This switch should not be engaged for longer intervals than 10 or 15 seconds.

(9) **ADJUST THROTTLE.** Push in throttle button until engine runs smoothly at a moderate speed. Use foot throttle (called accelerator) to speed up if engine shows signs of dying.

(10) **RELEASE CLUTCH PEDAL.**

(11) **PUSH IN CHOKE CONTROL.** Push in choke button when engine is running smoothly and temperature gage indicates favorable operating temperature.

(12) **RUNNING CHECK.** Note readings on ammeter, temperature gage, and oil pressure gage to be certain that engine and accessories are functioning properly.

b. Driving the Vehicle.

(1) **WARM-UP.** Always allow the engine to run for an initial warm-up period, which will not be completed until the temperature gage indicates normal engine temperature (160° to 180°F), oil pressure gage shows between 20 and 30 pounds, and ammeter shows a slight positive (+) charge.

(2) **SELECT FORWARD TRANSMISSION SPEEDS—LOW TO HIGH.** Push down clutch pedal and move transmission shift lever to the right against the spring and back, in order to select first speed, or low gear (fig. 8). Gradually speed up engine with accelerator, releasing clutch pedal at the same time, and release hand brake lever. As soon as the vehicle is moving forward smoothly, slow down the engine, depress the clutch pedal, and shift transmission shift lever through neutral to second speed position, which is extreme left and forward (fig. 8). Release clutch pedal gradually and speed up the engine. Repeat operation. Follow positions shown on shifting diagram (fig. 8) until in fourth speed. This is the normal operating speed under usual road conditions. Fifth speed or overdrive is reserved for open roads at high speed.

(3) **SELECT FORWARD TRANSMISSION SPEEDS—HIGH TO LOW.** Drivers should devote extra time to practice on this operation, as it is often the only way the vehicle can be kept under control in an emergency and brought to a stop. This operation requires careful attention if it is to be successfully accomplished without damage to the vehicle. Transmission should always be shifted to lower speeds when engine starts to "lug" or "labor." Push down clutch pedal; decelerate

DRIVING CONTROLS AND OPERATION

engine by decreasing pressure on accelerator pedal and shift transmission to neutral. Release clutch pedal; accelerate engine to synchronize engine speed in second gear position with vehicle speed. Push down clutch pedal and shift transmission lever into second gear position, then accelerate engine and gradually release clutch pedal. Use the same procedure as outlined above to shift from second to first speed position. **CAUTION:** *If difficulty is experienced, bring vehicle to complete stop (step c below).*

(4) **SELECT REVERSE TRANSMISSION SPEED.** Bring vehicle to a complete stop (step c following). Depress clutch pedal and move transmission shift lever to reverse position, which is all the way to the right and forward. Gradually speed up engine and release clutch pedal.

c. Stopping the Vehicle.

(1) **STOPPING FROM HIGH SPEED.** Remove foot from accelerator pedal. Gently apply pressure to brake pedal until engine decelerates

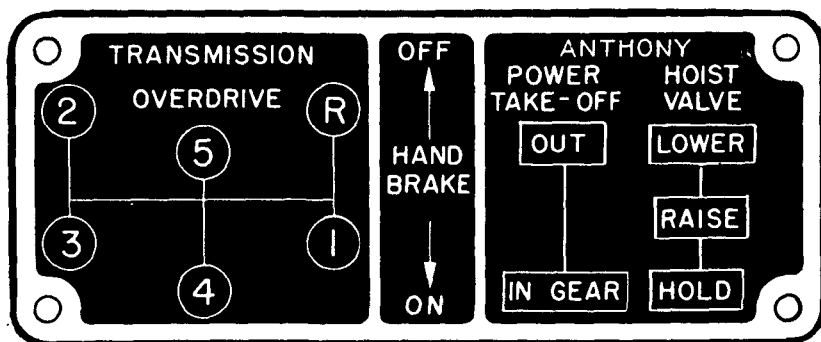

(Anthony)

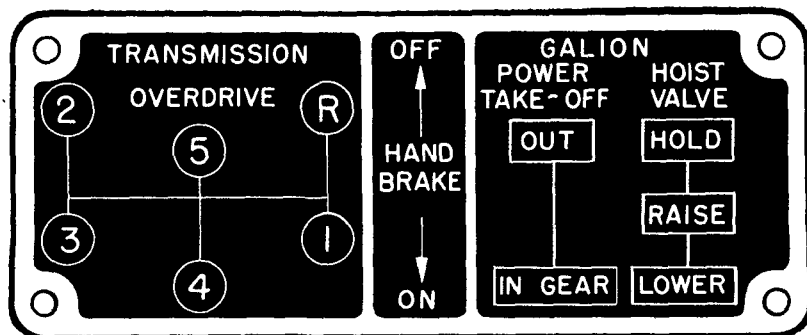

(Galion)

RA PD 300053

Figure 8—Shifting Diagram

2½-TON 4 x 2 TRUCK (FEDERAL)

to idling speed; then depress clutch pedal and move transmission shift lever to neutral position. Continue to apply pressure to brake pedal until vehicle comes to a complete stop. Set hand brake; turn off lights.

(2) **STOPPING FROM LOW SPEED.** Depress clutch pedal. Remove foot from accelerator pedal until engine reaches idling speed; then move transmission shift lever to neutral position. Apply pressure to brake pedal until vehicle comes to a complete stop. Set hand brake; turn off lights.

d. Stopping the Engine.

(1) If temperature gage shows between 160°F and 180°F, and truck has been operating at medium and light loads, allow engine to idle momentarily at normal speed before shutting off ignition switch.

(2) If engine temperature gage shows higher than 180°F, or if truck has been operated for a long period under heavy load, allow engine to idle at about twice normal idle speed for 5 minutes before shutting off ignition switch.

8. ANTHONY DUMP BODY OPERATION (fig. 8).

a. **To Raise Body.** If cargo is to be dumped, raise tail gate lever. Place hoist valve operating lever in extreme rear "HOLD" position. Depress clutch pedal, disengaging clutch. Pull back power take-off lever to "IN GEAR" position and release clutch pedal. Move hoist valve operating lever forward to "RAISE" position and at the same time accelerate engine to raise load to desired height. Do not race engine. When load has reached desired height, pull valve-operating lever back to "HOLD" position while dumping load. Load may be held at any desired intermittent height by moving operating valve lever backward to "HOLD" position during the raising operation.

b. **To Lower Body.** Depress clutch pedal disengaging clutch. Move power take-off lever forward to "OUT" position. Move hoist operating valve lever forward through "RAISE" position to "LOWER" position until desired lowering speed is attained. Bring body gently to rest on subframe by carefully manipulating valve lever between "LOWER" and "RAISE" positions. With body at rest on subframe, move hoist operating valve lever forward to "HOLD" position. Swing tail gate to closed position and lock tail gate lever.

9. GALION DUMP BODY OPERATION (fig. 8).

a. **To Raise Body.** If cargo is to be dumped, release tail gate lever. Place hoist valve operating lever in extreme forward "HOLD" position. Depress clutch pedal disengaging clutch. Pull power take-off lever backward to "IN GEAR" position and release clutch pedal. Pull hoist valve operating lever back to "RAISE" position and at the same time accelerate engine sufficiently to raise load to desired height. Do not race the engine. When load has reached desired height, push operating lever forward to "HOLD" position while dumping load. Position load

DRIVING CONTROLS AND OPERATION

at any desired intermittent height by moving operating valve lever forward into "HOLD" position during the raising operation.

b. **To Lower the Body.** Depress clutch pedal disengaging clutch. Move power take-off lever forward to "OUT" position. Move hoist operating valve lever back through "RAISE" position to "LOWER" position until desired lowering speed is attained. Bring body gently to rest on the subframe by careful manipulation of valve operating lever between "LOWER" and "RAISE" positions. With body at rest on subframe, move hoist operating valve lever forward to "HOLD" position. Swing tail gate to closed position and lock tail gate lever.

10. TOWING THE VEHICLE.

a. **Towing to Start Engine.** When engine fails to start after normal starting procedure has been followed, tow the truck to start the engine rather than completely run down the battery. When it becomes necessary to tow truck to start the engine, proceed as follows:

(1) Tie both trucks together with short length of chain or cable from the pintle hook of tow truck to towing hooks of towed truck.

(2) In truck to be started, depress clutch, shift transmission into high gear, turn on ignition switch, and set choke control as in conventional starting.

(3) Start towing truck, and after momentum has been obtained, release clutch in towed truck, gradually causing engine to spin.

(4) If engine fails to start immediately, manipulate choke and throttle controls as in conventional starting. If engine still fails to start, investigate cause.

b. **Towing Disabled Vehicle.** Particular care must be exercised when towing damaged vehicle to repair base to be sure that no additional damage occurs while vehicle is being towed.

(1) **TOWING VEHICLE WITH ALL WHEELS ON GROUND.** If rear axle and transmission are not damaged, truck may be towed with all four wheels on the ground by shifting transmission into neutral.

(2) **TOWING VEHICLE WITH REAR WHEELS OFF GROUND.** If rear axle and transmission are damaged, truck may be towed with front wheels only on the ground by lashing steering wheel in straight ahead position.

(3) **TOWING VEHICLE WITH FRONT WHEELS OFF GROUND.** If front end is damaged, truck may be towed with front wheels off ground. Shift transmission into neutral, or if transmission is damaged, disconnect propeller shaft.

2½-TON 4 x 2 TRUCK (FEDERAL)**Section IV****OPERATION UNDER UNUSUAL CONDITIONS**

	Paragraph
Cold weather operation	11
Hot weather operation	12
Mud, sand, snow, ice, flood, and poisonous gas.....	13

11. COLD WEATHER OPERATION.

a. **Purpose.** Operation of automotive equipment at subzero temperatures presents problems that demand special precautions and extra careful servicing from both operation and maintenance personnel, if poor performance and total functional failure are to be avoided.

b. **Gasoline.** Winter grade of gasoline is designed to reduce cold weather starting difficulties; therefore the winter grade motor fuel should be used in cold weather operation.

c. **Storage and Handling of Gasoline.** Due to condensation of moisture from the air, water will accumulate in tanks, drums, and containers. At low temperatures, this water will form ice crystals that will clog fuel lines and carburetor jets unless the following precautions are taken:

(1) Strain the fuel through filter paper, or any other type of strainer that will prevent the passage of water. **CAUTION:** *Gasoline flowing over a surface generates static electricity that will result in a spark, unless means are provided to ground the electricity. Always provide a metallic contact between the container and the tank, to assure an effective ground.*

(2) Keep tank full, if possible. The more fuel there is in the tank, the smaller will be the volume of air from which moisture can be condensed.

(3) Add ½ pint of denatured alcohol, grade 3, to the fuel tank each time it is filled. This will reduce the hazard of ice formation in the fuel.

(4) Be sure that all containers are thoroughly clean and free from rust before storing fuel in them.

(5) If possible, after filling or moving a container, allow the fuel to settle before filling fuel tank from it.

(6) Keep all closures of containers tight to prevent snow, ice, dirt, and other foreign matter from entering.

(7) Wipe all snow or ice from dispensing equipment and from around fuel tank filler cap before removing cap to refuel vehicle.

d. Lubrication.

(1) **TRANSMISSION AND DIFFERENTIAL.**

(a) Universal gear lubricant, SAE 80, where specified on figure 10

OPERATION UNDER UNUSUAL CONDITIONS

or War Department Lubrication Guide, is suitable for use at temperatures as low as -20°F . If consistent temperature below 0°F is anticipated, drain the gear cases while warm and refill with Grade 75 universal gear lubricant, which is suitable for operation at all temperatures below 0°F . If Grade 75 universal gear lubricant is not available, SAE 80 universal gear lubricant diluted with the fuel used by the engine, in the proportion of one part fuel to six parts universal gear lubricant, may be used. Dilute make-up oil in the same proportion before it is added to gear cases.

(b) After engine has been warmed up, engage clutch and maintain engine speed at fast idle for 5 minutes, or until gears can be engaged. Put transmission in low (first) gear, and drive vehicle for 100 yards, being careful not to stall engine. This will heat gear lubricants to the point where normal operation can be expected.

(2) CHASSIS POINTS. Lubricate chassis points with general purpose grease, No. 0.

(3) HYDROVAC CYLINDERS. Lubricate hydrovac cylinders with hydraulic oil above -20°F , and special recoil oil, or light shock absorber fluid below -20°F .

(4) STEERING GEAR HOUSING. Drain housing, if possible, or use suction gun to remove as much lubricant as possible. Refill with universal gear lubricant, Grade 75, or, if not available, SAE 80 universal gear lubricant diluted with fuel used in the engine, in the proportion of one part fuel to six parts SAE 80 universal gear lubricant. Dilute make-up oil in the same proportion before it is added to the housing.

(5) OILCAN POINTS. For oilcan points where engine oil is prescribed for above 0°F , use light lubricating, preservative oil.

e. Protection of Cooling Systems.

(1) USE ANTIFREEZE COMPOUND. Protect the system with antifreeze compound (ethylene-glycol type) for operation below $+32^{\circ}\text{F}$. The following instructions apply to use of new antifreeze compound.

(2) CLEAN COOLING SYSTEM. Before adding antifreeze compound, clean the cooling system, and completely free it from rust. If the cooling system has been cleaned recently, it may be necessary only to drain, refill with clean water, and again drain. Otherwise the system will be cleaned with cleaning compound.

(3) REPAIR LEAKS. Inspect all hoses and replace if deteriorated. Inspect all hose clamps, plugs, and pet cocks and tighten if necessary. Repair all radiator leaks before adding antifreeze compound. Correct all leakage of exhaust gas or air into the cooling system.

(4) ADD ANTIFREEZE COMPOUND. When the cooling system is clean and tight, fill the system with water to about $\frac{1}{3}$ capacity. Then add antifreeze compound, using the proportion of antifreeze compound to the cooling system capacity indicated below. Protect the system to at least 10°F below the lowest temperature expected to be experienced during the winter season.

2½-TON 4 x 2 TRUCK (FEDERAL)**ANTIFREEZE COMPOUND CHART**
(for 22-quart capacity cooling system)

Temperature	Antifreeze Compound (ethylene-glycol type)
+10°F	5.5 qt
0°F	6.9 qt
-10°F	8.3 qt
-20°F	9.6 qt
-30°F	11 qt
-40°F	12.9 qt
-50°F	13.8 qt

(5) **WARM THE ENGINE.** After adding antifreeze compound, fill with water to slightly below the filler neck; then start and warm the engine to normal operating temperature.

(6) **TEST STRENGTH OF SOLUTION.** Stop the engine and check the solution with a hydrometer, adding antifreeze compound if required.

(7) **INSPECT WEEKLY.** In service, inspect the coolant weekly for strength and color. If rusty, drain and clean cooling system thoroughly and add new solution of the required strength.

(8) **CAUTIONS.**

(a) *Antifreeze compound is the only antifreeze material authorized for ordnance material.*

(b) *It is essential that antifreeze solutions be kept clean. Use only containers and water that are free from dirt, rust, and oil.*

(c) *Use an accurate hydrometer. To test a hydrometer, use one part antifreeze compound to two parts water. This solution will produce a hydrometer reading of 0°F.*

(d) *Do not spill antifreeze compound on painted surfaces.*

f. Electrical Systems.

(1) **GENERATOR AND STARTER.** Check the brushes, commutators, and bearings. See that the commutators are clean. The large surges of current which occur when starting a cold engine require good contact between brushes and commutators.

(2) **WIRING.** Check, clean, and tighten all connections, especially the battery terminals. Care should be taken that no short circuits are present.

(3) **COIL.** Check coil for proper functioning by noting quality of spark.

(4) **DISTRIBUTOR.** Clean thoroughly, and clean or replace points. Check the points frequently. In cold weather, slightly pitted points may prevent engine from starting.

(5) **SPARK PLUGS.** Clean and adjust or replace, if necessary. If it is difficult to make the engine fire, reduce the gap to 0.005 inch less than that recommended for normal operation (par. 88). This will make ignition more effective at reduced voltages likely to prevail.

OPERATION UNDER UNUSUAL CONDITIONS

(6) **TIMING.** Check carefully. Care should be taken that the spark is not unduly advanced nor retarded.

(7) **BATTERY.**

(a) The efficiency of batteries decreases sharply with decreasing temperatures, and becomes practically nil at -40°F . Do not try to start the engine with the battery when it has been chilled to temperatures below -30°F until battery has been heated, unless a warm slave battery is available. See that the battery is always fully charged, with the hydrometer reading between 1.275 and 1.300. A fully charged bat-

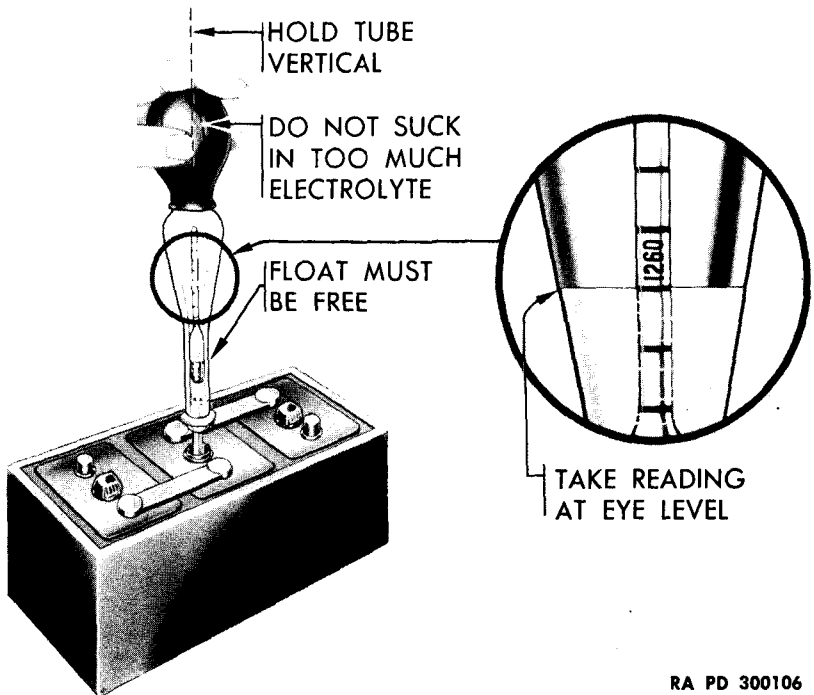

RA PD 300106

Figure 9—Testing Battery Solution

tery will not freeze at temperatures likely to be encountered even in Arctic climates, but a fully discharged battery will freeze and rupture at $+5^{\circ}\text{F}$.

(b) Do not add water to a battery when it has been exposed to subzero temperatures unless the battery is to be charged immediately. If water is added and the battery not put on charge, the layer of water will stay at the top and freeze before it has a chance to mix with the acid.

(8) **LIGHTS.** Inspect the lights carefully. Check for short circuits and presence of moisture around sockets.

2½-TON 4 x 2 TRUCK (FEDERAL)

(9) **ICE.** Before every start, see that the spark plugs, wiring, or other electrical equipment are free from ice.

g. Starting and Operating Engine.

(1) **INSPECT STARTER MECHANISM.** Be sure that no heavy grease or dirt has been left on the starter throwout mechanism. Heavy grease or dirt is liable to keep the gears from being meshed, or cause them to remain in mesh after the engine starts running. The latter will ruin the starter and necessitate repairs.

(2) **USE OF CHOKE.** A full choke is necessary to secure the rich air-fuel mixture required for cold weather starting. Check the butterfly valve to see that it closes all the way and otherwise functions properly.

(3) **CARBURETOR AND FUEL PUMP.** The carburetor, which will give no appreciable trouble at normal temperatures, is liable not to operate satisfactorily at low temperatures. Be sure the fuel pump has no leaky valves or diaphragm as this will prevent the fuel pump from delivering the amount of fuel required to start the engine at low temperatures when turning speeds are reduced to 30 to 60 revolutions per minute.

(4) **AIR CLEANERS.** At temperatures below 0°F do not use oil in air cleaners. The oil will congeal and prevent the easy flow of air. Wash screens in dry-cleaning solvent, dry, and replace. Ice and frost formations on the air cleaner screens can cause an abnormally high intake vacuum in the carburetor air horn hose, resulting in collapse.

(5) **FUEL SYSTEM.** Remove and clean sediment bulb, strainers, etc., daily. Also drain fuel tank sump daily to remove water and dirt.

h. Chassis.

(1) **BRAKE BANDS.** Brake bands, particularly on new vehicles, have a tendency to bind when they are very cold. Always have a blow torch handy to warm up these parts, if they bind prior to moving, or attempting to move, the vehicle. Parking the vehicle with the brake released will eliminate most of the binding. Precaution must be taken, under these circumstances, to block the wheels or otherwise prevent movement of the vehicle.

(2) **EFFECT OF LOW TEMPERATURES ON METALS.** Inspect the vehicle frequently. Shock resistance of metals, or resistance against breaking, is greatly reduced at extremely low temperatures. Operation of vehicles on hard, frozen ground causes strain and jolting which will result in screws breaking, or nuts jarring loose.

(3) **SPEEDOMETER CABLE.** Disconnect the oil-lubricated speedometer cable at the drive end when operating the vehicle at temperatures of -30°F and below. The cable will often fail to work properly at these temperatures, and sometimes will break, due to the excessive drag caused by the high viscosity of the oil with which it is lubricated.

OPERATION UNDER UNUSUAL CONDITIONS**12. HOT WEATHER OPERATION.**

a. **General.** Operation of these vehicles in high temperatures requires regular maintenance of cooling units, lubrication-filtering devices, and air cleaners. In extremely high temperatures, water-saving devices such as surge or overflow tanks should be employed.

b. **Cooling System Maintenance.**

(1) **COOLING LIQUID.** Formation of scale and rust in cooling system occurs more often during operation in extremely high temperatures; therefore rust preventives should always be added to the cooling liquids (par. 77). Use only clean water. Avoid the use of water that contains alkali or other substances which may cause scale and rust formations.

(2) **CLEANING COOLING SYSTEM.** Cooling system should be thoroughly cleaned and flushed at frequent intervals when operating in extremely high temperatures.

(3) **FAN BELT AND WATER PUMP.** Fan belt should be inspected at regular intervals and adjusted if necessary (par. 80). Water pump must be kept in good operating condition.

(4) **THERMOSTAT.** Check operation of thermostat (par. 82). Thermostat must open at calibrated temperature to prevent overheating of cooling liquid.

(5) **HOSE CONNECTIONS.** Check hose connections frequently for leaks.

c. **Oil Filter.** Oil filter elements must be checked and replaced at more frequent intervals if vehicle is operating in hot, sandy regions. Crankcase air vent cleaner must be serviced at frequent intervals.

d. **Air Cleaners.** If vehicle is extensively operated in sandy or dusty regions, carburetor air cleaner and crankcase ventilator air cleaner should be cleaned daily. If vehicle is operated in dust storm areas, these cleaners should be cleaned immediately after such storms occur.

e. **Battery.**

(1) **WATER LEVEL.** In torrid zones, cell water level should be checked daily and replenished if necessary with pure distilled water. If this is not available, any water fit to drink may be used. However, continuous use of water with high mineral content will eventually cause damage to battery and should be avoided.

(2) **SPECIFIC GRAVITY.** Batteries operating in torrid climates should have a weaker electrolyte than for temperate climates. Instead of 1.300 gravity, the electrolyte should be adjusted to around 1.210 to 1.230 for a fully charged battery. This will prolong the life of the negative plates and separators. Under this condition battery should be recharged at about 1.160. Where freezing conditions do not prevail, there is no danger with gravities from 1.230 to 1.075.

2½-TON 4 x 2 TRUCK (FEDERAL)

(3) **SELF-DISCHARGE.** A battery will "self-discharge" at a greater rate at high temperatures if standing for long periods. This must be taken into consideration when operating in torrid zones. If necessary to park for several days, battery should be removed and stored in a cool place.

f. Operating Vehicle. In extremely high temperatures, avoid the continuous use of low gear ratios whenever possible. Frequent inspection and servicing of air cleaners, fuel filter, and oil filter should be made if side panels are removed during operation in dusty areas. Watch the temperature and oil gages constantly. Check and replenish oil and water frequently.

13. MUD, SAND, SNOW, ICE, FLOOD, AND POISONOUS GAS.

a. Mud. Install tire chains on both rear wheels and select low enough gear ratio to move vehicle steadily without putting undue driving strain on engine and axles. Do not attempt to affect increased traction by elevating a loaded body, as the increased weight on rear axle will cause the vehicle to sink beyond the point where it can be moved by its own power.

b. Sand. The main objective when driving in sand is to avoid the possibility of spinning the driving wheels. If possible, lay an improvised track with planks or brush in order to prevent the wheels coming in contact with the loose footing. Do not let the motor labor. Reverse and go forward several times if necessary, until a solid road bed is reached.

c. Snow and Ice. Skidding is the general hazard encountered in these conditions. Install chains, and select the proper gear ratio to move the vehicle steadily, without imposing undue strain on engine and axle. When skidding occurs, turn the front wheels in the same direction that the rear end is sliding. Decelerate the engine and apply brakes very gradually until vehicle is under control. Proceed with caution. Remove chains as soon as their use is no longer necessary.

d. Flood. Know the fording depth of your vehicle and do not exceed its known limits. Reduce the vehicle speed to 4 miles per hour and proceed with caution. Exercise care to avoid water damage to electrical and driving systems. Lubricated parts which have been affected by mud and water must be serviced at earliest opportunity.

e. Poisonous Gas. Removing and destroying dangerous chemical agents encountered when operating in these areas is known as decontamination and is covered by instructions contained in FM 17-59, which should be followed in every case.

Section V

FIRST ECHELON PREVENTIVE MAINTENANCE SERVICE

	Paragraph
Purpose	14
Before-operation service	15
During-operation service	16
At-halt service	17
After-operation and weekly service.....	18

14. PURPOSE.

a. To insure mechanical efficiency it is necessary that the vehicle be systematically inspected at intervals, each day it is operated and weekly, so that defects may be discovered and corrected before they result in serious damage or failure. Certain scheduled maintenance services will be performed at these designated intervals. The services set forth in this section are those performed by driver or crew, before-operation, during-operation, at-halt, and after-operation and weekly.

b. Driver Preventive Maintenance Services are listed on the back of "Driver's Trip Ticket and Preventive Maintenance Service Record," W.D. Form No. 48, to cover vehicles of all types and models. Items peculiar to specific vehicles, but not listed on W.D. Form No. 48, are covered in manual procedures under the items to which they are related. Certain items listed on the form that do not pertain to the vehicle involved are eliminated from the procedures as written into the manual. Every organization must thoroughly school each driver in performing the maintenance procedures set forth in manuals, whether they are listed specifically on W.D. Form No. 48 or not.

c. The items listed on W.D. Form No. 48 that apply to this vehicle are expanded in this manual to provide specific procedures for accomplishment of the inspections and services. These services are arranged to facilitate inspection and conserve the time of the driver, and are not necessarily in the same numerical order as shown on W.D. Form No. 48. The item numbers, however, are identical with those shown on that form.

d. The general inspection of each item applies also to any supporting member or connection, and generally includes a check to see whether the item is in good condition, correctly assembled, secure, or excessively worn.

(1) The inspection for "good condition" is usually an external visual inspection to determine whether the unit is damaged beyond safe or serviceable limits. The term "good condition" is explained further by the following: not bent or twisted, not chafed or burned, not broken or cracked, not bare or frayed, not dented or collapsed, not torn or cut.

2½-TON 4 x 2 TRUCK (FEDERAL)

(2) The inspection of a unit to see that it is "correctly assembled" is usually an external visual inspection to see whether it is in its normal assembled position in the vehicle.

(3) The inspection of a unit to determine if it is "secure" is usually an external visual examination, a hand-feel, a pry-bar or wrench check for looseness. Such an inspection should include any brackets, lock washers, lock nuts, locking wires, or cotter pins used in assembly.

(4) "Excessively worn" will be understood to mean worn, close to or beyond serviceable limits, and likely to result in a failure if not replaced before the next scheduled inspection.

e. Any defects or unsatisfactory operating characteristics beyond the scope of first echelon to correct must be reported at the earliest opportunity to the designated individual in authority.

15. BEFORE-OPERATION SERVICE.

a. This inspection schedule is designed primarily as a check to see that the vehicle has not been tampered with, or sabotaged since the After-operation Service was performed. Various combat conditions may have rendered the vehicle unsafe for operation, and it is the duty of the driver to determine whether or not the vehicle is in condition to carry out any mission to which it is assigned. This operation will not be entirely omitted, even in extreme tactical situations.

b. **Procedures.** Before-operation Service consists of inspecting items listed below according to the procedure described, and correcting or reporting any deficiencies. Upon completion of the service, results should be reported promptly to the designated individual in authority.

(1) **ITEM 1, TAMPERING AND DAMAGE.** Examine exterior of vehicle, engine, wheels, brakes, and steering control for damage by falling debris, shell fire, sabotage, or collision. If wet, dry the ignition parts to insure easy starting.

(2) **ITEM 2, FIRE EXTINGUISHER.** Be sure it is full, nozzle is clean, and mountings are secure.

(3) **ITEM 3, FUEL, OIL, AND WATER.** Check for tampering and low levels. Add fuel, oil, or water as needed. Have value of antifreeze compound checked if, during period when antifreeze is used, it becomes necessary to replenish a considerable amount of water. Report unusual losses to designated authority.

(4) **ITEM 4, ACCESSORIES AND DRIVES.** Check carburetor, generator, regulator, cranking motor, and water pump for loose connections, or leaks, and security of mountings. Test fan belt for deflection of ½ inch midway between fan and crankshaft pulleys.

(5) **ITEM 6, LEAKS, GENERAL.** Look on ground under vehicle for indications of fuel, oil, water, brake fluid, or gear oil leaks. Trace leaks to source and correct or report to higher authority.

FIRST ECHELON PREVENTIVE MAINTENANCE SERVICE

(6) **ITEM 7, ENGINE WARM-UP.** Start engine, observe cranking motor action, listen for unusual noise, and note cranking speed. Idle engine only fast enough to run smoothly. Proceed immediately with following services while engine is warming up:

(7) **ITEM 8, CHOKE.** As engine warms, push in choke as required for smooth operation and to prevent crankcase dilution.

(8) **ITEM 9, INSTRUMENT.**

(a) *Fuel Gage.* Gage must indicate approximate amount of fuel in tank.

(b) *Oil Gage.* Normal oil pressure must be not below 10 pounds at idle, and 20 to 30 pounds at running speeds, at operating temperature. If gage fails to register within 10 seconds, stop engine and correct or report to designated authority.

(c) *Temperature Indicator.* Temperature should rise slowly during warm-up. Normal operating temperature is 160° to 185°F.

(d) *Ammeter.* Ammeter must show high charge for short period after starting and a zero or slight positive (+) reading with lights and accessories off. A zero reading with lights and accessories on is normal.

(9) **ITEM 10, HORN AND WINDSHIELD WIPERS.** Test horn for proper operation and tone if tactical situation permits. Check both wipers for secure attachment and normal full-contact operation through full stroke.

(10) **ITEM 11, GLASS AND REAR VIEW MIRROR.** Clean and look for cracked, discolored, or broken glass. Clean and aim mirror.

(11) **ITEM 12, LAMPS AND REFLECTORS.** Try switches in each position and see if lights respond; lights and warning reflectors must be secure and clean. Test foot control of headlight beams.

(12) **ITEM 13, WHEEL AND FLANGE NUTS.** Observe whether all wheel and flange nuts are present; tighten as needed.

(13) **ITEM 14, TIRES.** Test tires with gage if time permits; pressure should be 60 pounds with tires cold (including spare). Remove imbedded objects from treads and stones, or debris from between duals. Inspect treads and carcasses for cuts and bruises. Observe for presence of valve caps.

(14) **ITEM 15, SPRINGS AND SUSPENSION.** Look for sagged or broken leaves, shifted leaves, loose or missing rebound clips, and loose U-bolts.

(15) **ITEM 16, STEERING LINKAGE.** Examine steering gear case, steering arms, drag link, tie rod and pitman arm for security and good condition. Test for excessive lash by "back-and-forth" motion of steering wheel.

(16) **ITEM 17, FENDERS AND BUMPER.** Examine fenders and bumper for security and serviceable condition.

2½-TON 4 x 2 TRUCK (FEDERAL)

(17) **ITEM 18, TOWING CONNECTIONS.** Examine pintle and tow hooks for secure mounting and damaged condition.

(18) **ITEM 19, BODY AND LOAD.** Examine for damage. Observe tail-gate locking devices, chains and hinge pivots for good operating condition, and make sure tail gate is fastened securely.

(19) **ITEM 20, DECONTAMINATOR.** Examine decontaminator for full charge and secure mounting.

(20) **ITEM 21, TOOLS AND EQUIPMENT.** See that tools and equipment are all present, properly stowed, and serviceable.

(21) **ITEM 23, DRIVER'S PERMIT AND ACCIDENT REPORT FORM No. 48.** These forms must be present, legible, and safely stowed.

(22) **ITEM 22, ENGINE OPERATION.** Accelerate engine and observe for unusual noise indicating compression or exhaust leaks, worn, damaged, loose, or inadequately lubricated parts, or misfiring.

(23) **ITEM 25, DURING-OPERATION SERVICE.** Begin the During-operation Service immediately the vehicle is put in motion. **CAUTION:** *Make sure power take-off is not engaged when not using hoist.*

16. DURING-OPERATION SERVICE.

a. While vehicle is in motion, listen for any sounds such as rattles, knocks, squeals, or hums that may indicate trouble. Look for indications of trouble in cooling system and smoke from any part of the vehicle. Be alert to detect any odor of overheated components or units such as generator, brakes, or clutch, fuel vapor from a leak in fuel system, exhaust gas, or other signs of trouble. Any time the brakes are used, gears shifted, or vehicle turned, consider this a test and notice any unsatisfactory or unusual performance. Watch the instruments constantly. Notice promptly any unusual instrument indication that may signify possible trouble in system to which the instrument applies.

b. **Procedures.** During-operation Service consists of observing items listed below according to the procedures following each item, and investigating any indications of serious trouble. Notice minor deficiencies to be corrected or reported at earliest opportunity, usually at next scheduled halt.

(1) **ITEM 27, FOOT AND HAND BRAKES.** Foot brakes must stop vehicle smoothly without side-pull, and within reasonable distance. Pedal to floor board clearance must be at least 1 inch with pedal in applied position. Hand brake must securely hold vehicle on reasonable incline, with ½ reserve ratchet travel.

(2) **ITEM 28, CLUTCH.** Clutch must operate smoothly without chatter, grabbing, or slipping. Free pedal travel must be ¾ to 1½ inch.

(3) **ITEM 29, TRANSMISSION AND POWER TAKE-OFF.** Gear shift mechanism must operate smoothly and not creep out of mesh.

FIRST ECHELON PREVENTIVE MAINTENANCE SERVICE

(4) **ITEM 31, ENGINE AND CONTROLS.** Observe whether engine responds to controls and has maximum pulling power without unusual noises, stalling, misfiring, overheating, or unusual exhaust smoke.

(5) **ITEM 32, INSTRUMENTS.** Observe the readings of all instruments frequently during operation to see whether they are indicating properly.

(a) *Fuel Gage.* Gage must register approximate amount of fuel in tank.

(b) *Oil Pressure Gage.* Gage must register 10 pounds pressure at idle, to 20 to 30 pounds pressure at running speeds.

(c) *Speedometer.* Speedometer must show speed, accumulating trip and total mileage.

(d) *Temperature Gage.* Normal operating temperature should be between 160° to 185°F.

(e) *Ammeter.* Ammeter should show zero reading with lights on and engine at idle speed; zero or slight positive (+) charge with all lights off, if battery is fully charged; higher positive (+) reading immediately after starting, or if battery is low or electrical load heavy.

(6) **ITEM 33, STEERING GEAR.** Observe vehicle for excessive pulling to either side, wandering, or shimmy.

(7) **ITEM 34, RUNNING GEAR.** Listen for unusual noises from wheels or axles.

(8) **ITEM 35, BODY AND HOIST.** Observe for loose body mountings. Observe hoist during operation for proper speed in raising and lowering, and firmness in holding in elevated positions as desired. **CAUTION:** *Use extreme care in lowering loaded body to avoid damage to subframe and hinge brackets.*

17. AT-HALT SERVICE.

a. At-halt Service may be regarded as minimum maintenance procedures and should be performed under all tactical conditions, even though more extensive maintenance services must be slighted or omitted altogether.

b. **Procedures.** At-halt Service consists of investigating any deficiencies noted during operation, inspecting items listed below according to the procedures following the items, and correcting any deficiencies found. Deficiencies not corrected should be reported promptly to the designated individual in authority.

(1) **ITEM 38, FUEL, OIL, AND WATER.** Check fuel supply, oil, and water, and add as required to complete operation of vehicle to the next refueling point. If during period when antifreeze compound is used, an abnormal amount of water is required to refill radiator, have coolant tested with hydrometer and add antifreeze compound if required.

2½-TON 4 x 2 TRUCK (FEDERAL)

(2) **ITEM 39, TEMPERATURES: HUBS, BRAKE DRUMS, TRANSMISSION, AND REAR AXLES.** Feel each brake drum and wheel hub to see whether it is abnormally hot. Feel transmission and rear axle for overheating. Examine for excessive oil leaks.

(3) **ITEM 40, AXLE VENT.** Observe whether axle vent is present and not damaged or clogged.

(4) **ITEM 41, PROPELLER SHAFT.** Inspect propeller shaft for looseness, damage, or oil leaks. Remove any foreign material wound around propeller shafts or joints.

(5) **ITEM 42, SPRINGS.** Look for broken leaves or loose clips, loose spring and shackle bolts, and loose U-bolts.

(6) **ITEM 43, STEERING LINKAGE.** Examine steering control mechanism for damage or looseness. Investigate any irregularities noted during operation.

(7) **ITEM 44, WHEEL AND FLANGE NUTS.** Observe whether all wheel and axle flange nuts are present and tight.

(8) **ITEM 45, TIRES.** Inspect tires for flats or damage, cuts, or foreign material imbedded in tread (including spare). Remove stones or debris from duals.

(9) **ITEM 46, LEAKS, GENERAL.** Look around engine and on ground beneath the vehicle for excessive leaks. Trace to source and correct cause or report to designated authority.

(10) **ITEM 47, ACCESSORIES AND BELT.** See that fan, water pump, and generator are secure; see that fan belt is adjusted to a deflection of ½ inch, and not badly frayed.

(11) **ITEM 48, AIR CLEANER.** If dusty or sandy conditions have been encountered, examine air cleaner oil reservoir for excessive dirt; service if required. Service crankcase oil-bath breather each time carburetor air cleaner is serviced.

(12) **ITEM 49, FENDERS AND BUMPER.** Inspect fenders and bumper for looseness or damage.

(13) **ITEM 50, TOWING CONNECTIONS.** Inspect pintle hook, front tow hooks and trailer light attachment for looseness or damage.

(14) **ITEM 51, BODY.** Examine for damage, loose or missing bolts, and missing cotter pins.

(15) **ITEM 52, APPEARANCE AND GLASS.** Clean all glass, mirror, and light lenses and inspect vehicle for damage.

18. AFTER-OPERATION AND WEEKLY SERVICE.

a. After-operation Service is particularly important because at this time the driver inspects his vehicle to detect any deficiencies that may have developed, and corrects those he is permitted to handle. He should report promptly, to the designated individual in authority, the results of his inspection. If this schedule is performed thoroughly, the

FIRST ECHELON PREVENTIVE MAINTENANCE SERVICE

vehicle should be ready to roll again on a moment's notice. The Before-operation Service, with a few exceptions, is then necessary only to ascertain whether the vehicle is in the same condition in which it was left upon completion of the After-operation Service. The After-operation Service should never be entirely omitted, even in extreme tactical situations, but may be reduced to the bare fundamental services outlined for the At-halt Service, if necessary.

b. Procedures. When performing the After-operation Service the driver must remember and consider any irregularities noticed during the day in the Before-operation, During-operation, and At-halt Services. The After-operation Service consists of inspecting and servicing the following items. Those items of the After-operation Service that are marked by an asterisk (*) require additional weekly services, the procedures for which are indicated in subparagraph (b) of each applicable item.

(1) **ITEM 55, ENGINE OPERATION.** Listen for miss, backfire, noise, or vibration that might indicate worn parts, loose mountings, faulty fuel mixture, or faulty ignition. Report any unsatisfactory condition noted during operation.

(2) **ITEM 56, INSTRUMENTS.** Inspect all instruments to see that they are properly recording performance of units to which they apply, and whether they are secure and not damaged.

(3) **ITEM 57, HORN AND WINDSHIELD WIPERS.** If tactical situation permits, test horn for proper operation and tone. See that it is secure and properly connected. Operate wipers. See that blades contact the glass throughout full stroke.

(4) **ITEM 54, FUEL, OIL, AND WATER.** Check coolant and oil levels, and add as needed. Fill fuel tank. During period when antifreeze compound is used, have hydrometer test made of coolant if loss of coolant from boiling or other cause has been considerable. Add antifreeze compound with water if required.

(5) **ITEM 58, GLASS AND REAR VIEW MIRROR.** Clean glass. Examine mirror for secure mounting and damage.

(6) **ITEM 59, LAMPS AND REFLECTORS.** Observe whether lights operate with the switch at "ON" positions and go out when switch is "OFF." Observe stop light operation. Clean all lenses and warning reflectors and inspect for looseness or damage.

(7) **ITEM 60, FIRE EXTINGUISHER.** Be sure fire extinguisher is full, nozzle clean, and mounted securely.

(8) **ITEM 61, DECONTAMINATOR.** Examine decontaminator for good condition and secure mounting.

(9) **ITEM 62, *BATTERY.**

2½-TON 4 x 2 TRUCK (FEDERAL)

(a) See that battery is clean, secure, and not leaking. See that caps are in place with vents open, and that cables are clean.

(b) *Weekly.* Clean top of battery. Remove battery caps, and add water to $\frac{3}{8}$ inch above plates. (Use distilled water if available; if not, use clean water). **CAUTION: Do not overfill.** Clean post and terminals of corrosion, and apply light coat of grease. Tighten terminals as needed. Tighten carrier clamp bolts. Clean battery carrier if corroded.

(10) ITEM 63, *ACCESSORIES AND BELTS.

(a) Test fan belt for deflection of $\frac{1}{2}$ inch. Examine belt for good condition; it must not be frayed.

(b) *Weekly.* Tighten all accessories such as carburetor, generator, and regulator, cranking motor, fan, water pump, hose connections, and any leading connections. Examine fan belt for fraying, wear, cracking, or presence of oil.

(11) ITEM 64, *ELECTRIC WIRING.

(a) See that ignition wiring is securely connected, clean, and undamaged.

(b) *Weekly.* See that wiring is securely connected and supported, that insulation, conduits, and shielding are not cracked or chafed.

(12) ITEM 65, *AIR CLEANER AND CRANKCASE OIL-BATH BREATHER.

(a) Examine oil in cleaner and breather to see that it is at proper level and not excessively dirty. Clean and reoil elements and clean and refill oil cup reservoirs as required.

(b) *Weekly.* Remove, clean, and dry elements and oil reservoirs. Reoil elements and fill cups to indicated oil level.

(13) ITEM 66, *FUEL FILTERS.

(a) Examine fuel filters for leaks.

(b) *Weekly.* Remove plug from bottom of frame-mounted fuel filter. Allow water and sediment to drain out. Be sure plug is replaced tightly, without leak. Clean fuel filter on fuel pump. Replace gasket if necessary.

(14) ITEM 67, ENGINE CONTROLS. Examine engine controls for wear or disconnected linkage.

(15) ITEM 68, *TIRES.

(a) Inspect tires for cuts, or abnormal tread wear, and remove foreign bodies from tread. Test pressure of all tires (including spares), and inflate to 60 pounds maximum, when cool.

(b) *Weekly.* Replace badly worn or otherwise unserviceable tires.

FIRST ECHELON PREVENTIVE MAINTENANCE SERVICE

(16) ITEM 69, *SPRINGS.

(a) Examine springs for sag, broken or shifted leaves, loose or missing rebound clips, bolts, or shackles.

(b) *Weekly.* Tighten and align springs as required.

(17) ITEM 70, STEERING LINKAGE. Inspect steering linkage for bent, loose, or inadequately lubricated parts.

(18) ITEM 71, PROPELLER SHAFTS AND CENTER BEARING. Inspect these items for loose connections, lubrication leaks, or damage.

(19) ITEM 72, *AXLE AND VENT.

(a) Axle vent must be in good condition, clean and secure.

(b) *Weekly.* Remove, clean, and replace vent. Make sure differential carrier mounting cap screws are tight.

(20) ITEM 73, LEAKS, GENERAL. Check under hood and beneath the vehicle for indication of fuel, oil, water, or brake fluid leaks.

(21) ITEM 74, GEAR OIL LEVELS. After units have cooled down, inspect differential and transmission for lubricant levels and leaks. Lubricant should be $\frac{1}{2}$ inch below bottom of filler hole (cool).

(22) ITEM 76, FENDERS AND BUMPER. Fenders and bumper must be in good condition and secure.

(23) ITEM 77, TOWING CONNECTIONS. Inspect pintle hook and towed-load connections for looseness or damage.

(24) ITEM 78, BODY AND CAB. Examine cab and body mounting bolts. Tighten if necessary. CAUTION: *Do not overtighten rear cab mounting bolt (with spring).* Examine hoist, hoist pump valve linkage, and propeller shafts, and universal joints for good condition, secure mounting, and adequate lubrication. Inspect hoist and hoist pump for excessive leaks.

(25) ITEM 82, *TIGHTEN: (WHEEL, AXLE DRIVE FLANGE, AND SPRING U-BOLT NUTS).

(a) Tighten any loose wheel, axle drive flange, and spring U-bolt nuts.

(b) *Weekly.* Tighten all vehicle assembly or mounting nuts or screws that inspection indicates require tightening. Inspect for presence of cotter pins on dump body and subframe.

(26) ITEM 83, *LUBRICATE AS NEEDED.

(a) Lubricate spring shackles and steering linkage, if needed. Turn down water pump grease cup one turn each day vehicle is used.

2½-TON 4 x 2 TRUCK (FEDERAL)

(b) *Weekly.* Lubricate points indicated on vehicle Lubrication Guide as requiring weekly attention, also points that experience and condition indicate need lubrication.

(27) ITEM 84, *CLEAN ENGINE AND VEHICLE.

(a) Clean dirt and trash from inside of body. Remove excessive dirt or grease from the exterior of the engine.

(b) *Weekly.* Wash vehicle when possible. If not possible, wipe off thoroughly. Clean engine.

(28) ITEM 85, *TOOLS AND EQUIPMENT.

(a) Check to see that all tools and equipment assigned to vehicle are present and secure.

(b) *Weekly.* Check tools and equipment with stowage list (par. 21) to see that all items are present. See that they are in good condition and securely mounted or properly stowed.

Section VI

LUBRICATION

	Paragraph
Introduction	19
Lubrication guide	20

19. INTRODUCTION.

a. Lubrication is an essential part of preventive maintenance, determining to a great extent the serviceability of parts and assemblies.

20. LUBRICATION GUIDE.

a. **General.** Lubrication instructions for this materiel are consolidated in a Lubrication Guide (figs. 10 and 11). These specify the points to be lubricated, the periods of lubrication, and the lubricant to be used. In addition to the items on the guide, other small moving parts, such as hinges and latches, must be lubricated at frequent intervals.

b. **Supplies.** In the field it may not be possible to supply a complete assortment of lubricants called for by the Lubrication Guide to meet the recommendations. It will be necessary to make the best use of those available, subject to inspection by the officer concerned, in consultation with responsible ordnance personnel.

c. **Lubrication Notes.** The following notes apply to the Lubrication Guide (figs. 10 and 11). All note references in the guide itself are to the subparagraph below having the corresponding number:

(1) **FITTING.** Clean before applying lubricant. Lubricate until new lubricant is forced from the bearing, unless otherwise specified. **CAUTION:** *Lubricate chassis points after washing truck.*

(2) **INTERVALS.** Intervals indicated are for normal service. For extreme conditions of speed, heat, water, sand, mud, snow, rough roads, dust, etc., reduce interval by $\frac{1}{3}$ or $\frac{1}{2}$, or more if conditions warrant.

(3) **AIR CLEANERS.** Daily, check level and refill oil reservoir of engine and crankcase breather air cleaners to bead level with used crankcase oil or crankcase grade engine oil. Every 1000 miles, or daily under extreme dust conditions, remove and wash all parts. Every 1000 miles, remove hydrovac cylinder air cleaner located under driver's seat, clean hair and oil with crankcase grade engine oil. Proper maintenance of air cleaners is essential to prolonged engine life.

(4) **CRANKCASE.** Drain only when engine is hot. Refill to "FULL" mark on gage. Run engine a few minutes and recheck oil level. If oil filter element is changed, two additional quarts will be required. **CAUTION:** *Be sure pressure gage indicates oil is circulating.*

(5) **OIL FILTER.** Every 1000 miles, drain filter through drain plug. Every 6000 miles, or more often if filter becomes clogged, renew

2½-TON 4 x 2 TRUCK (FEDERAL)

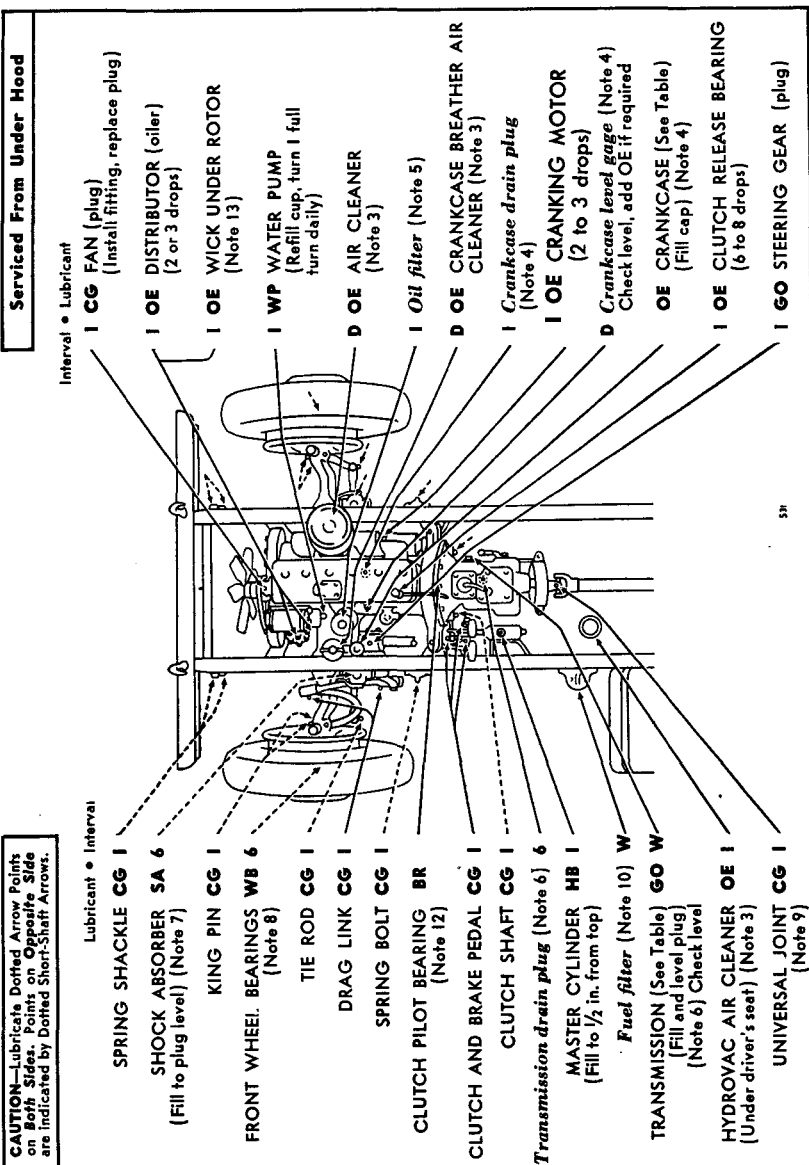

RA PD 300107

LUBRICATION

KEY

LUBRICANTS	
OE	OIL, engine Crankcase grade
CG	GREASE, general purpose No. 1 (above +32°F.) No. 0 (below +32°F.)
GO	LUBRICANT, gear, universal Seasonal grade
WB	GREASE, general purpose, No. 2
WP	GREASE, water pump
HB	FLUID, brake, hydraulic
SA	FLUID, shock-absorber, light
OH	OIL, hydraulic
BR	GREASE, ball and roller bearing

INTERVALS	
D	DAILY
W	WEEKLY
1	1,000 MILES
6	6,000 MILES
CHECK DAILY	
Crankcase	
Air Cleaner	
Crankcase Breather	

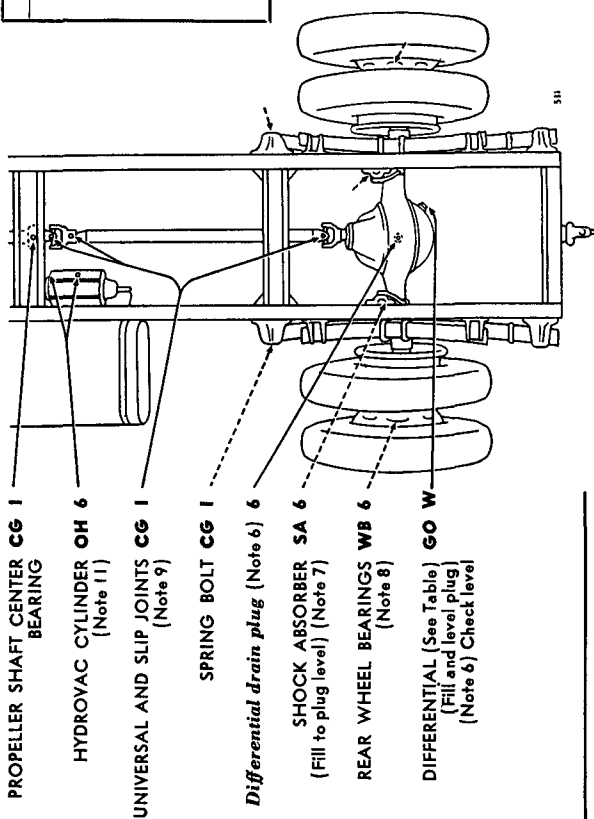

TABLE OF CAPACITIES AND LUBRICANTS TO BE USED

UNIT	CAPACITY (Approx.)	LOWEST EXPECTED AIR TEMPERATURE	
		+32°F. and above	+32°F. to 0°F. Below 0°F.
Crankcase	6 qt.	OE SAE 30	OE SAE 10
Transmission	7 qt.	GO	GO
Rear Axle Differential	7 1/2 qt.	SAE 90	SAE 80

OF58 4-G-538 (131)

RA PD 300107B

Figure 10—Chassis Lubrication Guide

2½-TON 4 x 2 TRUCK (FEDERAL)

CAUTION—Always place a prop or block under body before performing any service work.

CAUTION—Lubricate Dotted Arrow Points on Both Sides. Points on Opposite Side are indicated by Dotted Short-Shaft Arrows.

Lubricant • Interval

TAILGATE CONTROL LEVER **CG 1**

TAILGATE RELEASE LEVER **CG 1**
BRACKET
(Galion Models only)

TAILGATE CONTROL ROD **OE 2W**

PISTON ROD CROSSHEAD **CG 1**

TRIP ROD YOKE **OE 2W**

TIPPING FRAME HINGE **CG 1**
SHAFT

HOIST CYLINDER **OE 2W**
(Note 14)

CYLINDER HINGE **CG 1**
(Anthony Models only)

VALVE CONTROL ROD **OE 2W**

UNIVERSAL JOINT **CG 2W**
(Sparingly)

SLIP JOINT **CG 2W**
(Sparingly)

UNIVERSAL JOINT **CG 2W**
(Sparingly)

CENTER BEARING **CG 2W**

UNIVERSAL JOINT **CG 2W**
(Sparingly)

DUMP BODY

KEY

LUBRICANTS

OE—OIL, engine
Crankcase grade

CG—GREASE, general purpose
No. 1 (above +32°F.)
No. 0 (below +32°F.)

INTERVALS

1—1,000 MILES
2W—2 WEEKS

RA PD 300108

Figure 11—Hoist Lubrication Guide

filter element. After renewing element, refill crankcase to "FULL" mark on gage. Run engine a few minutes, recheck level and add oil to "FULL" mark.

(6) GEAR CASES. Weekly, check level with truck on level ground and, if necessary, add lubricant to within ½ inch of plug level when cold or to plug level when hot. Drain, flush, and refill at intervals indicated on Lubrication Guide. When draining, drain immediately after operation. To flush, fill cases to about one-half capacity with SAE

LUBRICATION

10 engine oil. Operate mechanism within cases slowly for several minutes and redrain. Replace drain plugs and refill cases to correct level with lubricant specified on guide.

(7) **SHOCK ABSORBERS.** To fill, disconnect linkage at lower end. Remove plug and fill to level with light shock absorber fluid. Pump arm up and down to expel air. Repeat this procedure until no more fluid can be added. Install plug and connect linkage.

(8) **WHEEL BEARINGS (FRONT AND REAR).** Remove bearing cone assemblies from hub and wash spindle and inside of hub with dry-cleaning solvent. Inspect bearing races and replace if necessary. Wet the spindle and inside of hub and hub cap with wheel bearing grease (No. 2) to a maximum thickness of $\frac{1}{16}$ inch only, to retard rust. Wash bearing cones and grease seals with dry-cleaning solvent. Inspect and replace if necessary. Lubricate bearings with wheel bearing grease (No. 2) with a packer or by hand, kneading lubricant into all spaces in the bearing. Use extreme care to protect bearings from dirt, and immediately reassemble and replace wheel. The lubricant in the bearings is sufficient to provide lubrication until the next service period. Any excess might result in leakage into the brake drum.

(9) **UNIVERSAL JOINTS AND SLIP JOINTS.** Apply general purpose grease (seasonal grade), to universal joint until it overflows at relief valve and to slip joint until lubricant is forced from end of slip joint.

(10) **FUEL FILTER.** Weekly, remove drain plug to drain accumulated dirt and sediment. Every 1000 miles, remove filter and clean thoroughly.

(11) **HYDROVAC CYLINDER.** Every 6000 miles or 6 months, remove pipe plug at relay valve end of power cylinder near center plate. Lubricate with $\frac{1}{2}$ ounce of hydraulic oil through each opening. Replace plugs.

(12) **CLUTCH PILOT BEARING.** Whenever clutch is removed for inspection or repair, after cleaning parts, pack pilot bearing and fill cavity in crankshaft behind bearing; coat shaft splines lightly with ball and roller bearing grease.

(13) **DISTRIBUTOR.** Every 2000 miles, wipe distributor breaker cam lightly with general purpose grease (seasonal grade), and lubricate breaker arm pivot with one or two drops of crankcase grade engine oil.

(14) **HOIST CYLINDERS. (GALION):** Raise body to maximum lift, fill cylinder and before replacing cover, lower body to bleed air and surplus oil. Again raise body and replace fill hole cover and gasket. **(ANTHONY):** With body in full raised position and with pump operating at idling speed, remove filler plug and fill cylinder to plug level. To expel air and excess oil from system, replace filler plug loosely, about two turns, remove body props and stop pump, slowly lower the body to riding position, and allow to set for a few moments, then raise the

2½-TON 4 x 2 TRUCK (FEDERAL)

body and tighten filler plug securely. **CAUTION:** *Do not race or speed motor while raising or lowering body, as this will cause the oil to foam and may result in damage to seals.*

(15) **OILCAN POINTS.** Every 1000 miles, lubricate pintle hook pins and connections, all control and shift rod bushings, pins, linkage, clevises, etc., with crankcase grade engine oil.

(16) **POINTS REQUIRING NO LUBRICATION SERVICE.** Generator, springs, shock absorber linkage, power take-off, and dump hoist hydraulic pump require no lubrication service.

(17) **POINTS TO BE SERVICED AND/OR LUBRICATED BY ORDNANCE MAINTENANCE PERSONNEL.** None.

d. **Localized Views.** The series of illustrations (figs. 13 through 16) show localized views of various lubrication points. Caption under

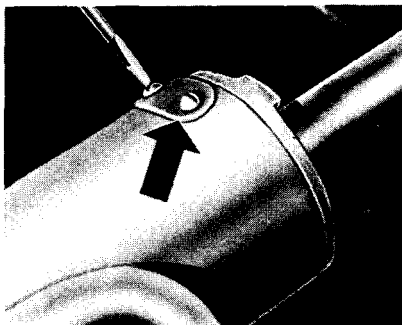

HOIST CYLINDER (GALION)—OE

Filler plate, filler gun. Raise body, remove plate and gasket.

Fill to plug level. Lower body to bleed surplus air and oil.

Raise body, install filler plate and gasket.

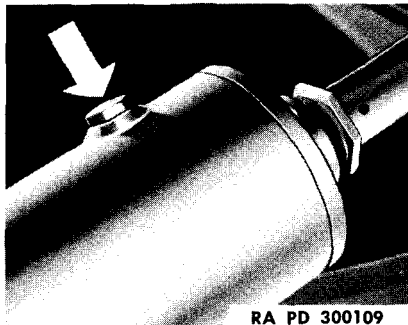

RA PD 300109

HOIST CYLINDER (ANTHONY)—OE

Filler plug. Filler gun. Raise and prop body, and keep pump at idling speed. Remove plug and fill to plug level. Install plug, loosely, remove body prop and stop pump. Lower body slowly, allow to set at riding position for a few moments to expel surplus air. Raise body and tighten filler plug.

Figure 12—Lubrication Points

each view briefly describes the type of fitting, method of lubrication, and special information regarding the lubrication of that specific item. The illustrations or captions do not specify lubricant (except by symbols), or intervals at which points must be lubricated. Reference must be made to Lubrication Guides (figs. 10, 11, and 12) for those items. Information on those items which require special lubrication operations will be found in respective sections of the manual.

e. Reports and Records.

(1) **REPORTS.** If lubrication instructions are closely followed, proper lubricants used, and satisfactory results are not obtained, make a report to the ordnance officer responsible for the maintenance of the materiel.

(2) **RECORDS.** Keep a complete record of lubrication servicing.

LUBRICATION

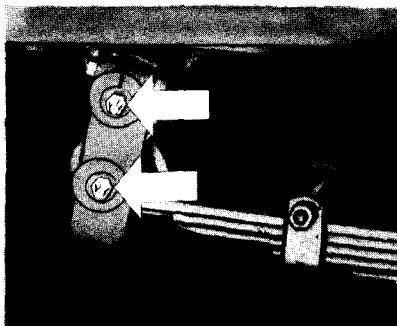

FRONT SPRING SHACKLES—CG

Two fittings each side. Pressure gun. Apply lubricant through fittings until new grease shows both ends of each pin.

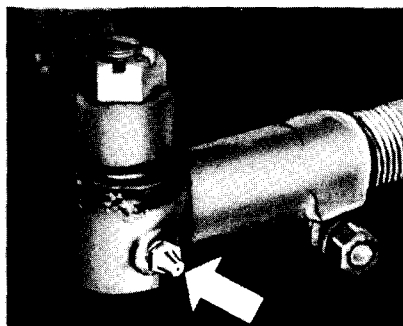

TIE ROD END—CG

One fitting each side. Pressure gun. Apply lubricant through fittings until new grease shows above each fitting.

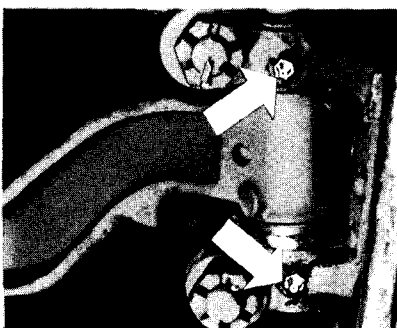

KNUCKLE PINS—CG

Two fittings each side. Pressure gun. Apply lubricant through fittings until new grease shows top and bottom.

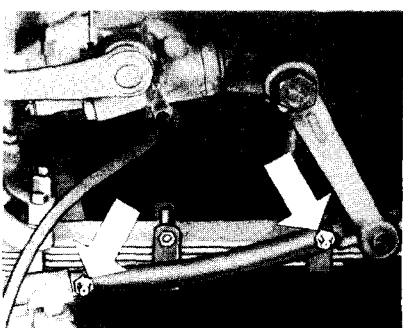

STEERING DRAG LINK—CG

Two fittings LH side. Pressure gun. Apply lubricant until new grease shows at each end.

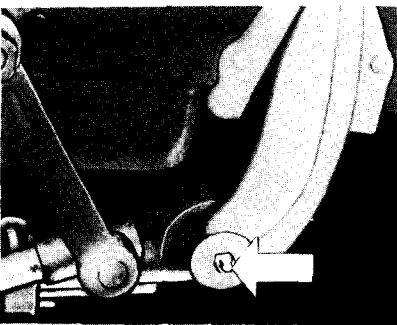

FRONT SPRING BOLTS—CG

One fitting each side. Pressure gun. Apply lubricant through fittings until new grease shows both ends of each pin.

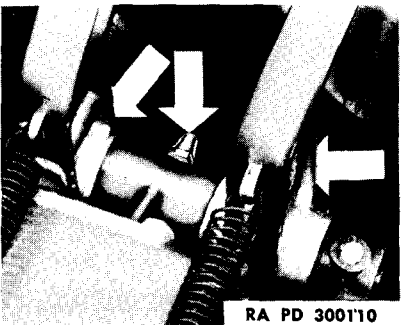

PEDAL SHAFT—CG

Three fittings, LH side. Pressure gun. Apply lubricant until new grease shows at each end of bracket.

RA PD 3001'10

Figure 13—Lubrication Points

2½-TON 4 x 2 TRUCK (FEDERAL)

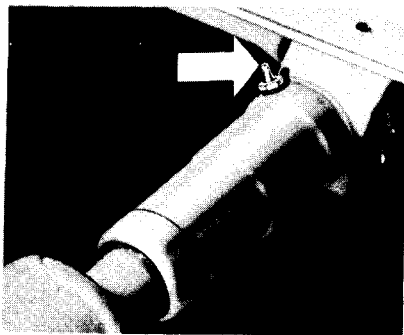

PROPELLER SHAFT SLIP JOINT—CG

One fitting. Pressure gun. Apply lubricant until new grease shows.

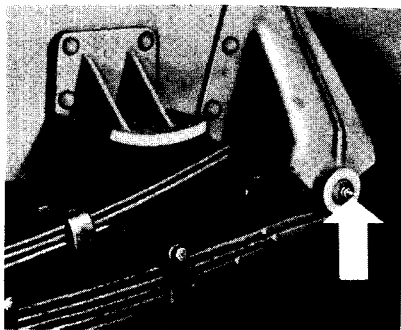

REAR SPRING BOLTS—CG

One fitting each side. Pressure gun. Apply lubricant until new grease shows at both ends of each pin.

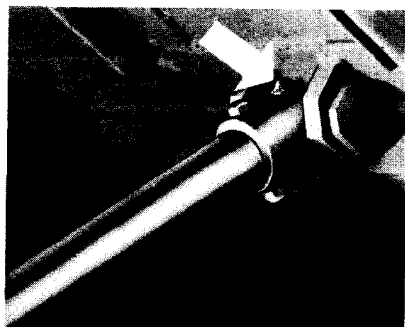

HOIST CYLINDER END YOKE—CG

One fitting under body. Pressure gun. Apply lubricant until new grease shows at both ends of pin.

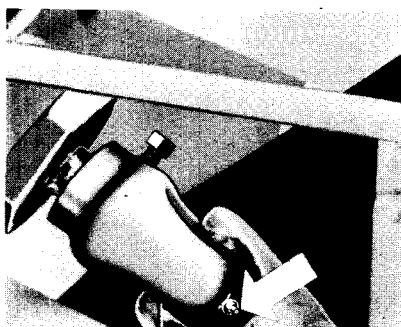

HYDRAULIC HOIST UNIVERSAL—CG

Five fittings, RH side. Pressure gun. Apply lubricant until new grease shows inside yokes.

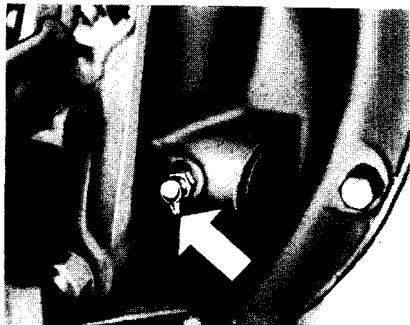

CLUTCH THROWOUT SHAFT—CG

One fitting each side. Pressure gun. Apply lubricant until new grease shows at each end.

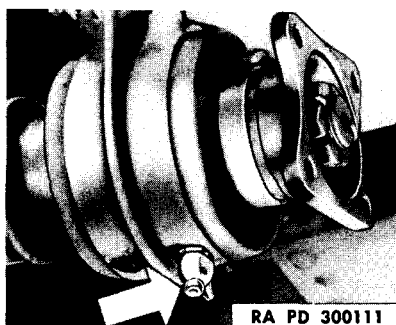

PROPELLER SHAFT—CENTER BEARING—CG

One fitting on bracket. Pressure gun. Apply lubricant until new grease shows at relief valve.

RA PD 300111

Figure 14—Lubrication Points

LUBRICATION

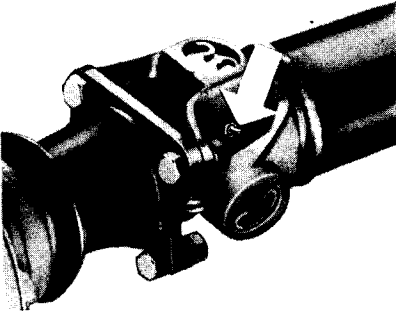

UNIVERSAL JOINT—NEEDLE BEARING—GO

Three fittings. Pressure gun. Apply lubricant until new grease shows at relief valve in center of cross.

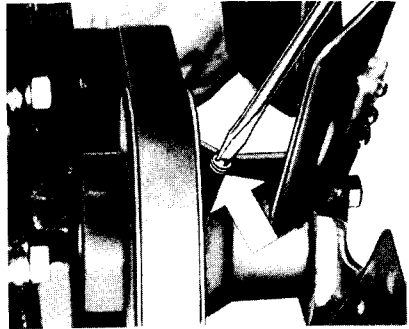

FAN ASSEMBLY—CG

One fitting plug. Pressure gun. Remove plug and install one fitting. Apply two or three shots with gun. Remove fitting and install plug.

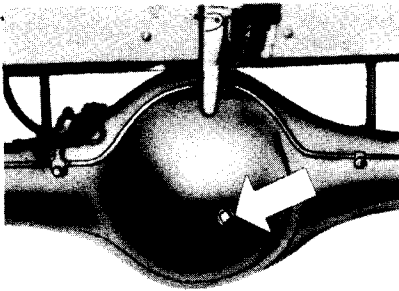

REAR AXLE HOUSING—GO

Filler plug. Pump gun. Remove filler plug. Apply lubricant with pump gun until lubricant fills to one-half inch below plug level.

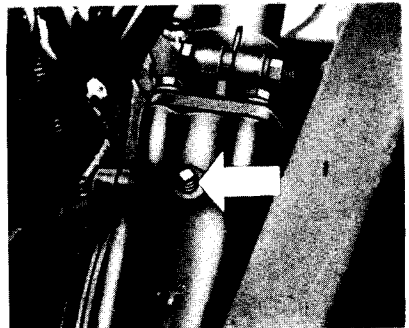

STEERING GEAR—GO

Filler plug. Pump gun. Remove plug and apply lubricant. Fill to plug level. Install plug.

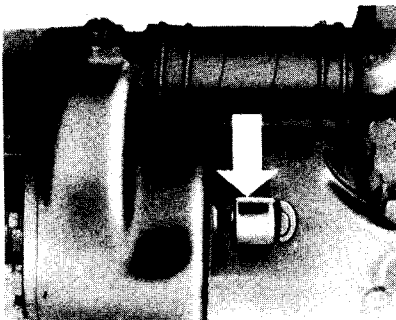

WATER PUMP—WP

One grease cup. Turn down cup daily. Refill cup and turn down as required.

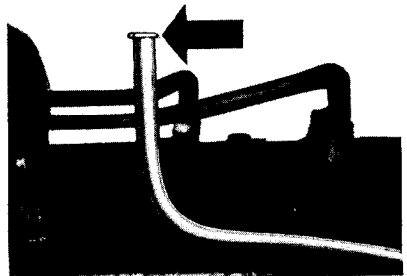

CLUTCH RELEASE BEARING—OE

Filler tube at rearmost cylinder head. Oil can. Apply six drops of engine oil.

RA PD 300112

Figure 15—Lubrication Points

2½-TON 4 x 2 TRUCK (FEDERAL)

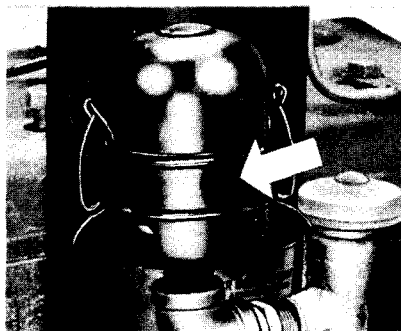

CRANKCASE BREATHER—OE

Remove bowl and element. Wash element and bowl in dry cleaning solvent. Dry element and dip in fresh engine oil. Fill bowl to level with fresh engine oil. Assemble bowl and element and install on base.

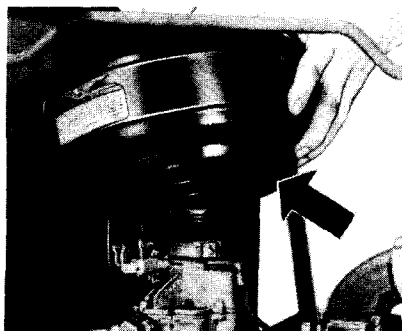

AIR CLEANER—OE

Remove bowl and element. Wash bowl and element in dry cleaning solvent. Dry element and dip in fresh engine oil. Fill bowl to level mark, assemble with element and install in place.

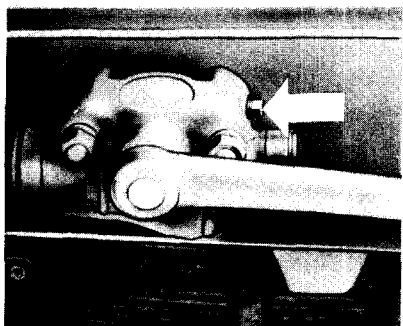

SHOCK ABSORBERS—SA

Filler plug. Fluid gun. Remove plug. Fill to filler plug level. Install plug.

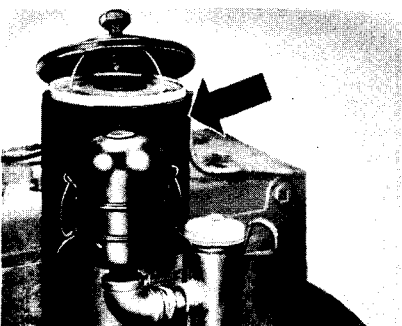

OIL FILTER—OE

Remove drain plug and cover screw. Remove cover and lift out element. Install plug. Install new element. Install cover and screw. Replenish engine oil in crankcase up to "FULL" mark on dip stick.

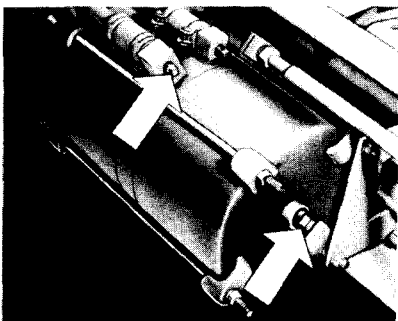

HYDROVAC CYLINDER—OH

2 pipe plugs. Oil can. Remove 2 plugs. Fill ½ oz. each opening. Install plugs.

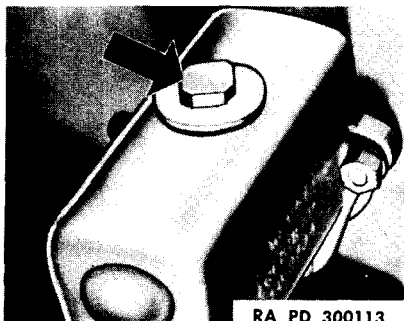

RA PD 300113

BRAKE MASTER CYLINDER—HB

Filler plug. Fluid gun. Remove plug. Fill to plug level. Install plug.

Figure 16—Lubrication Points

Section VII

TOOLS AND EQUIPMENT STOWAGE ON THE VEHICLE

	Paragraph
Tools	21
Equipment	22

21. TOOLS.

Tool	Number Carried	Mfr's Number	Federal Stock Number	Where Carried
BAG, tool envelope...	1	16A4364		Tool compartment
HANDLE, wheel nut socket wrench, 30-in.	1	16A7258		Tool compartment
HANDLE, wheel bearing wrench, 5/8-in. diam.	1	16A7113		Tool compartment
HAMMER, ball peen, 16-oz.	1	16A5006	41-H-523	Tool bag
JACK, hydraulic, with handle, 5-ton	1	16C8409	41-J-73	Tool compartment
PLIERS, slip joint, wire cutting, 6-in....	1	16A1566	41-P-1650	Tool bag
SCREWDRIVER, heavy duty, 6-in....	1	16A1956	41-S-1076	Tool bag
WRENCH, adjustable, crescent, 12-in.	1	16A1917	41-W-488	Tool bag
WRENCH, adjustable, 15-in.	1	16A1918	41-W-450	Tool bag
WRENCH, open end, 15°, 3/8-in. x 7/16-in.	1	16A1921	41-W-991	Tool bag
WRENCH, open end, 15°, 1/2-in. x 19/32-in.	1	16A1563	41-W-1003	Tool bag
WRENCH, open end, 15°, 9/16-in. x 11/16-in.	1	16A1922	41-W-1005-5	Tool bag
WRENCH, open end, 15°, 5/8-in. x 25/32-in.	1	16A1923	41-W-1008-10	Tool bag
WRENCH, open end, 15°, 3/4-in. x 7/8-in.	1	16A1924	41-W-1012-5	Tool bag
WRENCH, rear wheel bearing nut	1	16B7065		Tool compartment
WRENCH, spark plug, with handle	1	16A7281	41-W-3335-30	Tool bag
WRENCH, wheel nut socket	1	16C2261		Tool compartment
WRENCH, water pump packing nut	1	16A1569		Tool bag

22. EQUIPMENT.

GUIDE, Lubrication ..	1	Glove compartment
BOOK, Operator's Manual, TM 9-821..	1	Glove compartment
BOOK, parts, SNL G-539	1	Glove compartment

2½-TON 4 x 2 TRUCK (FEDERAL)

Tool	Number Carried	Mfr's Number	Federal Stock Number	Where Carried
BATTERY, storage...	1	16D7108		Carrier, LH front fender
CRANK, starting	1	1C7097		Tool compartment
CHAINS, dual tire, 9.25/20	2	16A1926	8-C-1600	Tool compartment
CAN, oil, ¾-pint	1	16A3300		On dash, RH side
DECONTAMINATOR	1			Cab, LH side
EXTINGUISHER, fire, 1-qt	1	16C7063	58-E-202	In cab, RH side
GAGE, tire pressure...	1	16A3874	8-G-615	Tool bag
GUN, grease, hydraulic, 1-lb	1	16C7101	41-G-1344-40	Tool compartment
KEYS, padlock	2	15A7223		Tied to steering wheel
LOCK, tool box, long shackle w/chain	1	16A3835		Bolted to tool box
LOCK, spare tire, long shackle w/chain	1	16A3835		Bolted to carrier
MIRROR, outside rear view	2	56D2467C		Top door hinge
MIRROR, inside rear view	1	56D2001B		Cab, center front
PUMP, tire, hand.....	1	16B8428	8-P-5000	Tool compartment
TIRE, tube and spare wheel, 8.25/20	1	17C7028		In carrier
WIPERS, windshield..	2	56D2516D		Over windshield

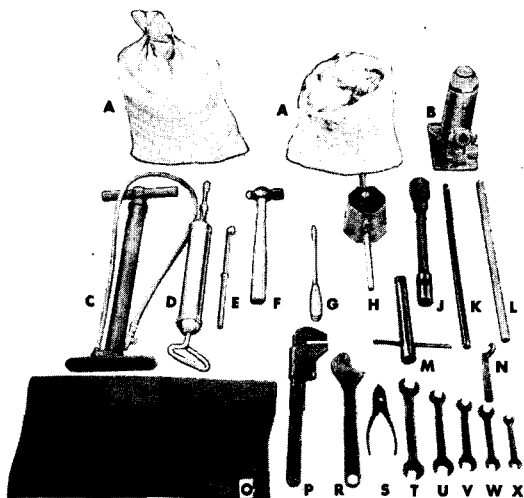

RA PD 300094

A-DUAL TIRE CHAINS 8.25x20
B-HYDRAULIC JACK-5-TON
C-HAND TIRE PUMP
D-GREASE GUN
E-TIRE PRESSURE GAGE
F-BALL PEEN HAMMER-16-OZ.
G-SCREWDRIVER-6-INCH BLADE
H-WHEEL BEARING NUT WRENCH

J-WHEEL NUT WRENCH
K-HYDRAULIC JACK HANDLE
L-WHEEL NUT WRENCH HANDLE
M-SPARK PLUG WRENCH
N-WATER PUMP PACKING NUT WRENCH
O-TOOL BAG ENVELOPE
P-ADJUSTABLE WRENCH-15-INCH
(AUTO-TYPE)

R-ALLOY ADJUSTABLE WRENCH-
12-INCH
S-PLIERS-6-INCH
T-15° OPEN-END WRENCH ¾-1½-IN.
U-15° OPEN-END WRENCH ¾-2½-IN.
V-15° OPEN-END WRENCH 1½-1½-1½-IN.
W-15° OPEN-END WRENCH 1½-1½-1½-IN.
X-15° OPEN-END WRENCH 1½-1½-1½-IN.

Figure 17-Vehicle Tools

PART TWO—VEHICLE MAINTENANCE INSTRUCTIONS

Section VIII

MAINTENANCE ALLOCATION

	Paragraph
Scope	23
Allocation of maintenance	24

23. SCOPE.

a. The scope of maintenance and repair by the crew and other units of the using arms is determined by the availability of suitable tools, availability of necessary parts, capabilities of the mechanics, time available, and the tactical situation. All of these are variable and no exact system of procedure can be prescribed.

24. ALLOCATION OF MAINTENANCE.

a. Indicated below are the maintenance duties for which tools and parts have been provided for the using arm and maintenance personnel. Replacements and repairs which are the responsibility of ordnance maintenance personnel may be performed by using arm personnel when circumstances permit, within the discretion of the commander concerned. Echelons and words as used in this list of maintenance allocations are defined as follows:

FIRST AND SECOND ECHELON: Table III AR 850-15	Operating organization driver, operator or crew, companies and detachments, battalions, squadrons, regiments, and separate companies and detachments (first and second echelons, respectively).
THIRD ECHELON: Table III AR 850-15	Technical light and medium maintenance units, including Post and Port Shops.
FOURTH ECHELON: Table III AR 850-15	Technical heavy maintenance and field depot units including designated post and service command shops.
FIFTH ECHELON: Table III AR 850-15	Technical base units.
SERVICE: (Including preventive maintenance) par. 24 a (2) and (3) in part. AR 850-15	Checking and replenishing fuel, oil, grease, water and antifreeze, air, and battery liquid; checking and tightening nuts and bolts; cleaning.
REPLACE: Par. 24 a (5) AR 850-15	To remove an unserviceable part, assembly, or subassembly from a vehicle and replace it with a serviceable one.

2½-TON 4 x 2 TRUCK (FEDERAL)**REPAIR:**

Par. 24 a (6) in part
AR 850-15

To restore to a serviceable condition, such parts, assemblies or subassemblies as can be accomplished without completely disassembling the assembly or subassembly, and where heavy riveting, or precision machining, fitting, balancing, or alining are not required.

REBUILD:

Par. 24 a (6)
AR 850-15

Consists of stripping and completely reconditioning and replacing in serviceable condition any vehicle or unserviceable part, subassembly, or assembly of the vehicle, including welding, riveting, machining, fitting, alining, balancing, assembling, and testing.

RECLAMATION:

AR 850-15
Par. 4 (c) in part, CIR 75,
dated 16 March '43

Salvage of serviceable or economically repairable units and parts removed from vehicles, and their return to stock. This includes the process which recovers and/or reclaims unusable articles or component parts thereof and places them in a serviceable condition.

b. Maintenance Allocation Chart.**ECHELONS**

2nd 3rd 4th 5th

ABSORBERS, SHOCK AND LINKAGE

Absorbers, shock and linkage, assembly—replace . . .	X			
Absorbers, shock and linkage, assembly—repair . . .		X		
Absorbers, shock and linkage, assembly—rebuild . . .			E	X

AXLE, FRONT

Arm, steering knuckle—replace	X			
*Axle assembly—replace	*	X		
Axle assembly—repair		X		
Axle assembly—rebuild			E	X
Bearing, wheel—service (adjust) and replace	X			

- NOTES:** (1) Operations allocated will normally be performed in the echelon indicated by X.
- (2) Operations allocated to third echelon as indicated by E may be performed by these units in emergencies only.
- (3) Operations allocated to the fourth echelon by E are normally fifth echelon operations. They will not be performed by the fourth echelon, unless the unit is expressly authorized to do so by the chief of the service concerned.
- (4) Consult reclamation bulletins for detailed information relative to reclamation procedure.

*The second echelon is authorized to remove and reinstall items marked by an asterisk. However, when it is necessary to replace an item marked by an asterisk with a new or rebuilt part, subassembly or unit assembly, the assembly marked by an asterisk may be removed from the vehicle by the second echelon *only after authority has been obtained from a higher echelon of maintenance.*

MAINTENANCE ALLOCATION

ECHELONS

2nd 3rd 4th 5th

AXLE, FRONT (Cont'd)

Hub and drum assembly—replace	X			
Hub and drum assembly—rebuild			X	
Retainer, grease, wheel—replace	X			
Rod, tie, assembly—replace	X			
Rod, tie, assembly—repair		X		
Spindle assembly—replace	X			
Spindle assembly—repair		X		
Spindle assembly—rebuild			X	
Stop, steering knuckle—adjust and replace		X		
Wheel alinement, toe-in—service (adjust)	X			
Wheel alinement, camber and caster—service (check)		X		
Wheel alinement, camber and caster—aline			E	X

AXLE, REAR

*Axle assembly—replace	*	X		
Axle assembly—repair		X		
Axle assembly—rebuild			E	X
Bearing, wheel—service (adjust) and replace	X			
Drum, brake—replace	X			
Gear, bevel and pinion—adjust		X		
Retainer, grease, wheel—replace	X			
Shaft, axle—replace	X			

BODY

Body assembly—repair		X		
Body assembly—replace			X	
Body assembly—rebuild			E	X

BRAKE (HAND)

Band assembly—service (adjust) and replace	X			
Band assembly—repair (reline)		X		
Controls—replace	X			
Controls—repair		X		

BRAKES, SERVICE (FOOT)

Brakes—service (adjust)	X			
Cylinder, master, assembly—replace	X			
Cylinder, master, assembly—repair		X		
Cylinder, master, assembly—rebuild			X	
Cylinder, wheel, assembly—replace	X			
Cylinder, wheel, assembly—repair		X		

*The second echelon is authorized to remove and reinstall items marked by an asterisk. However, when it is necessary to replace an item marked by an asterisk with a new or rebuilt part, subassembly or unit assembly, the assembly marked by an asterisk may be removed from the vehicle by the second echelon *only after authority has been obtained from a higher echelon of maintenance.*

2½-TON 4 x 2 TRUCK (FEDERAL)

ECHELONS

2nd 3rd 4th 5th

BRAKES, SERVICE (FOOT) (Cont'd)

Cylinder, wheel, assembly—rebuild			X	
Cylinder, power (hydrovac) assembly—replace	X			
Cylinder, power (hydrovac) assembly—repair		X		
Cylinder, power (hydrovac) assembly—rebuild			X	
Hose, flexible—replace	X			
Lines and connections—replace or repair	X			
Shoe assembly—replace	X			
Shoe assembly—repair (reline)		X		

CAB

Cab assembly—repair		X		
Cab assembly—replace			X	
Cab assembly—rebuild			E	X
Cushion, seat—replace	X			
Cushion, seat—rebuild			X	
Door assembly—replace or repair		X		
Glass—replace		X		
Upholstery—replace			X	
Windshield assembly—replace	X			
Windshield assembly—repair		X		
Wiper, windshield, assembly—replace	X			
Wiper, windshield, assembly—repair		X		
Wiper, windshield, assembly—rebuild			X	

CASE, POWER TAKE-OFF

Case, power take-off, assembly—replace or repair		X		
Case, power take-off, assembly—rebuild			E	X
Controls and linkage—replace	X			
Controls and linkage—repair		X		

CLUTCH

Clutch—replace—repair		X		
Clutch—rebuild			E	X
Pedal, free travel—service (adjust)	X			

COOLING SYSTEM

Connections, radiator to engine—service and replace. X				
Cooling system, service (clean and flush)	X			
Radiator assembly—replace	X			
Radiator assembly—repair		X		
Radiator assembly—rebuild			X	

ELECTRICAL SYSTEM

Battery—service, recharge or replace	X			
Battery—repair		X		
Battery—rebuild			E	X

MAINTENANCE ALLOCATION

ECHELONS

2nd 3rd 4th 5th

ELECTRICAL SYSTEM (Cont'd)

Cables, battery—replace—repair	X			
Coil, ignition—replace	X			
Generator control—replace	X			
Generator control—service and repair		X		
Generator control—rebuild			X	
Horn, replace	X			
Horn, repair		X		
Lamps (all)—service and replace	X			
Lamps (all)—repair		X		
Switches (all)—replace	X			
Switches (all)—repair		X		
Wiring—replace	X			

ENGINE

Bearings, connecting rod (inserts)—replace		E	E	X
Bearings, crankshaft (inserts)—replace		E	E	X
Belt, fan—service (adjust) and replace	X			
Block, cylinder—rebuild (recondition)			E	X
Carburetor assembly—service (adjust) and replace ..	X			
Carburetor assembly—repair		X		
Carburetor assembly—rebuild			X	
Cleaner, air—service (clean) and replace	X			
Cleaner, air—repair		X		
Condenser, distributor—replace	X			
Controls and linkage—replace	X			
Controls and linkage—repair		X		
Cover and gasket—valve chamber—replace	X			
Crankshaft—rebuild (recondition)			E	X
Distributor assembly—replace	X			
Distributor assembly—repair		X		
Distributor assembly—rebuild			X	
*Engine assembly—replace	*	X		
Engine assembly—repair		X		
Engine assembly—rebuild			E	X
Fan and hub assembly—replace	X			
Fan and hub assembly—repair		X		
Filter, oil, assembly—service (clean) and replace ...	X			
Flywheel—replace or repair		X		
Flywheel—rebuild (recondition)			E	X
Gaskets, cylinder head, manifolds, and oil pan— replace	X			

*The second echelon is authorized to remove and reinstall items marked by an asterisk. However, when it is necessary to replace an item marked by an asterisk with a new or rebuilt part, subassembly or unit assembly, the assembly marked by an asterisk may be removed from the vehicle by the second echelon only after authority has been obtained from a higher echelon of maintenance.

2½-TON 4 x 2 TRUCK (FEDERAL)

	ECHELONS			
	2nd	3rd	4th	5th
ENGINE (Cont'd)				
Gears, timing—replace		X		
Generator assembly—replace	X			
Generator assembly—repair		X		
Generator assembly—rebuild			X	
Governor assembly—replace		X		
Governor assembly—rebuild			E	X
Guide, valve—replace		E	E	X
Head, cylinder—replace or repair		X		
Housing, bell—replace		X		
Housing, bell—rebuild			X	
Lifter, valve—replace			E	X
Lines and connections, oil (external)—replace	X			
Lines and connections, oil (external)—repair		X		
Lines and connections, oil (internal)—replace or repair		X		
Manifolds—replace	X			
Manifolds—rebuild			X	
Motor, starting, assembly—replace	X			
Motor, starting, assembly—repair		X		
Motor, starting, assembly—rebuild			X	
Pan, oil, assembly—service (clean)	X			
Pan, oil, assembly—repair or replace		X		
Pistons and rings—replace		E	E	X
Plugs, spark—replace	X			
Plugs, spark (two-piece)—repair		X		
Points, breaker, distributor—replace	X			
Pump, fuel, assembly—service (clean) and replace ...	X			
Pump, fuel, assembly—repair		X		
Pump, fuel, assembly—rebuild			X	
Pump, oil, assembly—replace—repair		X		
Pump, oil, assembly—rebuild			X	
Pump, water, assembly—replace	X			
Pump, water, assembly—repair		X		
Pump, water, assembly—rebuild			X	
Rod, connecting—replace		E	E	X
Seat, valve—repair		X		
Thermostat—replace	X			
Valve clearance—service (adjust)	X			
Valve—replace or repair		X		
Ventilator, crankcase—service (clean) and replace ...	X			
Wiring, ignition—replace	X			

EXHAUST

Muffler and exhaust pipe—replace X

MAINTENANCE ALLOCATION

ECHELONS

2nd 3rd 4th 5th

EXTINGUISHER, FIRE

Extinguisher, fire (carbon tetrachloride CCl_4)— service (refill) and replace	X			
Extinguisher, fire (carbon tetrachloride CCl_4)— repair		X		
Extinguisher, fire (carbon tetrachloride CCl_4)— rebuild			E	X

FRAME

Bumper—replace	X			
Bumper—repair		X		
Frame assembly—repair		X		
Frame assembly—rebuild			E	X
Hooks, towing—replace	X			
Pintle assembly—replace	X			
Pintle assembly—repair		X		

FUEL SYSTEM

Filter, fuel—service (clean) and replace	X			
Lines and connections—replace	X			
Lines and connections—repair		X		
Tank—service (clean) and replace	X			
Tank—repair		X		

HOIST, HYDRAULIC

Controls and linkage—replace	X			
Controls and linkage—repair		X		
Cylinder assembly—replace	X			
Cylinder assembly—repair		X		
Cylinder assembly—rebuild			X	
Hoist assembly—replace	X			
Hoist assembly—repair		X		
Hoist assembly—rebuild			E	X
Pump assembly—replace	X			
Pump assembly—repair		X		
Pump assembly—rebuild			E	X

INSTRUMENTS AND GAGES

Instruments and gages—replace	X			
Instruments and gages—repair		X		
Instruments and gages—rebuild			E	X

METAL, SHEET

Boards, running—replace	X			
Boards, running—repair		X		
Fenders—replace	X			
Fenders—repair		X		

2½-TON 4 x 2 TRUCK (FEDERAL)

	ECHELONS			
	2nd	3rd	4th	5th
METAL, SHEET (Cont'd)				
Hood assembly—replace	X			
Hood assembly—repair		X		
Pan, splash—replace	X			
Pan, splash—repair		X		
MISCELLANEOUS				
Chains, tire—repair	X			
Shaft, flexible drive, speedometer, assembly—replace	X			
Shaft, flexible drive, speedometer, assembly—repair		X		
SHAFT, PROPELLER				
Bearing, midship, shaft—replace	X			
Shaft assembly w/universal joints—replace	X			
Shaft assembly w/universal joints—repair		X		
Shaft assembly w/universal joints—rebuild			E	X
SPRINGS				
Shackle and bolt—replace	X			
Springs—replace	X			
Springs—repair		X		
Springs—rebuild			E	X
STEERING SYSTEM				
Arm (pitman)—replace	X			
Gear assembly—replace—repair		X		
Gear assembly—rebuild			E	X
Link, drag, assembly—replace	X			
Link, drag, assembly—repair		X		
TIRES				
Casings and tubes—replace	X			
Casings—repair			E	X
Tubes, inner—repair	X			
TRANSMISSION				
*Transmission assembly—replace	*	X		
Transmission assembly—repair		X		
Transmission assembly—rebuild			E	X
VEHICLE ASSEMBLY				
Truck, dump—service	X			
Truck, dump—rebuild (with serviceable unit assemblies)			X	E
WHEELS				
Wheels—replace	X			
Wheels—rebuild			E	X

*The second echelon is authorized to remove and reinstall items marked by an asterisk. However, when it is necessary to replace an item marked by an asterisk with a new or rebuilt part, subassembly or unit assembly, the assembly marked by an asterisk may be removed from the vehicle by the second echelon *only after authority has been obtained from a higher echelon of maintenance.*

Section IX

SECOND ECHELON PREVENTIVE MAINTENANCE

Paragraph

Second echelon preventive maintenance service 25

25. SECOND ECHELON PREVENTIVE MAINTENANCE SERVICE.

a. Regular scheduled maintenance inspections and services are a preventive maintenance function of the using arm, and are the responsibility of commanders of operating organizations.

(1) **FREQUENCY.** The frequencies of the preventive maintenance services outlined herein are considered a minimum requirement for normal operation of vehicles. Under unusual operating conditions such as extreme temperatures, dusty or sandy terrain, it may be necessary to perform certain maintenance services more frequently.

(2) **FIRST ECHELON PARTICIPATION.** The drivers should accompany their vehicles and assist the mechanics while periodic second echelon preventive maintenance services are performed. Ordinarily the driver should present the vehicle for a scheduled preventive maintenance service in a reasonably clean condition: that is, it should be dry and not caked with mud or grease to such an extent that inspection and servicing will be seriously hampered. However, the vehicle should not be washed or wiped thoroughly clean, since certain types of defects, such as cracks, leaks, and loose or shifted parts or assemblies are more evident if the surfaces are slightly soiled or dusty.

(3) If instructions other than those contained in the General Procedures (step h) or the Specific Procedures (step f) which follow, are required for the correct performance of a preventive maintenance service, or for correction of a deficiency, other sections of the vehicle operator's manual pertaining to the item involved, or a designated individual in authority, should be consulted.

b. General Procedures. These general procedures are basic instructions which are to be followed when performing the services on the items listed in the specific procedures. *NOTE: The second echelon personnel must be thoroughly trained in these procedures so that they will apply them automatically.*

(1) When new or overhauled subassemblies are installed to correct deficiencies, care should be taken to see that they are clean, correctly installed, and properly lubricated and adjusted.

(2) When installing new lubricant retainer seals, a coating of the lubricant should be wiped over the sealing surface of the lip of the seal. When the new seal is a leather seal, it should be soaked in SAE 10 engine oil (warm if practicable) for at least 30 minutes. Then, the leather lip should be worked carefully by hand before installing the seal. The lip must not be scratched or marred.

2½-TON 4 x 2 TRUCK (FEDERAL)

(3) The general inspection of each item applies also to any supporting member or connection, and usually includes a check to see whether the item is in good condition, correctly assembled, secure, or excessively worn. Mechanics must be thoroughly trained in the following explanations of these terms.

(a) The inspection for "good condition" is usually an external visual inspection to determine whether the unit is damaged beyond safe or serviceable limits. The term "good condition" is explained further by the following: not bent or twisted, not chafed or burned, not broken or cracked, not bare or frayed, not dented or collapsed, not torn or cut.

(b) The inspection of a unit to see that it is "correctly assembled" is usually an external visual inspection to see whether it is in its normal assembled position in the vehicle.

(c) The inspection of a unit to determine if it is "secure" is usually an external visual examination, a hand-feel, a wrench or pry-bar check for looseness. Such an inspection should include any brackets, lock washers, lock nuts, locking wires, or cotter pins used in assembly.

(d) "Excessively worn" will be understood to mean worn, close to or beyond serviceable limits, and likely to result in a failure if not replaced before the next scheduled inspection.

c. **Special Services.** These services are indicated by repeating the item numbers in the columns which show the interval at which the services are to be performed, and show that the parts or assemblies are to receive certain mandatory services. For example, an item number in one or both columns opposite a **TIGHTEN** procedure, means that the actual tightening of the object must be performed. The special services include:

(1) **ADJUST.** Make all necessary adjustments in accordance with the pertinent section of the vehicle operator's manual, special bulletins, or other current directives.

(2) **CLEAN.** Clean units of the vehicle with dry-cleaning solvent to remove excess lubricant, dirt, and other foreign material. After the parts are cleaned, rinse them in clean fluid and dry them thoroughly. Take care to keep the parts clean until reassembled, and be certain to keep dry-cleaning fluid away from rubber or other material which it will damage. Clean the protective grease coating from new parts since this material is not a good lubricant.

(3) **SPECIAL LUBRICATION.** This applies both to lubrication operations that do not appear on the vehicle lubrication chart and to items that do appear on such charts but should be performed in connection with the maintenance operations if parts have to be disassembled for inspection or service.

(4) **SERVE.** This usually consists of performing special operations,

SECOND ECHELON PREVENTIVE MAINTENANCE

such as replenishing battery water, draining and refilling units with oil, and changing or cleaning the oil filter or cartridge.

(5) **TIGHTEN.** All tightening operations should be performed with sufficient wrench-torque (force on the wrench handle) to tighten the unit according to good mechanical practice. Use torque-indicating wrench where specified. Do not overtighten, as this may strip threads or cause distortion. Tightening will always be understood to include the correct installation of lock washers, lock nuts, and cotter pins provided to secure the tightening.

d. When conditions make it difficult to perform the complete preventive maintenance procedures at one time, they can sometimes be handled in sections, but all operations should be completed within the week if possible. All available time at halts and in bivouac areas must be utilized if necessary to assure that maintenance operations are completed. When limited by the tactical situation, items with special services in the columns should be given first consideration.

e. The numbers of the preventive maintenance procedures that follow are identical with those outlined on W.D. AGO Form No. 461, which is the Preventive Maintenance Service Work Sheet for Wheeled and Half-track Vehicles. Certain items on the work sheet that do not apply to this vehicle are not included in the procedures in this manual. In general, the numerical sequence of items on the work sheet is followed in the manual procedures, but in some instances there is deviation for conservation of the mechanic's time and effort.

f. **Specific Procedures.** The procedures for performing each item in the 1000-mile (monthly) and 6000-mile (6-month) maintenance procedures are described in the following chart. Each page of the chart has two columns at its left edge corresponding to the 6000-mile and the 1000-mile maintenance respectively. Very often it will be found that a particular procedure does not apply to both scheduled maintenances. In order to determine which procedure to follow, look down the column corresponding to the maintenance due, and wherever an item number appears, perform the operations indicated opposite the number.

MAINTENANCE	
6000-Mile (6-Month)	1000-Mile (Monthly)
1	1

ROAD TEST

NOTE: When the tactical situation does not permit a full road test, perform those items which require little or no movement of the vehicle. When a road test is possible, it should be for preferably 5, and not over 10 miles.

Before-operation Service. Perform the Before-operation Service (par. 15) as a check to determine whether the vehicle is in a satisfactory condition to safely make the road test and to be sure the supply of fuel, oil, and coolant is adequate.

2½-TON 4 x 2 TRUCK (FEDERAL)

MAINTENANCE	
6000-Mile (6-Month)	1000-Mile (Monthly)
3	3
4	4
5	5
6	6

Instruments and Gages. Observe the readings of all instruments frequently during operation to see whether they are indicating properly. Do not move vehicle until gage indicates at least 135°F.

FUEL GAGE. Gage must register approximate amount in tank.

OIL PRESSURE GAGE. This gage must register 10 pounds at idle speed, to 20 to 30 pounds at running speeds.

SPEEDOMETER. Speedometer must show speed, accumulating trip, and total mileage.

TEMPERATURE GAGE. Gage should register normal operating temperature of 160° to 185°F.

AMMETER. Should show zero reading with lights on and engine at idle speed if battery is fully charged, a zero or slight positive (+) charge with lights off. High positive (+) charge may be indicated after starting engine until generator restores to battery current used in starting. High charge may be indicated for a longer period if battery is low, or electrical load heavy.

Horn, Mirrors, and Windshield Wipers. When tactical situation permits, test horn. Aim, clean, and secure rear vision mirrors. Operate windshield wipers. Tighten, adjust arms, and replace blades if faulty.

Brakes (Foot and Hand). Make first brake check from low speed when starting road test. Continue tests as other stops are made.

FOOT BRAKES. Foot brakes must stop the vehicle safely at a fast rate, within a reasonable distance, and operate effectively. Brake pedal must have moderate but not hard nor spongy feel. Front brakes must not pull the vehicle to one side. Listen for any objectionable noise or chatter. Pedal to floor board clearance, with brake in applied position, must be at least 1 inch.

HAND BRAKES. When set, hand brakes must hold vehicle effectively on grade. Half the ratchet travel should be reserve.

Clutch. Test clutch for grabbing, dragging, chatter, or noise that might indicate faulty adjustment, defective clutch parts, or dry release bearing. Pedal should have free travel of ¾ to 1½ inch before meeting resistance.

SECOND ECHELON PREVENTIVE MAINTENANCE

MAINTENANCE	
6000-Mile (6-Month)	1000-Mile (Monthly)
7	7
8	8
9	9
10	10
11	11
12	12

While running at low speed in high gear, depress accelerator fully, at same time apply brakes slightly, and observe if clutch slips.

Transmission. With vehicle in motion, shift through the entire gear range of transmission and see that shifter mechanism operates freely without clashing or jumping out of gear, whether there are any unusual vibrations that might indicate loose mountings, and whether there is any unusual noise.

Steering. With the vehicle in motion, move steering wheel fully in both directions and observe whether there is any indication of looseness or binding. Test for any tendency to wander, shimmy, or pull to one side while vehicle is operated at normal speeds. Steering column and steering wheel must be in good condition and secure.

Engine. During the road test note any tendency of the engine to stall while decelerating to shift gears. With the vehicle stopped, observe whether engine will run smoothly at normal idling speed. Observe if engine has normal acceleration, pulling power, and operating characteristics in each speed when shifting through the gear range from first to high. Make a similar observation in high gear from low speed with wide-open throttle. During this operation, note any unusual engine noise such as excessive ping, which may indicate early timing or too low octane fuel. Listen for other noises that might indicate damaged, excessively worn, or inadequately lubricated engine parts or accessories, or loose drive belt. With vehicle in second gear, slowly depress the accelerator to toeboard and by observing speedometer reading, determine if vehicle reaches, but does not exceed, the governed speed specified on the caution plate, 12 miles per hour.

Unusual Noises. Be alert for any unusual noise that may indicate looseness, damage, excessive wear in body, wheels, suspension assemblies, attachments, and equipment.

Brake Booster Operation (Hydrovac). Test brakes to learn whether vacuum power unit assists in application. A quick test is to stop vehicle, with engine running, and listen for air movement in the hydrovac unit air cleaner, while the brake pedal is being operated.

Temperatures. After completing road test run, check the following:

BRAKE DRUMS AND HUBS. Feel all brake drums and wheel hubs cautiously for abnormal temperatures. An

2½-TON 4 x 2 TRUCK (FEDERAL)

MAINTENANCE	
6000-Mile (6-Month)	1000-Mile (Monthly)
14	14
16	16
17	17
18	18
19	19

overheated brake drum or wheel hub is an indication of a dragging brake, or a defective, dry, or improperly adjusted wheel bearing.

REAR AXLE, TRANSMISSION. Cautiously feel rear axle differential carrier and transmission for overheating. If either is excessively hot, for the distance traveled, an abnormal condition in the unit is indicated.

Leaks. Look within engine compartment and under vehicle for indications of fuel, oil, water, and brake fluid leaks. Trace them to their source, and correct or report them.

Gear Oil Level and Leaks. Examine rear axle and transmission for lubricant level and leaks. *NOTE: The safe level range is from the lower edge of the filler hole when hot, to ½ inch below when cold.* When organization lubrication records indicate that a change of oil in these units is due, drain transmission and rear axle housing, and refill with specified lubricant. *CAUTION: Refill promptly after draining to avoid hazard of operating without lubricant.*

MAINTENANCE OPERATIONS**Raise Vehicle—Block Safely**

Unusual Noises (with the engine running).

ENGINE, BELT, AND ACCESSORIES. Accelerate and decelerate engine momentarily and listen for unusual noise that might indicate damaged, loose, or excessively worn engine parts, drive belt or accessories. Locate and correct or report any unusual engine noise heard during road test.

TRANSMISSION, PROPELLER SHAFTS AND U-JOINTS, AXLE AND WHEEL BEARINGS. With transmission in third gear, operate these units at constant, moderate speed by use of the hand throttle, and test for any unusual noise that might indicate damaged, loose, or excessively worn unit parts. Also observe propeller shafts for vibration or run-out, and vibrations in the other units which may indicate looseness or unbalance. Locate, correct, or report to designated authority, any unusual noise noted during road test.

Cylinder Head and Gasket. Check cylinder head for cracks or indications of oil, water, or compression leaks around cap screws and gaskets. *CAUTION: Cylinder heads should not ordinarily be tightened unless there is definite indication of looseness or leaks.*

Valve Mechanism. Inspect valve cover gasket for leaks.

SECOND ECHELON PREVENTIVE MAINTENANCE

MAINTENANCE		
6000 Mile (6-Month)	1000-Mile (Monthly)	
19		Make adjustment only if valves are noisy. See that valve tappets, springs, and locks are in good condition, correctly assembled, and secure.
20	20	ADJUST. Exhaust valve clearance must be 0.010 inch, intake valve clearance, 0.008 inch, hot. Make sure lock nuts are secure.
20		Spark Plugs. Clean and examine insulators to see if they are cracked. Reset electrodes to 0.025 inch.
21		TEST. Test compression before reinstalling plugs (item 21).
21		Compression Test. Test compression. If compression is 90 pounds at normal cranking speed, and does not vary more than 5 pounds, plus or minus, between cylinders, the compression pressure may be considered normal.
22	22	Battery (Cables, Hold-downs, Carrier, Specific Gravity). Examine battery for leaks. Clean and dry exterior, cables, and terminals. Lightly grease terminals and posts. Carefully tighten terminals and hold-down bolts. Test specific gravity and record on W.D. AGO Form No. 461. Reading of 1.225 or less indicates re-charge is necessary. Bring electrolyte level to $\frac{3}{8}$ inch above plates.
22		TEST. Make a high-rate discharge test of the battery. Report if difference in reading between cells is more than 30 percent.
23	23	Crankcase. Inspect the crankcase, valve covers, timing gear cover, and clutch housing for oil leaks, and check oil level. If an oil change is due, or condition of oil indicates a change is necessary, drain crankcase and refill to proper level with specified oil. CAUTION: <i>Be sure to refill immediately to avoid hazard of operating without oil. Do not start engine again until item 24 is completed.</i>
24	24	Oil Filter and Lines. Inspect oil filter and lines for leakage, loose connections, or loose mounting.
24		CLEAN. Remove the filter element. Clean oil filter case and install new filter cartridge.
25	25	Radiator (Mountings, Hose, Cap, and Gasket). Observe radiator for looseness, damage, or leakage. Check coolant for contamination. If antifreeze compound is used, check protective value for temperature encountered. Clean any dirt, insects, and trash from exterior of core.
25		TIGHTEN. Tighten all radiator mountings and hose.
26	26	Water Pump, Fan, and Shroud. Observe water pump for leaks. Test shaft for end play and loose bearings.

2½-TON 4 x 2 TRUCK (FEDERAL)

MAINTENANCE	
6000-Mile (6-Month)	1000-Mile (Monthly)
27	27
27	
29	29
31	31
31	
32	32

Inspect fan blades and shroud for damage.

Generator, Cranking Motor, and Switch. Examine mountings and wiring connections for good condition and security.

REMOVE. Remove inspection covers and see that commutators and brushes are in good condition and not excessively worn; that brushes are free in holders, and brush-connecting wires are secure and not chafing. Dirty commutator must be cleaned with sandpaper (No. 00). Blow out dust with compressed air. Tighten cranking motor mounting cap screws securely.

Drive Belt and Pulleys. Check fan and generator drive belt for good condition, and drive pulleys and hubs for good condition and security. Adjust drive belt to a deflection of ½ inch.

Distributor. Wipe off distributor and external attachments and examine for good condition, correct assembly, security, and serviceability. Inspect for cracks in cap and rotor arm, corrosion of terminals and connections, and burning of the outer ends of conductor strap. Breaker points must be in good condition, alined, and adjusted to 0.020-inch gap. Replace points if burned, pitted, or excessively worn. Inspect shaft for looseness. Test centrifugal advances to see whether or not the camshaft can be rotated by finger force through normal range of movement permitted by centrifugal advance mechanism, and whether it returns when released without binding or sticking.

SERVE. If breaker plate assembly is excessively worn or dirty, remove distributor, clean in dry-cleaning solvent, dry with compressed air, lubricate as specified below, and reinstall in position for timing. When cleaning, remove the wick and lubrication cup. Clean while removed and reinstall only after distributor assembly is cleaned and dried. Lubricate cam surface, movable breaker arm pin, wick, and camshaft with light oil. Adjust breaker point gap to 0.020 inch.

Coil and Wiring. Inspect coil for good condition, cleanliness, and security. Inspect all high-voltage ignition wiring, including shielding or conduits, to see that they are in good condition, and securely fastened at all supports and terminals. See that connections are clean. Inspect all low-voltage wiring in the engine compartment in the same manner.

SECOND ECHELON PREVENTIVE MAINTENANCE

MAINTENANCE		
6000-Mile (6-Month)	1000-Mile (Monthly)	
33	33	Manifolds. Inspect intake and exhaust manifold for good condition and security, and manifold gaskets for leaks.
34	34	Air Cleaner. Inspect carburetor air cleaner for good condition, security, and oil leaks. Make sure base clamp and air cleaner brace are tight. Inspect base of reservoir for cracks. Observe condition of the cleaning element. Clean and recoil element, and fill reservoir to correct level with specified oil.
35	35	Breather Cap and Ventilator. Inspect cap and ventilator to see that they are in good condition, correctly assembled, secure, and that ventilator tube is open. Remove breather element, and clean both element and body in dry-cleaning solvent, dip element in engine oil, and refill reservoir.
36	36	Carburetor (Choke, Throttle, Linkage, and Governor). Inspect to see that these items are in good condition, correctly assembled, secure, that carburetor does not leak, and that governor is properly sealed.
37	37	Fuel Filter and Lines. Inspect fuel filter, sediment bowl, fuel lines and connections to see that they are in good condition, secure, and not leaking. Remove filter bowl and element, and clean in dry-cleaning solvent. Include screen in fuel pump. Reinstall, using new gaskets. After assembling, recheck for leaks.
38	38	Fuel Pump. Inspect fuel pump for good condition, security, and leaks. Attach test gage and with the engine idling, note whether the pump pressure is satisfactory. Normal pressure is 3 pounds.
39	39	Cranking Motor. Start engine, observing whether general action of cranking motor is satisfactory, particularly whether it engages and disengages properly without excessive noise and has adequate cranking speed, and whether engine starts readily.
40	40	Leaks. Check in engine compartment and under the vehicle for engine oil, fuel, brake fluid, and water leaks.
41	41	Ignition Timing. Check and adjust ignition timing by neon-light method. Observe whether centrifugal control advances timing as engine is accelerated gradually.
42	42	Engine Idle and Vacuum Test. Connect a vacuum gage to intake manifold, adjust engine to its normal idle

2½-TON 4 x 2 TRUCK (FEDERAL)

MAINTENANCE	
6000-Mile (6-Month)	1000-Mile (Monthly)
43	43
47	47
48	49

speed by means of throttle stop screw, then adjust the idle-mixture adjusting needle until vacuum gage indicates maximum reading. If this latter adjustment changes idle speed appreciably, reset idle speed and mixture until both are satisfactory.

Regulator Unit. Observe if regulator unit is in good condition and if connections and mountings are secure. Connect low voltage circuit tester and test voltage regulator, current regulator, and cut-out for proper generator output control. Follow the instructions which accompany the test instrument.

CHASSIS, BODY, AND ATTACHMENTS

Tires and Rims. Inspect tires as follows: Inspect valve stems for good condition, correct position, and see that all valve caps are present and secure; test air pressure (60 pounds with tires cold); inspect tires for cuts, bruises, breaks, blisters, and irregular tread wear, watching for any sign of flat spots, cupping, feather edges, and one-sided wear. Any mechanical deficiencies causing such conditions should be determined and corrected, or reported to proper authority. Remove imbedded glass, nails, and stones. The wheel positions of tires with irregular wear should be changed; front tires to rear wheel positions, and vice versa. Directional and nondirectional tires should not be installed on same vehicle. Directional tires should be mounted so that open end of "V" of chevron meets ground first on front wheels and last on rear wheels. With tires properly inflated, inspect for matching according to over-all circumference, permissible variation being $\frac{3}{4}$ inch. Inspect spare tire carrier for good condition and security. See that all rims and their lock rings or flanges are in good condition and secure. Tighten securely.

Brakes, Rear. Inspect and service brakes as follows: remove dirt and grease and inspect to see that they are in good condition, securely mounted, and that drums are not excessively worn or scored. Clean drums and backing plates. Observe if wheel cylinders are in good condition, securely mounted, and not leaking. Tighten drum mounting bolts securely.

Brake Shoes, Rear (Linings, Links, Guides, and Anchors). Inspect linings through inspection holes in brake drums to determine whether they are worn sufficiently so that rivet heads may score drums within next 1000 miles of operation. If vehicle has recently been operated in deep water, mud, loose sand, or dirt which

SECOND ECHELON PREVENTIVE MAINTENANCE

MAINTENANCE		
6000-Mile (6-Month)	1000-Mile (Monthly)	
49		<p>may have entered brake drum, remove right rear hub and drum for inspection of brake linings, to determine whether they should be replaced, and if lubricant has been contaminated. If linings on this wheel brake must be replaced, remove all wheels and service their brakes similarly, being sure to clean, lubricate, and adjust all removed bearings; clean drums, shoes, linings, and backing plates.</p> <p>INSPECT. See that linings are in good condition, secure, in good wearing contact with drums, free of lubricant or brake fluid, and not excessively worn. Also see that brake shoes are in good condition, properly secured and guided by anchor bolts, connecting links, guides, and springs. Also, that they are properly returned by the retracting springs. Clean dust from the linings with a wire brush, clean cloth, or compressed air. After completion, adjust brake shoes by minor-adjustment method, so that linings have proper clearances from brake drums. Where new linings have been installed, adjust shoes by the major-adjustment method. Normal clearance must be 0.006 inch at heel, and 0.012 inch at toe.</p>
52	52	<p>Rear Wheels (Bearings, Seals, Drive Flanges, and Nuts). See that wheels are in good condition, revolve them, and observe if they have excessive run-out. Without removing rear wheels, examine for evidence of looseness in wheel bearing or adjustment. Revolve rear wheels and listen for indications of dry or damaged wheel bearings. Inspect drive flanges and around brake backing plates and drums for lubricant or brake fluid leaks. Check to see that drive flanges and nuts are in good condition and secure.</p>
52		<p>CLEAN. Disassemble bearings and oil seals. Clean thoroughly and inspect bearings to see that they are in good condition. Also see if the machined surfaces upon which the bearings are assembled are in good condition. When bearings are reinstalled, lubricate and adjust them.</p>
53		<p>Brakes, Front (Drums, Backing Plates, and Cylinders). Remove dirt and grease and examine drums and backing plates for good condition and secure mounting; check drums for excessive wear or scoring. Examine wheel cylinders for good condition, secure mounting, and fluid leaks. Tighten drum mounting bolts securely. Examine backing plate for alinement or distortion.</p>
	54	<p>Brake Shoes, Front (Linings, Links, Guides, and Anchors). Examine linings through inspection holes in</p>

2½-TON 4 x 2 TRUCK (FEDERAL)

MAINTENANCE	
6000-Mile (6-Month)	1000-Mile (Monthly)
54	
54	54
55	55
56	56
57	57
57	

brake drums to see whether they are so worn that rivet heads may score drums within next 1000 miles of operation. **NOTE:** *A similar inspection of brake linings should be made if vehicle has recently been operated in deep water, mud, loose sand, or dirt which may have entered brake drum.* If linings on this wheel brake must be replaced, remove all wheels and service their brakes similarly, being sure to clean, lubricate, and adjust all removed bearings, and to adjust brakes.

INSPECT. Check to see that linings are in good condition, tightly secured to brake shoes, in good wearing contact with the drums, free of lubricant or brake fluid, and not excessively worn. Also see that brake shoes are in good condition, properly secured and guided by anchor bolts, connecting links, guides, and springs. Clean all dust from linkage with a wire brush, clean cloth, or compressed air.

ADJUST. After services and inspections of all following items to and including item 60 are completed, adjust brake shoes by minor-adjustment method, so that linings have proper clearances from brake drums. Where new linings have been installed, adjust shoes by major-adjustment method. Normal clearance must be 0.006 inch at heel, and 0.012 inch at toe.

Steering Spindles, Bearings, Bushings and Seals. Examine spindles for good condition. Test bushings and bearings for looseness or excessive wear by jacking up axle and shaking wheel by hand. Inspect seals for excessive leaks.

Front Springs (Clip, Leaves, U-bolts, Hangers, and Shackles). Examine these items to see that they are in good condition, correctly assembled, and secure, and note whether springs have excessive sag. Tighten U-bolts securely.

Steering (Arms, Tie Rod, Drag Link, Seals, Pitman Arm, Gear, Column, and Wheel). Examine to see that these items are in good condition, correctly and securely assembled and mounted, and determine whether steering gear case lubricant is at the proper level, and not leaking. Note if steering gear is in satisfactory adjustment.

TIGHTEN. Tighten pitman arm shaft nut and steering gear case assembly and mounting nuts or screws securely. **CAUTION:** *Loosen the steering column bracket when tightening the steering case mounting nuts, so as not to distort the column.*

SECOND ECHELON PREVENTIVE MAINTENANCE

MAINTENANCE		
5000-Mile (6-Month)	1000-Mile (Monthly)	
58	58	Front Shock Absorbers and Links.
58		SERVE. Fill shock absorber bodies with specified fluid. Work arm several times and add fluid. Repeat operation until all air is dispelled and reservoir is full.
60	60	Front Wheels (Bearings, Seals, and Nuts). Inspect to see that wheels are in good condition, revolve them, and observe if they have excessive run-out. Without removing front wheels, examine for evidence of looseness in wheel bearing or adjustment. Revolve front wheels and listen for indications of dry or damaged wheel bearings. Inspect around brake supports and drums for lubricant or brake fluid leaks. Check to see that wheels and mounting nuts are in good condition, and secure.
60		CLEAN. Disassemble the bearings and oil seals. Clean thoroughly and inspect the bearings to see that they are in good condition, and that the cups are secure. Also examine to see if the machined surfaces upon which the bearings are assembled are in good condition. When bearings are reinstalled, lubricate and adjust.
61	61	Front Axle Alinement. If front axle appears to be out of line, measure distance from front spring front eyebolt to center of axle spring pad on each side. This distance should be about the same on each side.
63	63	Engine Mountings. Inspect engine to see that mountings are in good condition and securely connected. If the mounting bolts are loose, tighten them properly.
64	64	Hand Brake (Ratchet and Pawl, Linkage, Drum, and Lining). Examine to see that hand brake ratchet, pawl, and linkage are in good condition and secure; that brake drum is not scored or oily; and that brake lining is not oil-soaked, nor worn thin.
65	65	Clutch Pedal (Free Travel, Linkage, and Return Spring). Examine clutch to see that pedal free travel is satisfactory, $\frac{3}{4}$ to $1\frac{1}{2}$ inch, that pedal is securely mounted, and that clutch operating linkage is in good condition, secure, and not excessively worn. See that return spring is intact and has sufficient tension.
65		ADJUST. Adjust clutch pedal free travel according to specifications, $\frac{3}{4}$ to $1\frac{1}{2}$ inch.
66	66	Brake Pedal. Brake pedal to floor board clearance, with the pedal in applied position, should be at least 1 inch.

2½-TON 4 x 2 TRUCK (FEDERAL)

MAINTENANCE	
6000-Mile (6-Month)	1000-Mile (Monthly)
67	67
68	68
68	
71	71
71	
73	73
73	
75	75
76	

Inspect brake linkage for damage and excessive wear. See that return spring is intact and has sufficient tension.

Brake Master Cylinder (Vent, Fluid Level, Leaks, and Switch). Examine these items to see that they are in good condition and secure, and that the boot is properly installed. Inspect for fluid leaks. Fill the master cylinder reservoir to correct level, allowing approximately ¼ inch for expansion. Clean vent.

Brake Booster-hydrovac (Linkage, Air Cleaner Hose, and Slave Cylinder). Inspect to see that they are in good condition, securely assembled and mounted; and that operating and control linkage does not bind. Observe whether brake fluid is leaking from the slave cylinder. Clean and oil the air cleaner element.

SPECIAL LUBRICATION. Insert ½ ounce of hydraulic oil in pipe plug opening in rear of rear vacuum cylinder, and in pipe plug opening of center plate elbow.

Transmission (Mounting, Seals, Power Take-off, and Linkage). Inspect transmission case for good condition. Look for oil leaks from seals and gaskets. See that control linkage is in good condition, properly connected, and secure.

TIGHTEN. Tighten all transmission and power take-off mounting and external assembly bolts and cap screws securely.

Propeller Shafts (Joints and Alinement, Seals, and Flanges). Inspect for good condition, and correct and secure assembly. Inspect universal joints for proper alinement and excessive wear. Slip joint should be free, well lubricated, and not excessively worn. Seals of universal joints and slip joint should not leak excessively.

TIGHTEN. Tighten all universal joint assembly and companion flange bolts securely.

Rear Axle (Pinion End Play, Seals, Vent, and Alinement). If rear axle appears to be out of line, measure distance from rear spring eyebolt to center of axle spring pad on either side. This distance should be about the same on each side. Inspect housing for good condition. Look for leaks. Examine pinion shaft for excessive end play and check seal for leaks. Clean axle housing vent thoroughly.

Inspect. Inspect differential mounting cap screws for tightness.

SECOND ECHELON PREVENTIVE MAINTENANCE

MAINTENANCE		
5000-Mile (6-Month)	1000-Mile (Monthly)	
77	77	Rear Springs (Clips, Leaves, U-bolts, Hangers, and Shackles). Examine springs to see that these items are in good condition, correctly assembled, and secure, and note whether springs have excessive sag. Tighten U-bolts securely.
78	78	Rear Shock Absorbers and Links. Examine shock absorber bodies and links for good condition; secure mounting, and fluid leaks.
78		SERVE. Fill shock absorber bodies with specified fluid. Disconnect the link, work the arm several times, and add fluid. Repeat this operation until all air is expelled and the reservoir is full. Check to see that arm action is normal. A double-acting shock absorber should have resistance in both directions.
79	79	Cab and Body Mountings. Check to see that all mounting brackets and bolts are present; tighten securely. The cab mounting bolt with spring should not be over-tightened.
80	80	Frame (Rails and Cross Members). Inspect frame to see that rails and cross members are in good condition, secure, and in apparent alinement.
81	81	Wiring, Conduits, and Grommets. Examine these items underneath vehicle to see that they are in good condition, properly supported, connected, and secure.
82	82	Fuel Tank, Fittings, and Lines. Examine fuel tank for good condition and security. Inspect cap for defective gasket or plugged vent. See that filler neck and cap fit securely. Inspect fuel lines and fittings for good condition, security, and leaks.
83	83	Brake Lines (Fittings, and Hose). Look underneath vehicle and on rear axle housing to see that they are in good condition, and secure, and whether or not they leak.
84	84	Exhaust Pipes and Muffler. Examine exhaust pipes to see that they are securely attached to the exhaust manifold and muffler; make sure that muffler is in good condition and securely mounted. Look for leaks. Examine tail pipe to see that it is securely clamped to the muffler, properly supported, and unobstructed at its outer end.
85	85	Vehicle Lubrication. On any unit where disassembly was necessary for inspection purposes, lubrication must

2½-TON 4 x 2 TRUCK (FEDERAL)

MAINTENANCE	
6000-Mile (6-Month)	1000-Mile (Monthly)
86	86
89	89
90	90

be performed unless the vehicle is to be deadlined for repair of that unit. Lubricate all points of vehicle in accordance with instructions in vehicle maintenance manual, Lubrication Guide, and current lubrication bulletins or directives, and the following instructions: Use only clean lubricant and keep all lubricant containers covered; clean the lubrication fitting or plug before applying lubricant; replace missing or damaged lubrication fittings, flexible lines, vent, or plugs. On all unsealed bushings or joints, the lubricant should be applied until it appears at the openings. On units, provided with lubricating retainer seals, do not force the lubricant beyond the seals. To do so, may cause a failure. Wipe off excess lubricant that may drip onto brakes, rubber parts, soil clothes, or detract from the vehicle's appearance. Parts or assemblies that have already been lubricated while disassembled for inspection, gear cases that have been drained and refilled as mandatory items in the procedures, and those parts that have been indicated in the procedures for special lubrication may be omitted from the general lubrication of the vehicle.

Lower Vehicle to Ground

Toe-in and Turning Stops. With front wheels on ground in straight ahead position, and using proper toe-in gage, see if front wheel toe-in is within specified limits, $\frac{1}{16}$ to $\frac{1}{8}$ inch; and that wheel turning stops are present, secure, and the weld not broken. Turn front wheels in both directions to see that they engage the stops, and if tires clear all parts of vehicle in this position. If there is any indication that turning angle exceeds specified limits, such as scuffing of tires against vehicle, report for a check of turning angle by higher echelon.

Tractor-to-trailer Connections. Inspect connection socket in rear of frame for good condition, and check connections for good condition and secure attachment, if towed load is attached to vehicle.

Hoist (Mounting, Drive, Controls, Pump, Lines, Cylinder). Raise body and examine all units and connections for good condition, secure mounting, and leaks. Note any tendency for body to drop (indicating leak past cylinder piston). **CAUTION: Block body in raised position.** Fill cylinder (par. 176), lubricate fitting and apply few drops of oil on hinge pin points. Lower body and observe for full lowering and alinement with guides.

SECOND ECHELON PREVENTIVE MAINTENANCE

MAINTENANCE		
6000-Mile (6-Month)	1000-Mile (Monthly)	
90		TIGHTEN. Tighten all mounting and assembly bolts securely. Tighten the piston rod packing nut and pump shaft packing nut carefully.
91	91	Lights (Head, Tail, Stop, and Blackout). See that switches and lights operate properly; be sure to inspect stop light operation. See that foot switch controls headlight beams and that they are correctly adjusted. Inspect all lights for good condition, and security. Check for dirty and broken lenses, or discolored reflectors.
91		ADJUST. Adjust headlight beams.
92	92	Safety Reflectors. Clean and inspect reflectors for breakage; make sure they are securely mounted.
93	93	Front Bumpers, Tow Hooks, and Brush Guards. Inspect these items to see that they are in good condition and correctly assembled to brackets.
94	94	Hood (Hinges, and Fasteners). See that hood, hinges, fasteners, and props are in good condition, securely mounted, and properly lubricated.
95	95	Front Fenders and Running Boards. See that fenders and running boards are in good condition and secure.
96	96	Cab (Doors, Hardware, Glass, Seats, Upholstery, Floor Boards, Ventilator, Map Compartment). Inspect these items for good condition, secure attachment, or mounting. See that ventilators, windshield, and hardware operate properly. Make sure doors are properly aligned and latch securely.
98	98	Circuit Breaker. Inspect circuit breaker for good connections.
99	99	Gasoline Tank Splash Guard. See that gasoline tank splash guard is in good condition and secure.
100	100	Body (Floor, Sides, Tail Gate, Locking Devices, Chains). See that these items are in good condition and securely mounted. See that tail gate and controls operate readily.
101	101	Rear Bumpers and Pintle Hook (Latch, Lock Pin, and Drawbar). Make sure that these items are in good condition and secure, that pintle and latch operate properly, are adequately lubricated, and that lock pin is secured with a chain.
103	103	Paint and Markings. Examine paint of entire vehicle for good condition. Repaint bright spots in finish that

2½-TON 4 x 2 TRUCK (FEDERAL)

MAINTENANCE	
6000-Mile (6-Month)	1000-Mile (Monthly)
104	104
131	131
132	132
133	133
134	134
135	135
136	136
141	
142	142

might cause reflection. See that identification plates and vehicle markings are legible.

Radio Bonding (Suppressors, Filters, Condensers, and Shielding). Examine these items to see if their bonding connections are in good condition, clean, and secure; note whether all items are securely mounted. **NOTE:** *Any irregularities, except cleaning and tightening, should be reported through channels to signal corps personnel.*

TOOLS AND EQUIPMENT

Tools. Check all tools against the stowage lists (pars. 21 and 22), to see that they are all present, in good condition, clean, and properly stowed or securely mounted. Any tools mounted on outside of vehicle that have bright or polished surfaces, should be painted or otherwise treated so as not to cause glare or reflection.

Fire Extinguisher. Inspect fire extinguisher to see that it is fully charged, in good condition, securely mounted, and the nozzle clean.

Decontaminator. Inspect decontaminator for good condition, secure mounting, and full charge. **NOTE:** *Contents of decontaminator must be renewed every 90 days, as it deteriorates.* Refer to tag for date of last recharge.

First-aid Kit. Inspect kit for good condition, and presence of all items. Report deficiencies immediately.

Publications and Form No. 26. The vehicle manuals and parts lists, Lubrication Guide, and Standard Accident Form No. 26 should be present, legible, and properly stowed.

Traction Devices (Chains). Inspect chains for good condition, cleanliness, protection against rust, and proper stowage.

Modification (Field Service Modification Work Orders Completed). Organizational vehicle records should be checked to be sure that all Field Service Modification Work Orders pertaining to vehicle have been completed.

Final Road Test. Make final road test, rechecking items 2 to 15 inclusive. Be sure to recheck the transmission and rear axle to see that lubricant is at the correct level and not leaking. Confine road test to minimum distance necessary to make satisfactory observations. Correct or report to designated authority all deficiencies found during final road test.

Section X

ORGANIZATION TOOLS AND EQUIPMENT

Organization tools and equipment	Paragraph 26
--	-----------------

26. ORGANIZATION TOOLS AND EQUIPMENT.

a. In addition to the tools listed in paragraphs 21 and 22, the following are available to the using arms for the maintenance of this vehicle.

b. **Standard Tool Sets.** The tool sets available to individuals (specialists) and organizations, dependent upon the allocation in the Tables of Equipment, are listed in SNL N19. The components of these tool sets are also listed and illustrated.

c. **Special Tool Set.** The following special tools are allocated one each to a Regimental or Battalion Maintenance Platoon:

Item	Manufacturer's No.
Wrench, crowfoot open-end	HM 2255A
Wrench, T-handle socket	HM 2268A
Gage, clutch adjusting	LPE T-2187

2½-TON 4 x 2 TRUCK (FEDERAL)

Section XI

TROUBLE SHOOTING

	Paragraph
Engine	27
Clutch	28
Fuel	29
Intake and exhaust system	30
Cooling system	31
Ignition system	32
Starting and generating systems	33
Transmission	34
Propeller shaft	35
Front axle	36
Rear axle	37
Service and hand brakes	38
Wheels and hubs	39
Springs and shock absorbers	40
Steering	41
Body and frame	42
Hoist	43
Battery and lights	44
Instruments	45
Power take-off	46

27. ENGINE.

a. Lack of Power.

Possible Cause	Possible Remedy
Defective ignition.	Inspect and adjust (par. 84).
Carburetor or fuel pump functioning improperly.	Adjust or replace carburetor (par. 68); clean or replace fuel pump (par. 69).
Fuel filter dirty.	Empty and clean (par. 70).
Air cleaner dirty.	Clean and renew oil (par. 75).
Overheating.	Check cooling system (par. 79).
Engine too cold.	Check thermostat (par. 82).

b. Engine overheating.

Cooling system defective.	Check cooling system (par. 79).
Fuel mixture incorrect.	Adjust or replace carburetor (par. 68).
Ignition system defective.	Check for faulty timing or crossed spark plug cable (par. 84).
Loose or broken fan belt.	Tighten or replace (par. 80).

TROUBLE SHOOTING

c. Excessive Oil Consumption.

Possible Cause	Possible Remedy
Overheating.	Check and adjust ignition timing (par. 84).
Improper grade of oil.	Supply proper grade of oil (par. 20).
Oil level too high.	Reduce to correct level (par. 20).
Oil leaks at gaskets and seals.	Tighten or replace (par. 51).

d. Low Oil Pressure.

Improper grade of oil.	Supply proper grade of oil (par. 20).
Excessive crankcase dilution.	Service crankcase ventilating system more frequently (par. 59).
Oil pump screen clogged.	Clean screen (par. 57).
Relief valve out of adjustment.	Adjust relief valve (par. 57).
Excessive oil pump wear.	Install new pump (par. 57).

e. Popping, Spitting, and Spark Knock.

Ignition system defective.	Check and adjust (par. 84).
Carburetor improperly adjusted.	Adjust or replace (par. 68).
Valve clearances adjusted too closely.	Adjust (par. 53).
Excessive carbon deposits.	Remove carbon (par. 50).
Low octane number fuel.	Use higher octane fuel.
Weak or broken valve springs.	Report to higher authority.

f. Squealing Sound.

Faulty generator.	Check lubrication and belt alignment, or replace generator (par. 94).
Faulty water pump.	Check lubrication, replace packing, or replace pump (par. 78).

g. Loud Knock.

Loose or burned out connecting rod bearings.	Report to higher authority.
Broken piston.	Report to higher authority.
Broken valve.	Report to higher authority.

h. Dull, Heavy Thump.

Loose or burned out main bearings.	Report to higher authority.
------------------------------------	-----------------------------

i. Light Rattling Noise.

No oil in engine.	Stop engine at once. Replenish oil. Search for leaks.
-------------------	---

j. Light Clicking.

Sticking valve.	Report to higher authority.
-----------------	-----------------------------

2½-TON 4 x 2 TRUCK (FEDERAL)

Possible Cause	Possible Remedy
Broken valve spring. Improperly adjusted valve.	Report to higher authority. Adjust (par. 53).
k. Hissing Sound.	
Broken windshield wiper line, or leaking couplings.	Repair or replace line, inspect couplings and tighten or replace (par. 170).
Leaking intake manifold gasket.	Replace gasket (par. 55).

28. CLUTCH.

a. Slipping.	
Facing wear and need for shim adjustment.	Adjust clutch for facing wear and pedal free travel (par. 63).
Weak or broken pressure spring.	Replace clutch (par. 65).
Worn or broken pressure levers.	Replace clutch (par. 65).
Clutch facings worn out or burned.	Replace clutch (pars. 64-65).
Pressure plate drive lugs sticking to flywheel ring slots.	Check clearance between pressure plate drive lugs and flywheel ring (par. 64).
Oil or grease on facings.	Install new driven plate (par. 65).
Improper facings.	Install new driven plate (par. 65).
b. Grabbing.	
Improper adjustment.	Adjust clutch assembly and pedal linkage (par. 63).
Oil or grease on facings.	Install new driven plate (par. 65).
Worn splines in driven plate hub.	Install new driven member assem- bly (par. 65).
c. Improper Release.	
Improper adjustment.	Adjust clutch assembly and pedal linkage (par. 63).
Pressure plate warped.	Replace clutch (par. 65).
Driven plate distorted.	Install new driven plate (par. 65).
Worn or broken pressure levers.	Replace clutch (par. 65).
Weak, stretched, or broken con- trol springs.	Install new springs.
Release bearing noisy.	Install new release bearing and adjust pedal free travel (par. 65).
d. Improper Action of Controls.	
Pedal fails to return.	Install new pull-back spring.
Pedal binds on shaft.	Lubricate or replace (par. 65).

29. FUEL.

a. Excessive Fuel Consumption.	
Dirty air cleaner.	Service air cleaner (par. 75).

TROUBLE SHOOTING

Possible Cause	Possible Remedy
Improper carburetor adjustment.	Adjust or replace (par. 68).
Fuel leaks in fuel lines.	Tighten connections or replace (par. 72).
Fuel leak at carburetor.	Tighten cover to body screws (par. 68).
Fuel leak at fuel pump.	Tighten knurled nut at top of fuel bowl. Replace bowl gasket (par. 69).
Fuel leaks at fuel filter.	Tighten cover bolt at top of filter, or replace gasket (par. 70).
Fuel leak in fuel tank.	Replace tank (par. 71).
Engine not properly timed.	Check timing (par. 84).
Improper engine temperature.	Check cooling system (par. 79).
Vehicle overloaded.	Load to rated capacity (par. 5).
Tires underinflated.	Inflate to 60 pounds.
Carburetor controls frozen.	Free up and lubricate.
Carburetor parts worn.	Replace carburetor (par. 68).
b. Fast Idling.	
Improper throttle control adjustment.	Adjust control linkage (par. 73).
Throttle control frozen.	Free up and lubricate.
Improper or broken accelerator return spring.	Replace spring.
c. Engine Will Not Idle.	
Throttle plate closing too far.	Adjust throttle stop screw (par. 68).
Improper fuel mixture.	Adjust idling screw (par. 68).
Incorrect ignition timing.	Check timing (par. 84) and correct.
Improper valve clearance.	Adjust (par. 53).
d. Low Fuel Pressure.	
Air leaks.	Tighten all fuel line connections (par. 72). Tighten fuel pump bowl (par. 69). Tighten fuel filter cover bolt (par. 70).
Fuel pump inoperative.	Clean or replace (par. 69).
Fuel pump valves leaking.	Replace pump (par. 69).
Fuel pump linkage worn.	Replace pump (par. 69).
Diaphragm defective.	Replace diaphragm (par. 69).
e. Engine "Stumbles" on Acceleration.	
Improper carburetor functioning.	Replace carburetor (par. 68).
Incorrect ignition timing.	Check ignition timing (par. 84).
Incorrect spark plug gap.	Correct (par. 88).
Sticking valves.	Free or replace.

2½-TON 4 x 2 TRUCK (FEDERAL)

30. INTAKE AND EXHAUST SYSTEM.

a. Excessive Fuel Consumption.

Possible Cause	Possible Remedy
Dirty air cleaner.	Service air cleaner (par. 75).

b. Exhaust Fumes in Cab.

Loose exhaust pipe coupling.	Tighten exhaust pipe to manifold coupling (par. 76).
------------------------------	--

c. Excessive Noisy Exhaust.

Defective or burned out muffler.	Replace muffler and exhaust pipe (par. 76).
----------------------------------	---

d. Pronounced Rattle Under Body.

Loose muffler and/or tail pipe.	Tighten muffler and/or tail pipe clamps (par. 76).
---------------------------------	--

31. COOLING SYSTEM.

a. Overheating.

Lack of coolant.	Fill system (par. 77).
Fan inoperative due to loose or broken belt.	Adjust or replace belt (par. 80).
Thermostat remains closed.	Replace thermostat (par. 82).
Water pump defective.	Repack or replace pump (par. 78).
Cooling system clogged.	Clean entire system (par. 79).
Radiator core air passages clogged.	Clean radiator core (par. 79).
Incorrect ignition timing.	Check ignition timing (par. 84).

b. Overcooling.

Thermostat remains open.	Replace thermostat (par. 82).
--------------------------	-------------------------------

c. Loss of Coolant Liquid.

Loose hose connections.	Tighten all connections.
Defective hose.	Replace (par. 81).
Worn water pump packing.	Adjust, repack, or replace pump (par. 78).
Leak in cylinder head gasket.	Replace gasket.
Leaks in radiator core.	Replace core (par. 79).

32. IGNITION SYSTEM.

a. Hard Starting.

Distributor points burned.	Clean or replace points (par. 85) and inspect condenser (par. 86).
Points out of adjustment.	Adjust to 0.020 inch (par. 85).
Incorrect spark plug gap.	Adjust to 0.025 inch (par. 88).

TROUBLE SHOOTING

Possible Cause	Possible Remedy
Spark plug wires loose or corroded in distributor cap.	Clean wire and cap terminals (par. 90).
Loose connections in primary circuit.	Tighten all connections in primary circuit (par. 90).
Corroded battery terminals and ground terminals.	Clean and tighten terminals (par. 181).
Series resistance in condenser circuit.	Clean and tighten connections (par. 86).
Low capacity condenser.	Replace condenser (par. 86).
b. Failure to Start.	
Disconnected or loose distributor or coil wires.	Connect wires (par. 90).
Ignition coil faulty.	Replace (par. 89).
Wet spark plugs.	Remove and dry thoroughly (par. 88).
Distributor points burned.	Replace points (par. 85).
Shorted condenser.	Replace condenser (par. 86).

33. STARTING AND GENERATING SYSTEMS.

a. Discharged Battery.	
Excessive use of cranking motor due to hard starting.	Recharge or replace (par. 180).
Generator not charging.	Test as directed, or replace (par. 94).
Regulator not working.	Replace regulator (par. 93).
b. Slow Starter Speed.	
Worn brushes.	Report to higher authority.
Sticking brushes.	Report to higher authority.
Dirty or burned commutator.	Clean commutator (subpar. 35, item 27).
Worn drive end bushing.	Replace cranking motor (par. 95).
Burned starter switch points.	Replace switch (par. 96).
c. Low Generator Charging Rate.	
Dirty commutator.	Clean commutator (subpar. 25, item 27).
Loose fan belt.	Adjust fan belt (par. 80).
Generator regulator out of adjustment.	Replace unit (par. 93).
High resistance in charging circuit.	Clean and tighten battery terminals and check circuit for loose connections (par. 181).
Worn brushes.	Report to higher authority.
Weak brush springs.	Report to higher authority.

2½-TON 4 x 2 TRUCK (FEDERAL)

d. Too High Generator Charging Rate.

Possible Cause

Possible Remedy

Generator regulator out of adjustment.	Replace unit (par. 93).
--	-------------------------

34. TRANSMISSION.

a. Noises.

Insufficient lubricant.	Fill to correct level (par. 20).
Universal joint front yoke, or retainer nut loose.	Tighten securely (par. 101).
Loose transmission mounting studs at clutch housing.	Tighten studs and nuts (par. 99).
Loose clutch housing to flywheel housing bolts.	Tighten bolts (par. 99).
Worn or broken bearings.	Replace transmission (par. 99), or report to higher authority.
Badly worn gears.	Replace transmission (par. 99), or report to higher authority.
Gear teeth chipped.	Replace transmission (par. 99), or report to higher authority.
Worn reverse idler gear bushing.	Replace transmission (par. 99), or report to higher authority.

b. Jumping Out of Gear.

Transmission to clutch housing studs and nuts loose.	Tighten studs and nuts (par. 99).
Clutch housing to flywheel housing bolts loose.	Tighten bolts (par. 99).
Shift lock spring weak or broken.	Replace transmission (par. 99), or report to higher authority.
Bent shifter fork.	Replace transmission (par. 99), or report to higher authority.
Worn gears.	Replace transmission (par. 99), or report to higher authority.

c. Loss of Transmission Lubricant.

Excessive lubricant.	Drain to level of filler plug (par. 20).
Defective gaskets.	Replace transmission (par. 99), or report to higher authority.
Worn or damaged oil seal.	Replace transmission (par. 99), or report to higher authority.
Worn or scarred propeller shaft yoke.	Replace transmission (par. 99), or report to higher authority.

TROUBLE SHOOTING

35. PROPELLER SHAFT.

a. Excessive Noise and Vibration.

Possible Cause	Possible Remedy
Propeller shaft universal joints not in same planes.	Replace correctly (par. 101).
Joints worn excessively.	Replace propeller shaft and joints (par. 101).
Joints lacking lubrication.	Lubricate through fittings (par. 20).
Universal joint flanges loose.	Tighten (par. 101).
Propeller shaft sprung.	Replace shaft (par. 101).
Center bearing attaching bolts loose.	Tighten bolts (par. 102).
Center bearing worn.	Replace (par. 102).

36. FRONT AXLE.

a. Excessive or Uneven Tire Wear.

Tires wearing evenly but too rapidly, due to incorrect toe-in.	Adjust toe-in.
Outside edge of tread wearing.	Report to higher authority.
Inside edge of tread wearing.	Report to higher authority.
Irregular tread wear due to worn knuckle and bushings.	Replace spindle (par. 112).
One tire wearing excessively, due to bent I-beam.	Report to higher authority.
Tire wearing due to bent steering knuckle arm.	Replace steering knuckle arm (par. 108).

b. Steering Difficulty.

Steering hard, due to bent tie rod.	Replace tie rod (par. 110).
Steering hard, due to lack of lubrication.	Lubricate (par. 20).
Steering hard, due to under-inflation of tires.	Inflate tires to 60 pounds.
Steering drag link out of adjustment.	Adjust drag link (par. 154).
Incorrect front wheel toe-in.	Adjust toe-in (par. 104).
Adjustment too tight.	Correct.

c. Front Axle Wander.

Truck wanders, due to worn spindles or loose tie rod ends.	Replace parts (pars. 110 and 112).
Truck wanders, due to loose wheel bearings.	Adjust wheel bearings (par. 141).
Truck wanders, due to broken spring, worn spring shackle, or pin.	Replace parts (par. 148).

2½-TON 4 x 2 TRUCK (FEDERAL)

Possible Cause	Possible Remedy
Truck wanders, due to bent steering knuckle arm.	Replace steering knuckle arm (par. 108).
d. Wheel Pounding.	
Loose front wheel bearings.	Adjust bearings (par. 141).
Wheel assembly out of balance, due to improperly mounted tires.	Deflate tires and mount properly.
Rim or wheel bent.	Replace wheel (par. 139).
Wheel improperly mounted.	Mount correctly (par. 139).

37. REAR AXLE.

a. Axle Noises, Both Driving and Coasting.	
Wheel bearing out of adjustment.	Adjust bearings (par. 141).
Tires soft or worn.	Inflate to 60 pounds, or replace.
b. Axle Noises, Pulling Only.	
Improper ring gear and pinion contact or rough bearing.	Report to higher authority.
c. Axle Noises When Coasting Only.	
Excessive backlash or rough bearing.	Report to higher authority.
d. Excessive Backlash.	
Axle shaft flange loose.	Tighten flange cap screws (par. 117).
e. Grease Leakage.	
Grease leakage at carrier flange or inspection cover gasket.	Replace gasket, and tighten flange nuts (par. 117).
Grease leakage at bowl.	Report to higher authority.

38. SERVICE AND HAND BRAKES.

a. Excessive Pedal Pressure and Poor Stop.	
Brake shoes improperly adjusted.	Adjust to proper clearance (par. 121).
Relay valve not functioning.	Replace hydrovac unit (par. 124).
Power cylinder not functioning.	Replace hydrovac unit (par. 124).
Leak in vacuum system.	Tighten all connections (par. 127).
Improper linings.	Replace shoe and lining assembly (par. 128).
Check valve not functioning.	Clean or replace (par. 125).
Dirty hydrovac air cleaner.	Clean or replace (par. 124).

TROUBLE SHOOTING

Possible Cause	Possible Remedy
Grease-soaked linings.	Replace shoe and lining assembly (par. 128).
Shoe twisted or sprung.	Replace shoe and lining assembly (par. 128).
Shoe anchor twisted or sprung.	Replace shoe anchor (par. 128).
Improper brake fluid.	Bleed and refill lines (par. 120).
Obstructed brake line.	Remove and replace (par. 127).

b. Pedal Goes to Floor Board.

Normal lining wear.	Adjust for wear (par. 121).
Excessive lining wear.	Replace shoe and lining assembly (par. 128).
Low fluid in master cylinder.	Refill master cylinder (par. 120).
Air trapped in hydraulic system.	Bleed entire system (par. 120).
Hydraulic fluid leak.	Tighten or replace connections or replace defective parts (pars. 120 through 127).
Brake shoes improperly adjusted.	Adjust shoes to proper clearances (par. 121).

c. Noisy Brakes.

Shoe twisted or sprung.	Replace shoe and lining assembly (par. 128).
Shoe anchor twisted or sprung.	Replace shoe anchor (par. 128).
Dirty linings.	Clean or replace shoe and lining assembly (par. 128).
Loose lining rivets.	Replace shoe and lining assembly (par. 128).
Drums distorted.	Replace hub and drum (pars. 137-138).

d. Springy, Spongy Pedal Action.

Air in hydraulic system.	Bleed entire system (par. 120).
Brake shoes improperly adjusted.	Adjust to proper clearance (par. 121).

e. Truck Pulls to One Side.

Grease-soaked linings.	Replace shoe and lining assembly (par. 128).
Brake shoes improperly adjusted.	Adjust to proper clearance (par. 121).
Loose anchor.	Tighten or replace anchor pin (par. 128).
Wheel bearings improperly adjusted.	Adjust (par. 141).
Tires not properly inflated.	Inflate to 60 pounds.

2½-TON 4 x 2 TRUCK (FEDERAL)

f. One Brake Drags.

Possible Cause	Possible Remedy
Weak or broken brake shoe return spring.	Replace return spring (par. 128).
Brake anchor pins too tight.	Clean or replace (par. 128).
Brake shoes improperly adjusted.	Adjust to proper clearance (par. 128).
Wheel bearings improperly adjusted.	Adjust to proper limits (par. 141).
Defective wheel cylinder piston cups.	Replace wheel cylinder (par. 123).
Obstructed brake line.	Replace (par. 127).
Grease-soaked linings.	Replace shoe and lining assembly (par. 128).

g. All Brakes Drag.

Weak or broken brake shoe return springs.	Replace return springs (par. 128).
Mineral oil in hydraulic system.	Bleed and refill entire system (par. 120).
Defective master cylinder check valve.	Replace master cylinder (par. 122).
Defective hydrovac slave cylinder check valve.	Replace hydrovac (par. 124).

h. Severe Brake with Light Pedal Pressure.

Brake shoes improperly adjusted.	Adjust to proper clearance (par. 121).
Loose brake shoe anchor.	Tighten anchor pins (par. 128).
Improper linings.	Replace shoe and lining assembly (par. 128).
Grease-soaked linings.	Replace shoe and lining assembly (par. 128).

i. Hand Brake Fails to Hold Vehicle.

Worn or loose linkage.	Replace controls (par. 135).
Worn lining or drum.	Adjust or replace lining assembly (par. 131).

39. WHEELS AND HUBS.

a. Excessive or Uneven Tire Wear.

Low tire pressure.	Keep tires inflated to 60 pounds.
Tires wearing evenly but too rapidly, due to incorrect toe-in.	Correct toe-in (par. 104).
Outside edge of tread wearing.	Report to higher authority.
Inside edge of tread wearing.	Report to higher authority.
Irregular tread wear, due to worn knuckle and bushings.	Replace spindle (par. 112).

TROUBLE SHOOTING

Possible Cause	Possible Remedy
One tire wearing excessively, due to bent I-beam.	Report to higher authority.
Tire wearing, due to bent steering knuckle arm.	Replace steering knuckle arm (par. 108).

b. Steering Difficulty.

Steering hard, due to bent tie rod.	Replace tie rod (par. 110).
Steering hard, due to under-inflation of tires.	Inflate tires to 60 pounds.
Steering hard, due to lack of lubrication.	Lubricate (par. 20).
Adjustment too tight.	Correct.

40. SPRINGS AND SHOCK ABSORBERS.

a. Hard Riding.

Insufficient lubrication.	Lubricate spring shackle and bracket bolts (par. 20).
Bolts in shackle or bracket frozen.	Remove and clean. Replace if necessary (par. 146).
Spring U-bolts loose, causing spring or axle to shift.	Aline axle and tighten spring U-bolt nuts (pars. 106 and 115 c).
Overload.	Load vehicle only to rated capacity (par. 5).
Uneven load distribution.	Distribute load evenly.
Broken spring.	Replace (par. 148).

b. Excessive Noise.

Worn bolts and bushings in shackles or brackets.	Replace with new parts (par. 146).
Loose spring U-bolt nuts, causing misalignment of axle and springs.	Aline axle and tighten U-bolt nuts (pars. 106 and 115 c).

41. STEERING.

a. Hard Steering.

Steering gear bearings worn or damaged.	Replace steering gear assembly (par. 160).
Drag link ends adjusted too tight.	Check and adjust correctly (par. 154).
Misalignment in steering gear mountings, causing binding.	Adjust steering gear mountings (par. 160).
Bent drag link or pitman arm, causing binding.	Replace part (pars. 155, 158).

2½-TON 4 x 2 TRUCK (FEDERAL)

Possible Cause	Possible Remedy
Lack of lubrication at drag link ends or in gear housing.	Lubricate as required (par. 20).
Tires underinflated.	Inflate tires to 60 pounds.
b. Wander or Lack of Steering Control.	
Steering gear bearings too loose.	Replace steering gear assembly (par. 160).
Drag link ends worn or adjusted too loose.	Adjust or replace drag link (par. 154).
Steering gear mountings loose.	Adjust and tighten steering gear assembly mountings (par. 160).
Worn parts in steering gear.	Replace steering gear assembly (par. 160).
Pitman arm loose on sector shaft.	Tighten pitman arm lock nut (par. 158).
c. Road Shock Transmitted to Steering Wheel.	
Steering drag link ends adjusted too tight.	Check and adjust drag links correctly (par. 154).
Looseness and misalignment of front-end parts.	Tighten parts and align front end (pars. 104 and 154).
d. Unequal Turning Radius to Right and Left.	
Drag link bent.	Replace (par. 156).
Steering knuckle stop screws broken, worn, or improperly adjusted.	Report to higher authority.
Pitman arm incorrectly installed.	Remove and install correctly (pars. 157 and 158).

42. BODY AND FRAME.

a. Excessive Tire Wear.

Frame misalignment, if steering and spring systems are correct.	Report to higher authority.
---	-----------------------------

b. Difficult Steering.

Frame misalignment, if steering and spring systems are correct.	Report to higher authority.
---	-----------------------------

c. Excessive Jolting of Cab.

Loose or broken mounting bolts.	Tighten or replace mounting bolts (par. 161 c).
---------------------------------	---

43. HOIST.

a. Lifting Speed Too Slow.

Insufficient oil supply in cylinder.	Check and replenish (par. 176).
Pump valve not opening properly.	Check linkage (par. 175).
Insufficient pump pressure.	Replace pump (par. 177).

TROUBLE SHOOTING

b. Body Settling from Raised Position.

Possible Cause	Possible Remedy
Ball check not seating properly.	Report to higher authority.
Manifold control valve not closing.	Check control lever position (par. 175).
Oil in cylinder too light, or dirty.	Drain and refill cylinder with proper grade as recommended for local climatic conditions (par. 20).

44. BATTERY AND LIGHTS.

a. Discharged Battery.

Loose or dirty terminals.	Clean and tighten (par. 181).
Short in wiring.	Check wiring for short circuit (par. 181).
Short in battery.	Replace battery (par. 180).
Worn-out battery.	Replace battery (par. 180).

b. Slow Cranking Motor Speed.

Discharged battery.	Recharge or replace battery (par. 180).
Loose or dirty terminals on battery and ground.	Clean and tighten terminals (par. 181).

c. Too High Generator Charging Rate.

Dead cell in battery.	Replace battery (par. 180).
-----------------------	-----------------------------

d. Failure to Start.

Corroded battery and/or ground terminal.	Remove and clean terminals. Tighten terminal nuts (par. 181).
--	--

e. Lights Burn Dim.

Loose connections.	Tighten connections (par. 181).
Burned switch contacts.	Replace lighting or dimmer switch (par. 194).
Corroded battery terminals.	Clean and tighten battery terminals (par. 181).

45. INSTRUMENTS.

a. Incorrect Reading or Failure.

Defective.	Replace (pars. 188 to 199).
Temperature gage fitting loose.	Check fitting at cylinder block (par. 192).
Oil gage line leaking or broken.	Tighten line or replace (par. 190).
Fuel gage terminals loose.	Check terminals at gage and tank unit (par. 189).
Loose or broken speedometer drive cable.	Tighten or replace (par. 191).

2½-TON 4 x 2 TRUCK (FEDERAL)

46. POWER TAKE-OFF.

a. Noisy Operation.

Possible Cause

Loose mounting bolts.

Excessive gear wear.

Possible Remedy

Tighten mounting bolts (par. 202).

Replace assembly (par. 202), or report to higher authority.

Section XII

ENGINE—DESCRIPTION, DATA, MAINTENANCE, AND ADJUSTMENT IN VEHICLE

	Paragraph
Description and tabulated data.....	47
Tune-up.....	48
Cylinder head and gasket removal.....	49
Carbon removal.....	50
Cylinder head and gasket installation.....	51
Valve chamber cover and gasket.....	52
Valve tappet adjustment.....	53
Intake and exhaust manifolds and gasket removal.....	54
Intake and exhaust manifolds and gasket installation.....	55
Oil pan.....	56
Oil pump.....	57
Oil filter service.....	58
Crankcase ventilator and air cleaner.....	59

47. DESCRIPTION AND TABULATED DATA.

a. **Description.** This vehicle is powered by a Hercules JXD engine of six-cylinder L-head design, with cylinder block and crankcase cast integral. Cylinders are numbered from front to rear, the engine front (fan and timing gear end) being toward the front of the vehicle. As viewed from the front end, engine crankshaft rotation is clockwise. The engine mounting is three-point design with one front and two rear supports.

b. Tabulated Data.

(1) ENGINE SPECIFICATIONS.

Make.....	Hercules gasoline
Model.....	JXD
Type.....	L-head
Number of cylinders.....	6
Bore.....	4-in.
Stroke.....	4¼-in.
Piston displacement.....	320 cu in.
Compression ratio.....	5.9 to 1
Rated speed.....	3000 rpm
Rated horsepower (N.A.C.C.).....	38.4
Maximum bhp at rated rpm (2800).....	95
Firing order.....	1-5-3-6-2-4
Number of main bearings.....	7
Crankcase.....	With block
Oil capacity—dry.....	8-qt
Oil capacity—refill.....	6-qt
Weight without accessories.....	560 lb

2½-TON 4 x 2 TRUCK (FEDERAL)**48. TUNE-UP.**

a. **Description.** The engine tune-up is the orderly process of checking engine and accessory equipment to determine if they are within original specifications. The proper equipment, such as compression gage and timing light, should be employed. Chart shows the proper sequence of the operations (fig. 18), which must be performed under normal operating temperature.

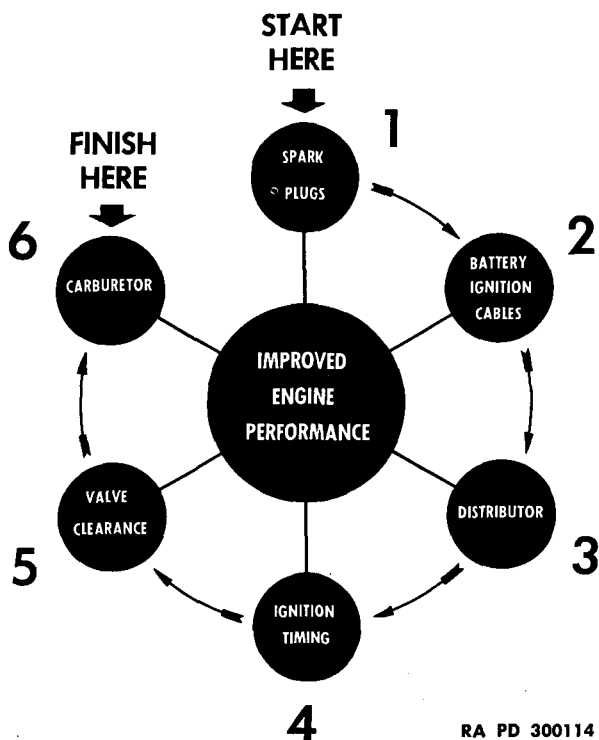

Figure 18—Tune-up Chart

b. **Compression Test.** With spark plugs removed, throttle full-open, and engine revolving under cranking motor power, each cylinder should test 90 pounds with pressure gage in spark plug hole. Variation of five pounds either way is permissible. If compression variation is beyond this limit, repair work beyond the scope of this manual is indicated, and condition should be reported to higher authority. If compression variation is within the above limit, proceed as outlined in the following steps:

(1) **SPARK PLUGS.** Check plugs for proper size and heat range, for fouled gap, for cracked porcelains, and for gap settings (par. 88).

ENGINE—DESCRIPTION, DATA, MAINTENANCE, AND ADJUSTMENT IN VEHICLE

(2) **BATTERY AND IGNITION CABLES.** Inspect ground strap and cranking motor cables; check ignition wiring; all terminals must be tight and clean (par. 90).

(3) **DISTRIBUTOR.** Inspect points for evidence of pitting or burning (par. 85); check gap (par. 85); check cap for cracks; check operation of centrifugal governor; check condenser (pars. 86 and 87).

(4) **TIMING.** Check ignition timing with neon lamp to be sure No. 1 cylinder is firing according to flywheel marking (par. 84).

(5) **VALVE CLEARANCE.** Check valve clearance (par. 53) and make visual inspection for broken valve springs.

(6) **CARBURETOR.** Clean air cleaner and filter; check for leaks; adjust idling screw; check connections at controls (par. 73).

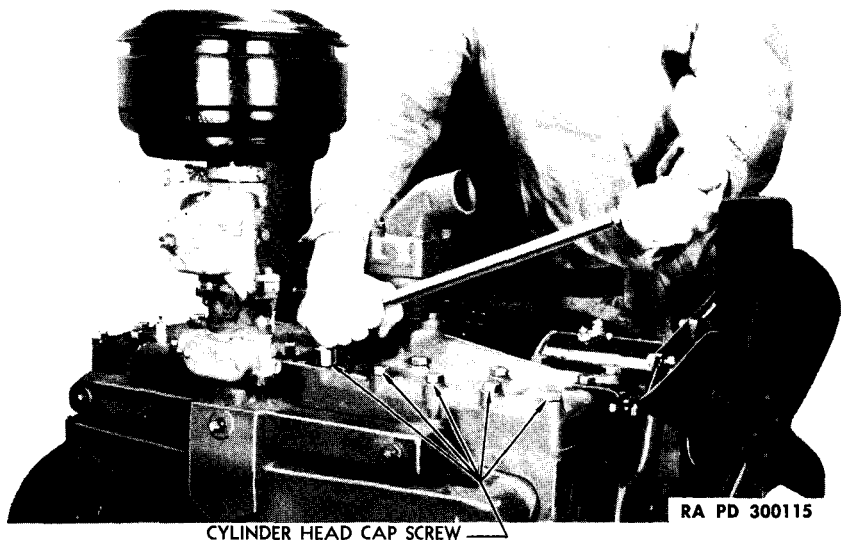

Figure 19—Removing Cylinder Head Cap Screws

49. CYLINDER HEAD AND GASKET REMOVAL.

a. Disconnect spark plug wires and remove spark plugs. Remove thermogage fitting from left side at the rear of the cylinder head. Disconnect radiator inlet pipe hose and water bypass line at thermostat housing. Loosen and remove all cylinder head cap screws. Oil filler and breather clip support brace comes off when cap screw is removed. Lift off cylinder head and lift off gasket.

50. CARBON REMOVAL.

a. Use a wire brush or scraping tool to completely remove carbon deposits from inside cylinder head, top of cylinder block, and from

2½-TON 4 x 2 TRUCK (FEDERAL)

top of each piston. Clean all scraped surfaces with a dry rag, being careful to remove all small particles.

51. CYLINDER HEAD AND GASKET INSTALLATION.

a. Wipe clean surface of cylinder head and cylinder block. Place gasket in position. Place cylinder head in position and insert all cylinder head cap screws. Secure breather and filler support clip under proper cap screw. Tighten cap screws uniformly, following the recommended sequence (fig. 20). Install radiator inlet pipe hose and water bypass line. Install thermogage line. Install spark plugs and connect high-tension cables. After approximately a week's operation, check all cap screws for tightness.

52. VALVE CHAMBER COVER AND GASKET.

a. **Valve Chamber Cover and Gasket Removal.** Remove right-hand engine hood side panel by removing three metal attaching screws

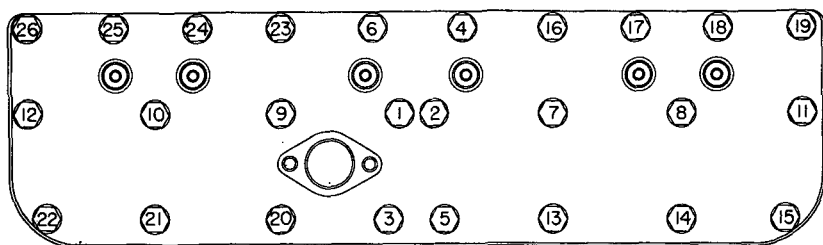

RA PD 300116

Figure 20—Cap Screw Tightening Sequence

that hold each end of side panel, and remove panel. Remove two valve cover retainer stud nuts and remove one valve chamber cover and gasket. The other valve cover is removed in like manner.

b. **Valve Chamber Cover and Gasket Installation.** Examine valve chamber cover gasket and if loosened, fasten to cover with gasket cement. Install cover and gasket assembly in position over studs. Install two cover retainer stud nuts and draw up tight. The other valve chamber cover is installed in like manner. Install right-hand engine hood side panel with three metal attaching screws at each end.

53. VALVE TAPPET ADJUSTMENT.

a. **Warm Up Engine.** Engine must be warmed up until oil reaches normal operating temperature. Run at a rapid idle for at least 20 minutes. After temperature of 160° to 180°F has been reached, allow

ENGINE—DESCRIPTION, DATA, MAINTENANCE, AND ADJUSTMENT IN VEHICLE

engine to run at normal idling speed, and proceed with valve clearance adjustment.

b. **Remove Valve Covers.** Remove two valve cover retainer stud nuts and remove valve cover and cover gasket (par. 52).

c. **Stop Engine.** Shut down engine and hand crank to firing position (both valves down) for each cylinder before setting the valve clearance on that cylinder.

d. **Adjust Clearance.** Place flat 0.006-inch feeler gage between the tappet and valve stem. Loosen lock nut and adjust tappet screw until a slight drag is felt when withdrawing feeler gage (fig. 21).

e. **Lock Adjustment.** Lock tappet screw lock nut in adjusted position. The valve tappet body and the adjusting screw must be held from turning when the tappet screw lock nut is being tightened. After removing wrenches, recheck with feeler gage. Proceed in like manner for all cylinders.

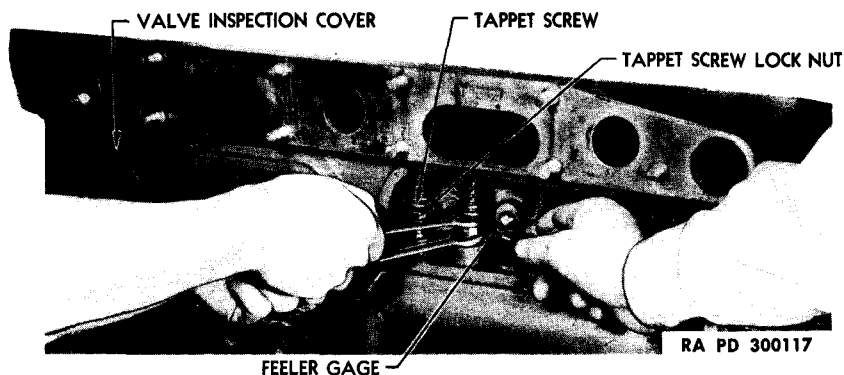

Figure 21—Adjusting Valve Tappet Clearance

54. INTAKE AND EXHAUST MANIFOLDS AND GASKET REMOVAL.

a. Remove air cleaner, carburetor, and governor (pars. 67, 68, and 75). Remove exhaust pipe support clip at cranking motor stud and two exhaust pipe flange nuts; drop flange and exhaust pipe away from manifold. Disconnect windshield wiper and brake system vacuum line at manifold. Remove 10 brass nuts and washers from manifold studs, and lift off manifold and gasket (fig. 46).

55. INTAKE AND EXHAUST MANIFOLDS AND GASKET INSTALLATION.

a. Make sure manifold and cylinder block faces are clean. Place gaskets in position and place manifolds on studs. Tighten stud nuts

2½-TON 4 x 2 TRUCK (FEDERAL)

evenly. Push exhaust pipe into manifold, place flange in position, and draw up stud nuts. Connect vacuum lines, and install carburetor and air cleaner (pars. 68 and 75).

56. OIL PAN.

a. **Oil Pan Removal.** Drain oil into suitable container, placing wood blocks under pan if necessary. Remove 20 cap screws and lock washers holding the oil pan to the crankcase. Remove five cap screws and lock washers holding oil pan to flywheel housing. Lower oil pan to ground, and remove gasket from edge of pan.

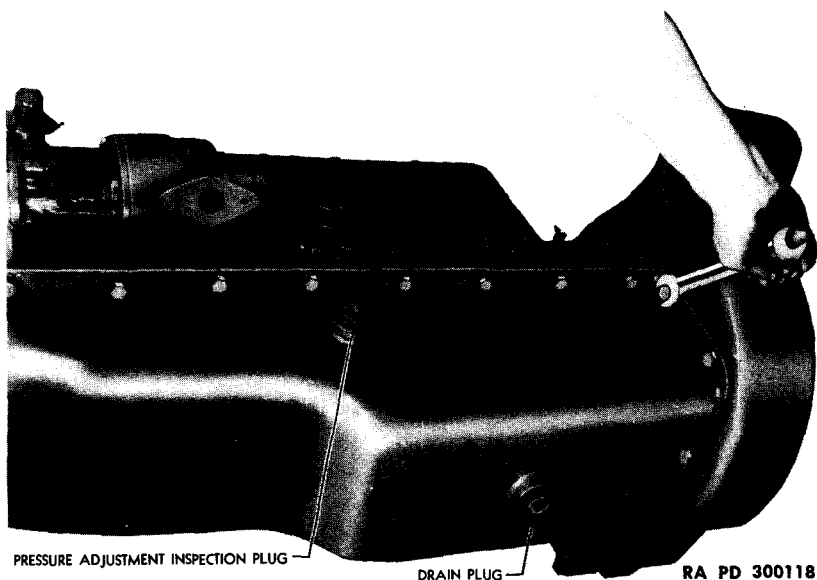

Figure 22—Removing Oil Pan

b. **Cleaning.** Use dry-cleaning solvent to dissolve and remove all soluble sludge from pan interior. Scrape all encrusted and insoluble particles from pan with a wire brush. Remove all small particles with a dry rag. Clean exterior with a wire brush, using dry-cleaning solvent on obstinate parts.

c. **Oil Pan Installation.** Install gasket on top rim of pan. Use gasket cement to hold it in position, being careful to line up gasket cap screw holes. Examine bell housing gasket and if loose, seal it to bell housing with gasket cement. Place pan in position and install a few cap screws and lock washers on each side, but not on ends of pan. Insert five cap screws and lock washers holding pan to bell housing, but do not draw up tight. Insert the remaining cap screws and lock

ENGINE—DESCRIPTION, DATA, MAINTENANCE, AND ADJUSTMENT IN VEHICLE

washers holding pan to engine base, but do not draw up tight. Tighten all cap screws holding pan to engine base and bell housing in alternate rotation, so that pan will draw up firmly and evenly to seal. Replace drain plug. Replace crankcase oil.

57. OIL PUMP.

a. **Oil Pump Removal.** Remove oil pan (fig. 22). Remove three oil pump mounting screws that hold the oil pump to the main bearing

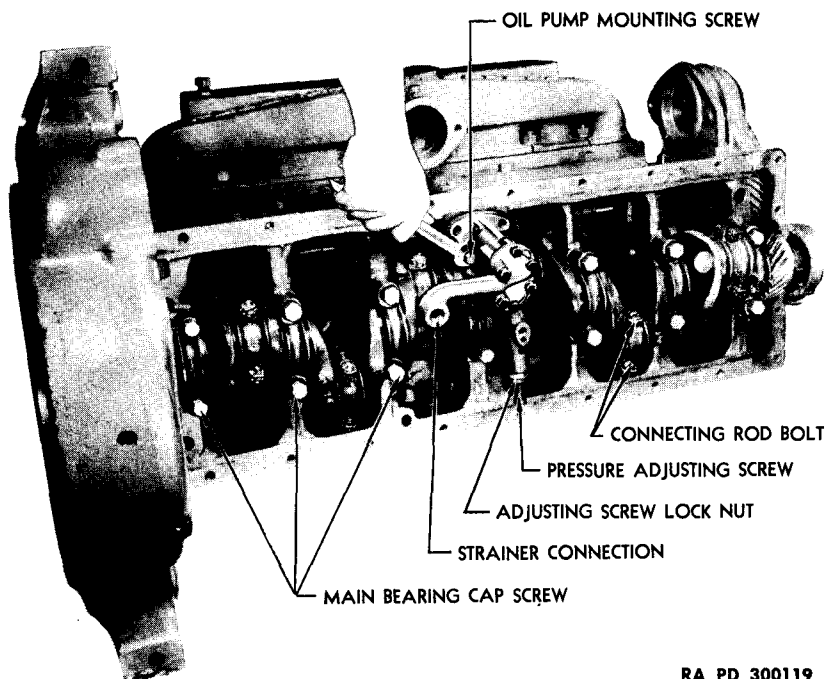

RA PD 300119

Figure 23—Removing Oil Pump Mounting Screws

web (fig. 23). Turn pump assembly $\frac{1}{4}$ turn counterclockwise to release oil pump drive gear mesh. Pull pump assembly and gasket straight away from the engine.

b. **Oil Pump Adjustment.** It is not necessary to remove pump assembly from engine to make the following oil pressure adjustments:

(1) **REMOVE PLUG.** Remove the adjusting hole plug located on the left side of the oil pan (fig. 24).

2½-TON 4 x 2 TRUCK (FEDERAL)

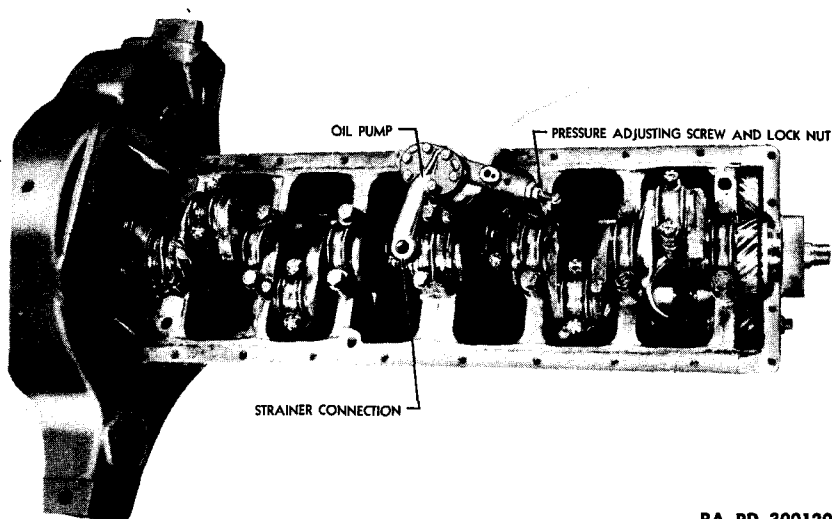

RA PD 300120

Figure 24—Removing Oil Pump Assembly

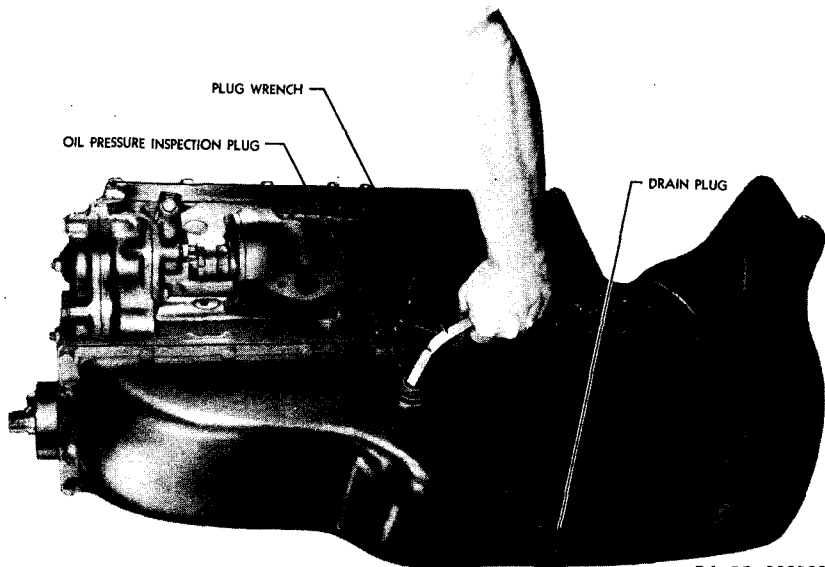

RA PD 300121

Figure 25—Removing Oil Pressure Inspection Plug

(2) **ADJUST PRESSURE.** Using special T-socket wrench on the adjusting screw hex head nut, and a crowfoot wrench on the adjusting screw locking nut, loosen locking nut and turn adjusting screw in to increase pressure, or out to decrease pressure (fig. 25).

**ENGINE—DESCRIPTION, DATA, MAINTENANCE, AND
ADJUSTMENT IN VEHICLE**

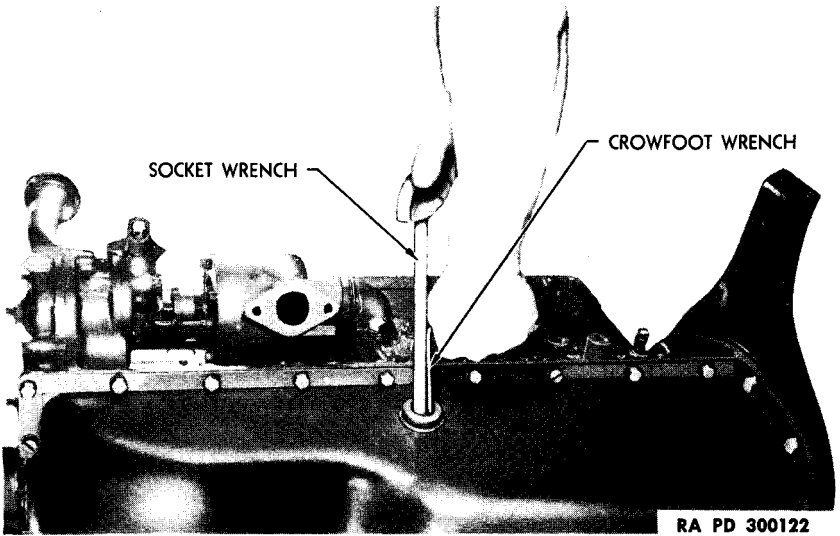

Figure 26—Adjusting Oil Pump (Pan in Place)

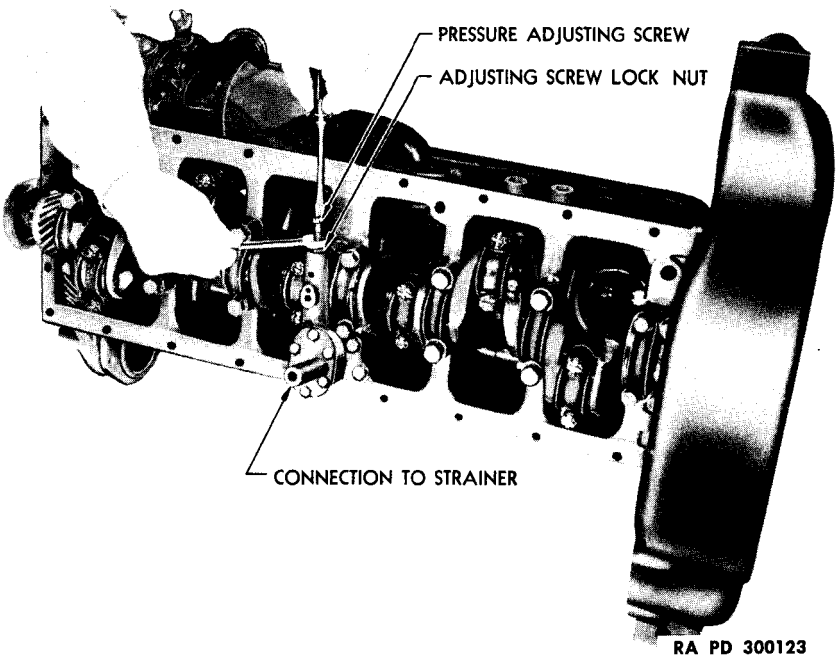

Figure 27—Adjusting Oil Pump (Pan Removed)

2½-TON 4 x 2 TRUCK (FEDERAL)

(3) **STICKING RELIEF VALVE.** Dirt and carbon may cause relief valve piston to stick, resulting in low oil pressure. This condition can sometimes be corrected by tightening the adjusting screw to force the plunger loose. If this does not correct the condition, replace oil pump.

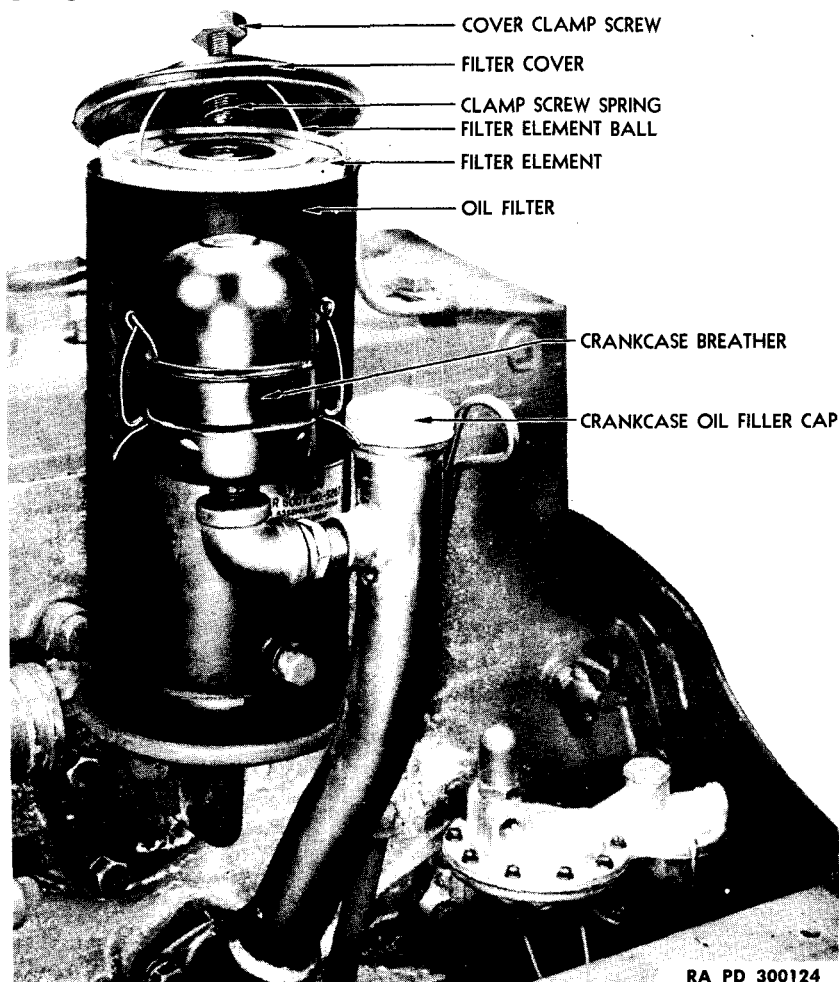

Figure 28—Oil Filter

c. **Oil Pump Installation.** Position oil pump on main bearing web and turn ¼ turn clockwise while installing. Install three cap screws and lock washers to hold pump. Install oil pan (par. 56).

58. OIL FILTER SERVICE.

a. **Remove Oil Filter Element.** Unscrew oil filter housing cover screw (fig. 28) and lift off cover. Withdraw oil filter element. Remove

ENGINE—DESCRIPTION, DATA, MAINTENANCE, AND ADJUSTMENT IN VEHICLE

drain filter plug in side of filter body near lower edge and drain off sludge.

b. **Clean Oil Filter Body.** Clean oil filter body and bowl with dry-cleaning solvent. Wipe dry with a clean rag.

c. **Install Oil Filter Element.** Place filter element in position inside filter body. Set filter body cover in place and secure with cover retaining screw. Use new cover gasket if necessary.



RA PD 300062

Figure 29—Crankcase Ventilator and Air Cleaner

59. CRANKCASE VENTILATOR AND AIR CLEANER.

a. **Remove Crankcase Ventilator and Air Cleaner.** Unsnap the two retaining clips, lift up cover, and remove filter element. Breather body may be removed by unscrewing from pipe fitting at oil filler pipe.

2½-TON 4 x 2 TRUCK (FEDERAL)

b. Maintenance of Crankcase Ventilator and Air Cleaner. Breather should be inspected regularly and cleaned as often as the oil bath or copper filter appears to be loaded with dirt. Cleaning procedure is accomplished as follows: Remove breather element and wash in dry-cleaning solvent until dirt is removed. Thoroughly clean oil reservoir with dry-cleaning solvent and wipe dry. Fill to level mark with engine oil. Pour out dirty oil, wash reservoir with dry-cleaning solvent, clean, and wipe dry with clean cloth. Fill reservoir with fresh oil to level mark stamped on side. Install cleaner filter element and cover assembly. Install and tighten wing bolts. Install air cleaner assembly on carburetor and tighten clamp screw securely. Install the ventilator body by screwing to pipe fitting at oil filler pipe. Place filter element and cover assembly in position and snap two retaining clips in place.

Section XIII

ENGINE REMOVAL AND INSTALLATION

	Paragraph
Removal	60
Installation	61

60. REMOVAL.

a. **Drain Cooling System.** Open drain cock (fig. 50) below water pump and drain water into pail or on ground. Antifreeze compound, if in good condition, should be saved.

b. **Remove Hood.** Unfasten hood latches and raise hood to lifted position. Disconnect hood brace bracket at dash. Unscrew and remove two hood hinge pins and lift off hood. Remove engine compartment side panels.

c. **Remove Hose Connections.** Loosen clamps holding inlet and outlet radiator hoses and pipes and pull loose from radiator and engine.

d. **Remove Wiring.** Disconnect grounded battery terminal and cable leading from battery to cranking motor switch. Disconnect cable from cranking motor switch to cranking motor. Disconnect ignition coil primary terminal to switch wire at ignition coil. Disconnect generator to generator regulator wire.

e. **Remove Controls.** Disconnect engine controls and linkage (par. 73).

f. **Remove Lines.** Disconnect oil gage oil line at left-rear side of engine, fuel inlet flexible line at tank line, brake vacuum and windshield vacuum lines at manifold, and thermogage line at left-rear of engine.

g. **Remove Radiator and Guard.** Remove radiator and guard as a complete assembly, following the procedure outlined: Loosen radiator guard stay rod lock nuts, remove nuts, and remove both stay rods. Remove three bolts each side holding guard to fender. Remove bolt each side holding two fender braces to lower guard corner. Remove five bolts each side holding guard to engine compartment side panels. Remove guard hold-down bolt and spring at lower center of guard, and lift off entire guard and radiator core assembly.

h. **Remove Exhaust Pipe.** Remove cranking motor flange nut securing exhaust pipe support clamp, and remove clamp from stud. Loosen two flange nuts at exhaust manifold, drop flange, and pull exhaust pipe down.

i. **Remove Transmission.** Remove transmission from chassis (par. 98).

j. **Remove Support Bolts.** Remove front motor support to cross member hold-down bolts. Remove rear motor support to bracket through bolts. Remove hold-down springs.

2½-TON 4 x 2 TRUCK (FEDERAL)

k. **Remove Engine.** Install engine lifting fixture (fig. 30), or if not available, use rope sling. Lift engine from chassis by raising engine assembly sufficient distance to relieve weight on brackets, then lift forward to clear chassis, or move chassis rearward to clear engine.

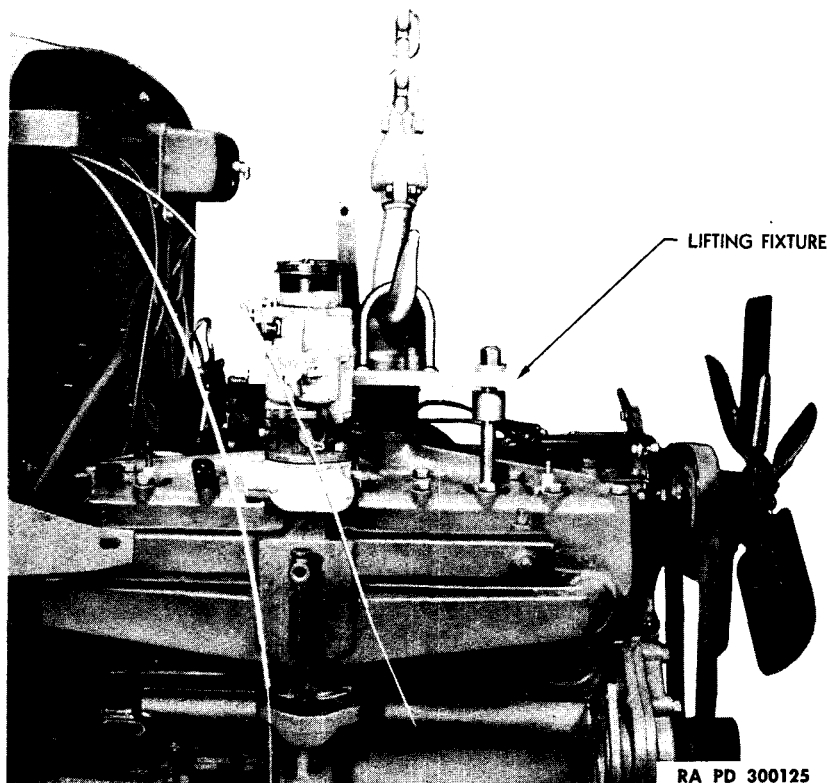

Figure 30—Removing Engine Assembly

61. INSTALLATION.

a. **Put Engine in Place.** Using engine lifting fixture, or if not available, a simple rope sling, lift engine and swing into position in chassis.

b. **Install Support Bolts.** With engine properly lined up on supports, install and tighten front and rear support bolts and hold-down springs. Remove sling.

c. **Install Transmission** (par. 99).

d. **Install Exhaust Pipe.** Push exhaust pipe into manifold, place flange in position on studs, and pull up with stud nuts. Place exhaust pipe support clamp on cranking motor stud and secure with stud nut.

ENGINE REMOVAL AND INSTALLATION

e. Install Radiator Core and Guard. Place radiator and guard assembly in position and install hold-down bolt and spring in lower center of guard. Attach guard to engine compartment side panels, using five bolts on each side. Attach two fender braces at lower corners of guard. Install three bolts each side holding guard to fender. Install two guard stay rods, fastening securely with lock nuts.

f. Install Lines. Connect oil gage oil line at left-rear side of engine, fuel inlet flexible line, brake vacuum, and windshield vacuum lines at manifold, and thermogage line at left rear of engine.

g. Install Wiring. Connect ignition coil primary terminal to switch wire at ignition coil. Connect generator to generator regulator wires. Connect cable from cranking motor switch to cranking motor. Connect battery to cranking motor switch cable and connect ground cable to battery terminal.

h. Install Hose Connections. Put radiator inlet hose and pipe, and radiator outlet hose and pipe back into position, and secure with hose clamps.

i. Install Hood. Place hood in position, and insert and tighten hinge pins. Fasten hood support brace bracket to dash.

j. Fill Cooling System. Close drain cocks and fill cooling system. Run engine at fast idle to circulate cooling water and remove air pockets.

k. Install Controls and Linkage. Install and adjust throttle control linkage, choke control linkage, and accelerator control linkage (par. 73).

2½-TON 4 x 2 TRUCK (FEDERAL)

Section XIV

CLUTCH

	Paragraph
Description and tabulated data.....	62
Maintenance and adjustment.....	63
Removal	64
Installation	65

62. DESCRIPTION AND TABULATED DATA.

a. **Description.** Clutch assembly provides a means of engaging and disengaging engine power from transmission. Clutch is single-plate type. Assembly is bolted to flywheel and drive is taken on four driving lugs integral with pressure plate. Clutch is controlled by foot-operated pedal connected by linkage to release mechanism. Clutch permits engine to pick up load gradually as clutch pedal is released to engage clutch. When clutch pedal is depressed, pressure of release bearing compresses spring and relieves pressure on pressure plate. Pull-back springs retract pressure plate and pressure at facings is relieved. When clutch pedal is released, throw-out bearing and sleeve are retracted by pressure spring, pressure is reapplied to pressure plate, and facings are pressed tightly between flywheel and pressure plate.

b. Tabulated Data.

Clutch type	Single-plate dry disk
Clutch make	W.C. Lipe
Clutch model	Z34-S-C-26 and ZP-1-P178
Size	12 in.

Pressure plate assembly:

Clutch adjustment clearance between shim seat on flywheel ring to rear face of release sleeve should be	1 1/8 in. to 1 3/16 in.
Clearance, release bearing to release sleeve.	1/8 in. to 5/32 in.
Clearance, pedal to toeboard.....	1 in.
Pedal free travel	3/4 in. to 1 1/2 in.
Adjusting shims—quantity	6
(under each strap with new driven plate)	

63. MAINTENANCE AND ADJUSTMENT.

a. **Clutch Lubrication.** In addition to the periodic lubrication requirements of the clutch controls and release bearing, it is essential that lubrication operations be performed whenever clutch is removed to assure proper lubrication of the following items which are not accessible for periodic lubrication.

- (1) **CLUTCH PILOT BEARING.** Clutch pilot bearing must be hand-

CLUTCH

packed with recommended lubricant before installing transmission.

(2) **CLUTCH SHAFT.** Clutch shaft and hub splines must have recommended lubricant applied before assembly of transmission and clutch. Further lubricant is not necessary until clutch is again removed.

(3) **RELEASE BEARING.** Clutch release bearing is lubricated through external oil line and cup. Oil line extends upward through clutch housing and into engine compartment directly over rear end of engine.

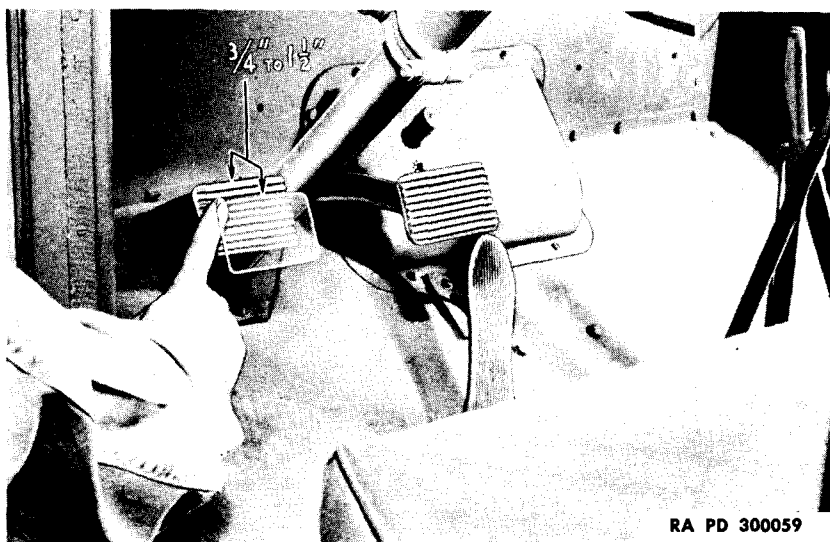
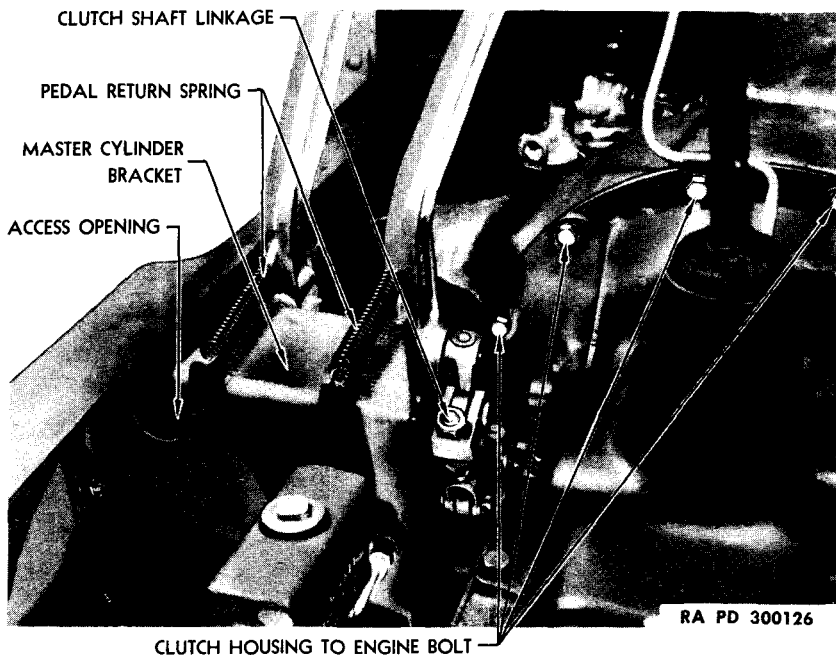

Figure 31—Testing Clutch Pedal Free Travel

b. **Clutch Pedal Free Travel Adjustment.** There are three types of adjustment provided, only one of which is used to compensate for clutch facing wear. The three adjustments are: adjustment for facing wear, adjustment for free pedal travel, and pedal-to-toeboard adjustment.

c. **Adjustment for Facing Wear.** As normal wear occurs, clutch sleeve moves toward release bearing. This changes dimension between rear face of clutch cover and rear face of release sleeve, and results in loss of spring pressure and of free pedal travel, which must be restored by adjustment. Adjustment is made by removing shims from clutch as follows:

(1) **CHECK NEED FOR ADJUSTMENT.** Before shims are removed, the need for adjustment is checked by taking measurement of the dimension between clutch cover and release sleeve. Remove inspection cover and insert a straightedge and scale, or special gage (fig. 33), to check this dimension. If this dimension is greater than $1\frac{3}{16}$ inches,

2½-TON 4 x 2 TRUCK (FEDERAL)**Figure 32—Clutch Control Linkage**

shims must be removed to obtain correct dimension. **NOTE:** *Make this adjustment at time new clutch plate assembly is installed, or after normal facing wear is indicated by free pedal travel of less than ¾ inch.*

(2) **BLOCK CLUTCH PEDAL.** Place wood block or adjustable jack between clutch pedal and seat to block pedal in fully released position.

(3) **LOOSEN ADJUSTING STRAP STUD NUTS.** Back off four adjusting strap stud nuts five full turns.

(4) **REMOVE CLUTCH PEDAL BLOCK.** Remove wood block, or jack, which has been used to hold clutch pedal in released position (fig. 33). This will permit adjusting plate to move out of contact with shims (fig. 33).

(5) **REMOVE SHIMS.** Remove one shim from under each adjusting strap with a pair of sharp-nosed pliers. Do not remove too many shims; as they cannot be easily reinstalled. Be sure that shim is completely removed and that no portion is left between adjusting strap and clutch cover. Each shim that is removed will reduce dimension between release sleeve and clutch cover $\frac{7}{64}$ inch.

(6) **CHECK SHIMS.** Count number of shims remaining under each adjusting strap to be sure that quantity is equal under each of the four straps.

CLUTCH

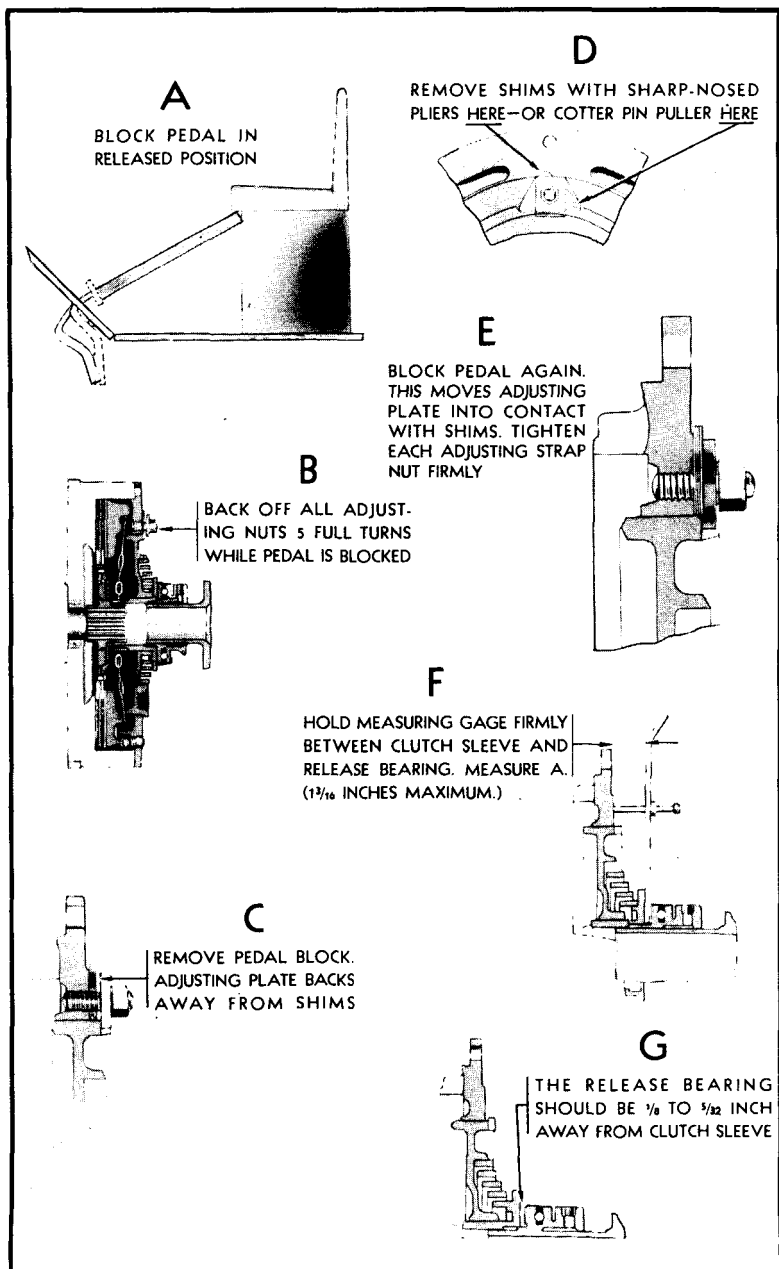

RA PD 300127

Figure 33—Clutch Adjustment

2½-TON 4 x 2 TRUCK (FEDERAL)

(7) **BLOCK CLUTCH PEDAL.** Install wood block, or jack, in the same manner as previously described so that clutch is again in released position. When pedal is depressed, adjusting strap moves into contact with shims (fig. 33).

(8) **TIGHTEN STUD NUTS.** Tighten adjusting strap stud nuts evenly and tightly. Return clutch pedal to engaged position by removing block at pedal.

(9) **RECHECK DIMENSION.** Measure distance from machined surface on clutch cover to rear face of release sleeve, using a special gage (fig. 33), or straightedge and scale. This dimension must be between $1\frac{1}{8}$ and $1\frac{13}{16}$ inches.

(10) **ADJUSTMENT LIMITATIONS.** When all shims have been removed, install a new driven plate and new pack of six shims under each adjusting strap, and then readjust clutch to correct dimension between clutch cover and rear face of release sleeve (step b above).

d. Adjustment for Pedal Free Travel. Determine need for adjustment by measuring the correctness of the clutch assembly shim adjustment with gage (step c (1) above). If shim adjustment is correct and free pedal travel is not $\frac{3}{4}$ to $1\frac{1}{2}$ inches, or when installing new clutch, or new clutch plate, make adjustment as follows:

(1) **CHECK RELEASE BEARING CLEARANCE.** Adjust to $\frac{1}{8}$ -inch to $\frac{5}{32}$ -inch clearance between release sleeve and release bearing (fig. 33). This clearance is equivalent (and is directly proportionate) to free pedal travel of $\frac{3}{4}$ to $1\frac{1}{2}$ inches. Remove inspection cover at bottom of clutch housing. A simple gage consisting of a rod of suitable length ground flat to required dimension ($\frac{1}{8}$ to $\frac{5}{32}$ in.) may be made for insertion between release sleeve and bearing to simplify checking adjustment.

(2) **CHECK PEDAL TRAVEL.** After clearance between release bearing and release sleeve is adjusted to $\frac{1}{8}$ to $\frac{5}{32}$ -inch, measure free movement of pedal, which should be $\frac{3}{4}$ to $1\frac{1}{2}$ inches.

(3) **ADJUST LINKAGE.** If free travel is not $\frac{3}{4}$ to $1\frac{1}{2}$ inches, loosen lock nut at connecting link and remove cotter pin from yoke. Turn yoke into or out of linkage, as required to decrease or increase free pedal travel.

(4) **CONNECT LINKAGE.** When proper adjustment has been obtained, tighten lock nuts and install cotter pin in clevis pin. Install clutch housing inspection cover.

e. Adjustment for Pedal to Toeboard Clearance. Correct pedal to toeboard clearance at underside of toeboard is 1 inch. Make this clearance adjustment only when installing clutch pedal linkage, and before pedal linkage is connected and adjusted. Following is method of adjustment: Loosen pedal stop screw lock nut at pedal. Turn stop screw until 1-inch clearance between pedal and toeboard is obtained. Tighten lock nut securely to lock adjustment.

CLUTCH**64. REMOVAL.**

- a. **Remove Transmission** (par. 98).
- b. **Remove Clutch Cover Assembly.** Take out the 12 screws holding cover plate assembly to flywheel and remove clutch cover assembly (fig. 34).
- c. **Remove Clutch Plate Assembly.** Remove clutch plate and facing assembly from flywheel.

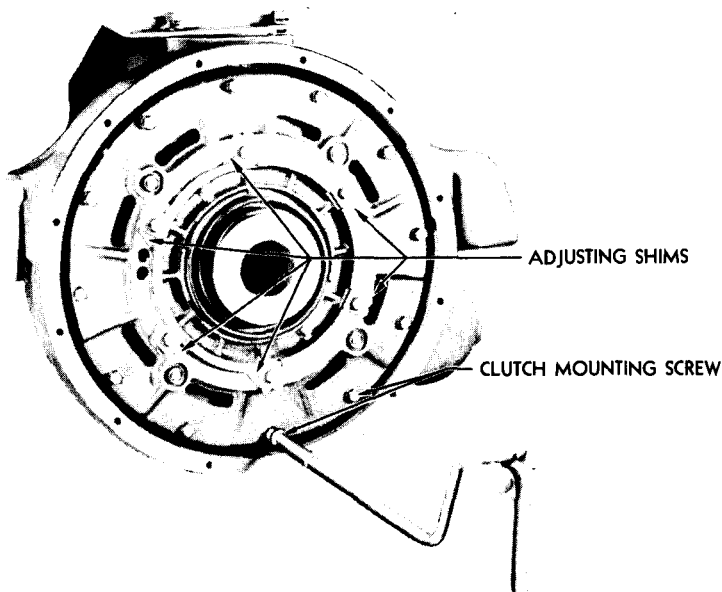

RA PD 300128

Figure 34—Removing Clutch Assembly

d. **Inspection.** Before installing any of the removed parts, inspect each unit as follows:

(1) **INSPECT CLUTCH PLATE.** Inspect driven plate assembly for worn, loose, or oil-soaked facings, for loose rivets at hub, and for distortion. If plate is distorted, or if facings are loose, grease-soaked, or worn, a new clutch driven plate must be installed.

(2) **INSPECT PRESSURE PLATE AND FLYWHEEL.** Carefully examine contact surfaces of pressure plate and flywheel for any indication of scores, roughness, or excessive wear. Replace entire unit if necessary.

2½-TON 4 x 2 TRUCK (FEDERAL)

(3) **CHECK DRIVING LUGS.** Check action of clutch pressure plate in clutch cover to determine condition of the four driving lugs. A binding condition at this point will cause hard shifting, whereas excessive looseness will result in rough clutch operation.

(4) **CHECK FIT OF CLUTCH PLATE.** Place clutch plate on splines of clutch shaft. Plate should fit freely without binding and without excessive looseness.

(5) **CHECK ADJUSTING SHIMS.** If a new driven plate and facing assembly is to be installed, see that the original quantity of shims (six under each strap) is installed between clutch cover and adjusting strap before clutch is reinstalled.

(6) **CHECK RELEASE MECHANISM.** Inspect shifter yoke shaft and check its fit in housing bushings. Examine release bearing and check it for roughness.

65. INSTALLATION.

a. **Install Clutch Plate.** Install clutch plate and facing assembly in flywheel with long end of hub toward rear.

b. **Aline Clutch Plate.** Use suitable alining arbor to hold clutch plate in alinement with pilot bearing, and install pressure plate and cover assembly.

c. **Install Clutch Cover Assembly Cap Screws.** Install and tighten cap screws which attach clutch cover to flywheel. Be sure that lock washer is used under head of each screw. Tighten cap screws alternately and evenly, to prevent possible distortion of clutch cover.

d. **Install Transmission** (par. 99).

e. **Adjust Clutch Controls.** The controls, including clutch release mechanism, are connected. Check all clutch adjustments and correct as required. This is the only time at which adjustment of clutch pedal free travel and toeboard clearance is necessary.

Section XV

FUEL SYSTEM

	Paragraph
Description and tabulated data	66
Governor	67
Carburetor	68
Fuel pump	69
Fuel filter	70
Fuel tank	71
Lines and connections	72
Controls and linkage	73

66. DESCRIPTION AND TABULATED DATA.

a. **Description.** The fuel system consists of fuel tank, fuel filter, fuel pump, carburetor, governor, air cleaner, and interconnecting fuel lines (fig. 35). In addition to these units, an electrically actuated fuel gage system is provided.

b. Tabulated Data.

Carburetor model	Carter BBRI-429-S
Governor	Hoof H-225-SD
Maximum speed setting	3000
Fuel pump model	AC 1537983
Fuel pump capacity	1 pt or over in 45 sec
Fuel pump pressure	5¼ lb
Manifold vacuum	18 to 20 in. idling
Fuel tank capacity	40 gal
Fuel filter	AC 1595134
Fuel gage	Electric actuation

67. GOVERNOR.

a. **Description.** A velocity-type governor (fig. 36) is mounted between carburetor and intake manifold. The governor is entirely automatic and protects engine by limiting the speed.

b. **Remove Governor.** Remove carburetor assembly as outlined in paragraph 68 c. Lift governor off manifold and remove governor to manifold gasket.

c. **Install Governor.** Place governor to manifold gasket on studs and install governor in position. Install carburetor (par. 68 d).

68. CARBURETOR.

a. **Description.** Carburetor used on this truck is conventional down-draft design. Fuel mixture is controlled by fixed jets and metering rod, and except for idling speed and idling mixture, calibration cannot be changed.

2½-TON 4 x 2 TRUCK (FEDERAL)

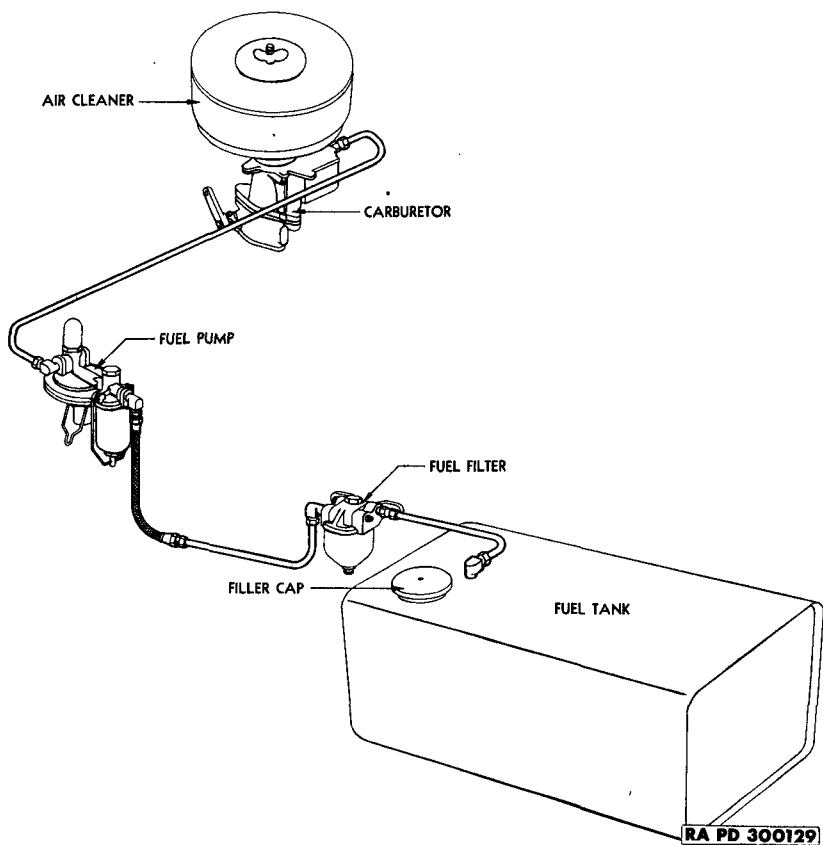

Figure 35—Fuel System Layout

FUEL SYSTEM

b. Adjustment and Maintenance.

(1) **IDLING MIXTURE ADJUSTMENT.** Before adjusting idling mixture, warm up engine so that intake manifold is warm to the hand (120°F or higher). Slow down engine to idling speed. Turn idling mixture screw into stop position, and then back out approximately 1½ turns. Turn mixture screw slowly back and forth from this position until best setting is found for smooth engine operation.

(2) **IDLING SPEED ADJUSTMENT.** Adjust idling speed by turning throttle lever stop screw until engine idles at approximately 350 revolutions per minute. Carburetor idling and throttle stop screw must be adjusted in combination with each other to secure best idling performance. After idling speed is set, recheck mixture idling adjustment.

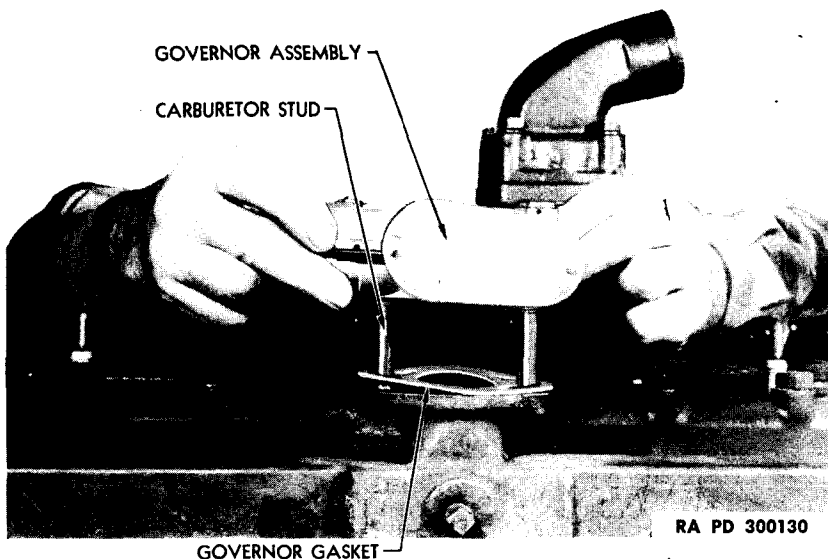

Figure 36—Removing Governor

(3) **MAINTENANCE.** Check carburetor hold-down bolts for tightness. Note adjustment of hand, choke, and throttle controls. With choke pull button ¼ inch from instrument panel, choke valve must be wide open, and throttle valve idling adjustment screw must be against stop. Inspect accelerator pedal, linkage, and return spring for free action.

c. Remove Carburetor. Remove air cleaner from carburetor (par. 75 a). Disconnect carburetor controls (par. 72). Disconnect fuel pump to carburetor line at carburetor. Loosen two stud nuts that hold carburetor to governor assembly. Remove front stud nut first, then while elevating carburetor assembly (fig. 37) remove the rear stud nut.

2½-TON 4 x 2 TRUCK (FEDERAL)

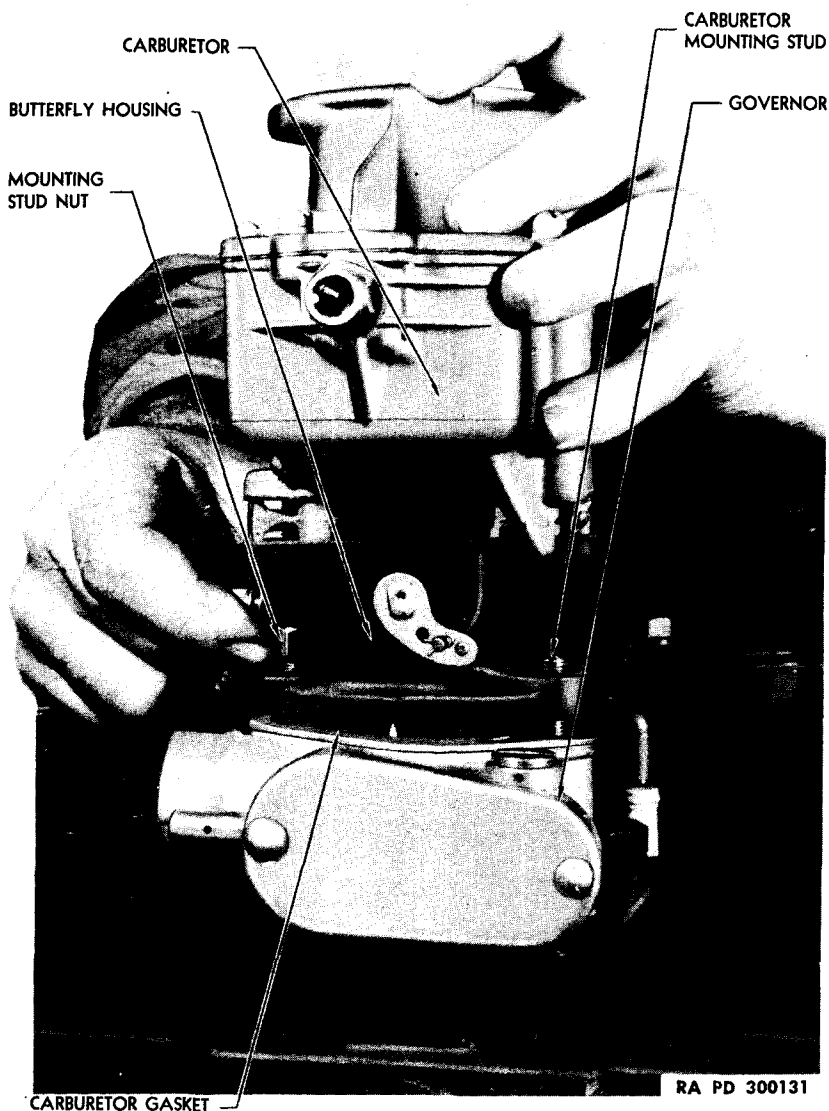

Figure 37—Removing Carburetor Assembly

Remove carburetor and gaskets by lifting off from carburetor mounting studs.

d. **Install Carburetor.** Place carburetor gasket in position on carburetor mounting studs and place carburetor assembly in position over gasket. While holding carburetor in elevated position (fig. 37)

FUEL SYSTEM

place stud nut on rear carburetor mounting stud. Place stud nut on front carburetor mounting stud and draw up snug. Tighten rear and front mounting stud nuts alternately until carburetor is properly seated. Connect fuel pump to carburetor fuel line, tightening connector nuts securely (par. 72). Connect carburetor controls (par. 73). Install air cleaner (par. 75).

69. FUEL PUMP.

a. Description. The fuel pump (fig. 38) is the diaphragm type, mechanically operated from the camshaft. The pump is equipped with

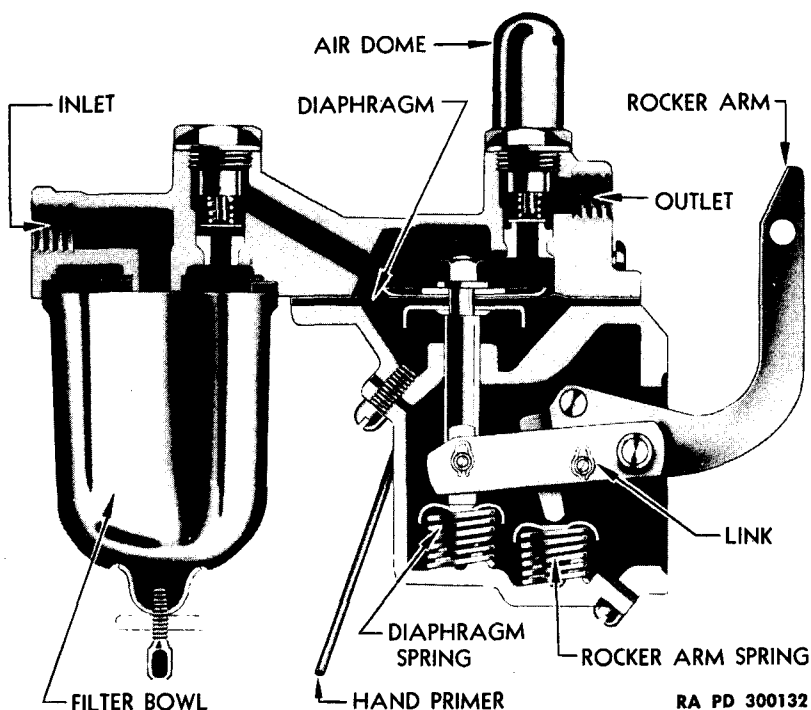

RA PD 300132

Figure 38—Fuel Pump

a hand lever for operation in emergency, to force a supply of fuel into the carburetor bowl.

b. Maintenance. Unscrew knurled retaining nut at bottom of sediment bowl and remove sediment bowl. Clean bowl in dry-cleaning solvent, and wipe with clean rag. Note condition of sediment bowl and gasket, and replace if necessary. Install sediment bowl, tightening retaining nut securely. Start engine and check fuel pump assembly for leaks.

2½-TON 4 x 2 TRUCK (FEDERAL)

c. **Fuel Pump Removal.** Disconnect fuel pump to carburetor fuel line at fuel pump. Disconnect fuel pump flexible fuel line at frame junction bracket. Remove two fuel pump to crankcase cap screws and lift fuel pump away from engine. Disconnect flexible fuel line at fuel pump body.

d. **Install Fuel Pump.** Connect fuel pump flexible fuel line at fuel pump body. Install fuel pump on crankcase, using new fuel pump to crankcase gasket. Tighten two mounting cap screws securely. Connect fuel pump to carburetor line. Connect flexible fuel line at frame junction bracket.

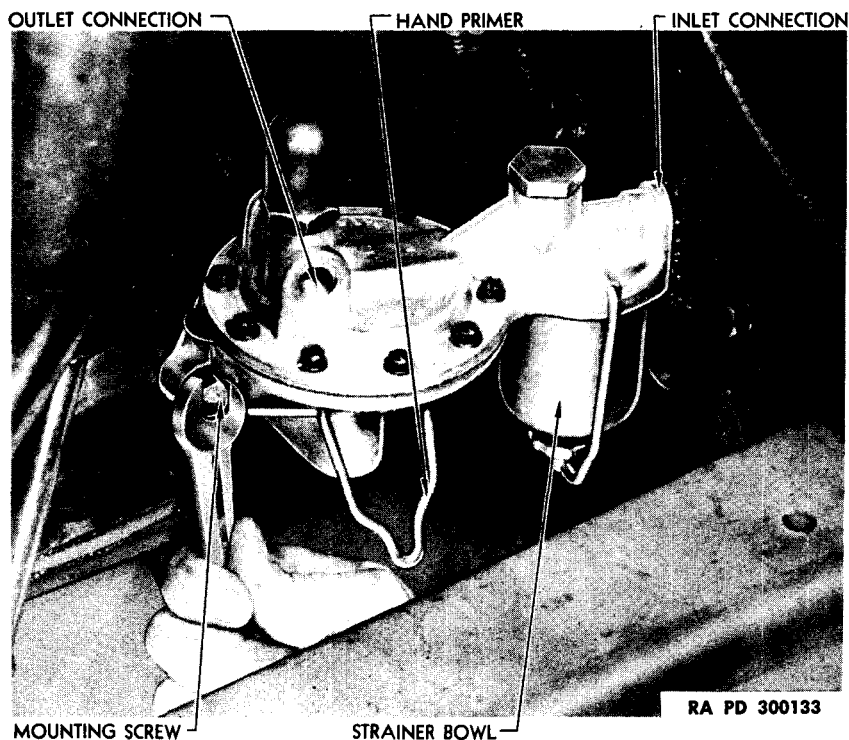

Figure 39—Removing Fuel Pump

e. **Remove Fuel Pump Diaphragm.** Remove nine screws holding fuel pump upper section to lower section. Remove lower section lower cover, and disconnect diaphragm pull rod at driving lever. Lift diaphragm and pull rod assembly out of lower section. Remove diaphragm pull rod nut, lift off alignment washer, and separate diaphragm from pull rod.

f. **Install Fuel Pump Diaphragm.** With pull rod gasket and diaphragm, lower protector into position on pull rod, and place new

FUEL SYSTEM

diaphragm on rod. Follow with diaphragm upper protector alignment washer, lock washer, and diaphragm nut. Tighten nut securely. Place diaphragm and pull rod assembly in lower section and attach lower end of pull rod to linkage. Place upper section of fuel pump on lower section. Note carefully alignment of diaphragm holes with nine holes in body upper and lower sections. Install nine attaching screws and tighten evenly. Move fuel pump lever and note action at diaphragm pull rod. Install lower cover, using new gasket.

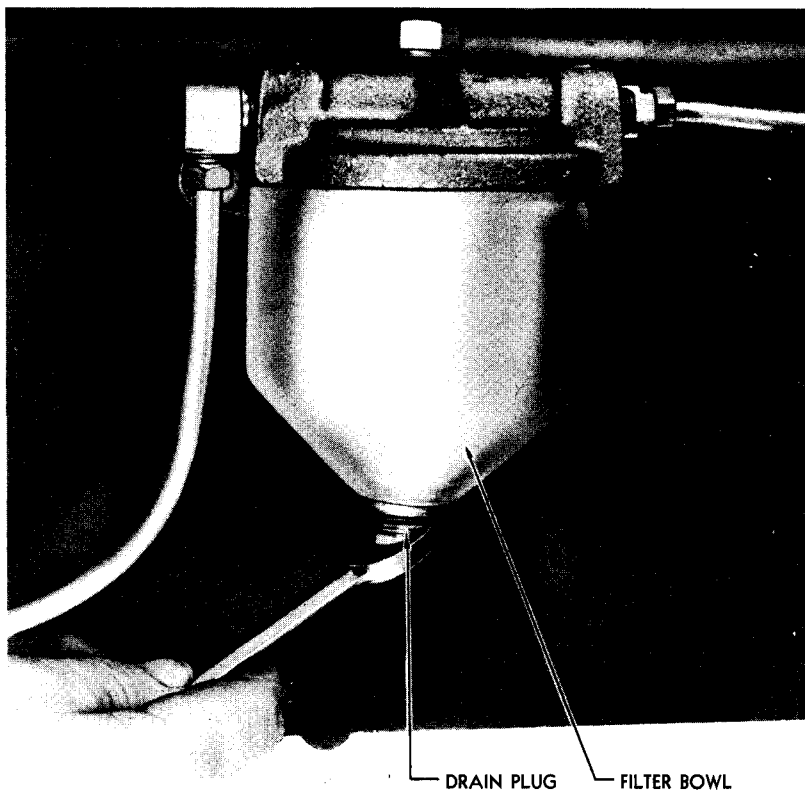

RA PD 300134

Figure 40—Draining Fuel Filter Bowl

70. FUEL FILTER.

a. **Description.** Fuel filter (fig. 40) is mounted on left-hand frame side rail between fuel tank and fuel pump. Laminated filtering element removes water and dirt from fuel, and sediment settles in the bottom of the body.

2½-TON 4 x 2 TRUCK (FEDERAL)

b. **Remove Filter Element.** Unscrew cover bolt holding bowl to cover and remove bowl. Lift filler element and spring from filter bowl.

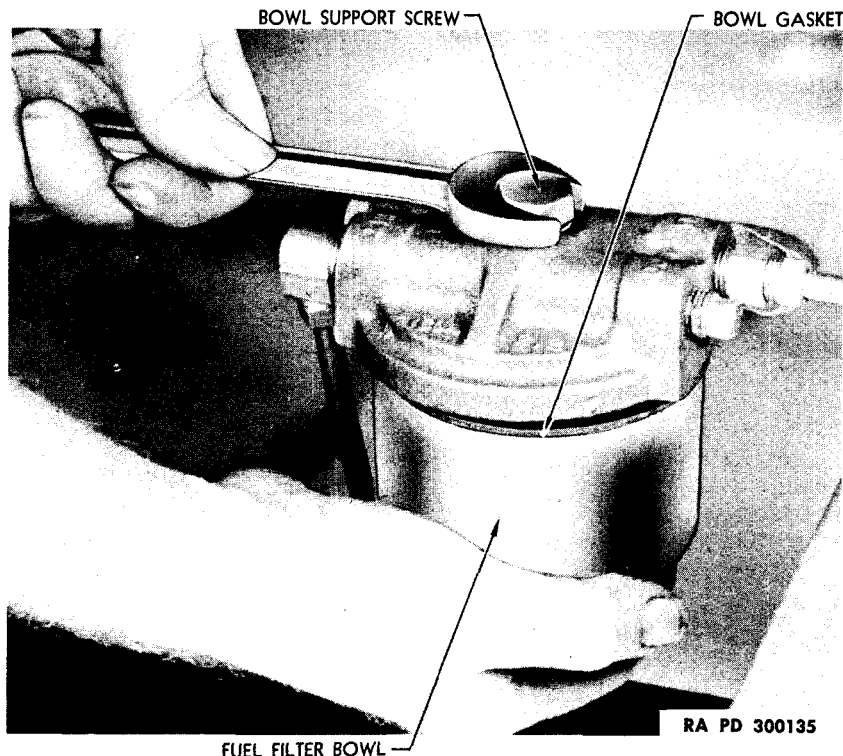

Figure 41—Removing Fuel Filter Element

c. **Service.** Clean fuel filter element of all foreign matter. Dip in dry-cleaning solvent, and be sure that all particles are removed from between plates. Blow dry with air. Clean bowl thoroughly before reassembly. Inspect gaskets for condition and replace if damaged.

d. **Install Filter Element.** Place filter element spring and element in filter bowl. Install bowl gasket in filter cover and secure bowl to filter cover with bolt.

71. FUEL TANK.

a. **Description.** Conventional metal fuel tank of 40-gallon capacity is mounted behind cab on left-hand frame side rail.

b. **Remove Fuel Tank.** Drain fuel from tank in suitable container. Disconnect fuel line at tank. Disconnect fuel gage tank unit wire. Support tank while removing strap to bracket bolts. Lower tank to ground and remove.

FUEL SYSTEM

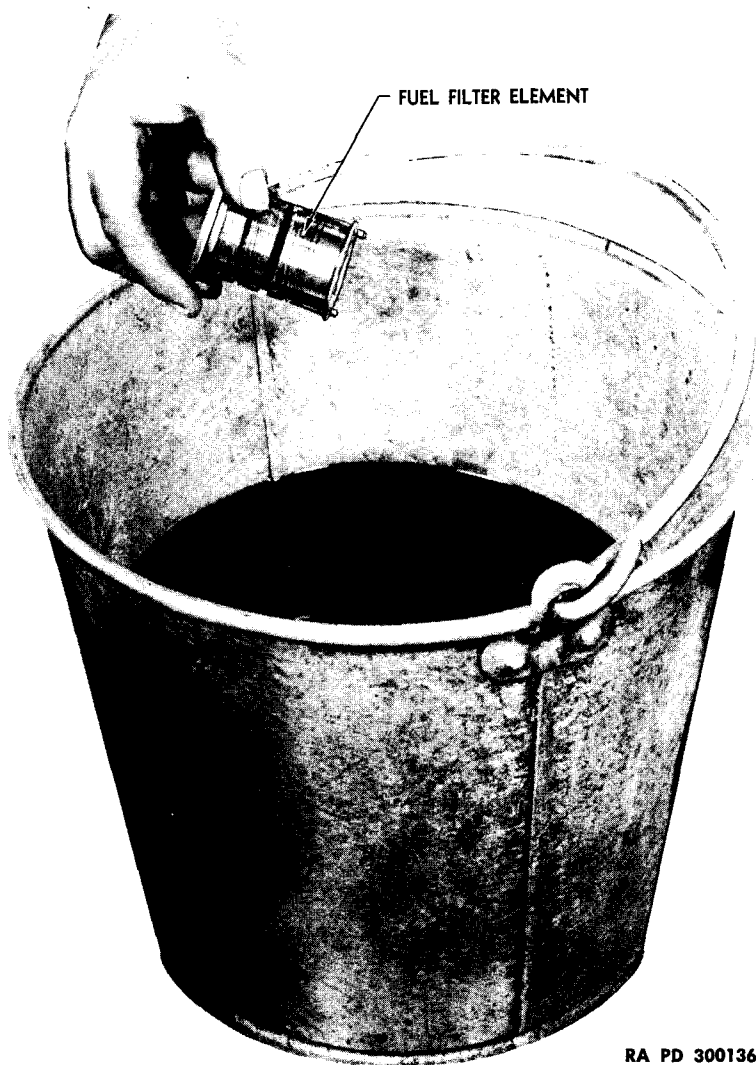

RA PD 300136

Figure 42—Cleaning Fuel Filter Element

c. **Clean Fuel Tank.** Put in a gallon of dry-cleaning solvent, and agitate the tank well to loosen any solidified sediment. Drain thoroughly before installing on vehicle.

d. **Install Fuel Tank.** Place tank in position and rest on suitable blocks while attaching strap to bracket bolts. Connect fuel gage tank unit wire to gage terminal. Connect fuel line to tank connection. Remove blocking and fill tank.

2½-TON 4 x 2 TRUCK (FEDERAL)

72. LINES AND CONNECTIONS.

a. **Description.** A metal line conducts the fuel from the tank through the filter to a connector located on the chassis side frame near the fuel pump. A flexible line leads from this connector to the fuel pump inlet fitting. Fuel from the pump to carburetor travels through a metal line (fig. 35).

b. **Remove Lines and Connections.** Loosen and disconnect fitting on each end of line being removed. Detach line from supporting clamps and remove line from chassis.

c. **Install Lines and Connections.** Place line in position and secure with supporting clamps. Tighten connections and fittings on each end of line. Always use two wrenches on fuel line fitting to avoid twisting line.

73. CONTROLS AND LINKAGE.

a. **Remove Choke Control.** Loosen choke control cable clamp at carburetor. Loosen pull wire trunnion clamp screw and pull cable and control wire away from carburetor. Remove hex lock nut from pull button fitting and withdraw entire cable assembly from instrument panel.

b. **Install Choke Control.** Pass choke cable control assembly through instrument panel and lock pull button fitting in position with hex lock nut. Pass cable through dash and clamp in position at carburetor. With pull button $\frac{1}{16}$ inch out from instrument panel fitting, and choke valve in wide open position, clamp pull wire at carburetor with trunnion clamp screw.

c. **Remove Throttle Control.** Loosen throttle control cable clamp at carburetor. Loosen pull wire trunnion clamp screw and pull cable and control wire away from carburetor. Remove hex lock nut from pull button fitting and withdraw entire cable assembly from instrument panel.

d. **Install Throttle Control.** Pass throttle cable control assembly through instrument panel, and lock pull button in position with hex lock nut. Pass cable through dash and clamp in position at carburetor. With pull button $\frac{1}{16}$ inch out from instrument panel fitting, and throttle valve in closed position, clamp pull wire at carburetor with trunnion clamp screw.

e. **Remove Accelerator Pedal.** Unhook accelerator pedal linkage return spring. Disconnect accelerator rod ball joint from carburetor throttle shaft lever. Remove floor toeboard, accelerator pedal, and cross shaft linkage as an assembly.

f. **Install Accelerator Pedal.** Install toeboard, accelerator pedal, and cross shaft linkage as an assembly. Connect accelerator rod ball joint to carburetor throttle shaft lever. Connect accelerator pedal return spring.

Section XVI

INTAKE AND EXHAUST SYSTEMS

	Paragraph
Description	74
Intake system	75
Exhaust system	76

74. DESCRIPTION.

a. **Intake System.** The intake system consists of the air cleaner mounted directly above the carburetor. The cleaner is of the oil-bath type with an oil-wetted copper mesh element, which removes dirt from the air, entering the engine.

b. **Exhaust System.** The exhaust system consists of an exhaust pipe, muffler, tail pipe, and attaching parts for these units. The pri-

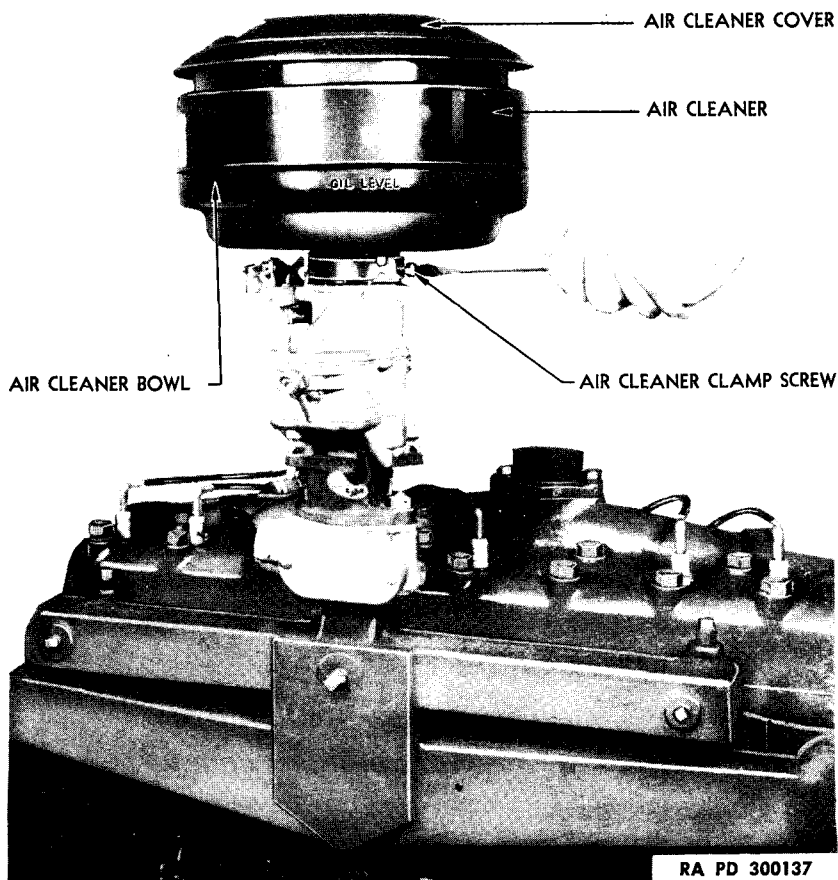

RA PD 300137

Figure 43—Removing Air Cleaner Assembly

2½-TON 4 x 2 TRUCK (FEDERAL)

mary purpose of the exhaust system is to carry the exhaust gases away from the engine, and to muffle or reduce the combustion noises of the engine. The complete system is installed at the right-hand side of chassis, and is accessible from engine compartment and from beneath vehicle.

75. INTAKE SYSTEM.

a. **Air Cleaner Removal.** Remove air cleaner brace wing screw on side of bowl. Loosen air cleaner to carburetor clamp screw, and lift entire air cleaner assembly from carburetor. Be careful to hold the air cleaner level while carrying it away from vehicle, in order to avoid spilling the oil.

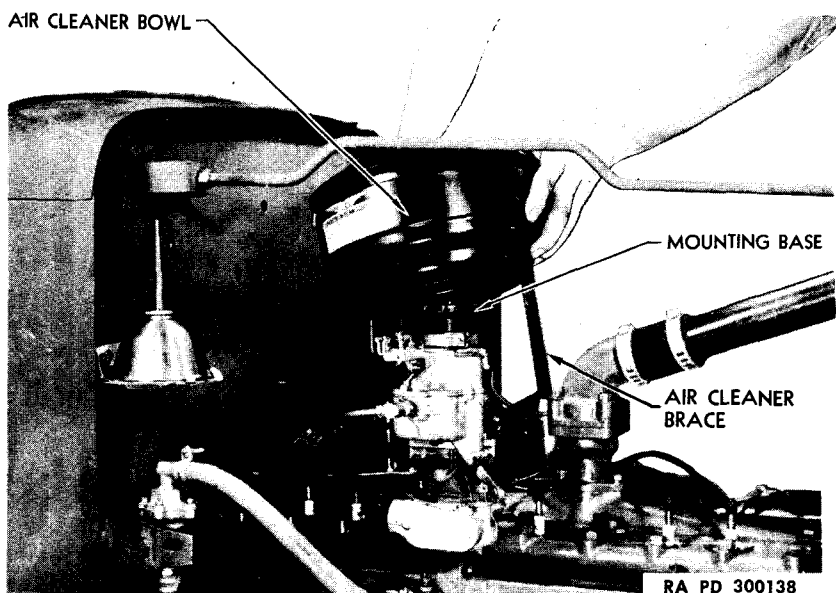

Figure 44—Removing Air Cleaner Bowl

b. **Air Cleaner Service.** Remove wiring bolt at center of air cleaner cover and separate cover from bowl. Clean filter element thoroughly by flushing in a pan of dry-cleaning solvent. Blow dry with compressed air, being careful not to compress or disarrange copper wool with too high pressure. Dip element in clean engine oil and allow excess to drain before assembling with bowl. Fill air cleaner bowl with clean oil before assembling with element.

c. **Air Cleaner Installation.** Place assembly in position on top of carburetor inlet. Install air cleaner brace and fasten in position with wing nut. Tighten air cleaner to carburetor clamp screw.

INTAKE AND EXHAUST SYSTEMS



RA PD 300139

Figure 45—Cleaning Air Cleaner Bowl

76. EXHAUST SYSTEM.

a. **Exhaust Pipe and Muffler Removal.** Remove support bolts from front and rear of muffler, at cross member and below cranking motor mounting. Remove clamp bolt from each support. Remove two cap screws which connect upper and lower flanges at manifold. Loosen

2½-TON 4 x 2 TRUCK (FEDERAL)

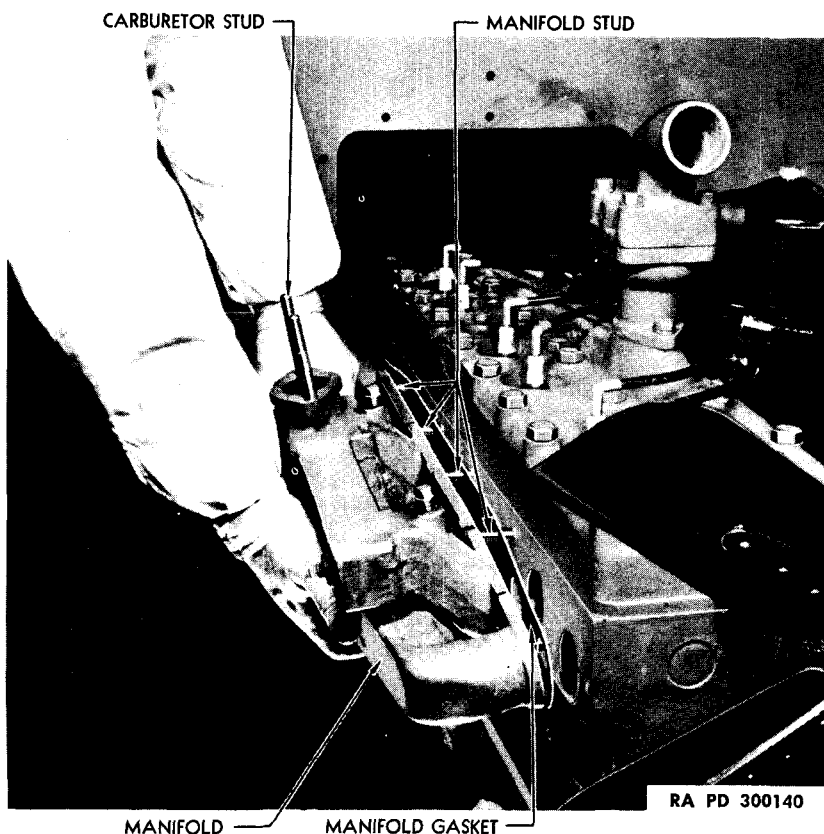

Figure 46—Removing Manifold and Gasket

clamp screws from front and rear of muffler, and pull exhaust and tail pipe from muffler fitting.

b. Exhaust Pipe and Muffler Installation. Place exhaust and tail pipe in position on muffler fittings and place entire unit in position. Connect all support straps and tighten clamp bolts securely. Connect exhaust pipe flange and tighten the two cap screws evenly and securely.

Section XVII

COOLING SYSTEM

	Paragraph
Description and tabulated data	77
Water pump	78
Radiator assembly	79
Fan belt and fan and hub assembly	80
Hose connections	81
Thermostat	82

77. DESCRIPTION AND TABULATED DATA.

a. **Description.** The cooling system consists of a radiator, fan and shroud, water pump, thermostat, temperature gage, engine water by-pass tube, connecting hose and fittings, and the cooling liquid. When engine is operating, water is drawn from bottom of radiator by centrifugal-type water pump which is mounted on left-hand side of the engine. The water pump forces the cooling liquid through the water jackets in the cylinder block and the cylinder head, and completes the circulation by returning the water through the upper connection to the radiator, where it is cooled by the action of the fan drawing air through the radiator core. The thermostat assists in maintaining the engine temperature by restricting the water flow to radiator until a predetermined engine temperature is obtained. The engine water by-pass tube permits an adequate portion of the water to circulate in the engine, to assure uniform temperature in the engine.

b. Tabulated Data.

Radiator core	Area 473 sq in.
Radiator core	Thickness, 4-in.
Cooling system capacity	22-qt
Water pump capacity	65 gpm
Thermostat operating temperature	165°F

78. WATER PUMP.

a. **Description.** The water pump is impeller type and is supported by a special flange from the front of the crankcase on the left side. The pump is driven by the timing gear train in conjunction with the distributor.

b. Maintenance and Adjustment.

(1) **ADJUSTING WATER PUMP PACKING.** Water pump packing requires adjustment from time to time to prevent leaks from water pump. Packing nut is accessible for adjustment without removing water pump or other units. Turn packing nut inward to tighten packing. The packing nut requires very little pressure, due to ample width of packing used. When tightening packing nut to stop a water leak,

2½-TON 4 x 2 TRUCK (FEDERAL)

use very little force, and if the leak does not stop, then repack or replace pump assembly.

(2) **PACKING WATER PUMP.** Split-ring type packing is furnished for service, so that pump can be packed without removing unit from



RA PD 300141

Figure 47—Removing Water Pump Assembly

engine. Pump can be packed without removing either the distributor or ignition coil; however, accessibility is greatly improved if either of these units is removed. Unscrew packing nut. Pry packing gland out of housing and remove old packing. Install new split type packing and slide gland back into position. Screw packing nut into pump; do not tighten nut. First fill radiator with water or antifreeze compound;

COOLING SYSTEM

start engine, and inspect for leaks. Tighten packing nut while engine is running.

c. Water Pump Removal.

(1) **DRAIN COOLING SYSTEM.** Open drain cock at bottom of water pump (fig. 50).

(2) **REMOVE DISTRIBUTOR AND IGNITION COIL.** Remove distributor and ignition coil (pars. 87 and 89). Carefully lift the distributor from its bearings so as not to move the distributor shaft.

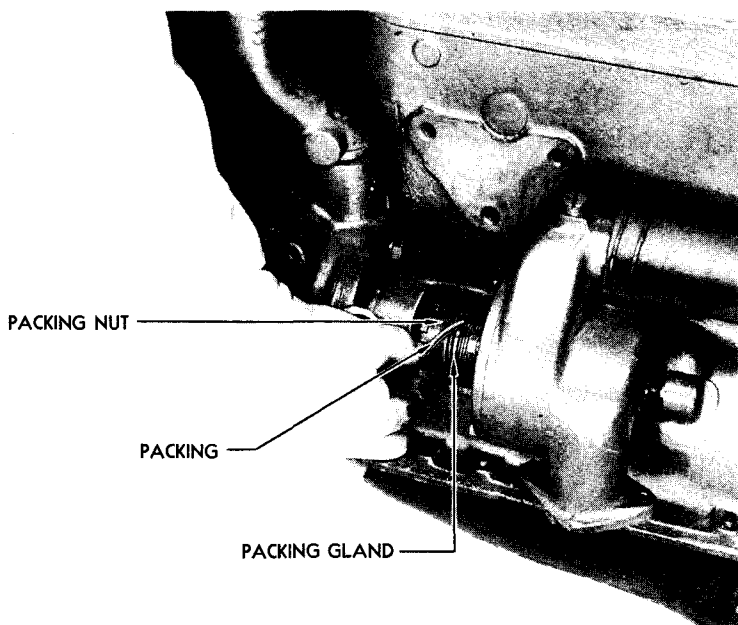

RA PD 300142

Figure 48—Adjusting Water Pump Packing

(3) **MARK DISTRIBUTOR SHAFT TIMING POSITION.** Holding the distributor, place a straightedge on the shaft bearing in line over the drive gear retaining pin and scribe a line on the pin and bearing which will indicate the position of the gear when distributor is installed.

(4) **DISCONNECT PUMP INLET AND ENGINE BYPASS TUBE.** Disconnect pump inlet hose clamp and engine bypass tube clamp at water pump. Disconnect water pump discharge hose.

(5) **REMOVE PUMP ATTACHING SCREWS.** Remove three cap screws and lock washers holding pump assembly (fig. 47) to rear of gear housing.

(6) **REMOVE PUMP ASSEMBLY.** Pull water pump backward until gear is clear of timing gear housing and lift out water pump assembly.

2½-TON 4 x 2 TRUCK (FEDERAL)

Remove pump gasket and elbow gasket. It may be necessary to tap the pump lightly to free the sleeve mounting from the gear case before the pump can be pulled out.

d. Water Pump Installation.

- (1) **INSTALL WATER PUMP ASSEMBLY.** Place water pump assem-

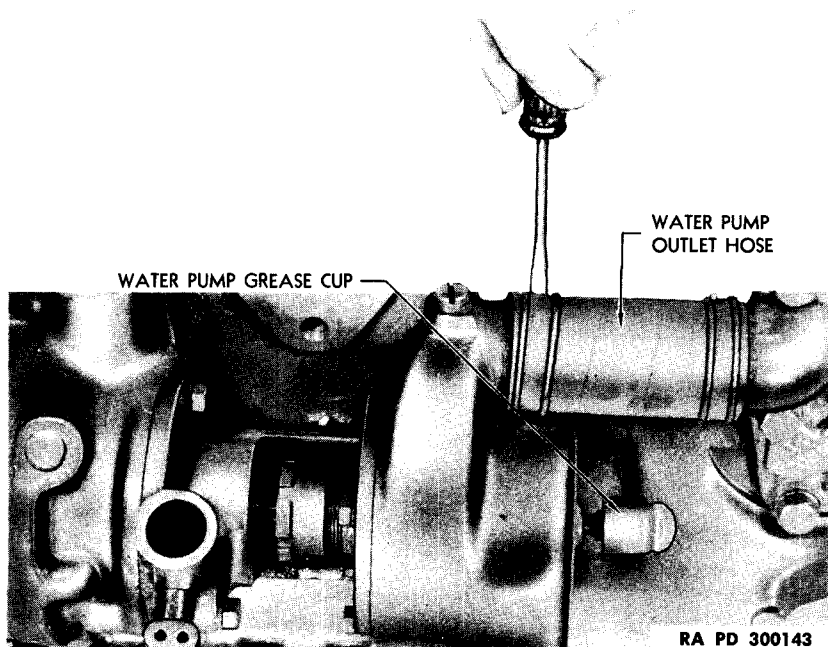

Figure 49—Removing Water Pump Outlet Hose

bly in position so that pump drive gear meshes with idler gear in gear case. Use new gaskets between pump assembly and gear housing and between discharge pipe and block. Secure assembly between gear housing with lock washers and cap screws.

- (2) **CONNECT HOSE.** Connect radiator outlet hose and engine

COOLING SYSTEM

bypass tube hose to pump inlet elbow. Connect water pump discharge hose, then tighten hose clamps.

(3) **INSTALL DISTRIBUTOR ON PUMP COVER.** Make sure that scribed lines on distributor bearing and on drive gear retaining pin are in line. Install distributor (par. 87).

(4) If the engine is rotated for the removal of other parts, or for any other reason, during the time that the water pump and distributor are removed from the engine, the ignition must be timed (par. 84). After the water pump has been installed and water replaced in the cooling system, run the engine at idling speed. Inspect the hose connections, flanges, and packing nut for water leaks.

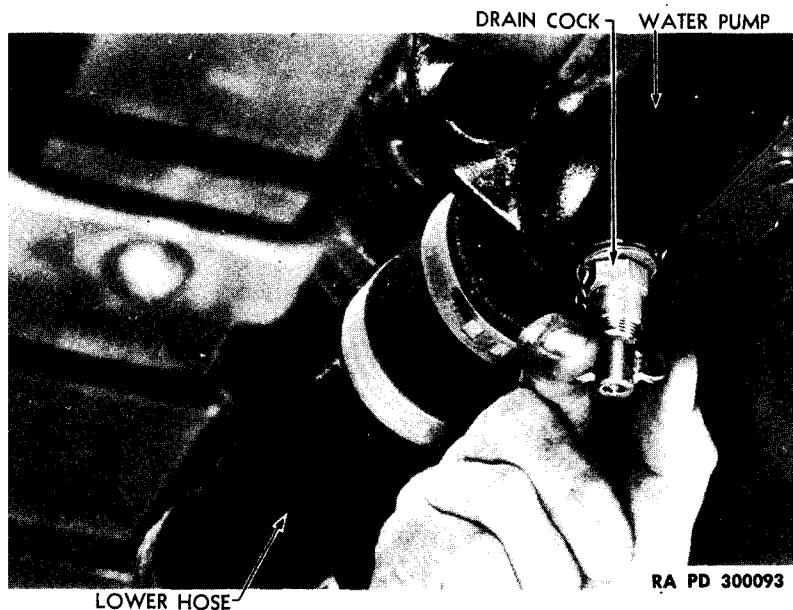

Figure 50—Draining Cooling System

79. RADIATOR ASSEMBLY.

a. **Description.** Radiator core is of fin and tube construction and is provided with a permanently attached shroud. Radiator core and brush guard are mounted together as an assembly at front of vehicle.

b. **Remove Radiator Assembly.** Remove core and brush guard as complete assembly.

(1) **REMOVE BRUSH GUARD TO SIDE PANEL BOLTS.** Remove 12 bolts, nuts, and lock washers (six on each side) which attach outer vertical bar of brush guard to side panel (fig. 52).

(2) **DRAIN SYSTEM.** Open drain cock at bottom of water pump and drain radiator.

2½-TON 4 x 2 TRUCK (FEDERAL)

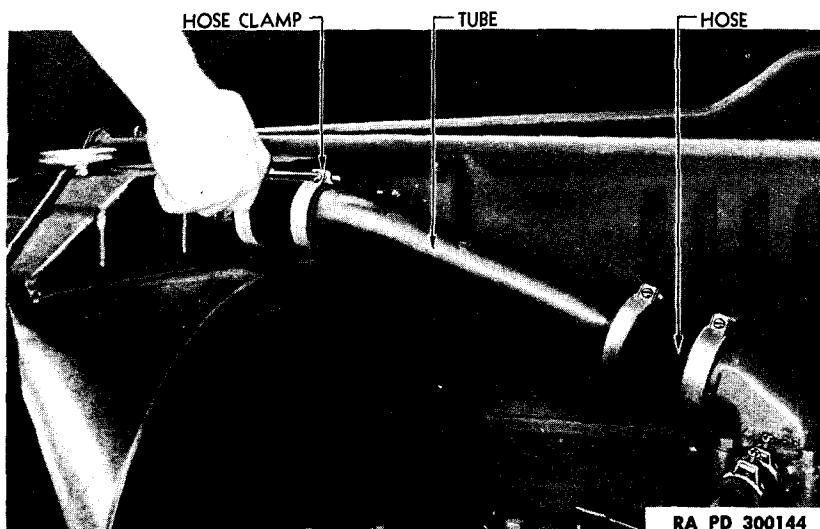

Figure 51—Disconnecting Radiator Hose

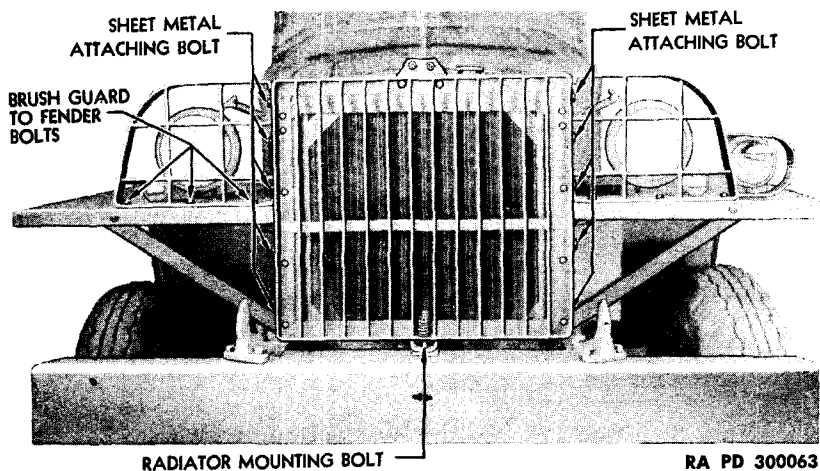

Figure 52—Radiator Mounting

(3) **DISCONNECT HOSE.** Loosen hose clamp screws and disconnect hose from radiator inlet and outlet pipes.

(4) **DISCONNECT RADIATOR TIE ROD.** Remove bolts which attach radiator tie rod to bracket at front of radiator.

(5) **DISCONNECT RADIATOR LOWER CENTER MOUNTING.** Remove cotter pin, castle nut, through bolt, and spring from lower center of

COOLING SYSTEM

brush guard at front cross member (fig. 52). Do not lose insulating spacer between brush guard and cross member.

(6) **REMOVE RADIATOR AND BRUSH GUARD ASSEMBLY FROM VEHICLE** (fig. 52).

(7) **REMOVE BOLTS.** Remove six brush guard to fender bolts, nuts, and lock washers (three on each side) (fig. 52).

(8) **REMOVE BRUSH GUARD FROM RADIATOR.** Remove eight bolts, nuts, and lock washers which attach brush guard side supports to radiator core flanges. Remove radiator assembly (fig. 52).

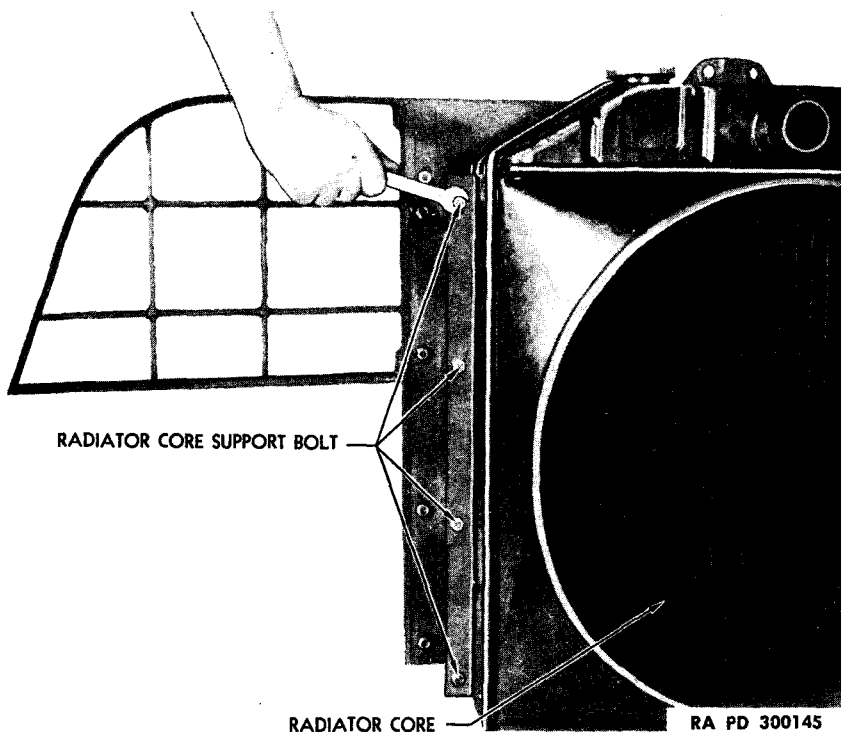

Figure 53—Removing Brush Guard from Radiator

c. Install Radiator Assembly.

(1) **ATTACH BRUSH GUARD TO RADIATOR.** Install and tighten eight bolts, nuts, and lock washers which attach brush guard side support to radiator core flange (fig. 53).

(2) **INSTALL RADIATOR AND BRUSH GUARD ASSEMBLY.** Place unit in position on front cross member. Make sure insulating spacers are installed between brush guard and cross member.

(3) **INSTALL MOUNTING BOLTS.** Install 12 bolts, nuts, and lock

2½-TON 4 x 2 TRUCK (FEDERAL)

washers attaching brush guard to side panel. Install six bolts, nuts, and lock washers attaching brush guard to fender.

(4) **INSTALL LOWER CENTER SPRING MOUNTING.** Install through bolt, spring, nut, and cotter pin at lower mounting. Do not compress spring excessively when tightening nut.

(5) **CONNECT RADIATOR TIE ROD.** Install and tighten two bolts which attach tie rod to bracket at front of radiator.

(6) **CONNECT HOSE.** Connect inlet and outlet hose at top and bottom of radiator and tighten clamps securely.

(7) **FILL SYSTEM.** Add water or antifreeze compound to cooling system and inspect all connections for leaks.

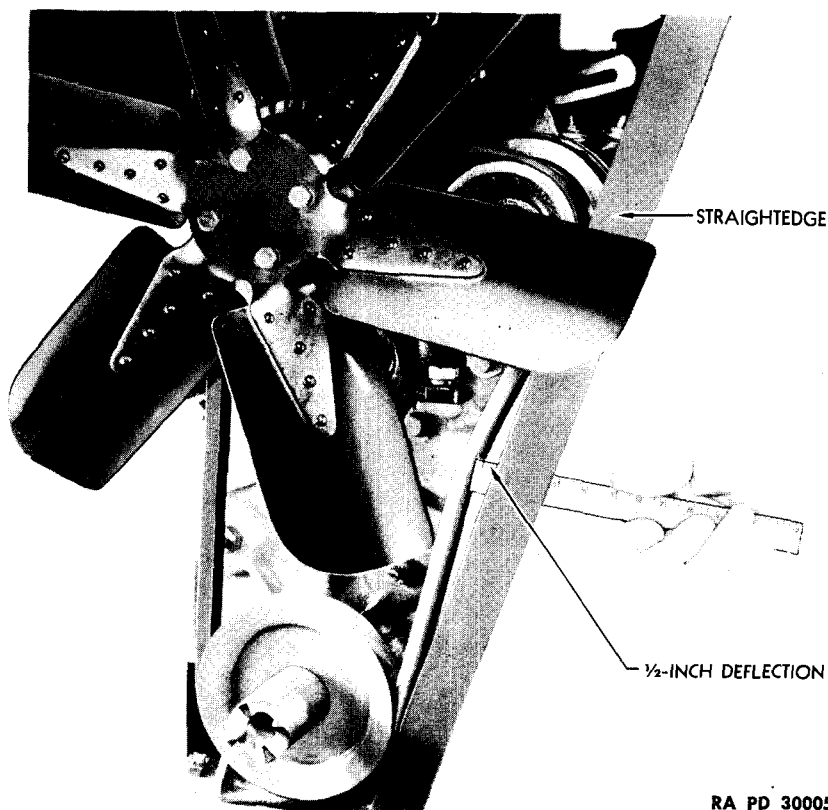

RA PD 300057

Figure 54—Measuring Fan Belt Deflection

80. FAN BELT AND FAN AND HUB ASSEMBLY.

a. **Description.** A single V-type belt, driven from the engine crankshaft pulley, is used to drive the fan and generator. The fan and

COOLING SYSTEM

hub assembly is mounted on a special bracket which is attached to the timing gear case with two cap screws.

b. Maintenance and Adjustment.

(1) **FAN BELT ADJUSTMENT.** Loosen two generator to mounting bracket bolt nuts and then loosen generator to adjusting arm bolt (fig. 55). Move generator toward, or away from, engine as necessary to obtain correct belt tension. A light pressure on belt at a point midway between crankshaft and fan pulley must cause a $\frac{1}{2}$ - to $\frac{3}{4}$ -inch deflection (fig. 54). Do not adjust belt too tight. Tighten generator to adjusting arm bolt and then tighten the two generator to mounting bracket bolt nuts.

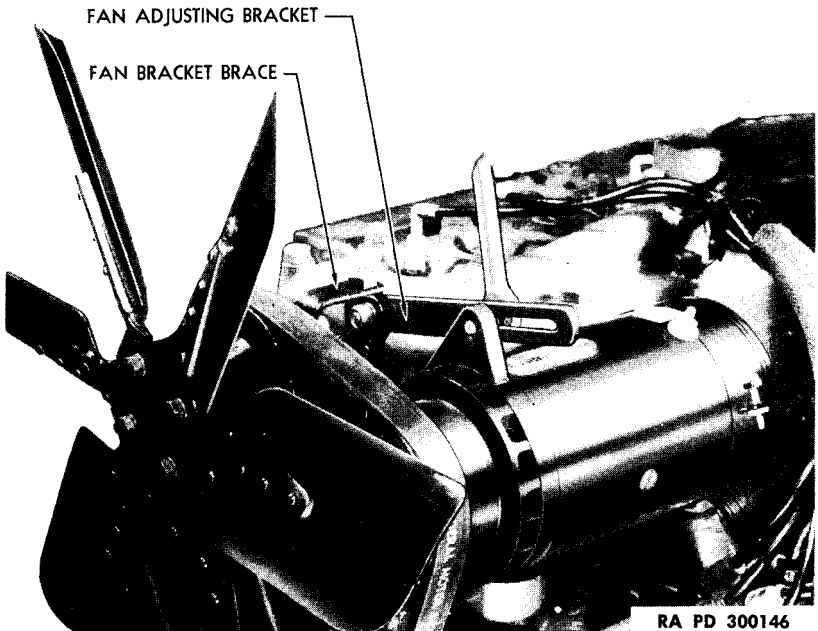

Figure 55—Adjusting Fan Belt Tension

(2) **FAN AND HUB MAINTENANCE.** Fan hub bearings require periodic lubrication. Figure 56 shows removal of plug for insertion of pressure fitting in preparation for application of lubricant. Refer to paragraph 20 for proper lubricant and recommended lubrication intervals.

c. **Remove Fan Belt.** Loosen generator mounting. Loosen two generator to mounting bracket bolt nuts and loosen generator to

2½-TON 4 x 2 TRUCK (FEDERAL)

adjusting arm bolt. Move generator toward engine as far as it will go. Remove belt from generator pulley, fan pulley, and crankshaft pulley. Remove belt over fan blade.

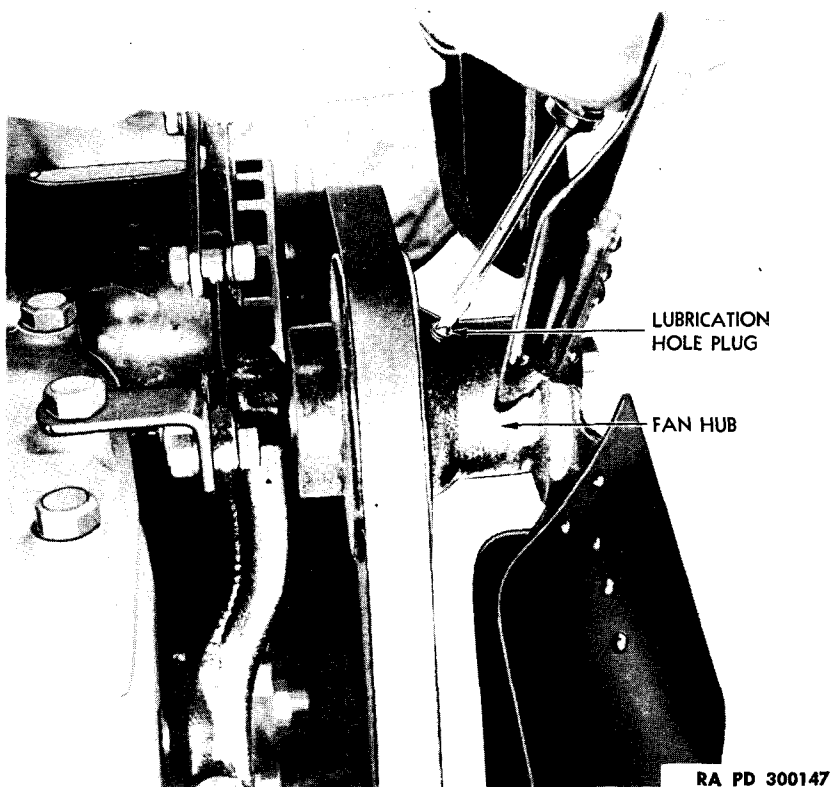
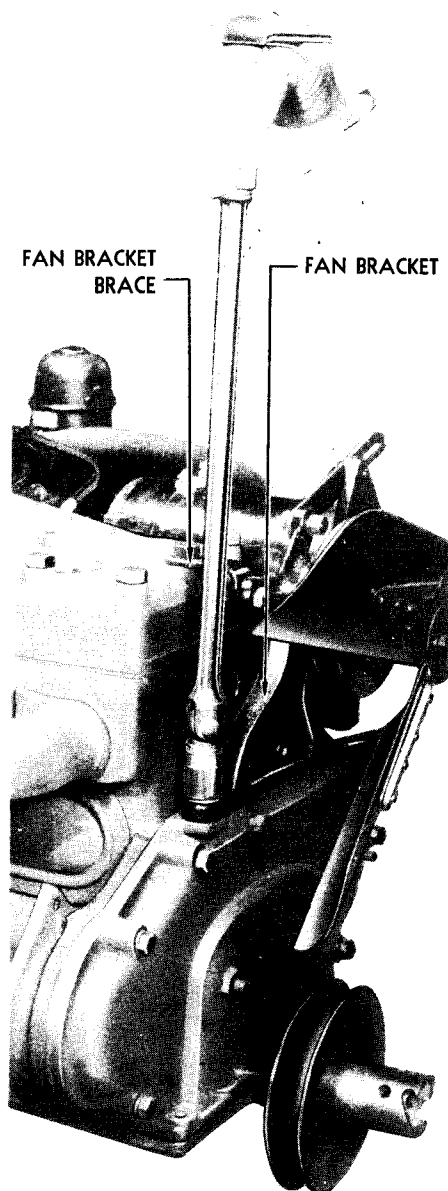

Figure 56—Lubricating Fan Hub

d. Install Fan Belt. Place fan belt over fan blades and then install on fan, crankshaft, and generator pulleys. Adjust belt to proper tension (step b above).

e. Remove Fan and Hub. Remove fan belt from hub (step c above). Loosen and remove generator brace bolt at fan hub bracket.

COOLING SYSTEM



RA PD 300148

Figure 57—Removing Fan and Hub Assembly

2½-TON 4 x 2 TRUCK (FEDERAL)

f. **Install Fan and Hub.** Place fan and hub in position, install generator brace bolt. Install fan belt and adjust (step b above).

81. HOSE CONNECTIONS.

a. **Hose Connections Removal.** Remove clamp screws from clamps at both ends of hose. Move clamps inward (away from hose ends) sufficient distance to clear tubing. Remove hose from tubing by flexing hose in middle and pulling straight away.

b. **Hose Connections Installation.** Position clamps two inches away from each end of hose. Secure clamp bolt in nut, but do not

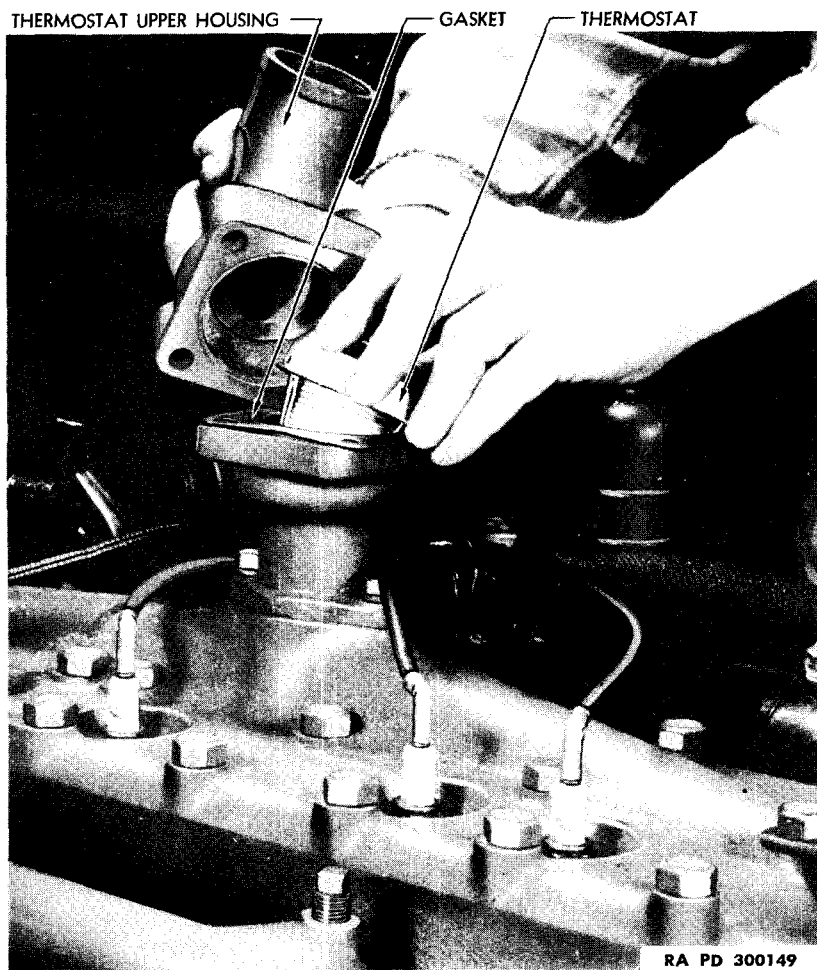

RA PD 300149

Figure 58—Removing Thermostat

COOLING SYSTEM

tighten to crimp hose. When hose is positioned over fitting, move clamp into position, and tighten bolt securely.

82. THERMOSTAT.

a. **Description.** The thermostat is installed in a housing at the cylinder head water outlet above the engine. Thermostat valve "cracks" or just starts to open, at 157°F and continues to open in gradual stages until temperature reaches 183°F, at which point water flow is unrestricted.

b. **Remove Thermostat.** Drain approximately four quarts coolant from cooling system (fig. 50). Disconnect engine water outlet hose at thermostat housing. Disconnect engine water bypass tube hose at thermostat housing. Remove four cap screws from thermostat upper housing. Swing air cleaner support brace to one side. Lift thermostat out of housing. Note relative position of thermostat in housing, to avoid installing upside down (fig. 58).

c. **Test Thermostat.** Place thermostat in water and heat the water gradually until opening temperature of thermostat is reached. Check action of thermostat and if unit does not open and close at proper temperatures (step a above), a new thermostat must be installed.

d. **Install Thermostat.** Place thermostat in housing in proper position (fig. 58). Place upper housing in position on cylinder head water outlet and install and tighten four cap screws. Secure air cleaner brace in air cleaner bowl. Connect outlet hose and engine bypass tube hose to thermostat housing. Tighten hose clamps securely. Refill system with water or antifreeze compound; start engine and inspect all connections for leaks.

2½-TON 4 x 2 TRUCK (FEDERAL)

Section XVIII

IGNITION SYSTEM

	Paragraph
Description and tabulated data	83
Ignition timing	84
Distributor points	85
Distributor condenser	86
Distributor assembly	87
Spark plugs	88
Ignition coil	89
Ignition wiring	90
Ignition switch	91

83. DESCRIPTION AND TABULATED DATA.

a. **Description.** The ignition system comprises an ignition switch, a source of electrical energy (battery or generator), an ignition coil, a distributor assembly, six spark plugs, and the necessary high- and low-tension wires to connect the units (fig. 64). There are two distinct electrical circuits in the ignition system—the primary circuit and the secondary circuit. Briefly, these circuits function in the following manner: With the ignition switch turned on and the distributor contact points closed, current flows through the primary winding of the ignition coil and builds up a strong magnetic field in the coil. This magnetic field collapses and induces a high voltage in the secondary winding of the coil every time the distributor contact points open. This induced high voltage is distributed to the spark plugs at correct firing intervals by the distributor cap and rotor, and the high-tension wires between distributor cap and spark plugs.

b. Data.

(1) DISTRIBUTOR.

Make	Auto-Lite
Model	1GC-4709
Breaker point gap	0.020 in.
Breaker arm tension	17 to 20 oz
Firing order	1-5-3-6-2-4
Timing	6 degrees before TDC

84. IGNITION TIMING.

a. **Timing Distributor.** The correct basic ignition timing is six degrees before top dead center. If engine has been rotated from original position before reinstallation of distributor, proceed as follows:

IGNITION SYSTEM

(1) **SET NO. 1 PISTON.** The No. 1 piston (nearest the front of the engine) must be set exactly on top dead center at the end of the compression stroke. Remove No. 1 spark plug. Remove front valve tappet cover on right side of engine. Turn engine slowly with hand crank. Compression stroke begins with both intake and exhaust valve (front pair) closed in down position. Feel with wire through spark plug hole for approach of piston toward top of compression stroke, and halt engine rotation just before top is reached. Observe flywheel marking

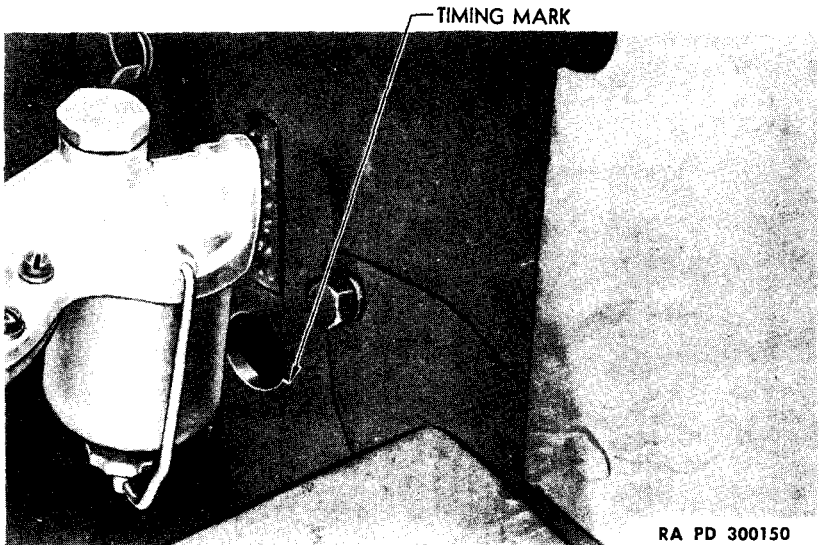

RA PD 300150

Figure 59—Timing Mark Inspection Hole

through flywheel timing hole at left rear of engine. Rotate engine slowly with crank until flywheel timing mark "DC" lines up exactly with timing mark on flywheel housing. Use mirror for clear view if necessary. The No. 1 piston is now set at top dead center at end of compression stroke.

(2) **TRACE NO. 1 SPARK PLUG LEAD.** Remove distributor cap and trace the high-tension lead from the No. 1 spark plug through the cap. Scribe a mark on the outside of the cap identifying the No. 1 terminal. If other leads have been disturbed in cap, they too should now be traced, proceeding in a clockwise direction from No. 1 terminal tracing consecutively to cylinders 5-3-6-2-4. Place cap in position on distributor housing and scribe a mark on the housing directly under the No. 1 terminal of the distributor cap.

2½-TON 4 x 2 TRUCK (FEDERAL)

SPARK PLUGS

MakeAC
Type44
Size14-mm
Point gap0.025 in.

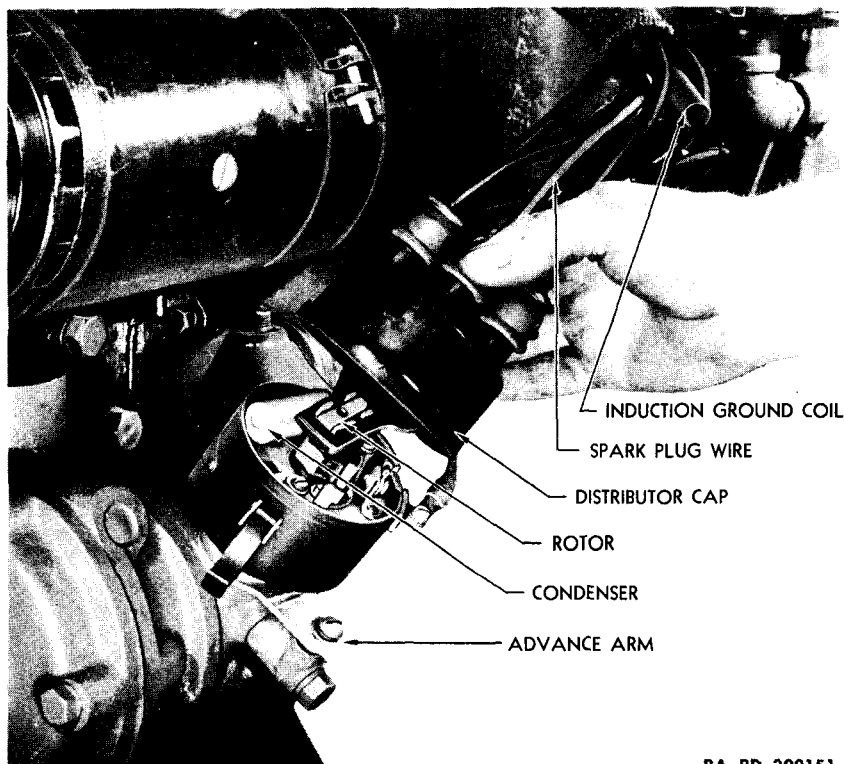

RA PD 300151

Figure 60—Removing Distributor Cap

(3) **PRE-SET ADVANCE ARM.** Loosen advance arm clamp screw (fig. 61) and set advance arm pointer 1½ graduations to the left of center "0" mark. Tighten advance arm clamp screw to retain advance arm in position.

(4) **INSTALL DISTRIBUTOR ASSEMBLY.** With cap again removed, but with rotor in place, start distributor assembly into opening in

IGNITION SYSTEM

water pump housing. Have distributor body turned in same position as when removed (mark at right angles to engine center line, or low-tension terminal downward and to the right) (fig. 61), and place center of rotor strip about $\frac{1}{4}$ inch counterclockwise from No. 1 mark

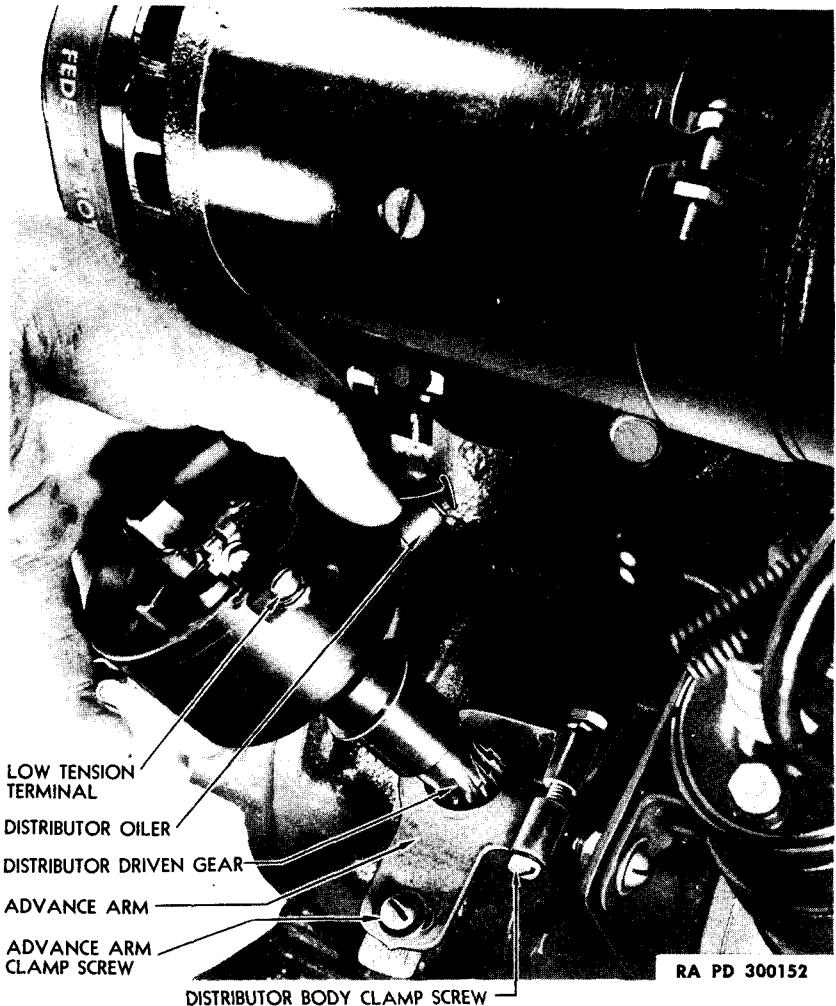

Figure 61—Installing Distributor Assembly

on housing. As distributor body slides downward, rotor gear engages, and rotor will turn clockwise to line up exactly with No. 1 scribed mark.

(5) **INITIAL DISTRIBUTOR BODY SETTING.** With No. 1 piston still in top dead center position, rotate distributor body slightly, noting that breaker points open and close. Set body at position when points

2½-TON 4 x 2 TRUCK (FEDERAL)

just break contact, with rotor pointing to No. 1 mark on body. Exact time of point opening can be determined by using a very thin feeler of paper, or by watching the "break" indicated by a 6-volt test lamp temporarily connected across distributor points. Lamp lights when points separate or "break." Lock distributor body in No. 1 "break" position by tightening distributor body clamp screw (fig. 61). Install distributor cap, No. 1 spark plug, and spark plug high-tension leads.

(6) INITIAL DISTRIBUTOR BODY SETTING (ALTERNATE METHOD).

The initial distributor body setting may be made as follows, using a neon timing light: Install distributor body (step (4) above) and tighten distributor body clamp screw just enough to hold distributor body from turning freely. Install distributor cap, No. 1 spark plug, and spark plug high-tension leads. Attach one lead of neon timing light to No. 1 spark plug terminal without removing regular spark plug high-tension lead, and ground other timing light lead. Hold timing light in position to illuminate timing hole in flywheel housing. Start engine and run at slow idle. Observe timing mark on flywheel as illuminated by neon light. Loosen distributor body clamp screw and slightly rotate distributor either way until light shows perfect alinement between flywheel mark and housing timing mark. Use mirror for clear view. Tighten distributor body clamp when correct mark alinement is obtained.

(7) BASIC ADVANCE ARM SETTING. After setting distributor body by either method (steps (5) or (6) above), loosen advance arm clamp screw (fig. 61) and set advance arm pointer back to center "0" mark. This has the effect of advancing the ignition timing six degrees ahead of piston top dead center—the correct basic ignition timing setting.

(8) ADJUSTMENT FOR FUEL. With varying grades of fuel, it may be necessary to alter distributor timing. Loosen advance arm clamp screw and rotate distributor assembly a point at a time as indicated by advance pointer. To advance timing, move pointer to right. To retard timing, move pointer to left. When desired setting is obtained, as indicated by performance and degree of detonation, tighten clamp screw. Timing should be advanced enough to cause slight detonation on sudden acceleration. Constant detonation is undesirable.

85. DISTRIBUTOR POINTS.

a. **Breaker Point Adjustment.** The two breaker points are supported on the breaker plate. The movable point is mounted on a pivoted arm actuated by the rotated cam. The stationary point is supported on an adjustable mounting plate controlled by an eccentric screw, locked in adjustment by a lock screw. Breaker point gap adjustment is made as follows:

(1) Unsnap side clamps and lift cap upwards and to one side. It is unnecessary to withdraw high-tension wires. Lift off rotor. Hand

IGNITION SYSTEM

crank the engine until the breaker arm rubbing strip is on the peak of the cam. The contact points are then at maximum gap. Loosen stationary point mounting plate lock screw. With correct thickness feeler gage in position between points (fig. 62), adjust eccentric screw to right or left, increasing or decreasing gap until feeler gage just fills gap. (Gage can be inserted between points with barely appreciable friction.) Tighten lock screw and recheck gap.

(2) Breaker contact gap should be 0.020 inch. When new points are being installed, gap should be set at 0.022 inch to compensate for

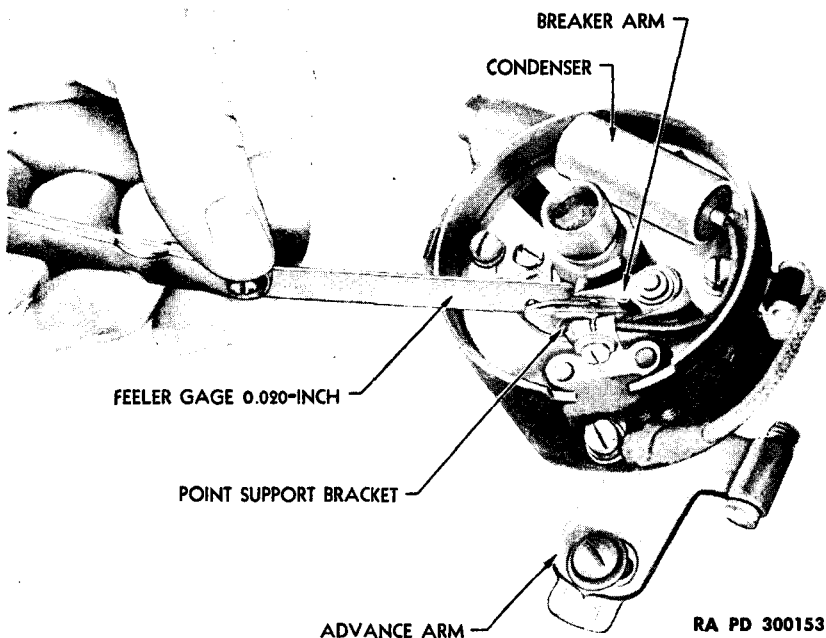

Figure 62—Adjusting Distributor Contact Points

initial "wear-in" of rubbing strip. Breaker contact point pressure should be 17 to 20 ounces. Check with spring scale hooked on the breaker arm at the contact, and pull on a line perpendicular to the breaker arm. Take the reading just as the points separate. Adjust the point pressure by loosening the screw holding the end of the contact arm spring, and slide the end of the spring in or out as necessary. Tighten the screw and check the pressure. Place rotor in position and press down firmly. Place cap in correct position on distributor housing and secure in place with two side snap retainers.

2½-TON 4 x 2 TRUCK (FEDERAL)

b. Remove Distributor Points. Lift off distributor cap and rotor. Loosen movable breaker arm spring retaining screw and lift off breaker arm. Remove fixed point support lock screw. Lift off fixed point support bracket.

c. Install Distributor Points. Fasten fixed point support bracket in place with attaching screw and temporarily tighten lock screw. Place breaker arm on pivot, and secure spring and condenser lead under retaining screw. Adjust breaker point gap and spring tension (step a above).

86. DISTRIBUTOR CONDENSER.

a. Description. The condenser is mounted in the body of the distributor (fig. 62) secured to the support plate by a screw and connected through short lead across distributor breaker points. The condenser has the capacity to absorb or store up momentarily electrical energy surging in the primary circuit at the instant points "break" the circuit. This function of the condenser prevents point burning and arcing.

b. Inspection and Test. Inspect the condenser lead for broken wires or frayed insulation, and clean and tighten the connection to the terminal. Be sure condenser is firmly mounted to the base plate. Withdraw coil high-tension lead from center of distributor, and place end terminal $\frac{3}{8}$ inch from cylinder block, supporting with a screw-driver at a point free of gasoline and grease. Turn on ignition switch, and with fingers, make and break contact at breaker points. If spark jumping from coil wire terminal to cylinder block is a snappy blue color, condenser is in good working condition; but if spark is a weak red color, replace condenser (steps c and d below), or test on a condenser tester if available.

c. Remove Condenser. Lift off distributor cap and rotor. Loosen screw holding condenser lead and disconnect lead. Remove condenser mounting screw and lift out condenser.

d. Install Condenser. Place condenser on base plate and secure with mounting screw. Connect condenser lead. Replace distributor rotor and cap.

87. DISTRIBUTOR ASSEMBLY.

a. Description. The ignition distributor is a six-cylinder, fully automatic, single breaker-arm type. It is located on the left side of the engine, supported on the water pump housing, and driven by a gear from the water pump shaft. Rotation is clockwise viewed from the top of the unit. Spark control is entirely automatic, being operated by centrifugal weights pivoted on a plate which is an integral part of the shaft, and connected to the breaker cam. This mechanism advances the timing automatically as the engine speed increases. The distributor shaft turns at $\frac{1}{2}$ engine speed. The cam separates the breaker points

IGNITION SYSTEM

at approximately the end of the compression stroke in each cylinder, thus breaking circuit in the primary coil. The secondary then develops a high voltage in a circuit which extends through the rotor to the correct spark plug. The distributor rotates, and ignition is thus produced in the proper firing order in each cylinder.

b. Remove Distributor. The correct ignition timing is of the utmost importance to the proper operation of the engine. Therefore, the distributor must not be disturbed until it is positively known to be inoperative or out of adjustment. When removing distributor, proceed as follows, paying particular attention to instructions for marking original position of distributor and initial correct engine rotation to top dead center:

(1) **REMOVE DISTRIBUTOR CAP.** It is unnecessary to immediately withdraw high-tension cables. Unsnap two side retaining clips and lift cap up.

(2) **MARK ROTOR POSITION.** Inside distributor cap note position of No. 1 terminal (par. 84 a (2)) and mark position on distributor body.

(3) **DISCONNECT PRIMARY LEAD.** Remove hex nut, lock washer, and primary lead from distributor body.

(4) **REMOVE DISTRIBUTOR.** Loosen distributor body clamp screw (fig. 61) in distributor advance arm on top of water pump housing, and withdraw distributor body assembly. Do not crank or rotate engine while distributor is removed.

c. Install Distributor.

(1) **ENGINE ROTATION DISTURBED.** If engine has been rotated while distributor was removed, repeat installation and timing procedure (par. 84 a (1) through (8)).

(2) **ENGINE ROTATION UNDISTURBED.** If engine has *not* been rotated during period when distributor was removed, proceed to install distributor (par. 84 a (4) through (8)).

(3) **CONNECT PRIMARY LEAD.** Place primary lead over terminal bolt and secure with lock washer and hex nut.

(4) **INSTALL DISTRIBUTOR CAP.** Place distributor cap on distributor body in correct position and secure with two snap retaining springs.

d. Distributor Maintenance and Service.

(1) **SYSTEMATIC IGNITION ANALYSIS.** A systematic analysis of fundamentals is of great value in locating the trouble. Use an accurate low scale direct current ammeter in localizing difficulties. The following is a suggested routine for trouble shooting:

(2) **COIL-DISTRIBUTOR CIRCUIT.** Remove the coil-distributor, high-tension (secondary) cable and hold it $\frac{3}{8}$ inch from ground (any convenient metal part of the engine, free of gasoline, oil, etc.). Make and

2½-TON 4 x 2 TRUCK (FEDERAL)

break the primary circuit with the ignition turned on, either by using the cranking motor, or by rocking the cam inside the distributor back and forth. A hot, snappy spark should result, and if so, proceed to second test. If no spark occurs, check the coil-distributor wire to be sure it can conduct current, or substitute a wire known to be good, and repeat. If a weak spark is obtained, either the condenser or coil, or both, are at fault. Turn engine over with the cranking motor and look for excessive arcing at the breaker points, which is an indication of a bad condenser. Replace condenser and repeat original test. If spark is still weak, install new coil.

(3) **DISTRIBUTOR COVER.** With the coil-distributor wire inserted in the center well of the distributor cover, remove cover, and turn engine over to produce current in the secondary circuit. Observe cover interior for cracks and moisture, and watch for leakage, or a short circuit evidenced by sparks jumping from the center terminal to the spark plug terminals. Carbon paths which resemble cracks will also be apparent in the bakelite of the cover. To test whether the secondary circuit is established through the center brush or terminal inside the distributor cover, hold one end of a high-tension cable against the point with its other end $\frac{3}{8}$ inch from ground. A spark should jump to ground when a secondary current is induced.

(4) **DISTRIBUTOR ROTOR.** A grounded rotor will interrupt the passage of current between the center segment and the spark plug cables. To test the insulation of the rotor, remove distributor cap and hold the coil-distributor high-tension cable approximately $\frac{3}{8}$ inch from the rotor center strip. Induce a secondary voltage by making and breaking the primary circuit, and if a spark occurs to rotor strip, the rotor is grounded, and must be cleaned or replaced.

(5) **SPARK PLUG CABLES.** Having proved that the secondary current reaches the spark plug cables, check the cables by removing each one in turn from its spark plug, holding it approximately $\frac{3}{8}$ inch from ground, and inducing a secondary voltage by turning over the engine with the cranking motor. If a spark does not occur with regularity in any cable, the cable must be replaced.

(6) **SPARK PLUG TESTING.** With the secondary current checked as far as the plugs, the latter must be thoroughly tested to insure that the spark jumps its gap and ignites the charge in the cylinder. Clean and test spark plugs on a spark plug tester, or shorten out individual plugs with the bit of an insulated screwdriver across the terminal to ground, and note the result in engine operation. If a cylinder is already missing, no change will be noted when its plug is shorted out. Faulty plug must be replaced.

(7) **AMMETER INDICATES CONSTANT NORMAL DISCHARGE.** Under such circumstances, the primary circuit is complete but it is not being interrupted to induce a secondary discharge. Several tests can be

IGNITION SYSTEM

made for checking troubles of this kind in circuits beyond the ignition coil.

(a) *Distributor.* Disconnect the primary wire where it enters the distributor, and if the ammeter needle returns to "0", the distributor is at fault. Connect primary wire, remove distributor cover, and while rotating engine, note if points open. If points remain closed, set correctly (par. 85 a). If discharge continues with points open and correctly set, a shorted condenser is indicated. Check by replacing with condenser known to be good, or checking condenser (par. 86 b). If discharge continues, a grounded distributor is indicated, and distributor must be replaced (steps b and c above).

(b) *Coil-distributor Wire.* If the ammeter needle does not return to "0" when the primary circuit is opened at the distributor as above, connect the wire to the distributor and disconnect the end at the primary terminal of the coil to check for a grounded coil-distributor wire. If the needle still does not return to "0", examine the coil terminal for fracture or foreign material. If no defect is found externally, the trouble must be inside the coil where one of the primary terminals is grounded. Coil replacement is necessary.

(8) **AMMETER INDICATES NO DISCHARGE.** A "0" reading on the ammeter, with the ignition switch closed, indicates an open circuit, or a dead battery. With a battery known to be fully charged, ground the terminal where the primary winding enters the distributor, and if a spark results, the trouble is in the distributor. If no flash occurs, the fault lies back toward the source.

(a) *Distributor.* Check the points for closing and make sure that there is a continuous path for the current through the points to ground (distributor base). With points closed, connect 6-volt test lamp between movable point and engine cylinder head for positive ground. If lamp lights, a faulty point or distributor ground is indicated. Replace points, or replace distributor as necessary.

(b) Return to the battery side of the ammeter and flash test with a free piece of insulated wire, bare at each end. (Hold one end of a test wire at the terminal being checked and strike the other end on a convenient ground.) If the cranking motor turned the engine, current must be available, and by starting at the ammeter, the trouble may be traced from there.

(c) If a spark is obtained on the battery side of the ammeter, by momentarily grounding the terminal with the test wire, place this lead on the opposite terminal of the ammeter to shunt the ammeter during remainder of test, and protect it against excessive test currents.

(d) Continue the flash tests for the battery (hot) side of the ignition switch. Then do the dead side with switch closed, and so on through complete primary circuit to the distributor. The break or defect in wiring will be found between the last terminal that showed

2½-TON 4 x 2 TRUCK (FEDERAL)

the presence of current, and the next succeeding one that denoted its absence. After satisfactory repair or replacement has been accomplished, connect the ammeter back into the circuit.

(e) If ammeter indicates heavy discharge, this may be caused by a ground before the primary current passes through the majority of the primary windings of the coil. The trouble can be localized by observing the ammeter action while turning the ignition switch.

(f) If the ammeter registers zero with the switch "OFF," the trouble must be between the switch and the coil terminal.

(g) If the discharge exists with the switch either "ON" or "OFF," the trouble lies between the ammeter and switch involving an examination of the generator circuit. Remove the respective wires to note effect on ammeter and localize fault, correcting as necessary.

88. SPARK PLUGS.

a. **Description.** The spark plug is the medium by which high-tension voltage is converted into a spark to cause combustion in the compression chamber of the engine. Each plug consists of a metal shell within which is fixed an insulator with a central electrode stem. The shell is threaded at one end to screw into the cylinder head; at its inner end it carries a fixed, bent, side electrode. The stem is sealed into the insulator, its inner end is the central electrode, its outer end the spark plug high-tension terminal. The spark plug is manufactured as a one-piece sealed unit and cannot be disassembled for service. A copper gasket is placed over the threaded end when the plug is screwed into position.

b. **Spark Plug Service.** Gaps are burned open by the constant application of spark, heat, pressure, and the chemical action of fuel mixture. Electrodes become oxidized and corroded, causing increased resistance to the passage of current. The firing end of the core becomes crusted with carbon and other deposits, or cracked, resulting in "missing" because of current loss over and through deposits and fracture. Plugs develop a gas leakage between the core and shell, or between the center electrode and core. Test plugs on spark plug tester. If faulty, replace. Adjust gap by bending side electrode only. Correct gap is 0.025 inch measured with standard wire gage.

c. **Remove Spark Plug.** Disconnect high-tension lead and unscrew spark plug. Exercise care to avoid breaking insulator.

d. **Install Spark Plug.** When installing spark plugs, use a new gasket and screw the plug in finger-tight. Then tighten ½ turn more with wrench, just tight enough to make a good seat on gasket. Connect high-tension lead.

89. IGNITION COIL.

a. **Description.** The ignition coil converts low-voltage primary current, from generator or battery, to a higher voltage which is strong

IGNITION SYSTEM

enough to jump the spark plug gaps and fire the fuel charge compressed within the cylinders. Two primary circuit terminals are provided on the coil for the distributor and ignition switch low-tension wires. One secondary high-tension terminal is provided in the center

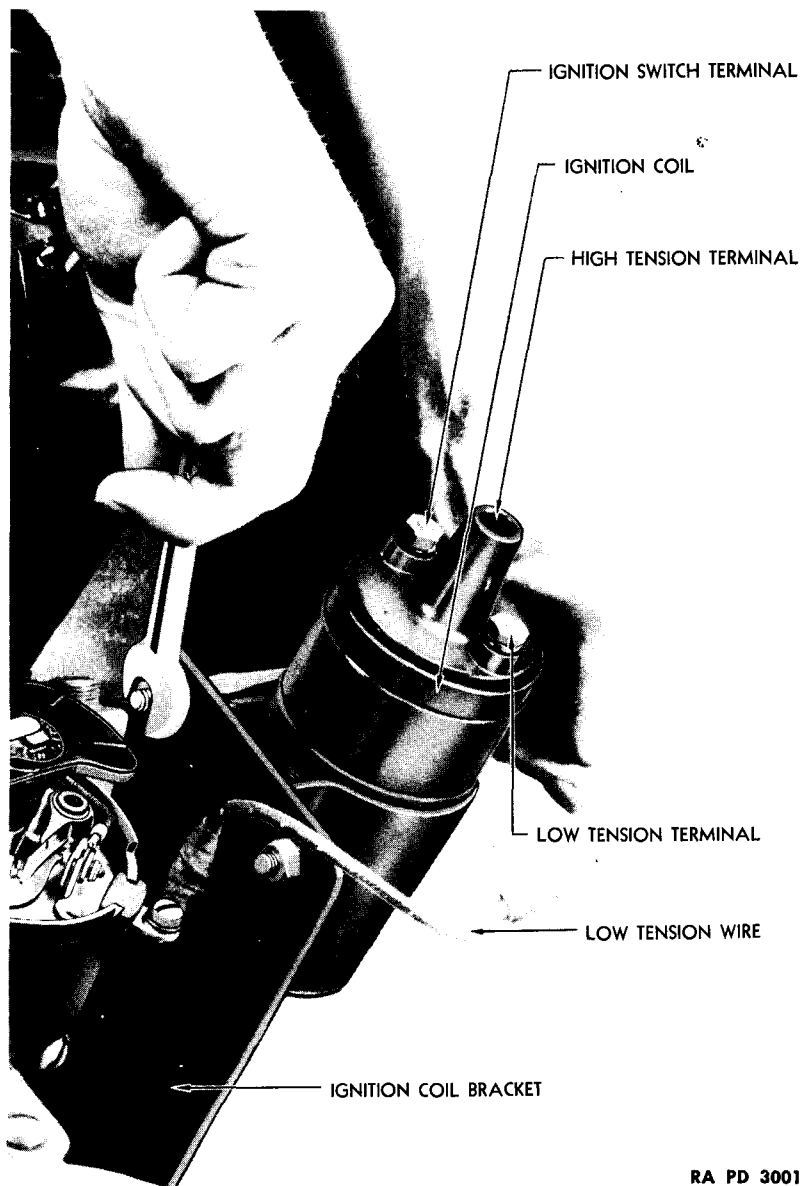

RA PD 300154

Figure 63—Removing Ignition Coil

2½-TON 4 x 2 TRUCK (FEDERAL)

of one end of the coil to take the high-tension cable leading to the center of the distributor cap.

b. Testing. Remove coil high-tension cable from distributor cap and support with a screwdriver approximately $\frac{3}{8}$ inch from the cylinder head. With ignition switch on, manually open and close distributor breaker points (cap off), and note spark jumping from high-tension cable to cylinder head. If it is a hot blue color, coil is working satisfactorily. If spark is weak and stringy, coil operation is faulty. If coil performance is in doubt, substitute a unit known to be satisfactory and check difference in operation. Further testing of coil is beyond the scope of this manual.

c. Remove Ignition Coil. Pull out distributor high-tension cable and disconnect two primary wires at terminals. Remove two coil support bracket to coil bolts and nuts.

d. Install Coil. Attach coil to support bracket high-tension terminal and using two bolts, lock washers, and nuts, attach primary wires to terminals and insert high-tension wire.

90. IGNITION WIRING.

a. Description. The low- and high-tension ignition wiring system (fig. 64) carries the primary low-tension electrical energy from the battery, through the ammeter, ignition switch, coil primary, and distributor; and as high-tension energy from the coil secondary through the distributor to the spark plugs, where the spark, jumping the plug gap, causes fuel to explode in the combustion chambers. Connecting wires from the battery to ammeter and ignition switch to primary coil terminal are part of the chassis front end wiring harness. Connecting wires from the ammeter to ignition switch, primary coil to distributor, high-tension secondary coil to distributor, and distributor to spark plugs, are separate wires. The six spark plug wires are supported as a group in an insulating conduit and held by suitable spool grommets and clips. Within the conduit the six spark plug wires are grouped around a central core wire, consisting of a tightly coiled steel spring, which extends the length of the conduit, the upper end of the core spring being grounded to the supporting metal clip, the lower end being free of metal contact. This central wire-coiled core acts to isolate and confine the individual spark impulses to their respective cables, and avoids impulse transfer from cable to cable, which would cause preignition in an "out-of-time" spark plug, a phenomena commonly known as "ignition bump." It is important that this center core be in position and properly grounded at all times for correct functioning of the ignition system.

b. Remove Ignition Wiring. To eliminate possibility of short circuits, always disconnect grounded terminal of battery before replacing any ignition low-tension wiring. It is unnecessary to disconnect battery ground cable before replacing high-tension wiring. The same

IGNITION SYSTEM

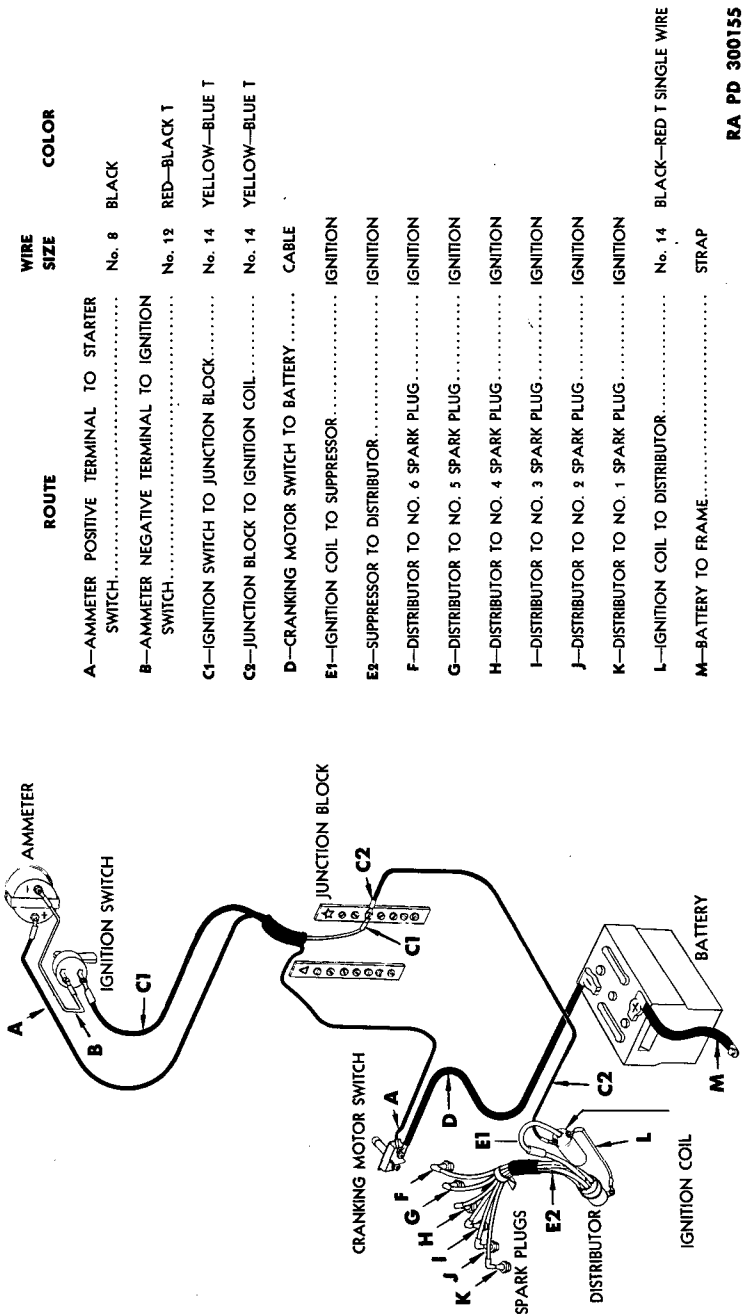

RA PD 300155

Figure 64—Ignition Wiring Diagram

2½-TON 4 x 2 TRUCK (FEDERAL)

basic steps may be followed in removing any of the ignition wiring. Disconnect all terminals on the wire or harness concerned, open clips, remove grommets, and pull harness or wires through any remaining grommets until it is completely free. When removing high-tension wiring, particularly spark plug wires, it is of advantage to scribe a mark on the distributor cap at the terminal corresponding to No. 1 spark plug. Note clockwise sequences of remaining wires (Nos. 5-3-6-2-4).

c. **Install Ignition Wiring.** Using pull wire or heavy string if necessary, draw harness through supporting grommets. Fasten into position with clips and grommets. Connect all terminals on harness. Connect all terminals on individual wires. Assemble spark plug wires around center coil spring core and place in conduit. Place rubber distributor terminal nipples on cables. First trace through the No. 1 spark plug wire. Install in previously marked No. 1 distributor cap terminal. Then follow suit with other spark plug wires in clockwise sequence, tracing to Nos. 5-3-6-2-4 cylinders in turn. Install coil to distributor single high-tension wire (to center of distributor cap) and connect low-tension coil to distributor wire. Connect battery ground terminal.

91. IGNITION SWITCH.

a. **Remove Ignition Switch.** The ignition switch is of the keyless lever type. To remove, disconnect leads, remove knurled mounting nut from switch body at front of panel by inserting small drift into one of the two countersunk holes, and tap lightly.

b. **Install Ignition Switch.** Place switch body through instrument panel, and secure with knurled lock nut. Connect leads to proper terminals and tighten securely.

Section XIX

STARTING AND GENERATING SYSTEMS

	Paragraph
Description and tabulated data.....	92
Generator regulator	93
Generator assembly	94
Cranking motor	95
Cranking motor switch	96

92. DESCRIPTION AND TABULATED DATA.

a. **Description.** The starting and generating system consists of a 6-volt cranking motor, foot-operated cranking motor switch, 6-volt generator, three-unit generator regulator, and necessary connecting wiring and cables. The starting and generating wiring diagram is shown in figure 65.

b. **Data.**

Starter	Auto-Lite
Generator	Auto-Lite GEG 5002C
Generator regulator	Auto-Lite VRY-4203A

93. GENERATOR REGULATOR.

a. **Description.** The generator output to the electrical system is controlled automatically by a factory-tested, sealed control-device known as the generator regulator, commonly called the voltage regulator, which is mounted to the left on the engine side of the dash. The generator regulator consists of three separate and distinct elements: a cut-out relay, the voltage-regulator relay, and a current-limiting relay, all of which are mounted on the same base under a common cover.

b. **Testing.** Detailed testing recommendations for this type of equipment are not within the scope of this manual. A fully charged battery with low charging rate indicates that generator and regulator are functioning normally. A fully charged battery showing a high charging rate, or a low battery showing a low or no-charging rate indicates that the regulator is not functioning properly. Test regulator by substitution of a unit known to be in good working order (step c below).

c. **Failure in Operation.** In event of an emergency involving failure of the generator regulator, disconnect and insulate all leads at the regulator. This prevents the generator from developing any voltage when it is driven. The generator cannot be removed without depriving the fan of its driving belt, since the same belt drives both units. Operation with generator leads disconnected at the regulator must be strictly temporary, as battery reserve is limited.

2½-TON 4 x 2 TRUCK (FEDERAL)

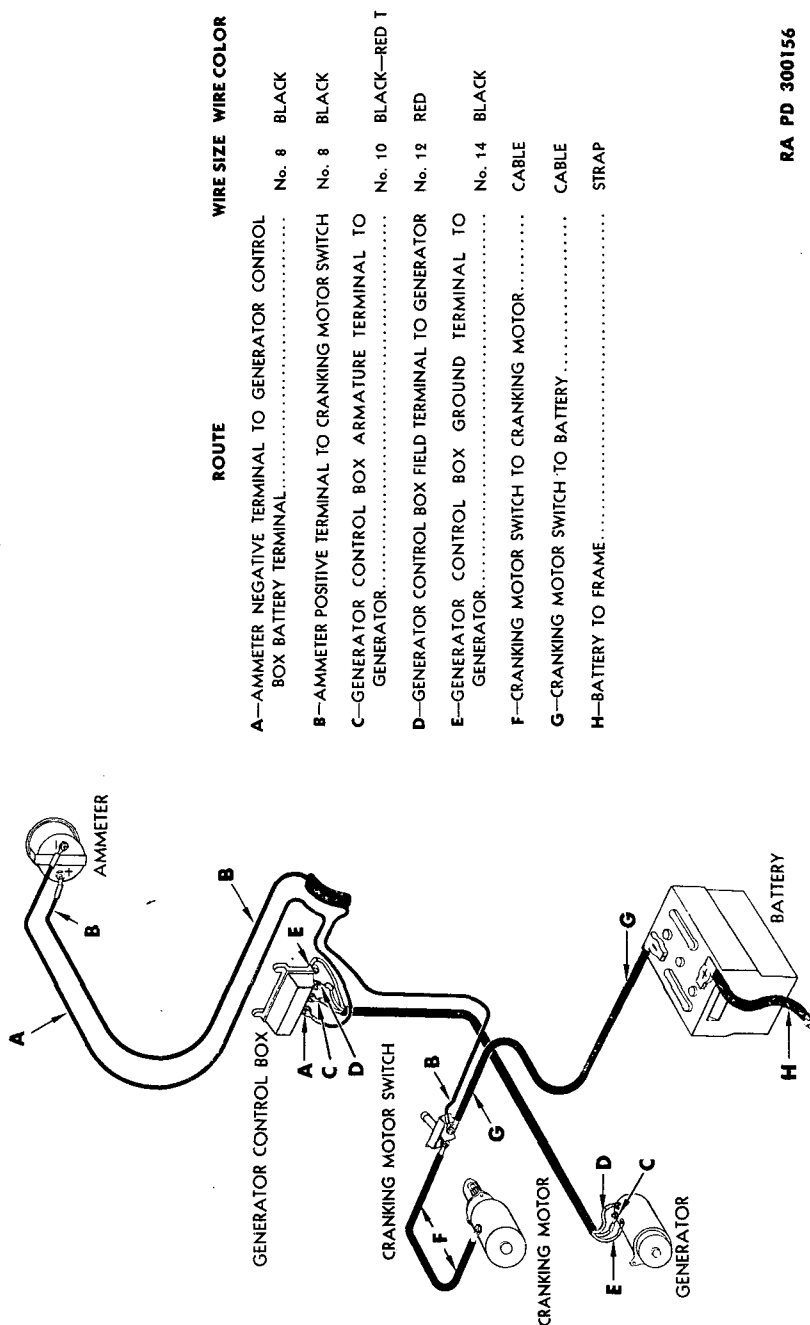

RA PD 300156

Figure 65—Starting and Generating Systems Wiring Diagram

STARTING AND GENERATING SYSTEMS

d. **Generator Regulator Removal.** Remove leads one at a time from regulator terminals, tagging them to make certain of returning them to the correct terminals. Remove four regulator retaining screws holding unit to dash, and lift off.

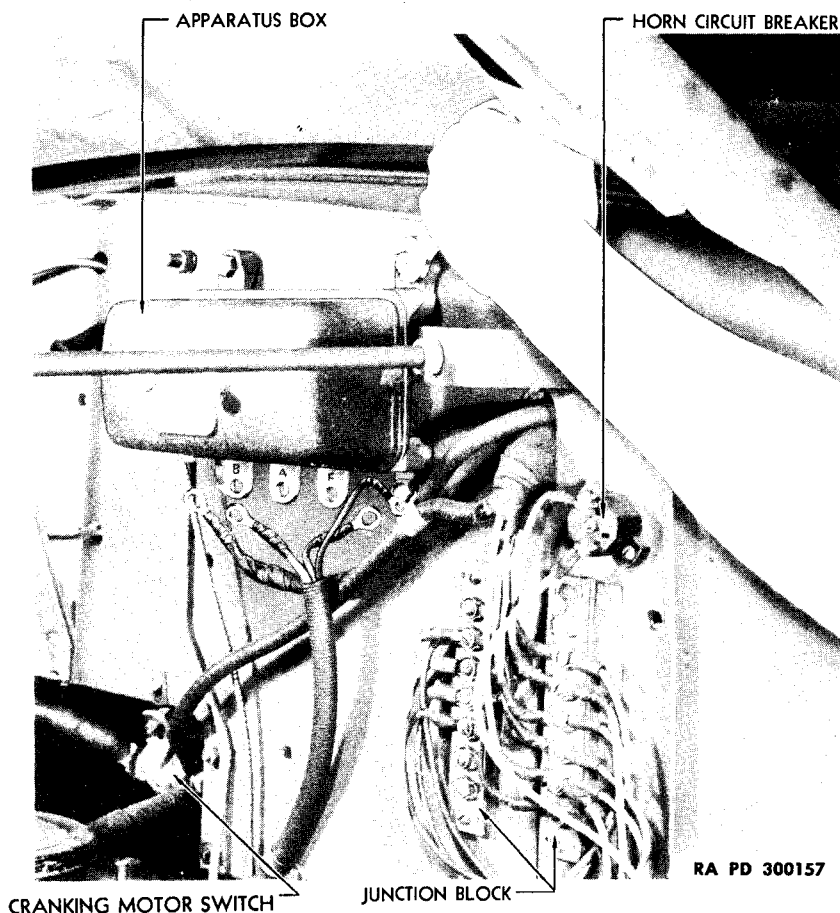

Figure 66—Generator Regulator

e. **Generator Regulator Installation.** Mount generator regulator on dash, securing with four dash screws. Connect leads, making certain they are returned to proper control terminals. **CAUTION:** After replacement of generator regulator, or generator, always connect a jumper lead momentarily between armature and battery terminals of the regulator after it is connected, but before the engine is started. This will correctly polarize the generator with the battery it is to charge.

2½-TON 4 x 2 TRUCK (FEDERAL)**94. GENERATOR ASSEMBLY.**

a. **Description.** The generator is a heavy-duty, 6-volt, two-brush, shunt-wound unit, and is belt driven clockwise from the engine crankshaft by the same belt which drives the fan pulley. Maximum cold output under control of the regulator is 40 amperes. A removable cover band around the field frame permits the inspection of the commutator and brushes.

b. **Testing.** Detailed testing recommendations for this type of equipment are not within the scope of this manual. A fully charged battery and low charging rate indicates normal functioning of gener-

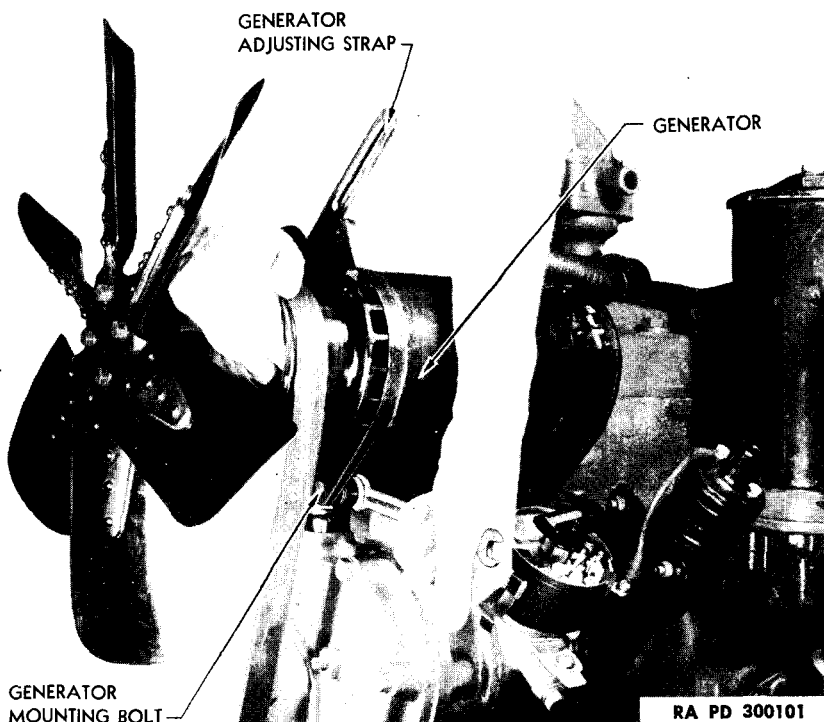

Figure 67—Removing Generator Assembly

ator and regulator. A low battery and low or no-charging rate will indicate a faulty generator, a faulty generator control box, or a defective circuit. First inspect entire circuit and correct loose connections, corroded battery terminals, and loose or corroded ground strap. The high resistance resulting from these conditions will prevent normal charge from reaching the battery. If the entire charging circuit is in good condition, and the generator still fails to charge, then either the regulator or generator is at fault. Test these units by substitution of units known

STARTING AND GENERATING SYSTEMS

to be in good working order (pars. 93-94). **CAUTION:** *After replacement of generator regulator, or replacement of generator, always connect a jumper lead momentarily between the armature and battery terminals of the regulator after it is connected, but before the engine is started. This will correctly polarize the generator with the battery it is to charge.*

c. **Belt Tension Adjustment.** A slotted brace held to generator by clamping bolt and washer provides for generator and fan belt tension adjustment (fig. 55). Do not adjust belt too tight. Allow $\frac{1}{2}$ -inch flex at point midway between crankshaft pulley and generator pulley. Check with straightedge (fig. 54).

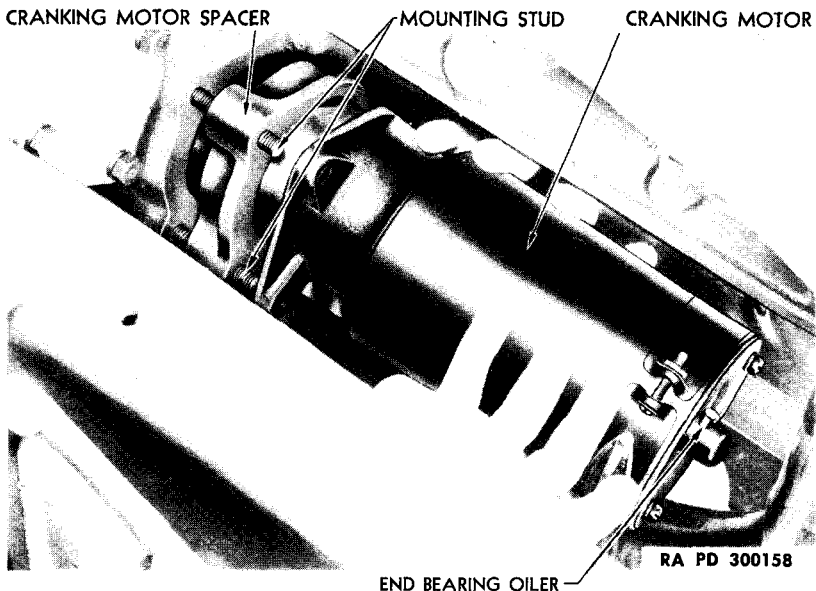

Figure 68—Removing Cranking Motor Assembly

d. **Generator Removal.** Disconnect generator leads, tagging each for reinstallation on same terminals. Remove generator adjusting brace clamp bolt. Loosen generator to mounting bracket bolts and swing generator in toward engine. Remove drive belt from generator pulley. Remove generator to bracket bolts and lift up generator.

e. **Generator Installation.** Place generator in supporting bracket and secure with generator to bracket bolts. Swing generator in toward engine and place belt over pulley. Place adjusting brace in position and partially tighten clamp bolt. Adjust belt tension (step c above). Connect generator leads.

2½-TON 4 x 2 TRUCK (FEDERAL)

95. CRANKING MOTOR.

a. **Description.** The cranking motor is a 6-volt, heavy-duty, four-brush type, and is secured to the flywheel housing on the right side of the engine by means of a three-stud flange mounting. Cranking power is transmitted to the engine flywheel through a right-hand Bendix drive. A removable cover band around the field frame permits inspection of the commutator and brush connections.

b. **Cranking Motor Removal.** Disconnect lead at cranking motor terminal. Remove the three mounting stud nuts and lock washers. Drive back exhaust pipe support clip. Lift cranking motor away. Remove spacer flange.

c. **Cranking Motor Installation.** Place spacer flange on studs. Lift cranking motor into place. Place exhaust pipe support clip on stud. Tighten stud nut securely. Connect lead to cranking motor terminal.

96. CRANKING MOTOR SWITCH.

a. **Remove Cranking Motor Switch.** The cranking motor switch is of the push-button, foot-operated type. To remove, disconnect leads; loosen retaining nuts at rear of panel, and lift off switch.

b. **Install Cranking Motor Switch.** Place switch in position in panel and secure with bolts, lock washers, and retaining nuts. Connect and tighten the two leads.

Section XX

TRANSMISSION

	Paragraph
Description and tabulated data	97
Removal	98
Installation	99

97. DESCRIPTION AND TABULATED DATA.

a. **Description.** Transmission is selective sliding-clutch and sliding-gear type, providing five speeds forward and one reverse. Fourth-speed position provides a direct drive through transmission (1 to 1 ratio) with fifth-speed position providing overdrive ratio. In all other speeds including reverse, the power is directed through gears of various sizes to provide the desired gear ratio. Gears are shifted manually by conventional gear shift lever (fig. 6). Provision is made on the right side of the transmission unit for mounting power take-off case. The transmission assembly is attached to the rear face of the clutch housing by four studs, lock washers, and nuts. The clutch housing is mounted on the flywheel housing and held in position by 12 bolts and lock washers.

h. Tabulated Data.

Transmission	Clark
Model	204-VO-320
Type	Overdrive helical gear
Speeds	5 forward, 1 reverse
Mounting	On clutch housing
Gear ratios:	
First speed	6.06:1
Second speed	3.50:1
Third speed	1.80:1
Fourth speed	Direct
Fifth speed (overdrive)	0.799:1
Reverse	6.00:1

98. REMOVAL.

a. **Remove Transmission.** The transmission must be removed as a complete assembly including power take-off, proceeding carefully as outlined in the following steps:

- (1) Remove all floor board retaining screws and lift out floor boards.
- (2) Remove five bolts and nuts on each side holding front cross brace to running boards, and drop cross brace.
- (3) Separate front propeller shaft joint from brake drum by removing four bolts. Drop center bearing hanger by removing four bolts. Drop entire propeller shaft front end to floor.

2½-TON 4 x 2 TRUCK (FEDERAL)

(4) Disconnect power take-off shift lever linkage at power take-off shift rod. Loosen set screw holding power take-off shaft yoke. Drive yoke off take-off shaft, using soft drift.

(5) Unscrew knurled nut and withdraw speedometer cable from fitting, unscrew nut from speedometer drive fitting.

(6) Loosen and remove cylinder head bolt holding clutch throw-out bearing oil line clip on left rear side of cylinder head.

(7) Remove cotter pin, and remove yoke pin holding clutch linkage to clutch shaft lever.

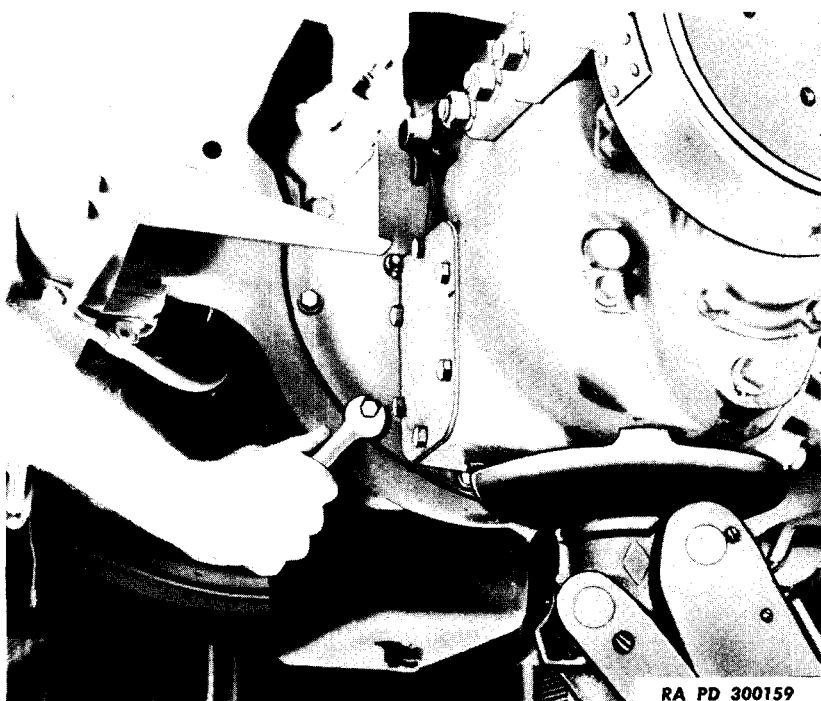

Figure 69—Removing Transmission Assembly

(8) Clutch and brake pedals with their supporting brackets must be removed as a complete assembly.

(9) Support transmission on suitable jack or blocks and loosen 12 clutch housing to flywheel housing bolts. Make certain that transmission will not swing out of line, and then remove clutch housing to flywheel housing bolts. Draw transmission straight back, taking particular care not to swing it, as moving transmission out of line during withdrawal operation will spring or damage clutch plate. Lower transmission to ground, roll on side, and pull out from under truck.

TRANSMISSION

99. INSTALLATION.

a. Install Transmission.

(1) Place transmission under truck and lift on suitable blocks or jack. Note carefully alinement of main drive gear with clutch plate and clutch pilot bearing. Also check alinement at clutch and flywheel housing. Move transmission toward flywheel housing, and rock slightly to engage splines on main drive shaft with splines on clutch plate.

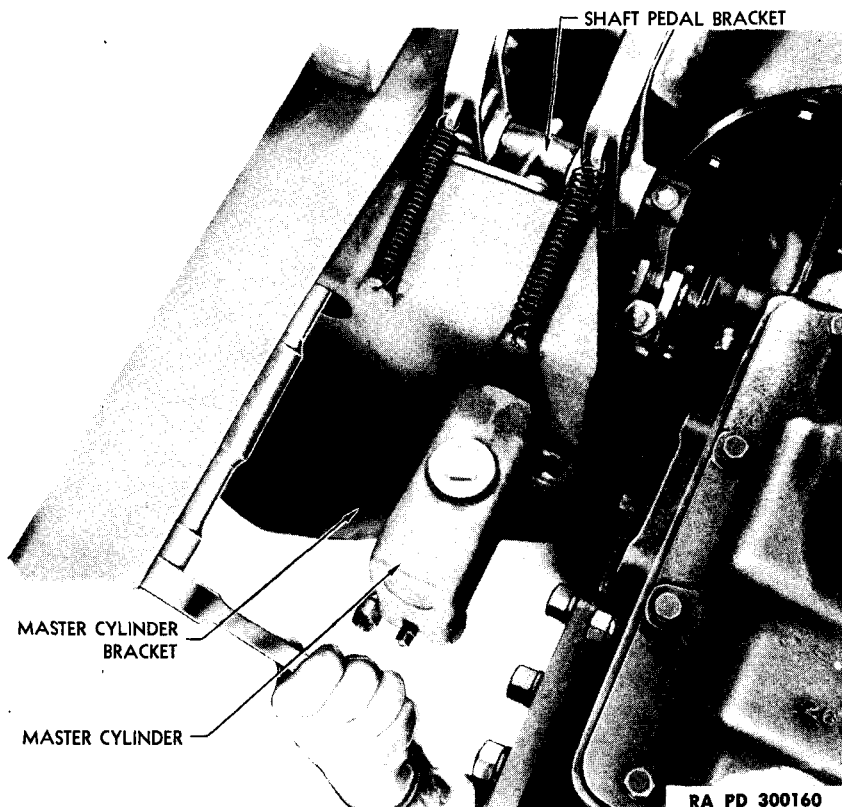

Figure 70—Removing Clutch and Brake Pedal Shaft and Bracket Assembly

Exercise particular care to avoid misalinement between transmission and flywheel housing, otherwise clutch plate may be damaged.

(2) With transmission pushed firmly against flywheel housing, install 12 bolts and tighten evenly. Remove jacks or blocks supporting transmission.

(3) Clutch and brake pedals with pedal brackets must be installed as a unit.

2½-TON 4 x 2 TRUCK (FEDERAL)

(4) Clutch linkage yoke at clutch shaft lever must be connected at this time. Secure yoke pin with cotter pin.

(5) At left rear side of cylinder head, install clutch throw-out bearing oil line clip under cylinder head bolt, and tighten bolt securely.

(6) Insert speedometer cable end in speedometer drive fitting, making sure tongue on cable end engages drive groove. Tighten knurled nut to hold cable in place.

(7) Connect power take-off shift lever linkage. Drive power take-off shaft yoke on drive shaft and secure with set screw. Secure set screw with lock wire.

(8) Lift propeller shaft into position and fasten center bearing support to cross member with four bolts. Connect front propeller shaft universal joint and brake drum securely with four bolts, nuts, and lock washers.

(9) Lift cross brace into position and secure to fenders with five bolts, nuts, and lock washers on each side.

(10) Place floor boards in position and secure with screws.

(11) Transmission replacement may have disturbed clutch pedal linkage adjustment. Check clutch adjustment (par. 63).

Section XXI

PROPELLER SHAFT

	Paragraph
Description and tabulated data	100
Propeller shafts and universal joints	101
Center bearing	102

100. DESCRIPTION AND TABULATED DATA.

a. **Description.** The propeller shaft drive line consists of two tubular shafts supported by a center bearing. Three needle bearing type universal joints are used and a slip joint is provided at the forward end of the rear shaft. The propeller shaft provides a means of transmitting power of the engine from the transmission to the rear

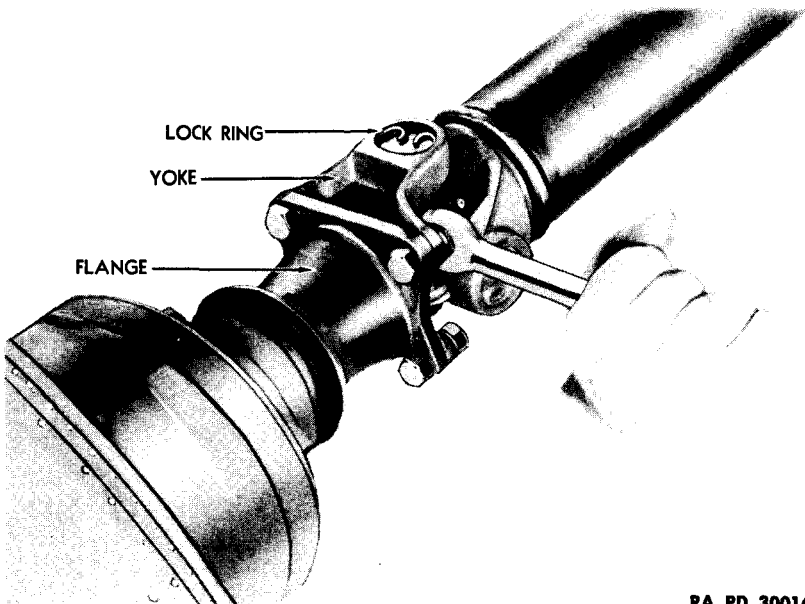

RA PD 300161

Figure 71—Removing Propeller Shaft

axle. The universal joints permit the angular movement of the shaft during rotation, and the slip joint permits the variation in length of the shaft during vehicle operation.

b. Tabulated Data.

Shafts, number used	2
Universal joints, number used	3
Shaft diameter	3 in.
Make	Spicer
Type of joint	1400 series

2½-TON 4 x 2 TRUCK (FEDERAL)**101. PROPELLER SHAFTS AND UNIVERSAL JOINTS.**

a. **Rear Propeller Shaft with Universal Joint Removal.** Remove nuts, lock washers, and bolts from flanges and yokes at both ends of rear propeller shafts (fig. 71). Lower shaft to ground and remove from beneath vehicle.

b. **Rear Propeller Shaft with Universal Joint Installation.** Place shaft in position beneath vehicle and connect yoke and flange at front end by installing bolts, nuts, and lock washers. Tighten securely. Connect yokes and flange at rear end in similar manner.

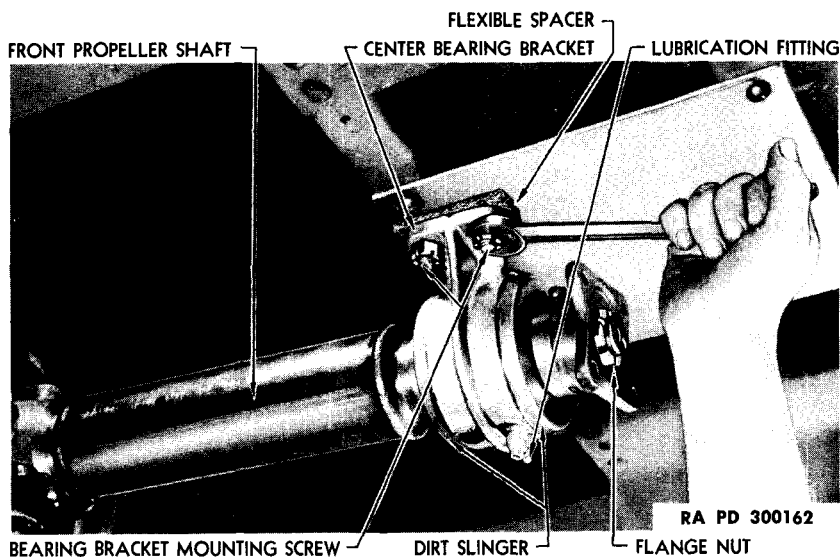

Figure 72—Removing Center Bearing

c. **Front Propeller Shaft with Center Bearing Removal.** Remove nuts, lock washers, and bolts from flange and yoke at front end of rear propeller shaft, and lower shaft to ground. Remove nuts, lock washers and bolts from flange and yoke at front end of front propeller shaft. Remove nuts from four center bearing mounting screws (fig. 72), drop center bearing and shaft to ground. Remove flexible spacers from center bearing mounting screws.

d. **Front Propeller Shaft with Center Bearing Installation.** Place flexible spacers in position over mounting screws (fig. 72) and position center bearing in place. Install nuts on center bearing mounting screws, draw up tight, and secure with cotter pins. Connect front universal joint by installing bolts, nuts, and lock washer through yoke and flange on transmission drum flange. Connect rear universal joint by installing bolts, nuts, and lock washers through flange and yoke of rear propeller shaft.

PROPELLER SHAFT**102. CENTER BEARING.**

a. **Center Bearing Removal.** Disconnect universal joint (par. 101 d). Remove flange nut from front shaft rear flange and remove flange. Remove center bearing mounting nuts and slide center bearing from front shaft.

b. **Center Bearing Installation.** Slide center bearing in place over front propeller shaft stud. Connect center bearing to cross member (par. 101 d). Connect universal joint.

2½-TON 4 x 2 TRUCK (FEDERAL)

Section XXII

FRONT AXLE

	Paragraph
Description and tabulated data	103
Wheel alinement	104
Axle assembly removal	105
Axle assembly installation	106
Steering knuckle arm removal	107
Steering knuckle arm installation.....	108
Tie rod assembly removal	109
Tie rod assembly installation	110
Spindle assembly removal	111
Spindle assembly installation	112

103. DESCRIPTION AND TABULATED DATA.

a. Description. The front axle is a drop-forged I-beam with reverse Elliott construction at the steering knuckle. The axle is attached to the frame of the vehicle by means of large, malleable brackets beneath semielliptical springs. The steering knuckles rotate on a knuckle pin that is mounted in two bronze-alloy bushings. A roller bearing at the lower end takes the thrust.

b. Tabulated Data.

Make	Timken
Type	Reverse Elliott
Ground clearance	11¾ in.
Tire track	63⅝ in.

104. WHEEL ALINEMENT.

a. Measure Toe-in. Wheel toe-in is the difference in distance between the front wheels at the front and at the rear of the axle. Determine toe-in by measuring the distance with wheel alining gage (in a line with center of wheel from ground) between front inner face of front tires. Measure similar distance (in a line with center of wheel from ground) between rear inner faces of front tires. If toe-in is correct, front measurement will be ⅛ to ¼ inch less than rear measurement.

b. Adjust Toe-in. The toe-in adjustment is made, when required, by loosening the clamp screw at each tie rod end and rotating the tie rod. Rotating the rod in the direction the wheels turn, when the vehicle is moving forward, increases the toe-in. Rotating in the opposite direction decreases the toe-in.

RA PD 300163

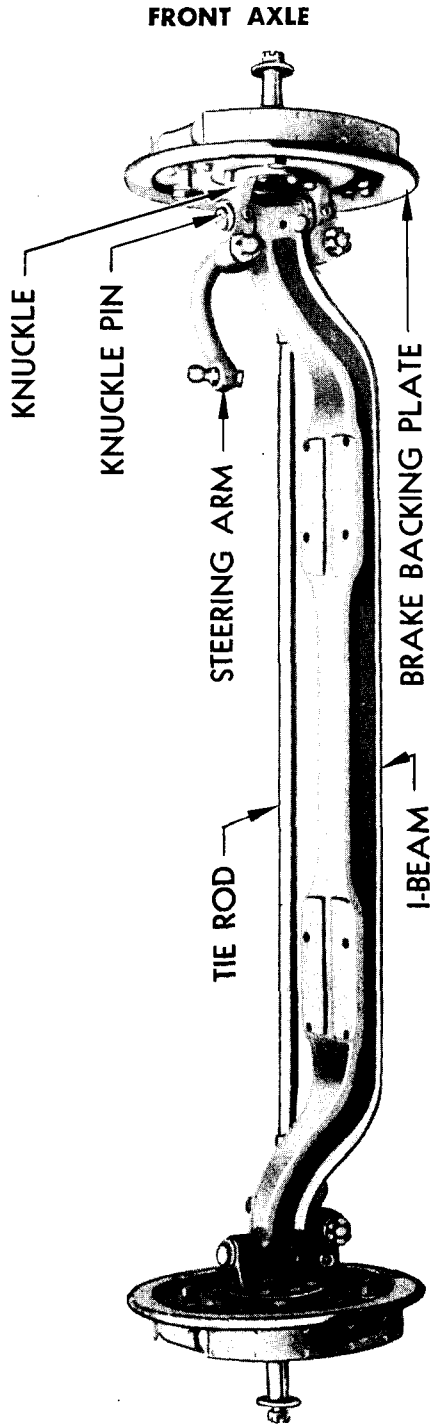

Figure 73—Front Axle Assembly

2½-TON 4 x 2 TRUCK (FEDERAL)

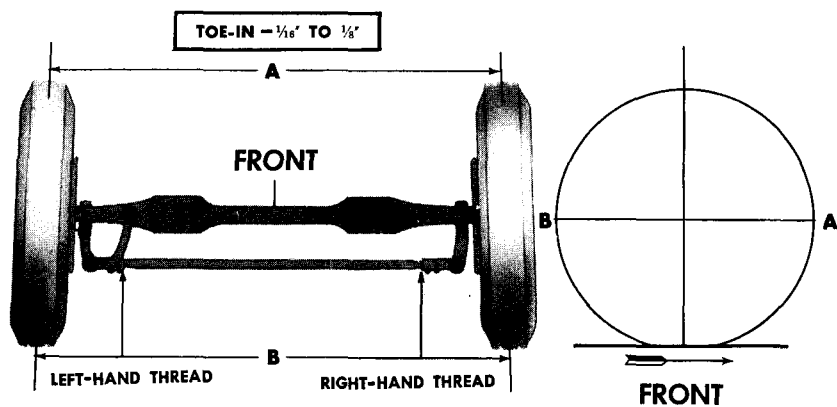

Figure 74—Toe-in

RA PD 300164

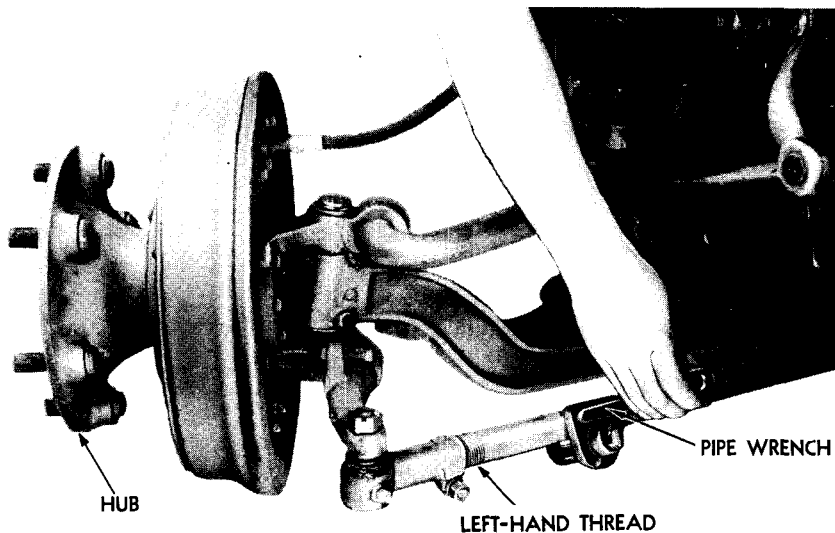

Figure 75—Adjusting Toe-in

RA PD 300165

FRONT AXLE

105. AXLE ASSEMBLY REMOVAL.

a. **Remove Axle.** Jack up front end of vehicle on both sides, using one jack under each frame side member, or a hoist, if available. Remove both front wheels (par. 139). Remove cotter pin from front end of steering drag link and take out threaded plug. Tap steering drag link out of left-hand steering spindle. Disconnect front wheel flexible brake lines at junction plate on frame. Hold fittings with two wrenches to avoid twisting lines. Remove the four nuts, bolts, and lock washers that hold the axle I-beam to the bottom of the mounting bracket on each side (fig. 76), holding the bolt head with one wrench, while turning the nut with the other. **CAUTION:** *Support axle while removing the last bolt and nut on each side. Lower axle carefully to the ground.*

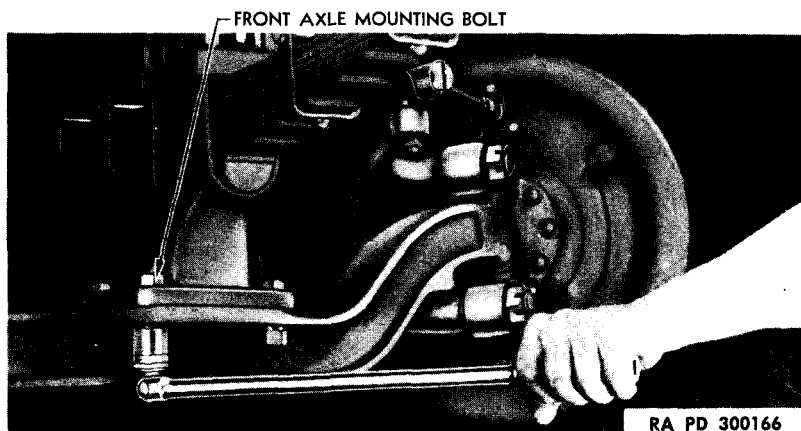

Figure 76—Tightening Front Axle Mounting Bolt

106. AXLE ASSEMBLY INSTALLATION.

a. **Install Axle.** Raise axle into position under mounting brackets and install four bolts, lock washers and nuts on each side (fig. 76). Tighten nuts and bolts securely, using one wrench on bolt head, and another on nut. Connect front wheel brake lines at junction plate on frame. Hold fittings with two wrenches to avoid twisting lines. Bleed all brake lines (par. 120). Position steering drag link over ball stud in left-hand steering knuckle arm, tapping into place with hammer, if necessary. Install adjusting plug in drag link and tighten securely. Turn nut back to nearest cotter pin slot and insert cotter pin, bending back with pliers. Install wheels on hubs and install and tighten six mounting cap screws alternately in rotation. Lower vehicle to ground and remove jacks or hoist. Check front wheel alinement (par. 104).

2½-TON 4 x 2 TRUCK (FEDERAL)

107. STEERING KNUCKLE ARM REMOVAL.

- a. Remove Steering Tie Rod from Steering Arm (par. 109).
- b. Remove Steering Knuckle Arm. Remove cotter pins from nut at front end of steering arms and remove nuts. Tap steering arms out of steering knuckle assembly with hammer.

108. STEERING KNUCKLE ARM INSTALLATION.

- a. Install Arm. Insert steering arm in steering spindle from rear, tapping in place with hammer, if necessary. Install attaching nut and turn down tightly. Adjust nut to nearest cotter pin hole and insert new cotter pin, bending back with pliers.
- b. Install Tie Rod on Steering Arm (par. 110).

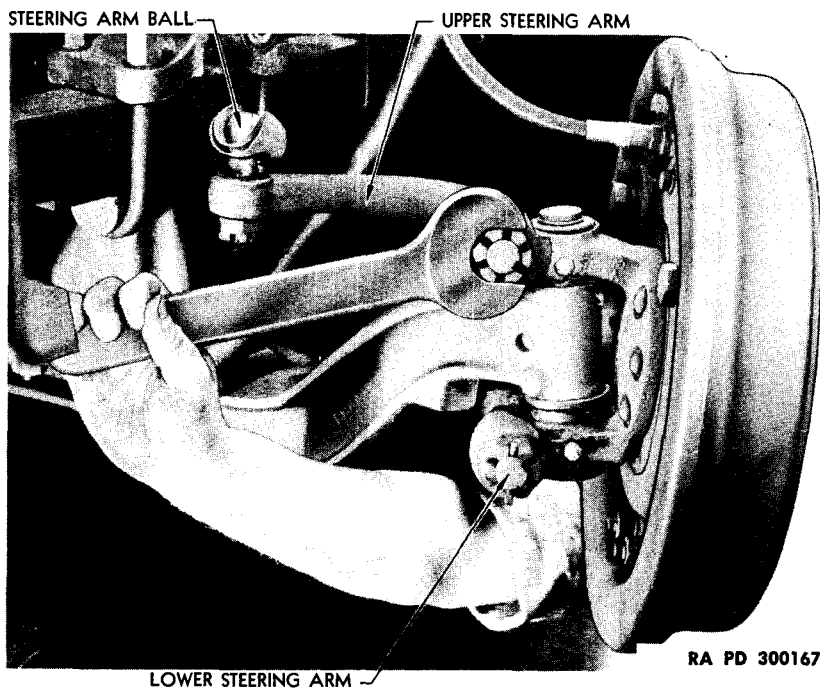

Figure 77—Removing Steering Knuckle Arm

109. TIE ROD ASSEMBLY REMOVAL.

- a. Remove cotter pin from nut at top of tie rod assembly and remove nut. Tap tie rod ends out of steering knuckle arms at each side of vehicle, taking care not to lose spring washers and grease retainers. Tie rod ends can be removed from tie rod by loosening clamp bolt and unscrewing the tie rod end. The right-hand tie rod end has a right-hand thread. The left-hand tie rod end has a left-hand thread.

FRONT AXLE

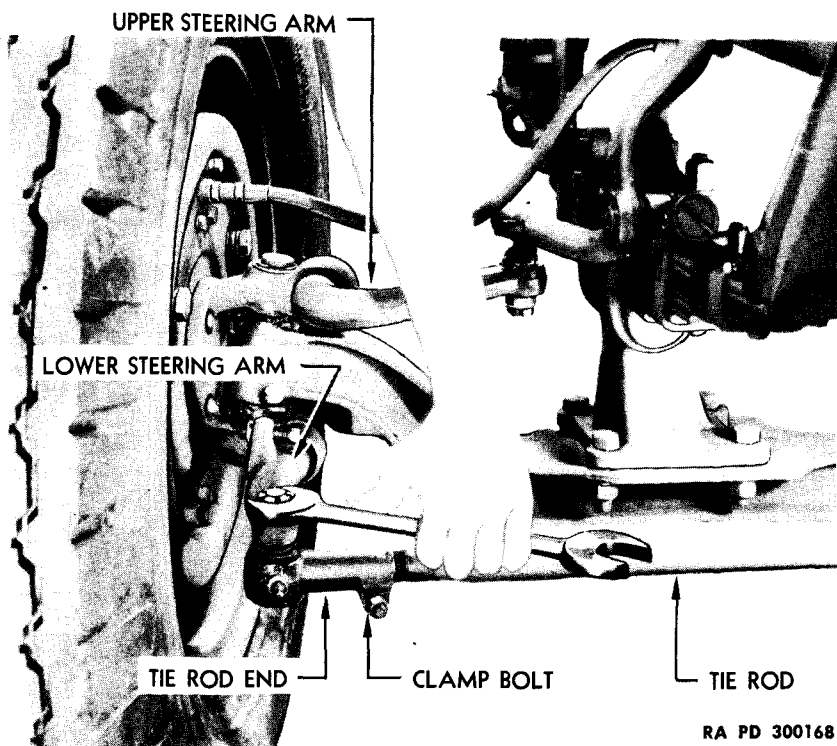

Figure 78—Removing Tie Rod Assembly

110. TIE ROD ASSEMBLY INSTALLATION.

a. **Install Tie Rod Ends.** Assemble tie rod ends to tie rod by turning onto threaded ends. Right-hand thread is used on the right-hand end, and left-hand thread on the left-hand end. Tighten clamps on tie rod ends tight enough to hold.

b. **Install Tie Rod Assembly.** Position retaining washer grease seal and upper retaining washer on tie rod end, and insert from below in each steering knuckle arm. Install attaching nut and turn down securely. Insert cotter pin to lock nut in place. Repeat procedure at other end of tie rod.

c. **Adjust Toe-in** to $\frac{1}{8}$ or $\frac{1}{16}$ inch (par. 104).

111. SPINDLE ASSEMBLY REMOVAL.

a. **Remove Wheel from Axle** (par. 139).

b. **Remove Hub and Drum Assembly from Spindle** (par. 137).

c. **Remove Steering Arm from Knuckle** (par. 107).

2½-TON 4 x 2 TRUCK (FEDERAL)

d. Remove Spindle Assembly from Axle. Using a punch and heavy hammer, drive steering spindle bolt retaining pin out toward rear of vehicle. Remove lock wire and dust cover at top of steering spindle bolt. Using drift and hammer, drive steering spindle bolt downward enough to knock out plug at bottom, and then drive upward to remove. Remove steering spindle from axle.

e. Remove Brake Backing Plate. Using hammer and cold chisel, cut rivets holding brake backing plate assembly to spindle, and remove backing plate from spindle. Disconnect hydraulic brake hose at wheel.

112. SPINDLE ASSEMBLY INSTALLATION.

a. Install Brake Backing Plate. Position and secure brake backing plate to spindle either by riveting or by inserting bolts and nuts of adequate size. Tighten securely and stake nuts in place. Connect hydraulic brake hose.

b. Install Spindle Assembly. Position steering spindle on end of axle and tap steering spindle bolt in place, making sure that cut-out for lock pin lines up with hole in axle. Drive retaining pin in axle from rear. Install new plug at lower end of steering spindle, and drive plug in place with drift and hammer. Install new dust shield and lock on top of steering spindle. Connect brake hose.

c. Install Steering Arm on Spindle (par. 108).

d. Install Hub and Drum Assembly on Spindle (par. 137).

e. Install Wheel on Hub and Drum (par. 139).

f. Adjust Toe-in on Front Wheels (par. 104).

g. Bleed Hydraulic Brake System (par. 120).

Section XXIII

REAR AXLE

	Paragraph
Description and tabulated data	113
Axle assembly removal	114
Axle assembly installation	115
Axle drive shaft removal	116
Axle drive shaft installation	117

113. DESCRIPTION AND TABULATED DATA.

a. **Description.** The rear axle is of the single-reduction, spiral bevel gear drive, full-floating type, with one-piece banjo-type housing. The pinion gear is straddle-mounted and drives bevel gear mounted on conventional-type differential assembly.

b. Tabulated Data.

Make	Timken
Model	5600
Ratio	7.25:1
Type	Full-floating
Housing	Banjo-type

114. AXLE ASSEMBLY REMOVAL.

a. **Elevate Frame.** Jack up rear of frame to relieve spring tension.

b. **Remove Wheels.** Remove rear wheels from hubs (par. 140).

c. **Disconnect Propeller Shaft.** Remove four bolts and separate universal joint at rear axle flange (par. 101).

d. **Disconnect Brake Line.** Disconnect hydraulic brake line flexible coupling from frame fitting at left side of frame behind rear axle (fig. 93).

e. **Remove Spring Seat.** Remove four nuts from U-bolts holding spring to axle and knock off lower spring seat. Replace nuts on U-bolts and drive U-bolts upward to clear axle housing. Disconnect shock absorber linkage at shock absorber arm.

f. **Remove Axle Assembly.** Lower jacks holding axle assembly until housing clears any overhead obstruction, and withdraw axle assembly from beneath chassis. Remove axle from jacks.

115. AXLE ASSEMBLY INSTALLATION.

a. **Elevate Frame.** Jack up and block frame so that upper spring seats are approximately 18 inches from the ground.

b. **Axle Position.** Place axle assembly under truck and center under upper spring seats. Elevate axle with jacks until axle contacts and centers on upper spring seat. Be sure drive pinion shaft and flange of axle are forward and properly lined up to take propeller shaft.

2½-TON 4 x 2 TRUCK (FEDERAL)

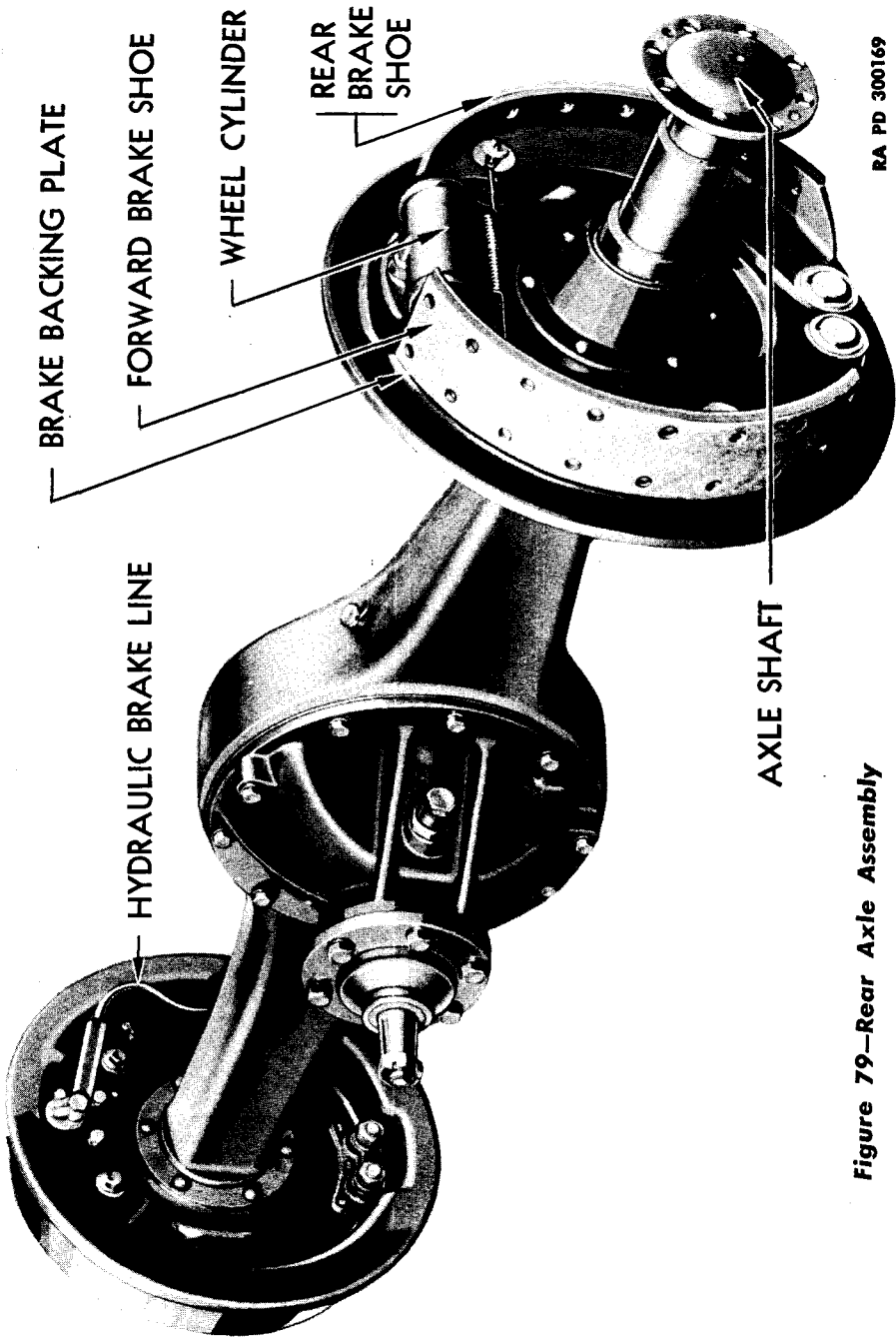

RA PD 300169

Figure 79—Rear Axle Assembly

REAR AXLE

- c. **Install Spring Seats.** Remove nuts from U-bolts. Place lower spring seats in position on U-bolts. Secure spring seats with four nuts and lock washers on each side of axle, and draw up tight.
- d. **Connect Shock Absorber Linkage to Shock Absorber Arms.**
- e. **Install Wheels on Hubs** (par. 140).
- f. **Lower Truck and Allow Wheels to Rest on Ground.**
- g. **Lower Vehicle.** Raise jack slightly to remove blocking. Lower and remove jack.
- h. **Connect Brake Line.** Connect brake flexible line at left corner of frame behind axle. Bleed and refill brakes (par. 120).
- i. **Connect Propeller Shaft to Rear Axle Flange** (par. 101).

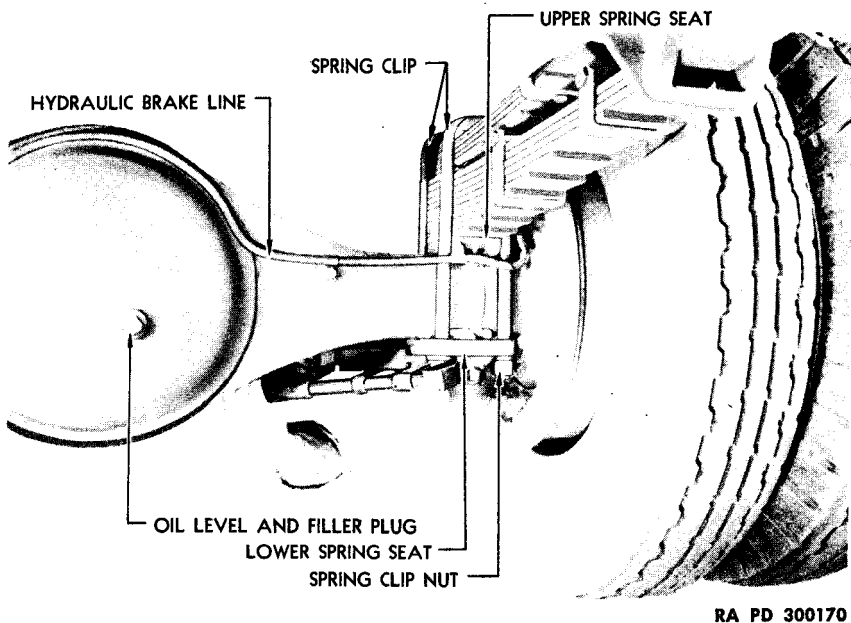

RA PD 300170

Figure 80—Removing Rear Axle Assembly

116. AXLE DRIVE SHAFT REMOVAL.

- a. **Remove Nuts.** Remove the 12 axle flange nuts, lock washers, and cone-shaped washers from studs.
- b. **Remove Axle Shaft.** Cut lock wire on puller screws (fig. 81) and while turning screws in, drive on axle flange with five-pound hammer and heavy drift. When flange loosens, pry out with pinch bar, and withdraw axle shaft.

2½-TON 4 x 2 TRUCK (FEDERAL)

117. AXLE DRIVE SHAFT INSTALLATION.

a. **Insert Axle Shaft.** Insert axle shaft in axle housing. Rotate and feel for spline alignment, and press shaft in as far as it will go, aligning flange holes with flange studs. Back out puller cap screws as far as necessary to permit flange to seat.

b. **Install Flange Nuts.** Install cone-shaped washers, lock washers, and flange nuts, and tighten alternately in rotation. Lock puller cap screws with lock wire.

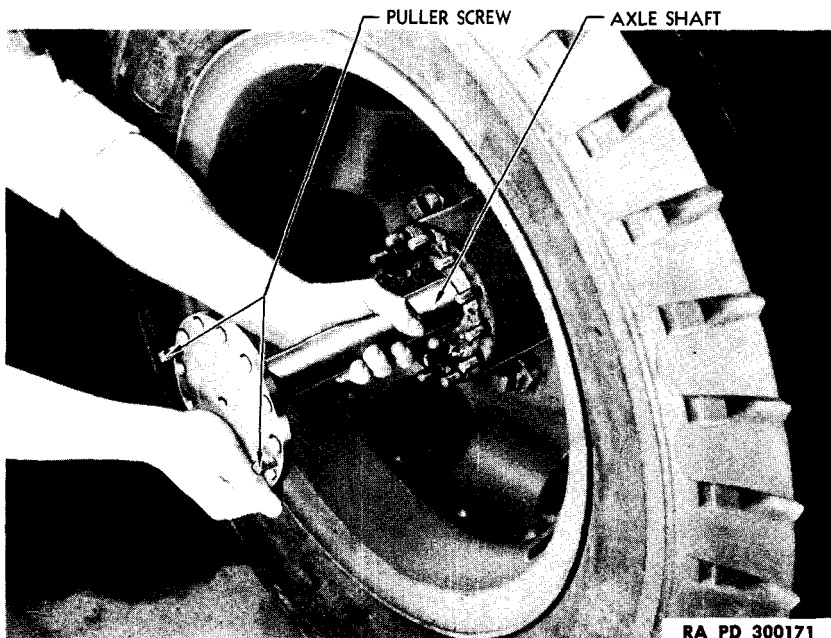

Figure 81—Removing Rear Axle Drive Shaft

Section XXIV

BRAKE SYSTEM

	Paragraph
Description and tabulated data	118
System testing	119
Bleeding the brake lines	120
Servicing brakes	121
Master cylinder	122
Wheel cylinder	123
Hydrovac assembly	124
Check valve	125
Flexible hose	126
Brake lines assembly	127
Brake shoe assembly	128
Hand brake adjustment	129
Hand brake band and lining removal.....	130
Hand brake band and lining installation.....	131
Hand brake drum removal	132
Hand brake drum installation	133
Hand brake controls removal	134
Hand brake controls installation	135

118. DESCRIPTION AND TABULATED DATA.

a. **Description.** Service brake system is the vacuum-assisted hydraulic type and operates brake shoes at all four wheels. The brake system consists of: brake pedal, pedal linkage, master cylinder, hydrovac unit, vacuum lines, hydraulic lines, fluid, and wheel cylinders. The service brakes are dependent on the function of two systems: hydraulic and vacuum. These two systems are interconnected in such a manner that hydraulic pressure actuates relay valve which controls vacuum and atmosphere in the power cylinder section of the hydrovac. The hand-brake system consists of hand brake lever, connecting linkage, brake band and lining assembly, and brake drum. The lever movement is transmitted to brake band through pull rod, which applies the brake by drawing the brake band and lining assembly tightly around the brake drum. Brakes are released when the lever is moved forward and, with the assistance of return springs, the lining is released from brake drum.

b. **Hydraulic System.** The primary or actual brake-operating system consists of a master cylinder, one wheel cylinder at each wheel, hydrovac slave cylinder, and hydraulic hose and lines. The master cylinder is operated through brake pedal and connecting linkage. The hydraulic system employs the principle of forcing fluid through the lines to the wheel cylinder pistons, which expand the brake shoes against the brake drums.

2½-TON 4 x 2 TRUCK (FEDERAL)

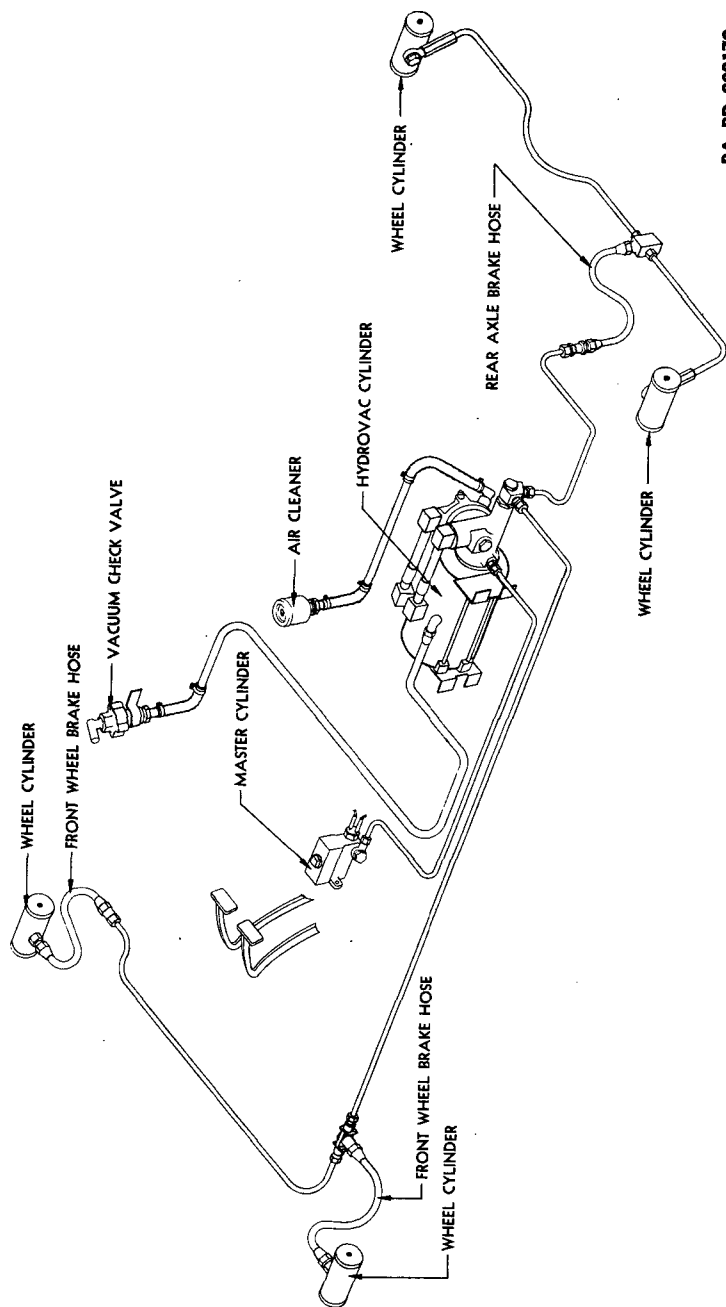

RA PD 300172

Figure 82—Brake System Layout

BRAKE SYSTEM

c. **Vacuum System.** The secondary, or assisting system, consists of a hydrovac unit (relay valve, power cylinder and hydraulic slave cylinder combined), check valve, and interconnecting tubing and lines. This system utilizes the engine manifold vacuum and atmosphere to operate the power cylinder, which assists the driver in building up the sufficient hydraulic pressure that is needed to apply the brakes. Movement of the power cylinder pistons, controlled by vacuum and atmosphere, forces fluid from hydraulic slave cylinder through brake lines to each wheel cylinder. As brakes are released, hydraulic pressure at relay valve drops, shutting off atmospheric pressure in power cylinder, and opening both sides of cylinder pistons to vacuum.

d. Tabulated Data for Service Brakes.

Type	Bendix hydrovac
Front brake size	14 x 2 in.
Lining width	2 in.
Lining thickness	¼ in.
Rear brake size	16 x 3½ in.
Lining width	3½ in.
Lining thickness	¼ in.
Hand brake type	Drum and band
Hand brake drum diameter	9½ in.
Hand brake drum width	3 in.
Hand brake lining width	3 in.
Hand brake lining thickness	⅝ in.

119. SYSTEM TESTING.

a. **Primary Testing.** Connect a vacuum gage to intake manifold, adjust engine to its normal idling speed by means of throttle stop screw, then adjust the idle mixture adjusting needle until vacuum gage indicates maximum reading. If this latter adjustment changes idle speed appreciably, reset idle speed and mixture until both are satisfactory. Note maximum vacuum reading. Check hydraulic fluid level in master cylinder. Fluid should be within ⅜ to ½ inch of filler cap. If not, check for leaks.

b. **Test Brake Pedal Adjustment.** Check clearance between brake pedal and toeboard. Brake pedal must have ½- to 1-inch clearance at toeboard with pedal in released position. If pedal strikes against toeboard, master cylinder will not fully release.

c. Check Valve and Vacuum Line Test.

(1) Remove hose clamps attaching vacuum line to hydrovac center plate fitting. Attach vacuum gage to end of vacuum line so that no leaks exist at this point. Start engine and note vacuum gage reading, which should be the same as vacuum at manifold, if there are no leaks.

(2) Turn off ignition switch to stop engine. Observe rate of vacuum drop. If vacuum drops more than 1 inch every 15 seconds, it indicates that vacuum check valve is not seating properly, or that

2½-TON 4 x 2 TRUCK (FEDERAL)

vacuum line is leaking at one of the connections. Inspect and tighten all connections or replace vacuum valve (par. 125). Remove vacuum gage. Connect vacuum line to hydrovac, being careful when tightening connections to prevent leaks.

d. Power Cylinder and Relay Valve Test.

(1) Disconnect vacuum line from hydrovac center plate fitting. Install a suitable tee in center plate fitting so that vacuum line can be connected, and a vacuum gage installed. Make sure all connections are leakproof. With engine running, vacuum gage reading should be same as manifold vacuum. Turn off ignition switch to stop engine and note rate of vacuum drop at gage. If rate of vacuum drop is more than 2 inches every 15 seconds (when vacuum lines and check valve have been tested (step c above), and are known to be free from leaks), it indicates that leaks exist in hydrovac, and complete unit must then be replaced.

(2) Start engine and apply brakes. Stop engine and carefully hold brake pedal very steadily in this applied position. Note rate of vacuum drop at gage. If rate of vacuum drop is more than 1 inch every 15 seconds, it indicates that vacuum and atmospheric valves in relay valve or power piston seals are defective, and complete unit must be replaced. Remove vacuum gage and tee from center plate fitting at hydrovac. Connect vacuum line to fitting. Remove plug from forward end of hydrovac and install vacuum gage. Start engine and apply brakes. If atmospheric valve in relay valve is functioning properly, gage reading will drop to "0"; if it does not, hydrovac unit must be replaced.

e. Hydraulic Slave Cylinder Test.

(1) With engine stopped, make a few applications of brakes to deplete vacuum from hydrovac power cylinder or vacuum lines. Remove bleeder valve screw at any one of the wheels. Install 2000-pound hydraulic pressure gage in the bleed hole and tighten it securely.

(2) While engine is still stopped, apply brakes and note hydraulic pressure at gage. Pressure will indicate that brake fluid is passing through hydrovac slave cylinder, which makes it possible to apply brakes in case of hydrovac failure. This hydraulic pressure is the output of the brake master cylinder.

(3) With brake pedal held in same position (step d (2) above), start engine and note increase of hydraulic pressure. If hydraulic pressure increases approximately 800 pounds, this indicates that hydrovac slave cylinder is functioning satisfactorily on application.

(4) Release foot brake pedal quickly and note drop of hydraulic pressure at gage. If pressure returns to near "0" immediately, it indicates that slave cylinder valve is functioning satisfactorily. Remove hydraulic gage attached at wheel bleeder screw. Install bleeder valve screw and tighten securely.

BRAKE SYSTEM

120. BLEEDING THE BRAKE LINES.

a. Whenever any service operations make it necessary to disconnect hydraulic lines, it is necessary to bleed entire brake system. A bleeder screw is provided at each wheel cylinder, also three bleeder screws are used at the hydrovac unit (figs. 83, 84, and 90). There are two methods of bleeding the lines—pressure and manual.

b. Pressure Bleeding Procedure (With Pressure Tank).

(1) Remove screws attaching floor boards and remove floor boards. Remove filler cap from master cylinder. When using pressure tank, make sure fluid level is up to pet cock above outlet, and that tank

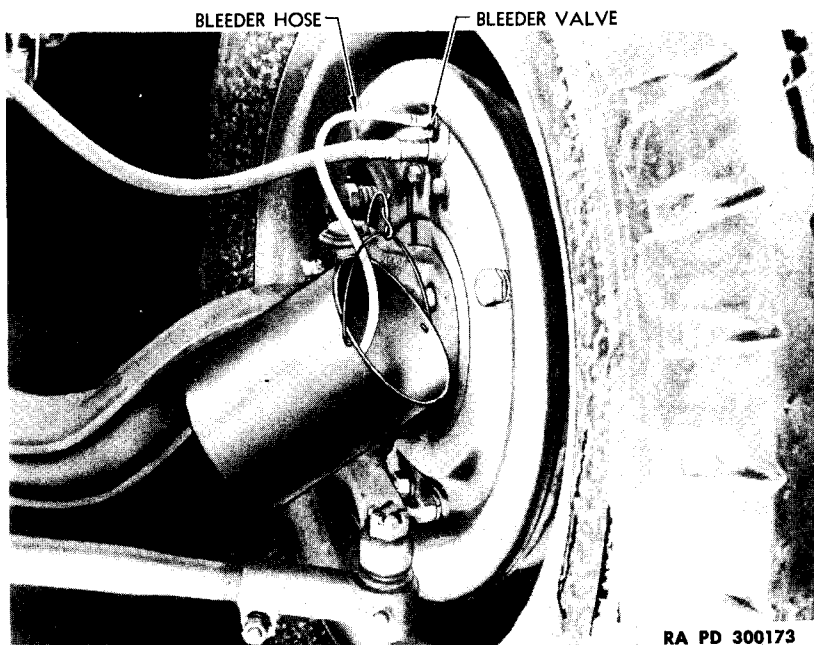

Figure 83—Bleeding Front Brake

has 10 to 20 pounds of air pressure before starting the bleeding operation. Connect bleeding tank hose to master cylinder filler cap opening, using proper size fitting.

(2) Remove cap screws and lock washer (at wheel cylinder or at hydrovac) from bleeder screw. Attach bleeder tube in end of bleeder valve screw. Place opposite end of bleeder tube in suitable container which should have sufficient fluid to cover end of tube. Inaccessibility of rear wheel bleeder screws is such that conventional-type bleeder hose cannot be used. Therefore, allow fluid to run directly out of bleeder valve screw.

2½-TON 4 x 2 TRUCK (FEDERAL)

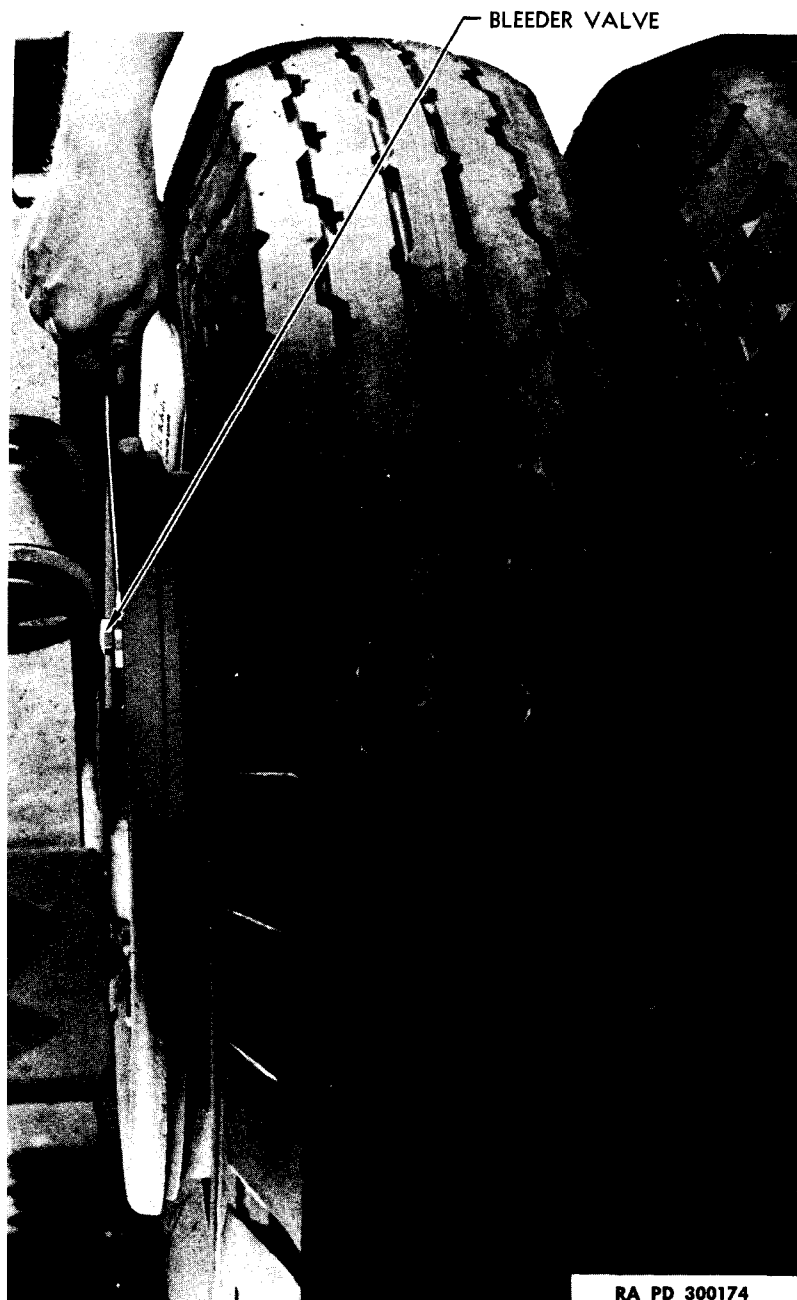
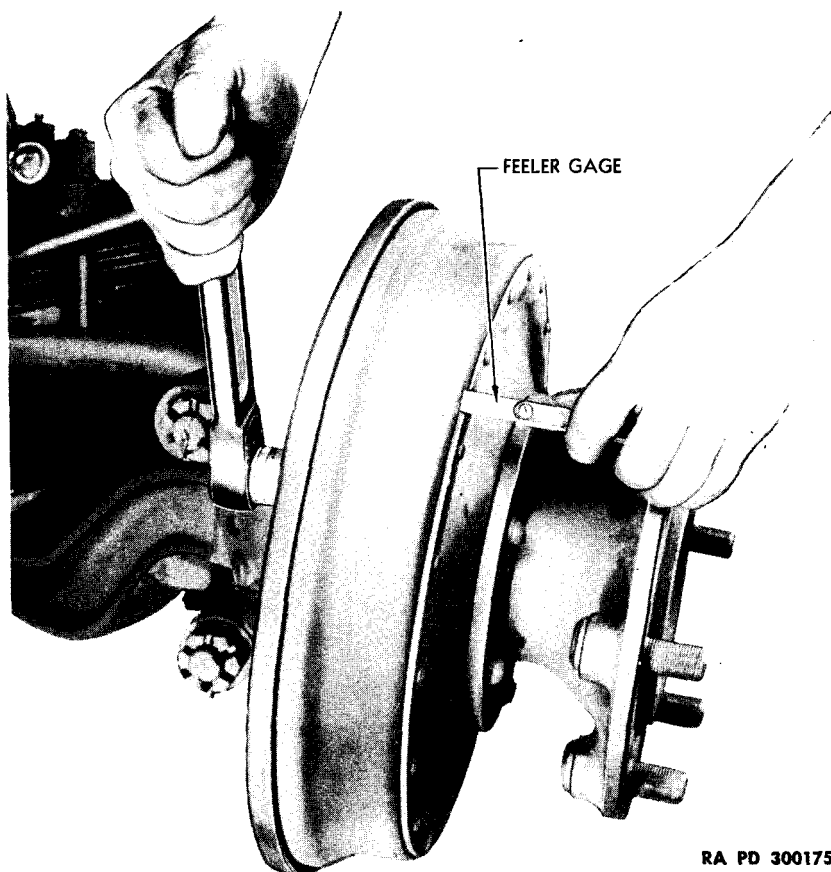

Figure 84—Bleeding Rear Brake

BRAKE SYSTEM

(3) Note air pressure in pressure tank, which must be from 10 to 20 pounds. Also see that fluid level is above shut-off valve on tank. Open shut-off cock at pressure tank. Open bleeder valve screw $\frac{3}{4}$ turn counterclockwise and watch flow at end of bleeder hose. Close bleeder valve tightly as soon as air bubbles stop and fluid comes out in solid stream. Remove bleeder hose and install cap screw and lock washer. Repeat operation at all four wheels, cylinders, and at the three hydrovac bleeder screws. Hydrovac bleeder screw must be bled in proper order ("A", "B", and "C") (fig. 90). Remove bleeder hose attached to master cylinder filler cap. Install cap and floor boards.



RA PD 300175

Figure 85—Adjusting Front Brake Cam

c. Manual Bleeding Procedure.

(1) Manual bleeding requires no special equipment other than bleeder hose and suitable container. Master cylinder must be completely filled with fluid. Operations necessary to manually bleed

2½-TON 4 x 2 TRUCK (FEDERAL)

system are the same as described above for pressure bleeding, except that pressure tank is not required and brake pedal is "pumped" to force fluid through lines, to expel air from system. Refill master cylinder after bleeding each point, as air may be taken into system unless master cylinder is kept full.

(2) Inaccessibility of rear wheel cylinder bleeder valve screws for attachment of bleeder hose is such that conventional-type bleeder hose cannot be used. Therefore, it is necessary to allow fluid to run directly from fitting. To successfully bleed rear wheel brake lines manually in this manner, it is necessary to close bleeder valve screw immediately each time brake pedal is depressed before pedal is released, or air will be taken into lines.

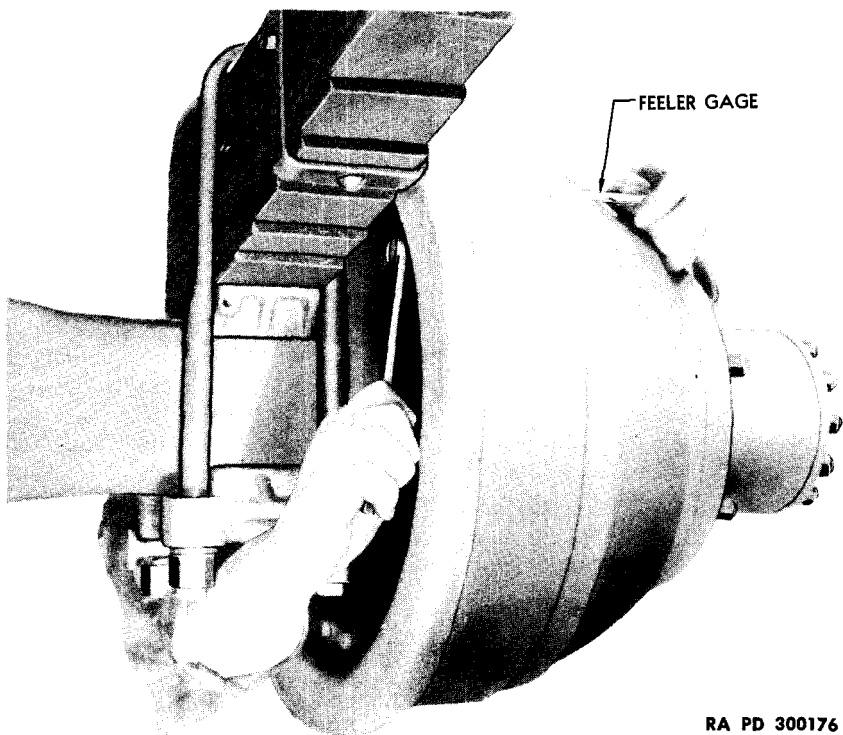

RA PD 300176

Figure 86—Adjusting Rear Brake Cam

121. SERVICING BRAKES.

a. **Minor Adjustment Procedure.** Minor adjustment is required after normal wear occurs on brake linings, and pedal travel becomes excessive. Minor adjustments consist of turning eccentric cams near top of each brake backing plate (fig. 85). Adjustment procedure is same for all four wheels. Jack up wheel and check wheel bearing

BRAKE SYSTEM

adjustment. Proper brake shoe adjustment cannot be obtained unless wheel bearings are correctly adjusted. Turn adjusting cam at top of backing plate until brake drags slightly when wheel is turned by hand. Back off adjusting cam until wheel turns freely. Both adjustments at each shoe, and at each wheel, must be as nearly alike as possible.

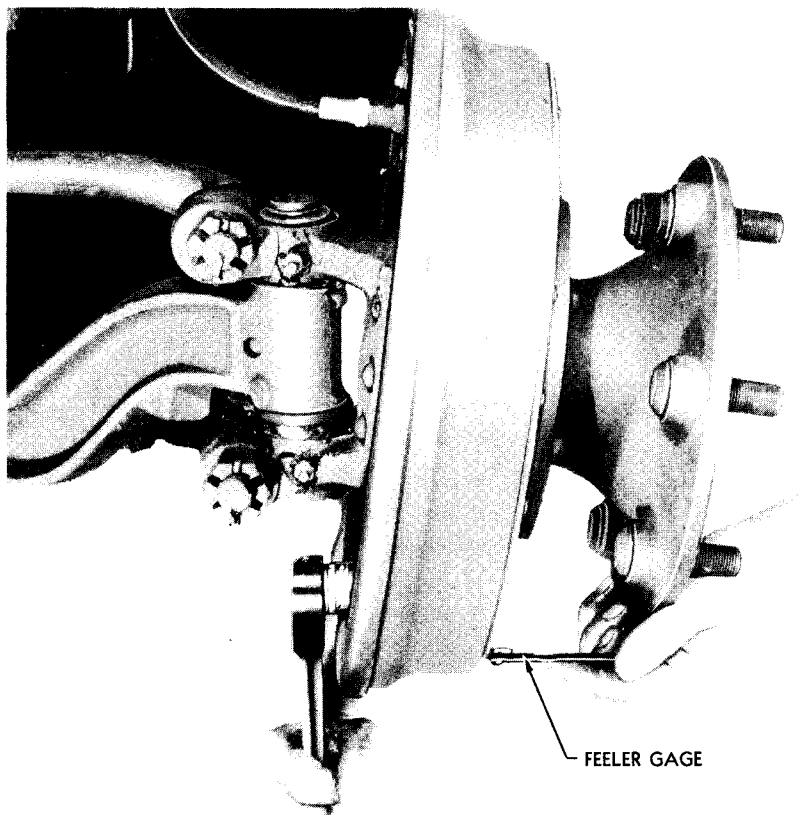

RA PD 300177

Figure 87—Adjusting Front Brake Anchor Pin

b. Major Adjustments Procedure. Major adjustments are not ordinarily necessary, except after installing new shoes and linings; or if anchor pins have been previously misadjusted, or if minor adjustments as described do not give satisfactory results. Major adjustments consist of turning eccentric anchor pins at bottom of each brake backing plate (figs. 87 and 88). Remove wheel to expose inspection cover on brake drum. Remove retaining screw and cover and back off

2½-TON 4 x 2 TRUCK (FEDERAL)

lock nuts on two eccentric anchor pins at bottom of brake backing plate (figs. 87 and 88). Turn anchor pin and adjusting cam until clearance of 0.006 inch is secured at lower end of shoe and 0.012 inch at upper end of shoe. *NOTE: Check this clearance with feeler gage at*

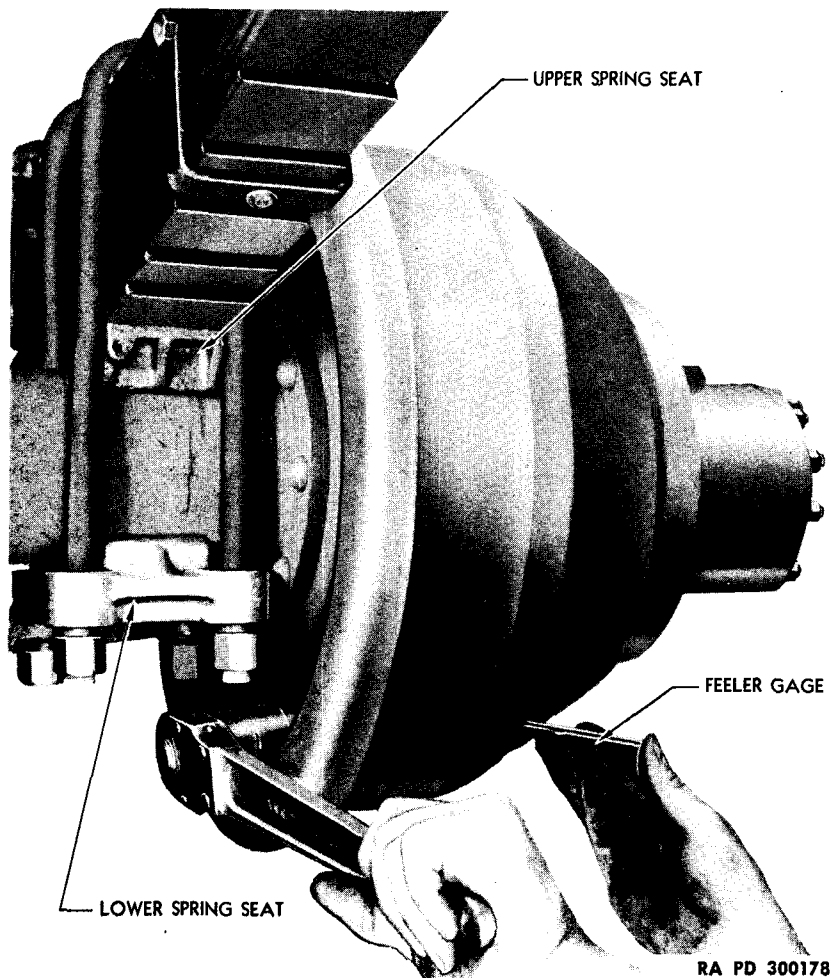

Figure 88—Adjusting Rear Brake Anchor Pin

about 1½ inch from end of lining at each end of each shoe. When adjustment has been completed, hold anchor pins securely with wrench to prevent them from turning while lock nuts are tightened. Make final check of brake shoe-to-drum clearance with feeler gage, to be sure that anchor pins have not been moved, or that adjustment did not change while lock nut was being tightened.

BRAKE SYSTEM

122. MASTER CYLINDER.

a. **Description.** The master cylinder provides a means of converting the pedal effort into hydraulic pressure for operation of the hydrovac relay valve, and for direct application of a portion of the force required to operate brakes. The master cylinder is attached to the support bracket at left-hand side of the chassis and is connected directly to the brake pedal.

b. **Remove Master Cylinder.** Remove cotter pin and clevis pin at brake pedal. Loosen nut at rear of master cylinder and disconnect

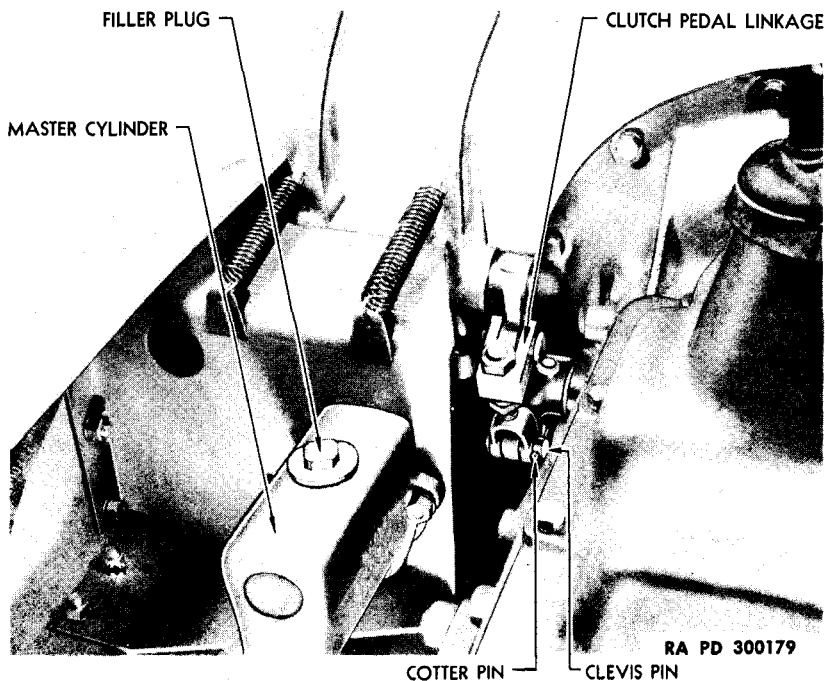

Figure 89—Brake Master Cylinder Mounting

hydraulic line. Pull the socket-type connections out of stop light switch at master cylinder. Remove master cylinder by removing three bolts and nuts which attach master cylinder to mounting bracket, and then withdraw master cylinder out of bracket.

c. **Install Master Cylinder.** Install master cylinder in position in mounting bracket by installing and tightening the three mounting bolts, lock washers and nuts. Plug in socket-type connectors at stop light switch at rear of master cylinder. Connect hydraulic line at rear

2½-TON 4 x 2 TRUCK (FEDERAL)

of master cylinder and tighten tubing nut securely. Insert clevis pin in yoke and then through pedal and install cotter pin to connect linkage. Bleed entire hydraulic system (par. 120).

123. WHEEL CYLINDER.

a. **Description.** One wheel cylinder is used at each wheel to convert the hydraulic pressure energy in the lines to direct mechanical force against the brake shoes. Each wheel cylinder contains two pistons, which are forced outward by the hydraulic pressure. The pistons act directly on the brake shoes.

b. **Remove Wheel Cylinder.** Remove wheel and hub assemblies from axles (pars. 137 and 138). Install wheel cylinder clamp over ends of wheel cylinder to keep wheel cylinder together. Remove brake shoe retracting spring, using suitable pliers. Before removing cylinder, disconnect hydraulic fluid line. Do not twist flexible hose at front wheels. Remove cap screws and lock washers attaching cylinder to backing plate. Lift cylinder with clamp from backing plate.

c. **Install Wheel Cylinder.** With wheel cylinder clamp in place, install cylinder on backing plate, using cap screws and lock washers. Draw screws up tightly and evenly. Connect hydraulic brake fluid line to wheel cylinder. NOTE: *Do not twist flexible hose at front wheels when tightening line connections.* Install brake shoe retracting spring, using pliers. Unhook and remove clamp from ends of wheel cylinder. Replace wheel and hub assembly on axle (pars. 137 and 138). Bleed each wheel cylinder which has been removed. Adjust brake shoes to proper clearance (par. 121).

124. HYDROVAC ASSEMBLY.

a. Hydrovac air cleaner is located under the driver's seat and is connected to hydrovac unit (fig. 82). Atmosphere entering power cylinder via relay valve passes through air cleaner and is filtered by the curled hair element within the air cleaner. Element in air cleaner is oiled as an aid in preventing dirt from reaching relay valve and power cylinder.

b. **Maintenance.** Remove screw and flat washer holding cover, outer screen, curled hair, inner screen, and stem from shell. Place all parts in dry-cleaning solvent to loosen accumulated dirt. After deposits of dirt have been removed, blow all parts dry with compressed air. Saturate curled hair in light engine oil and allow surplus to drain off. Place stem through hole in shell and install inner (small) screen in bottom of shell. Place oiled, curled hair evenly around stem inside of shell. Place outer (large) screen inside of shell with edge of screen toward cover. Replace cover and attach with flat washer and screw.

c. **Hydrovac Removal.** Loosen tubing nut to disconnect hydraulic inlet line at rear end of hydrovac near relay valve. Loosen tubing nut to disconnect the two hydraulic outlet lines at rear end of hydrovac

BRAKE SYSTEM

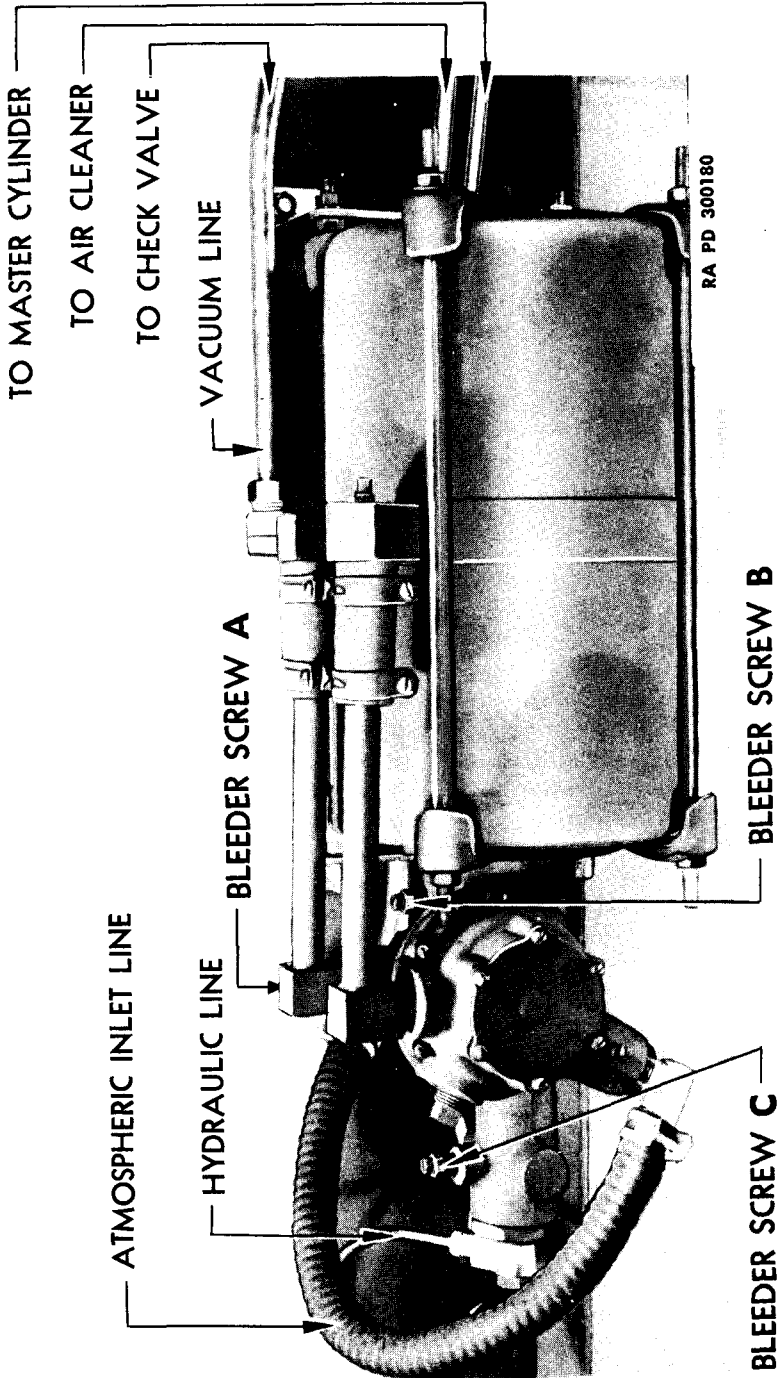

Figure 90—Hydrovac Assembly

2½-TON 4 x 2 TRUCK (FEDERAL)

slave cylinder. Loosen clamp screw and pull flexible hose off fitting at relay valve. Disconnect vacuum line at hydrovac. Insert wrench between tool box and dump body front cross member. (Fitting is located at frame directly beneath left front corner of dump body). Remove two nuts and lock washers attaching hydrovac to rear support bracket. Remove the two bolts, nuts, and lock washers which attach front bracket to frame side rail. Hydrovac assembly with front bracket can now be completely removed from vehicle. **NOTE:** *It is unnecessary to remove both brackets in order to remove hydrovac.*

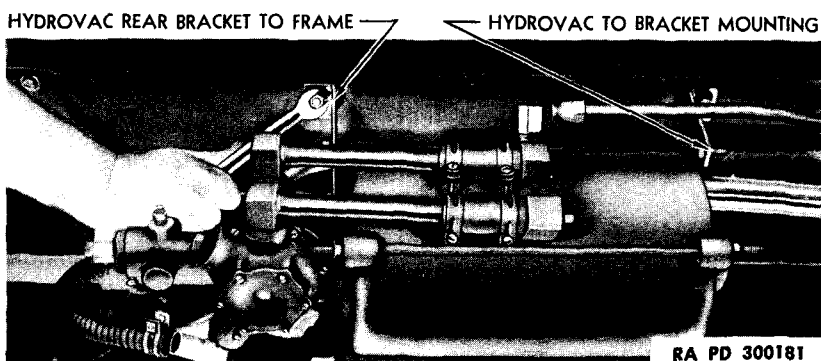

Figure 91—Removing Hydrovac Assembly

d. **Hydrovac Installation.** Place hydrovac in vehicle with slave cylinder end toward rear of chassis and with vacuum line fitting on top. Insert two clamp studs of hydrovac unit through holes in rear frame bracket, and install two lock washers and nuts. Install hydrovac front bracket to frame side rail with two bolts, lock washers, and nuts; tighten securely. Attach hydraulic inlet line (master cylinder to hydrovac) to inner side of slave cylinder housing. Attach hydraulic outlet line (from wheel cylinders) to end of slave cylinder. Tighten fitting securely to prevent hydraulic fluid leaks. Raise body and insert open-end wrench from above chassis, between hoist front cross member and tool box. Connect atmosphere lines (from air cleaner) to hydrovac relay valve. Tighten all connections and hose clamps securely to prevent leaks. Bleed hydraulic system (par. 120).

125. CHECK VALVE.

a. **Description.** The check valve provides a means of sealing vacuum system against loss of vacuum, or entrance of atmospheric pressure from engine when manifold vacuum is low, or when engine is not operating. Check valve is installed in vacuum line between engine manifold and hydrovac unit, and is located at right-hand rear corner of engine compartment.

BRAKE SYSTEM

b. **Check Valve Removal.** Loosen clamp screws and disconnect inlet and outlet hose from upper and lower valve fittings. Loosen clamp screw at check valve mounting bracket. Pull check valve upward and out of clamp. Do not remove bracket.

c. **Check Valve Installation.** Install check valve in bracket with straight fitting downward. Tighten screws securely. Connect end of flexible hose from manifold to check valve inlet elbow. Connect hose from hydrovac to outlet fitting at bottom of check valve. Tighten hose clamp screws to prevent leaks.

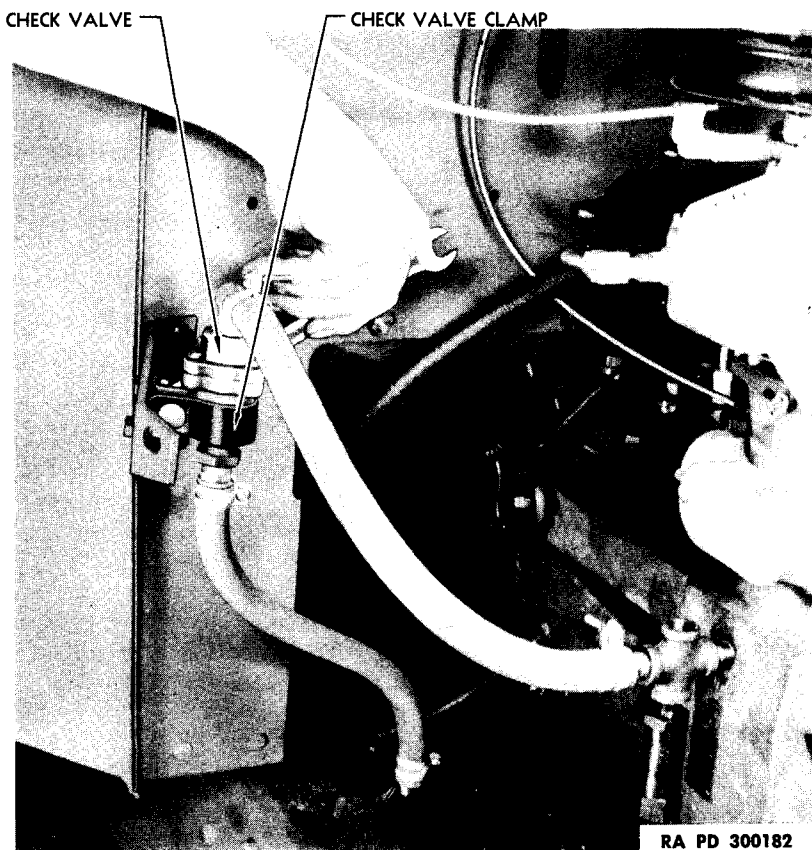

RA PD 300182

Figure 92—Removing Hydrovac Check Valve

126. FLEXIBLE HOSE.

a. **Description.** The flexible hydraulic hose is used between the frame and the front wheel cylinders.

b. **Flexible Hose Removal.** Remove bolts attaching tee to housing at three-way connection. At side opposite three-way connection,

2½-TON 4 x 2 TRUCK (FEDERAL)

remove tubing flared nut. Remove lock nut and shakeproof lock washer attaching hose to fitting. Use two wrenches, one at hose fitting and the other at lock nut, to prevent twisting the hose. Remove flexible hose at wheel cylinder with a wrench.

c. **Flexible Hose Installation.** Use a new gasket and attach flexible hose to wheel cylinder. Attach opposite end of hose to frame fitting and replace shakeproof lock washer and lock nut at inside of fitting. Use two wrenches to avoid twisting hose while tightening nut. Attach tee to housing, using the special bolt. Attach tubing nut directly to flexible hose and connect flared fitting nut to attach tubing. Be sure all connections are tight.

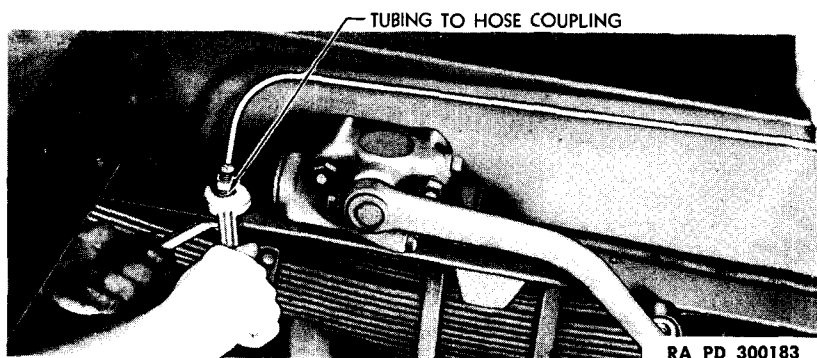

Figure 93—Removing Hydraulic Brake Hose

127. BRAKE LINES ASSEMBLY.

a. **Tubing Repair.** Use special tube cutter to prevent flattening. Square off the ends with a fine cutting file, then ream the sharp edges with reamer blade provided on the tube cutter. Install new compression coupling nuts on tubing. Dip end of tubing to be flared in hydraulic brake fluid. This lubrication results in a better formation of the flare. Loosen clamping nuts on flaring tool. Insert finished end of tubing in the channel of the die until it bears against the stop pin. Tighten clamping nuts by hand and place fixture in a bench vise. Tighten down clamping nuts firmly with a wrench. Remove stop pin from the die. Grip tubing firmly in die. Use the flare-forming tool having the concave die. Insert tool in die and strike firm blows with a hammer until shoulder of the tool contacts top of die. Use flare-forming tool having 45-degree die at its lower end. Insert tool in die and strike firm blows with the hammer until shoulder of tool contacts top of die. Remove tube from tool and install tube.

BRAKE SYSTEM

128. BRAKE SHOE ASSEMBLY.

a. **Description.** Shoes are anchored to the backing plate by adjustable eccentric anchor pins at the lower end of the shoes. The adjusting cams located near the upper end of the shoes bear against the brake shoe itself. Guide pins, two in each shoe, are riveted to the backing plate. Special washers, used over the guide pins, are installed on

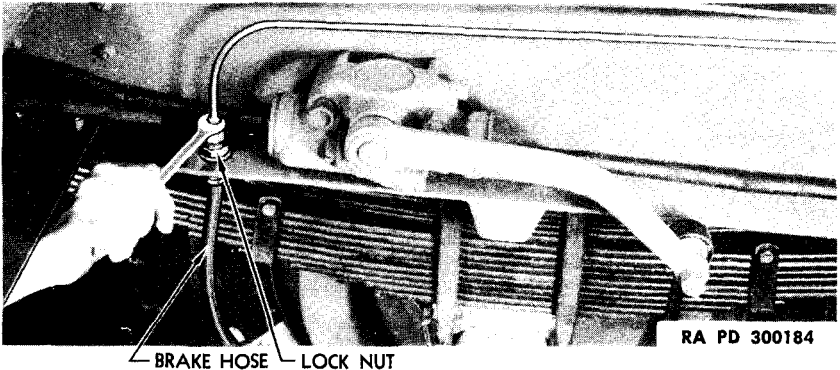

Figure 94—Removing Hydraulic Brake Line

each side of the shoe and are held in place by C-shaped washers in the grooves at the outer end of the pin. C-shaped washers are also used to hold the brake shoes in place on anchor pins.

b. **Remove Brake Shoe Assembly.** Remove wheel and hub assembly (pars. 137 and 138). Use a pair of pliers to remove C-washers from anchor pins at bottom of shoes and from guide pins near center of shoes. Disconnect brake shoe return spring, using suitable pliers. Place a suitable spring-type clamp in position over ends of wheel cylinders. If same brake shoes are to be reinstalled, it is advisable to mark shoes so that they can be replaced in their original position. Note position of punch marks on heads of eccentric anchor pins so that they may be installed in their original position. This is unnecessary when new shoes and linings are installed, as a complete major adjustment will then be necessary (par. 121). Pull shoe straight out to remove from anchor pins and guide pins.

c. **Install Brake Shoe Assembly.** Install shoe on backing plate by guiding it over anchor pins and guide pins. Use new C-washers, and tap them in place in groove of anchor pins, making sure that washers are fully seated. Use pliers to clamp ends of washers together. Install flat washers on each side of shoe. Then install C-washers in groove of guide pins and clamp ends together with pair of pliers. Install brake shoe return springs and see that they are securely connected to brake shoes. After brake shoe return spring is installed, remove wheel cylinder clamp. Install hub and drum to axle (pars. 137 and 138). Adjust brake shoes to proper clearance (par. 121).

2½-TON 4 x 2 TRUCK (FEDERAL)

129. HAND BRAKE ADJUSTMENT.

a. **Release Hand Brake Lever.** Set hand brake lever in fully released position by moving lever as far forward as possible.

b. **Adjust Anchor Screw.** Remove lock wire from anchor screw slot. Turn anchor screw as necessary to obtain 0.010-inch to 0.015-inch clearance between lining and drum. Insert feeler gage between lining and drum, opposite anchor. Thread lock wire through band anchor

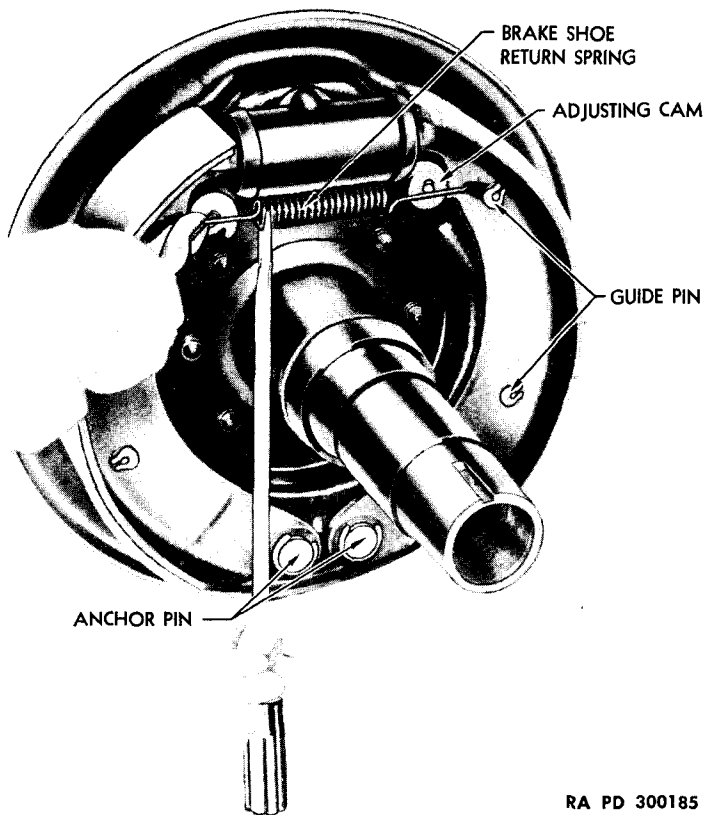

Figure 95—Removing Brake Shoe Return Spring

bracket and slot in anchor screw. Twist ends of wire to prevent anchor screw turning.

c. **Adjust Locating Screw.** Loosen lock nut on locating screw. Use screwdriver in slotted head of locating screw to prevent screw turning. Turn adjustment nuts to obtain 0.020-inch clearance between lining and drum. Measure clearance at lower end of band, about 1½ inches from end of lining. Tighten lock nut when proper adjustment has been obtained.

BRAKE SYSTEM

d. **Adjust Adjusting Bolt.** Loosen lock at lower end of adjusting bolt. Turn adjusting nut to obtain 0.020-inch clearance between lining and drum. Measure at upper end of band, about 1½ inches from end of lining. Tighten lock nut when proper adjustment has been obtained.

e. **Adjust Pull Rod.** Remove cotter pin and clevis pin attaching adjustable yoke to cam levers. Loosen adjustable yoke lock nut. Turn yoke as necessary to line up holes in yoke and cam levers. Attach adjustable yoke to cam levers, using clevis pin and cotter pin. Tighten adjustable yoke lock nut.

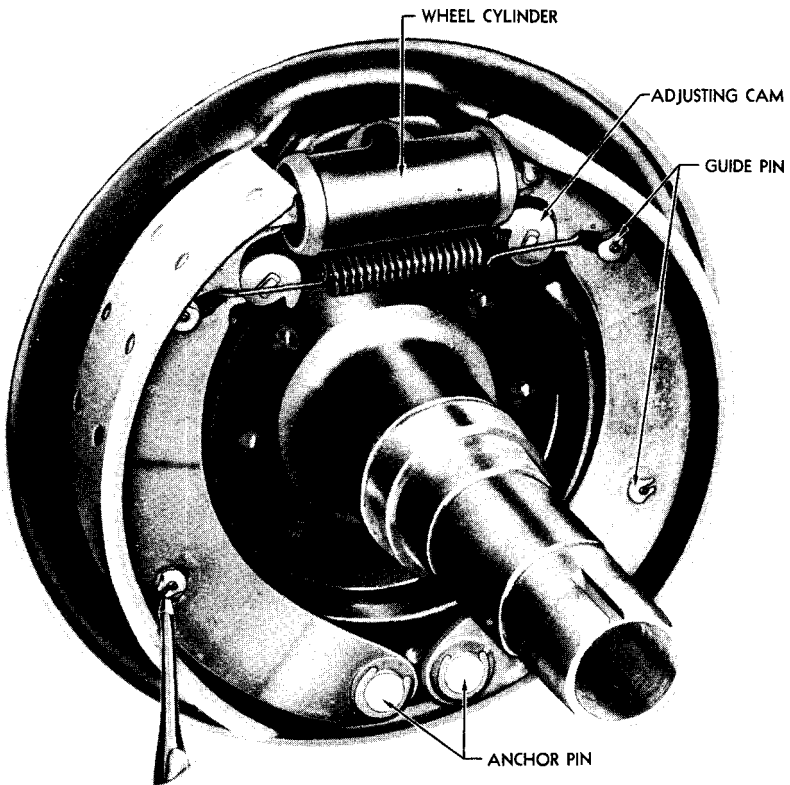

RA PD 300186

Figure 96—Removing Brake Shoe "C" Clamp

2½-TON 4 x 2 TRUCK (FEDERAL)**130. HAND BRAKE BAND AND LINING REMOVAL.**

a. **Disconnect Linkage.** Remove cotter pins and clevis pins attaching spacer links to brake support and adjusting bolt.

b. **Remove Adjusting Bolt.** Use wrench to remove lock nut and adjusting nut from lower adjusting bolt. Remove lock washer, flat washer, and compression spring from lower end of adjusting bolt. Lift bolt straight up as two release springs and cam shoe are removed.

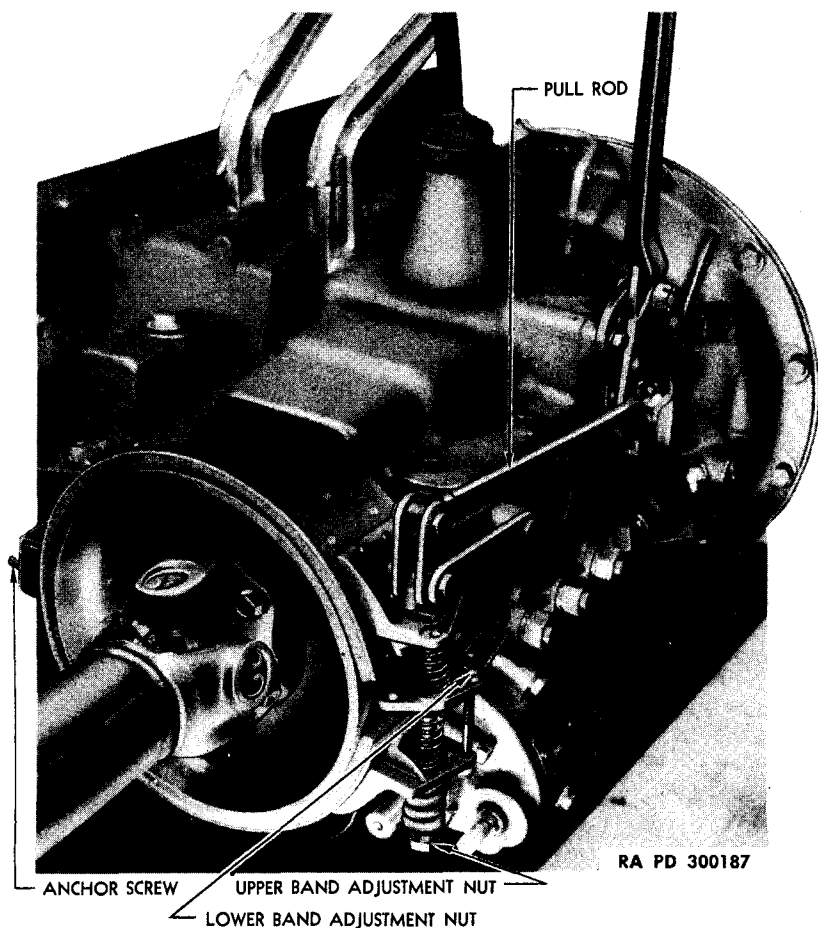
**Figure 97—Hand Brake Adjustment**

BRAKE SYSTEM

c. **Remove Locating and Anchor Screws.** Use wrench to remove two nuts from locating screw, so that screw can be lowered and removed. Use pliers to cut anchor screw lock wire. Remove anchor screw from anchor and band anchor bracket.

d. **Remove Band and Lining.** Pull brake band and lining assembly toward rear to remove from brake support. When band has been removed, anchor screw spring can also be removed.

131. HAND BRAKE BAND AND LINING INSTALLATION.

a. **Install Brake Band.** Place anchor screw spring in left-hand support while brake band lining assembly is being moved forward and over anchor.

b. **Install Anchor and Locating Screws.** Thread anchor screw through band anchor and into support anchor. Anchor screw is only temporarily installed at this time. Pass locating screw through holes in brake band lower bracket and support. Temporarily thread two nuts on locating screw.

c. **Install Adjusting Bolt.** Place cam shoe on adjusting bolt. Pass threaded end of adjusting bolt downward through band upper bracket, and then through upper release spring, support, lower release spring, and band lower bracket. Place compression spring, flat washer, and adjusting nuts on lower end of adjusting bolt.

d. **Install Clevis Pins.** Place spacer link at each side of spacer eye and attach with clevis pin. Attach spacer links to adjusting bolt eye and cam levers by passing clevis pin through spacer links, cam levers, and adjusting bolt loop. Install cotter pin in each clevis pin eye.

e. **Adjust Brake Band.** Adjust brake lining to drum clearance (par. 129).

132. HAND BRAKE DRUM REMOVAL.

a. **Disconnect Propeller Shaft.** Remove four nuts and lock washers from bolts which attach front end of front propeller shaft yoke to drum (par. 101).

b. **Remove Propeller Shaft.** Remove center bearing retaining bolts and remove center bearing and front propeller shaft (par. 102).

c. **Remove Brake Drum.** Pull brake drum toward rear and remove.

133. HAND BRAKE DRUM INSTALLATION.

a. **Install Brake Drum.** Clean bolting surfaces on both sides of drum. Place drum in its correct position inside of lining, and push forward against universal joint flange. Turn drum to line up bolt holes, and push bolts through drum holes and mating holes in flange.

b. **Install Propeller Shaft** (par. 101).

c. **Adjust Brake Band.** Adjust brake lining to drum clearance (par. 129).

2½-TON 4 x 2 TRUCK (FEDERAL)

134. HAND BRAKE CONTROLS REMOVAL.

- a. Remove Pull Rod.** Remove cotter pin attaching pull rod to lever so that rod can be moved toward rear.
- b. Remove Sector Bolts.** Remove nuts and lock washers from bolts attaching sector to support bracket. Remove lever and sector assembly. During removal see that two spacers between sector and support bracket are not mislaid or lost.
- c. Remove Sector.** Remove sector from lever by taking cotter pin and nut from bolt which acts as pivot for lever.

135. HAND BRAKE CONTROLS INSTALLATION.

- a. Attach Sector.** Place sector between forks at lower end of lever, and insert bolt through lever and sector. Replace nut on bolt, tighten, and lock with cotter pin.
- b. Install Pull Rod.** Attach pull rod to lever before attaching lever to transmission. Rod is secured to lever by clevis pin.
- c. Install Lever.** Attach sector and lever assembly to transmission by using bolts in bracket. Be sure that spacers are placed over bolts between bracket and sector. Install lock washers and nuts on bolts and tighten securely.

Section XXV

WHEELS, HUBS, AND WHEEL BEARINGS

	Paragraph
Description	136
Front hub and drum assembly	137
Rear hub and drum assembly	138
Front wheels	139
Rear wheels	140
Wheel bearings	141
Rear wheel grease retainer	142
Tire chains	143

136. DESCRIPTION.

a. **Wheels.** The wheels are of the demountable, steel-spoke type with six mounting stud holes. Wheel hub and drum assemblies are carried on opposed tapered roller bearings. Front wheels are retained by six taper stud nuts, and rear inner and outer duals are held on hubs by separate inner and outer taper stud nuts. Inner wheel is held in place by a special lock nut threaded to the wheel studs. Outer wheel is held in place by a special lock nut threaded on the inner lock nut. Spare wheel and tire carrier assembly is mounted behind the cab. Jam nut and padlock hold spare wheel securely in carrier.

b. **Hubs and Drums.** Hubs are heavy steel forging assembled integrally with their respective brake drums. Each hub carries six wheel mounting studs and is fitted with inner and outer taper bearing cups and conventional grease seal at inner band. Brake drums have opening with a snap cover for inspecting and adjusting brakes.

137. FRONT HUB AND DRUM ASSEMBLY.

a. **Front Hub and Drum Removal.** Jack up front of vehicle and remove road wheel by taking off six mounting nuts. Take out four screws holding wheel bearing dust cover and remove cover. Remove cotter pin from wheel bearing adjusting nut, and remove nut and washer. Remove hub and drum assembly from spindle, pulling outer bearings at the same time.

b. **Front Hub and Drum Installation.** Position two steel washers and felt grease retainer on wheel spindle and place inner bearing cone, well-packed with grease, on spindle. Place hub and drum assembly on wheel spindle and push all the way on. Place outer bearing cone, well-packed with grease, on spindle and press in position. Install washer and adjusting nut for wheel bearing. Position road wheel on mounting studs. Attach six mounting nuts and tighten securely. Lower vehicle to road and remove jack. Adjust wheel bearing (par. 141).

2½-TON 4 x 2' TRUCK (FEDERAL)

138. REAR HUB AND DRUM ASSEMBLY.

- a. Remove Rear Axle Shaft (par. 116).
- b. Remove Rear Wheels (par. 140).
- c. Remove Hub and Drum. Wipe grease from axle housing end with a clean rag. Remove jam nut, lock ring, and bearing adjusting nut (fig. 100). Remove hub and drum assembly, pulling outer bearing at the same time. If necessary, tap outer end of axle housing to loosen

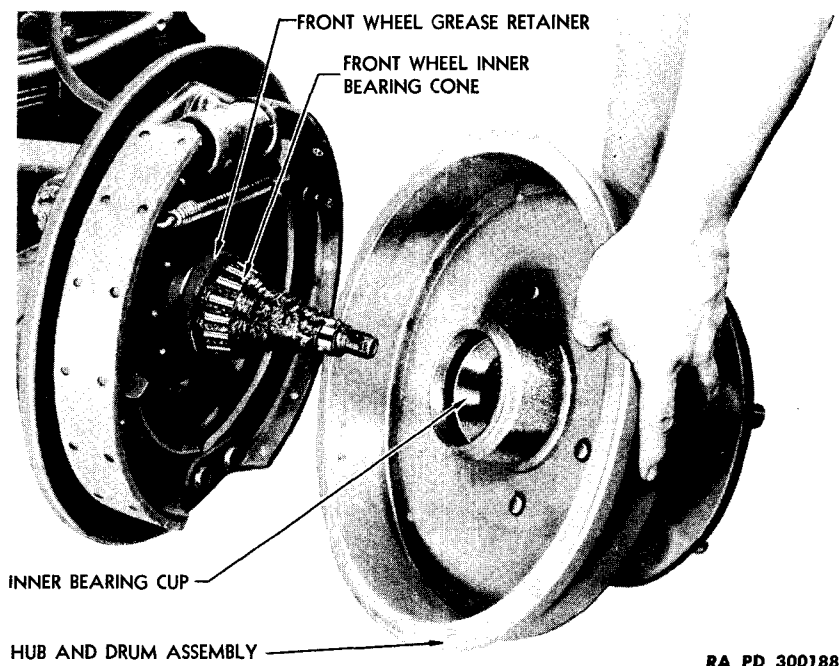

Figure 98—Removing Front Hub and Drum Assembly

WHEELS, HUBS, AND WHEEL BEARINGS

outer bearing cone. Remove inner bearing cone assembly from axle housing.

d. **Hub and Drum Installation.** Install inner bearing by placing inner bearing cone and roller assembly, well-packed with grease, on axle housing and press into position. Place hub and drum assembly

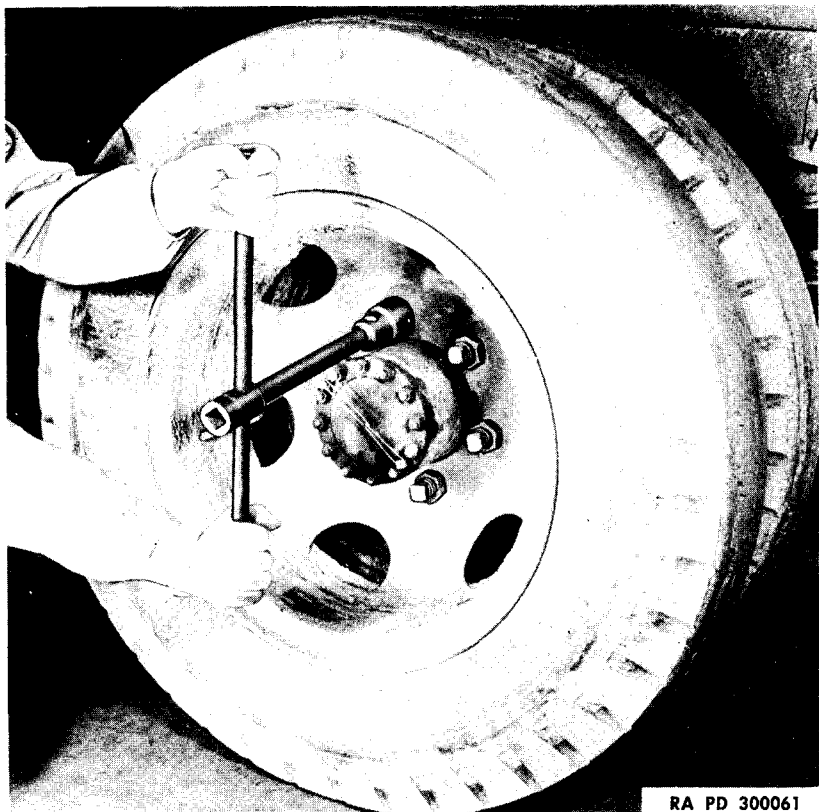

Figure 99—Removing Rear Wheel

in position on axle housing and push all the way on. Place outer bearing cone and roller assembly, well-packed with grease, on axle housing and press into position. Install bearing adjusting nut, drawing up snugly while rotating drum and hub assembly to slot bearings. Install lock ring and momentarily tighten jam nut. Install rear wheels (par. 140). Make sure that brakes are not dragging on drum (par. 121) before proceeding with final bearing adjustment (par. 141). Install axle shaft.

2½-TON 4 x 2 TRUCK (FEDERAL)

139. FRONT WHEELS.

a. **Wheel and Tire Removal.** Loosen six wheel stud nuts about ½ turn each (fig. 99). Jack up wheel to clear ground. Completely remove six wheel stud nuts and lift wheel from truck.

b. **Wheel and Tire Installation.** Place wheel and tire assembly over studs. Place stud nuts in position and draw up snug. Successively

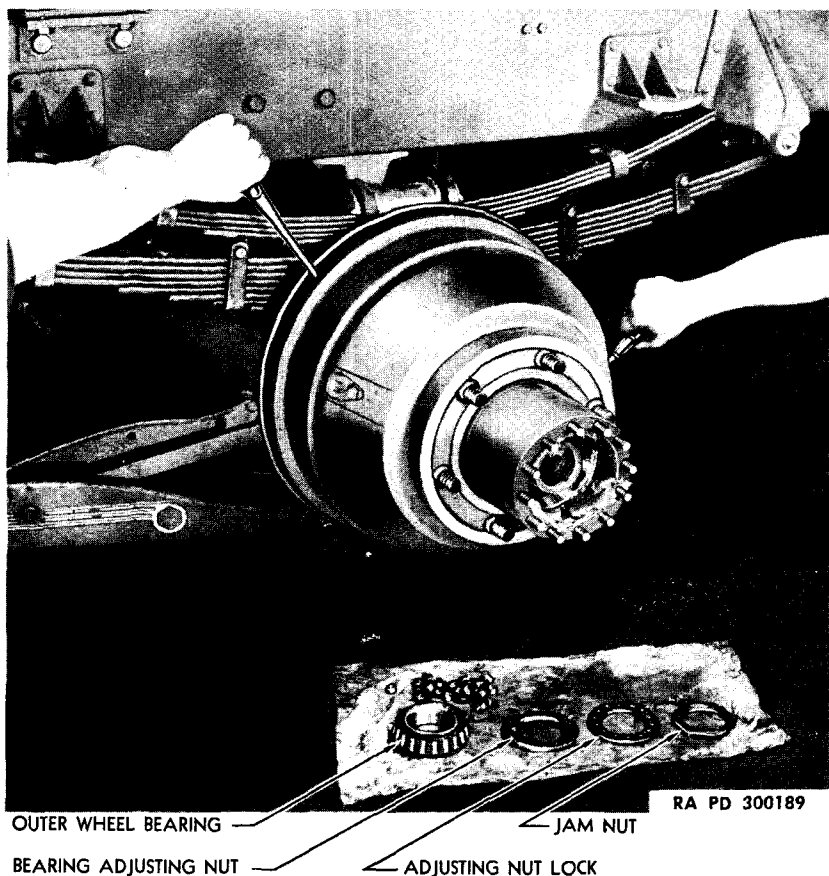

Figure 100—Removing Rear Hub and Drum Assembly

tighten opposite stud nuts to prevent cocking wheel. Remove jack.
NOTE: When wheel and tire assembly has been installed, always check tightness of nuts after 500 miles of operation.

140. REAR WHEELS.

a. **Wheel and Tire Removal.** Partially loosen each of six outer and six inner stud nuts (fig. 99). Jack up axle until wheels clear

WHEELS, HUBS, AND WHEEL BEARINGS

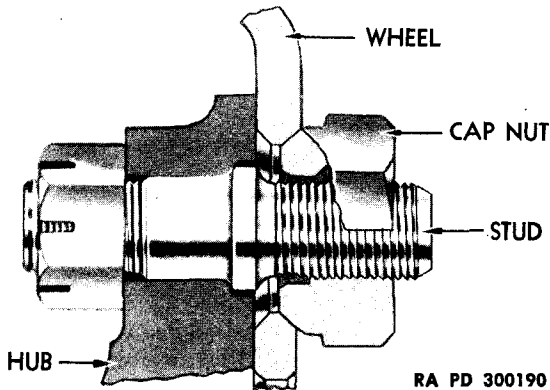

Figure 101—Single Cap Nut Installed

ground. Finish outer stud nut removal and lift off outer wheel. Complete inner stud nut removal and lift off inner wheel.

b. **Wheel and Tire Installation.** With truck in jacked-up position, place inner wheel and tire assembly over studs. Place inner wheel stud nuts in position and draw up snug. Place outer wheel in position over inner wheel nut, being careful to locate valve stem diametrically opposite inner wheel valve stem. Place outer wheel stud nuts in position and draw up snug.

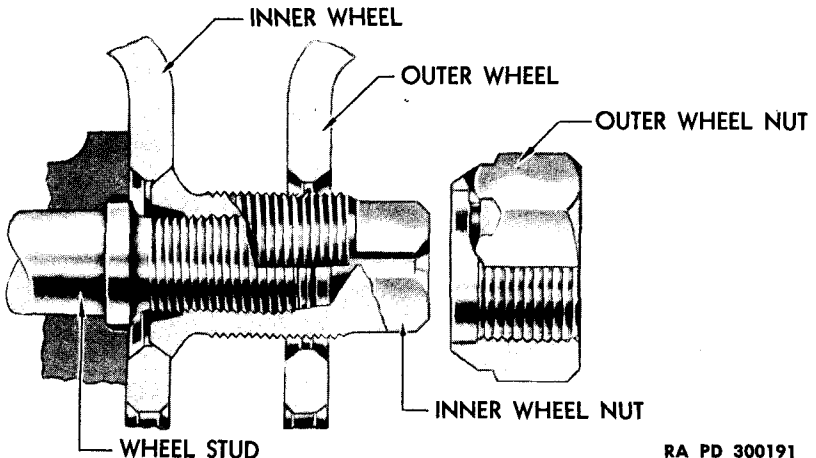

Figure 102—Double Cap Nut (Duals) in Process of Assembly

2½-TON 4 x 2 TRUCK (FEDERAL)**141. WHEEL BEARINGS.****a. Front Wheel Bearing Adjustment.**

(1) Jack up axle until wheel is free to turn. Make certain brakes are not dragging before proceeding. Remove four screws holding bearing dust cover and remove dust cover.

(2) Remove cotter pin from bearing adjusting nut. Gradually tighten bearing adjusting nut to set bearings, meanwhile turning

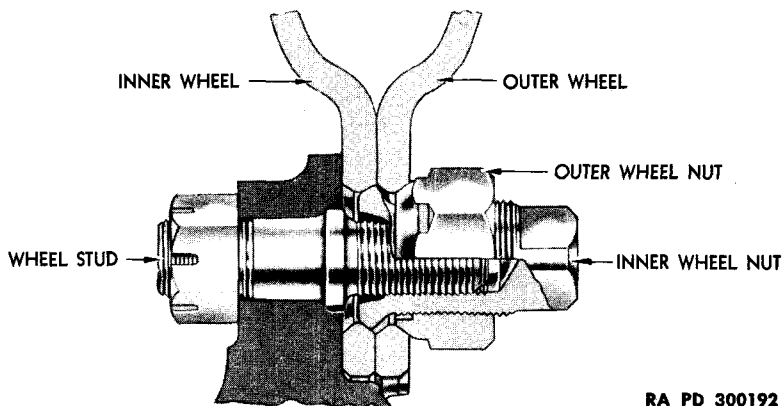

Figure 103—Double Cap Nut (Duals) Assembled

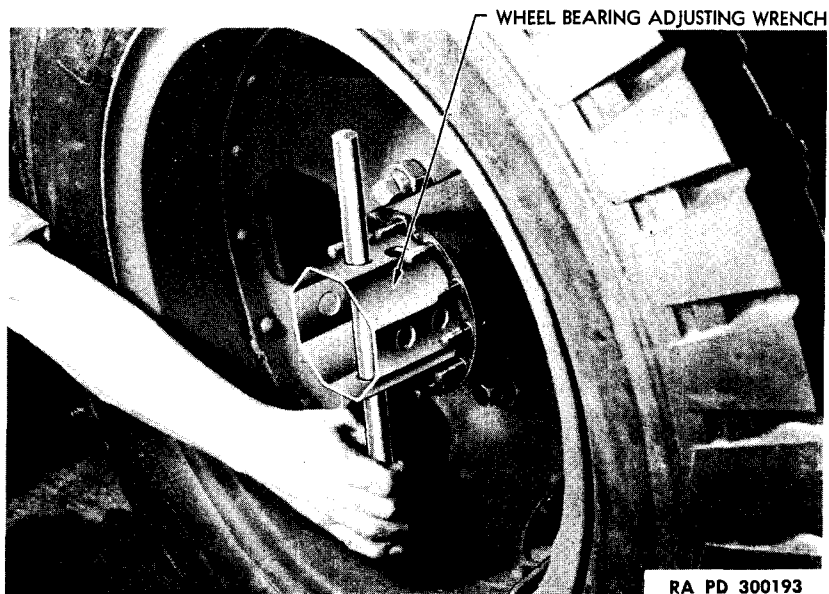

Figure 104—Adjusting Rear Wheel Bearing

WHEELS, HUBS, AND WHEEL BEARINGS

wheel by hand first in one direction, and then the opposite. Turn bearing adjusting nut until wheel offers appreciable resistance to rotation by hand, then back off the adjusting nut to nearest cotter pin hole and insert cotter pin.

(3) Wheel should turn freely without bind or drag. Test for looseness in bearing by lifting with a pinch bar between the wheel and ground, while a finger is placed between the cone and cup of the bearing. Readjust if excessive looseness is evident. Install dust cover, securing with four cap screws and lock washers. Lower axle and remove jack.

b. Rear Wheel Bearing Adjustment.

(1) Jack up axle until wheel is free to turn. Remove axle shaft (par. 116). Make certain that brakes are not dragging before proceeding. Remove jam nut and lock plate.

(2) Draw the adjusting nut up tightly against the outer cone assembly, meanwhile rotating wheel assembly first in one direction and then in the opposite, until the bearings bind and the wheel turns hard. Rotating the wheel in both directions causes rollers to become fully and evenly seated. Back off the adjusting nut until the wheel turns freely without perceptible end play. It may be necessary to tap the end of the rear axle housing while loosening the adjusting nut, in order to release the cone on the tube end.

(3) Test end play by placing the end of a pinch bar between the bottom of the tire and the ground, lifting up while holding the finger on the cage of the outer bearing. Readjust if excessive looseness is evident. With adjustment satisfactory, place lockplate in position, backing off adjusting nut to nearest dowel hole, and lock with jam nut. Install axle shaft (par. 117). Lower axle and remove jack.

c. **Front Wheel Bearing Removal.** Remove hub and drum assembly (par. 137). Remove inner bearing cone and roller assembly from spindle. With soft drift, drive bearing cups out of hub.

d. Front Wheel Bearing Installation.

(1) Have wheel hub thoroughly cleaned. Drive inner and outer bearing cup into position in hub, then position two steel washers and felt grease retainer on wheel spindle. Install inner bearing cone and roller assembly well-packed with grease, and press into position on spindle.

(2) Install hub and drum assembly (par. 138). Install wheel (par. 139), and adjust wheel bearing (par. 141).

e. **Rear Wheel Bearing Removal.** Remove hub and drum assembly (par. 138). Remove inner bearing cone and roller assembly. With soft drift, drive grease seal assembly and inner and outer bearing cups from hub.

2½-TON 4 x 2 TRUCK (FEDERAL)

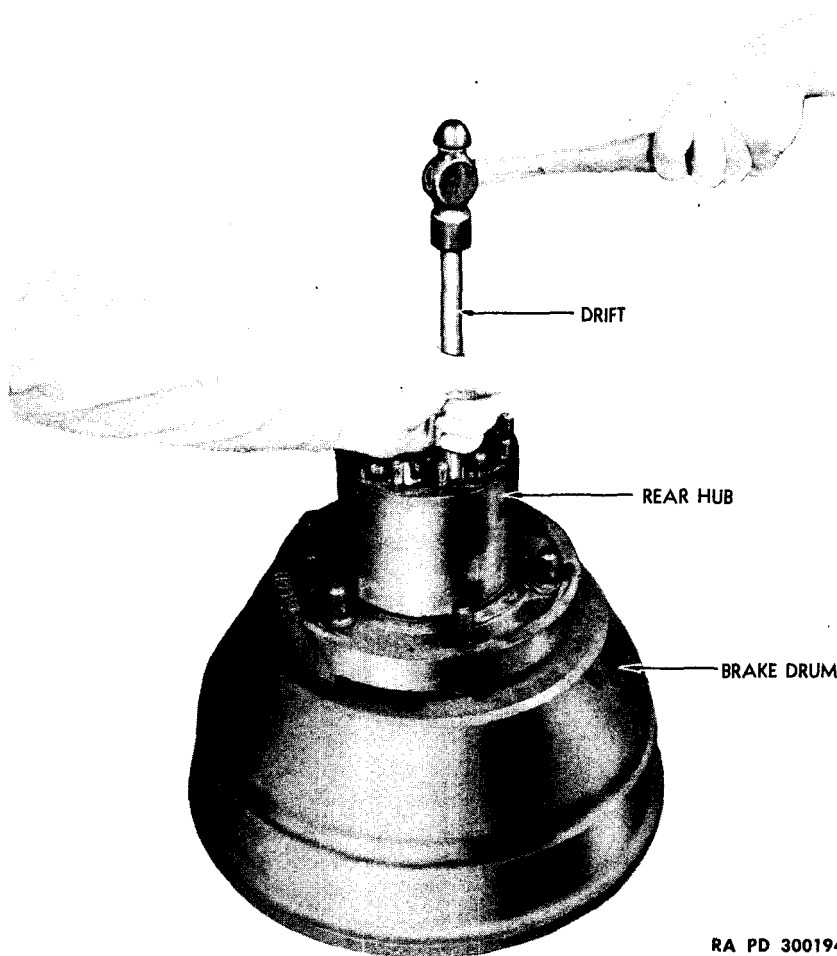

RA PD 300194

Figure 105—Removing Rear Wheel Grease Retainer

f. Rear Wheel Bearing Installation.

(1) With hub thoroughly cleaned, place inner and outer bearing cups in position, and press into place. Place grease seal in position and press in place. Place inner bearing cone and roller assembly, well-packed with grease, on axle housing and press into position.

(2) Install hub and drum assembly (par. 138). Make sure that brakes are not dragging on drum before adjusting bearings (par. 121). Install axle shaft (par. 117). Install wheel and tire assembly (par. 140).

WHEELS, HUBS, AND WHEEL BEARINGS

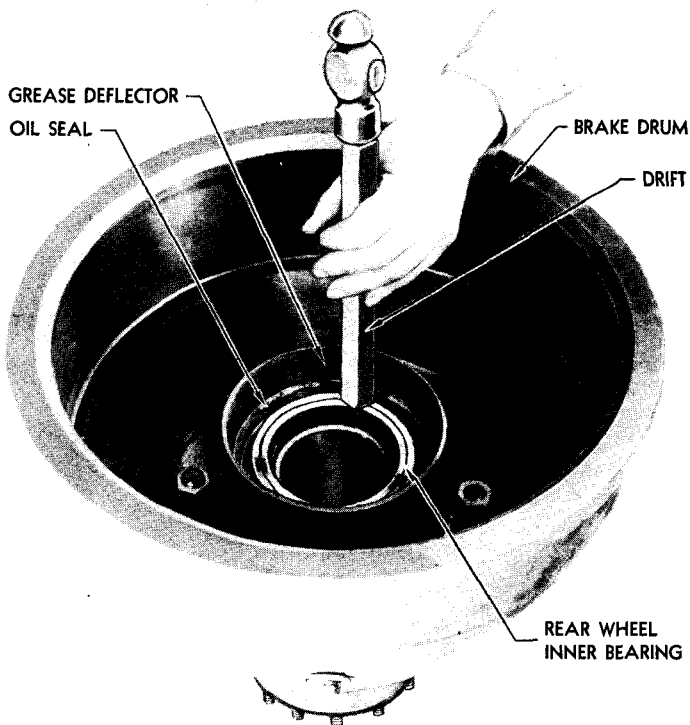

RA PD 300195

Figure 106—Installing Rear Wheel Grease Retainer

142. REAR WHEEL GREASE RETAINER.

a. **Rear Wheel Grease Retainer Removal.** Remove rear hub and drum assembly (par. 138). Using soft drift, drive grease retainer assembly out of hub (fig. 105). Inspect grease retainer contact surface of the axle housing for roughness, and if not in clean, smooth condition, report to higher authority.

b. **Rear Wheel Grease Retainer Installation.** Soak new grease retainer assembly in engine lubricating oil until it is thoroughly saturated, place in position over end of hub, and drive into position,

2½-TON 4 x 2 TRUCK (FEDERAL)

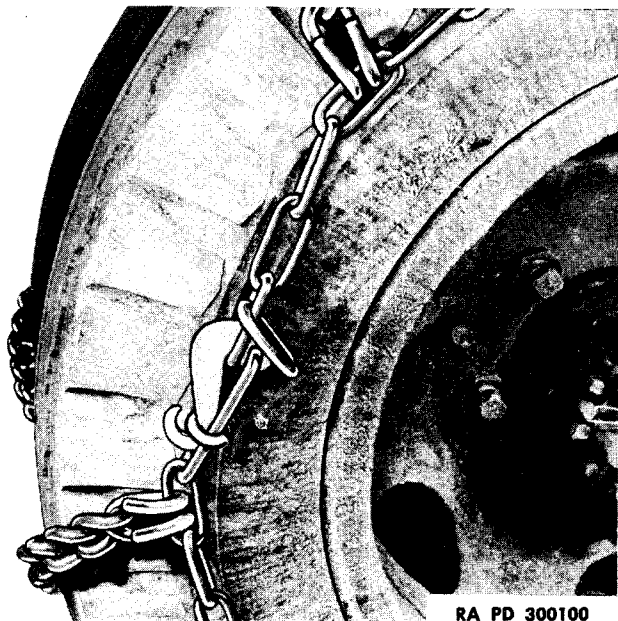

RA PD 300100

Figure 107—Tire Chain Clamp

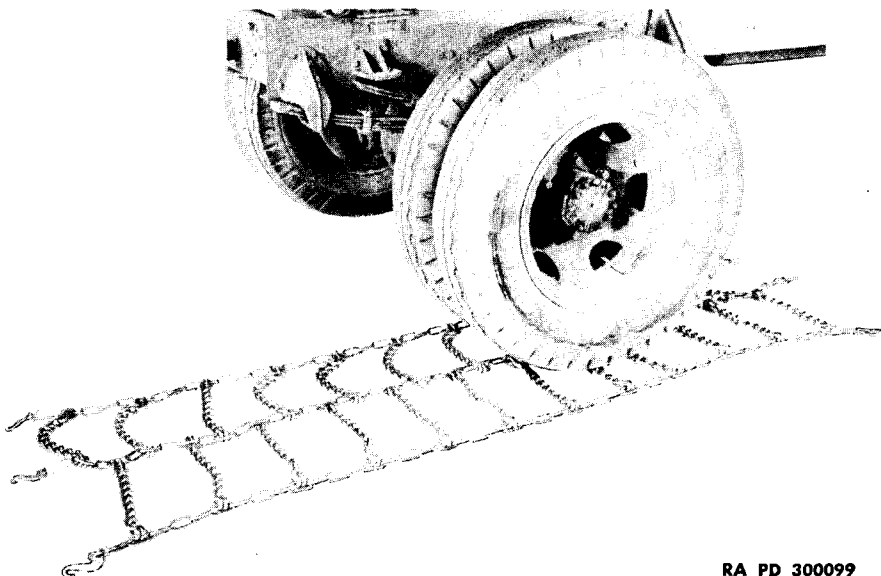

RA PD 300099

Figure 108—Installing Tire Chain

WHEELS, HUBS, AND WHEEL BEARINGS

taking care not to distort retainer assembly. When lifting hub into position, use caution not to damage grease retainer assembly. Install rear hub and drum assembly (par. 138).

143. TIRE CHAINS.

a. **Usage.** When operation over slippery or icy surfaces requires better traction, use tire chains. Do not operate with chains unless necessary. Avoid running chains on dry roadway.

b. **Tire Chain Removal.** Unfasten each clamping hook by sliding the slotted locking ring to uppermost position, and release each hook in turn (fig. 107). Lay chains flat on the ground. Drive truck off chains. Clean and place chains in bags. Report any lost or broken links to higher authority.

c. **Tire Chain Installation.** Remove chain from bag and lay inside of chain face up on ground directly behind rear wheel. Back the truck over the chain until approximately $\frac{2}{3}$ of the chain has been traveled on (fig. 108). Fasten each of the three links in turn, removing all slack from chain. Slide slotted locking ring into position over clamping hook (fig. 107).

SPRINGS AND SHOCK ABSORBERS

b. Tabulated Data.

Front springs—length	40 in. at 3¾ in. loaded height
Front springs—width	2 in.
Front springs—number of leaves.....	9
Rear springs—length	50 in. at 5⅞ in. loaded height
Rear springs—width	3 in.
Rear springs—number of leaves	10
Rear auxiliary springs—length..	40¾ in. under 1100 lb load
Rear auxiliary springs—width	3 in.
Rear auxiliary springs—number of leaves.....	5
Shock absorbers—type	Hydraulic

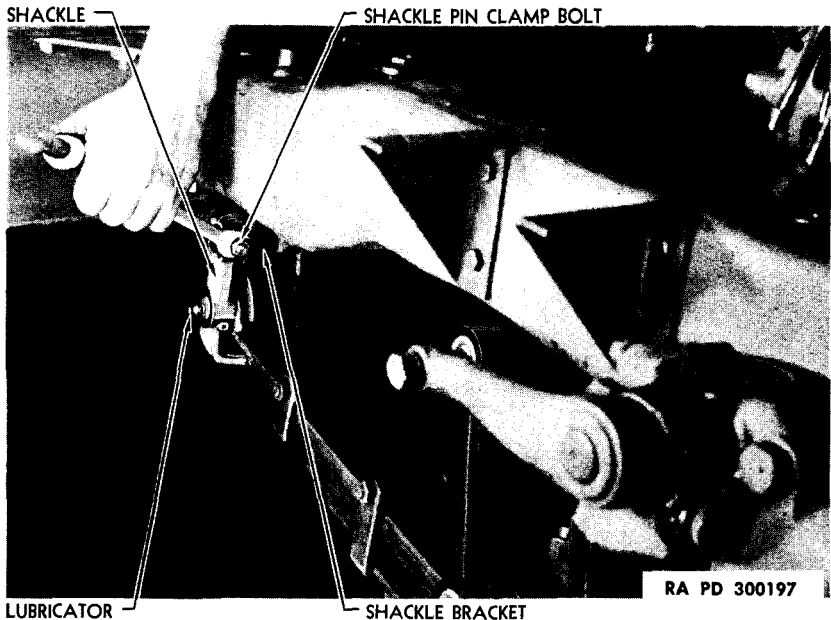

Figure 110—Removing Shackle Pin Clamp Bolt

145. SHACKLE AND PIN REMOVAL.

a. Place jack under truck and raise frame high enough to relieve weight on springs. Remove lock bolt nut, lock washer, and lock bolt (fig. 110). With hammer and soft drift, drive pins out, freeing shackles and springs.

146. SHACKLE AND PIN INSTALLATION.

a. Place jack under truck and lift frame to height where springs are in a position in line with anchor pin holes. Line up spring pin holes with shackle holes. **CAUTION:** Before driving, note position of lock

2½-TON 4 x 2 TRUCK (FEDERAL)

bolt groove in end of pin in relation to locking bolt hole in anchor bracket or shackle. Alinement of these holes must be perfect, or lock bolts cannot be installed. Drive anchor pins into position using hammer and soft drift.

147. SPRING ASSEMBLY REMOVAL.

- a. Remove spring U-bolts (par. 114); remove spring shackles and pins (par. 145); and remove spring assembly.

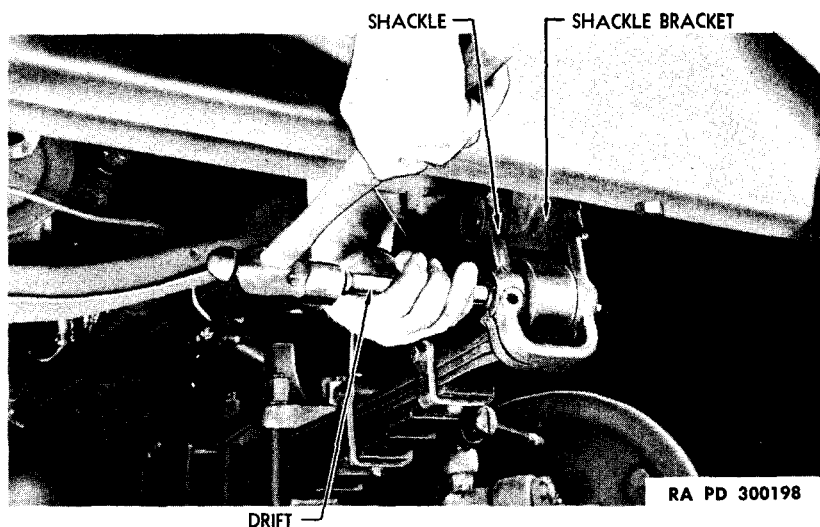

Figure 111—Removing Front Spring Shackle Pin

148. SPRING ASSEMBLY INSTALLATION.

- a. Lift spring into position to line up shackles and anchor pin holes. With spring in position, install shackles and anchor pins (par. 146). Install spring U-bolts (par. 115).

149. SHOCK ABSORBER REMOVAL.

- a. Disconnect shock absorber linkage at arm. Remove shock absorber to frame bolts. Lift off shock absorber.

SPRINGS AND SHOCK ABSORBERS

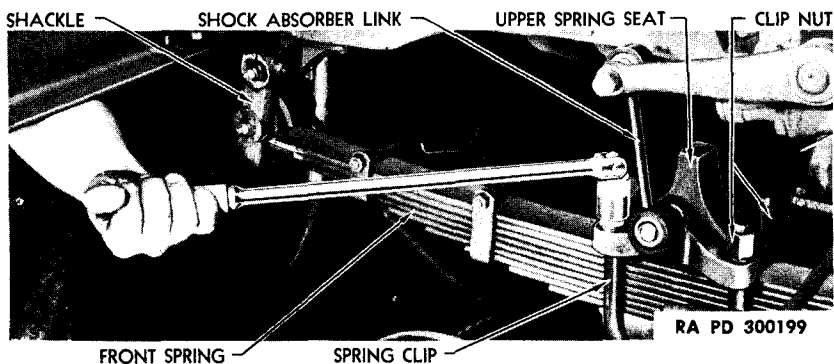

Figure 112—Installing Front Spring Assembly

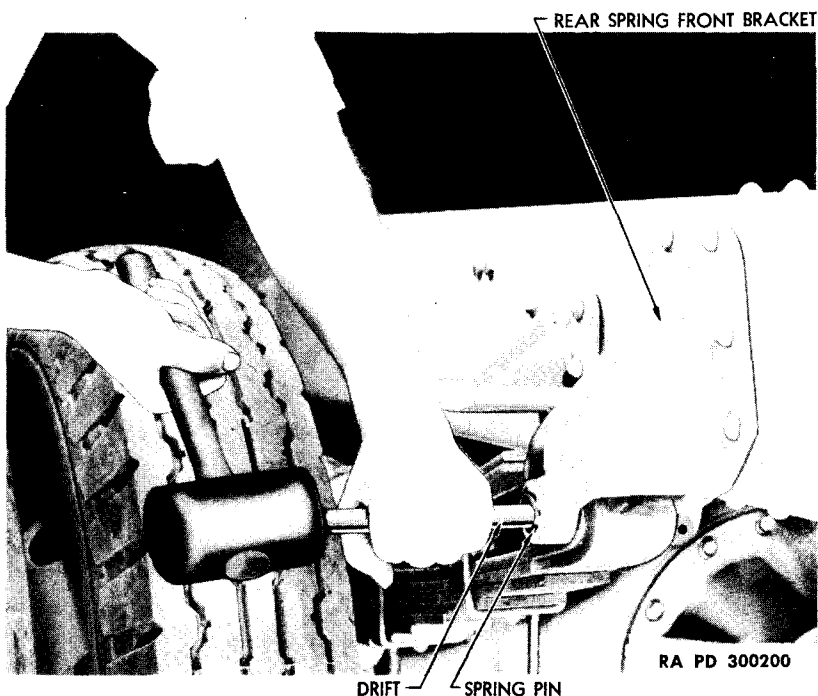

Figure 113—Installing Rear Spring Pin

150. SHOCK ABSORBER INSTALLATION.

- a. Mount shock absorber on frame, tightening bolts securely. Connect linkage to shock absorber arm.

151. SHOCK ABSORBER LINKAGE REMOVAL.

- a. Remove upper link anchor pin lock nut, and drive pin out of

2½-TON 4 x 2 TRUCK (FEDERAL)

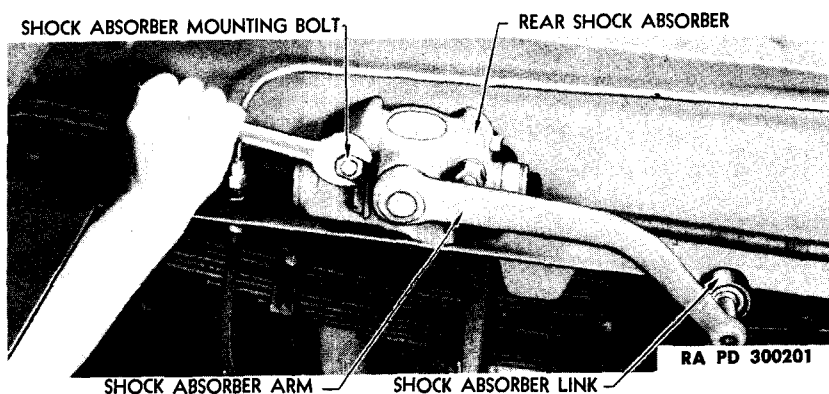

Figure 114—Installing Rear Shock Absorber

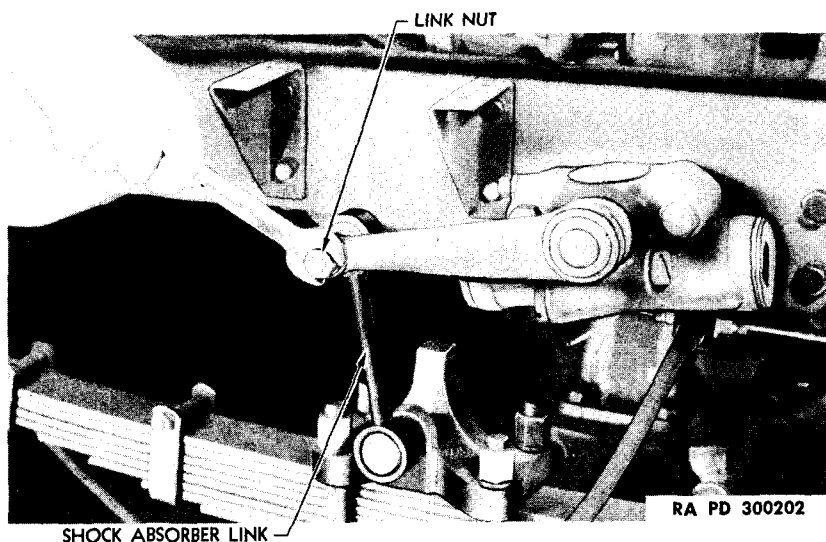

Figure 115—Installing Front Shock Absorber Linkage

shock absorber arm, using soft hammer. Remove lower link anchor pin nut, and drive lower pin out of anchor bracket.

152. SHOCK ABSORBER LINKAGE INSTALLATION.

- a. Drive lower link anchor pin into position in anchor bracket, and secure with lock washer and nut. Drive upper link pin into position in shock absorber arm. Secure with lock washer and nut.

SPRINGS AND SHOCK ABSORBERS

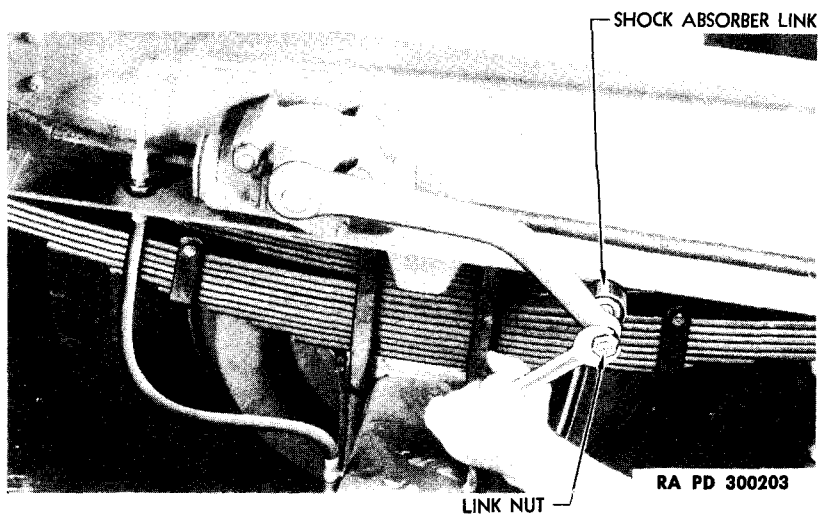

Figure 116—Removing Rear Shock Absorber Linkage

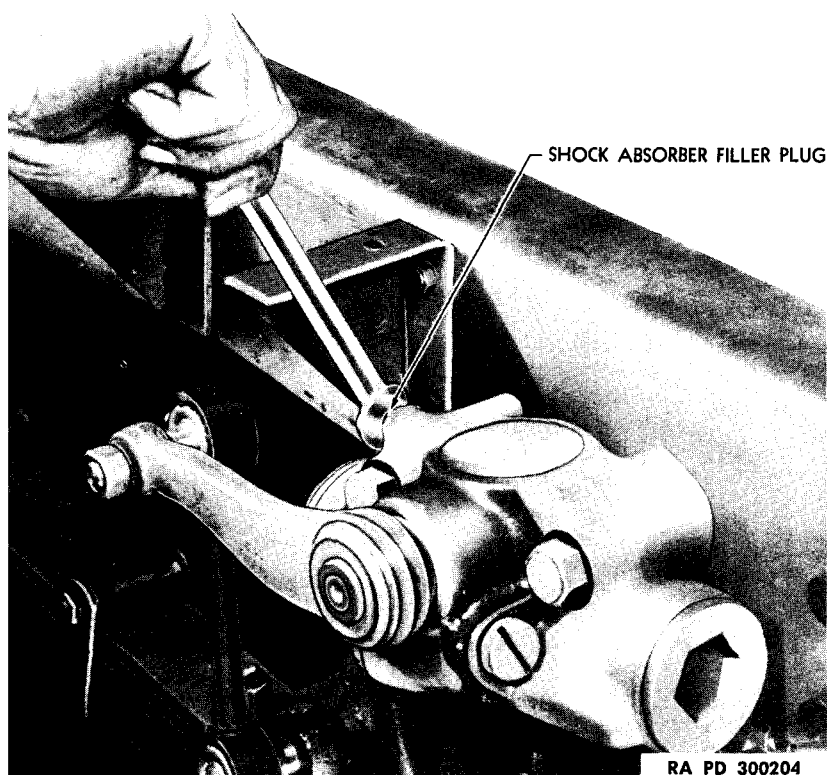

Figure 117—Shock Absorber Filler Plug

2½-TON 4 x 2 TRUCK (FEDERAL)

Section XXVII

STEERING GEAR

	Paragraph
Description and tabulated data	153
Drag link adjustment	154
Drag link removal	155
Drag link installation	156
Pitman arm removal	157
Pitman arm installation	158
Steering gear assembly removal	159
Steering gear assembly installation	160

153. DESCRIPTION AND TABULATED DATA.

a. **Description.** The steering system consists of the steering wheel and gear, pitman arm, and drag link. The steering gear is of the single-cam-and-lever type, and is mounted on left-hand frame side rail. The operation of the steering gear converts rotary motion, applied at steering wheel, to back-and-forth movement of pitman arm and drag link for directional control of front wheels. The steering gear pitman arm is connected to the front axle by means of a single tubular-type drag link.

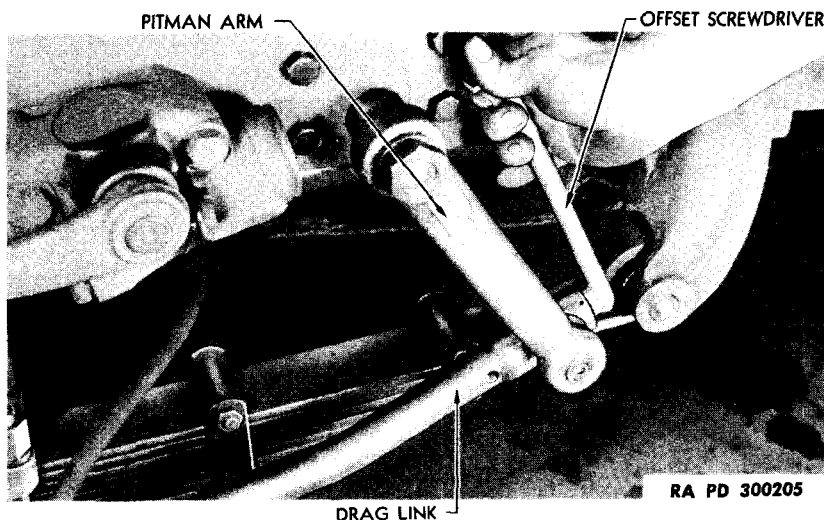

RA PD 300205

Figure 118—Adjusting Steering Drag Link

STEERING GEAR

b. Tabulated Data.

Type	Cam and lever
Model	Ross
Ratio	22-18-22

154. DRAG LINK ADJUSTMENT.

a. **Description.** Drag link is equipped with spring-loaded, split-type ball socket bearing seats. Springs maintain uniform tension of socket bearing seats on ball studs and also automatically compensate to some extent for wear on bearings. Manual adjustment of drag link ends is necessary whenever drag link has been disconnected, or when looseness develops as the result of wear on bearing seats.

b. **Adjustment Procedure.** Remove cotter pin. Screw adjusting plug into drag link with offset screwdriver (fig. 118). Turn plug inward until it is tight against ball. Be sure bearing seats are well lubricated. Back off adjusting plug $\frac{1}{2}$ to 1 turn and test action of ball in bearing seat by moving drag link by hand. Drag link adjustment must be tight enough to prevent end play, and yet loose enough to allow free movement. Insert new cotter pin to lock adjustment.

155. DRAG LINK REMOVAL.

a. Remove cotter pin and use offset screwdriver to loosen adjusting plug. Unscrew adjusting plug far enough to allow drag link to be withdrawn from ball stud. Perform this operation at pitman arm end, and at steering arm end of drag link.

156. DRAG LINK INSTALLATION.

a. **Drag Link Lubrication.** Drag link bearing seats must be thoroughly lubricated before installation of drag link.

b. **Drag Link Installation.** Place drag link in position on pitman arm and steering arm ball studs. Tighten adjusting screws and adjust bearing seat spring tension (par. 154 b).

157. PITMAN ARM REMOVAL.

a. **Drag Link Removal.** Remove cotter pin from pitman arm end of drag link, and unscrew plug far enough to withdraw bolt stud from drag link.

b. **Pitman Arm Removal.** Remove pitman arm nut. Carefully mark exact relation of pitman arm and lever shaft. This is necessary, unless pitman arm is being removed for the purpose of readjusting its position. Pry or pull pitman arm from shaft with a suitable puller.

158. PITMAN ARM INSTALLATION.

a. **Pitman Arm Installation.** If pitman arm position is being readjusted or a new pitman arm installed, check position of pitman

2½-TON 4 x 2 TRUCK (FEDERAL)

arm on lever shaft. With gear in center of travel, and wheels in straight-ahead position, pitman arm must be assembled on lever shaft so that drag link can be easily connected without changing position of either the steering gear or front wheels. Install and tighten pitman arm nut.

b. **Install Drag Link.** Install drag link on pitman arm ball stud and tighten adjusting screw to provide proper adjustment.

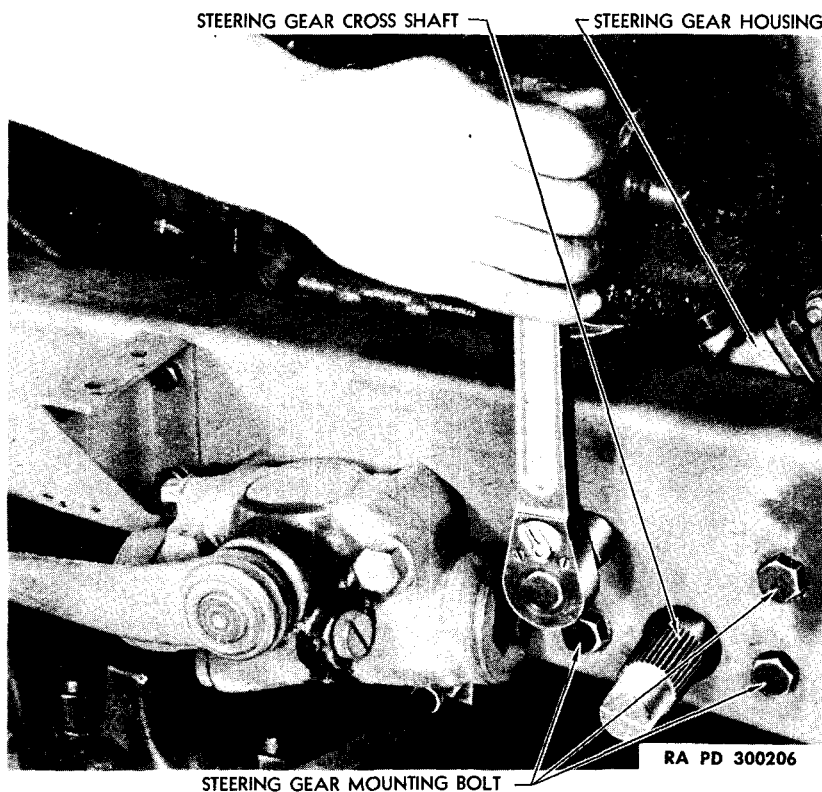

Figure 119—Removing Steering Gear Housing

159. STEERING GEAR ASSEMBLY REMOVAL.

a. **Remove Steering Wheel.** Remove horn button assembly and nut from end of steering shaft. Use a suitable puller to pull steering wheel from shaft.

b. **Remove Support Bracket Bolts.** Disconnect steering column support from instrument panel. Loosen and remove clamp screw at steering column support.

c. **Remove Pitman Arm.** Remove cotter pin from pitman arm end of drag link. Use an offset screwdriver and loosen adjusting plug in end of drag link (fig. 118). Withdraw drag link from pitman arm

STEERING GEAR

ball stud. Remove pitman arm retaining nut from end of lever shaft. Pry or use a suitable puller to pull pitman arm from shaft. Punch-mark relative position of pitman arm and shaft to permit reinstallation in exactly correct position. Pull horn wire out of connection at lower end of steering gear. Disconnect steering gear at frame mounting by removing four bolts, nuts, and lock washers at left-hand frame side rail (fig. 119). Move steering gear toward engine to clear lever shaft from frame, and then lower steering gear carefully downward and out from beneath chassis.

160. STEERING GEAR ASSEMBLY INSTALLATION.

a. **Aline Steering Column.** Install steering gear from beneath chassis. Push steering column carefully through hole in floor board and through instrument panel support. Place steering gear lever shaft through hole in frame.

b. **Install Mounting Bolts.** Install four bolts, nuts, and lock washers at frame side rail but do not tighten. Mounting bolts must not be tightened until steering column is attached to instrument panel support.

c. **Install Support Bracket Bolts.** Attach steering column support. Connect steering column to support and tighten clamp bolts securely.

d. **Tighten Steering Gear Mounting Bolts.** After steering column is properly attached, tighten the four mounting bolt nuts at frame side rail. Install horn button wire. Install pitman arm in exactly the original position on lever shaft (par. 158).

e. **Install Steering Wheel.** Install steering wheel on column and secure with nut on upper end of steering shaft. Install horn button assembly.

2½-TON 4 x 2 TRUCK (FEDERAL)**Section XXVIII****BODY AND FRAME**

	Paragraph
Description	161
Running boards	162
Bumper	163
Fenders	164
Hood assembly	165
Tow hooks	166
Pintle hook assembly	167
Cushion seats	168
Windshield assembly	169
Windshield wiper assembly	170
Windshield wiper assembly repair	171
Dump body	172

161. DESCRIPTION.

a. **Frame.** The frame used on this vehicle is rolled-steel channel. The two side members are held together in one rigid box-type structure by heavy cross members, riveted in position, and reinforced with gusset plates. A spring-cushioned pintle hook is mounted in the center of the rear frame cross member and secured in place with a heavy nut. A spring latch with locking pin enables easy engagement and disengagement. A tow hook is bolted in place at each front corner of the frame. A deep-channel, one-piece bumper is bolted to front of frame and reinforced with a gusset at each side rail.

b. **Sheet Metal.** Radiator enclosure and engine compartment are made up of sheet metal panels bolted in position on the brush guard frame work, cowl assembly, and fender. Engine compartment top is enclosed with a conventional sheet metal hood, secured with spring latches on either side, and hinged to cowl at rear. Extension arm with latch arrangement holds hood in elevated position. Conventional fenders and running boards are mounted over front wheels and on each side of the truck. Sheet metal lower side panel, bolted to fenders and radiator side plates, shield each side of the engine under fender.

c. **Cab.** Cab is of all-steel construction assembled integrally with cowl. Cowl and cab are supported by a three-point mounting with two mounting bolts, one at each front corner of the cowl, and one at rear center of cab support member. Each mounting consists of a through bolt, rubber vibration pad, heavy tension spring and washer held by castellated nut with cotter pin lock. Dual windshield wipers are mounted above windshield and are vacuum-operated. Individually

BODY AND FRAME

controlled valve is provided on each wiper. In emergency, wipers may be operated by hand levers provided. Windshield is of the double V-type and each section can be individually adjusted and positioned with manually controlled sector arms and brackets. Three ventilators are provided at different locations on the cab, and furnish adjustable ventilation for all types of driving conditions. One is mounted on the center of the front of the cowl, and is controlled by hand lever beneath the instrument panel. One ventilator is mounted on each side of the lower cowl, and can be opened and shut from inside the cab with foot lever. Door window glasses are adjustable with convenient regulator arrangement. Cab seat is adjustable to four positions. Fire extinguisher mounting is provided. Cab rear window is shielded with protective screen. Removable floor boards provide access to operating control levers and mechanism beneath.

162. RUNNING BOARDS.

a. **Running Board Removal.** Remove five running board to cross brace nuts, lock washers, and bolts. Remove two running board to fender nuts, lock washers, and bolts. Remove six running board to skirt nuts, lock washers, and bolts and lift off running board.

b. **Running Board Installation.** Place running board in position and install six running board to skirt bolts, lock washers, and nuts, temporarily leaving loose to facilitate alinement of other holes. Install two running board to fender bolts, lock washers, and nuts. Install five running board to cross brace bolts, lock washers, and nuts. Go over all bolts and nuts for final, even tightening.

163. BUMPER.

a. **Bumper Removal.** Remove tow hooks (par. 166). Remove four upper bumper to gusset nuts, lock washers, and bolts. Remove two bumper lower bracket nuts, lock washers, and bolts and lift off bumper.

b. **Bumper Installation.** Place bumper in position and install two lower bracket to bumper bolts, lock washers, and nuts. Install four upper bumper to gusset bolts, lock washers, and nuts. Install tow hooks (par. 166).

164. FENDERS.

a. **Fender Removal.** Disconnect all lamp wiring harness at radiator side panel terminal block, withdrawing through side panel hole, freeing retaining clips under fender. Remove lamp retaining nuts and lock washers, and lift off headlight and driving light (right-hand side) or headlight, blackout light, blackout driving light (left-hand side), drawing wire and harness out through light mounting holes. Remove bolt underneath rear fender curvature. Remove three bolts

2½-TON 4 x 2 TRUCK (FEDERAL)

at side of cowl. Remove three bolts at front horizontal edge of fender at brush guard. Remove five fender to brush guard bolts along vertical front edge of sheet metal radiator side plate, laying angle fender brace aside. Lift entire fender and side panel assembly from truck.

b. Fender Installation. Install engine compartment lower side panel on fender. Install radiator core side panel on fender, leaving the three cap screws temporarily loose. Lift fender and panel assembly into position, and install one of the three mounting bolts at side of cowl, securing loosely with lock washer and nut. Line up front holes at brush guard, and install one of the three bolts at inner edge of brush guard next to radiator, securing loosely with lock washer and nut. Install bolt underneath rear fender curvature through fender support bracket. On right side, make sure vacuum check valve bracket is in position before installing nut and lock washer. Install five fender to brush guard bolts along vertical front edge sheet metal radiator side plate, making sure to install front angle fender brace under lower bolt. Swing angle brace up, and install upper anchor bolt at front outer fender edge, securing loosely with lock washer and nut. Install remaining fender to brush guard bolt, nut, and lock washer at front horizontal edge of fender. Install two remaining bolts, lock washers, and nuts at rear of fender. Go over entire group of bolts and cap screws, tightening securely and evenly. Install headlight and driving light (right-hand side) or headlight, blackout light, and blackout driving light (left-hand side). Thread light wiring and harness through mounting holes in fender, and secure lights in position with retaining lock washers and nuts. Clip loom and wiring in position under fender, thread wires and wiring harness through hole in radiator side panel, and connect to terminal block.

165. HOOD ASSEMBLY.

a. Hood Removal. Unlatch hood on either side. Raise hood and while helper holds it steady, disconnect hood brace bracket from dash by removing four bracket to dash screws. Lower hood, and unscrew hood hinge pins. Lift hood from truck.

b. Hood Installation. Place hood into position, lining up hinges. Install hinge pins, tightening securely. Raise hood and attach hood brace bracket to dash, using four screws and tightening securely. Raise and lower hood, checking alinement.

166. TOW HOOKS.

a. Tow Hook Removal. Remove three tow hook anchor nuts, lock washers, and bolts, and rear bolt spacer, and lift off tow hook.

b. Tow Hook Installation. Place tow hook in position with spacer lined up at rear bolt hole. Install three anchor bolts, lock washers, and nuts, tightening securely.

BODY AND FRAME

167. PINTLE HOOK ASSEMBLY.

a. **Pintle Assembly Removal.** Withdraw cotter pin and take off large castellated nut and spacer washer. Pull pintle hook assembly out toward rear of truck and lay aside. Remove 12 nuts, lock washers, and bolts holding front section of the rear cross member in place. Swing or drive cross member forward until spring and front and rear spring bushing drop out.

b. **Pintle Assembly Installation.** Place bushings in spring and hold spring and bushing assembly in position while driving front section of cross member back into place. Line up cross member to frame side rail bolt holes and install 12 bolts, lock washers, and nuts, tightening securely. Place pintle assembly in position, sliding through spring bushings. Install spacer washers and tighten large castellated anchor nut until pintle hook can be slightly rotated by hand. Install cotter pin, turning castellated nut, if necessary, to line up slots with hole.

168. CUSHION SEATS.

a. **Cushion Seat Removal.** Upper edge of cushion back is held by two hinge pin bolts. Remove bolt nuts and withdraw bolts, freeing top edge of cushion. Lift entire back and seat cushion assembly forward, unhooking rear cushion bracket at lower edge from seat cushion bracket. Lift seat and back cushions separately from cab.

b. **Cushion Seat Installation.** Place seat cushion on seat support in cab. Place cushion back in cab and hook up to rear edge of seat cushion. Slide entire cushion assembly backwards toward normal position, lining up hinge brackets at top of rear cushion. Install hinge bolts and nuts. Place cushion in desired position on adjustment dowel.

169. WINDSHIELD ASSEMBLY.

a. **Windshield Assembly Removal.** Remove windshield adjusting sector wing nuts and hold windshield in extreme open position. Remove three hinge to windshield frame screws. Lift off windshield glass assembly.

b. **Windshield Assembly Installation.** Hold windshield assembly in place, aline, and install hinge to windshield screws. With adjusting sector brackets in position, try windshield for freedom of adjustment and alinement with cab. Loosen hinge screws and adjust hinge to frame mounting, if necessary, to correct alinement. Install and tighten sector retaining wing nuts.

170. WINDSHIELD WIPER ASSEMBLY.

a. **Windshield Wiper Assembly Removal.** Remove windshield wiper arm retaining screw and pull off arm and blade assembly. From inside of cab, remove four sheet metal screws holding cab header trim

2½-TON 4 x 2 TRUCK (FEDERAL)

panel, and remove header panel. Loosen vacuum line clips and disconnect rubber-lined coupling at windshield wiper motor. Remove two motor support bracket attaching screws and withdraw motor and bracket assembly. Remove motor to bracket retaining nut and lock washer, and remove bracket.

b. **Windshield Wiper Assembly Installation.** Place bracket in position on windshield wiper motor, installing lock washer nut, and tighten securely. Place motor and bracket assembly in position, and install bracket to header bolts, lock washers, and nuts, tightening securely. Connect wiper line and secure with clips. Install header trim panel, securing with four sheet metal screws. Place upper arm and blade assembly into position, and secure with retaining screws.

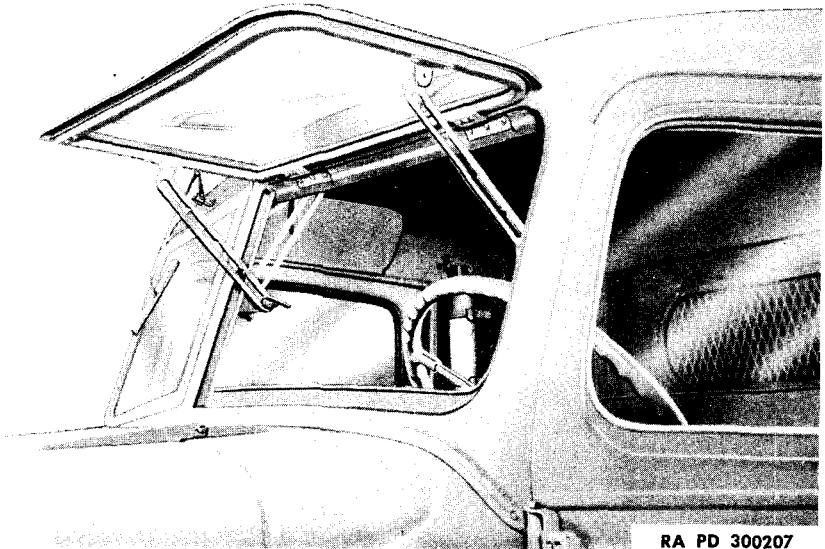

Figure 120—Windshield Mounting

171. WINDSHIELD WIPER ASSEMBLY REPAIR.

a. **Windshield Wiper Blade Removal.** Lift windshield wiper arm, swing blade outward, and unhook from end of arm.

b. **Windshield Wiper Blade Installation.** Lift windshield wiper arm outward, hook blade onto end, and swing downward into position.

c. **Windshield Wiper Arm Removal.** Remove windshield wiper arm retaining screw and pull arm free of shaft.

d. **Windshield Wiper Arm Installation.** Place windshield wiper arm in position and press onto shaft. Secure with retaining screws.

BODY AND FRAME

172. DUMP BODY.

a. **Dump Body Removal.** Due to the size and weight of the body, care must be used in removing, to prevent injury to personnel, or damage to the body. First raise body sufficiently to permit insertion of a 2 x 4 block between body and subframe toward the front, then lower body to rest on the blocking. Remove body hinge bracket rod or hinge pins, depending on body type, and with chain fall or other suitable lifting device, raise body clear of vehicle. With body raised sufficiently, remove the piston rod to body knuckle pin. Drive or pull vehicle forward until body will clear, then place suitable support under body, and lower to rest. Inspect body hinge brackets and replace if worn excessively, or showing evidence of fracture or breakage (Galion body only).

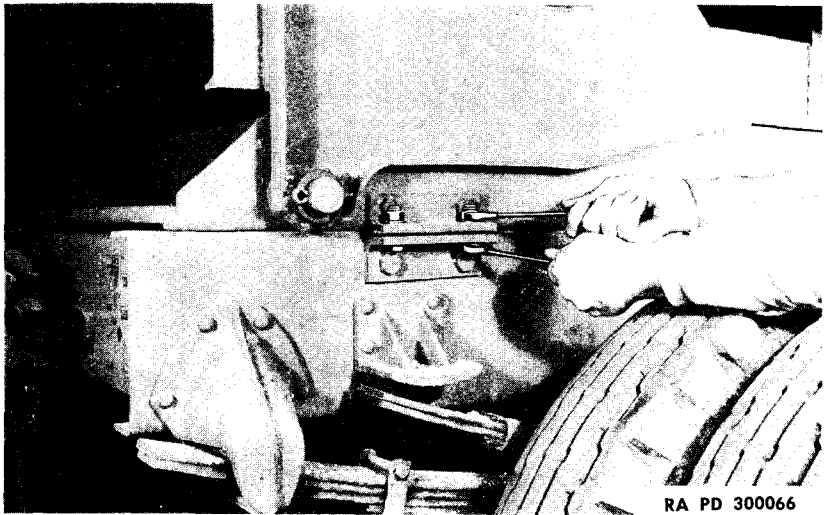

Figure 121—Tightening Body Bolts

b. **Dump Body Installation.** Raise body sufficiently to permit vehicle to be driven or pushed directly underneath. Raise body to sufficient height for piston rod yoke pin installation. Install pin and lock securely. Install body hinge bracket rod or pins and cotter pin in place. Lubricate hinge brackets and piston rod yoke pin (par. 20). Test body mounting by raising and lowering two or three times.

2½-TON 4 x 2 TRUCK (FEDERAL)

Section XXIX

HOIST

	Paragraph
Description	173
Body service	174
Controls and linkage	175
Hoist cylinder assembly	176
Hoist pump assembly	177
Drive shaft assembly	178

173. DESCRIPTION.

a. **Basic Body.** This vehicle is equipped with two types of all-steel welded dump bodies of 2-cubic-yard capacity each, mounted on an all-steel subframe assembly. These two body types are known as Anthony and Galion and are herein described in detail:

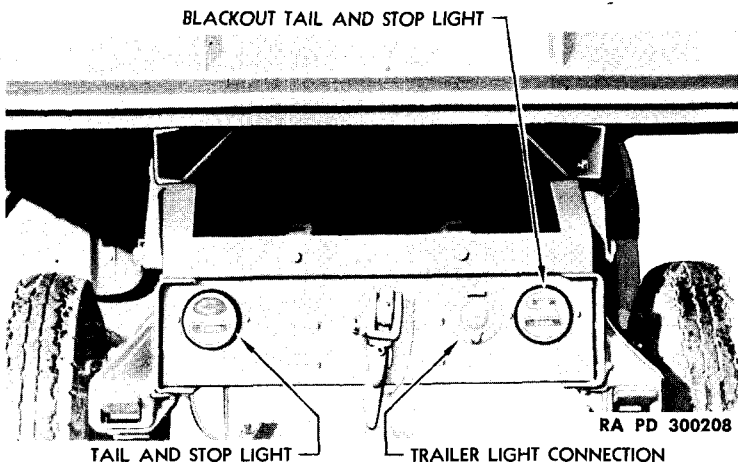

Figure 122—Galion Body Mounting

(1) Subframe mounting is all-steel welded, and is attached to vehicle by four steel plates.

(2) Galion body is attached to subframe by means of two heavy hinge brackets that bolt to body side and pivot on a cross bar fitted into the subframe (fig. 122).

(3) Anthony body is attached to subframe by means of two forged sections welded to the body frame. Pivot action is obtained by two large hinge pins fitted at the rear corners of the subframe (fig. 123).

HOIST

(4) Tail gate mounting is hinged at the top and is secured in closed position by means of two hooks which fit over lug studs on lower outside edges of the gate. Operation of tail gate is by a locking lever located on the left front corner of body. Hinge action can be changed from top to bottom of gate by removing the hinge pins, and leaving the hooks in closed position. Gate angularity can be adjusted as desired by the chains located at each end of the gate.

b. **Hoist.** The hoist consists of a cylindrical barrel fitted with a piston, piston rod, and gear-type oil pressure pump.

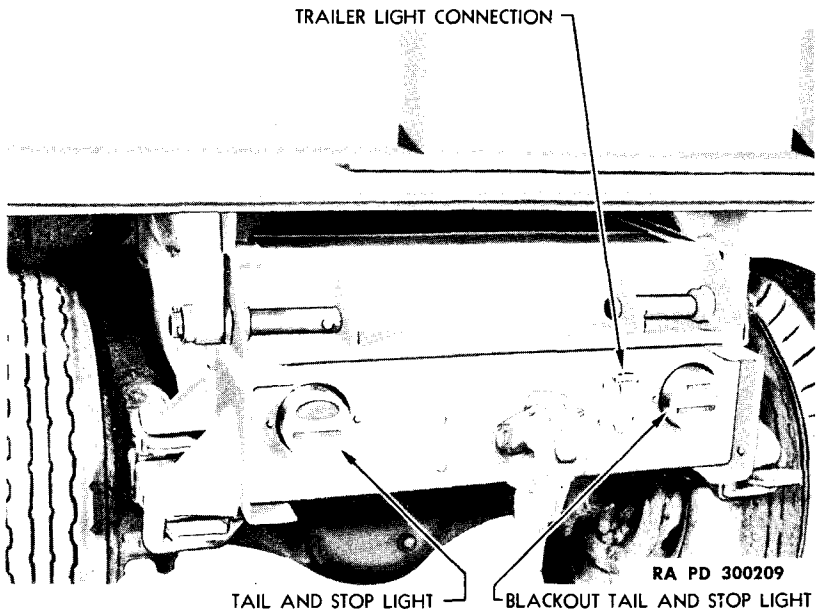

Figure 123—Anthony Body Mounting

(1) Galion hoist assembly is swivel-mounted on a cross bar fitted in the subframe, thus providing a pivot action for the hoist, allowing it to follow the body while raising or lowering. This maintains proper alinement of the piston rod.

(2) Anthony hoist assembly is swivel-mounted on a support bar that pivots on two studs which are bracket-mounted to the subframe, thus providing pivot action for the hoist, allowing it to follow the body while raising or lowering. This maintains proper alinement of piston rod.

(3) Power to drive pressure pump is obtained through power take-off on vehicle transmission, with controls located in cab.

2½-TON 4 x 2 TRUCK (FEDERAL)

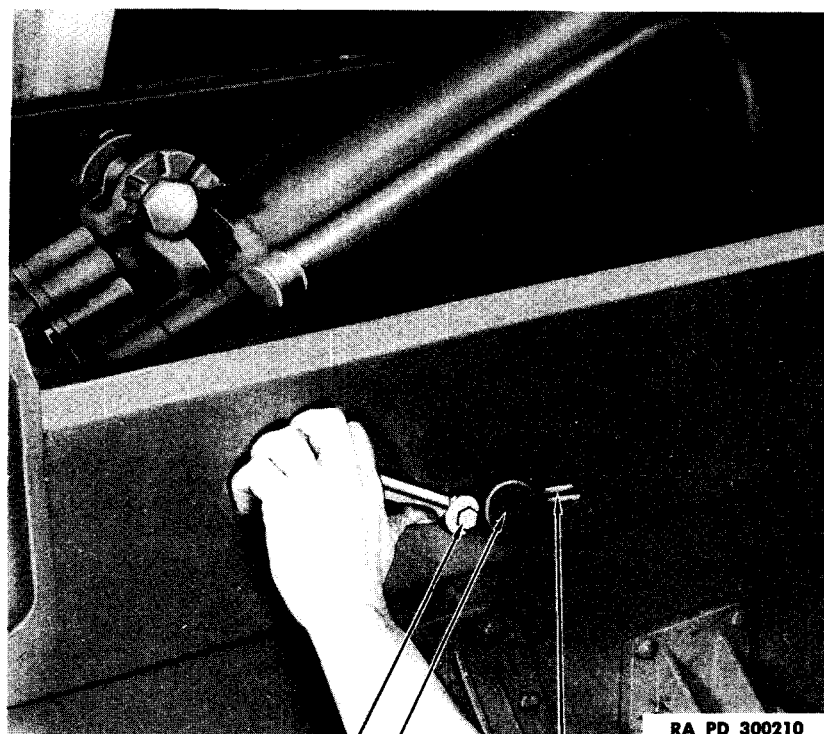

Figure 124—Galion Hoist Mounting

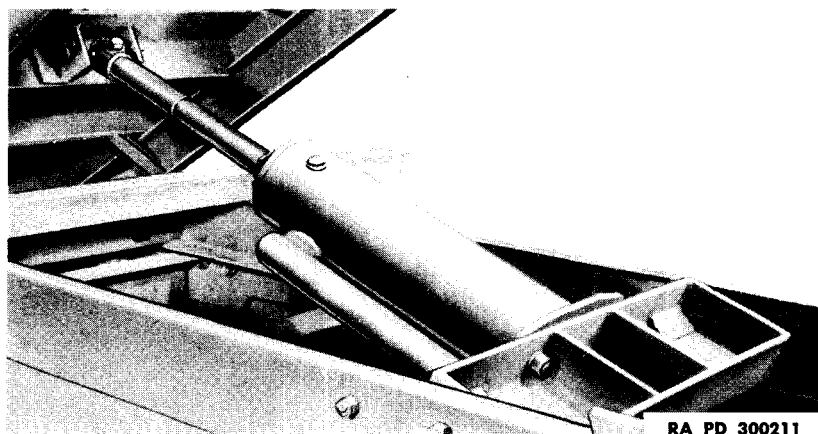

Figure 125—Anthony Hoist Mounting

HOIST

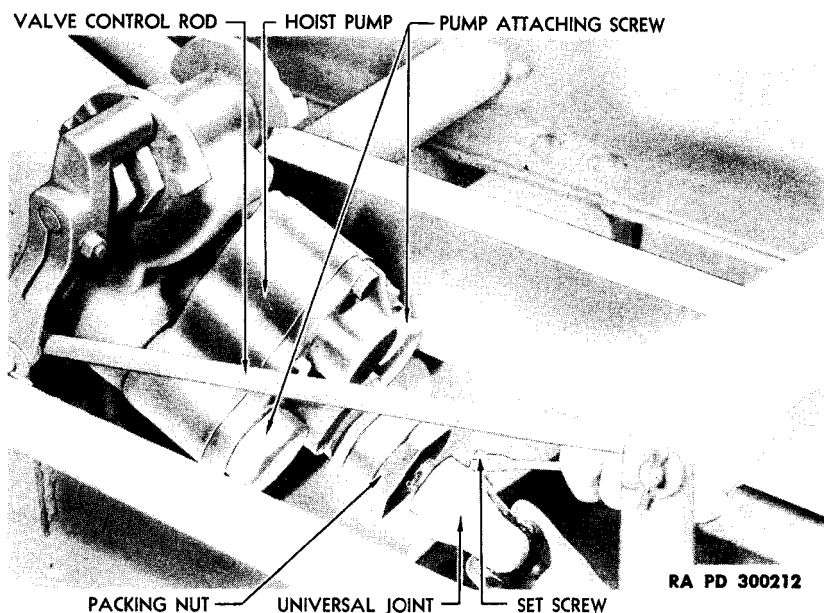

Figure 126—Galion Pump Mounting

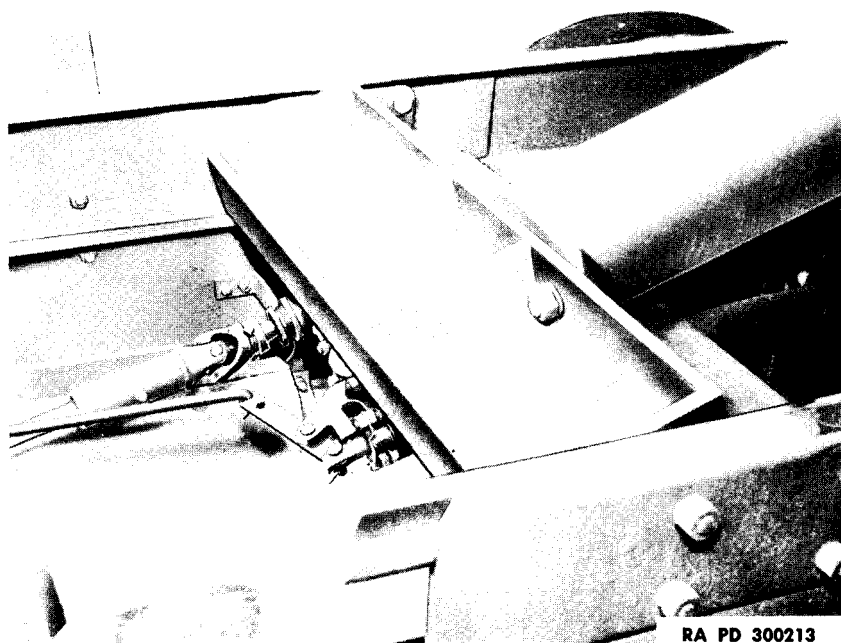

Figure 127—Anthony Pump Mounting

2½-TON 4 x 2 TRUCK (FEDERAL)

c. Pump.

(1) Galion pump assembly is attached to hoist cylinder by two large cap screws; one being a plain cap screw, and the other a ball check cap screw.

(2) Anthony pump assembly is attached to the cylinder by means of four studs and nuts.

(3) The drive shaft consists of two sections of shafts with three universal joints, and one shaft steady bearing. Two of the universal joints have fixed positions, while the third (located at pressure pump) is the sliding type, or slip joint.

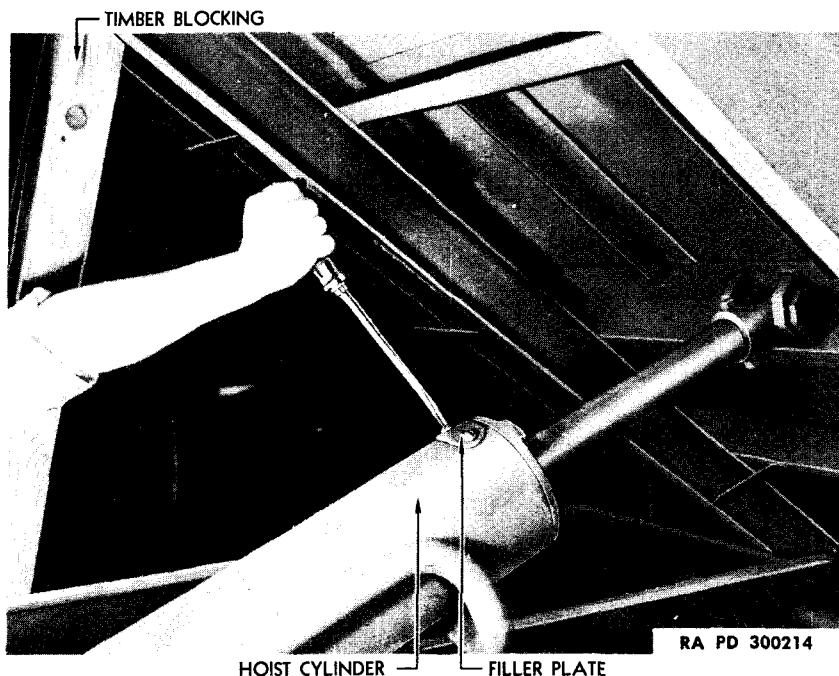

Figure 128—Timber Blocking

174. BODY SERVICE.

a. Before attempting to make any inspection or adjustment to the body or operating mechanism while body is raised, make sure the body is adequately supported by suitable blocking (fig. 128).

b. **Body and Subframe.** The body and subframe being of all-steel welded construction, require very little maintenance other than periodic tightening and lubrication at certain points (par. 20):

(1) Tighten bracket bolts holding subframe to vehicle frame, also body guide bracket bolts.

HOIST

(2) Check tail gate hinge pins and chains, making sure they are secured in proper position.

(3) Galion body hinge bracket bolts must be tightened and checked to see that hinge bracket cross bar is properly cotter-pinned in place.

(4) Anthony body hinge bracket must be inspected to see that pivot pins are properly cotted in place.

c. Hoist.

(1) Check the oil supply, making sure the cylinder is full at all times.

(2) Tighten piston rod packing nut: (Draw up tight, then back off $\frac{1}{4}$ turn).

(3) Check valve operation by moving control lever to "RAISE," "HOLD," and "LOWER" positions.

(4) Check to see that valve control linkage is properly cotter-pinned.

(5) On Galion hoist mounting, check hoist support cross bar cotter pins, making sure they are in place.

(6) On Anthony hoist mounting, check hoist support pivot brackets, making sure all bracket bolt nuts are in position and securely tight.

d. Pump.

(1) On Galion pump mounting, check pump to cylinder cap screws, making sure they are tight and that no leaks exist.

(2) On Anthony pump mounting, check pump to cylinder stud nuts, making sure they are tight and that no leaks exist.

(3) Tighten valve stem packing nut. (Draw up tight then back off $\frac{1}{4}$ turn).

e. Drive Shaft.

(1) Keep the universal joints and steady bearing well lubricated (par. 20).

(2) Check slip joint, making sure this is free to move on the shaft when body is being raised or lowered.

(3) Tighten steady bearing support bracket bolts.

(4) Check shafts for excessive vibration "whip," making sure that yokes are tight on the shafts.

175. CONTROLS AND LINKAGE.

a. **Hoist Control Lever Removal.** Remove cab floor board retainer screws and floor board. Use care to position other levers so that floor board may be lifted clear without twisting or binding.

(1) Disconnect control rod at lower end of lever by removing cotter pin and washer.

2½-TON 4 x 2 TRUCK (FEDERAL)

(2) Remove pivot stud nut and washer. Lift lever off pivot stud and out of cab.

b. Hoist Control Lever Installation.

(1) Install lever on pivot stud and replace washer, nut, and cotter pin.

(2) Connect control rod to lower end of lever, and replace washer and cotter pin.

(3) Install cab floor board. Replace and tighten retainer screw.

c. Hoist Control Rods Removal.

(1) On Galion hoist, disconnect control rods at control lever, bell crank, and hoist valve lever, by removing cotter pins and washers.

(2) On Anthony hoist, disconnect control rod at control lever and valve lever by removing the cotter pins, washers, and clevis pins.

d. Hoist Control Rods Installation.

(1) On Galion hoist, insert rod ends through holes in levers and bell crank. Replace washers and cotter pins.

(2) On Anthony hoist, insert rod end through holes in hoist lever and insert clevis pin through rod yoke at control lever. Replace washers and cotter pins.

e. Hoist Control Bell Crank Removal (Galion Body Only).

(1) Disconnect control rods from bell crank by removing cotter pins and washers.

(2) Remove bell crank stud cotter pin, nut, and washer. Pull bell crank free of stud and lift out.

f. Hoist Control Bell Crank Installation (Galion Body Only).

Position bell crank on stud and replace washer, nut, and cotter pin. Connect control rods by inserting ends through the hole, and replacing washers and cotter pins.

g. Hoist Valve Lever Removal. On Galion hoist, disconnect control rod at lever by removing cotter pin and washer. Remove cotter pins, washers, and clevis pins from lever bracket and valve shaft. Withdraw control lever from position.

h. Hoist Valve Lever Installation.

(1) On Galion hoist, position lever on valve shaft and tap lightly with a hammer until clamp bolt hole lines up with slot in shaft. Install lever clamp bolt and tighten securely. Connect control rod to lever and install washer and cotter pin.

(2) On Anthony hoist, position lever and anchor bracket. Install clevis pins through anchor bracket and in valve shaft. Replace washer and cotter pins. Connect control rod to lever, and replace washer and cotter pin.

HOIST

176. HOIST CYLINDER ASSEMBLY.

a. Fill Hoist Cylinder with Oil.

(1) With body in fully raised position and safety blocking under the body, remove the filler plate or plug (fig. 128). (Anthony cylinder is equipped with a plug).

(2) Fill cylinder with proper grade of oil and replace filler plate or plug loosely.

(3) Remove the safety blocking, then raise and lower the body six times. This will free the cylinder of air. **CAUTION:** *Do not speed the engine while raising or lowering the body, as this will cause air pockets to form in the oil.* Idling speed is proper for this operation.

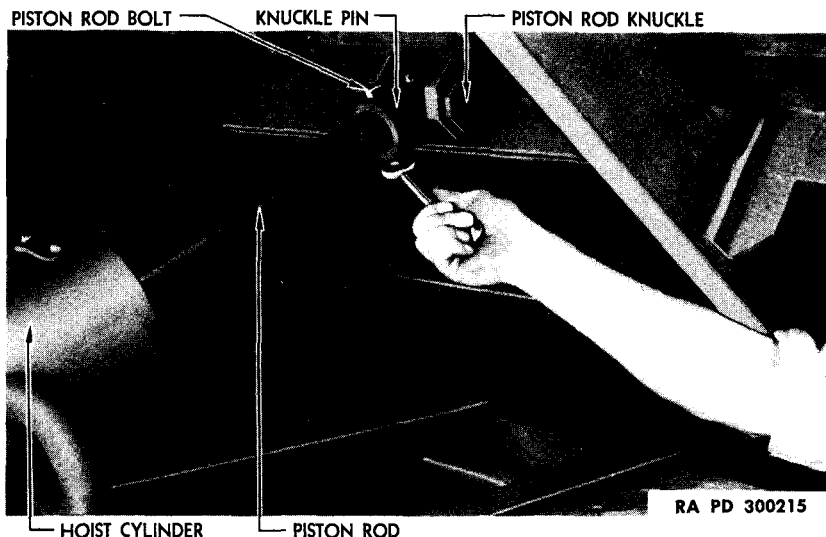

Figure 129—Removing Plunger Cross Head

(4) Replace the safety blocking and remove the filler plate, or plug, and check the oil supply. Add oil if necessary.

(5) Install the filler plate, or plug, and tighten securely.

(6) Remove safety blocking and lower body to normal position.

b. Hoist Cylinder Assembly Removal.

(1) Raise body to maximum height and place safety blocking in position to hold the body.

(2) Place suitable bar or block under hoist cylinder on subframe.

(3) Remove piston rod knuckle bolt (fig. 129).

(4) Disconnect cylinder valve control rod.

(5) Disconnect drive line by removing universal yoke set screw

2½-TON 4 x 2 TRUCK (FEDERAL)

and tapping yoke from pump shaft. Use a soft metal drift and a light hammer in removing yoke.

(6) On Galion hoist, remove hoist support bar cotter pin lock screw and cotter pin (fig. 124). Using suitable drift and hammer, drive the bar through the subframe. Continue to drive until cylinder is free (fig. 130).

(7) On Anthony hoist, remove the hoist pivot bracket to subframe bolts on left- and right-hand side.

(8) Work piston rod free of knuckle and lift cylinder assembly from subframe.

c. Hoist Cylinder Assembly Installation. Position cylinder on blocking on subframe, and fit piston rod in knuckle. Secure with bolt or cotter pin.

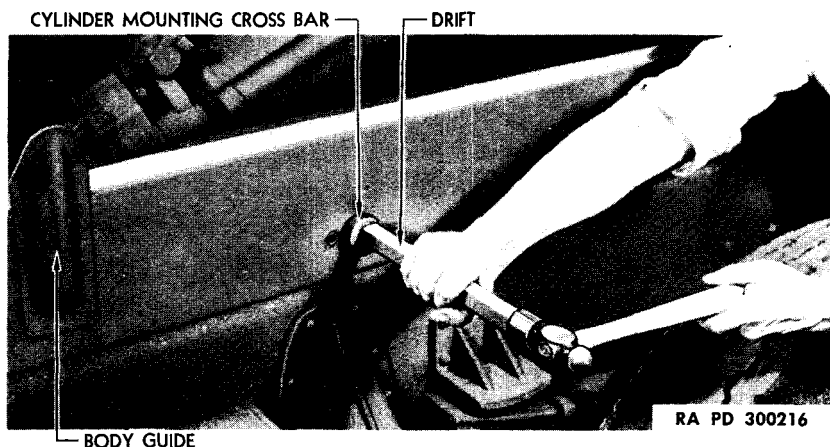

Figure 130—Removing Cylinder Mounting Cross Bar

(1) On Galion hoist, align cylinder with support bar and drive bar through. Continue to drive bar until cotter pin can be installed on outside of subframe. Install cotter pin and secure with lock screw.

(2) On Anthony hoist, position hoist cylinder and support member assembly on subframe. Replace pivot bracket bolts, tightening securely.

(3) Connect cylinder valve control rod.

(4) Install universal joint yoke on pump shaft. Make sure set screw is tight and wire locked.

(5) Remove temporary support block or bar from under cylinder.

HOIST

177. HOIST PUMP ASSEMBLY.

a. Hoist Pump Removal.

(1) Disconnect drive line at pump shaft by removing yoke set screw and universal joint yoke.

(2) Disconnect valve control rod at pump lever.

(3) On Galion pump, remove the two large cap screws holding the pump to cylinder (fig. 126). It will be noted upon removal that the right-hand cap screw is the plain type, and the one to the left is the ball check cap screw. Care must be taken to see that these screws are replaced in their respective positions when the pump is replaced.

(4) On Anthony pump, remove pump to cylinder stud nuts and carefully work pump free of studs.

b. Hoist Pump Installation.

(1) On Galion pump, position pump on end of the cylinder and install the plain cap screw in the right-hand side. Coat the threads of the ball check cap screw with joint and thread compound, and install in the left-hand side. Make sure that both cap screws are tight. Install universal joint yoke on pump shaft. Replace lock screws and lock wire.

(2) On Anthony pump, position pump on studs on the hoist cylinder, replace lock washers and nuts, and tighten securely. Install universal joint yoke on pump shaft. Replace lock screw and lock wire.

178. DRIVE SHAFT ASSEMBLY.

a. Drive Shaft Removal.

(1) Remove the set screws and universal joint yokes at power take-off and pump shafts.

(2) Loosen shaft steady bearing bracket from frame. Lift complete shaft assembly from vehicle.

b. Drive Shaft Installation.

(1) Assemble steady bearing and bracket to drive shaft. Lubricate steady bearing and universal joints thoroughly.

(2) Position shaft assemblies, and bolt steady bearing bracket to frame. Leave bolts loose until shafts have been connected to the power take-off and pump shaft.

(3) Position universal joint yoke on power take-off shaft. Install set screw and lock wire.

(4) Position universal joint yoke on pump shaft. Install set screw and lock wire.

(5) Check and position steady bearing bracket on shaft, and tighten bracket bolts securely.

(6) After shafts are installed, check alinement by raising and lowering the body three or four times.

2½-TON 4 x 2 TRUCK (FEDERAL)

Section XXX

BATTERY AND LIGHTING SYSTEM

	Paragraph
Description and tabulated data	179
Battery	180
Battery cables	181
Headlights	182
Blackout driving light	183
Blackout headlights	184
Tail and stop lights	185
Light switches	186
Chassis wiring	187

179. DESCRIPTION AND TABULATED DATA.

a. **Description.** The battery and lighting system consists of a 6-volt battery, two headlights, two blackout headlights, blackout driving light, blackout and service tail and stop lights, light switches, and necessary connecting wiring and cables (fig. 131).

b. Data.

	Make	Part No.
Headlight lamp	Guide	925000
Blackout headlight lamp	Guide	5934473
Blackout driving lamp	Mazda	63
Blackout tail lamp	Guide	5933078
Blackout stop lamp	Guide	5933121
Service stop lamp	Guide	5933104
Service tail lamp	Guide	5933078

180. BATTERY.

a. **Description.** The 6-volt, 3-cell, 57-plate, lead-acid-type battery is rated at 152 ampere hours, weighs 60 pounds, and is located in a cradle on top of the frame under the left fender. Positive terminal is grounded to the frame.

b. Battery Maintenance.

(1) **CURRENT RESERVE CHECK.** A direct-current voltmeter can be used to indicate to some degree the battery's condition as far as its capacity to continue supplying current is concerned. With the engine shut down and no load on the battery, the open-circuit reading should be approximately 6 volts. An excessive drop (more than 1 to 1.5 volts) in voltage with battery under heavy load (cranking motor engaged, for example) will indicate that something is wrong with the battery, its

BATTERY AND LIGHTING SYSTEM

reserve current capacity is very low, or that something is wrong with cable connections.

(2) **CHARGING BATTERY.** Provision is made on the vehicle for normal charging in service from a voltage-regulated, battery-charging, direct-current generator (par. 94). Should the battery become discharged, through overloading or neglect, it should be charged by a standard auxiliary battery charger.

(3) TEMPERATURE EFFECTS.

(a) *Warm Weather.* Check the battery for heating in normal warm weather. If battery feels more than blood-warm to the touch (approximately 100°F), inspect for short circuits and excessive charging.

(b) *Hot Regions.* In tropical regions, danger of overheating is much greater than in cooler climates. The battery, when fully charged, should have a gravity reading of 1.225 under such conditions.

(c) *Cold Regions.* Unless a full charge is maintained, the solution may freeze and cause damage to plates and containers to such an extent as to destroy the battery for all practicable purposes. A completely discharged battery may freeze at approximately 20°F.

(4) **CHECK SPECIFIC GRAVITY.** Determination of specific gravity is accomplished by the use of a commercial hydrometer supplied for this purpose (fig. 9). These are usually calibrated to read accurately only when electrolyte is at a certain specified temperature. Standards commonly used are 60° and 80°F. It is necessary to make corrections when taking readings at temperatures other than specified standard of hydrometer used. For every 10 degrees the temperature is above the hydrometer standard, "0.004" must be added to the specified gravity reading. For every 10 degrees the temperature is below the standard, "0.004" must be subtracted from the reading. Specific gravity readings without corrections for temperature are meaningless.

c. **Battery Removal.** Remove five retaining screws and lock washers from engine side panel and lift off battery. Remove the five retaining screws and lock washers from the battery cover, and lift off cover (fig. 132). Loosen the grounded (positive) terminal and lift it off terminal post. As removal of the grounded lead prevents the possibility of destructive arcs if metal tools accidentally short circuit a negative terminal to the compartment or frame, first loosen two clamp bar nuts on inner side of battery box, and lift battery out (fig. 133).

d. **Battery Installation.** Place the battery in position in the battery box with positive terminal nearest the ground lead. Secure battery by tightening clamp bar nuts. First, install and clamp negative cable terminal, then install and clamp positive (ground) cable terminal. Replace compartment cover and engine side panel, and secure battery by installing and tightening retaining bolts and lock washers.

2½-TON 4 x 2 TRUCK (FEDERAL)

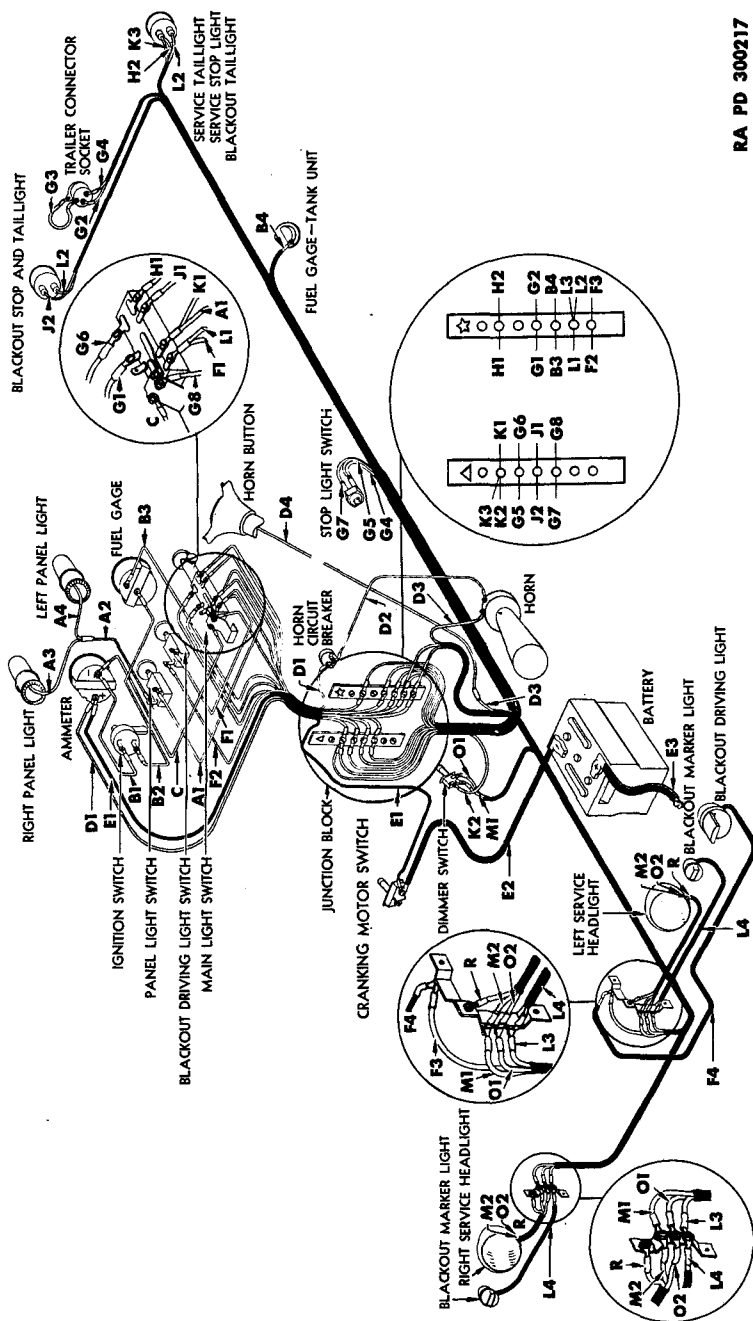

RA PD 300217

Figure 131—Battery and Lighting System Wiring Diagram

BATTERY AND LIGHTING SYSTEM

WIRE SIZE	ROUTE	COLOR
14	A1—MAIN LIGHT SWITCH "HT" TERMINAL TO PANEL LIGHT SWITCH	BLACK
16	A2—PANEL LIGHT SWITCH TO THREE-WIRE CONNECTION	BLACK—SINGLE
	A3—THREE-WIRE CONNECTION TO RIGHT PANEL LIGHT	
	A4—THREE-WIRE CONNECTION TO LEFT PANEL LIGHT	
	B1—AMMETER NEGATIVE TERMINAL TO IGNITION SWITCH	RED—BLACK T—SINGLE
	B2—IGNITION SWITCH TO FUEL GAGE	YELLOW—BLUE T
	B3—FUEL GAGE TO JUNCTION BLOCK	GREEN
	B4—JUNCTION BLOCK TO FUEL GAGE—TANK UNIT	RED
	C—AMMETER NEGATIVE TERMINAL TO MAIN LIGHT SWITCH "B" TERMINAL	BLUE
	D1—AMMETER POSITIVE TERMINAL TO HORN CIRCUIT BREAKER	BLACK
	D2—HORN CIRCUIT BREAKER TO HORN ASSY	CHROME
	D3—HORN ASSY. TO HORN BUTTON WIRE ASSY	CHROME
	D4—HORN BUTTON WIRE ASSY. THROUGH STEERING COLUMN TO HORN BUTTON	CHROME
	E1—AMMETER POSITIVE TERMINAL TO STARTER SWITCH	BLACK
	E2—STARTER SWITCH TO BATTERY NEGATIVE TERMINAL	BATTERY CABLE
	E3—BATTERY TO FRAME	STRAP
	F1—BLACKOUT DRIVING LIGHT SWITCH TO MAIN LIGHT SWITCH "BHT" TERMINAL	BLACK
	F2—BLACKOUT DRIVING LIGHT SWITCH TO JUNCTION BLOCK	BLACK
	F3—JUNCTION BLOCK TO LEFT HEADLIGHT JUNCTION BLOCK	BLACK
	F4—LEFT HEADLIGHT JUNCTION BLOCK TO BLACKOUT DRIVING LIGHT	
	G1—MAIN LIGHT SWITCH "IT" TERMINAL TO JUNCTION BLOCK	RED—YELLOW T
	G2—JUNCTION BLOCK TO TRAILER CONNECTOR SOCKET	RED—YELLOW T
	G3—TRAILER CONNECTOR SOCKET TO FRAME	RED
	G4—TRAILER CONNECTOR SOCKET TO STOP LIGHT SWITCH	YELLOW—BLUE T
	G5—JUNCTION BLOCK TO STOP LIGHT SWITCH	YELLOW—RED T
	G6—MAIN LIGHT SWITCH "SS" TERMINAL TO JUNCTION BLOCK	BLACK
	G7—JUNCTION BLOCK TO STOP LIGHT SWITCH	BLACK
	G8—MAIN LIGHT SWITCH "A" TERMINAL TO JUNCTION BLOCK	BROWN—BLACK T
	H1—MAIN LIGHT SWITCH "S" TERMINAL TO JUNCTION BLOCK	BROWN—BLACK T
	H2—JUNCTION BLOCK TO SERVICE STOP LIGHT	BLACK—WHITE T
	J1—MAIN LIGHT SWITCH "RS" TERMINAL TO JUNCTION BLOCK	BLACK—WHITE T
	J2—JUNCTION BLOCK TO BLACKOUT STOP AND TAILLIGHT	BLACK
	K1—MAIN LIGHT SWITCH "HT" TERMINAL TO JUNCTION BLOCK	BLACK
	K2—JUNCTION BLOCK TO DIMMER SWITCH	BLACK—GOLD TR
	K3—JUNCTION BLOCK TO SERVICE TAILLIGHT	YELLOW
	L1—MAIN LIGHT SWITCH "BHT" TERMINAL TO JUNCTION BLOCK	WHITE
	L2—JUNCTION BLOCK TO BLACKOUT TAILLIGHTS	
	L3—JUNCTION BLOCK TO RIGHT AND LEFT HEADLIGHT JUNCTIONS	
	L4—HEADLIGHT JUNCTION BLOCKS TO BLACKOUT MARKER LIGHTS	
	M1—DIMMER SWITCH TO RIGHT AND LEFT HEADLIGHT JUNCTION BLOCKS	RED—BLACK T
	M2—RIGHT AND LEFT HEADLIGHT JUNCTION BLOCKS TO SERVICE HEADLIGHTS—UPPER BEAM	
	O1—DIMMER SWITCH TO RIGHT AND LEFT HEADLIGHT JUNCTION	
	O2—RIGHT AND LEFT HEADLIGHT JUNCTION BLOCKS TO SERVICE HEADLIGHTS—LOWER BEAM	
	R—RIGHT AND LEFT HEADLIGHT JUNCTION BLOCKS TO SERVICE HEADLIGHTS—GROUND	GREEN

RA PD 300217B

Legend for Figure 131—Battery and Lighting System Wiring Diagram

2½-TON 4 x 2 TRUCK (FEDERAL)

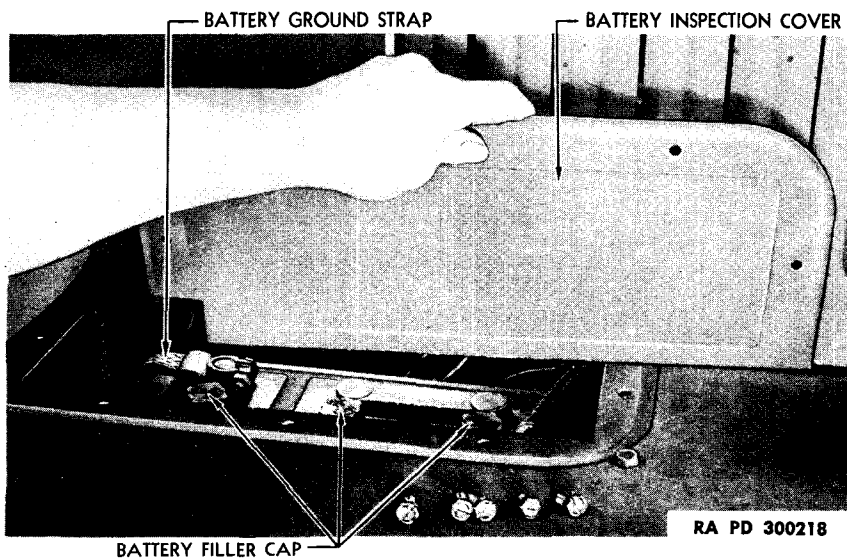

Figure 132—Removing Battery Inspection Cover

181. BATTERY CABLES.

a. **Description.** A heavy uninsulated ground strap connects the positive terminal of the battery to the frame side rail. The relatively heavy flow of starting current is conducted from the other terminal of the battery through a heavy, well-insulated cable reaching from the battery terminal to the cranking motor switch, and through another cable from the cranking motor switch to the cranking motor terminal.

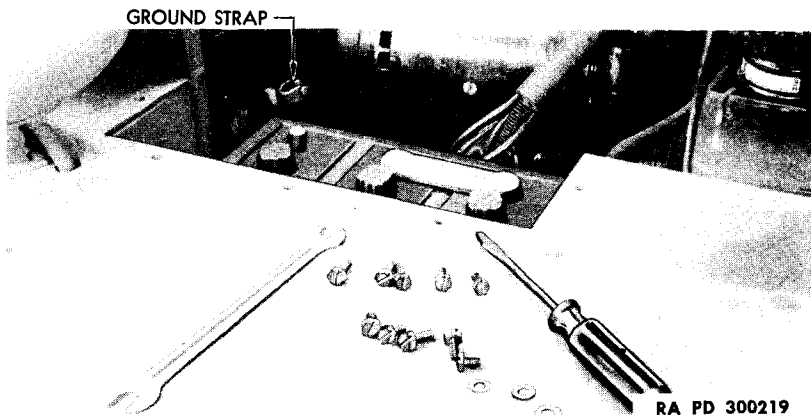

Figure 133—Battery Ready for Removal

BATTERY AND LIGHTING SYSTEM

b. Emergency Cable Repair. In the case of frayed or damaged insulation, cable must be temporarily protected with ordinary friction tape. If cable is broken, emergency repair is effected by fastening ends together, using lap or twisted joint secured with lighter wire. Solder or sweat the joint together for good electrical conductivity, then protect with friction tape.

c. Cable Removal. Always first loosen and remove cable from grounded terminal, regardless of what cables are to be removed (fig. 133), then proceed with the removal of desired cable. Loosen battery end terminal and lift off. Unscrew the terminal nuts on other end and remove cable. Remove switch to cranking motor cable by unscrewing terminal nuts and removing cable.

d. Cable Installation. Always replace grounded terminal cable last. This avoids possibility of shorts and dangerous burning in case of accidental metal-to-metal contact between other terminals and ground. Replace other cables in starting circuit first, making certain that they are in place in retaining grommets or supporting clips. Tighten all terminal nuts securely.

182. HEADLIGHTS.

a. Description. The headlights (fig. 134) are the sealed-beam type; that is, the reflector, lamp, and lens are a complete unit, and can only be replaced as a unit. The lower beam filament is positioned slightly to one side of the focal point in the reflector. This results in deflecting the lower or "traffic" beam to the right side, to illuminate the side of the road when meeting other vehicles.

b. Headlight Aiming. After lamp replacement it will be necessary to reaim headlights. An aiming screen should be used and the work should be done in a clear level space with a distance of 25 feet between screen and front of vehicle. A portable screen is preferable, because it simplifies the problem of centering the truck on the screen. The screen should be made of light-colored material, and should have a black center line for use in centering the screen on the truck. The screen should have two vertical black lines, one on each side of the center line and 18 inches from it. The screen should be equipped with a movable horizontal black tape.

(1) Place the truck on level floor, street, or ground with tires inflated to recommended specifications.

(2) Place screen 25 feet from the front of the truck and center the screen on the center line of the truck.

(3) Measure from the floor to the center of the headlight and set the horizontal tape on the screen three inches less than this measurement from the floor.

(4) Turn on the headlights (upper beam). Cover one light and check the location of the beam on the screen. The center of the hot

2½-TON 4 x 2 TRUCK (FEDERAL)

spot should be centered exactly at the intersection of the vertical and horizontal lines on the screen. If aim is incorrect, loosen the nut on the mounting bolt (fig. 134) and move the headlight body on its ball and socket joint until the beam is properly aimed. Then tighten the nut on the mounting bolt. Aim other headlight.

(5) No further adjustment is needed for the lower (traffic) beam.

c. **Headlight Unit Removal.** Loosen large nut under headlight body and swing headlight backward on its ball and socket support.

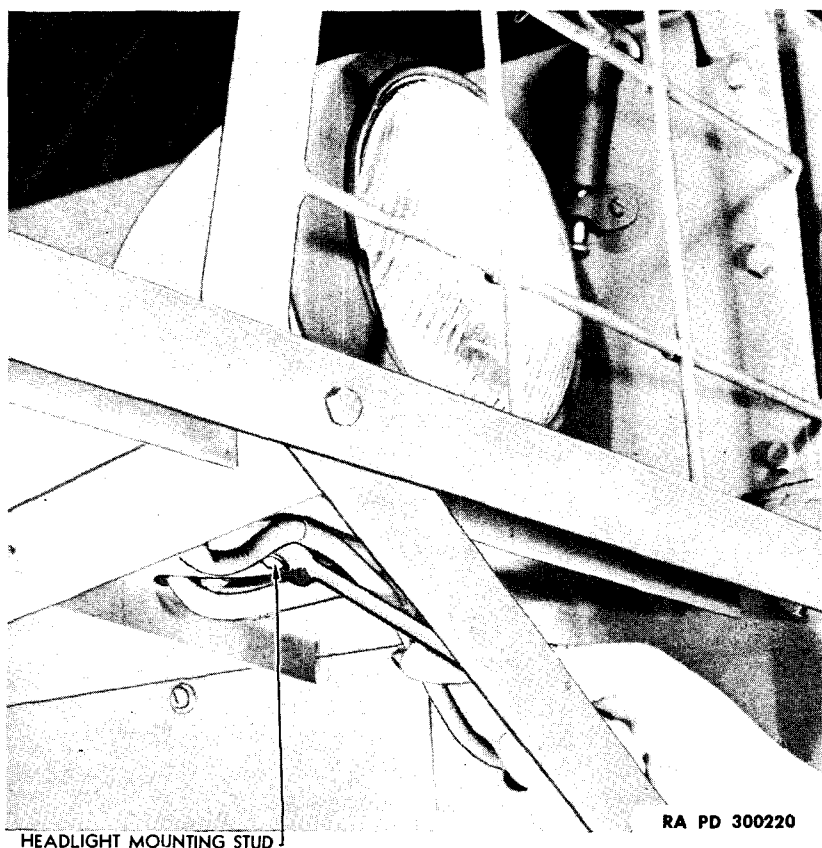

Figure 134—Loosening Headlight Mounting

BATTERY AND LIGHTING SYSTEM

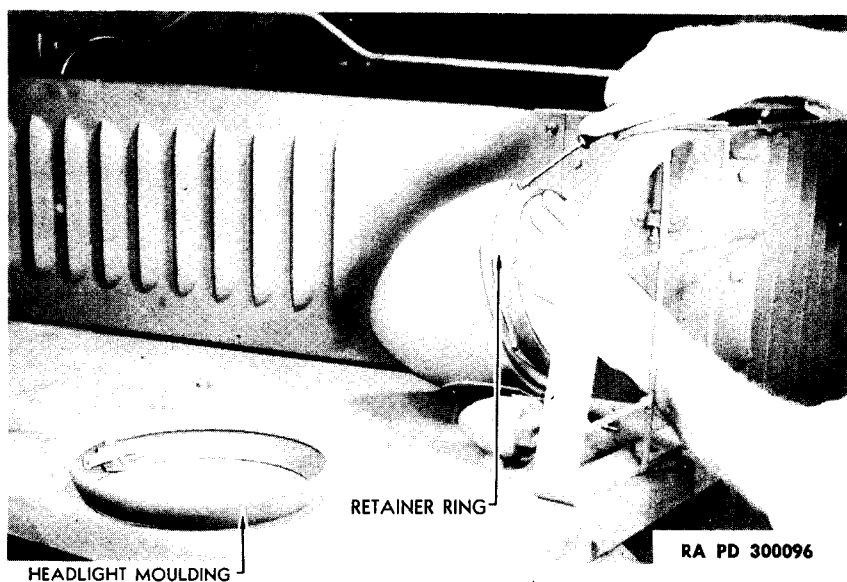

Figure 135—Removing Headlight Retainer Ring

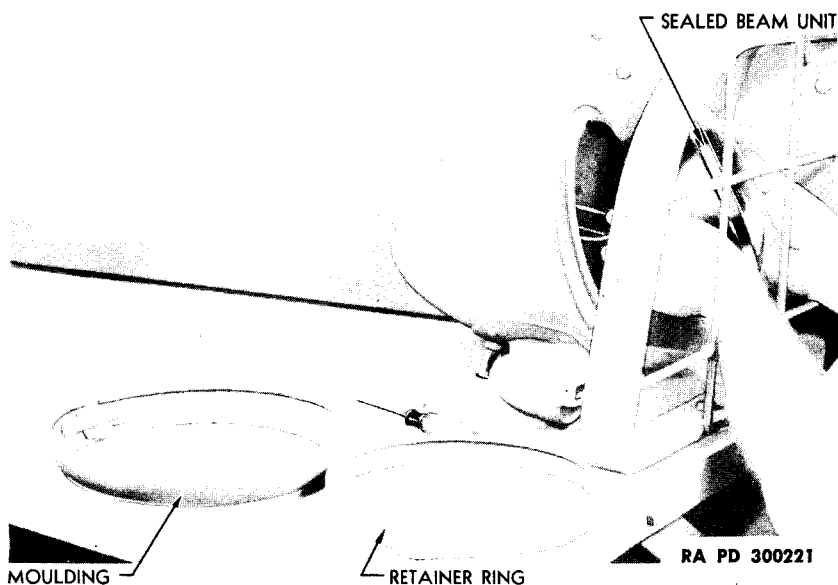

Figure 136—Removing Sealed Beam Unit

2½-TON 4 x 2 TRUCK (FEDERAL)

Loosen lens rim clamp screw and remove the rim. Remove the three screws attaching the retainer ring to the light body and remove ring. Pull the sealed beam lamp-unit out of the light body and disconnect the wiring connector from the rear of the unit.

d. **Head Lamp Unit Installation.** Connect wiring connector at rear of unit. Place lamp-unit in light body. Attach retainer ring to light body and fasten lens rim in place.

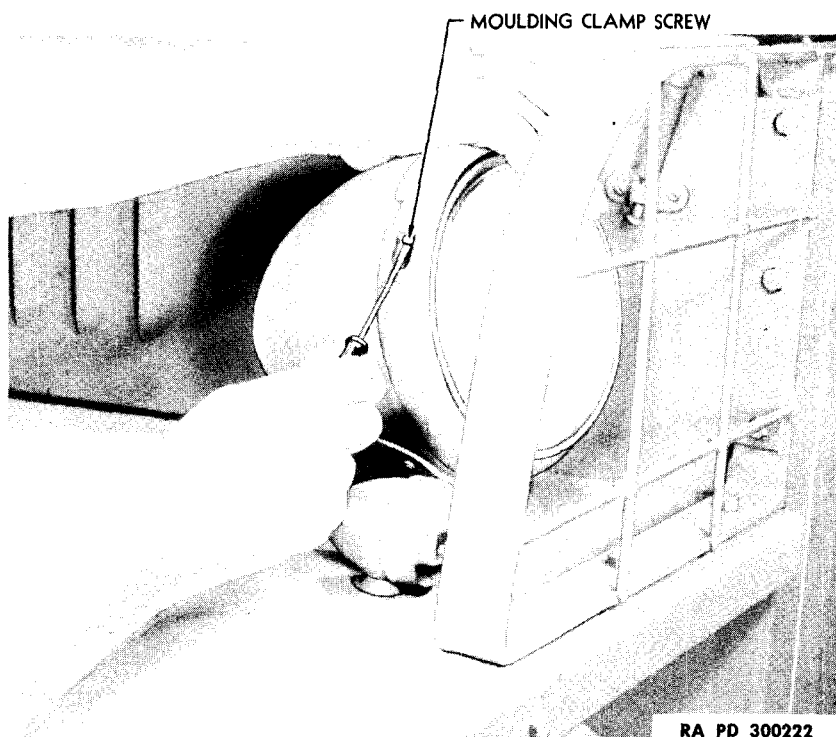

Figure 137—Installing Headlight

183. BLACKOUT DRIVING LIGHT.

a. **Description.** A blackout driving light mounted on the left front fender provides a shrouded, limited-range driving light. Reflector, lamp, lens, and shield are a complete sealed beam lamp-unit replaceable as an assembly.

b. **Lamp-unit Removal.** Take out clamp screw and remove retaining rim. Lift bulb unit out of support ring, disconnecting leads.

c. **Lamp-unit Installation.** Connect leads and place support ring and clamp in light body. Put retaining rim in position and secure with clamp screw.

BATTERY AND LIGHTING SYSTEM

184. BLACKOUT HEADLIGHTS.

a. **Description.** Blackout headlights are mounted on fenders at side of each headlight. A dowel hole in the fender assures proper positioning of the light.

b. **Lamp-unit Removal.** Remove light rim retaining screw, pull rim out at bottom, and raise it upward to release the stamped catch in the cover from the slot in the top of the light body. The lamp-unit is standard bayonet-base type. Press in slightly, turn to the left, and pull out.

c. **Lamp-unit Installation.** Press lamp into socket and turn to right to lock in position. Hook rim catch in slot in the top of light body, pull down, and secure with clamp screw.

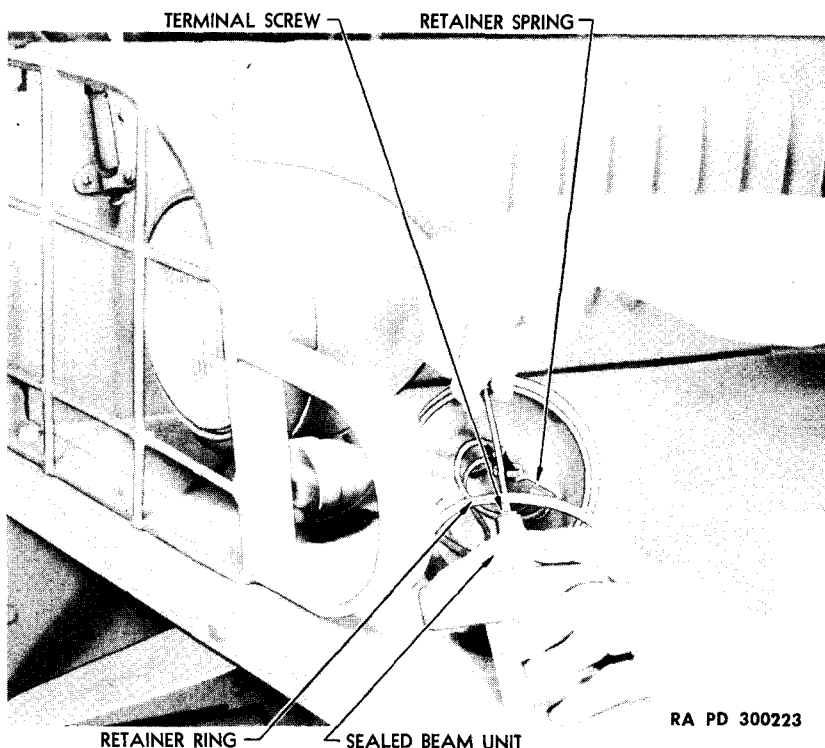

RA PD 300223

Figure 138—Removing Blackout Headlights

185. TAIL AND STOP LIGHTS.

a. **Description.** A combination service stop light and taillight and blackout taillight is mounted at left-hand rear of truck (figs. 122 and 123). A combination blackout stop light and taillight is mounted at right-hand rear of truck. The lens on each blackout taillight is

2½-TON 4 x 2 TRUCK (FEDERAL)

designed to produce two beams. This design is such that when one truck is following a preceding truck at a specified safe distance, these two beams will merge into a single beam. To insure the accuracy of construction necessary to produce this effect, the lamp is soldered to lens retainer, and lens and filter are crimped to retainer to form a complete lamp-unit.

b. Lamp-unit Removal. When a lamp-unit is burned out, it is necessary to replace the complete unit. Remove the two screws which attach the light rim to the body and pull the unit out of its socket in the light body.

c. Lamp-unit Installation. Press lamp-unit into socket in the light body, replace rim, and secure with two attaching screws.

186. LIGHT SWITCHES.

a. Stop Light Switch Removal. The stop light switch is of the hydraulic type. To remove, disconnect leads, and unscrew from master cylinder fitting.

b. Stop Light Switch Installation. Secure stop light switch into master cylinder fitting and tighten. Connect leads and tighten securely.

c. Headlight Beam Switch Removal. The headlight beam switch is of the foot-operated, push-button type. To remove, disconnect leads, and remove two screws holding switch to toeboard.

d. Headlight Beam Switch Installation. Place switch in position in toeboard and secure with two screws. Connect leads and tighten securely.

e. Main Light Switch. For removal and installation refer to paragraph 194.

187. CHASSIS WIRING.

a. Description. A simplified, perspective wiring diagram (fig. 131) shows the various circuits which operate the units and lights in the system. For convenience in servicing, the chassis wiring is made up in three separate wiring harnesses; namely, front chassis, instrument panel, and rear chassis wiring harness. These harnesses connect to a pair of common junction blocks on the front left side of the dash. Each block has seven terminals (fig. 131).

b. Wiring Harness Removal. *CAUTION: Always disconnect grounded terminal of battery before removing any harness from the chassis.* Disconnect all terminals at junction block, along the harness, and at outer ends of harness. Open clips, remove grommets, and pull harness through fixed grommets and from chassis.

Section XXXI

INSTRUMENTS, GAGES, AND SWITCHES

	Paragraph
Ammeter	188
Fuel gage	189
Oil pressure gage	190
Speedometer	191
Temperature gage	192
Speedometer shaft	193
Main light switch	194
Blackout driving light switch.....	195
Panel light switch	196
Ignition switch	197
Horn	198
Circuit breaker	199

188. AMMETER.

a. Before proceeding with any work behind the instrument panel involving switches or instruments, always remove battery cover and disconnect battery terminals (par. 180 c). When an instrument terminal wire is disconnected, tag it to make certain of correct installation.

b. **Ammeter Removal.** Remove terminal nuts and lock washers and lift off three cables from left-hand terminal, and two cables from right-hand terminal. Remove ammeter through front of panel by pressing from behind.

c. **Ammeter Installation.** Place ammeter in position. Place clamps on clamp screws and secure with lock washers and clamp nuts. Place three cables on left-hand terminal, two cables on right-hand terminal in same position as when removed, and secure with lock washers and terminal nuts.

189. FUEL GAGE.

a. **Fuel Gage Removal.** Remove terminal nut and lock washers from center terminal, and lift off terminal wire and insulating washer. Remove side terminal nut, lock washers, and wire. Remove two clamp nuts, lock washers, and clamps. Remove fuel gage through front of instrument panel by pressing from behind. It will facilitate removal of fuel gage to first remove main light switch from instrument panel, without disconnecting light switch terminals (par. 194).

b. **Fuel Gage Installation.** Place fuel gage in position. Place clamps on clamp screws and secure with lock washers and clamp nuts. Install insulating washer, center terminal wire, lock washer, and nut on center terminal, and tighten securely. Install side terminal wire and secure with lock washer and terminal nut. If main light switch was removed, install (par. 194).

2½-TON 4 x 2 TRUCK (FEDERAL)

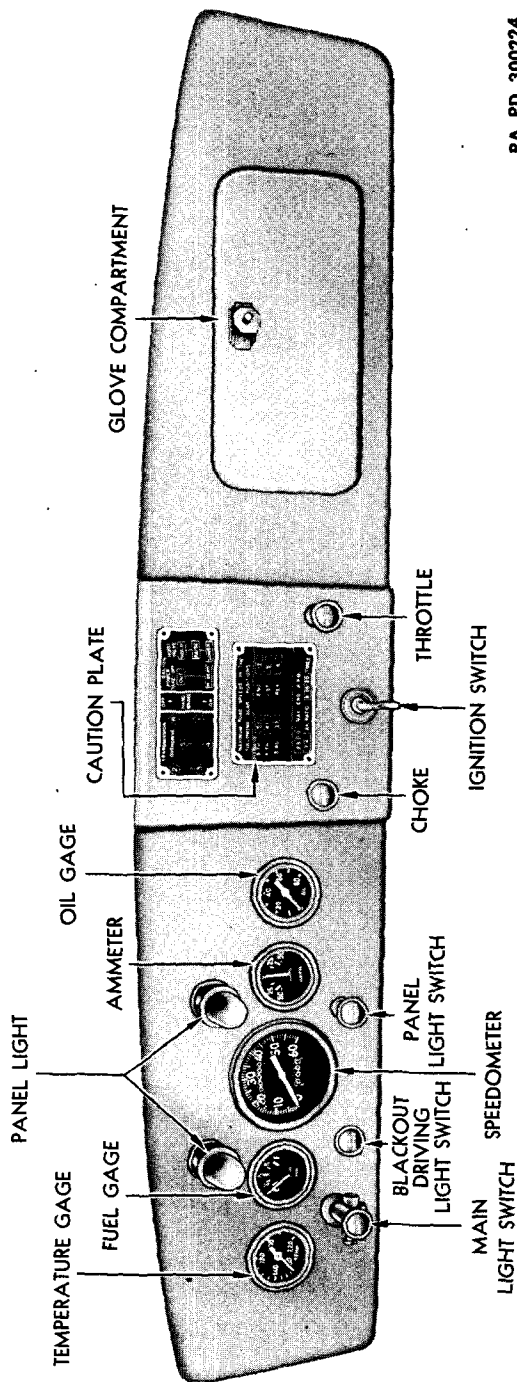

RA PD 300224

Figure 139—Instrument Panel, Front

INSTRUMENTS, GAGES, AND SWITCHES

RA PD 300225

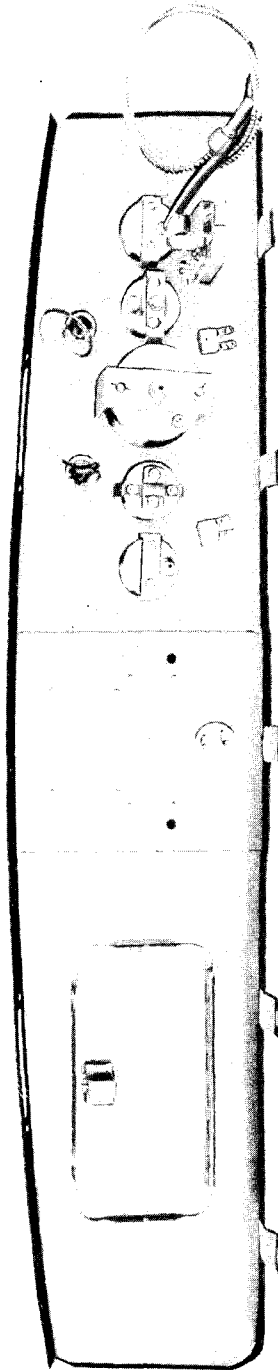

Figure 140—Instrument Panel, Rear

2½-TON 4 x 2 TRUCK (FEDERAL)

190. OIL PRESSURE GAGE.

a. **Oil Pressure Gage Removal.** Disconnect oil line at rear of gage, remove clamp nuts and lock washers, and lift off clamp. Remove gage through front of panel by pressing from behind.

b. **Oil Pressure Gage Installation.** Place gage in position in instrument panel and place clamp on clamp screws, installing lock washers and clamp nuts. Tighten securely. Place oil pressure line in position and tighten connecting nut securely.

191. SPEEDOMETER.

a. **Speedometer Head Removal.** Unscrew knurled cable nut from center of speedometer body and disconnect cable. Remove two clamp wing nuts and lock washers, and lift off clamp. Press speedometer from rear, and lift out through front of instrument panel.

b. **Speedometer Head Installation.** Place speedometer head in instrument panel. Place clamp in position, installing lock washers and tightening wing nuts. Place drive cable in position, making certain that tongue in cable fits in driven groove in speedometer head. Tighten knurled cable retaining nut.

192. TEMPERATURE GAGE.

a. **Temperature Gage Removal.** Disconnect capillary tube at engine. Unscrew the tube retaining nut with care to avoid twisting capillary tube. Remove temperature gage clamp nuts and lock washers and lift off clamp. Simultaneously work capillary tube through dash while gage and tube are being removed from instrument panel.

b. **Temperature Gage Installation.** Thread capillary tube through gage hole in instrument panel, and through hole in dash, working enough tube through dash to bring gage into position on instrument panel. Place gage clamp on gage screws, install lock washers, and tighten clamp nuts securely. Place capillary tube end fitting in cylinder block, and tighten retaining nut securely.

193. SPEEDOMETER SHAFT.

a. **Speedometer Shaft Removal.** Disconnect speedometer cable by loosening and removing knurled cable swivel nut at rear center of speedometer head. Free cable from cable clamp on engine side of dash, and at frame clamp beneath right-hand side of cab. Draw cable through dash, loosen, and remove knurled swivel nut at transmission end, and remove cable from vehicle.

b. **Speedometer Shaft Installation.** Place speedometer cable in position and connect lower end to transmission drive fitting, making certain that drive unit meshes with cable tongue. Tighten knurled swivel nut securely. Place cable in position at frame retaining clip, and dash retaining clip, and work upper end of cable through dash. Connect

INSTRUMENTS, GAGES, AND SWITCHES

upper end of cable to speedometer head, making certain that cable drive tongue meshes with speedometer head drive shaft. Tighten knurled retaining nut securely. Adjust cable for smooth curvature. Tighten cable retaining clamps at dash and frame.

194. MAIN LIGHT SWITCH.

a. **Main Light Switch Removal.** Disconnect and tag all leads from switch and circuit breaker behind instrument panel. Loosen small screw in switch knob hole by inserting small screwdriver. Remove knob from pull rod. Remove switch mounting screw from switch assembly. Push down on lockout button and pull locking assembly from switch body. Remove switch body and circuit breaker through the rear of the panel.

b. **Main Light Switch Installation.** Disassemble and remove lockout switch (step a above). Insert switch body and circuit breaker from rear through opening in panel and slide lockout button in place. Tighten switch mounting nut and connect wires to proper terminals.

195. BLACKOUT DRIVING LIGHT SWITCH.

a. **Blackout Driving Light Switch Removal.** Disconnect and tag two wires from terminals behind panel. With small screwdriver, loosen screw that holds switch knob to shaft, and remove knob. Remove lock nut from body at front of panel. Remove switch body from rear of panel.

b. **Blackout Driving Light Switch Installation.** With pull knob removed from switch, insert switch body in position from rear of panel and secure with lock nut installed from front. Install knob on shaft and set the screw with a small screwdriver. Connect wires to proper terminals.

196. PANEL LIGHT SWITCH.

a. **Panel Light Switch Removal.** Disconnect and tag two wires from terminals behind panel. With a small screwdriver loosen set screw that holds knob to shaft, and pull off knob. Remove lock nut from body at front of panel and remove switch body through rear of panel.

b. **Panel Light Switch Installation.** Install switch body through proper opening in panel from rear, and secure with lock nut from front. Install switch knob in position on shaft and set the set screw with a small screwdriver. Connect the wires to proper terminals.

197. IGNITION SWITCH.

a. **Ignition Switch Removal.** Disconnect and tag two leads from terminals behind instrument panel. Remove knurled mounting lock nut from switch body at front of panel, by inserting small drift into one of the two countersunk holes, and tap lightly.

2½-TON 4 x 2 TRUCK (FEDERAL)

b. Ignition Switch Installation. Place switch through hole in instrument panel and secure with knurled lock nut. Connect the leads to proper terminals and tighten securely.

198. HORN.

a. Horn Assembly Removal. Disconnect two leads and remove two horn to horn bracket support bolts. Lift out horn assembly.

b. Horn Assembly Installation. Secure horn to horn support bracket by installing two bolts and nuts. Attach two leads to proper terminals.

199. CIRCUIT BREAKER.

a. Horn Circuit Breaker Removal. Remove and tag two wires from terminals on circuit breaker (fig. 66). Remove two circuit breaker to dash mounting screws, and remove circuit breaker.

b. Horn Circuit Breaker Installation. Attach circuit breaker in position on dash, using two screws. Connect two wires to proper terminals.

c. Main Light Switch Circuit Breaker Removal. Remove and tag two wires from terminal posts on circuit breaker. Remove two circuit breaker to circuit breaker bracket screws and washers, and remove circuit breaker from behind panel.

d. Main Light Switch Circuit Breaker Installation. Attach circuit breaker to circuit breaker bracket on main light switch with two screws and washers. Connect wires to proper terminal posts.

Section XXXII

POWER TAKE-OFF

	Paragraph
Description and tabulated data	200
Case removal	201
Case installation	202
Controls and linkage removal	203
Controls and linkage installation	204

200. DESCRIPTION AND TABULATED DATA.

a. **Description.** The power take-off unit is bolted on the right side of the transmission case. Its purpose is to provide engine power for operating the hydraulic hoist cylinder pump. It is of the single sliding-gear type and is engaged and disengaged by the power take-off lever located in the cab.

b. Tabulated Data (Galion).

Power take-off make	National Fibre
Type	Single speed
Ratio	Direct
Engine rpm	1000
Take-off rpm	723

201. CASE REMOVAL.

a. Remove the transmission drain plug and drain lubricant into a suitable container. Disconnect take-off shifter linkage at shifter rail. Loosen drive shaft universal joint set screws. Using soft drift and hammer, drive universal joint and take-off shaft assembly toward rear of vehicle until joint is free from take-off drive shaft. Remove five power take-off case to transmission attaching cap screws, and remove power take-off case and gear as a unit. Remove power take-off case gasket.

202. CASE INSTALLATION.

a. Clean power take-off opening surface of transmission, coating new gasket with joint and thread compound and pressing into position. Place power take-off case and gear assembly in position and install five attaching cap screws, tightening securely. Place drive shaft universal joint in alignment and drive onto take-off shaft, using soft drift and hammer. Lock in position by tightening set screw and secure with lock wire in such a manner as to prevent reverse rotation of set screw. Connect take-off shift linkage, installing washer and cotter pin. Refill transmission with lubricant (par. 20).

2½-TON 4 x 2 TRUCK (FEDERAL)

203. CONTROLS AND LINKAGE REMOVAL.

a. Disconnect take-off shifter linkage at shifter shaft end by removing cotter pin and washer. Disconnect lever by removing lever bolt from frame bracket, and remove lever and link from truck. Disconnect valve operating linkage (par. 175) at valve, and at reversing lever, by removing cotter pins and washers, and lift from truck. Disconnect valve control lever linkage by removing cotter pins and washers, and lift from truck. Remove valve control lever. Remove bolt and lift out reversing lever.

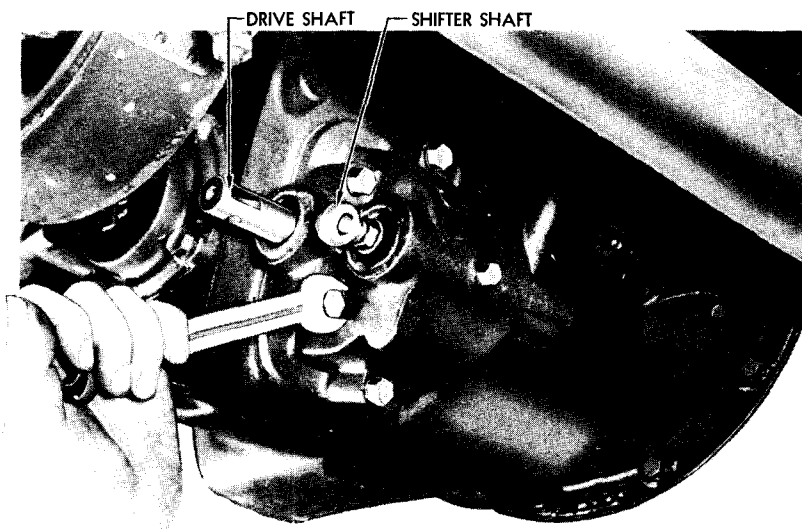

RA PD 300226

Figure 141—Removing Power Take-off Case

204. CONTROLS AND LINKAGE INSTALLATION.

a. Place power take-off shaft lever and power take-off valve lever in position, and install trunnion bolt through levers and supporting bracket. Connect take-off shift lever linkage at power take-off shift shaft, securing with washer and cotter pin. Connect valve linkage at valve end. At reverse lever end, install washers and cotter pins. Connect valve control lever linkage at control lever end. Connect lever linkage at oil pump end, installing washers and cotter pins.

Section XXXIII

SHIPMENT AND TEMPORARY STORAGE

	Paragraph
General instructions	205
Preparation for temporary storage or domestic shipment.....	206
Loading and blocking for rail shipment.....	207

205. GENERAL INSTRUCTIONS.

a. Preparation for domestic shipment of the vehicle is the same as preparation for temporary storage or bivouac. Preparation for shipment by rail includes instructions for loading and unloading the vehicle, blocking necessary to secure the vehicle on freight cars, number of vehicles per freight car, clearance, weight, and other information necessary to properly prepare the vehicle for rail shipment. For more detailed information, and for preparation for indefinite storage, refer to AR 850-18.

206. PREPARATION FOR TEMPORARY STORAGE OR DOMESTIC SHIPMENT.

a. Vehicles to be prepared for temporary storage or domestic shipment are those ready for immediate service, but not used for less than thirty days. If vehicles are to be indefinitely stored after shipment by rail, they will be prepared for such storage at their destination.

b. If the vehicles are to be temporarily stored or bivouacked, take the following precautions:

(1) **LUBRICATION.** Lubricate the vehicle completely (par. 20).

(2) **COOLING SYSTEM.** If freezing temperature may normally be expected during the limited storage or shipment period, test the coolant with a hydrometer and add the proper quantity of antifreeze compound, to afford protection from freezing at the lowest temperature anticipated during the storage or shipping period. Completely inspect the cooling system for leaks.

(3) **BATTERY.** Check battery and terminals for corrosion and if necessary, clean and thoroughly service battery (par. 180).

(4) **TIRES.** Clean, inspect, and properly inflate all tires. Replace with serviceable tires, all tires requiring retreading or repairing. Do not store vehicles on floors, cinders, or other surfaces which are soaked with oil or grease. Wash off immediately any oil, grease, gasoline, or kerosene which comes in contact with the tires under any circumstances.

(5) **ROAD TEST.** The preparation for limited storage will include a road test of at least five miles, after the battery, cooling system, lubrication, and tire services, to check on general condition of the vehicle. Correct any defects noted in the vehicle operation, before the vehicle

2½-TON 4 x 2 TRUCK (FEDERAL)

is stored, or note on a tag attached to the steering wheel, stating the repairs needed, or describing the condition present. A written report of these items will then be made to the officer in charge.

(6) **FUEL IN TANKS.** It is not necessary to remove the fuel from the tanks for shipment within the United States, nor to label the tanks under Interstate Commerce Commission Regulations. Leave fuel in the tanks except when storing in locations where Fire Ordinances, or other local regulations, require removal of all gasoline before storage.

(7) **EXTERIOR OF VEHICLE.** Remove rust appearing on any part of the vehicle exterior with sandpaper. Repaint painted surfaces whenever necessary to protect wood or metal from deterioration. Exposed polished metal surfaces which are susceptible to rust, such as winch cables, chains, and, in the case of track-laying vehicles, metal tracks, should be coated with a protective medium grade lubricating oil. Close firmly all cab doors, windows, and windshields. Vehicles equipped with open-type cabs with collapsible tops will have the tops raised, all curtains in place, and the windshield closed. Make sure tarpaulins and window curtains are in place and firmly secured. Leave rubber mats, such as floor mats, where provided, in an unrolled position on the floor, and not rolled or curled up. Equipment, such as Pioneer and truck tools, tire chains, and fire extinguishers, will remain in place in the vehicle.

(8) **INSPECTION.** Make a systematic inspection just before shipment or temporary storage, to insure all above steps have been covered, and that the vehicle is ready for operation on call. Make a list of all missing or damaged items and attach it to the steering wheel. Refer to Before-operation Service (par. 15).

(9) **ENGINE.** To prepare the engine for storage, remove the air cleaner from the carburetor. Start the engine and set the throttle to run the engine at a fast idle. Pour one pint of medium grade, preservative lubricating oil, Ordnance Department Specification AXS-674, of the latest issue in effect, into the carburetor throat, being careful not to choke the engine. Turn off the ignition switch as quickly as possible after the oil has been poured into the carburetor. With the engine switch off, open the throttle wide, and turn the engine five complete revolutions by means of the cranking motor. If the engine cannot be turned by the cranking motor with the switch off, turn it by hand, or disconnect the high-tension lead and ground it before turning the engine by means of the cranking motor. Then reinstall the air cleaner.

(10) **BRAKES.** Release brakes and chock the wheels or tracks.

c. Inspections in Limited Storage.

(1) Vehicles in limited storage will be inspected weekly for condition of tires and battery. If water is added when freezing weather is anticipated, recharge the battery with a portable charger or remove the battery for charging. Do not attempt to charge the battery by running the engine.

SHIPMENT AND TEMPORARY STORAGE

207. LOADING AND BLOCKING FOR RAIL SHIPMENT.

a. **Preparation.** In addition to the preparation described in paragraph 206, when ordnance vehicles are prepared for domestic shipment, the following preparations and precautions will be taken:

(1) **EXTERIOR.** Cover the body of the vehicle with a canvas cover supplied as an accessory.

(2) **TIRES.** Inflate pneumatic tires from 5 to 10 pounds above normal pressure.

(3) **BATTERY.** Disconnect the battery to prevent its discharge by vandalism or accident. This may be accomplished by disconnecting the positive lead, taping the end of the lead, and tying it back away from the battery.

(4) **BRAKES.** The brakes must be applied and the transmission placed in low gear, after the vehicle has been placed in position with a brake wheel clearance of at least 6 inches ("A", fig. 142). The vehicles will be located on the car in such a manner as to prevent the car from carrying an unbalanced load.

(5) All cars containing ordnance vehicles must be placarded "DO NOT HUMP."

(6) Ordnance vehicles may be shipped on flat cars, end-door box cars, side-door box cars, or drop-end gondola cars, whichever type car is the most convenient.

b. **Facilities for Loading.** Whenever possible, load and unload vehicles from open cars under their own power, using permanent end ramps and spanning platforms. Movement from one flat car to another along the length of the train is made possible by cross-over plates or spanning platforms. If no permanent end ramp is available, an improvised ramp can be made from railroad ties. Vehicles may be loaded in gondola cars without drop ends by using a crane. In case of shipment in side-door box cars, use a dolly-type jack to fit the vehicles into position within the car.

c. **Securing Vehicles.** In securing or blocking a vehicle, three motions (lengthwise, sidewise, and bouncing), must be prevented. There are two approved methods of blocking the vehicles on freight cars, as described below. When blocking dual wheels, all blocking will be located against the outside wheel of the dual.

(1) **METHOD 1** (fig. 142). Locate eight blocks "B," one to the front, and one to the rear of each wheel. Nail the heel of each block to the car floor, using five 40-penny nails to each block. That portion of the block under the tread will be toenailed to the car floor with two 40-penny nails to each block. Locate two blocks "D" against the outside face of each wheel. Nail the lower block to the car floor with three 40-penny nails, and the top block to the lower block with three 40-penny nails. Pass four strands, two wrappings, of No. 8 gage, black annealed wire "C" through the holes in the wheels and then through

2½-TON 4 x 2 TRUCK (FEDERAL)

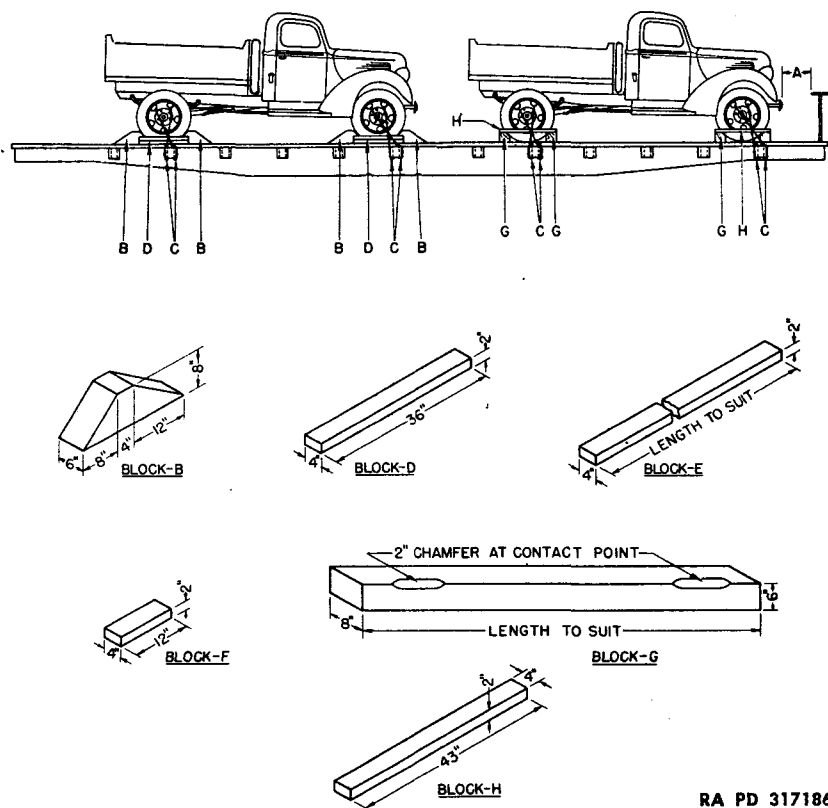

Figure 142—Block Requirements for Securing Wheeled Vehicles on Railroad Cars

SHIPMENT AND TEMPORARY STORAGE

the stake pockets. Tighten the wires enough to remove slack. When a box car is used, this strapping must be applied in a similar fashion and attached to the floor by the use of blocking or anchor plates. This strapping is not required when gondola cars are used.

(2) **METHOD 2** (fig. 142). Place four blocks "G," one to the front and one to the rear of each set of wheels. These blocks are to be at least 8 inches wider than the over-all width of the vehicle at the car floor. Using sixteen blocks "F," locate two against blocks "G" to the front of each wheel, and two against blocks "G" to the rear of each wheel. Pass four strands, two wrappings, of No. 8 gage, black annealed wire "C" through the holes in the wheels, and secure as described in method 1 above.

2½-TON 4 x 2 TRUCK (FEDERAL)

REFERENCES

STANDARD NOMENCLATURE LISTS.

Truck, 2½-ton, 4 x 2, dump (Federal 2 G).....	SNL G-539
Cleaning, preserving, and lubricating materials, recoil fluids, special oils, and miscellaneous related items	SNL K-1
Soldering, brazing, and welding materials, gases, and related items	SNL K-2
Tool sets—motor transport	SNL N-19
Interchangeability chart of organizational special tools for combat vehicles	SNL G-19
Current Standard Nomenclature Lists are listed above. An up-to-date list of SNL's is maintained in the "Index to Ordnance Publications".....	OFSB 1-1

EXPLANATORY PUBLICATIONS.

List of Publications for Training.....	FM 21-6
Automotive Materiel.	
Automotive brakes	TM 10-565
Automotive electricity	TM 10-580
Automotive power transmission units.....	TM 10-585
Chassis, body and trailer units.....	TM 10-560
Camouflage	FM 5-20
Driver's manual	TM 10-460
Electrical fundamentals	TM 1-455
Fuels and carburetion	TM 10-550
Military motor transportation	TM 10-505
Motor transport	FM 25-10
Military motor vehicles	AR 850-15
Ordnance maintenance: 2½-ton truck (Federal)	TM 9-1821
Ordnance maintenance: Electrical equipment (Auto-Lite)	TM 9-1825B
Ordnance maintenance: Carburetors (Carter)...	TM 9-1826A
Ordnance maintenance: Vacuum power brake systems (Bendix BK)	TM 9-1827B
Ordnance maintenance: Hercules engines, Model JXD	TM 9-1832A
Standard military motor vehicles.....	TM 9-2800
The internal combustion engine	TM 10-570
The motor vehicle	TM 10-510

REFERENCES

Care and Preservation.

Automotive lubrication	TM 10-540
Cleaning, preserving, lubricating, and welding materials, and similar items issued by the Ordnance Department	TM 9-850
Detailed lubrication instructions for Ordnance Materiel	OFSB-series
Explosives and demolitions	FM 5-25
Motor transport inspections	TM 10-545
Maintenance and care of pneumatic tires and rubber treads	TM 31-200

Decontamination.

Chemical decontamination materials and equipment.	TM 3-220
Decontamination of armored force vehicles.	FM 17-59
Defense against chemical attack	FM 21-40
Military chemistry and chemical agents	TM 3-215

Storage and Shipment.

Registration of motor vehicles	AR 850-10
Storage of motor vehicle equipment.	AR 850-18
Rules governing the loading of mechanized and motorized army equipment; also, major caliber guns, for the United States Army and Navy, on open top equipment, published by Operations and Maintenance Department of Association of American Railroads.	

2½-TON 4 x 2 TRUCK (FEDERAL)

INDEX

	A	Page No.		Page No.
Axles			dump body	
front		166	installation	225
rear		173	removal	225
B			fenders	
Battery and lighting system			installation	222
battery			removal	221
description		236	hood assembly	
installation		237	installation	222
maintenance		236	removal	222
removal		237	pintle hook assembly	
battery cables			installation	223
description		241	removal	223
emergency cable repair		241	running boards	
installation		241	installation	221
removal		241	removal	221
blackout driving light			tow hooks	
description		244	installation	222
lamp-unit installation		244	removal	222
lamp-unit removal		244	windshield wiper assembly	
blackout headlights			installation	224
description		245	removal	224
lamp-unit installation		245	repair	224
lamp-unit removal		245	Brake system	
chassis wiring			bleeding brake lines	181
description		246	brake lines assembly	
wiring harness removal		246	tubing repair	192
data		236	brake shoe assembly	
description		236	description	193
headlights		241	installation	193
light switches			removal	193
headlight beam switch instal-			check valve	
lation		246	description	190
headlight beam switch removal		246	installation	191
main light switch		246	removal	191
stop light switch installation..		246	description	177
stop light switch removal.....		246	flexible hose	
tail and stop lights			description	191
description		245	installation	192
lamp-unit installation		246	removal	191
lamp-unit removal		246	hand brake adjustment.....	194
Body and frame			hand brake band and lining	
			installation	197
bumper			removal	196
installation		221	hand brake controls	
removal		221	installation	198
cushion seats		223	removal	198
description			hand brake drum	
cab		220	installation	197
frame		220	removal	197
sheet metal		220		

INDEX

B—Cont'd	Page No.		Page No.
Brake system—Cont'd		fan belt removal	133
hydraulic system	177	maintenance	133
hydrovac assembly		hose connections	
description	188	installation	136
installation	190	removal	136
maintenance	188	radiator assembly	
removal	188	description	129
master cylinder		installation	131
description	187	removal	129
installation	187	tabulated data	125
removal	187	thermostat	
servicing brakes		description	137
major adjustment procedure..	185	installation	137
minor adjustment procedure..	184	removal	137
system testing		test	137
brake pedal adjustment.....	179	water pump	
check valve and vacuum line..	179	description	125
hydraulic slave cylinder	180	installation	128
power cylinder and relay valve	180	maintenance and adjustment.	125
primary testing	179	removal	127
tabulated data (service brakes).	179		
vacuum system	179	D	
wheel cylinder		Data	
description	188	battery and lighting system....	236
installation	188	brake system	179
removal	188	clutch	104
		cooling system	125
C		engine	89
Clutch		front axle	166
adjust controls	110	fuel system	111
cover assembly removal	109	ignition system	138
description	104	power take-off	253
installation	110	propeller shaft	163
maintenance and adjustment		rear axle	173
adjustment for facing wear...	105	springs and shock absorbers....	211
clutch pedal free travel adjust-		starting and generating systems.	153
ment	105	steering gear	217
lubrication	104	transmission	159
pedal-to-toeboard clearance ad-		vehicle	8
justment	108	Data, vehicle	
plate assembly removal	109	capacities	10
removal	109	performance	8
inspection	109	specifications	8
tabulated data	104	Description of vehicle	7
Cooling system		Differences among models	
description	125	dump bodies	7
fan belt, and fan and hub as-		Driving controls and operation	
sembly		dump body operation (Anthony)	
description	132	lowering body	16
fan and hub removal.....	134	raising body	16
fan belt installation	134		

2½-TON 4 x 2 TRUCK (FEDERAL)

D—Cont'd		Page No.		Page No.
Driving controls and operation—			exhaust	52
Cont'd			fire extinguisher	53
controls			frame	53
accelerator pedal	11		front axle	48
blackout driving light switch ..	11		fuel system	53
brake lever	11		hydraulic hoist	53
brake pedal	11		instruments and gages	53
choke control	11		miscellaneous	54
clutch pedal	12		power take-off case	50
cranking motor switch	12		propeller shaft	54
dimmer switch	12		rear axle	49
gas supply	11		sheet metal	53
hoist lever	12		shock absorbers and linkage	48
ignition switch	12		springs	54
main light switch	12		steering system	54
oil supply	11		tires	54
panel light switch	12		transmission	54
power take-off lever	12		vehicle assembly	54
tail gate release lever	12		wheels	54
throttle button	13		Engine	
transmission shift lever	12		carbon removal	91
water supply	11		compression test	90
windshield wiper control	13		battery and ignition cables	91
dump body operation (Galion)			carburetor	91
lowering body	17		distributor	91
raising body	16		spark plugs	90
instruments			timing	91
ammeter	13		valve clearance	91
fuel gage	13		crankcase ventilator and air	
oil gage	13		cleaner	
speedometer	13		maintenance	100
temperature gage	13		removal	99
operation of vehicle			cylinder head and gasket instal-	
driving vehicle	14		lation	92
starting engine	13		cylinder head and gasket removal	91
stopping vehicle	15		description	89
towing vehicle			engine specifications	89
disabled vehicle	17		installation	102
to start engine	17		intake and exhaust manifolds	
			and gasket installation	93
			intake and exhaust manifolds and	
			gasket removal	93
			oil filter service	
			clean oil filter body	99
			install element	99
			remove element	98
			oil pan	
			installation	94
			removal	94
			oil pump	
			adjustment	95

E

Echelon system of maintenance
allocation

body	49
brake (hand)	49
brakes (service—foot)	49
cab	50
clutch	50
cooling system	50
electrical system	50
engine	51

INDEX

E—Cont'd		Page No.			Page No.
Engine			removal		170
oil pump—Cont'd			wheel alinement		
installation	98		adjust toe-in	166	
removal	95		measure toe-in	166	
removal	101		Fuel system		
tabulated data	89		accelerator pedal		
tune-up			installation	120	
description	90		removal	120	
valve chamber cover and gasket			carburetor		
installation	92		adjustment and maintenance ..	113	
removal	92		description	111	
valve tappet adjustment			installation	114	
adjust clearance	93		removal	113	
lock adjustment	93		choke control		
remove valve covers	93		installation	120	
stop engine	93		removal	120	
warm up engine	92		controls and linkage	120	
Exhaust system			description	111	
description	121		fuel filter		
pipe and muffler			description	117	
installation	124		filter element installation	118	
removal	123		filter element removal	118	
			service	118	
F			fuel pump		
First echelon preventive maintenance service			description	115	
after-operation and weekly service			diaphragm installation	116	
procedures	31		diaphragm removal	116	
at-halt service			installation	116	
procedures	29		maintenance	115	
before-operation service			removal	116	
procedures	26		fuel tank		
during-operation service			cleaning	119	
procedures	28		description	118	
purpose	25		installation	119	
Frame, body and	220		removal	118	
Front axle			governor		
axle assembly			description	111	
installation	169		installation	111	
removal	169		removal	111	
description	166		lines and connections		
spindle assembly			description	120	
installation	172		installation	120	
removal	171		removal	120	
steering knuckle arm			tabulated data	111	
installation	170		throttle control		
removal	170		installation	120	
tabulated data	166		removal	120	
tie rod assembly			H		
installation	171		Hoist		
			body service		
			body and subframe	230	

2½-TON 4 x 2 TRUCK (FEDERAL)

H—Cont'd	Page No.		Page No.
Hoist		installation	150
body service—Cont'd		removal	150
drive shaft	231	testing	150
hoist	231	ignition switch	
pump	231	installation	152
controls and linkage	231	removal	152
cylinder assembly		ignition timing	
installation	234	spark plug data	140
lubrication	233	timing distributor	138
removal	233	ignition wiring	
description		description	150
basic body	226	installation	152
hoist	227	removal	150
pump	230	spark plugs	
drive shaft assembly		description	148
installation	235	installation	148
removal	235	removal	148
hoist control bell crank (Galion)		service	148
installation	232	tabulated data	138
removal	232	Instruments, gages, and switches *	
hoist control lever		ammeter	
installation	232	installation	247
removal	231	removal	247
hoist control rods		blackout driving light switch	
installation	232	installation	251
removal	232	removal	251
hoist valve lever		circuit breakers	
installation	232	horn circuit breaker installa-	
removal	232	tion	252
pump assembly		horn circuit breaker removal ..	252
installation	235	main light switch circuit	
removal	235	breaker installation	252
		main light switch circuit	
		breaker removal	252
		fuel gage	
		installation	247
		removal	247
		horn	
		installation	252
		removal	252
		ignition switch	
		installation	252
		removal	251
		main light switch	
		installation	251
		removal	251
		oil pressure gage	
		installation	250
		removal	250
		panel light switch	
		installation	251
Ignition system			
description	138		
distributor assembly			
description	144		
installation	145		
maintenance and service	145		
removal	145		
distributor condenser			
description	144		
inspection and test	144		
installation	144		
removal	144		
distributor points			
breaker point adjustment	142		
installation	144		
removal	144		
ignition coil			
description	148		

INDEX

I—Cont'd	Page No.		Page No.
Instruments, gages, and switches		electrical systems	20
panel light switch—Cont'd		gasoline	18
removal	251	lubrication	18
speedometer		protection of cooling systems	19
installation	250	purpose	18
removal	250	starting and operating engine	22
speedometer shaft		storing and handling gasoline	18
installation	250	flood	24
removal	250	hot weather operation	
temperature gage		air cleaners	23
installation	250	battery	23
removal	250	cooling system maintenance	23
Intake system		general	23
air cleaner		oil filter	23
installation	122	operating vehicle	24
removal	122	mud	24
service	122	poisonous gas	24
description	121	sand	24
		snow and ice	24
L		Organization tools and equipment	
Lighting system	236	special tool set	73
Lubrication		standard tool sets	73
introduction	35	P	
lubrication guide		Preventive maintenance service	
general	35	first echelon	25
localized views	40	second echelon	55
lubrication notes	35	Propeller shaft	
reports and records	40	center bearing	
supplies	35	installation	165
M		removal	165
Maintenance allocation		description	163
allocation of maintenance	47	front propeller shaft with center	
scope	47	bearing	
Maintenance road test chart	57	installation	164
Manual, scope of	3	removal	164
O		propeller shafts and universal	
Operation controls	11	joints	
Operation of vehicle		installation (rear)	164
driving vehicle	14	removal (rear)	164
starting engine	13	tabulated data	163
stopping vehicle	15	Power take-off	
towing vehicle		case	
disabled vehicle	17	installation	253
to start engine	17	removal	253
Operation under unusual conditions		controls and linkage	
cold weather operation		installation	254
antifreeze compound chart	20	removal	254
chassis	22	description	253
		tabulated data (Galion)	253

2½-TON 4 x 2 TRUCK (FEDERAL)

	Page No.		Page No.
Rear axle		Shock absorbers and springs.....	210
axle assembly		Springs and shock absorbers	
installation	173	description	210
removal	173	shackle and pin	
axle drive shaft		installation	211
installation	176	removal	211
removal	175	shock absorber	
description	173	installation	213
tabulated data	173	removal	212
References		shock absorber linkage	
explanatory publications		installation	214
automotive materiel	260	removal	213
care and preservation	261	spring assembly	
decontamination	261	installation	212
storage and shipment	261	removal	212
standard nomenclature lists	260	tabulated data	211
Road test chart (maintenance)....	57	Starting and generating systems	
		cranking motor	
S		description	158
Scope of manual	3	installation	158
Second echelon preventive maintenance service		removal	158
first echelon participation.....	55	cranking motor switch	
frequency	55	installation	158
general procedures	55	removal	158
road test chart	57	description	153
special services	56	generator assembly	
specific procedures	57	belt tension adjustment	157
Shipment and temporary storage		description	156
facilities for loading	257	installation	157
general instructions	255	removal	157
inspections in limited storage....	257	testing	156
loading and blocking for rail shipment		generator regulator	
battery	257	description	153
brakes	257	failure in operation	153
exterior	257	installation	155
tires	257	removal	155
preparation for temporary storage or domestic shipment		testing	153
battery	255	tabulated data	153
brakes	256	Steering gear	
cooling system	255	adjustment	
engine	256	description	217
exterior of vehicle	256	procedure	217
fuel in tanks	256	description	216
inspection	256	drag link	
lubrication	255	installation	217
road test	255	lubrication	217
tires	255	removal	217
securing vehicles	257	pitman arm	
		installation	217
		removal	217

INDEX

S—Cont'd		Page No.			Page No.
Steering gear—Cont'd			front axle		
steering gear assembly			excessive or uneven tire wear.		81
installation	219		front axle wander		81
removal	218		steering difficulty		81
tabulated data	217		wheel pounding		82
T			fuel		
Tools and equipment stowage on vehicle			engine "stumbles" on acceleration		77
equipment	45		engine will not idle		77
tools	45		excessive fuel consumption		76
Transmission			fast idling		77
description	159		low fuel pressure		77
installation	161		hoist		
removal	159		body settling from raised position		87
tabulated data	159		lifting speed too slow		86
Trouble shooting			ignition		
battery and lights			failure to start		79
discharged battery	87		hard starting		78
failure to start	87		instruments		
lights burn dim	87		incorrect reading or failure		87
slow cranking motor speed	87		intake and exhaust system		
too high generator charging rate	87		excessive fuel consumption		78
body and frame			excessive noisy exhaust		78
difficult steering	86		exhaust fumes in cab		78
excessive jolting of cab	86		pronounced rattle under body		78
excessive tire wear	86		power take-off		
clutch			noisy operation		88
grabbing	76		propeller shaft		
improper action of controls	76		excessive noise and vibration		81
improper release	76		rear axle		
slipping	76		axle noises, driving and coasting		82
cooling system			axle noises, pulling only		82
loss of coolant liquid	78		axle noises, when coasting only		82
overcooling	78		excessive backlash		82
overheating	78		grease leakage		82
engine			service and hand brakes		
dull, heavy thump	75		all brakes drag		84
engine overheating	74		excessive pedal pressure and poor stop		82
excessive oil consumption	75		hand brake fails to hold vehicle		84
hissing sound	76		noisy brakes		83
lack of power	74		one brake drags		84
light clicking	75		pedal goes to floor board		83
light rattling noise	75		severe brake with light pedal pressure		84
loud knock	75		springy, spongy pedal action		83
low oil pressure	75		truck pulls to one side		83
popping, spitting, and spark knock	75		springs and shock absorbers		
squealing sound	75		excessive noise		85

2½-TON 4 x 2 TRUCK (FEDERAL)

T—Cont'd	Page No.		Page No.
Trouble shooting		front hub and drum assembly	
springs and shock absorbers—		installation	199
Cont'd		removal	199
hard riding	85	front wheels	
starting and generating systems		installation of wheel and tire..	202
discharged battery	79	removal of wheel and tire....	202
low generator charging rate...	79	rear hub and drum assembly	
slow starter speed	79	installation	201
too high generator charging		removal	200
rate	80	rear wheel grease retainer	
steering		installation	207
hard steering	85	removal	207
road shock transmitted to steer-		tire chains	
ing wheel	86	installation	209
unequal turning radius to right		removal	209
and left	86	usage	209
wander or lack of steering con-		rear wheels	
trol	86	installation of wheel and tire.	203
transmission		removal of wheel and tire....	202
jumping out of gear	80	wheel bearings	
loss of transmission lubricant.	80	front wheel bearing	
noise	80	adjustment	204
wheels and hubs		installation	205
excessive or uneven tire wear.	84	removal	205
steering difficulty	85	rear wheel bearing	
W		adjustment	205
Wheels, hubs, and wheel bearings		installation	206
description		removal	205
hubs and drums	199		
wheels	199		

[A.G. 062.11 (2 April 1943)]

BY ORDER OF THE SECRETARY OF WAR:

G. C. MARSHALL,

Chief of Staff.

OFFICIAL:

J. A. ULIO,

*Major General,**The Adjutant General.*

DISTRIBUTION: R9 (4); Bn9 (2); C9 (8)

(For explanation of symbols, see FM 21-6)