

TM 9-740

WAR DEPARTMENT

TECHNICAL MANUAL



ARMORED CAR T17

NOVEMBER 2, 1942

DECLASSIFIED BY
AUTHORITY OF DOD DIR. 5200.1 R
BY RAKUS ON 112304



TECHNICAL MANUAL }
No. 9-740

WAR DEPARTMENT,
Washington, Nov. 2, 1942

ARMORED CAR T17

Prepared under the direction of the
Chief of Ordnance
(with the cooperation of the Ford Motor Company)

CONTENTS

PART I—OPERATING INSTRUCTIONS

	Paragraphs	Pages
SECTION: I: Introduction	1-5	2-8
II: Operation and controls	6-12	9-20
III: Lubrication Instructions	13-16	21-25
IV: Preventive maintenance and inspec- tions	17-22	26-35
V: Care and preservation	23-24	36
VI: Painting	25-30	37-39
VII: Materiel affected by gas	31-34	40-42
VIII: Armament	35-37	43-46

PART II—ORGANIZATION INSTRUCTIONS

IX: Organization maintenance	38	47
X: Engines	39-44	48-55
XI: Fuel system	45-50	56-59
XII: Cooling system	51-55	60-63
XIII: Electrical system	56-66	64-76
XIV: Propeller shafts	67-68	77
XV: Transmission and clutch	69-71	78-80
XVI: Transfer case	72-73	81-82
XVII: Bogie and axles	74-76	83-84
XVIII: Steering gear	77-78	85
XIX: Brakes	79-80	86-87
XX: Fire extinguishers	81-84	88-90
XXI: References	85-86	91
INDEX		92-97

ARMORED CAR T17

PART I — OPERATING INSTRUCTIONS

Section I

INTRODUCTION

	Paragraph
Purpose and scope	1
Content and arrangement of the manual.....	2
References	3
Description	4
Tabulated data	5

1. PURPOSE AND SCOPE.

a. TM 9-740, dated November 2, 1942, is intended to serve temporarily (pending the publication of a revision now in preparation which will be wider in scope) to give information and guidance to the personnel of the using arms charged with the operation and maintenance of this materiel.

2. CONTENT AND ARRANGEMENT OF THE MANUAL.

a. Sections I through VIII contain information chiefly for the guidance of operating personnel. Sections IX through XX contain information intended chiefly for the guidance of personnel doing maintenance work.

3. REFERENCES.

a. Section XXI lists all Standard Nomenclature Lists, Technical Manuals, and other publications for the materiel described herein.

4. DESCRIPTION (figs. 1 and 2).

a. The Armored Car T17 is an armored, six-wheeled (6 x 6) vehicle powered by two Hercules (JXD) engines. The engines are located in the rear of the hull. The operator steers the vehicle by means of a hydraulic power-operated steering gear with the conventional type steering wheel. The vehicle has eight forward speeds and two reverse speeds. The armored car is wired for radio installation and for inter-phone system within the armored car.

b. The turret armor is 1 1/4-inches thick on the sides and 3/4-inch thick on the top. The armor on the sides of the hull is 3/4-inch thick (plate) and 3/4-inch thick (cast) on the front slope. The top of the hull is

INTRODUCTION

RA PD 27447

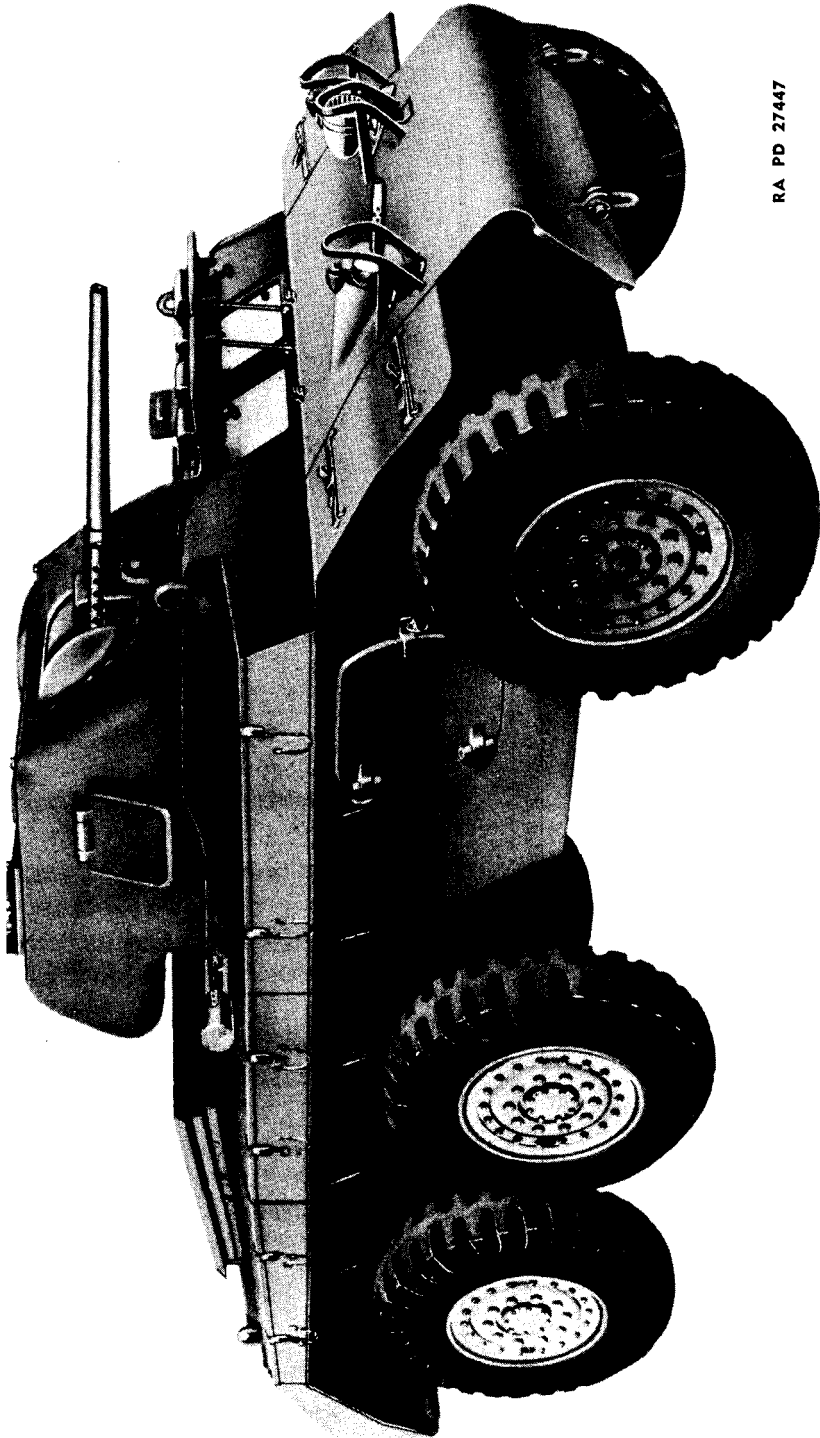
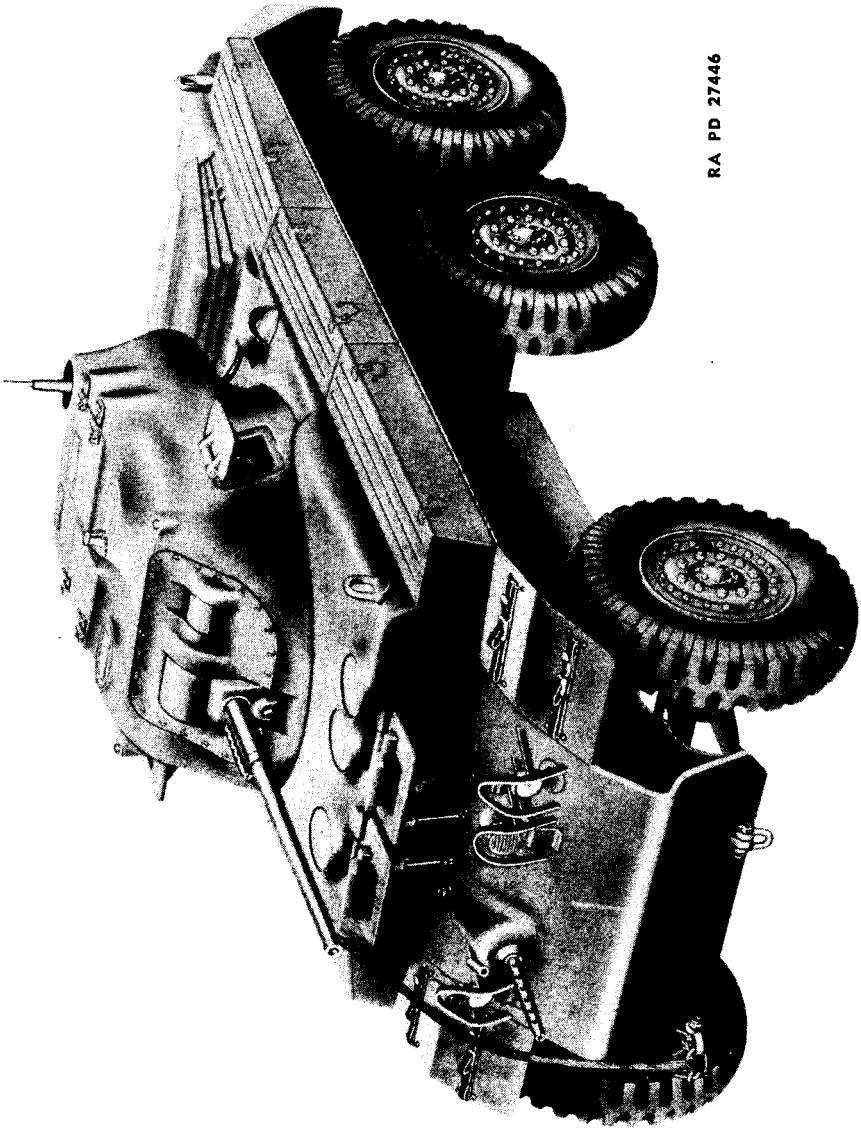

Figure 1 — Right Front View of Armored Car T17

ARMORED CAR T17



RA PD 27446

Figure 2 — Armored Car T17 from Above

INTRODUCTION

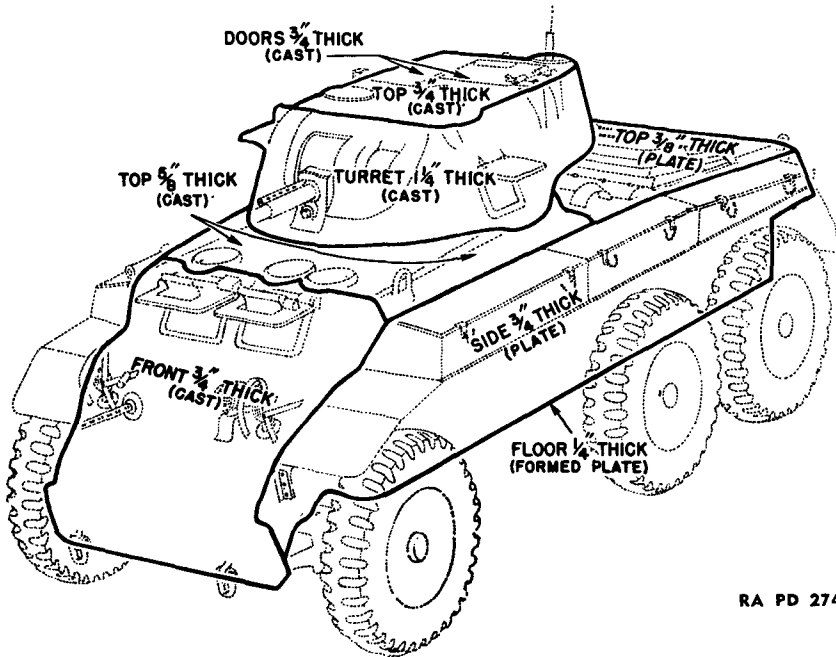

RA PD 27448

Figure 3 — Armor Thickness

5/8-inch thick cast armor. The floor (die-formed) is 1/4-inch thick and the engine compartment covers are 3/8-inch thick.

c. The turret can be rotated 360 degrees by a hydraulic system or by hand. The turret platform (basket) rotates with the turret.

5. TABULATED DATA.

a. General.

Length over-all (approximate)	218 in.
Width over-all (approximate)	102 in.
Height over-all (approximate)	91 in.
Gross weight (approximate)	31,000 lb
Ground pressure, pounds per square inch (hard road zero penetration)	70 lb
Ground pressure per square inch, with 4-inch penetration....	17.7 lb
Ground pressure per square inch, with 8-inch penetration....	12.4 lb
Area of contact per tire (hard road zero penetration).....	78 sq. in.
Load distribution:	
Front axle (approximate)	11,000 lb
Rear axle and intermediate axle, each (approximate)....	10,000 lb
Wheel base:	
Front to intermediate axle	96 in.
Front to rear axle	147 in.

ARMORED CAR T17

Thread:

Front and rear	86 in.
Turning radius	30 ft
Clearance under axle	13½ in.

b. Engines. (Hercules, model JXD (two))

Bore and stroke	4 x 4¼ in.
Number of cylinders, each engine	6
Developed horsepower, each engine	110
Piston displacement each engine, cubic inch.....	320
Firing order	1-5-3-6-2-4

c. Armament.

- 1 GUN, 37-mm, M6 (M24 combination turret mount)
- 1 GUN, machine, cal. .30, M1919A4 (combination turret mount)
- 1 GUN, machine, cal. .30, M1919A4 (flexible ball mount in front plate)
- 1 GUN, submachine, cal. .45, Thompson M1928A1 (carried in brackets within vehicle)
- 1 MOUNT, tripod, machine gun M1928A1, cal. .30, M2

d. Protected Vision. Protected vision is provided for the driver and assistant driver by the use of steel shutters (open and shut type) at vision slots, and by indirect vision devices called periscopes. There are seven periscopes on the Armored Car T17. The periscope for the gunner is telescope-equipped. The remaining six periscopes are of the plain-vision type.

e. Seats. An adjustable padded, chair-type seat, equipped with a safety belt, is provided for the gunner. Round, padded seats, equipped with safety belts and of the snap-down type, are provided for the loader and vehicle commander. A padded, farm-machinery type seat equipped with a padded back is provided for the driver. The same type seat, except with a removable back, is provided for the assistant driver. These are equipped with safety belts.

f. Protective Padding. Parts of the interior are padded to protect the crew from injury.

g. Communication.

- | | |
|--------------------|--|
| (1) Radio..... | } SCR 508 sending and receiving
Voice 15-25 miles
Code 30-45 miles |
| (2) Telephone..... | |
| Intracar. | |

INTRODUCTION

h. Armor Thickness (fig. 3).

Hull front slope	3/4 in.
Hull top	5/8 in.
Hull sides	3/4 in.
Hull bottom (die-formed)	1/4 in.
Turret sides	1 1/4 in.
Turret top	3/4 in.
Turret (cast armor plate).....	360 deg traverse

i. Fuel and Oil.

Fuel capacity	75 gal
No. miles without refueling.....	{ cross country 50 to 300 miles highway 300 to 400 miles
Octane rating of fuel.....	70 or higher
Engine oil capacity (each engine, use bayonet gage).....	7 qt
Lubricants	See Lubrication Guide

j. Performance.

Maximum sustained speed on hard road.....	50 mph
Maximum safe speed, down grade.....	60 mph
Expected cross country speeds for various terrains.....	4 to 60 mph
Minimum engine idling speed.....	500 rpm

k. Maximum Allowable Speeds: The engines of the Armored Car T17 are not governed, and it is each driver's responsibility to see that the engines are not abused by high engine speeds, particularly in the lower gears. The following are the maximum speeds allowable and are not to be exceeded:

Maximum allowable speeds with transfer case in low ratio:

First and reverse gears.....	4 mph
Second gear	8 mph
Third gear	18 mph
High gear	32 mph

Maximum allowable speeds with transfer case in high ratio:

First and reverse gears.....	8 mph
Second gear	16 mph
Third gear	32 mph
High gear	60 mph

Maximum grade ascending ability (approximate)..... 60 percent

Maximum fording depth (approximate) (at slowest forward speed)

	32 in.
--	--------

l. Crew.

	5 men
--	-------

ARMORED CAR T17

m. Tires.

Type	Combat
Size	12.00 x 20
Plies	16
Inflation pressure	80-lb
Capacity per tire (80-lb inflation).....	5,475-lb
Revolutions per mile.....	469
Rolling radius, inflated.....	21.5 in.
Loaded rolling radius with zero inflation.....	19.5 in.
Tread design	Mud and snow

Section II

OPERATION AND CONTROLS

	Paragraph
General information on controls.....	6
Prestarting inspection	7
Starting instructions	8
Engine test	9
Operating the vehicle.....	10
Towing	11
Stopping the engines	12

6. GENERAL INFORMATION ON CONTROLS.

a. Instrument Panel. The instrument panel is located directly in front of the driver and consists of the following items. (In the following descriptions where two identical units are provided, in each case the one to the left is for the left-hand engine and the one to the right is for the right-hand engine. In all instances throughout this book "Left" or "Right" is as viewed from the rear of the armored car when facing the same direction as the car is headed.)

(1) **BLACKOUT DRIVING LIGHT SWITCH (A, fig. 4).** The blackout driving light may be used to supply illumination for driving when reflections from the service driving lights might reveal the position of the vehicle. First, remove both service headlamps from their sockets at the front of the car and then insert the blackout driving lamp in the left front lamp socket. To turn on the blackout driving light, pull out the master light switch to first position and pull out the blackout driving light switch button. The blackout head lamps, marker lamps, tail lamps and stop light (when the brake pedal is depressed) will also be on with switches in this position. **CAUTION:** Under battle conditions use the blackout driving light intermittently and only when absolutely necessary for safe vision.

(2) **LIGHT SWITCH (B, fig. 4).** The knob on the instrument panel marked "LIGHTS" controls the service lights and the blackout driving lights. A spring-operated safety button prevents the knob from being accidentally pulled out beyond the blackout position. To release, push button in with thumb, at the same time continuing outward pull on knob with first and second fingers. In addition to "OFF," the switch has three positions, controlling lights as follows:

ARMORED CAR T17

Light Switch Position	Lights Operating	Location
BLACKOUT (1st position)	Blackout marker lights	Top of right and left headlights
	Blackout taillights	Lower section right and left taillights
	Blackout stop light (when brake pedal is depressed)	Upper section, right-hand taillight
SERVICE (2nd position)	Service headlights	Right and left headlights
	Service stop light (when brake pedal is depressed)	Upper section, left-hand taillight
	Service taillight	Upper section, left-hand taillight
STOP LIGHT (3rd position)	Service stop light (when brake pedal is depressed)	Upper section, left-hand taillight

(3) **IGNITION SWITCH (C, fig. 4)**. A four-position ignition switch is provided on the instrument panel. With this switch in the "BOTH" position the ignition circuits for both engines are complete, or in the "OFF" position the ignition circuits for both engines are broken. In either the "R" (right) or "L" (left) position, the ignition circuit to that particular engine only is completed.

(4) **FUEL LEVEL GAGE (D, fig. 4)**. An electrically operated fuel level gage is provided on the instrument panel and indicates the level of the fuel in the tank.

(5) **INSTRUMENT PANEL LIGHTS (E, fig. 4)**. Three instrument panel lights are used to provide illumination for the various gages. Each of the three lights is covered with a round, pronged button-light cover that is pried out to gain access to the bulb. The instrument panel lights are turned on or off and the degree of illumination is controlled by the five-position rheostat (X, fig. 4), located at the lower left of the panel.

(6) **AMMETER (F, fig. 4)**. The ammeter is provided with a range of 100-ampere discharge to 100-ampere charge. If during normal operations and when little current is being used, the ammeter consistently indicates discharge, one of the generator regulators is not functioning properly or one of the generators is at fault. In either case, the batteries

OPERATION AND CONTROLS

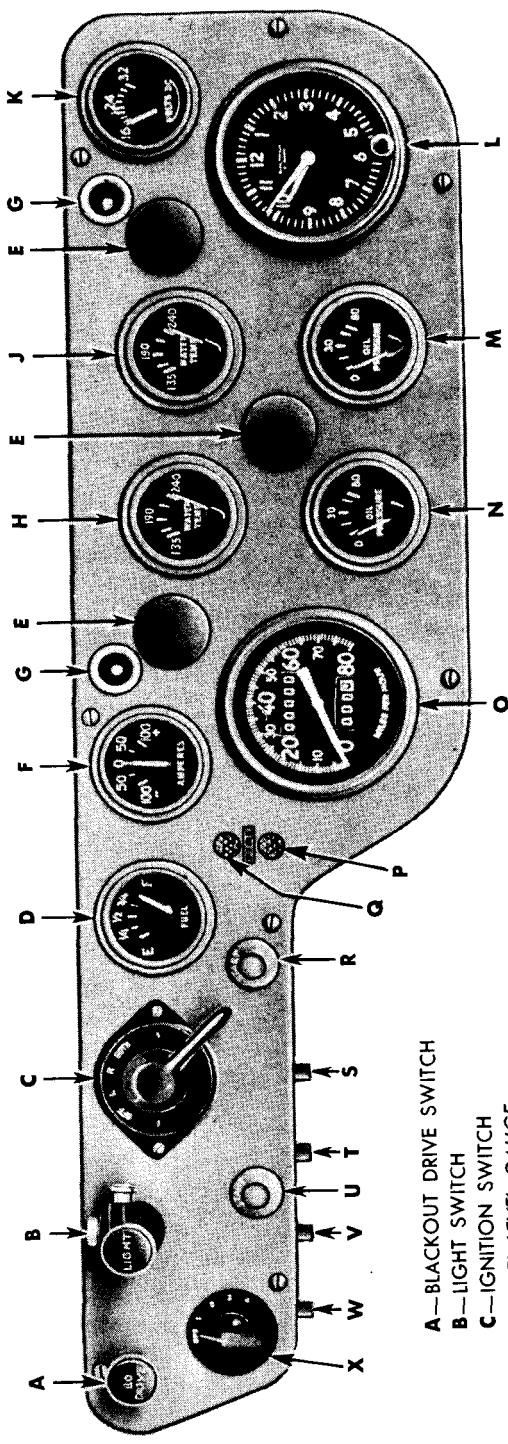

- A—BLACKOUT DRIVE SWITCH
- B—LIGHT SWITCH
- C—IGNITION SWITCH
- D—FUEL LEVEL GAUGE
- E—INSTRUMENT PANEL LIGHTS (4)
- F—AMMETER (100-0-100)
- G—UTILITY SOCKETS (2)
- H—WATER TEMPERATURE GAUGE LEFT-HAND ENGINE
- J—WATER TEMPERATURE GAUGE RIGHT-HAND ENGINE
- K—VOLTMETER (16-32)
- L—CLOCK
- M—OIL PRESSURE GAUGE RIGHT-HAND ENGINE
- N—OIL PRESSURE GAUGE LEFT-HAND ENGINE
- O—SPEEDOMETER
- P—FIRE DETECTOR SIGNAL (RED)
- Q—FIRE DETECTOR PILOT LIGHT (GREEN)
- R—STARTER BUTTON RIGHT-HAND ENGINE
- S—CIRCUIT BREAKER
- T—CIRCUIT BREAKER
- U—STARTER BUTTON LEFT-HAND ENGINE
- V—CIRCUIT BREAKER
- W—CIRCUIT BREAKER
- X—PANEL LIGHT RHEOSTAT

RA PD 27442

Figure 4 — Instrument Panel

ARMORED CAR T17

are not being charged and will quickly discharge. Check these units frequently to prevent failure during operation. Even when no electrical energy is being used, the ammeter should never go above 100 amperes. If the ammeter indicates more than 100-ampere charge, the current limiting unit in one or both of the generator regulators is at fault. Therefore, replace the regulator to prevent damage to the generator.

(7) **UTILITY SOCKETS (G, fig. 4).** Two utility sockets that permit plugging in trouble light, etc., are provided at the top of the instrument panel.

(8) **ENGINE TEMPERATURE GAGES (H and J, fig. 4).** Two engine temperature gages are provided. The left-hand gage is for the left-hand engine and the right-hand gage is for the right-hand engine. These gages are calibrated from 135 to 240 degrees. Under maximum power on a level hard surface the temperature of either engine should not be greater than 90 degrees above atmospheric temperature. If one engine consistently runs hotter than the other, this fact should be reported to ordnance maintenance personnel. It is to be expected, however, that the left-hand engine will run hotter than the right-hand engine, since it will pick up some heat from the exhaust manifold of the right-hand engine which is located between the two engines.

(9) **VOLTMETER (K, fig. 4).** A voltmeter, having a range from 16 to 32 volts, is provided on the instrument panel. When the ignition switch is "OFF" the voltmeter will read below 16. When the ignition is "ON" the voltmeter should read battery voltage (approximately 24 volts). If the reading is low when the engine is running and no electric energy is being used, the batteries are low in charge and must be recharged. At normal operating speeds during normal temperatures, the voltage should not exceed 30 volts. If the reading is greater than this, one or both of the generator regulators is not properly limiting the voltage and must be replaced in order to prevent damage to the generator.

(10) **CLOCK (L, fig. 4).** An 8-day clock is located at the lower right of the instrument panel. A reset and rewinding knob is located on the bottom of the dial. (To reset the clock, push the knob in and turn.)

(11) **OIL PRESSURE GAGES (M and N, fig. 4).** Two oil pressure gages are located on the instrument panel (one for each engine). The left-hand gage indicates the pressure for the left-hand engine and the right-hand gage indicates the pressure for the right-hand engine. Oil pressure under normal conditions is between 20 and 25 pounds. If during operation the oil pressure suddenly drops off, immediately stop the engine involved. This fault may be due to low oil level. If the oil pressure drops off slowly, it may be due to a change in the viscosity of the oil due to overheating. Check the engine temperatures. If the

OPERATION AND CONTROLS

oil pressure drops to, or fails to raise above, 15 pounds when the oil viscosity and level is known to be correct, operate the engine at reduced speeds until engine can be replaced or other corrections made.

(12) **SPEEDOMETER (O, fig. 4).** The speedometer is located to the left of the oil pressure gages on the instrument panel and is equipped with a trip mileage reset.

(13) **FIRE DETECTOR.** The two jewel-type lights on the instrument panel (P and Q, fig. 4) give warning of fire in the engine compartment. The fire detector consists of a 32-candlepower bulb located behind the red jewel (Q, fig. 4) connected in series with a 3-candlepower bulb behind the green jewel (P, fig. 4). The resistance of the 3-candlepower bulb is so great that sufficient current to light up the 32-candlepower bulb cannot pass through the circuit, with the result that only the green pilot light (3-candlepower) lights up. The wire connecting these two bulbs runs back to the engine compartment where several thermal switches will cause it to be grounded in case of fire. The grounding of this wire provides a path for the current parallel to the 3-candlepower bulb, with the result that the green light goes out and the red light goes on, thus giving a warning of the fire.

(14) **STARTER SWITCHES (R and U, fig. 4).** Two starter switch buttons are provided on the instrument panel. When pushed in, these buttons complete the circuit through the starter switch solenoids, causing the starter to crank the engine. The starter button to the left is for the left-hand engine and the starter button to the right is for the right-hand engine. Start one engine at a time in cold weather.

(15) **CIRCUIT BREAKERS (S, T, V, W, fig. 4).** Four circuit breaker buttons are provided on the under edge of the instrument panel at the left end of the panel, and control the four circuit breakers which take the place of the conventional fuses. In each instance, when these circuits are overloaded the circuit breaker will open. The circuit involved is then closed by pressing the correct button. The circuits controlled by the four buttons are as follows:

- (a) One circuit breaker (S, fig. 4) controls the utility sockets circuit.
- (b) A second circuit breaker (T, fig. 4) controls the siren circuit.
- (c) A third circuit breaker (V, fig. 4) controls the circuits for the various electrically operated instruments.
- (d) A fourth circuit breaker (W, fig. 4) controls the light circuit.

(16) **INSTRUMENT PANEL LIGHT RHEOSTAT SWITCH (X, fig. 4).** A five-position switch is used to turn the panel lights on or off. When the pointer is turned all the way counterclockwise the lights are "OFF." In any of the other four positions the lights are "ON" in different intensities.

ARMORED CAR T17

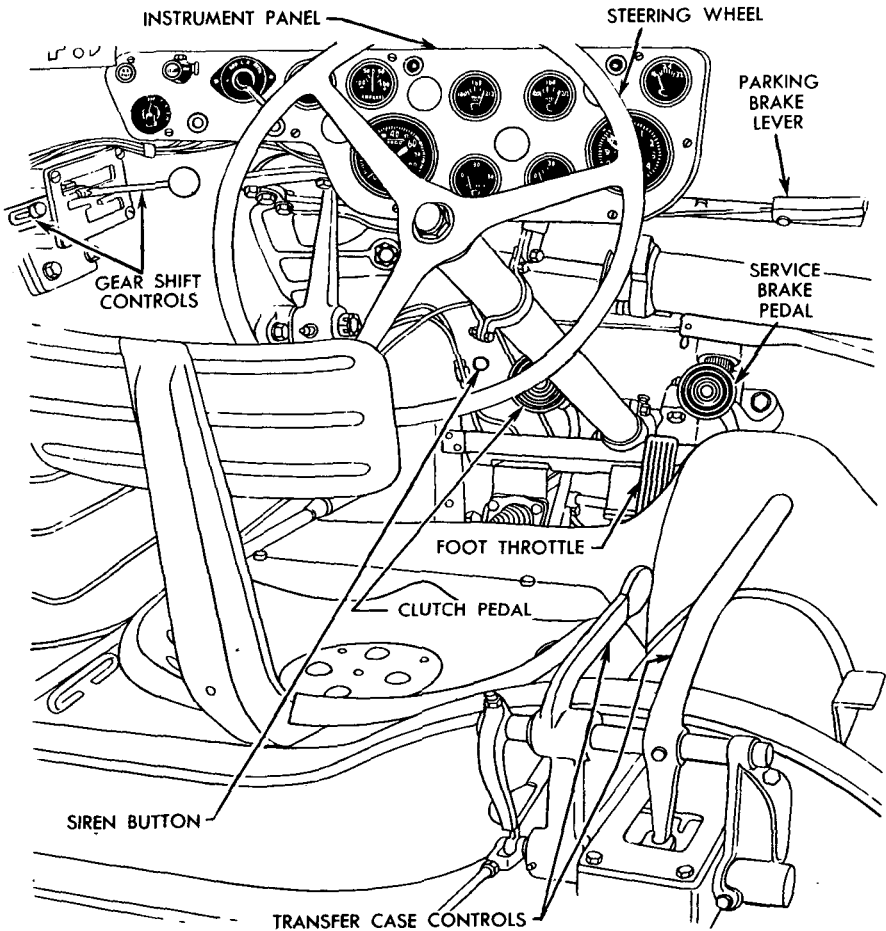

RA PD 27443

Figure 5 — Driver's Compartment

b. Controls. The various controls used by the driver (fig. 5) consist of the following:

(1) **BRAKES.**

(a) *Service Brakes.* Two shoe-hydraulic brakes are provided at each of the six wheels and are operated by the conventional foot pedal. The pressure applied to the pedal is amplified through a Hydrovac booster system. The pressure applied to the shoes, while much higher than that applied to the pedal, is, however, increased or decreased as the pedal pressure is increased or decreased, allowing smooth control for whatever kind of stop is desired.

(b) *Parking Brake Lever.* The parking brake lever is horizontally mounted directly in front of the driver, behind the instrument panel

OPERATION AND CONTROLS

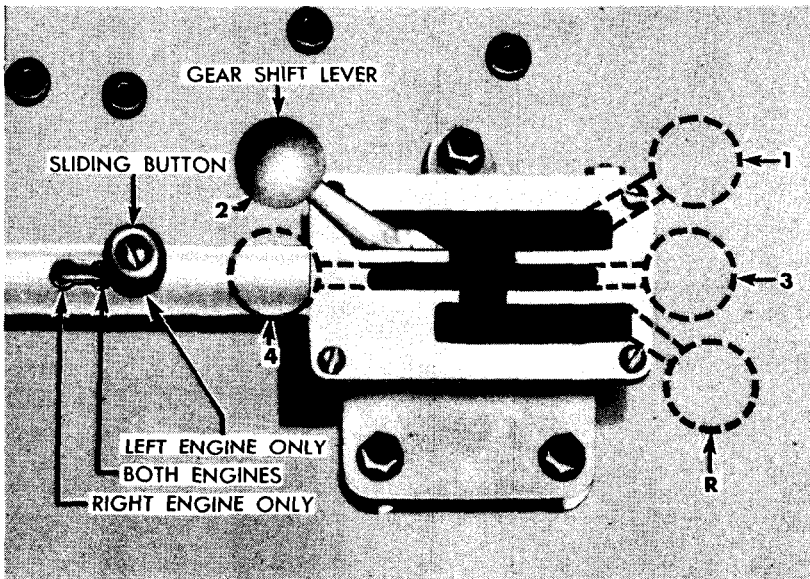

RA PD 27441

Figure 6 — Gearshift Lever Positions

(fig. 5). Always be sure the parking brake is released before moving the car.

(2) **SPARK CONTROL.** The spark control is entirely automatic and requires no attention by the operator of the vehicle.

(3) **THROTTLE CONTROLS.** A foot throttle pedal is located on the floor in front of the driver's seat to the left of the brake pedal, convenient to the driver's right foot (fig. 5).

(4) **STEERING WHEEL.** The conventional automotive-type steering wheel is used. However, the steering gear is assisted by a hydraulic booster as outlined in section XVIII.

(5) **CLUTCH PEDAL.** The clutch pedal is located on the floor in front of the driver's seat, convenient to the driver's left foot. To permit shifting of gears, the clutches of both engines are disengaged by depressing the clutch pedal. The pressure applied to the pedal is amplified or boosted by a Hydrovac cylinder.

(6) **SIREN BUTTON.** A siren button is located on the floor to the left of the clutch pedal.

(7) **GEAR SHIFTING** (figs. 6 and 7).

(a) *Description.* The transfer case controls consist of two levers

ARMORED CAR T17

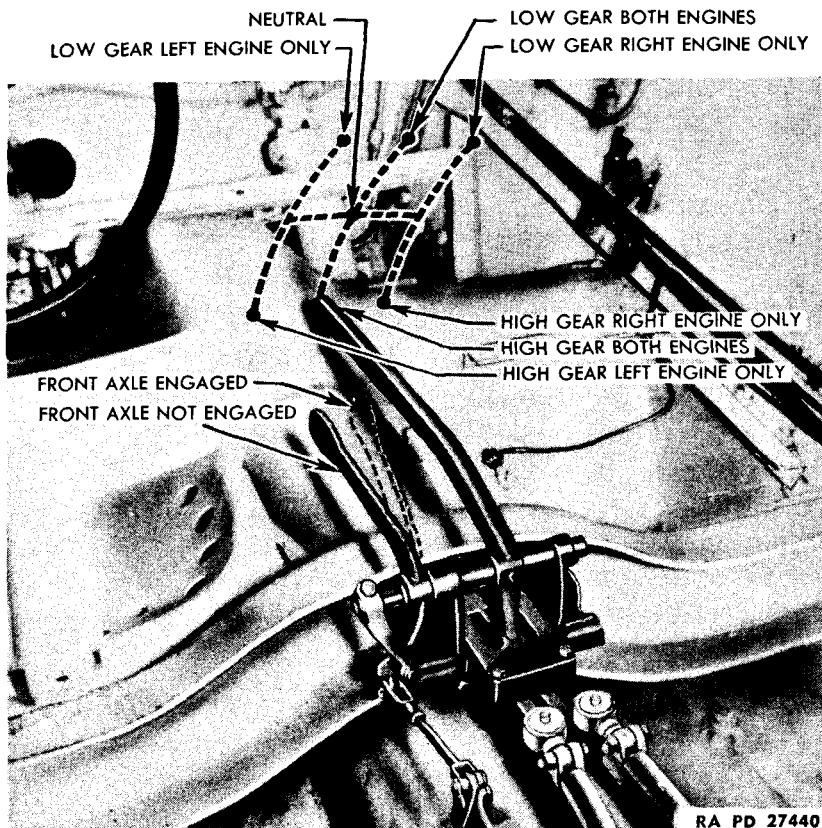

Figure 7 — Transfer Case Controls

(fig. 7). The transmission controls consist of a shifter lever and a sliding button (fig. 6).

1. *The gearshift lever* is located on the hull to the left of the driver. The vertical movement of the lever selects the correct rail in both of the transmission shifter housings, and the horizontal movement of the lever engages the correct gears. The horizontal movement of the gearshift lever operates a piston valve which causes the vacuum cylinder to assist the actual shifting of the gears (fig. 34).

2. *Sliding button* (fig. 6). By means of the sliding button just back of the gearshift lever, either transmission can be disconnected from the shift mechanism and kept in neutral. When this button is in the center position, the shift mechanism is engaged at both transmissions (fig. 34). With the gearshift lever in neutral and when this button is pulled back, it disconnects the shift mechanism for the left-hand engine, and the left-hand engine transmission will stay in neutral regardless of any

OPERATION AND CONTROLS

subsequent position of the gearshift lever. With the gearshift lever in neutral and when this button is pushed to the forward position, it disconnects the shift mechanism from the right-hand engine, and the right-hand transmission will stay in neutral. The shifting of the sliding button is a two-hand operation, as it is necessary to hold the gearshift lever in neutral while the sliding button is being moved. It is necessary to declutch and have both transmissions in neutral in order to engage or disengage the shift mechanism from either transmission. When operating on one engine only, it is necessary to declutch the drive line from the opposite engine at the transfer case. (See the following paragraph.)

3. *Transfer Case Controls* (fig. 7). The transfer case controls consist of two levers located to the right of the driver.

a. The short lever (nearest the driver, fig. 7) engages the front axle in the "UP" position and disengages the front axle when in the "DOWN" or forward position. The front axle must be engaged while the vehicle is moving slowly. In all instances, when shifting from high range to low range, reduce the speed of the vehicle to below five miles per hour before making the shift. Always engage the front axle before putting the transfer case in low ratio.

b. The long lever (farthest from the driver, fig. 7) can be moved both crosswise and up and down. In any down position, the transfer case is in high gear. In all up positions, the transfer case is in low gear. In the center position and either up or down, the drive lines from both engines are engaged at the transfer case. With this lever to the left (either up or down) only the left-hand engine is engaged, or when to the right (either up or down) only the right-hand engine is engaged at the transfer case. When the engine drive line is disengaged at the transfer case by means of this lever (with the engine stopped), that engine must be placed in neutral at the transmission.

7. PRESTARTING INSPECTION.

a. Before the engines are started follow procedure outlined under "Prestarting Inspection" (par. 18).

8. STARTING INSTRUCTIONS.

a. Before attempting to start the engine, familiarize yourself with all of the various instruments and controls (par. 6). Make sure that the function of each control is thoroughly understood and that the significance of the readings on the various instruments is appreciated.

b. Put gearshift lever in neutral.

c. Make sure transfer case control levers are in desired position.

d. Have sliding button (to rear of gearshift lever) in center position.

ARMORED CAR T17

- e. Depress clutch pedal.
- f. Turn ignition switch to "BOTH" position.
- g. Press both starter buttons, one at a time.
- h. Engine should start readily.

9. ENGINE TEST.

a. As soon as the engine starts, check oil pressure. Stop the engines if normal oil pressure is not indicated within 30 seconds.

b. Check the operation of instruments and switches while the engine is idling. Idle engine until engine temperature gage reads about 135 degrees.

c. When engines are sufficiently warm set the ignition switch at the "L" position. This will stop the right-hand engine, permit checking for any unusual noises from the left-hand engine, and make it easier to hear any unevenness or missing cylinders.

d. Turn the ignition switch to the "R" position and restart the right-hand engine to note any unevenness or unusual sounds.

e. Turn the ignition switch to "BOTH" position and start left engine. (If correctly set, the carburetor idle speed adjusting screws (fig. 18) will permit the engine to idle at 500 revolutions per minute after warming up.) Never idle the engine at less than 500 revolutions per minute.

f. Never lug engines at wide-open throttle below one third of the maximum speed allowable for whatever gear ratio is being used (par. 5 k). Shift to a lower gear.

g. Check oil pressure and temperature frequently.

10. OPERATING THE VEHICLE.

a. Before attempting to drive the vehicle, the prospective driver should be thoroughly familiar with all the instruments and the significance of their readings. One must also know the function and operation of all of the controls in the driver's compartment. Review of paragraph 6 will be helpful. The limitations of vehicle and engine are covered under paragraph 5.

b. **Operating Instructions.** With the engines at idling speed and all instruments showing normal readings, the driver may now operate the vehicle.

- (1) Release the parking brake. *This is important.*
- (2) Disengage the clutch by pressing clutch pedal down to the floor and holding it down.

OPERATION AND CONTROLS

(3) Move the gearshift lever into first gear.

(4) Gradually engage the clutch, at the same time depress the foot throttle. Except when under fire, do not move the vehicle in or out of close quarters without the aid of personnel outside of the vehicle serving as a guide.

(5) When the vehicle has started and is moving at some speed below eight miles per hour with transfer case in high ratio, or below four miles per hour with transfer case in low ratio, release the foot throttle, depress the clutch again, and move the gearshift lever into the second gear position. Release the clutch and again depress the throttle to pick up the load of the vehicle.

(6) Repeat the above procedure until the highest gear is reached which will enable the vehicle to proceed at the desired speed without causing the engine to labor. Do not lose sight of the fact that the engines are not governed and can be seriously damaged by high speeds in the lower gears. For maximum speeds permissible with each possible gear combination, refer to paragraph 5. Do not ride the clutch. The driver's left foot must be completely removed from the clutch pedal while driving, to avoid unnecessary wear and burning out the clutch.

(7) To place the vehicle in reverse gear, a complete stop must be made. After forward movement of the vehicle has stopped, depress the clutch pedal and move the gearshift lever to the reverse position (fig. 6). Backing the vehicle should never be attempted unless an observer is stationed in front to guide the driver.

(8) It is better to go into a turn slowly, increasing the speed during the turn rather than to enter the turn too fast and have to apply the brakes during the turn. The driver should anticipate each turn as much as is possible.

(9) To stop the vehicle, remove the right foot from the foot throttle and apply the foot brakes. Depress the clutch pedal when the vehicle has slowed down to approximately two to five miles per hour, depending upon which gear is being employed before stopping. Allow the engines to idle for the duration of the halt, if halt is not to be more than five minutes.

(10) The temperature gages and the oil pressure gages give the most satisfactory indications of the engines' performance. When the indications of these instruments appear to be irregular, stop the engine and determine the cause.

11. TOWING.

a. A towing shackle is mounted on each corner of the hull of the vehicle about 20 inches from the ground. Two of these shackles are

ARMORED CAR T17

mounted in front and two in the rear. These shackles provide a quick method of attaching either the towing bar or cables. When the vehicle is being towed, shift the transfer case to neutral (fig. 7).

12. STOPPING THE ENGINES

a. After completing a run, the engines must be allowed to operate at idling speed for two minutes to assure a gradual and uniform cooling of the valves and various other engine parts. Put the gearshift lever in neutral and turn the ignition switch to "OFF" position.

Section III

LUBRICATION INSTRUCTIONS

	Paragraph
General	13
Lubrication guide	14
Points to be serviced and/or lubricated by ordnance maintenance personnel	15
Reports and records	16

13. GENERAL.

a. The following lubrication instructions for Armored Car T17, are published for the information and guidance of all concerned, and supersede all previous instructions. Materiel must be lubricated in accordance with the latest instructions contained in Technical Manuals and/or Ordnance Field Service Bulletins.

14. LUBRICATION GUIDE.

a. Lubrication instructions for all points to be serviced by the using arm are shown in War Department Lubrication Guide No. 90, which specifies the types of lubricants required and the intervals at which they are to be applied. The following lubrication instructions contain the same information as the guide. Guides from which data is reproduced are 10-inch x 15-inch laminated charts which are part of the accessory equipment of each piece of materiel. Data contained in the lubrication guides is taken from TM's, and is binding on using troops.

15. POINTS TO BE SERVICED AND/OR LUBRICATED BY ORDNANCE MAINTENANCE PERSONNEL.

a. **Starters.** Every 6 months, disassemble, clean, and repack bearings with GREASE, ball and roller bearing.

b. **Clutch Pilot Bearings.** When clutch is disassembled, remove, clean, and repack bearing with GREASE, general purpose No. 2.

c. **Speedometer Cable.** Every six months, disconnect cable conduit. Lubricate cable sparingly with GREASE, general purpose No. 0, and reassemble.

16. REPORTS AND RECORDS.

a. **Reports.** If lubrication instructions are closely followed, proper

ARMORED CAR T17

CAUTION—Lubricate Dotted Arrow Points on Both Sides. Points on Opposite Side are indicated by Dotted Short-Shaft Arrows.

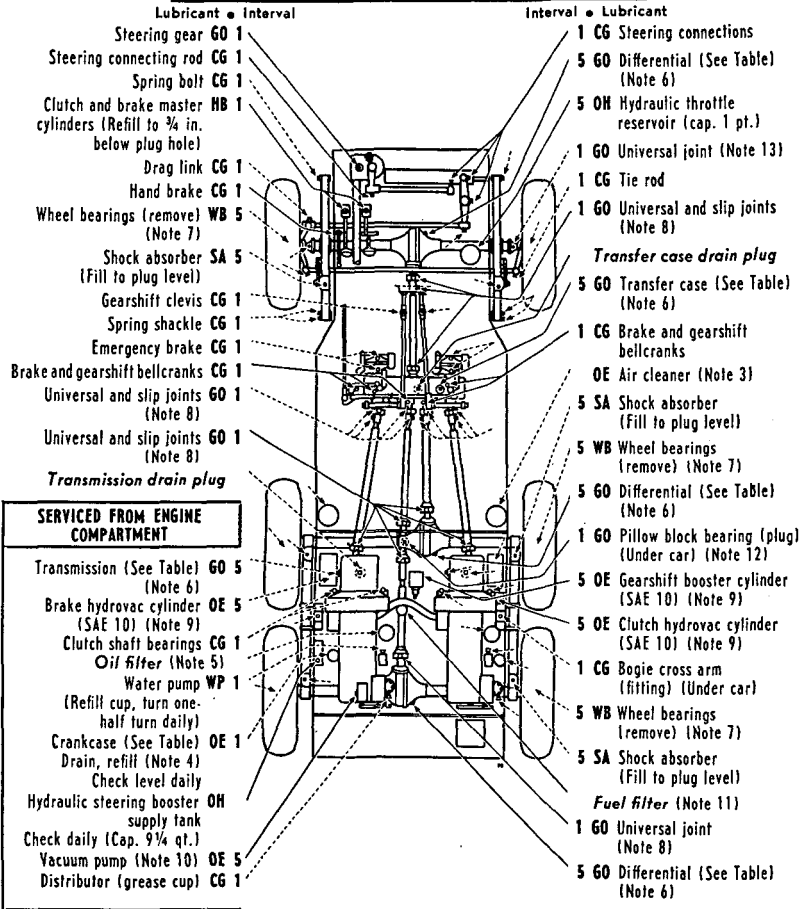

KEY

LUBRICANTS	
OE—OIL, engine	WB—GREASE, general purpose No. 2
Crankcase grade (unless otherwise specified)	WP—GREASE, water pump
GO—LUBRICANT, gear, universal	SA—SHOCK ABSORBER FLUID, heavy
CG—GREASE, general purpose No. 1 (above +32°)	HB—FLUID, brake, hydraulic
No. 1 or No. 0 (+32° to +10°)	OH—OIL, hydraulic
No. 0 (below +10°)	

INTERVALS
1—1,000 MILES
5—5,000 MILES
CHECK DAILY
Crankcase
Air cleaners

RA PD 27449

Figure 8 — Lubrication Chart of Chassis

LUBRICATION INSTRUCTIONS

NOTES: Additional Lubrication and Service Instructions on Individual Units and Parts.

- (1) **FITTINGS**—Clean before applying lubricant. Lubricate until new lubricant is forced from the bearing, unless otherwise specified. **CAUTION:** Lubricate chassis points after washing vehicle.
- (2) **INTERVALS** indicated are for normal service. For extreme conditions of speed, heat, water, sand, snow, mud, rough roads, dust, etc., reduce interval by 1/3 or 1/2, or more if conditions warrant.
- (3) **AIR CLEANERS** (Engine and Crankcase Breather)—Check level daily and refill oil reservoirs to bead level with OIL, engine, crankcase grade. Every 100 to 1,000 miles, depending on operating conditions, drain, clean, and refill. Every 2,000 miles also remove air cleaner and wash all parts. (Proper maintenance of air cleaners is essential to prolonged engine life.)
- (4) **CRANKCASES**—Drain only when engine is hot. Crankcase drain plugs are reached from under hull by removing large plugs in hull floor. Refill to FULL mark on gage. Run engine a few minutes and recheck oil level. **CAUTION:** Be sure pressure gages on instrument panel indicate oil is circulating in both engines.
- (5) **OIL FILTERS**—Every 2,000 miles, or more often if necessary, remove cover from filter shell. Remove old element and install new element. Replace and tighten cover. After renewing element, refill crankcase to FULL mark on gage. Run engine a few minutes and recheck level.
- (6) **GEAR CASES**—Check level weekly with vehicle on level ground and, if necessary, add lubricant to correct level. Transmission plugs and transfer case plug are reached from under hull by removing large plugs in hull floor. Drain, flush, and refill at the end of first 1,000 miles; thereafter as indicated at points on guide. When draining, drain immediately after operation.
- (7) **WHEEL BEARINGS** (Front and Rear)—Remove wheel, clean and repack bearings. To clean and pack wheel bearings properly, they must be removed from the hub. Follow the procedure below:
 - (a) Remove the bearings from the hub and wash them in SOLVENT, dry-cleaning, until all the old lubricant is removed from both inside and outside of cage.
 - (b) Lay them aside to dry, and wash the inside of the hub and the spindle with SOLVENT, dry-cleaning.
 - (c) When bearings are thoroughly dry, pack the races with GREASE, general purpose No. 2, and reassemble in hub. To satisfactorily pack a bearing, it is necessary to knead lubricant into space between the cage and inner race. Do not apply any lubricant to the inside of the hub or on the spindle. The lubricant packed in the bearing races is sufficient to provide lubrication until the next service period. An excess may result in leakage of the lubricant into the brake drum.
 - (d) Mount the wheel on the spindle and tighten the nut on the end of the spindle until there is a slight drag when the wheel is rotated.
 - (e) Back off the nut until the wheel turns freely without side play. Lock adjusting nut in position.
 - (f) Install hub cap. Lubricate bearings only.
- (8) **UNIVERSAL JOINTS AND SLIP JOINTS**—Apply lubricant with caution, as no relief valves are provided for the joints or splines. Excessive pressure may damage the seals.
- (9) **BRAKE AND CLUTCH HYDROVAC CYLINDERS, GEARSHIFT BOOSTER CYLINDER**—Every 6 months, or 10,000 miles, remove plugs and inject about one teaspoonful of OIL, engine, SAE 10, into each opening. Hydrovac cylinders have a pipe plug in the control port and a pipe plug in the center plate of the cylinder.
- (10) **VACUUM PUMP**—Every 500 miles, or once a week, check level; if necessary, add OIL, engine, SAE 30 above + 32 degrees, SAE 10 below + 32 degrees. Drain, flush, and refill as indicated at points on guide.
- (11) **FUEL FILTER**—Every 5,000 miles, or more often if necessary, remove sediment bowl from fuel filter attached to front of gas tank and thoroughly clean bowl. Replace bowl and check gasket for leaks.
- (12) **PILLOW BLOCK BEARING**—Mounted on bottom of forward rear axle and reached from under the car. Lubricate through plug hole on top of unit with LUBRICANT, gear, universal, to level of plug on side of unit.
- (13) **FRONT AXLE UNIVERSAL JOINTS**—A pressure fitting is provided just inside of finished portion of the spherical joint. Apply GREASE, general purpose, seasonal grade, at intervals shown on the guide.
- (14) **OIL CAN POINTS**—Daily, or every 250 miles, lubricate throttle cross shaft and clevises, hinges, latches, vacuum cylinder valve, power cylinder linkage, hand crank latch, turret traversing lock, gear selector H plate and lever, spark and throttle rod ends, gearshift linkages, clutch and brake linkages, etc., with OIL, engine, crankcase grade.
- (15) **POINTS REQUIRING NO LUBRICATION SERVICE**—Generators, clutch release bearings, shock absorber linkage, fan bearings.
- (16) **POINTS TO BE SERVICED AND/OR LUBRICATED BY ORDNANCE MAINTENANCE PERSONNEL**—Starters, clutch pilot bearings, speedometer cable.

RA PD 27449B

Notes on Figure 8 — Lubrication of Chassis

ARMORED CAR T17

TABLE OF CAPACITIES AND LUBRICANTS TO BE USED

	CAPACITY (APPROX.)	ABOVE 32°	32° TO 10°	10° TO —10°	BELOW —10°
CRANKCASE (EACH)	7 QT.	OE SAE 30	OE SAE 30 OR 10	OE SAE 10	
TRANSMISSION (EACH)	4-1/2 QT.	GO	GO	GO	
TRANSFER CASE	4-1/2 QT.				
DIFFERENTIAL (EACH)	3-1/2 QT.	SAE 90	SAE 90 OR 80	SAE 80	

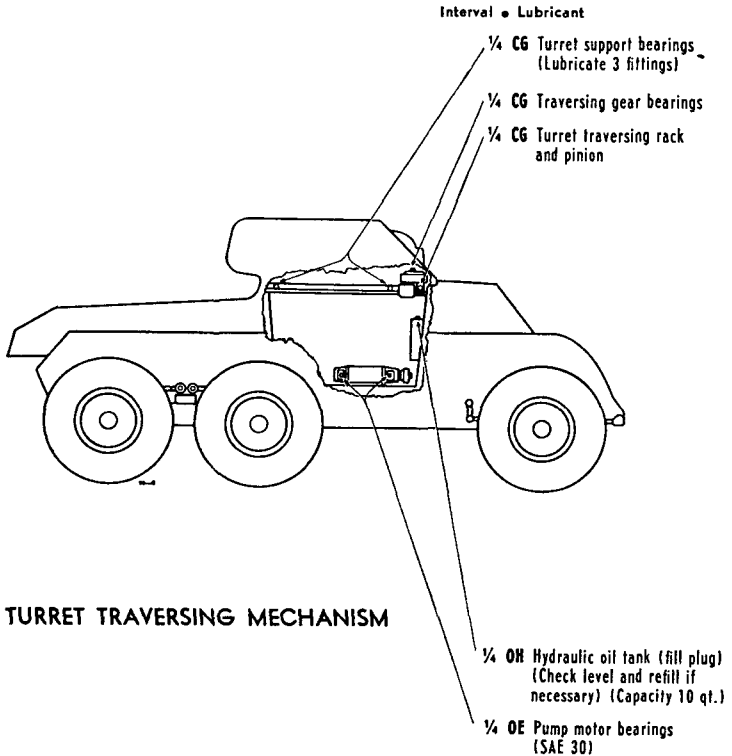

— KEY —

LUBRICANTS	
OE—OIL, engine	OH—OIL, hydraulic
CG—GREASE, general purpose	
No. 1 (above +32°)	
No. 1 or No. 0	
(+32° to +10°)	
No. 0 (below +10°)	

INTERVALS
1/4—250 MILES

RA PD 27450

Figure 9 — Lubrication Chart of Turret Mechanism

LUBRICATION INSTRUCTIONS

lubricants used, and satisfactory results are not obtained, a report will be made to the ordnance officer responsible for the maintenance of the materiel.

b. Records. A complete record of lubrication servicing will be kept for the materiel.

ARMORED CAR T17

Section IV

PREVENTIVE MAINTENANCE AND INSPECTIONS

	Paragraph
Purpose	17
Prestarting inspection	18
Inspection during operation.....	19
Inspection at the halt.....	20
Inspection after operation	21
Periodic inspection	22

17. PURPOSE (figs. 10 to 14).

a. To insure mechanical efficiency, it is necessary that the armored car systematically receive preventive maintenance service and inspections at intervals, in order that defects may be discovered and corrected before they result in serious damage. To aid in this purpose five charts (figs. 10 to 14) are included to support the text.

b. Cracks that develop in castings or other metal parts may often be detected through the medium of dust and oil deposits upon completion of the run.

c. Suggestions toward changes in design prompted by chronic failure or malfunction of a unit or group of units, pertinent changes in inspection or maintenance methods and changes involving safety, efficiency, and economy should be forwarded to the Office of the Chief of Ordnance, through proper channels, at the time they develop. Such action is encouraged, in order that other organizations may profit thereby.

18. PRESTARTING INSPECTION (fig. 10).

a. The armored car has a crew of five men and it is essential that all men be utilized in inspection of the vehicle under the direction of the car commander. The inspection should cover the vehicle as well as the engines.

b. Look at the ground under the armored car for oil and fuel leaks.

c. Check that all pioneer tools are present.

d. Check general condition of bogie, springs, shock absorbers, tie rod, drag link, wheels, and tires.

e. Check for loose air tube connections from carburetors to air cleaners.

PREVENTIVE MAINTENANCE AND INSPECTIONS

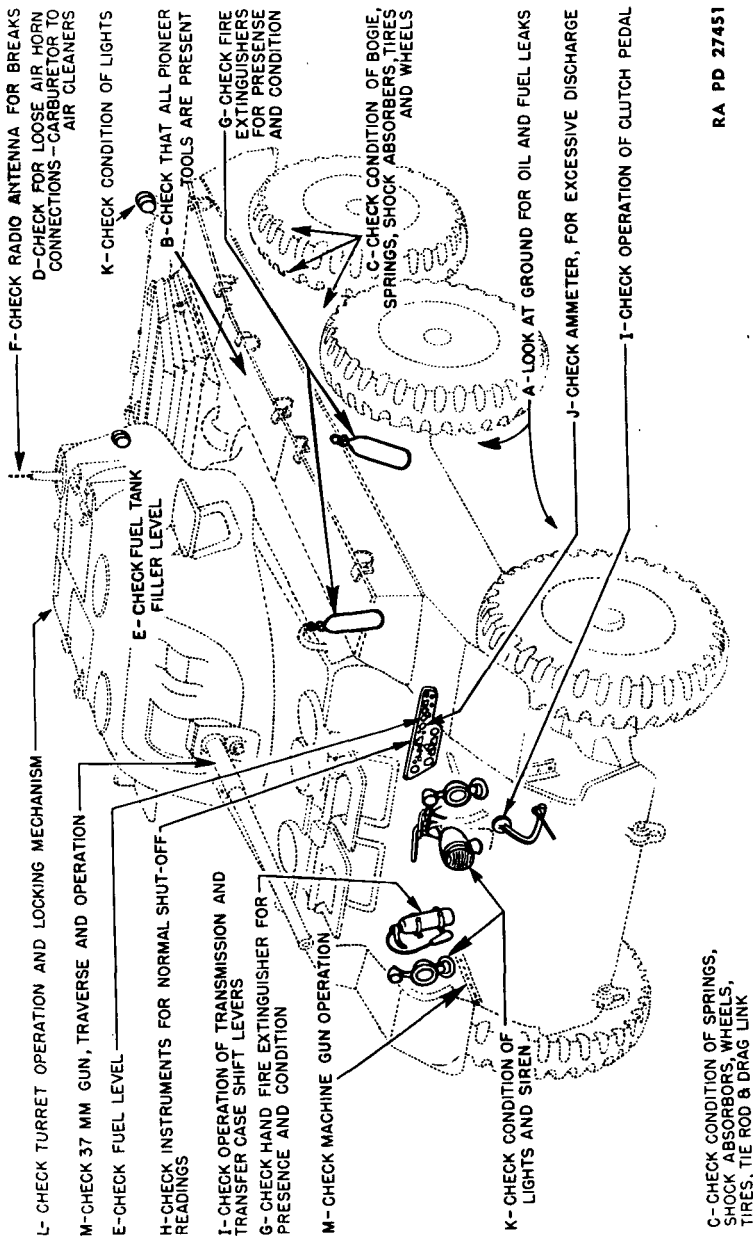

RA PD 27451

Figure 10 — Preventive Maintenance Chart No. 1. Prestarting Inspection

ARMORED CAR T17

- f. Check fuel level; fill if necessary.
- g. Check radio antenna for breaks.
- h. Check for presence and condition of fire extinguishers and vehicle tools.
- i. Check instrument panel and see that instruments indicate normal shut-off readings.
- j. Check to see that clutch pedal and transmission and transfer case shift levers operate freely and over their full range.
- k. If ammeter shows excessive discharge with all switches open, a short circuit exists and must be corrected immediately.
- l. Check lights and siren.
- m. Check operation of turret and locking mechanism.
- n. Check traverse and elevation of vehicle's weapons.
- o. Check to see that ammunition, flags, field equipment, and rations, if carried, are properly loaded.

19. INSPECTION DURING OPERATION.

a. During operation the driver will be on the alert to detect abnormal functioning of the engines. He should be trained to detect unusual engine sounds or noises. He should glance frequently at the instrument panel gages to see if the engines are functioning properly. An unsteady oil gage needle indicates low oil level, provided that engine speed is fairly constant. The steering mechanism must be checked for proper functioning of the hydraulic booster mechanism.

b. Only under exceptional circumstances will an armored car be operated after indications of trouble have been observed. When in doubt, the engines will be stopped, and assistance obtained. Inspection during operation applies to the entire vehicle and must be emphasized throughout the driving instruction period.

20. INSPECTION AT THE HALT (fig. 11).

a. At each halt the operator will make a careful inspection of the armored car to determine its general mechanical condition. Minor defects detected during the march, together with defects discovered at the halt, will be corrected before resuming the march. If the defects cannot be corrected during the halt, proper disposition of the vehicle will be made so that unnecessary delay may be avoided and a major failure prevented.

PREVENTIVE MAINTENANCE AND INSPECTIONS

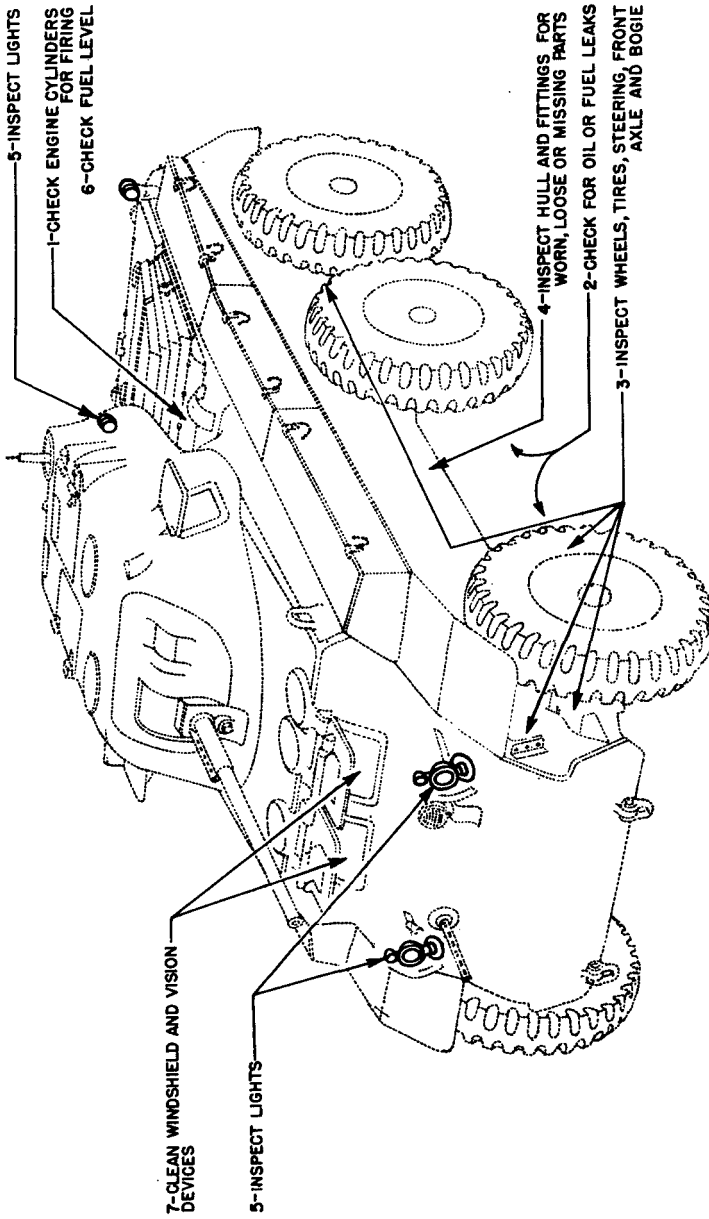

RA PD 27452

Figure 11 — Preventive Maintenance Chart No. 2, Inspection at the Halt

ARMORED CAR T17

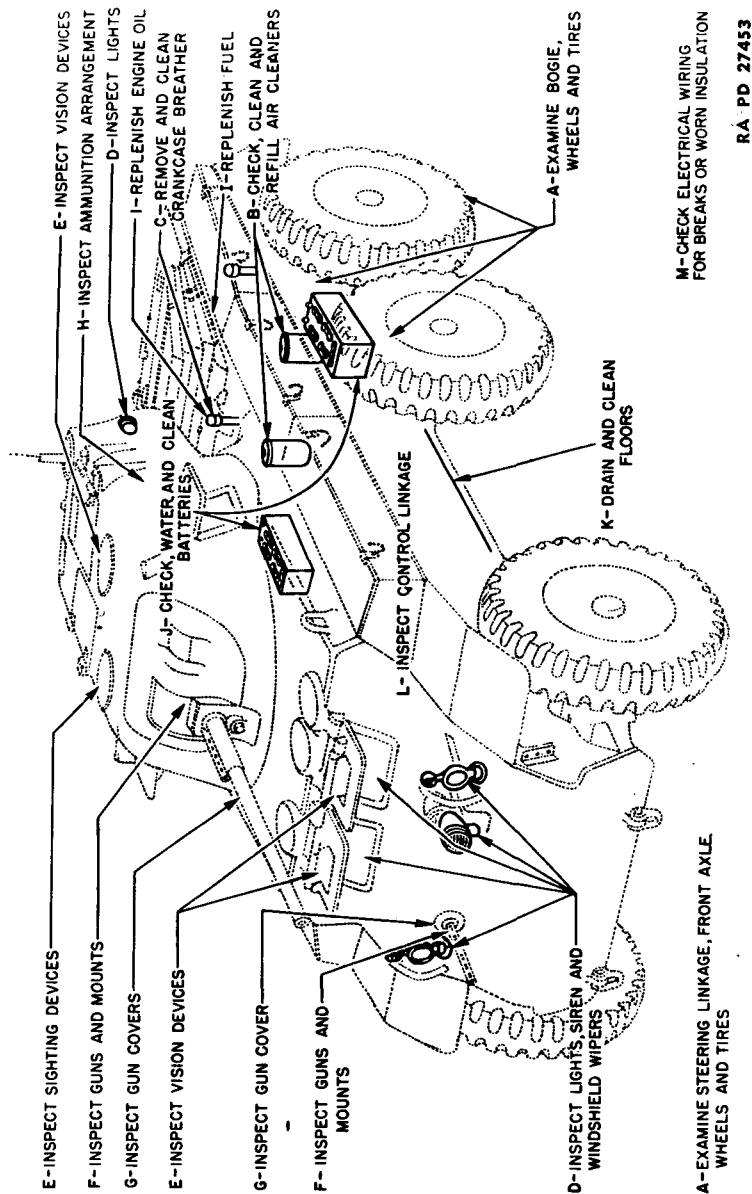

Figure 12 — Preventive Maintenance Chart No. 3, Inspection After Operation

RA PD 27453

PREVENTIVE MAINTENANCE AND INSPECTIONS

b. A suitable general routine is as follows:

(1) By means of the ignition switch, cut out each engine in turn to make sure all cylinders of both engines are firing. Allow each of the engines to run alone a short time at idling speed (500 rpm). Listen for unusual noises.

(2) Walk around the vehicle, looking carefully for fuel or oil leaks. Be sure to drain out any oil that has leaked onto hull floor, after correcting the cause of the leakage.

(3) Examine the wheels, tires, steering linkage, front axle, and bogie for adjustment and for worn, loose, broken, or missing parts.

(4) Inspect hull and fittings for missing, worn, or loose parts.

(5) Inspect the lights, if traveling at night with lights.

(6) Check the amount of fuel in the tank.

(7) Wipe all windshield and vision devices. Do not use an oily or dirty cloth.

21. INSPECTION AFTER OPERATION (fig. 12).

a. At the conclusion of each day's operation, the armored car commander should cause an inspection to be made, similar to that made at halts but more thorough and detailed. The inspection should be followed by preventive maintenance. If defects cannot be corrected, they should be reported promptly to the chief of section or other designated individual. The following points should be covered:

(1) Examine wheels, tires, steering linkage, front axle, and bogie.

(2) Check, clean, and refill air cleaners during extremely dusty operations.

(3) Clean crankcase breathers and replenish oil.

(4) Inspect lights, siren, and windshield wipers. Check for loss or damage of accessories.

(5) Inspect the sighting and vision devices for breakage.

(6) Inspect guns and mounts for defective performance.

(7) Inspect guns, sighting equipment, and accessories, and determine that covers are properly installed.

(8) Inspect ammunition and fighting compartments for cleanliness and orderly arrangement.

(9) Replenish ammunition, engine oil, and fuel. Always touch the nozzle of the gasoline hose to the hull of the armored car before removing gas tank cap, to eliminate possibility of a static charge of electricity in either the car or the gasoline truck from causing an explosion and fire when cap is removed from gas tanks.

ARMORED CAR T17

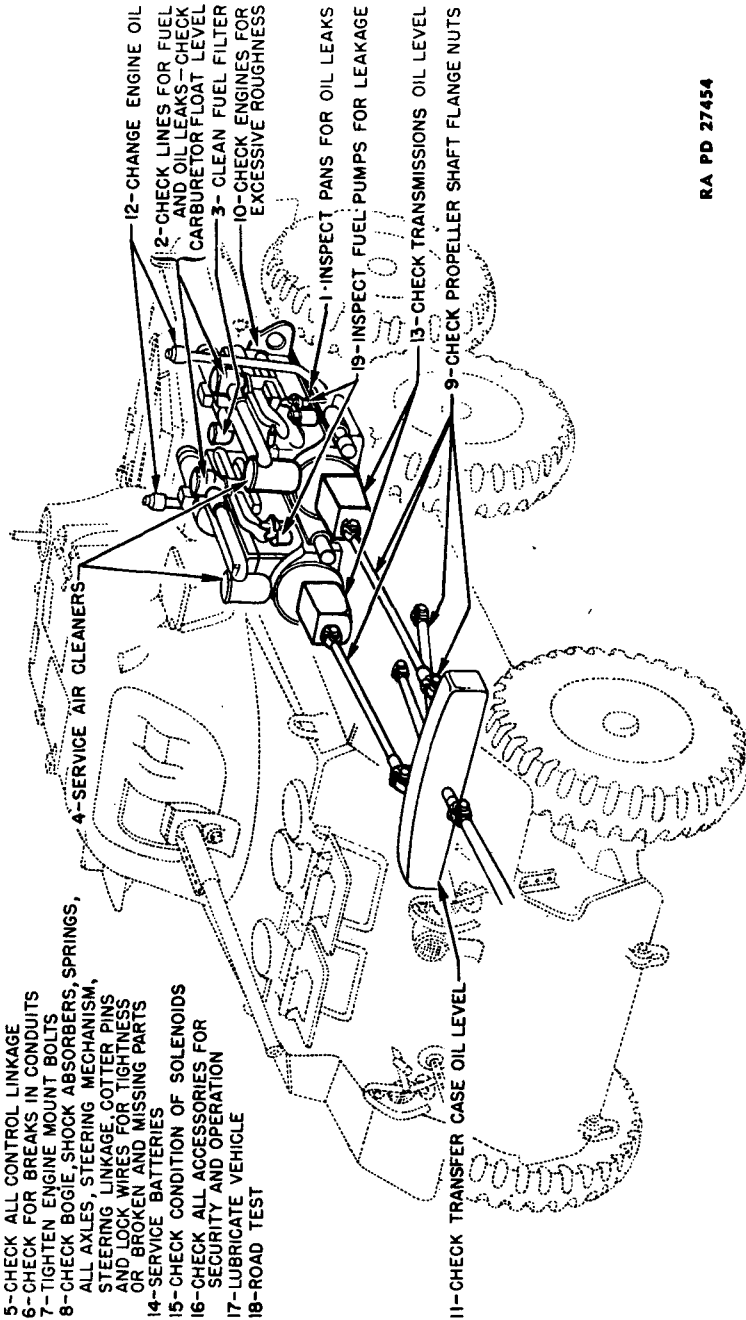

RA PD 27454

Figure 13 — Preventive Maintenance Chart No. 4, Inspection After 500 Miles of Operation

PREVENTIVE MAINTENANCE AND INSPECTIONS

(10) For continuous operation in hot weather, battery water must be replenished about twice a week. Check and clean battery and compartment weekly.

(11) Drain and clean all floors through spring-loaded valves provided, and be sure to remove any accumulation from the engine compartment. This is important to eliminate the fire hazard.

(12) Inspect all control linkage to locate loose or broken parts.

(13) Inspect electrical wiring for loose connections.

22. PERIODIC INSPECTION (figs. 13 and 14).

a. After 500 Miles of Operation. This check is made without removing the engines from vehicle. (Check for leaks, etc., will be made with engine compartment open and engines running.) Make routine daily inspection and the following:

(1) Inspection for oil leaks at oil pan.

(2) Check fuel and oil lines for breaks, loose connections and chafing. Check level of fuel in carburetor float bowl. Make external inspection of rigid and flexible lines having sharp bends or kinks.

(3) Close fuel line valve; remove the bolt passing through the fuel filter; and remove and clean the bowl and filter element. If excessive water or dirt is observed, drain and clean fuel tank.

(4) Service air cleaner; do not overfill with oil. Check all air induction pipes and connections for leaks. Check carburetor flange gasket.

(5) Check and adjust all control linkage for wear, free operation, and missing cotter pins. See that full travel of controls is obtained. This applies to all controls of the vehicle.

(6) Check all flexible conduits for breaks and worn sections.

(7) Tighten all engine mounting bolts.

(8) Check bogie, shock absorbers, springs, all axles, steering mechanism, steering linkage, cotter pins, and lock wires for tightness, or broken and missing parts.

(9) Check all propeller shaft flange nuts for tightness.

(10) Check engines for unusual operating noise or smoke.

(11) Check transfer case oil level.

(12) Change engine oil.

(13) Check oil level in transmission.

(14) Service batteries.

(15) Check solenoids for operation.

(16) Check all accessories for security and operation.

(17) Lubricate vehicle throughout in compliance with lubrication instructions.

(18) Road test for proper operation.

(19) Inspect fuel pumps and, if leaking, tighten or replace pump.

ARMORED CAR T17

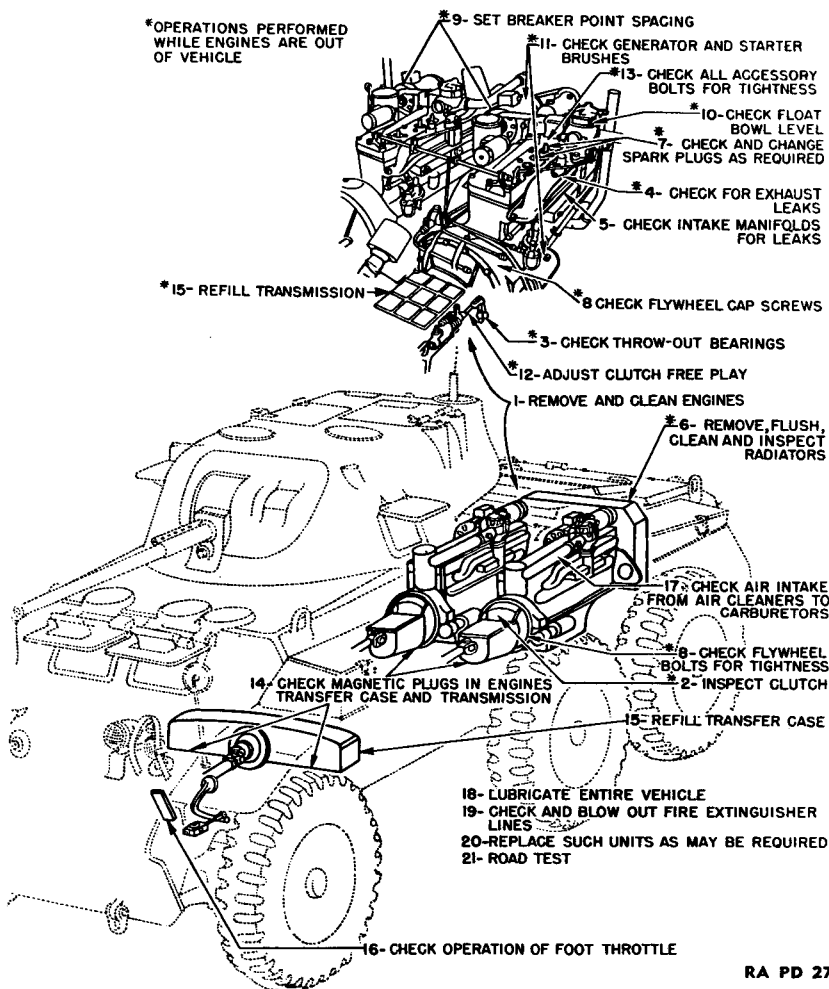

THE ABOVE OPERATIONS ARE IN ADDITION TO DAILY AND 500 MILE CHECK

Figure 14 — Preventive Maintenance Chart No. 5, Inspection After 2,500 Miles of Operation

b. After 2,500 Miles of Operation. Daily and 500-mile inspection will be repeated in addition to the following:

- (1) Remove engines; place on inspection stand and clean with SOLVENT, dry-cleaning.
- (2) Disassemble clutch; inspect plates; lubricate clutch hub, spindle, and throwout bearings.
- (3) Check clutch throwout bearing for wear and flat spots on races.
- (4) Check for exhaust leaks. Check all exhaust pipes for cracks, burned out spots, and rust.

PREVENTIVE MAINTENANCE AND INSPECTIONS

- (5) Check engine manifold gaskets and secure nuts for tightness.
- (6) Remove radiators; clean all dirt in air passages; drain and flush out inside. Remove flushing material completely.
- (7) Install new spark plugs if required. Check both new and old plugs before installing them. **NOTE:** Do not change spark plugs until all other top cylinder work has been completed.
- (8) Check flywheel mounting bolt nuts for tightness and presence of cotter pins.
- (9) Inspect distributor breaker and reset points to 0.020 inch, using feeler gage. Check points for pitting. If points show ash-colored burning, have condensers checked.
- (10) Inspect carburetor for float bowl fuel level.
- (11) Inspect starter, generator, brushes, commutator, and general internal appearance. If brushes need replacing or if other repairs are indicated, replace starter or generator.
- (12) Adjust clutch (par. 71).
- (13) Check all nuts securing engine accessories, fan and shroud, support brackets, etc., for tightness.
- (14) Clean magnetic plugs in engine oil pans, transmissions, and transfer case and check magnetic ability.
- (15) Refill transmission and transfer case.
- (16) Check foot accelerator to make sure both carburetors are wide open when foot throttle comes against stop.
- (17) Check carburetor air horn rubber connections for restricted passages.
- (18) Lubricate vehicle throughout, in compliance with lubrication instructions.
- (19) Check and blow out fire extinguisher lines.
- (20) Check and, where necessary, replace or exchange units such as engines, axles, etc., or unit accessories such as headlights, batteries, sirens, generators, wiring harness, etc.
- (21) Road test.

ARMORED CAR T17

Section V

CARE AND PRESERVATION

	Paragraph
Records	23
Cleaning	24

23. RECORDS.

a. **Use.** An accurate record must be kept of each motor vehicle issued by the Ordnance Department. For this purpose the Ordnance Motor Book (O.O. Form No. 7255), generally called "Log Book," is issued with each vehicle and must accompany it at all times. This book furnishes a complete record of the vehicle from which valuable information concerning operation and maintenance costs, etc., is obtained and organization commanders must insist that correct entries be made. This book will be habitually kept in a canvas cover to prevent its being injured or soiled.

b. **Assignment Record.** The page bearing a record of assignment must be destroyed prior to entering the combat zone. All other references which may be posted regarding the identity of the organization must also be deleted.

24. CLEANING.

a. Grit, dirt, and mud are the sources of greatest wear to a vehicle. If deposits of dirt and grit are allowed to accumulate, particles will soon find their way into bearing surfaces, causing unnecessary wear, and, if the condition is not remedied, will soon cause serious difficulty. When removing engine parts or any other unit, in making repairs and replacements, or, if in the course of inspection, working joints or bearing surfaces are to be exposed, all dirt and grit that might find its way to the exposed surfaces must first be carefully removed. The tools must be clean and care must always be taken to eliminate the possibilities of brushing dirt or grit into the opening with the sleeve or other part of the clothing. To cut oil-soaked dirt and grit, hardened grit, or road oil, use SOLVENT, dry-cleaning, applied with cloth (not waste) or a brush. Care should be taken to keep water from the power unit, as it might interfere with proper ignition and carburetion. Detailed information on cleaning is included in TM 9-850.

b. Oilholes which have become clogged should be opened with a piece of wire. Wood should never be used for this purpose, as splinters are likely to break off and permanently clog the passages. Particular care should be taken to clean and decontaminate vehicles that have been caught in a gas attack. See section VII on "Materiel Affected by Gas" for details of this operation.

Section VI

PAINTING

	Paragraph
General	25
Preparing for painting	26
Painting metal surfaces	27
Paint as a camouflage	28
Removing paint	29
Painting lubricating devices	30

25. GENERAL.

a. Ordnance materiel is painted before issue to the using arms and one maintenance coat per year will ordinarily be ample for protection. With but few exceptions, this materiel will be painted with **ENAMEL**, synthetic, olive drab, lusterless. The enamel may be applied over old coats of long oil enamel previously issued by the Ordnance Department if the old coat is in satisfactory condition for repainting.

b. Paints and enamels are usually issued ready for use and are applied by brush or spray. They may be brushed on satisfactorily when used unthinned in the original package consistency or when thinned no more than 5 percent by volume with **THINNER**. The enamel will spray satisfactorily when thinned with 15 percent by volume of **THINNER**. (Linseed oil must not be used as a thinner since it will impart a luster not desired in this enamel). If sprayed, it dries hard enough for repainting within 1/2 hour and dries hard in 16 hours.

c. Certain exceptions to the regulations concerning painting exist. Fire-control instruments, sighting equipment, and other items which require a crystalline finish will not be painted with olive-drab enamel.

d. Complete information on painting is contained in **TM 9-850**.

26. PREPARING FOR PAINTING.

a. If the base coat on the materiel is in poor condition, it is more desirable to strip the old paint from the surface than to use sanding and touch-up methods. After stripping, it will then be necessary to apply a primer coat.

b. **PRIMER**, ground, synthetic, should be used on wood as a base coat for synthetic enamel. It may be applied either by brushing or spraying. It will brush satisfactorily as received or after the addition of not more than 5 percent by volume of **THINNER**. It will be dry enough to touch in 30 minutes, and hard in 5 to 7 hours. For spraying,

ARMORED CAR T17

it may be thinned with not more than 15 percent by volume of **THINNER**. Lacquers must not be applied to the **PRIMER**, ground, synthetic, within less than 48 hours.

c. **PRIMER**, synthetic, rust inhibiting, for bare metal, should be used on metal as a base coat. Its use and application is similar to those outlined in paragraph **b** above.

d. The success of a job of painting depends partly on the selection of a suitable paint, but also largely upon the care used in preparing the surface prior to painting. All parts to be painted should be free from rust, dirt, grease, kerosene, oil, and alkali, and must be dry.

27. PAINTING METAL SURFACES.

a. If metal parts are in need of cleaning, they should be washed in a liquid solution consisting of $\frac{1}{2}$ pound of **SODA ASH** in 8 quarts of warm water, or an equivalent solution, then rinsed in clear water and wiped thoroughly dry. Wood parts in need of cleaning should be treated in the same manner, but the alkaline solution must not be left on for more than a few minutes and the surfaces should be wiped dry as soon as they are washed clean. When artillery or automotive equipment is in fair condition and only marred in spots, the bad places should be touched with **ENAMEL**, synthetic, olive drab, lusterless, and permitted to dry. The whole surface will then be sandpapered with **PAPER**, flint, No. 1, and a finish coat of **ENAMEL**, synthetic, olive drab, lusterless, applied and allowed to dry thoroughly before the material is used. If the equipment is in bad condition, all parts should be thoroughly sanded with **PAPER**, flint, No. 2, or equivalent, given a coat of **PRIMER**, ground, synthetic, and permitted to dry for at least 16 hours. They will then be sandpapered with **PAPER**, flint, No. 00, wiped free from dust and dirt, and a final coat of **ENAMEL**, synthetic, olive drab, lusterless, applied and allowed to dry thoroughly before the material is used.

28. PAINT AS A CAMOUFLAGE.

a. Camouflage is now a major consideration in painting ordnance vehicles, with rust prevention secondary. The camouflage plan at present employed utilizes three factors: color, gloss, and stenciling.

b. **Color.** Vehicles are painted with **ENAMEL**, synthetic, olive drab, lusterless, which was chosen to blend in reasonably well with the average landscape.

c. **Gloss.** The new lusterless enamel makes a vehicle difficult to see from the air or from relatively great distances over land. A vehicle painted with ordinary glossy paint can be detected more easily and at greater distances.

PAINTING

d. Stenciling. White stencil numbers on vehicles have been eliminated because they can be photographed from the air. A blue-drab stencil enamel is now used which cannot be so photographed. It is illegible to the eye at distances exceeding 75 feet.

e. Preserving Camouflage.

(1) Continued friction or rubbing must be avoided, as it will smooth the surface and produce a gloss. The vehicle should not be washed more than once a week. Care should be taken to see that the washing is done entirely with a sponge or a soft rag. The surface should never be rubbed or wiped, except while wet, or a gloss will develop.

(2) It is not desirable that vehicles, painted with lusterless enamel, be kept as clean as vehicles were kept when glossy paint was used. A small amount of dust increases the camouflage value. Grease spots should be removed with SOLVENT, dry-cleaning. Whatever portion of the spot cannot be so removed should be allowed to remain.

(3) Continue friction of wax-treated tarpaulins on the sides of a vehicle will also produce a gloss, which should be removed with SOLVENT, dry-cleaning.

(4) Tests indicate that repainting with olive-drab paint will be necessary once yearly, with blue-drab paint twice yearly.

29. REMOVING PAINT.

a. After repeated paintings, the paint may become so thick as to crack and scale off in places, presenting an unsightly appearance. If such is the case, remove the old paint by use of a lime-and-lye solution (see TM 9-850 for details) or REMOVER, paint and varnish. It is important that every trace of lye or other paint remover be completely rinsed off and that the equipment be perfectly dry before repainting is attempted. It is preferable that the use of lye solutions be limited to iron or steel parts. If used on wood, the lye solution must not be allowed to remain on the surface for more than a minute before being thoroughly rinsed off and the surface wiped dry with rags. Crevices or cracks in wood should be filled with putty and the wood sandpapered before refinishing. The surfaces thus prepared should be painted according to directions in paragraph 27.

30. PAINTING LUBRICATING DEVICES.

a. Oil cups, grease fittings, oilholes, and similar lubricating devices, as well as a circle about $\frac{3}{4}$ inch in diameter at each point of lubrication, will be painted with ENAMEL, red, water resisting, in order that they may be readily located.

ARMORED CAR T17

Section VII

MATERIEL AFFECTED BY GAS

	Paragraph
Protective measures	31
Cleaning	32
Decontamination	33
Special precautions for automotive materiel	34

31. PROTECTIVE MEASURES.

a. When materiel is in constant danger of gas attack, unpainted metal parts will be lightly coated with engine oil. Instruments are included among the items to be protected by oil, from chemical clouds or chemical shells, but ammunition is excluded. Care will be taken that the oil does not touch the optical parts of instruments or leather or canvas fittings. Materiel not in use will be protected with covers as far as possible. Ammunition will be kept in sealed containers.

b. Ordinary fabrics offer practically no protection against mustard gas or lewisite. Rubber and oilcloth, for example, will be penetrated within a short time. The longer the period during which they are exposed, the greater the danger of wearing these articles. Rubber boots worn in an area contaminated with mustard gas may offer a grave danger to men who wear them several days after the bombardment. Impermeable clothing will resist penetration more than an hour, but should not be worn longer than this.

32. CLEANING.

a. All unpainted metal parts of materiel that have been exposed to any gas except mustard and lewisite must be cleaned as soon as possible with SOLVENT, dry-cleaning, or ALCOHOL, denatured, and wiped dry. All parts should be coated with engine oil.

b. Ammunition which has been exposed to gas must be thoroughly cleaned before it can be fired. To clean ammunition use AGENT, decontaminating, noncorrosive, or if this is not available, strong soap and cool water. After cleaning, wipe all ammunition dry with clean rags. *Do not use dry-powdered AGENT, decontaminating (chloride of lime) (used for decontaminating certain types of materiel on or near ammunition supplies), as flaming occurs through the use of chloride of lime on liquid mustard.*

33. DECONTAMINATION.

a. For the removal of liquid chemicals (mustard, lewisite, etc.) from materiel, the following steps should be taken:

MATERIEL AFFECTED BY GAS

b. Protective Measures.

(1) For all of these operations a complete suit of impermeable clothing and a service gas mask will be worn. Immediately after removal of the suit, a thorough bath with soap and water (preferably hot) must be taken. If any skin areas have come in contact with mustard, if even a very small drop of mustard gets into the eye, or if the vapor of mustard has been inhaled, it is imperative that complete first-aid measures be given within 20 to 30 minutes after exposure. First-aid instructions are given in TM 9-850 and FM 21-40.

(2) Garments exposed to mustard will be decontaminated. If the impermeable clothing has been exposed to vapor only, it may be decontaminated by hanging in the open air, preferably in sunlight for several days. It may also be cleaned by steaming for two hours. If the impermeable clothing has been contaminated with liquid mustard, steaming for six to eight hours will be required. Various kinds of steaming devices can be improvised from materials available in the field.

c. Procedure.

(1) Commence by freeing materiel of dirt through the use of sticks, rags, etc., which must be burned or buried immediately after this operation.

(2) If the surface of the materiel is coated with grease or heavy oil, this grease or oil should be removed before decontamination is begun. SOLVENT, dry-cleaning, or other available solvents for oil should be used with rags attached to ends of sticks. Following this, decontaminate the painted surfaces of the materiel with bleaching solution made by mixing one part AGENT, decontaminating (chloride of lime), with one part water. This solution should be swabbed over all surfaces. Wash off thoroughly with water, and then dry and oil all surfaces.

(3) All unpainted metal parts and instruments exposed to mustard or lewisite must be decontaminated with AGENT, decontaminating, noncorrosive mixed one part solid to fifteen parts solvent (ACETYLENE TETRACHLORIDE). If this is not available, use warm water and soap. Bleaching solution must not be used, because of its corrosive action. Instrument lenses may be cleaned only with PAPER, lens, tissue, using a small amount of ALCOHOL, ethyl. Coat all metal surfaces lightly with engine oil.

(4) In the event AGENT, decontaminating (chloride of lime), is not available, materiel may be temporarily cleaned with large volumes of hot water. However, mustard lying in joints or in leather or canvas webbing is not removed by this procedure and will remain a constant source of danger until the materiel can be properly decontaminated. All mustard washed from materiel in this manner lies unchanged on the

ARMORED CAR T17

ground, necessitating that the contaminated area be plainly marked with warning signs before abandonment.

(5) The cleaning or decontaminating of materiel contaminated with lewisite will wash arsenic compounds into the soil, poisoning many water supplies in the locality for either men or animals.

(6) Leather or canvas webbing that has been contaminated should be scrubbed thoroughly with bleaching solution. In the event this treatment is insufficient, it may be necessary to burn or bury such materiel.

(7) Detailed information on decontamination is contained in FM 21-40, TM 9-850, and TC 38, 1941, Decontamination.

34. SPECIAL PRECAUTIONS FOR AUTOMOTIVE MATERIEL.

a. When vehicles have been subjected to gas attack with the engine running, the air cleaner should be serviced by removing the oil, flushing with SOLVENT, dry-cleaning, and refilling with the proper grade of oil.

b. Instrument panels should be cleaned in the same manner as outlined for instruments.

c. Contaminated seat cushions will be discarded.

d. Washing the compartments thoroughly with bleaching solution is the most that can be done in the field. When running under conditions of high temperatures, operators should constantly be on the alert, for slow vaporization of the mustard or lewisite.

e. Exterior surfaces of vehicles will be decontaminated with bleaching solution. Repainting may be necessary after this operation.

Section VIII

ARMAMENT

Paragraph

Guns and gun mounts.....	35
Sighting equipment	36
Ammunition	37

35. GUNS AND GUN MOUNTS.

a. **Combination Gun Mount M24.** This gun mount is located in the turret, and mounts a 37-mm gun M6, and a cal. .30 machine gun M1919, fixed, which move together as a single unit. The gunner sits in the left forward side of the turret basket to the left of the gun mount, while the loader sits on the right. The commander sits directly behind the gunner on the left-hand side.

(1) Traverse of 360 degrees is secured by rotating the entire turret either by the hydraulic mechanism or by hand. Selection of the method of rotation is made by means of a manually operated clutch lever at the bottom of the hydraulic motor housing convenient to the gunner's left hand. The turret can be locked in any position by means of the cam-type turret lock, located directly beneath the gun on the turret ring in front of the elevating handwheel.

(a) To rotate the turret with the hydraulic traverse, first move the clutch lever to the "UP" position, and turn the motor switch to the "ON" position. Turn the traverse control handle counterclockwise, to rotate turret to the left. Turn handle clockwise, to rotate turret to the right. The amount the handle is turned determines the speed of turret rotation.

(b) The turret can also be rotated by the manual control crank, after moving the clutch lever down to engage the manual gears with the turret gears. (It may be necessary to turn hand crank slightly to permit gears to mesh.)

(2) Elevation or depression of the gun is secured by a handwheel located on the left side of the gun mount. A gyrostabilizer maintains the gun position while the vehicle is in motion. Turning the elevating wheel counterclockwise depresses the guns a maximum of 10 degrees, while turning it clockwise elevates them to a maximum of 45 degrees.

(3) The electric firing controls consist of two buttons located convenient to the gunner's right foot, directly beneath the gun on the turret basket floor. The left-hand firing button controls the 37-mm gun, while the button to the right fires the cal. .30 machine gun. The 37-mm gun can be fired manually by the trigger at the rear of the firing solenoid, and the cal. .30 machine gun can be fired manually by the trigger on the gun itself, located just above the firing solenoid.

ARMORED CAR T17**b. Stabilizer Unit for Combination Gun Mount.**

(1) **GENERAL.** The stabilizer attached to the combination gun mount M24 is used to maintain the position of the gun so that the gunner may accurately aim and fire while the vehicle is in motion.

(2) **STARTING THE UNIT.** Set the stiffness control at zero, take the hand-elevating gears out of mesh, and turn the handwheel until the control unit is approximately in a vertical position. Start the oil pump motor by turning the switch to the "ON" position. This is the same switch as is used for the hydraulic turret traverse. In cold weather, the oil must be permitted to warm up to obtain full control from the gyrostabilizer equipment. In sub-zero weather, allow 1½ minutes running time for each degree of temperature below 0 F, or a total running time of 30 minutes at 20 F below zero.

(3) OPERATION.

(a) *Control of the Gun.* It is important that the stabilizer equipment be in operation only when the vehicle is moving and when control of the gun is desired. When the stabilizer equipment is in operation, the gun is elevated or depressed in the usual manner by turning the handwheel. This action changes the angular relation between the gun and the control unit, and the gun automatically takes up the new desired position. If the stabilizer equipment is operating satisfactorily, it will keep the gun very near its set angular position within its elevating range, as limited by its mounting. Therefore, when the gun is aimed, the stabilizer must be allowed to control the position of the gun. The handwheel should not be turned after the gun has reached its maximum limits of travel in elevation or depression. **CAUTION:** Continued turning of the handwheel, with the gun against either stop, will displace the control unit from its vertical position and result in an excessive overload on the battery.

(b) *Adjusting the Stiffness Adjuster.* The stiffness adjuster located in the control box provides a means for the gunner to control the operation and effectiveness of the stabilizer. After the oil has warmed up, the knob of the stiffness adjuster should be turned clockwise slowly. An indication of too stiff an adjustment is a vigorous vibration of the gun. An indication of insufficient stiffness adjustment is the gun "hunting" or slowly elevating and depressing from its aimed or set position. When the gun starts to vibrate or "hunt" as the stiffness control knob is turned, decrease or increase the adjustment by turning the knob in the opposite direction until the "hunting" or vibration is eliminated. To check the operation further, press on the breech of the gun suddenly and release. If the gun starts to vibrate, the stiffness adjustment must be decreased slightly. If the gun comes to rest almost immediately after a sharp sudden displacement, it can be considered in proper ad-

ARMAMENT

justment. It may be necessary for the operator to change the stiffness adjustment from time to time as the viscosity of the oil changes and after the vehicle is in use.

(c) *Adjusting the Recoil Adjuster.* The recoil adjuster, located in the control box, provides a means for the gunner to control the recoil of the gun. The recoil adjustment must be made by trial and error while the gun is being fired. The recoil adjustment knob should be gradually turned to the right or clockwise until a point is reached where the gun will keep its angular setting during recoil. If faulty operation is being obtained from the stabilizer during recoil, check for looseness in the mounting of the recoil switch.

(d) *Test for Effective Operation.* After the stabilizer is operating, it should be checked for effectiveness or accuracy before the vehicle is used in combat, as follows: Start and check the operation of the stabilizer equipment. Operate the vehicle over average rough terrain at a normal speed. Aim the gun in the usual manner, using the horizon as the target. If the gun does not fluctuate above or below the horizon, the stabilizer can be considered to be operating satisfactorily.

(4) **OIL LEVEL.** Check the level of the oil in the oil reservoir daily and keep $\frac{2}{3}$ full of hydraulic oil.

c. Bow Gun. A cal. .30 machine gun M1919, flexible, is carried in a ball mount on the right of the vehicle in front of the assistant driver. The ball mount allows both traverse, elevation, and depression. The gun is fired manually by squeezing the trigger and is sighted by tracer only. The bow gun can be pulled from its mounting by removing one pin and used on the tripod, which is stowed on the exterior of the vehicle.

d. Submachine Gun. One Thompson cal. .45 submachine gun is carried in brackets on the right side of the hull above the hull door. It can be used through the pistol ports, opened hatches, or outside when dismounting from the vehicle is necessary.

36. SIGHTING EQUIPMENT.

a. Turret Periscopes.

(1) One periscope is fixed on the left side of the 37-mm gun mount. This unit moves up and down as the gun is elevated and depressed. The combination telescope gun sight is built into the right-hand side of the periscope.

(2) Rotating periscopes are provided in the turret for the loader and for the commander. These periscopes have a 360-degree traverse, 25-degree elevation, and 17-degree depression from the normal vertical position.

ARMORED CAR T17

b. Bow Periscopes.

(1) Two periscopes are fixed in position in the hull roof directly above the driver. These periscopes can be rotated 360 degrees, elevated 25 degrees, or depressed a maximum of 17 degrees.

(2) One periscope is fixed in position directly above the assistant driver. This periscope has the same traverse, elevation, and depression as the driver's periscope.

(3) **REAR VIEW PERISCOPE.** An additional periscope is located in the left turret hatch door. This periscope faces directly to the rear and has a 25-degree elevation and 17-degree depression, but does not rotate.

c. Direct Vision. A direct vision slot is provided in each of the front driver's doors, these slots being covered with a clear plastic protector.

37. AMMUNITION.

a. Ammunition carried is as follows:

4,750 rounds—cal. .30, plus 750 in guns.

110 rounds—37-mm.

450 rounds—cal. .45, in 30-round clips or 320 rounds in .20-round clips.

Hand grenades—8.

PART II — ORGANIZATION INSTRUCTIONS

Section IX

ORGANIZATION MAINTENANCE

Paragraph

Scope 38

38. SCOPE.

a. The scope of maintenance and repairs by the crew and other units of the using arm is determined by the ease with which the project can be accomplished, the amount of time available, the nature of the terrain, weather conditions, temperatures, concealment, shelter, proximity to hostile fire, the equipment available, and the skill of the personnel. All of these are variable and no exact system of procedure can be prescribed.

b. The definitions given below are included in order that the operation name may be correctly interpreted by those doing the work.

(1) **SERVICE.** Consists of cleaning, lubricating, tightening bolts and nuts, and making external adjustments of subassemblies, or assemblies and controls.

(2) **REPAIR.** Consists of making repairs to, or replacement of a part, subassembly or assembly, that can be accomplished without completely disassembling the subassembly or assembly, and does not require heavy welding or riveting, machining, fitting, and/or alining.

(3) **REPLACE.** Consists of removing the part, subassembly, or assembly from the vehicle and replacing it with a new or reconditioned or rebuilt part, subassembly or assembly, whichever the case may be.

(4) **REBUILD.** Consists of completely reconditioning and placing in serviceable condition any unserviceable part, subassembly, or assembly of the motor vehicle including welding, riveting, machining, fitting, alining, assembling, and testing.

c. **NOTE:** The using arm personnel is authorized to remove and reinstall an axle, transfer case, engine, or transmission assembly. However, the replacement of any of these major units with *another* major unit *must not be done by using arm unless authorization* is received from ordnance personnel.

ARMORED CAR T17

Section X

ENGINES

	Paragraph
General description and data.....	39
Engine trouble shooting	40
Engine replacement	41
Oil pump	42
Oil filter	43
Air cleaners	44

39. GENERAL DESCRIPTION AND DATA (figs. 15, 16, and 17).

a. The Armored Car T17 is driven by two Hercules JXD engines (with special front cover, oil pan, oil pump, manifolds, fan, and generator drive, standard No. 4 housing and down-draft carburetor). Each engine is equipped with its own four-speed transmission and clutch.

b. The two engines are mounted side by side in the hull at the rear of the vehicle, with the transmissions toward the front. (Throughout this book, the flywheel or transmission end is referred to as the front. Left or right is as viewed from the rear of the vehicle, when facing the same direction as the armored car is headed.) Either engine can be disengaged in the event it becomes disabled.

c. The following data include the general information and engine characteristics which are frequently required for reference.

- MakeHercules
- ModelJXD
- Weight each, with transmission and accessories (approximate)1,030 lb
- Horsepower110 at 3,200 rpm
- Number of cylinders each engine 6
- Bore 4-in.
- Stroke4¼-in.
- Piston displacement each engine.....320 cu in.
- Compression ratio6.5 to 1
- Direction of rotation (viewed from rear of engine):
 - CrankshaftClockwise
 - StarterCounterclockwise
- Accessory speeds:
 - Generator.....1.73 to crankshaft speed
 - Valve minimum clearance (hot) intake.....0.010 in., exhaust 0.010 in.

ENGINES

Carburetor—make and model (2 used)	Zenith 29-W-12
Numbering of cylinders from rear to front	1-2-3-4-5-6
Firing order	1-5-3-6-2-4

40. ENGINE TROUBLE SHOOTING.

a. If the Engine Fails to Turn Over When Starter Button Is Pressed.

(1) Observe the voltmeter while pressing the starter button. If reading remains unchanged, the starter solenoid is not operating. If the reading drops rapidly to low limit, the battery is undercharged.

(2) Check the specific gravity of the batteries. If reading is 1.225 or less, replace with a fully charged battery and have the discharged battery recharged. If reading is approximately 1.280, the battery is fully charged.

(3) Examine battery terminals for corrosion, battery cable for a short circuit or broken sections. If such conditions exist, clean the terminals and replace the broken cables.

(4) Examine for loose connection at starter motor.

(5) Press the starter button to determine if the starter solenoid is working. Disconnect the battery starter motor cable at the starter motor, and while another person operates the starter button, hold the cable against the housing and observe whether a spark occurs. If no spark is seen, replace the solenoid. If the starter does not operate after replacing solenoid, replace the starter.

b. If the Engine Turns Over but Does Not Start.

(1) See that ignition switch is turned on for that engine.

(2) Check the amount of fuel in fuel tank and be sure the fuel valve is open.

(3) Check fuel flow to carburetors by disconnecting the inlet line to carburetor, and crank engine with starting motor. If no fuel flows, remove fuel pump outlet lines and blow out with air hose.

(4) After it has been determined that fuel is being supplied to carburetors, the ignition system should be checked as follows: Hold neon spark plug tester against each of the six spark plug terminals in turn while engine is being cranked with the starter. A bright flash will show that the distributor, coil, spark plugs, and wire from that terminal are operating satisfactorily. If dim light shows, check wire and spark plug. If the neon tester is not available, the test may be made as follows: Remove the spark plug lead from the spark plug to be tested and hold it approximately $\frac{1}{4}$ inch away from the cylinder head. Turn the engine over with the starting motor and if a good spark is noticed, the circuit is in good condition. Test the other spark plugs in the same

ARMORED CAR T17

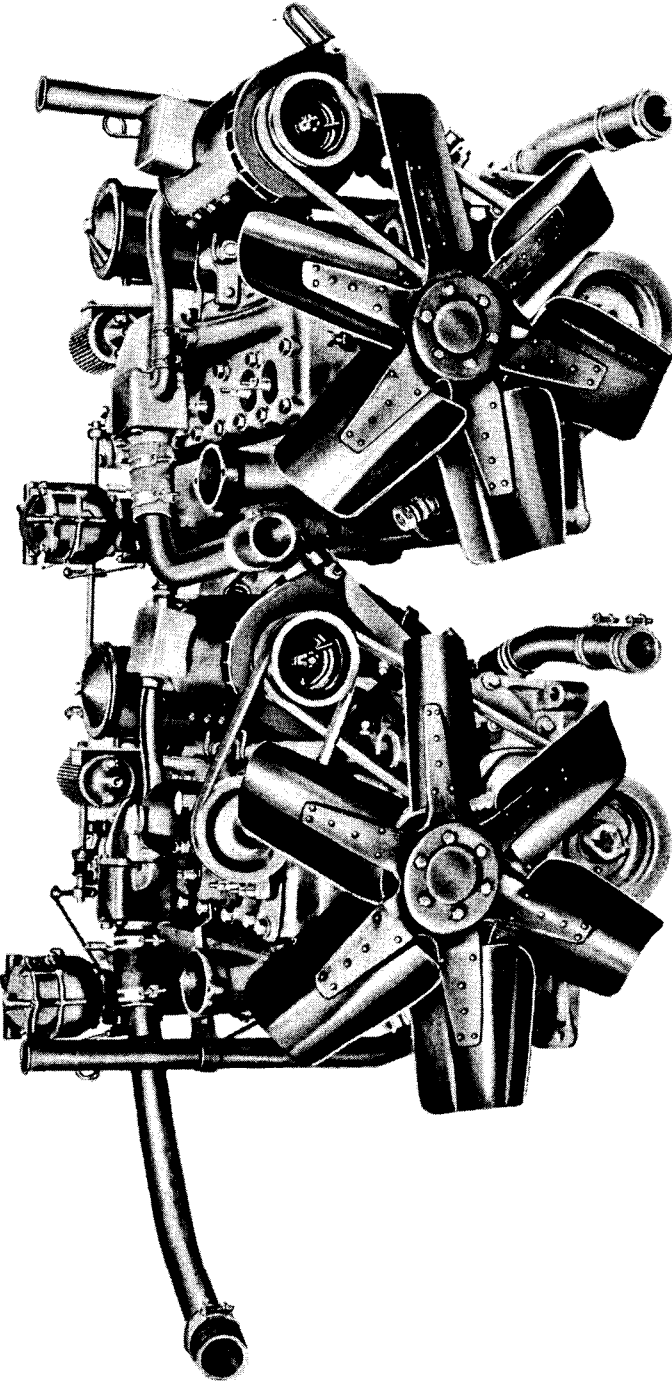

RA PD 27456

Figure 15 — Engines As Viewed from the Rear

ENGINES

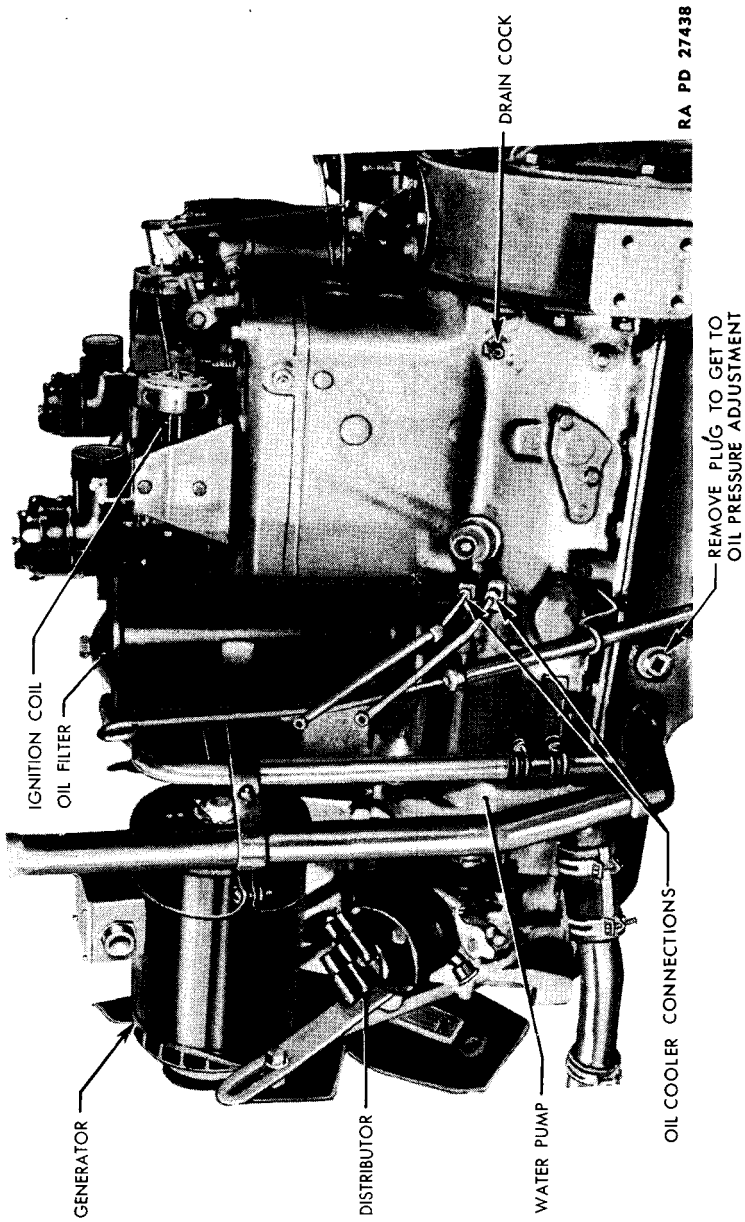
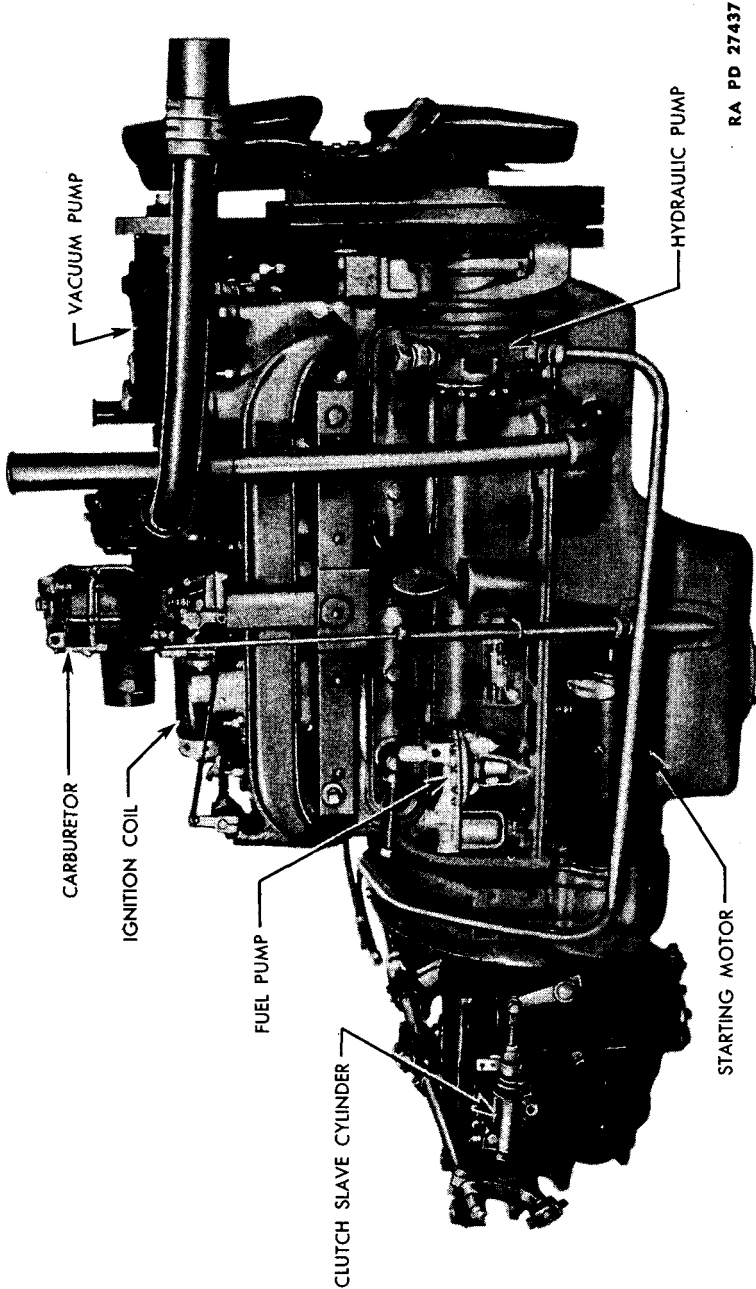

Figure 16 — Right Side of Right-hand Engine

ARMORED CAR T17



RA PD 27437

Figure 17 — Left Side of Left-hand Engine

ENGINES

manner. If testing in the bright sunlight, the spark should be shielded so that it can be seen. If test shows that either of the ignition coils are not operating, replace.

(5) If the engine will not start, notify ordnance personnel.

c. If the Engine Runs Unevenly.

(1) **POOR FUEL MIXTURE.** Too rich a mixture is evidenced by uneven running and black smoke from the exhaust. This may be caused by the carburetor float sticking, high float level, or by a sticking automatic choke. Too lean a mixture is evidenced by uneven running, overheating, or backfiring through the carburetor, and may be caused by vapor lock.

(2) **LEAKS IN INDUCTION SYSTEM.** Examine carburetor intake manifold flanges for tightness. Also examine carburetor gaskets.

(3) **IGNITION TROUBLE.** In general, when only one cylinder misfires, the fault is in the spark plug. The most common plug difficulties are as follows:

(a) *Plug Gap Too Wide.* The distance between the electrodes of the spark plug should be reset to 0.025 inch if over 0.035 inch maximum. A wider gap increases the electrical resistance and interferes with the operation of the engine under load.

(b) *Plug Short-Circuited.* This is usually caused by a cracked or porous insulator, or by fouling of the electrodes or insulator. Any of these conditions will cause misfiring by permitting the current to stray from its intended path.

(c) *Ignition Wires.* Misfiring of one cylinder, either continuous or intermittent, may be due also to a chafed or broken wire. If the wires and plugs are in good condition and yet the ignition is irregular, the trouble is probably with the ignition coil (pars. 62 and 63).

(d) *Damaged Insulating Parts.* It sometimes happens that distributor cap or rotor are damaged through accident or carelessness. These parts should also be carefully examined for possible disarrangement or damage which might permit leakage of current.

(4) **VALVE TROUBLE.** Check the compression of each cylinder with a compression gage. If compression is low, the valves may be sticking or not seating, or the valve clearance may be increased. Check the valve clearances and check for broken springs. Make sure the valves are not sticking.

(5) **POOR FUEL.** Use only the recommended grade of gasoline and see that it flows freely to the carburetor.

(6) **ENGINE OVERHEATING.** Excessive engine temperature may be due to any of the following causes:

ARMORED CAR T17

- (a) Fan belts loose or slipping.
- (b) Air flow restricted through radiator.
- (c) Engine operating on too lean a fuel mixture.
- (d) Engine operating on a retarded spark.
- (e) Engine oil of improper grade or insufficient quality.

41. ENGINE REPLACEMENT.

a. Due to the compactness of the arrangement in the engine compartment it is necessary to remove the engine or engines to gain access to some of the lesser assemblies. Study the job to be done so as to eliminate as much unnecessary removal as possible. The following procedure covers the removal of both engines. When one engine only is to be removed disregard those portions of the procedure that apply to the engine not being removed. The procedure to remove both engines is as follows:

- (1) Remove the engine compartment covers.
- (2) Drain the cooling system, engine oil pans, and all fuel from the gasoline tank.
- (3) In order to remove either radiator and shroud as an assembly, disconnect the fan blades from their hubs by removing the six bolts. Allow the fan blades to stay in the shrouds as the radiators are removed. Remove the lower baffles and both radiators.
- (4) Disconnect and tag all wires from the following units:
 - (a) Oil pressure gage engine units.
 - (b) Water temperature gage engine units.
 - (c) Ignition coil low-tension wires.
- (5) Disconnect oil cooler lines.
- (6) Remove the throttle cross shaft from both engines.
- (7) Remove the batteries and the battery carriers.
- (8) Disconnect the fuel line tubing running to the fuel pumps and remove the fuel tank.
- (9) Disconnect the vacuum tubing running from the engines and the mechanical shift cylinder.
- (10) Remove the hydraulic steering system lines from the engines.
- (11) Remove the transmission remote control shift mechanism from both transmissions.
- (12) Disconnect universal joints from rear of each transmission.
- (13) Disconnect the exhaust lines from each engine.
- (14) Remove the four engine mounting bolts from each engine.
- (15) Install motor sling and lift the engine from the hull.

ENGINES

b. Install Engines. To reinstall the engines, reverse the above procedure, being careful to obtain the correct setting or adjustment of the transmission remote control shift mechanism. Replace fuel, coolant, engine oil, and hydraulic fluid.

42. OIL PUMP.

a. Each engine is equipped with a gear-type oil pump located in the left-hand side of the crankcase. A scavenger pump, located on the same shaft, maintains a flow of oil to the screen on hills. The oil pump provides oil circulation, under pressure, to all connecting rods and crankshaft main bearings and provides a circulation of oil through the fin and tube type oil coolers located in the fighting compartment.

43. OIL FILTER.

a. A cartridge-type oil filter, located on the right-hand side of the engine is provided on each engine (fig. 16). The oil filter cartridges must be replaced when they fail to keep the engine oil clean as outlined in section III. When operating the vehicle under dusty conditions, check the oil filter more frequently.

44. AIR CLEANERS.

a. Two air cleaners of the oil-bath type are located one at the right and one at the left of the fighting compartment mounted on the forward side of the bulkhead. These air cleaners are effective in keeping abrasives out of the engines only if they are properly maintained and filled as outlined in section III.

ARMORED CAR T17

Section XI

FUEL SYSTEM

	Paragraph
General description and data	45
Carburetors	46
Fuel pumps	47
Fuel filter	48
Throttle controls	49
Automatic choke	50

45. GENERAL DESCRIPTION AND DATA.

a. The fuel system consists of a 75-gallon tank located in the engine compartment, a fuel filter, two fuel pumps, two carburetors, two automatic chokes, a hydraulically operated foot throttle control, and the necessary connecting lines.

46. CARBURETORS.

a. **Description.** Two Zenith model 29-W-12 carburetors are used, one on each engine. The carburetor is a single-barrel downdraft unit. It has two floats connected by one lever and operating one needle valve.

b. **Idle Adjustment.** The idle fuel adjustment screw is located on the carburetor cover (fig. 18). The idle speed adjustment likewise is shown (fig. 18).

(1) Make initial idle fuel adjustments with the engine stopped. Seat the idle fuel adjusting screw lightly, then turn out $\frac{5}{8}$ turn. These carburetors are but fairly uniform and this procedure will provide an average adjustment. Start the engine and allow to idle until engine is warmed up.

(2) After engine has warmed up, set idle speed at approximately 400 revolutions per minute, then manipulate the idle fuel adjustment screw from $\frac{1}{2}$ to $1\frac{1}{4}$ turns open until the engine idles smoothly.

(3) Reset the idle speed to 500 revolutions per minute. If engine still does not operate properly, notify ordnance maintenance personnel.

47. FUEL PUMPS.

a. **Description.** Two fuel pumps (one on each engine) are mounted on the crankcases (fig. 19). The pumps maintain a pressure of five pounds to the carburetors.

b. **Maintenance.** At the 1,000-mile inspection, check for leakage at connections and fittings.

FUEL SYSTEM

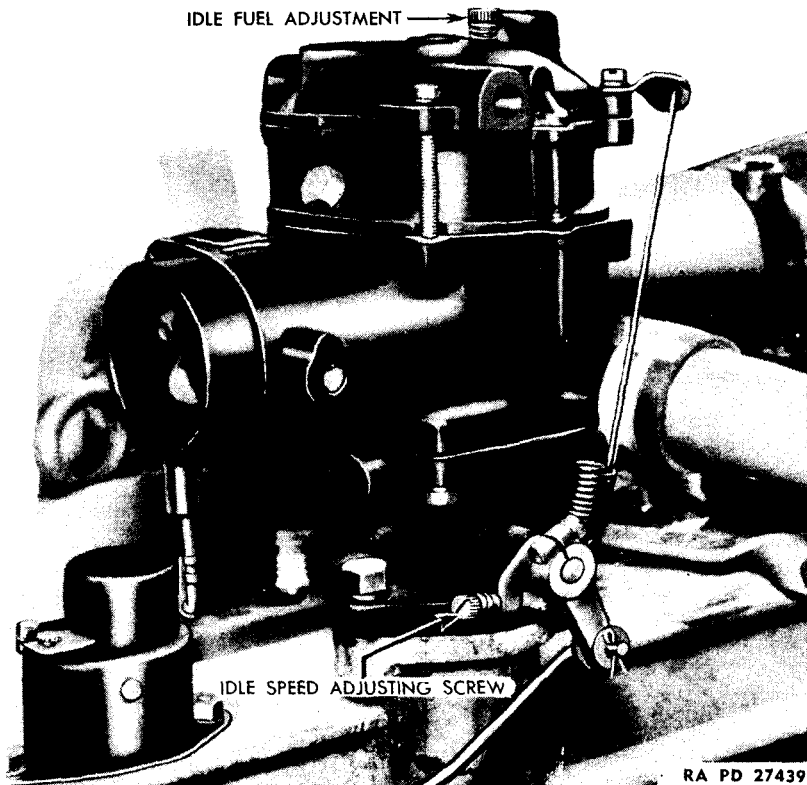

Figure 18 — Carburetor Adjustments

c. Removal. In the event the fuel pump fails to supply a sufficient quantity of fuel, the pump should be replaced with a serviceable unit. The following outlines the procedure to be followed:

- (1) Close fuel shut-off valve.
- (2) Disconnect fuel lines attached to the pump.
- (3) Remove the two screws that hold the pump to the engine and remove the pump.

d. Installation. To install the fuel pump, reverse the procedure outlined in step c of this paragraph, making certain that the mounting gasket is in place.

48. FUEL FILTER.

a. Description. A disk-type (AC) fuel filter, through which all fuel used by both engines passes, is located to the rear of the fuel tank.

ARMORED CAR T17

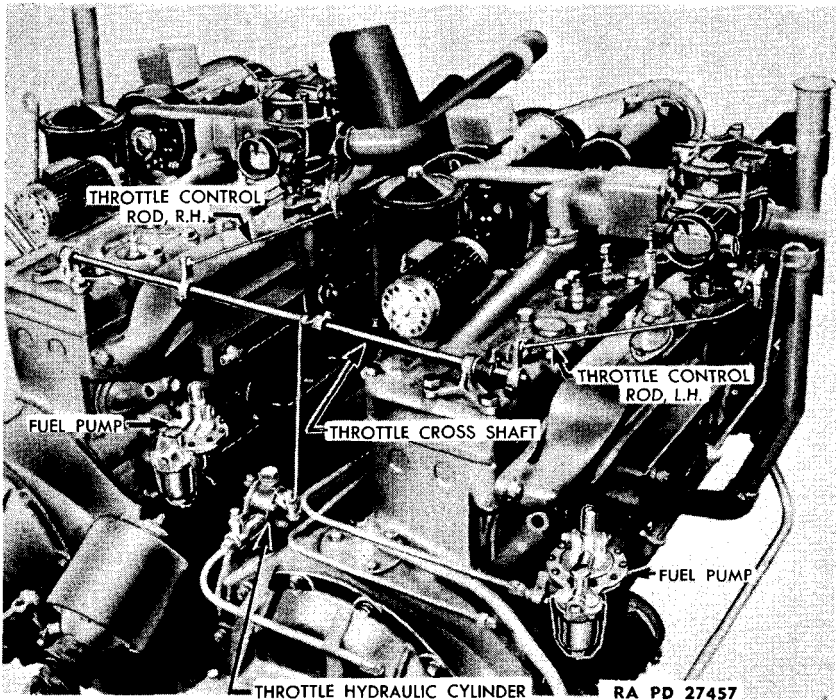

Figure 19 — Throttle Controls

b. Maintenance. Before draining or cleaning of the fuel filter, the fuel shut-off valve between the fuel filter and the fuel tank must be closed. Drain the filter daily and clean the filter disk on each 1,000-mile inspection.

49. THROTTLE CONTROLS.

a. The carburetor throttle plates are controlled by the foot throttle pedal on the floor of the driver's compartment. The movement of the driver's foot actuates a hydraulic cylinder connected to the pedal. The movement of the fluid in the hydraulic line is transmitted to a cylinder located at the right-hand side of the left-hand engine on the flywheel housing (fig. 19). This movement is then transmitted to the throttle cross shaft by direct linkage. On each of these throttle cross shaft levers, throttle control rods actuate the two carburetor throttles together.

50. AUTOMATIC CHOKE.

a. Description. Each carburetor is provided with an automatic choke control which closes the choke plate in the carburetor for cold starting and opens automatically as the engine warms up.

FUEL SYSTEM

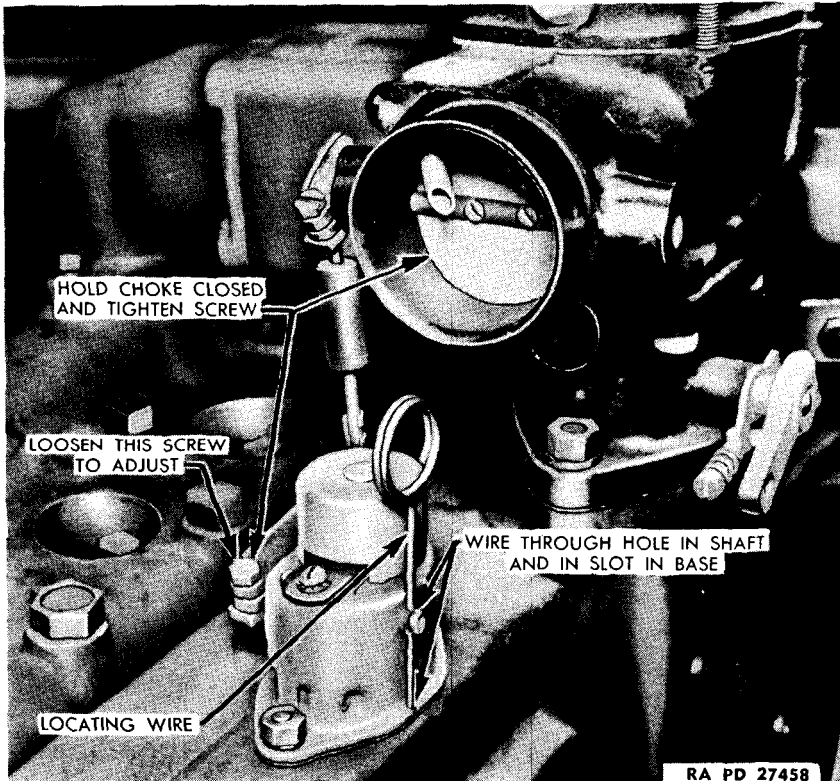

Figure 20 — Automatic Choke Adjustment

b. Adjustment. To adjust the automatic choke control procedure is as follows:

- (1) Loosen the screw holding the control lever to the shaft (fig. 20).
- (2) Install a straight piece of wire through the hole in the shaft, turning the shaft so that the other end of this locating wire is in the slot in the base of the automatic choke (fig. 20).
- (3) Set the lever so that the choke plate is completely closed and tighten the lever to the shaft.
- (4) Remove the locating wire.

ARMORED CAR T17

Section XII

COOLING SYSTEM

	Paragraph
General description and data	51
Radiators	52
Water pumps	53
Fans	54
Thermostats	55

51. GENERAL DESCRIPTION AND DATA.

a. Description. Each engine cooling system is independent of the other. The cooling systems each use a pressure cap that permits temperatures up to 225 degrees before the boiling point of the water is reached. The two radiators are located vertically, each behind its own engine. The water is circulated by means of a water pump through the engine when the thermostat is open and is bypassed around the engine when the thermostat is closed. Each engine is equipped with a pusher-type fan which draws air from the engine compartment, forcing it out through the tubes of the radiator. The radiators must be cleaned periodically, as described in paragraph 22 b (6).

b. Inhibitor. Use only clean soft water or rain water and the recommended types of antifreeze, having a suitable inhibitor in the cooling system to prevent corrosion and rusting. In the event soft or rain water is not available, a suitable inhibitor must be used.

c. Capacity. The capacity of the entire cooling system is 46 quarts — 23 quarts for each engine.

d. Drains. A petcock is provided on each radiator for draining the cooling system. A drain cock is provided on the right-hand side of each engine (fig. 16). To completely drain the cooling system, both the radiator and the cylinder block drain cocks should be open.

52. RADIATORS.

a. The radiators are of the fin and tube type, with the tubes running horizontally. An arrangement of armor plate louvers protect the radiator cores from the rear. Shrouds are provided around the fans to direct the flow of air through the radiator.

53. WATER PUMPS.

a. Two water pumps, one for each engine, provide circulation of the water through the cooling system at all times. The water pumps are of

COOLING SYSTEM

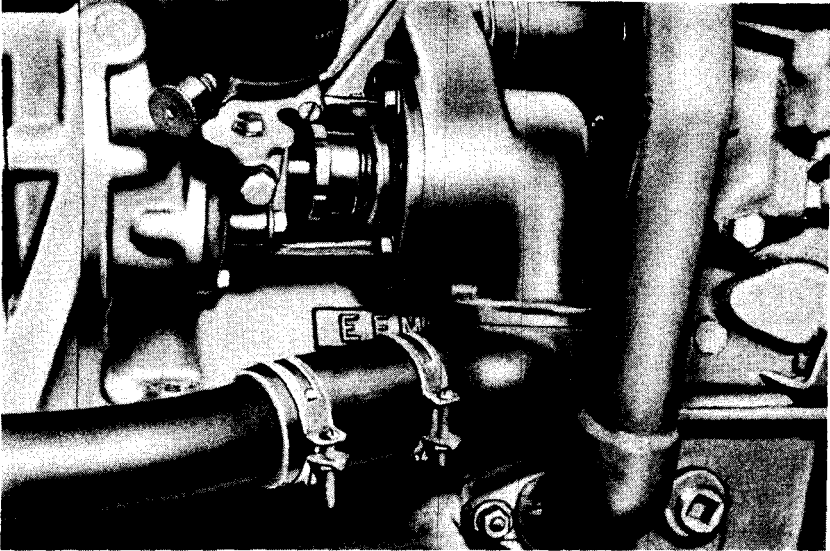

Figure 21 — Water Pump

RA PD 27459

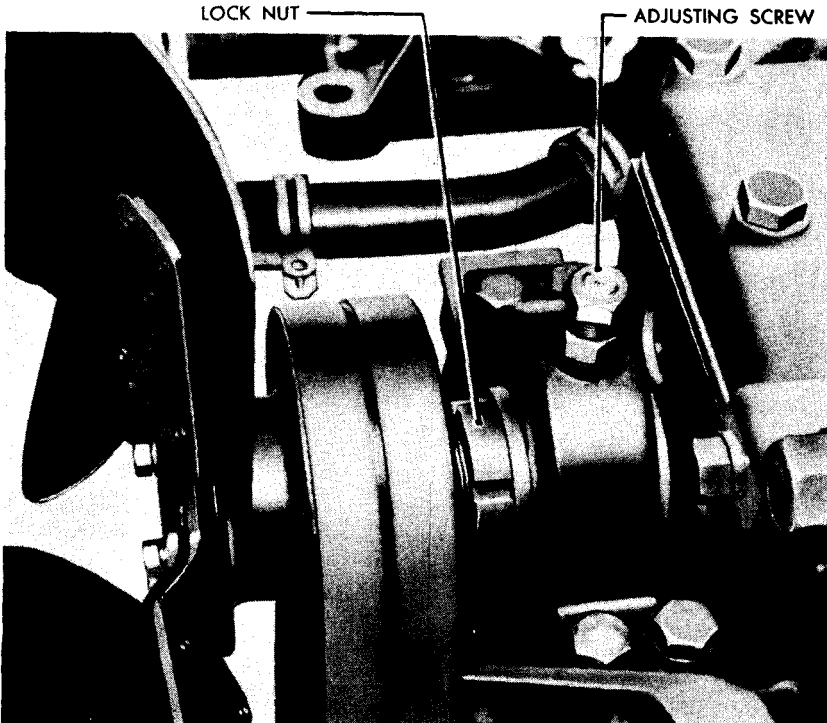

Figure 22 — Fan Belt Adjustment Screw

RA PD 27460

ARMORED CAR T17

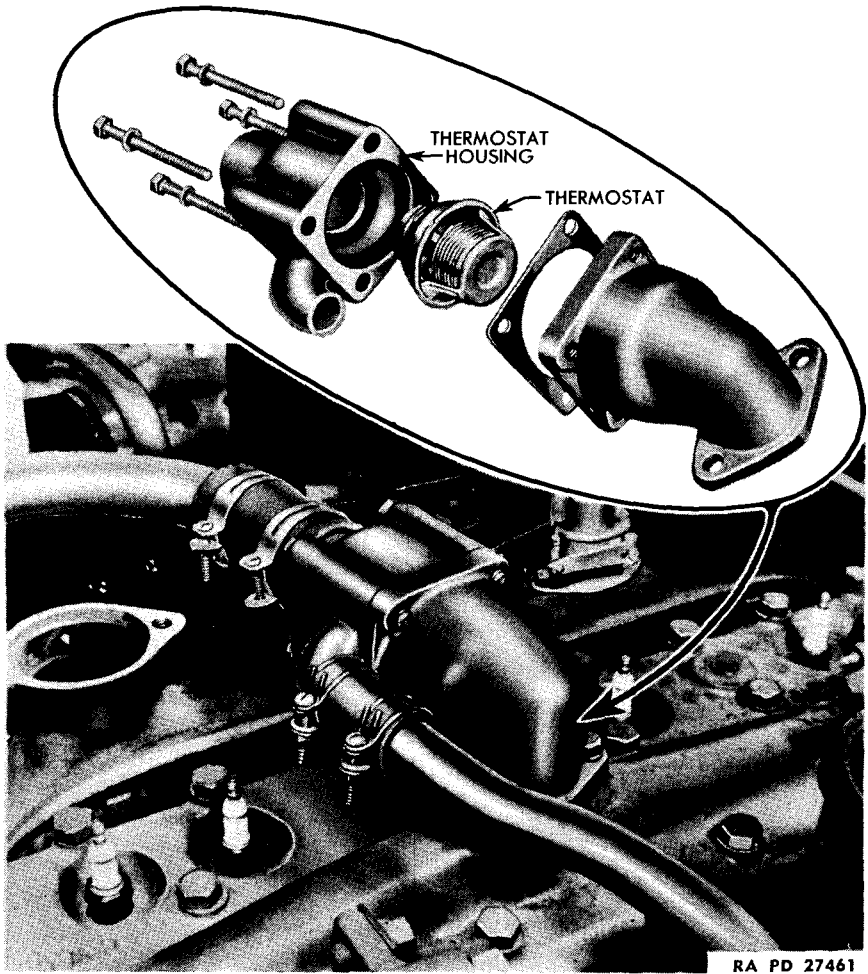

Figure 23 — Thermostat

the high-velocity, centrifugal type and are located on the right-hand side of each engine at the rear (fig. 21).

54. FANS.

a. **Description.** Each engine is equipped with a 22-inch 6-blade, pusher-type fan located at the rear of the engine. The fan is driven by two V-type belts from the crankshaft pulley (fig. 25).

b. **Belt Adjustment.** Fan belt adjustment is correct when a movement of one inch (fig. 25) is possible. To adjust the belts, proceed as follows:

COOLING SYSTEM

(1) Loosen the lock nut with a spanner wrench (fig. 22).

(2) Raise or lower the fan as may be required by means of the adjusting screw (fig. 22) until the correct adjustment is obtained. The fans are a fairly close fit in their shrouds and it will be necessary to adjust the shrouds up or down to provide clearance.

(3) Tighten the fan belt adjustment lock nut.

55. THERMOSTATS.

a. Description. Each engine is equipped with a bellows-type thermostat that starts to open at 160 degrees and is fully open at 176 degrees (fig. 23). When the thermostats are closed, the water from the water pump is recirculated through the engine and not through the radiator.

b. Removal. To remove the thermostats, proceed as follows:

(1) Drain the cooling system to a level below the top of the cylinder head.

(2) Remove the four screws holding the thermostat housing and remove the housing casting. The thermostat can now be lifted out (fig. 23).

(3) If inoperative for any reason, replace with a serviceable unit.

ARMORED CAR T17**Section XIII****ELECTRICAL SYSTEM**

	Paragraph
General description	56
Batteries	57
Generators	58
Generator regulators	59
Starting motor	60
Distributor	61
Ignition coil	62
Spark plugs	63
Lamps	64
Siren	65
Instrument panel	66

56. GENERAL DESCRIPTION.

a. The electrical system of the Armored Car T17 is a 24-volt system. Actual voltage range from 28½ to 30 volts. Each engine is equipped with a 1,500-watt generator. All units of the electrical system, with the exception of the blackout head lamps, are 24-volt capacity. The blackout head lamp is 6 volts. Figure 32 is a wiring diagram of the vehicle.

57. BATTERIES.

a. **Description.** Two 12-volt storage batteries, connected in series, are located in the engine compartment, one on each side of the fuel tank. Each of these batteries have 25 plates per cell with a positive plate area of 9,000 square inches. The batteries are equipped with "Non-Spill" filler plugs. The capacity of each battery is 168-ampere hours at the 6-hour rate.

b. Maintenance.

(1) **CARE.** Battery terminals and terminal posts will be frequently checked, cleaned, and coated with PETROLATUM. Check the battery fluid level once a week and after every long run. Maintain the level to ¼ inch above the top of the plates by adding distilled water. Take a specific gravity reading every 25 hours, and exchange a battery having a specific gravity of 1.225 or less at 80 F for a fully charged one.

(2) **CAPACITY AND TEMPERATURE DATA.** At temperatures below freezing, the load on the battery becomes greater and the relative capacity of the battery is reduced. For this reason, when low tempera-

ELECTRICAL SYSTEM

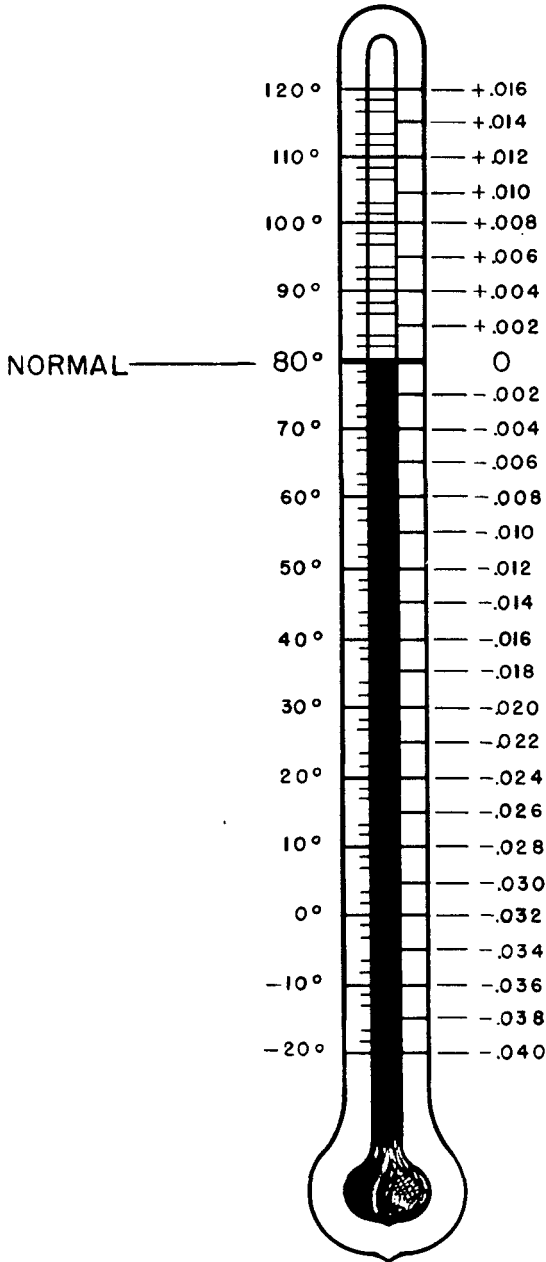

RA PD 5851

Figure 24 — Hydrometer Temperature Correction Chart

ARMORED CAR T17

tures prevail, it will be necessary to maintain the specific gravity of the battery electrolyte at 1.250 or higher and to replace the battery when its gravity reading is below that point. The following data shows the capacity of the batteries and the relative freezing point of the electrolyte.

Battery charged	1.285	-96 F
Battery $\frac{1}{3}$ discharged	1.255	-60 F
Battery $\frac{1}{2}$ discharged	1.220	-31 F
Battery $\frac{3}{4}$ discharged	1.185	- 8 F
Battery normally discharged	1.150	+ 8 F
	1.100	+18 F

(3) To determine the actual specific gravity of the electrolyte, it is necessary to check the temperature of the solution with a thermometer. If the temperature is normal (80 F) the specific gravity reading will be correct. However, if the temperature is above or below 80 F it will be necessary to make an allowance to determine the actual specific gravity. This is due to the fact that the liquid expands when warm, and the same volume weighs less than when it is at normal temperature. The reverse is also true, and when the temperature is below normal or 80 F the liquid has contracted and the same volume weighs more than it does when normal. The correction chart (fig. 24) shows the figures to be used to make these corrections. For example, when the specific gravity, as shown by the hydrometer reading is 1.290 and the temperature of the electrolyte is 60 F, it will be necessary to subtract 8 points or 0.008 from 1.290, which gives 1.282 as the actual specific gravity. If the hydrometer reading shows 1.270 at a temperature of 110 F, it will be necessary to add 12 points or 0.012 to the reading, which gives 1.282 as the actual specific gravity.

58. GENERATORS.

a. Description. Two special Ford generators, model D-67228 are used. Each generator is 30-volt, 50-ampere capacity, and current control is obtained by a generator regulator mounted on the side of the hull in the engine compartment, one for each generator. An automatic circuit breaker is located on the cover of the terminal housing on the generator. The generators are driven by V-belts (fig. 25).

b. Lubrication. Generators are properly lubricated at engine overhaul periods and should not require additional lubricant between overhaul periods.

c. Belt Adjustment. The generator belt is properly adjusted when one inch of movement can be obtained with the thumb and fingers at point shown in figure 25. To adjust the belt loosen the adjustment lock bolt and raise or lower the generator as required to obtain the correct adjustment. Retighten the lock bolt.

ELECTRICAL SYSTEM

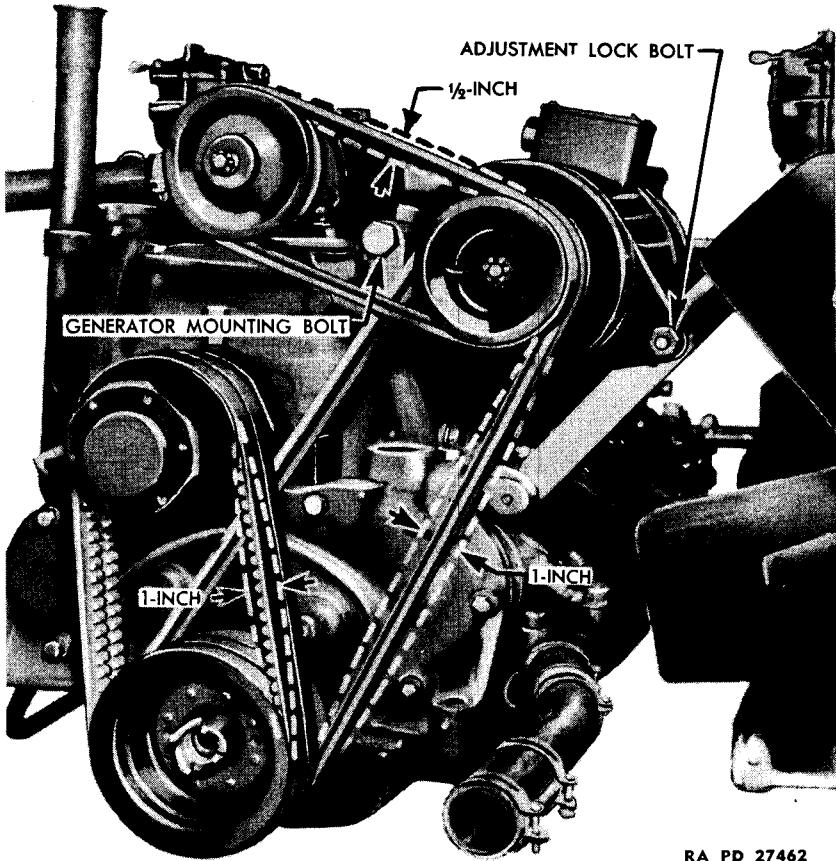

RA PD 27462

Figure 25 — Belt Arrangement

d. Removal. A faulty generator should be replaced as follows:

- (1) Disconnect wires from armature and field terminals.
- (2) Disconnect the flexible conduit.
- (3) Remove the belt adjustment lock bolt.
- (4) Remove the generator belt (on left-hand engine remove the vacuum pump belt also).
- (5) Remove the two mounting bolts and the generator.

e. Installation. To install the generator, reverse the procedure outlined above and adjust the belt.

59. GENERATOR REGULATORS.

a. Description. A three-unit type generator regulator, mounted on each side of the hull, is provided for each of the two generators and

ARMORED CAR T17

includes a voltage regulator, current limitator, and a reverse current relay or cut-out.

(1) **THE VOLTAGE REGULATOR** unit maintains the output of the generator at a constant predetermined voltage of 30 volts (at 70 F ambient). The current output on the generator is automatically varied in accordance with the state of charge of the battery and the amount of current being used throughout the vehicle. Thus, the proper charge is delivered to the battery at all times without danger of overcharging.

(2) **THE CURRENT LIMITATOR** unit limits the current output of each generator to 55 amperes (at 70 F ambient).

(3) **THE REVERSE CURRENT RELAY OR CUT-OUT** prevents the battery from discharging when the generator is at rest, or when it is not developing normal voltage. The cut-out points close at 26 volts (at 70 F ambient).

b. Inspection and Adjustments. When properly installed and operated, the generator regulator will not require any adjusting. If the regulator fails to regulate the voltage as it should, or to control the amperage, and it has been determined that the trouble is not caused by loose connection or faulty generator, the unit should be replaced. To replace the regulator unit, remove the cover from the junction box and disconnect the wires and conduit, then remove the four screws holding the regulator to the hull.

60. STARTING MOTOR.

a. Description. The starting motor is a 24-volt type mounted on the left side of the flywheel housing and its power is transmitted to the engine through an automatic drive. A solenoid switch closes the electric circuit to the starting motor when the starter button on the instrument panel is pressed. Rotation of the starter motor shaft causes the pinion of the automatic drive to advance and mesh with the flywheel. After the engine starts and the speed of the flywheel exceeds that of the starter motor, the pinion releases the flywheel automatically. The starting motor bearings do not require lubricating.

61. DISTRIBUTOR.

a. Description. Each engine uses a (Electric Auto-lite) six-cylinder distributor mounted on the right-hand side of the engine at the rear (fig. 16).

b. Tabulated Data.

Rotation Clockwise
Initial advance (crankshaft degrees) 2 deg

ELECTRICAL SYSTEM

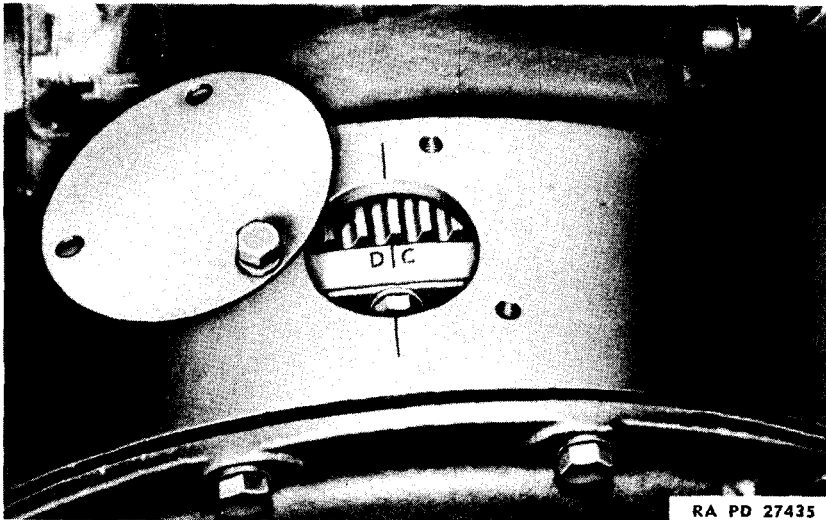

Figure 26 — Timing Marks on Flywheel

Maximum advance (degrees of distributor at distributor rpm)	11½ at 1,600
Advance starts at (distributor rpm).....	400
Breaker arm spring tension.....	17 to 20 oz
Breaker points spacing	0.020-in.

c. Ignition Timing. To time the ignition with engine, proceed as follows:

- (1) Remove all six spark plugs to relieve the compression. (Be extremely careful that nothing drops in the spark plug holes.)
- (2) Remove the inspection cover from the top of the flywheel housing (fig. 26).
- (3) Make sure the transmission is in neutral.
- (4) Use a compression gage in, or cover No. 1 spark plug hole with your thumb and turn the engine by means of the fan blades until the No. 1 cylinder is coming up on the compression stroke. Then, continue to turn carefully until the "DC" (dead center) mark on the flywheel lines up exactly with the index mark on the flywheel housing (fig. 26). This will place No. 1 cylinder on exactly top dead center.
- (5) Remove the distributor cap.
- (6) Place the center line of the distributor rotor over the timing line marked "NO. 1" on the internal cover plate (fig. 27).
- (7) Maintain the hold-down arm approximately 25 degrees counter-clockwise from the grease cup and remove the hold-down cap screw.

ARMORED CAR T17

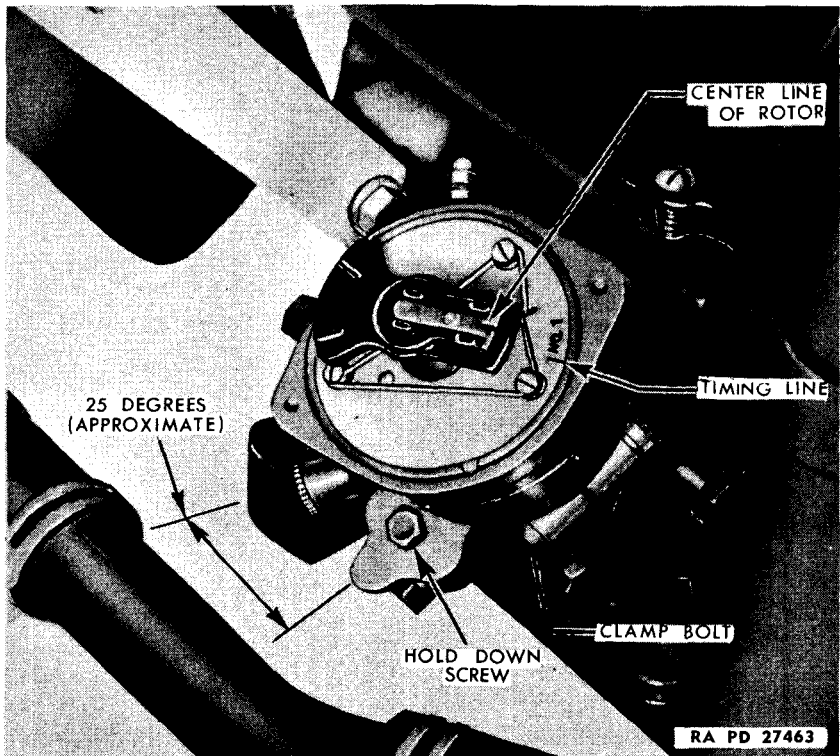

Figure 27 — Distributor With Cap Removed

(8) Insert the distributor in the mounting hole and “feel out” gear tooth mesh until hold-down arm is over the rear hole in the mounting bracket. If necessary, let the rotor shift a little from the No. 1 marking.

(9) Insert and tighten the hold-down screw.

(10) Loosen the clamp bolt on the hold-down arm.

(11) Rotate the distributor body until the center line of the rotor again lines up with the No. 1 mark on the plate.

(12) Install the distributor cap and all wires and turn ignition on.

(13) Hold the spark plug end of No. 1 spark plug $\frac{1}{8}$ inch away from the cylinder.

(14) Turn the engine over until timing mark on the flywheel is $\frac{1}{4}$ inch in advance of the index mark.

(15) Rotate the distributor to the point where the spark occurs between No. 1 spark plug wire and the cylinder head, and tighten the clamp bolt. The engine will then be timed two crankshaft degrees advanced.

(16) Reinstall the spark plugs.

ELECTRICAL SYSTEM

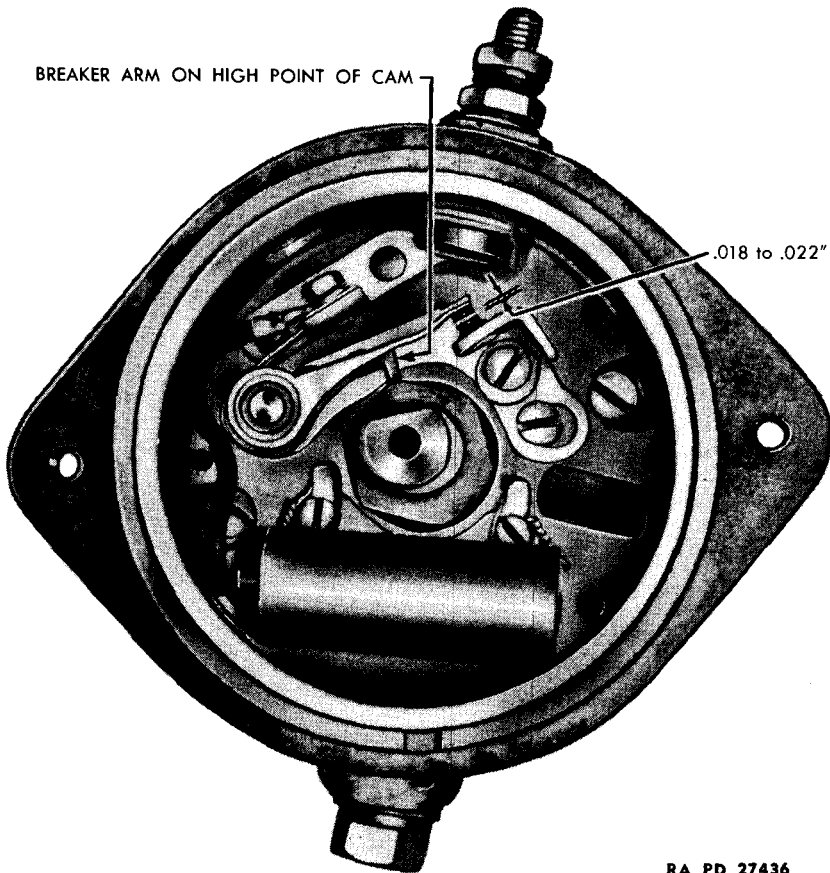

Figure 28 — Distributor Points

62. IGNITION COIL.

a. An Electric Auto-lite ignition coil is provided for each engine. The coil is mounted on the right-hand side of each cylinder head, toward the rear (fig. 16). This is the conventional automotive-type ignition coil, except these coils are designed for 24-volt system and are provided with cooling fins, ballast resistor, and are oil-filled. Therefore, they must be horizontally mounted.

63. SPARK PLUGS.

a. The spark plugs are "Champion" J-10 type. The correct spacing for these plugs is 0.025 inch.

64. LAMPS.

a. The front slope of the vehicle mounts either two service head-

ARMORED CAR T17

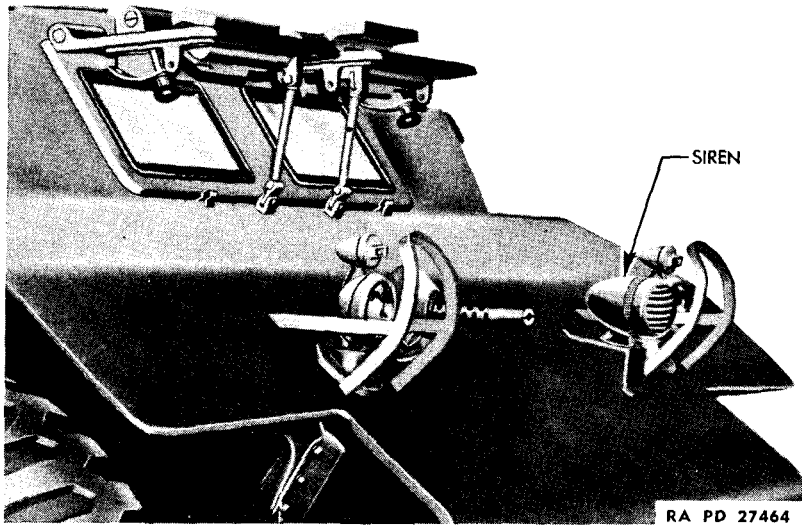

Figure 29 — Head Lamps and Siren

lamp and blackout marker lamp combination (fig. 29), controlled by the light switches on the instrument panel (fig. 4) or a blackout head lamp controlled by the blackout light switch on the instrument panel. When changing from one type to the other, pull out head lamp lock and turn $\frac{1}{4}$ turn. Head lamp assembly can be lifted out. When neither the service head lamps or the blackout head lamp is used, be sure the plug provided is inserted in the socket to protect the terminals.

b. Service Head Lamps. The service head lamps are used when there is a possibility that illumination ahead can be used with safety and permit immediate change to blackout marker lights. The service headlight reflectors, however, can pick up and reflect back other lights and, under certain conditions, the service head lamps should be removed and the blackout head lamp or the plug installed in the sockets.

(1) **HEAD LAMP BULB.** The service head lamp uses a sealed-beam, 24-volt, single filament bulb. Remove as follows:

(a) Remove screw attaching lens rim to body of head lamp and remove the rim.

(b) Remove the sealed-beam bulb.

(c) Reverse the above procedure to install new bulb.

(2) **BLACKOUT MARKER BULB.** The blackout marker lamps, mounted on top of both the service head lamps and the blackout head lamps, use a single contact, 24-volt bayonet base, 3-candlepower bulb. To replace the bulb proceed as follows:

ELECTRICAL SYSTEM

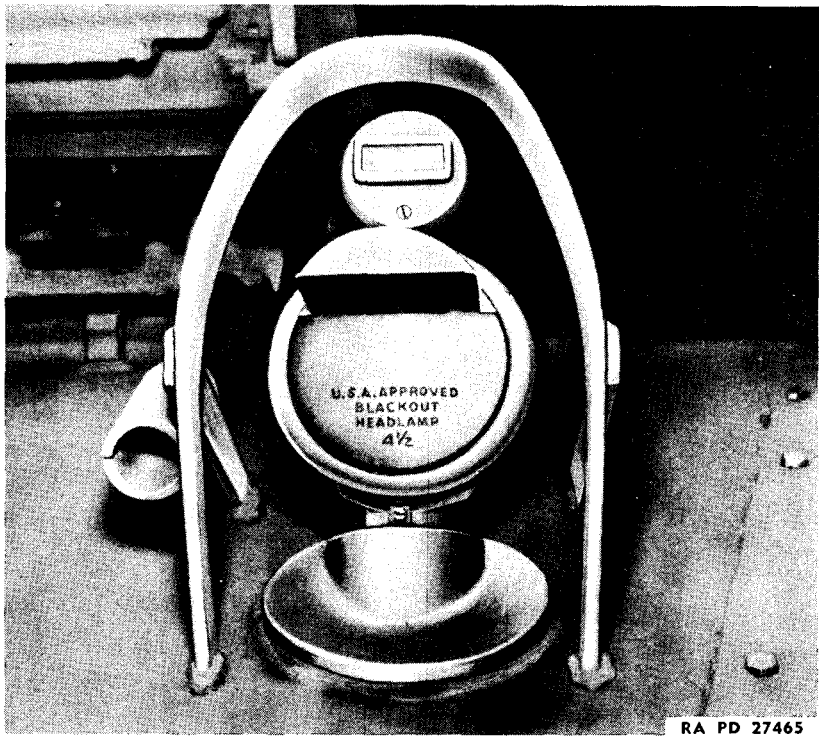

Figure 30 — Blackout Head Lamp

(a) Remove screw attaching lens frame to body of lamp and remove the frame.

(b) Press bulb in and turn slightly counterclockwise and pull bulb out of socket.

(c) Replace bulb by reversing above procedure.

c. Blackout Head Lamp. The blackout head lamp (fig. 30) throws a thin flat beam of light that cannot be seen from above, yet provides enough illumination to permit missing most obstacles. The bulb is of the sealed-beam type with only a narrow strip of lens exposed and a hood at the top. The bulb is 6-volt, 10-candlepower, and a resistor is included in series in the circuit that permits it to be used in a 24-volt system. To replace the blackout head lamp bulb proceed as follows:

(1) Remove the screw attaching the rim to the blackout head lamp body and remove the rim.

(2) Disconnect the wire from the terminal on back of the bulb.

ARMORED CAR T17

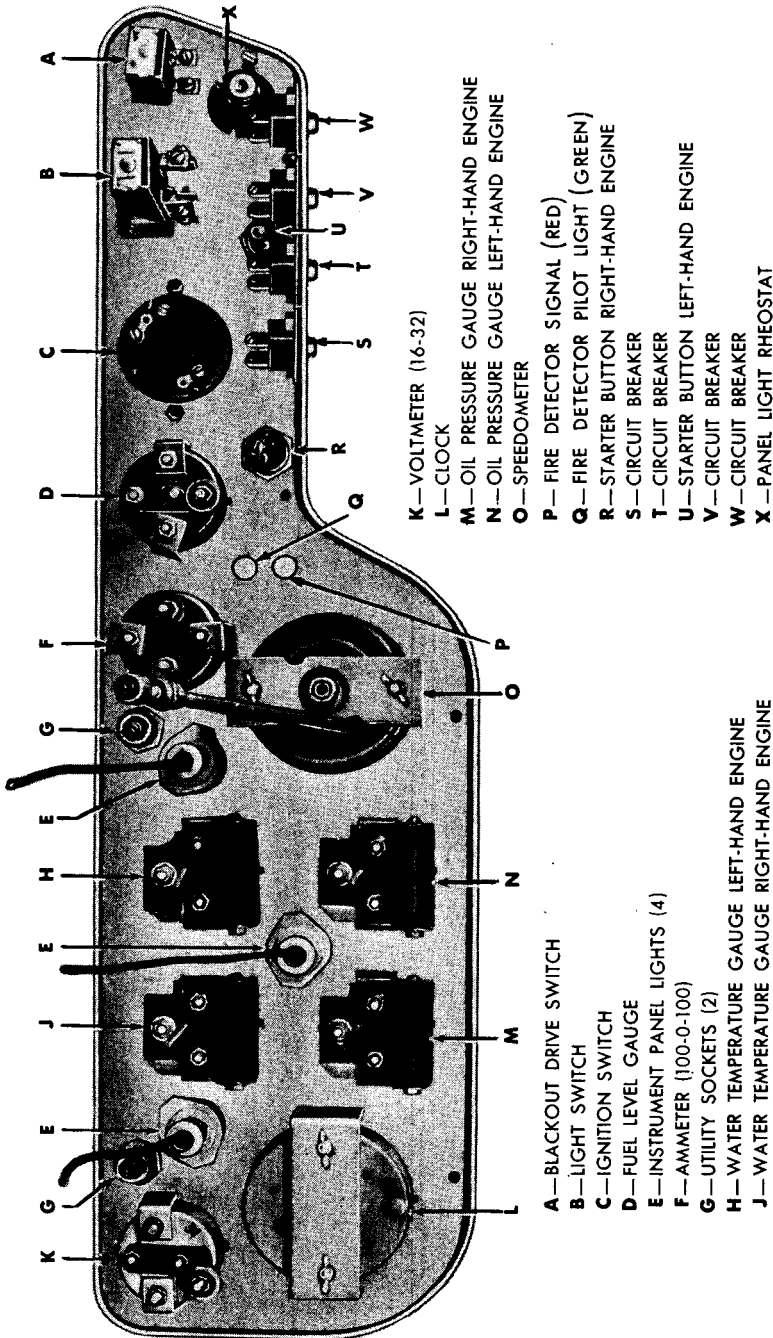

RA PD 27434

Figure 31 — Back of Instrument Panel

ELECTRICAL SYSTEM

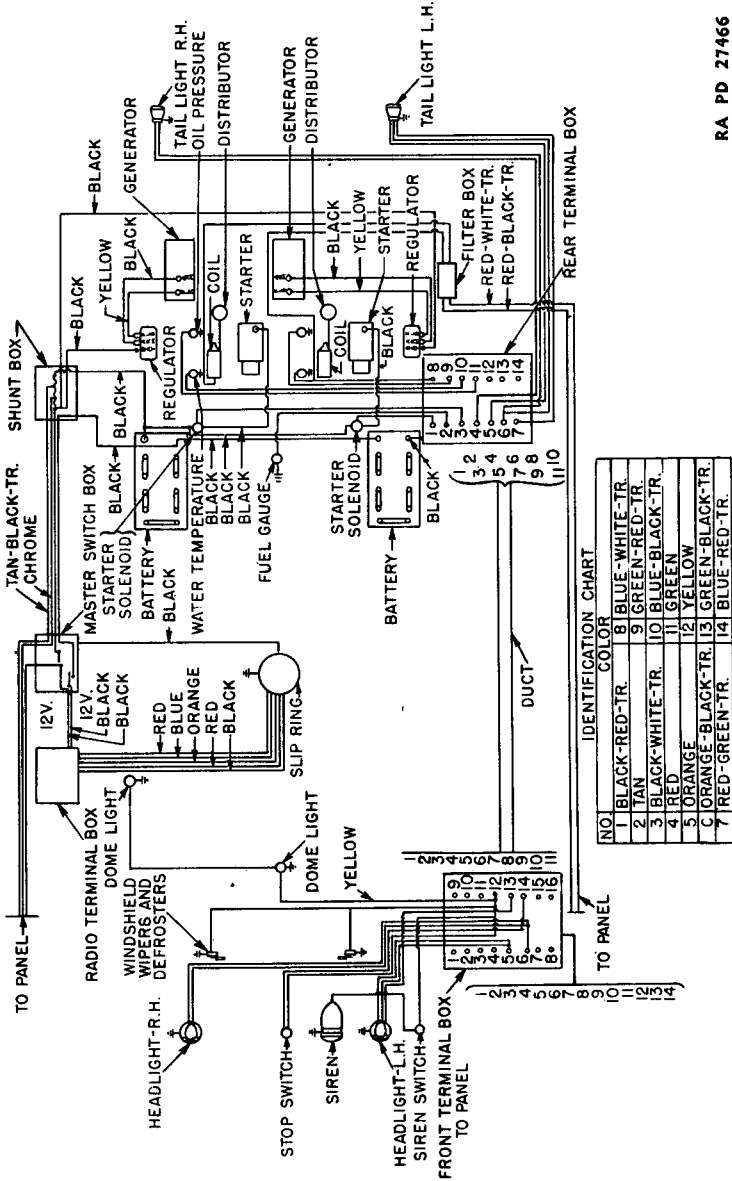

RA PD 27466

Figure 32 — Wiring Diagram of Armored Car T17

ARMORED CAR T17

(3) With a screwdriver, unhook the six wire retainers and remove the bulb.

(4) Reverse the above procedure to install a new bulb assembly.

d. Tail Lamps. A tail lamp is mounted in the rear, on each side. The lamps in the two tail lamps are operated by the light switch on the instrument panel. Each tail lamp consists of two sealed units, having pronged-type electrical connections to the filaments. The two sealed units for each lamp are held in place by a frame, attached to the metal housing or body of the lamp with a screw. The left tail lamp assembly has three filaments, for service, blackout tail and service stop light respectively. The right tail lamp has two filaments for blackout stop and blackout tail respectively. Use the following procedure in replacing the tail lamp or the sealed-beam lamp:

(1) **REPLACEMENT.**

(a) *Sealed Lamp Bulb Unit.* Remove screw attaching lens frame to body of tail lamp and remove frame. Pull the defective sealed lamp unit straight out to remove it. Reverse the above procedure to install a new sealed lamp unit.

(b) *Tail Lamp.* Disconnect the conduit coupling and pull out plug-type wire connector. Remove the lock nut. Remove two bolts and nuts fastening tail lamp to the tail lamp support bracket. Remove the tail lamp and disconnect the wire connector plugs. Reverse the above procedure to install a new tail lamp.

65. SIREN.

a. A siren, operated by a foot switch in the driver's compartment, is mounted on the front slope of the vehicle (fig. 29). Use the following procedure to replace a defective siren:

(1) Disconnect conduit coupling from bulkhead connector in front armor sloping plate and pull out plug.

(2) Remove two cap screws holding siren to mounting bracket. Remove siren.

(3) Reverse the above procedure to install a new siren.

66. INSTRUMENT PANEL.

a. The instrument panel is located directly in front of the driver. The use of the various instruments and devices are completely covered in paragraph 6. Figure 31 shows the back side of the panel with the various instruments in place and should assist in the replacements of any of the instruments. When replacing any of the instruments, be sure to tag the various wires so as to insure the correct reinstallation.

Section XIV

PROPELLER SHAFTS

Paragraph

Propeller shafts	67
Universal joints	68

67. PROPELLER SHAFTS.

a. Six propeller shafts are used to transmit the power from the engine to the transfer case and from the transfer case to each of the three axles (fig. 33). Each propeller shaft is provided with a slip joint. The power line, running from the transfer case to the rear axle, consists of a propeller shaft running from the transfer case to a pillow block on the intermediate axle and another propeller shaft running from the pillow block to the rear axle.

68. UNIVERSAL JOINTS.

a. A universal joint is provided on each end of the propeller shaft (fig. 33). Due to the angle at which these universal joints must operate, it is important that they receive regular preventive maintenance inspection and lubrication, as outlined in section III.

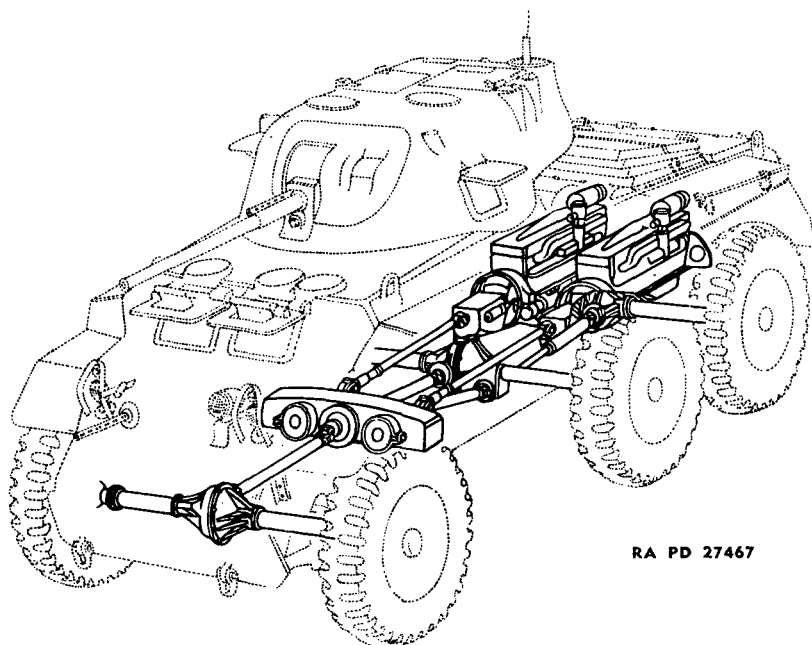

RA PD 27467

Figure 33 — Engines, Transmissions, Transfer Case and Drive Lines Arrangement

ARMORED CAR T17

Section XV

TRANSMISSION AND CLUTCH

	Paragraph
Transmissions	69
Clutches	70
Clutch adjustment	71

69. TRANSMISSIONS.

a. Description. Each engine is equipped with a Warner Gear Company four-speed transmission fitted for remote shifting control (figs. 34 and 35). These transmissions are of the synchronized, selective sliding-gear type. Ratios in the various gears are as follows:

First	6.499 to 1
Second	3.543 to 1
Third	1.752 to 1
Fourth	1 to 1
Reverse	6.987 to 1

b. Replacement. The transmission is removed from the engine after the engine has been removed from the hull, as outlined in section X, by removing the transmission to flywheel housing bolts.

70. CLUTCHES.

a. Description. Each engine is equipped with a Long Manufacturing Company dry type, single plate clutch, model No. 12 CB-C. The clutch friction facings are 12 inches in diameter. The total friction area is 149.3 square inches. The clutch pressure plate is adjusted, and the release levers locked, at the factory. No adjustment is required other than to maintain the clearance between the release fork and the release bearing, as outlined below.

71. CLUTCH ADJUSTMENT.

a. Description. The clearance between the clutch release bearing and the clutch release fork must be maintained at all times. Failure to maintain the clearance will result in burning out the clutch and clutch release bearing.

b. Procedure. To establish the proper amount of clearance proceed as follows: Remove the clevis pin from the clevis release lever (fig. 36). With the clutch operating hydraulic cylinder in release position $\frac{1}{4}$ -inch movement of the clutch release lever should be possible before

TRANSMISSION AND CLUTCH

BOTH TRANSMISSIONS CONNECTED TO SHIFT MECHANISM

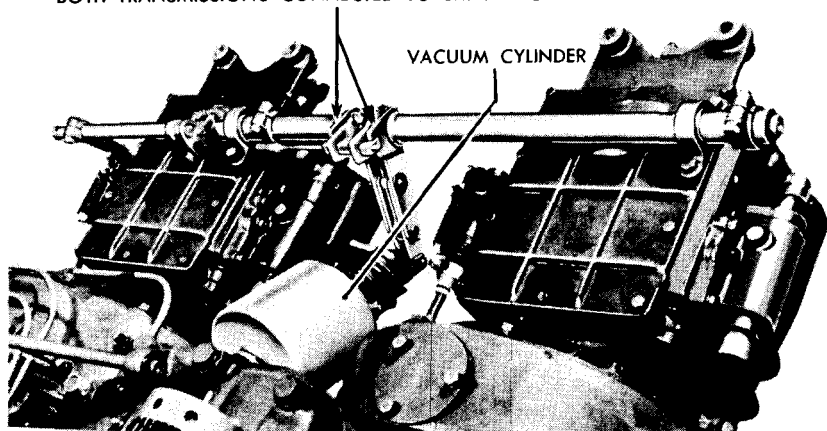

RA PD 27468

Figure 34 — Gearshift Mechanism

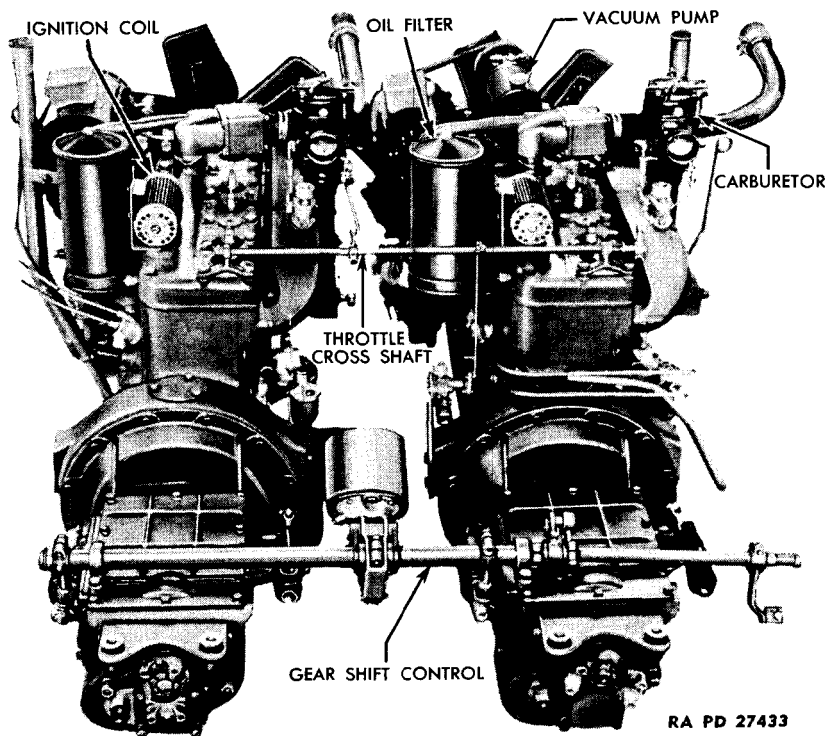

RA PD 27433

Figure 35 — Front View of Engines and Transmissions

ARMORED CAR T17

the clutch release fork contacts the release bearing. Adjust the length of the clutch operating hydraulic cylinder clevis rod until correct clearance is obtained.

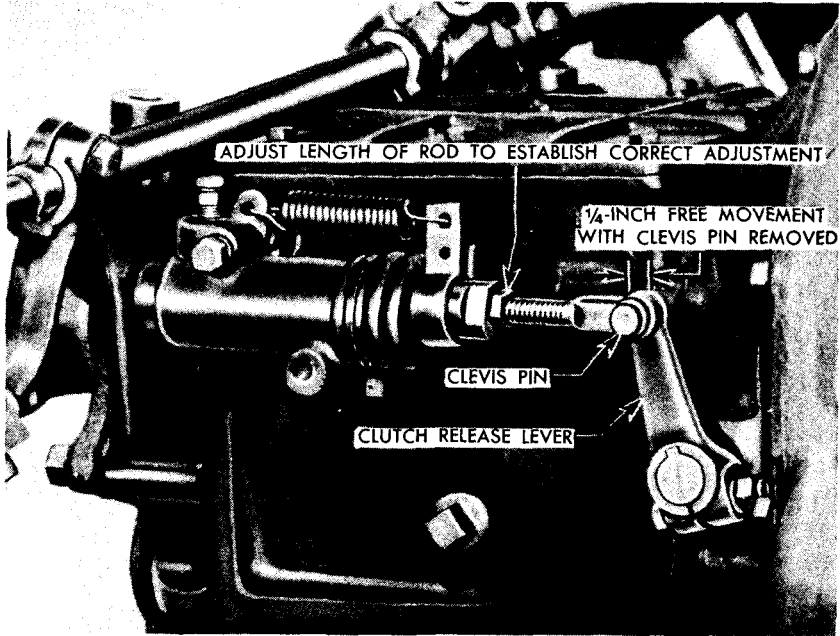

RA PD 27469

Figure 36 — Clutch Adjustment

Section XVI

TRANSFER CASE

Paragraph

Transfer case 72
 Transfer case replacement 73

72. TRANSFER CASE.

a. Description. A Warner two-speed transfer case is used in the Armored Car T17 (fig. 37). The transfer case is provided with three throwouts, one for the front axle and one for either engine. Two ratios are provided: 1.037 to 1 in high or 1.941 to 1 in low.

b. Controls. Complete instructions for the operation of the transfer case controls are given in section II. Always shift the transfer case to neutral when the vehicle is being towed.

c. Lubrication. A gear-type oil pump is provided in the transfer case which circulates the transfer case oil through a fin and tube cooler mounted on the bulkhead to the rear of the fighting compartment. See section III for capacities, lubricants, and intervals at which the transfer case should be lubricated.

73. TRANSFER CASE REPLACEMENT.

a. Removal. Use the following procedure to remove the transfer case from the hull:

- (1) Disconnect all wires running from the turret basket to the turret, by pulling out the plugs.
- (2) Disconnect the firing mechanism in the turret and the manual control.
- (3) Take out the turret to basket bolts and remove the turret.
- (4) Remove the slip ring straps under the turret basket floor and disconnect the wiring.
- (5) Remove the turret basket to hull bolts and remove the basket.
- (6) Disconnect and remove the hand brake cross rods running from the transfer case to the side bracket on the hull (fig. 37).
- (7) Remove the drag links running to the transfer case shifter housing (fig. 37).
- (8) Disconnect and remove the oil tubing running from the transfer case to the oil cooler.
- (9) Disconnect the transfer case end of the speedometer cable (fig. 37).
- (10) Disconnect the front axle propeller shaft at the front axle end.
- (11) Disconnect and remove the propeller shaft running from the transfer case to the pillow block on the intermediate axle.

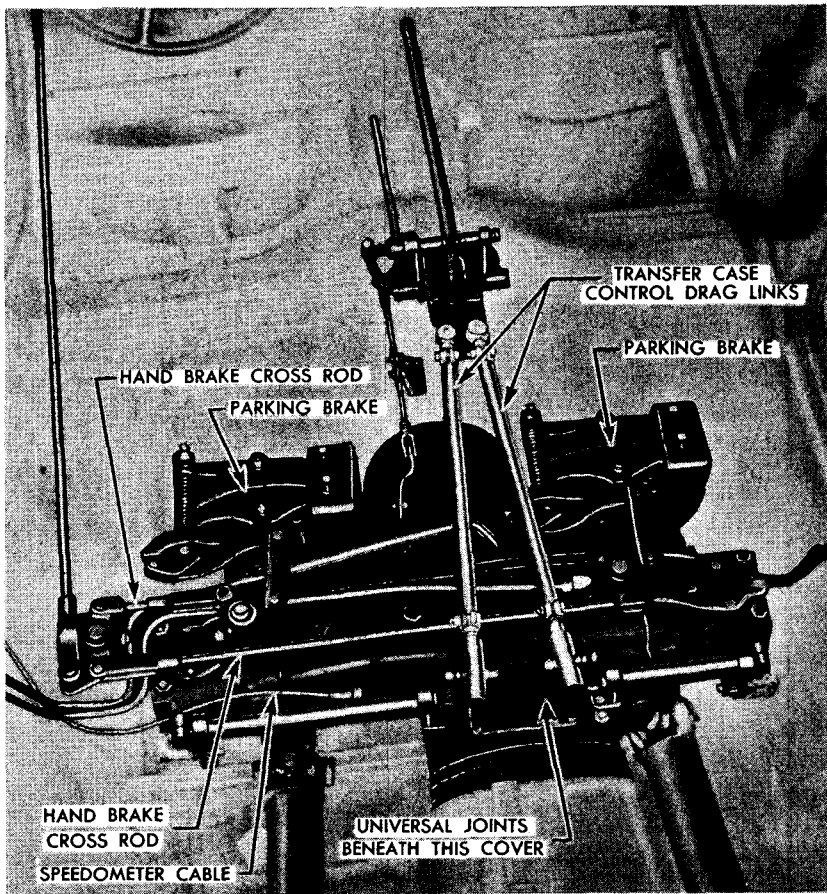
ARMORED CAR T17

RA PD 27432

Figure 37 — Transfer Case

(12) Disconnect and remove the propeller shaft which drives the intermediate axle.

(13) Disconnect the two propeller shafts, running from each engine to the transfer case, at the transfer case. The slip joints will permit pushing the universal joints toward the engines and out of the way.

(14) Remove the four transfer case mounting bolts and move the transfer case toward the rear of the vehicle to gain access to the rear end of front axle propeller shaft.

(15) Disconnect and remove front axle propeller shaft and remove the transfer case from the vehicle.

b. Installation. Reverse the above procedure to install the transfer case.

Section XVII

BOGIE AND AXLES

Paragraph

Front axle	74
Rear and intermediate axles.....	75
Bogie	76

74. FRONT AXLE.

a. Description. The front axle is made by the Ford Motor Company and is especially designed for the Armored Car T17. Two Houdaille (model BBRCT) adjustable hydraulic shock absorbers are used on the front axle. The front springs have a wrapped second leaf.

b. Tabulated Data.

Ratio	6.66 to 1
Universal joints (Tracta).....	6 in.
Caster	3 deg
Camber	1½ deg
Toe-in	1/16 in.
Side inclination of spindle pin.....	10 deg
Deflection rate of front spring (lb per in.).....	1,085
Width and length of front springs.....	3 in. x 44 in.

75. REAR AND INTERMEDIATE AXLES.

a. The rear and intermediate axles are made by the Ford Motor Company and use a special axle housing and differential with special long tubes and axle shafts. The intermediate axle is equipped with a pillow block for the rear axle drive line (fig. 38). A Houdaille (model BBRCT) adjustable hydraulic double acting shock absorber is used on both sides of each axle.

76. BOGIE.

a. Figure 38 shows the bogie and intermediate and rear axles. The springs are made by the Ford Motor Company and have a deflection rate of 1,085 pounds per inch. The springs are three inches wide and are 54¾ inches long.

ARMORED CAR T17

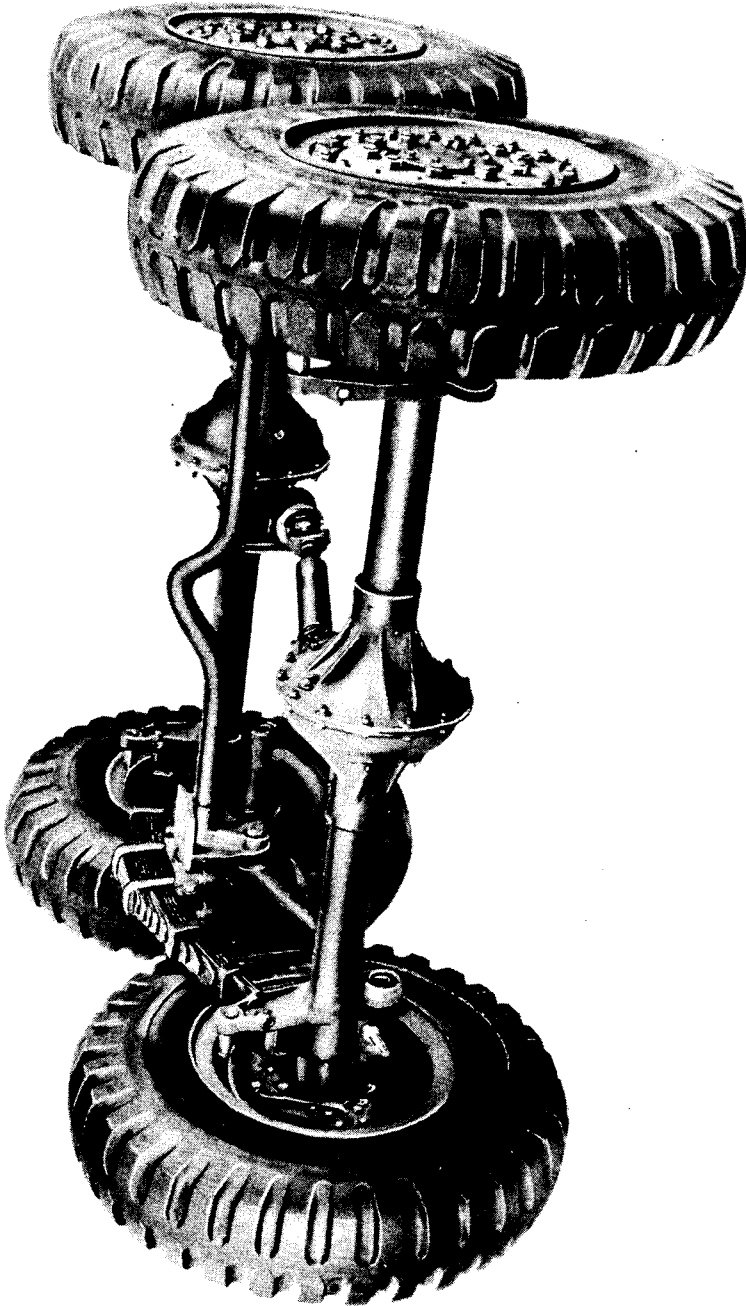

RA PD 27470

Figure 38 — Bogie With Rear and Intermediate Axle

Section XVIII

STEERING GEAR

	Paragraph
Steering gear	77
Power operation	78

77. STEERING GEAR.

a. The steering gear is made by Gemmer, model No. 500, with a special housing and sector shaft. The steering gear is of the worm and roller type having a ratio of 28.4 to 1. The steering wheel is 17¾ inches in diameter and has three spokes.

78. POWER OPERATION.

a. The steering of the vehicle is booster powered by a Vickers hydraulic cylinder controlled by the steering gear (fig. 40). Hydraulic pressure for this unit is provided by the two hydraulic pumps—one on the left-hand side of each engine at the rear (fig. 39). In the event of failure of the hydraulic power system, the vehicle can be steered manually.

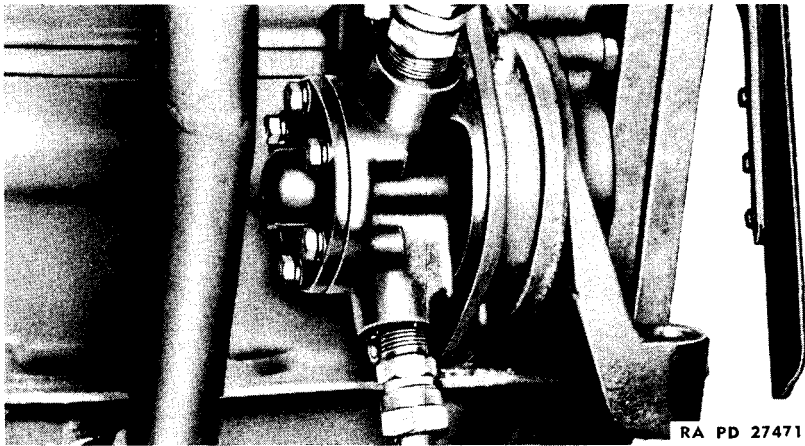

RA PD 27471

Figure 39 — Hydraulic Pump

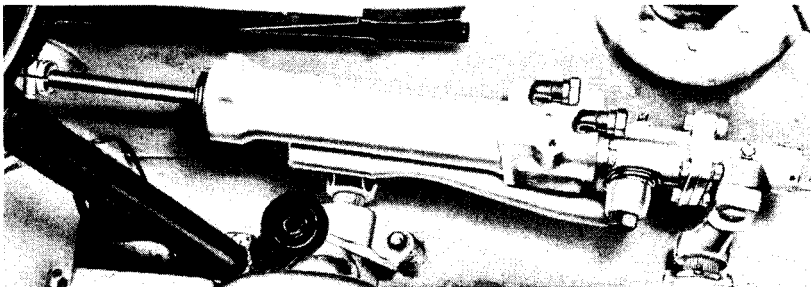

RA PD 27431

Figure 40 — Hydraulic Steering Mechanism

ARMORED CAR T17

Section XIX

BRAKES

Paragraph

Hand brakes	79
Service brakes	80

79. HAND BRAKES.

a. The hand brakes are located on the forward side of the transfer case (fig. 37). These brakes are of the disk type and are adjustable. The brakes are actuated by a parking brake lever, mounted horizontally in front of the instrument panel (par. 6).

80. SERVICE BRAKES.

a. **Description.** A hydraulically operated, two-shoe internal expanding brake is provided at each of the six wheels. The pressure applied to the brake pedal is boosted by means of a Hydrovac booster. Two

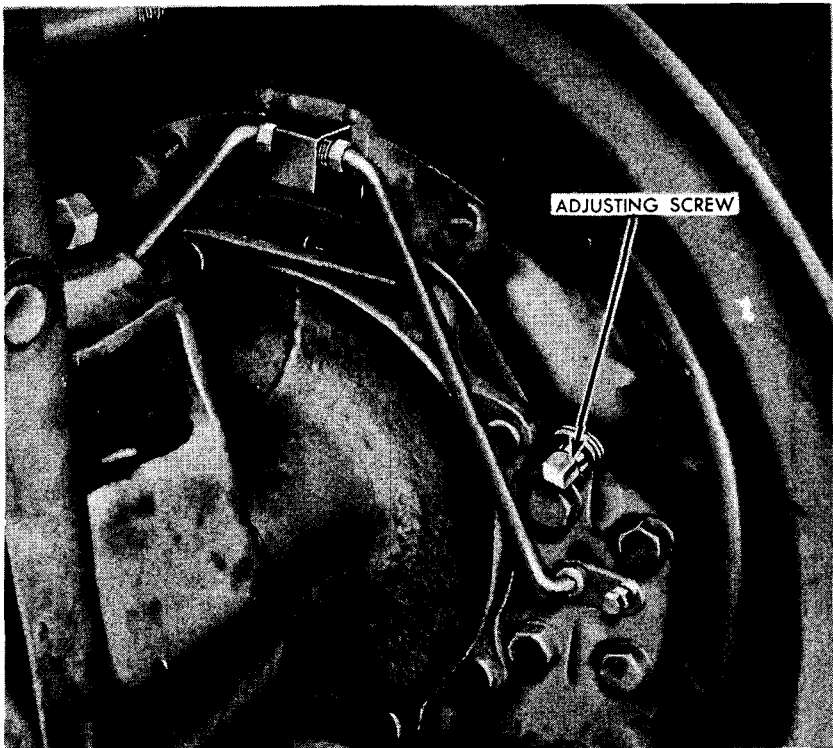

Figure 41.— Brake Adjusting Screw

RA PD 27430

BRAKES

of these boosters are used, one acting as a booster for the brakes on the front and intermediate axles and the other for the intermediate and rear axles. Each brake assembly has two slave cylinders, one for each shoe, thus making each shoe a primary shoe.

b. Tabulated Data.

Number of cylinders per wheel.....	2
Diameter of slave cylinders:	
Front	1½-in.
Rear and intermediate	1¼-in.
Thickness of lining	0.38-in.
Width of lining	3½-in.
Length of lining	15.9-in.
Total brake area for 6 wheels.....	666 sq in.

c. Adjustment. Adjustment of the service brakes is made by means of adjusting screws on the brake housing plate (fig. 41). When adjusting the brake, run the screws in (clockwise) until the shoes contact the drum. Then back off five notches.

ARMORED CAR T17

Section XX

FIRE EXTINGUISHERS

	Paragraph
Installation	81
Operation	82
Maintenance	83
Handling	84

81. INSTALLATION.

a. Two sizes of carbon dioxide fire extinguishers are carried in each vehicle. Two fixed 10-pound units are clamped in a vertical position on the bulkhead of the fighting compartment to the rear of the turret basket (fig. 42). These units connect to tubes leading to the engine compartment and are used for extinguishing fires in the engine compartment only. A 4-pound portable hand-operated extinguisher is strapped in a vertical position on the hull to the right of the assistant driver (fig. 42).

82. OPERATION.

a. **Portable Extinguisher.** Carry the portable extinguisher in the left hand and the hose in the right hand. Direct the discharge at the base of the flame, with the discharge cone as close to the flame as the operator can safely hold it. Increase the discharge from the extinguisher as the fire is put out.

b. **Fixed Extinguisher.** In case of a fire in the engine compartment, the fixed extinguisher can be set in operation from the outside of the armored car by means of the controls located behind and to the left of the turret, or by means of the controls in the driver's compartment located almost directly over the driver's left shoulder. In either case the left-hand control, when pulled out, opens the left-hand fixed extinguisher and the right-hand control opens the right extinguisher. Either floods the engine compartment with carbon dioxide gas, and will extinguish a fire with the engine running up to 1,200 revolutions per minute. However, if conditions permit, stop the engine.

83. MAINTENANCE.

a. After use, the extinguisher should immediately be exchanged for one that is fully charged. Every four months, or oftener if deemed necessary, weigh each extinguisher, and if the weight of the charge of liquid carbon dioxide is less than 3½ pounds for the 4-pound

FIRE EXTINGUISHERS

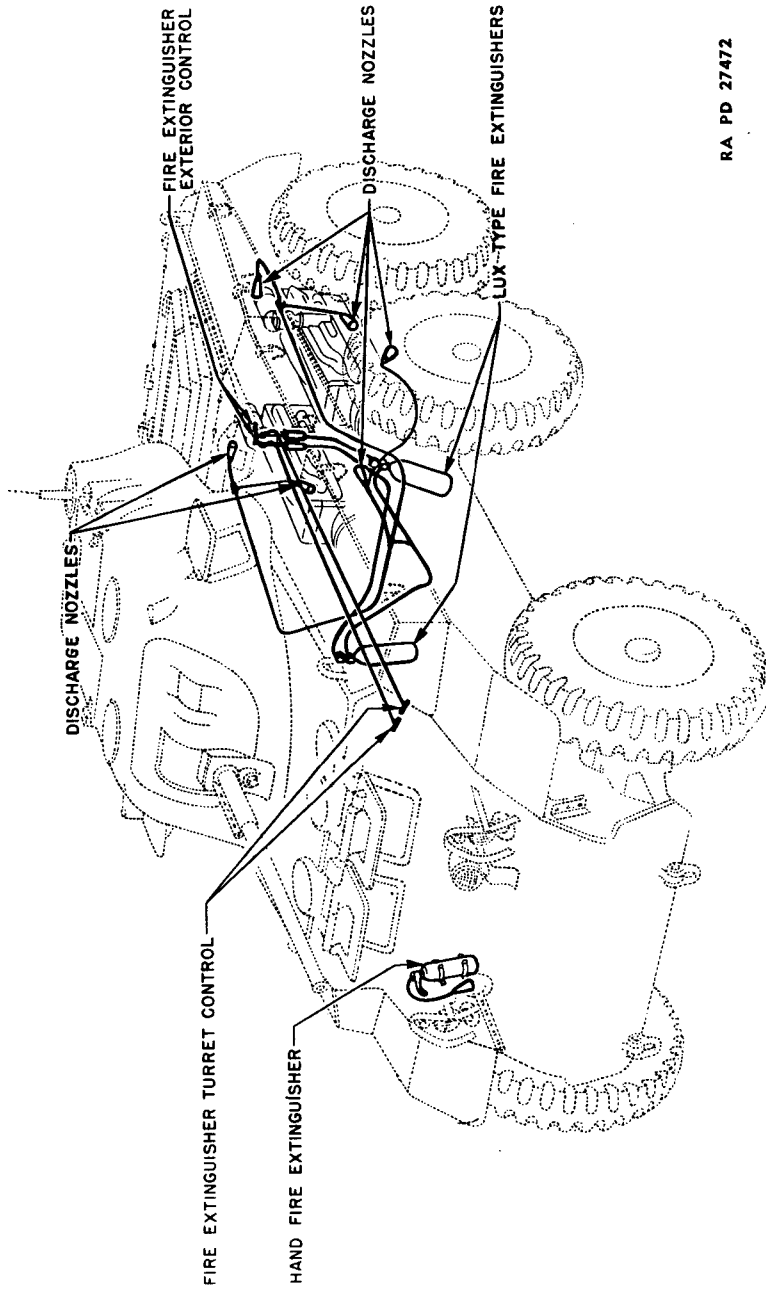

RA PD 27472

Figure 42 — Fire Extinguisher System

ARMORED CAR T17

extinguishers, or 9 pounds for the 10-pound ones, exchange the extinguisher for a fully charged one.

84. HANDLING.

a. Any cylinder containing gas under high pressure is as dangerous as a loaded shell. The extinguisher cylinders should never be dropped, struck, handled roughly, or exposed to unnecessary heat.

Section XXI

REFERENCES

	Paragraph
Standard nomenclature lists	85
Explanatory publications	86

85. STANDARD NOMENCLATURE LISTS.

- CAR, armored, T17 (Ford)—Parts and equipment. SNL G-134
- (NOTE: A list of all SNL's is maintained as the "Ordnance Publications for Supply Index")..... OPSI
- Cleaning, preserving and lubricating materials, recoil fluids, special oils and similar items of issue..... SNL K-1

86. EXPLANATORY PUBLICATIONS.

- Cleaning, preserving, lubricating, and welding materials and similar items issued by the Ordnance Department TM 9-850
- Fire prevention and safety precautions..... TM 10-360
- Military motor transportation..... TM 10-505
- Maintenance and repair..... TM 10-520
- Echelon system of maintenance..... TM 10-525
- Motor transport inspections..... TM 10-545
- Chassis, body, and trailer units..... TM 10-560
- Automotive brakes TM 10-565
- Hand, measuring, and power tools..... TM 10-590
- Storage of motor vehicle equipment..... AR 850-18
- Detailed lubrication instructions for ordnance materiel OFSB 6 Series

ARMORED CAR T17

INDEX

A	Page	B	Page
Accessory speeds	48	Batteries	
Adjustment of:		description	64
automatic choke	59	maintenance	64-66
clutch	78-80	Blackout head lamp	73
fan belt	62-63	Blackout driving light switch....	9, 10
generator belt	66	Bogie	83
generator regulators	68	Bow gun (cal. .30 machine gun	
recoil adjuster	45	M1919)	45
service brakes	87	Bow periscopes, fixed and rear view	46
stiffness adjuster	44-45	Brakes	
Air cleaners, location and use....	55	hand	86
Ammeter	10-12	parking brake lever	14-15
Ammunition	46	service	86-87
Armament	43-46	adjustment	87
ammunition	46	data	87
data	6	description	14, 86-87
guns and gun mounts	43-45		
sighting equipment	45-46	C	
Armor thickness, data on	7	Camouflage, paint as	38-39
Armored car T17		Capacity of:	
armament	43-46	batteries	64-66
bogie and axles	83-84	cooling system	60
brakes	86-87	Carburetors	56
care and preservation	36	data	49
cooling system	60-63	Care and preservation	36-39
data, tabulated	5-8	cleaning	36
description	2-5	records	36
electrical system	64-76	Chart	
engines	48-55	hydrometer temperature correc-	
fire extinguishers	88-90	tion	65
fuel system	56-59	lubrication	
lubrication instructions	21-25	chassis	22
materiel affected by gas	40-42	turret mechanism	24
operation and controls	9-20	Circuit breakers	13
organization maintenance	47	Cleaning	
painting	37-39	materiel affected by gas	40
preventive maintenance	26-35	vehicle	36
propeller shafts	77	Clearance	
steering gear	85	clutch and bearing	78-80
transfer case	81-82	valve	48
transmission and clutch	78-80	Clock, location	12
Assignment record	36	Clutch	
Automatic choke		adjustment	78-80
adjustment	59	description	78
description	58	pedal	15
Automotive materiel affected by		pilot bearings, lubrication	21
gas, special precautions.....	42		
Axles, front, rear, and intermediate	83		

INDEX

C—Cont'd	Page	Page	
Combination gun mount M24		Description	
electric firing controls	43-44	automatic choke	58
elevation or depression of gun..	43	brakes	86-87
rotation of turret	43	clutch	78
traverse	43	cooling system	
Communication, data on	6	fans	62
Compression ratio	48	radiators	60
Control of the gun (stabilizer unit)	44	thermostats	63
Controls		water pumps	60-62
brakes	14	electrical system	
parking brake lever	14-15	batteries	64
service brakes	14	distributor	68
clutch pedal	15	generator regulators	67-68
gear shifting	15-17	generators	66
gear shift lever	16	ignition coil	71
sliding button	16-17	lamps	
transfer case controls	17	blackout head	73
siren button	15	service head	72
spark control	15	tail	76
steering wheel	15	engines	48
throttle controls	15	fuel system	
transfer case	81	automatic choke	58
Cooling system	60-63	carburetor	56
description and data	60	fuel filter	57
fans		fuel pump	56
belt adjustment	62-63	throttle controls	58
description	62	gear shifting	15-16
radiator	60	propeller shafts	77
thermostats	63	transfer case	81
water pump	60-62	transmission	78
Crew, data on	7	Direct vision in sighting	46
Current limiter	60	Direction of rotation	48
Cylinder(s)		Distributor	68-70
misfiring	53	data, tabulated	68-69
number(-ing)	48, 49	description	68
		ignition timing	69-70
		Drains(-ing), cooling system	60
D			
Data (tabulated)		E	
armored car T17	5-8	Electric firing controls	43-44
bogie and axles	83	Electrical system	64-76
cooling system	60	batteries	64-66
distributor	68-69	description	64
engines	48-49	distributor	68-70
fuel system	56	generator regulators	67-68
service brakes	87	generators	66-67
Decontamination of materiel		ignition coil	71
affected by gas	40-42	instrument panel	76
procedure	41-42	lamps	71-76
protective measures	41	siren	76
Definitions of operation terms	47	spark plugs	71
Depression or elevation of gun	43	starting motor	68

ARMORED CAR T17

E—Cont'd	Page		Page
Elevation or depression of gun....	43	fuel filter	
Engine temperature gages	12	description	57
Engines		maintenance	58
air cleaners	55	fuel pumps	
data	6	description and maintenance..	56
description and data	48-49	removal and installation	57
oil filter	55	throttle controls	58
oil pump	55		
replacement	54-55	G	
install	55	Gas, materiel affected by (See Ma-	
remove	54	teriel affected by gas)	
stopping	20	Gear shift lever	16
test	18	Gear shifting	15-17
trouble shooting	49-54	description	15-16
Equipment, sighting	45-46	Generator regulators	
		description	67-68
F		inspection and adjustments	68
Fan(s)		Generators	
belt adjustment	62-63	belt adjustment	66
description	62	description	66
Fire detector	13	lubrication	66
Fire extinguishers	88-90	removal and installation	67
handling	90	Guide, lubrication	21
installation	88	Gun, control of with stabilizer....	44
maintenance	88-90	Guns and gun mounts	43-45
operation	88	bow gun	45
portable	88	combination gun mount M24...	43
Firing controls, electric	43-44	submachine gun	45
Firing, manual, of bow gun	45	stabilizer unit for combination	
Firing order	49	gun mount	44-45
Fixed bow periscopes	46		
Fixed fire extinguisher	88	H	
Fixed turret periscopes	45	Halt, inspection	28-31
Front axle	83	Hercules JXD engines (See Engines)	
Fuel and oil, data on	7	Hydraulic pumps	85
Fuel filter		Hydrometer temperature correction	
description	57	chart	65
maintenance	58		
Fuel level gage	10	I	
Fuel mixture, poor, symptom and		Ignition	
cause	53	coil	71
Fuel pumps		switch	10
description and maintenance....	56	timing with engine	69-70
removal and installation	57	trouble	53
Fuel system	56-59	Induction system, leaks.....	53
automatic choke		Inhibitor, use of in cooling system..	60
adjustment	59		
description	58		
carburetors	56		
description and data	56		

INDEX

I—Cont'd	Page	Page
Inspections		points to be serviced and/or lubricated 21
generator regulators	68	reports and records 21-24
vehicle		transfer case 81
after operation	31-33	
at the halt	28-31	
during operation	28	
periodic		
after 500 miles of operation	33	
after 2,500 miles of operation	34-35	
prestarting	26-28	
Instructions		
lubrication	21-25	
operating the vehicle	18-19	
starting	17-18	
Instrument panel	9-13	
ammeter	10-12	
blackout driving light switch	9	
circuit breakers	13	
clock	12	
engine temperature gages	12	
fire detector	13	
fuel level gage	10	
ignition switch	10	
instrument panel lights	10	
light switch	9-10	
location of and replacing caution	76	
oil pressure gages	12-13	
rheostat switch	13	
speedometer	13	
starter switches	13	
utility sockets	12	
voltmeter	12	
Insulating parts, damaged	53	
Intermediate axles	83	
L		
Lamps	71-76	
blackout head	73	
service head	72-73	
tail	76	
Leaks in induction system	53	
Light switch	9-10	
"Log Book"	36	
Lubricating devices, painting	39	
Lubrication (instructions)		
general information	21	
generators	66	
lubrication guide	21	
M		
Maintenance		
batteries	64-66	
fire extinguishers	88-90	
fuel filter	57	
fuel pumps	56	
organization	47	
preventive (See Inspections)		
Material affected by gas	40-42	
cleaning	40	
decontamination	40-42	
procedure	41-42	
protective measures	41	
protective measures	40	
special precautions for automotive materiel	42	
Metal surfaces, painting	38	
Misfiring of cylinder, cause	53	
O		
Oil, data	7	
Oil filter	55	
Oil level in stabilizer unit	45	
Oil pressure gages	12-13	
Oil pump	55	
Operating the vehicle, instructions	18-19	
Operation		
fire extinguishers	88	
inspection (See Inspections)		
stabilizer unit for combination		
gun mount	44-45	
test	45	
Operation and controls	9-20	
engine test	18	
general information on controls	9-17	
controls	14-17	
(See Controls for list)		
instrument panel	9-13	
operating the vehicle	18-19	
prestarting inspection	26-28	
starting instructions	17-18	
stopping the engines	20	
towing the vehicle	19-20	
Organization maintenance	47	
Overheated engine, cause	53-54	

INDEX

S—Cont'd	Page	Page	
Steering wheel	15	replacement	
Stiffness adjuster, adjusting	44-45	installation	82
Stop light	10	removal	81-82
Stopping the engines	20	Transmission	78
Submachine gun, cal. .45, Thompson	45	Traverse of combination gun mount	.
Switches		M24	43
blackout driving light	9	Trouble shooting the engines...	49-54
ignition	10-12	failure to turn over when starting	
light	9-10	button is pressed	49
starter	13	turning over but not starting..	49-53
		uneven running	53-54
		Turret	
		periscopes, fixed and rotating....	45
		rotation	43
		U	
		Universal joints	77
		Utility sockets	12
		V	
		Valve	
		minimum clearance	48
		trouble	53
		Vehicle (See Armored car T17)	
		Vision, direct, in sighting equipment	46
		Voltage regulator	68
		Voltmeter	12
		W	
		Water pumps	60-62
		Weight of engines	48

[A.G. 062.11 (11-2-42)
TT 98735 (11-3-42)]

BY ORDER OF THE SECRETARY OF WAR:

G. C. MARSHALL,
Chief of Staff.

OFFICIAL:

J. A. ULIO,
Major General,
The Adjutant General.

DISTRIBUTION: X

(For explanation of symbol, see FM 21-6)