

TM 9-834

WAR DEPARTMENT TECHNICAL MANUAL

RESCINDED Per DA Circular • 310-48 DEC 28 1962

VEHICULAR GENERAL PURPOSE UNIT EQUIPMENT

WAR DEPARTMENT TECHNICAL MANUAL

TM 9-834

**VEHICULAR GENERAL
PURPOSE UNIT
EQUIPMENT**



WAR DEPARTMENT
1 June 1944

9 030947
PROPERTY OF U.S. ARMY

WAR DEPARTMENT
Washington 25, D. C., 1 June 1944

TM 9-834, Vehicular General Purpose Unit Equipment, is published for the information and guidance of all concerned.

[A.G. 300.7 (19 May 44)]

BY ORDER OF THE SECRETARY OF WAR:

G. C. MARSHALL,
Chief of Staff.

OFFICIAL:

J. A. ULIO,
Major General,
The Adjutant General.

DISTRIBUTION:

As prescribed in paragraph 9A, FM 21-6: CH(1); ORD decentralized suboffices (3); PE "Mark for Ord O" (5); Hand R points (5); Ord dist. O (5); ORD regional O (3); ORD dist. Br. O (3); Ord establishments (5); Ord tank depots (3).

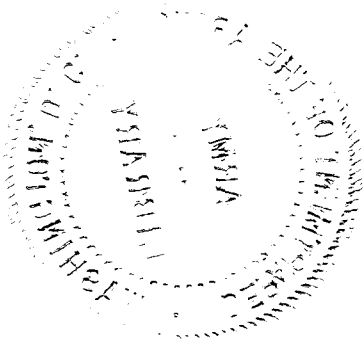

CONTENTS**PART ONE—GENERAL**

		Paragraphs	Pages
SECTION	I Introduction	1	5

PART TWO—TEST AND BENCH EQUIPMENT

SECTION	II Cleaner and tester, spark plug—No. 40-C-1011	2-5	6-7
	III Cleaner, engine, kerosene spray—No. 40-C-1008-20	6-7	8-9
	IV Gage, cylinder compression—No. 41-G-124	8-10	10-11
	V Gage, combination vacuum and pressure—No. 41-G-500	11-12	11-14
	VI Indicator, wheel alinement, portable—No. 41-I-130	13-15	14-16
	VII Light, timing, neon-tube type—No. 41-L-1440	16-17	16-18
	VIII Tester, battery, universal—No. 17-T-5505	18-19	18-20
	IX Tester, low-voltage circuit—No. 17-T-5575	20-22	20-24
	X Tester, ignition circuit, high-tension—No. 17-T-5520	23-25	25-31
	XI Tester, distributor, motor-driven—No. 17-T-5540	26-29	31-37
	XII Welding outfit, electric arc—No. 17-W-1715	30-34	38-49

PART THREE—AIR COMPRESSORS

SECTION	XIII Compressor, air, portable type, 4 cubic feet, gasoline engine-driven—No. 66-C-1380	35-39	51-60
	XIV Compressor, air, portable, 6 cubic feet, gasoline engine-driven—No. 66-C-1370	40-44	61-67

VEHICULAR GENERAL PURPOSE UNIT EQUIPMENT

PART THREE—AIR COMPRESSORS—Cont'd

	Paragraphs	Pages
SECTION XV Compressor, air, portable, gasoline engine-driven, 5 horsepower, 16 cubic feet capacity, with tank and hose— No. 66-C-1175	45-49	67-76
XVI Compressor, air, 3 cubic feet, gasoline engine-driven— No. 66-C-1369	50-54	77-82

PART FOUR—BATTERY CHARGERS

SECTION XVII Charger, battery— No. 17-C-8730	55-57	83-86
XVIII Charger, battery, 300-watt, 12-volt, gasoline engine-driven— No. 17-C-8760	58-62	86-92
XIX Charger, battery, portable, 12-volts, 2000-watts, gasoline engine-driven— No. 17-C-9635	63-67	92-102

APPENDIX

SECTION XX References	68-70	103-104
INDEX		105

PART ONE

GENERAL

Section I

INTRODUCTION

1. SCOPE.

a. This technical manual* is published for the information and guidance of the personnel to whom this equipment is assigned. It contains information on the operation, lubrication, and adjustment of Vehicular General Purpose Unit Equipment.

b. This manual has the following arrangement:

- (1) Part One, General, is the introduction to the manual.
- (2) Part Two contains information on the operation, lubrication, and adjustment of bench and test equipment.
- (3) Part Three contains information on the operation, lubrication, and adjustment of air compressors.
- (4) Part Four contains information on the operation, lubrication, and adjustment of battery chargers.

*To provide operating instructions with the materiel, this technical manual has been published in advance of complete technical review. Any errors or omissions will be corrected by changes, or, if extensive, by an early revision.

VEHICULAR GENERAL PURPOSE UNIT EQUIPMENT

PART TWO

TEST AND BENCH EQUIPMENT

Section II

CLEANER AND TESTER, SPARK PLUG—No. 40-C-1011
(Globe Union Co.)

2. DESCRIPTION.

a. The spark plug cleaner and tester is of metal construction, and is supplied in both floor and bench models. It is designed to sandblast clean, and make spark gap tests, on $\frac{7}{8}$ -inch, 10-, 14-, and 18-mm spark plugs. This unit operates from a 12-volt d-c outside power source. Battery clips are provided for this purpose. An outside source of compressed air is required for the sandblast cleaning operation.

3. CONTROLS AND INSTRUMENTS (fig. 1).

a. **Push Button.** The test button located on the front of the case is pushed to supply ignition voltage to the spark plug during the gap test.

b. **Air Valve Control.** The air valve control is a wing-type handle on the top of the cleaner-tester, and is marked "AIR." It has three positions, which are marked on the top of the case, namely: "OFF," "AIR," and "SAND." This control is used to control the flow of air and sand for sandblast cleaning of plugs.

c. **Needle Valve.** The needle valve, located between the two test openings on top of the case, is turned clockwise to decrease, and counter-clockwise to increase the pressure of air for the spark plug gap test.

d. **Pressure Gage.** The pressure gage, mounted in the top of the case at the right-hand test opening, registers the pressure applied during the spark plug gap test. It is calibrated from 0 to 300 pounds per square inch.

e. **Mirror.** The metal mirror, mounted at an angle to the rear of the plug test openings, is used to observe action of the spark during the gap test.

f. **Adapters and Gaskets.** The adapters and gaskets are kept on two posts to the rear of the cleaner-tester when not in use. They are used to install different size plugs in the test openings.

g. **Gap Gages.** Three wire-type gages are supplied with the unit for the purpose of checking and adjusting spark plug gaps.

CLEANER AND TESTER, SPARK PLUG—No. 40-C-1011

4. OPERATION.

a. Preliminary Instructions. Install cleaner-tester on a bench or other suitable base with tester openings to the front, air control valve to the left, and spark plug cleaner opening to the right. Screw or bolt down through the holes provided in the base of the unit. Connect air line from 125 to 150 pounds per square inch air supply to ¼-inch pipe tapped air inlet to the rear of the air control valve. Ground the case by connecting the ground clip in the rear of the unit to the nearest suitable water pipe or ground pipe. **CAUTION: Spark plug gap test will not be satisfactory without case adequately grounded.** Remove air

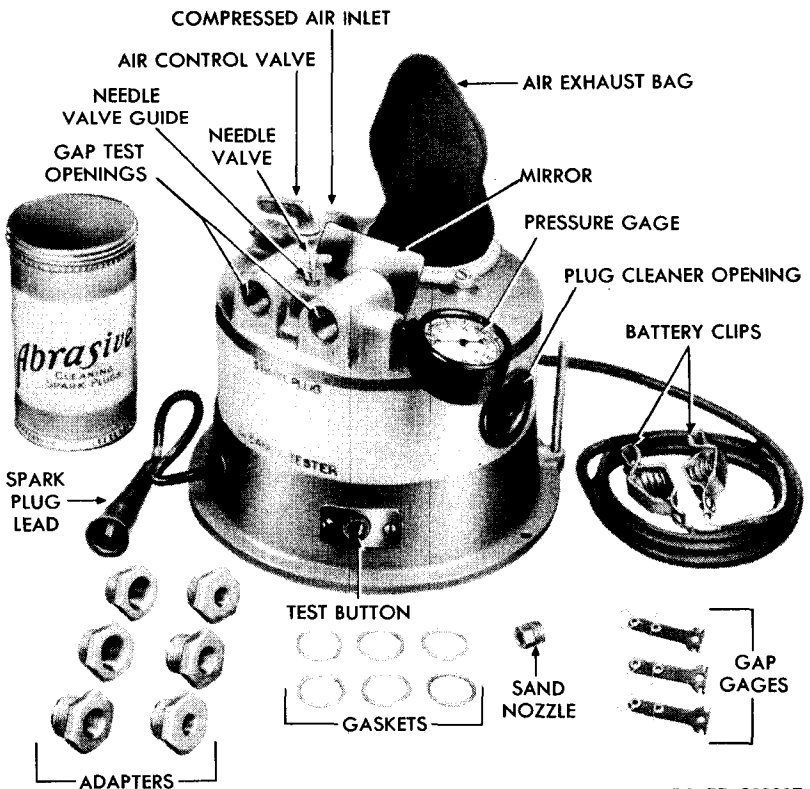

RA PD 322827

Figure 1—Spark Plug Cleaner and Tester

exhaust bag and screen, and pour 1 to 1½ pounds of abrasive into sand chamber. Replace bag and screen, and tighten securely in place. Attach battery clips to 12-volt storage battery (white wire to negative and black wire to positive terminal).

VEHICULAR GENERAL PURPOSE UNIT EQUIPMENT

b. **Sandblast Cleaning.** If there are not two spark plugs in the gap test openings, be sure the needle valve is closed before doing sandblast cleaning. Make sure plug is free of any excess oil or water and, using right hand, insert plug in cleaner opening. With left hand, turn air control valve to "SAND" position. Oscillate outer end of plug with a circular motion, so that cleaner blast can penetrate all crevices, for about 5 seconds. Without removing plug from opening, turn air valve 180° to the "AIR" position, and again oscillate plug for a few seconds to clear out all particles of loosened carbon or cleaning compound. Return the air valve to "OFF" position and remove the cleaned plug. Shake out, or jar loose any particles of abrasive remaining between the plug porcelain and shell. **CAUTION:** *Do not turn the air control valve to "SAND" position when there is no plug in the cleaner opening, as cleaning compound would be blown out through the cleaner opening at sufficient velocity to be injurious.*

c. **Testing Spark Plug Gap.** Adjust gap of old plug. Screw old plug and new plug to be compared into gap test openings, using copper gaskets and adapters when necessary. Clip high-tension spark plug lead to plug to be observed. Regulate air pressure to correct amount for plug being tested. Press the test button, gradually opening needle valve until pressure has been increased 20 pounds above normal. While pressure is being increased, observe action of the spark in the mirror to see if the spark remains bright and steady, without flickering or missing.

5. MAINTENANCE.

a. **Air Exhaust Bag.** When air exhaust bag becomes about half-filled with carbon and worn-out abrasive, remove the bag and screen. Clean the screen with dry-cleaning solvent and compressed air, being careful not to damage the mesh. Empty contents of bag and replace an equivalent amount of abrasive compound in the sand chamber. Install screen and bag.

Section III**CLEANER, ENGINE, KEROSENE SPRAY—No. 40-C-1008-20**

(Binks Mfg. Co., Model No. 160-B)

(DeVilbiss Mfg. Co., Type HM-551)

6. DESCRIPTION.

a. The engine cleaner gun is operated by compressed air, and is designed for throwing a spray of kerosene for cleaning engines and other metal parts. The cleaner is completely assembled with nozzle, control, and a one-quart liquid container for holding cleaning fluid. The differences in the types of guns are in the controls. One type (fig. 2) has

CLEANER, ENGINE, KEROSENE SPRAY—No. 40-C-1008-20

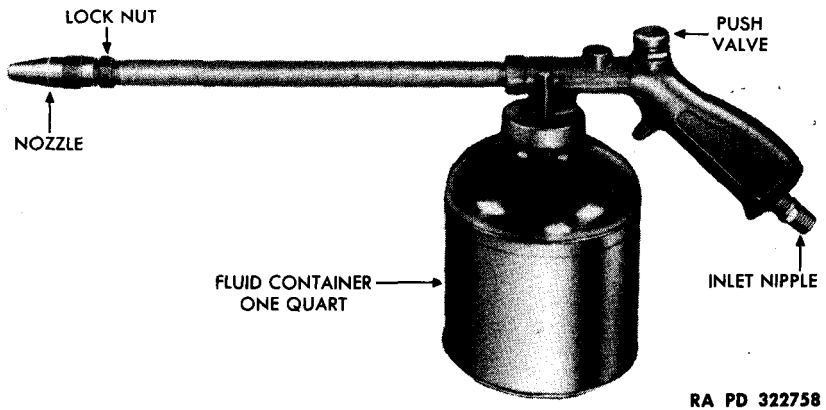

Figure 2—Engine Cleaner—Valve Type

the air control on top of the gun above the handle grip, the thumb releasing the air. Another type (fig. 3), is controlled by a trigger inserted in the handle grip, the air being released by applying pressure with the index finger.

7. OPERATION.

a. Fill the container with cleaning fluid, and attach the compressed air hose to the nipple in the base of the handle grip. Press the thumb valve, or pull the trigger with the index finger, allowing fluid to run. Adjust the flow of cleaning fluid by turning the nozzle to the left to increase, and to the right to decrease the flow of fluid. Tighten the lock nut on the nozzle after flow has been adjusted, and keep the air vent located on the left side of the container open.

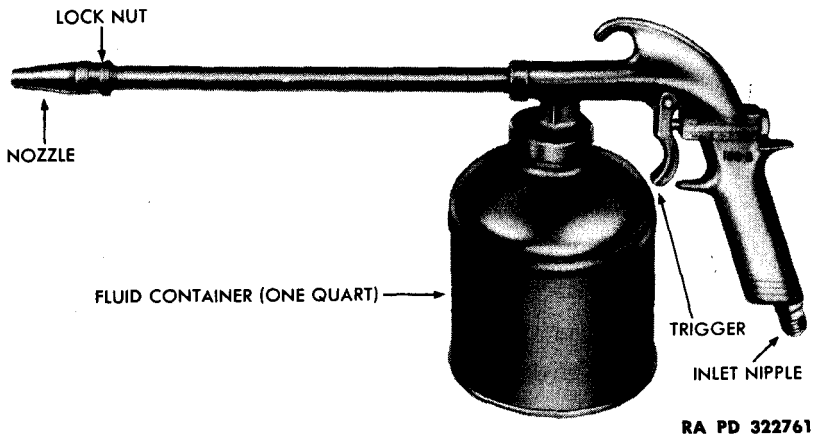

Figure 3—Engine Cleaner—Trigger Type

VEHICULAR GENERAL PURPOSE UNIT EQUIPMENT

Section IV

GAGE, CYLINDER COMPRESSION—No. 41-G-124
(E. A. Stromberg)

8. DESCRIPTION.

a. The compression gage is designed for quick and accurate tests of engine compression. It consists of a gage, calibrated from 0 to 200 pounds in 5-pound divisions, with a hexagon stem equipped with a pressure relief valve and ball check valve, a flexible hose connection with screw-type adapters to fit 10-, 14-, 18-mm and 7/8-inch spark plug ports, an extension equipped with a rubber adapter for rigid compression tests, and an air chuck adapter for compressed air tests.

9. ASSEMBLIES.

a. **Rigid Assembly.** This assembly consists of the gage, valve adapter, relief valve, rubber adapter extension, and the rubber adapter.

b. **Flexible Assembly.** This assembly consists of the gage, valve

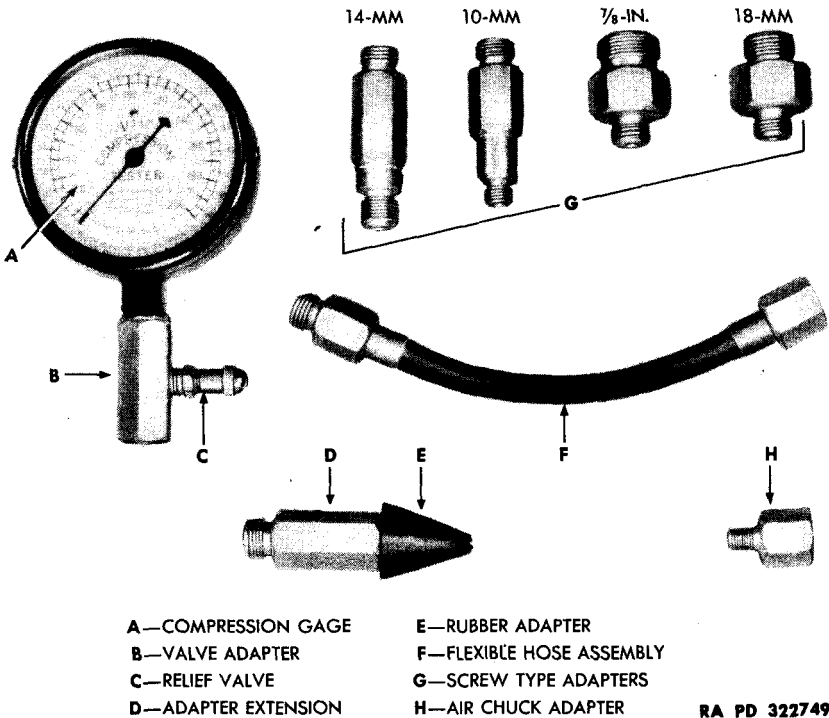

Figure 4—Cylinder Compression Gage

GAGE, COMBINATION VACUUM AND PRESSURE—No. 41-G-500

adapter, relief valve, flexible hose assembly, and the proper screw-type adapter.

c. **Air Chuck Assembly.** This assembly consists of the chuck valve and the flexible hose assembly (when hose is used).

10. OPERATION.

a. **Compression Test.** Remove all spark plugs from the engine being tested. Block the automatic choke and carburetor throttle in open position. Press rigid assembly firmly into the spark plug port of No. 1 cylinder, or connect flexible hose assembly with proper screw-type adapter into No. 1 cylinder. Crank the engine with cranking motor, and count number of strokes required to reach a maximum reading (4 or 5 strokes). Release the pressure in gage by unscrewing valve cap located on the hexagon of the valve adapter one-half turn, returning the pointer of the gage to zero. Close the valve by tightening the valve cap, and proceed to cylinder No. 2.

b. **Compressed Air Test.** Remove all spark plugs, and block carburetor and choke in full choke position. Turn engine to compression stroke of No. 1 cylinder, with piston at top dead center. Set vehicle transmission in gear, and apply hand brake. Select the proper screw-type adapter and install in No. 1 cylinder spark plug port. Attach the flexible hose assembly to the air chuck adapter, and screw into the screw-type adapter in the plug port. Apply air chuck on air compressor hose to air chuck adapter, and inject compressed air into cylinder. Listen for air leaks, to assist in analyzing the condition of the engine; for example, air rushing through the carburetor denotes intake valve failure; through the exhaust manifold, exhaust valve failure; through the breather pipe or oil filler neck, worn piston rings; and through the next cylinder, head gasket leaks between cylinders. Bubbling water in radiator denotes leaky gaskets in the cooling system. Check each succeeding cylinder in relation to the firing order.

Section V

**GAGE, COMBINATION VACUUM AND PRESSURE—
No. 41-G-500**

(Hygrade Products Co., Model No. PT-10)

11. DESCRIPTION (figs. 5 and 6).

a. The combination vacuum and pressure gage is designed for diagnosing troubles of high-compression gasoline engines at a speed slightly above idling speed. It consists of a gage with a dial indicator and two needles; the dark needle for steady, and the light needle for fluctuating readings, a rubber hose, and adapters. The gage is for making tests for burnt valves, weak valve springs, valve timing, warped and burnt manifolds, fuel pump, carburetion, and other engine functions.

VEHICULAR GENERAL PURPOSE UNIT EQUIPMENT

12. OPERATION.

a. **Vacuum Lift Test** (figs. 5 and 6). The lift test is made to determine the normal compression of the engine. Connect the tee fitting to the intake manifold, and attach the rubber hose. Disconnect the throttle shaft connector link, and turn stop screw to completely close

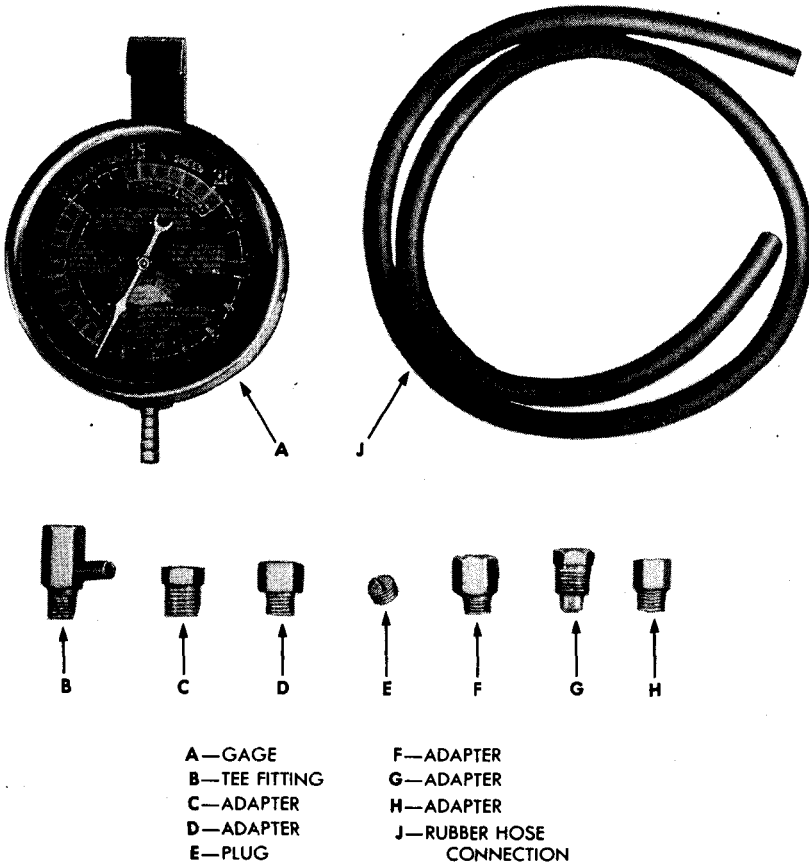

RA PD 322750

Figure 5—Combination Vacuum and Pressure Gage

throttle valve in carburetor body. With the ignition switch in "OFF" position, turn the engine over with the starter. Remove distributor cap to prevent engine from starting. As the starter turns the engine, the gage pointer will rise to where it stands when the engine is idling. If the pointer does not lift over 5 inches, the intake manifold or gaskets are faulty. If the pointer rises to a point between 10 and 15 inches and fluctuates badly, a cylinder head gasket is blown, or a bad valve condition exists.

GAGE, COMBINATION VACUUM AND PRESSURE—No. 41-G-500

RA PD 322755

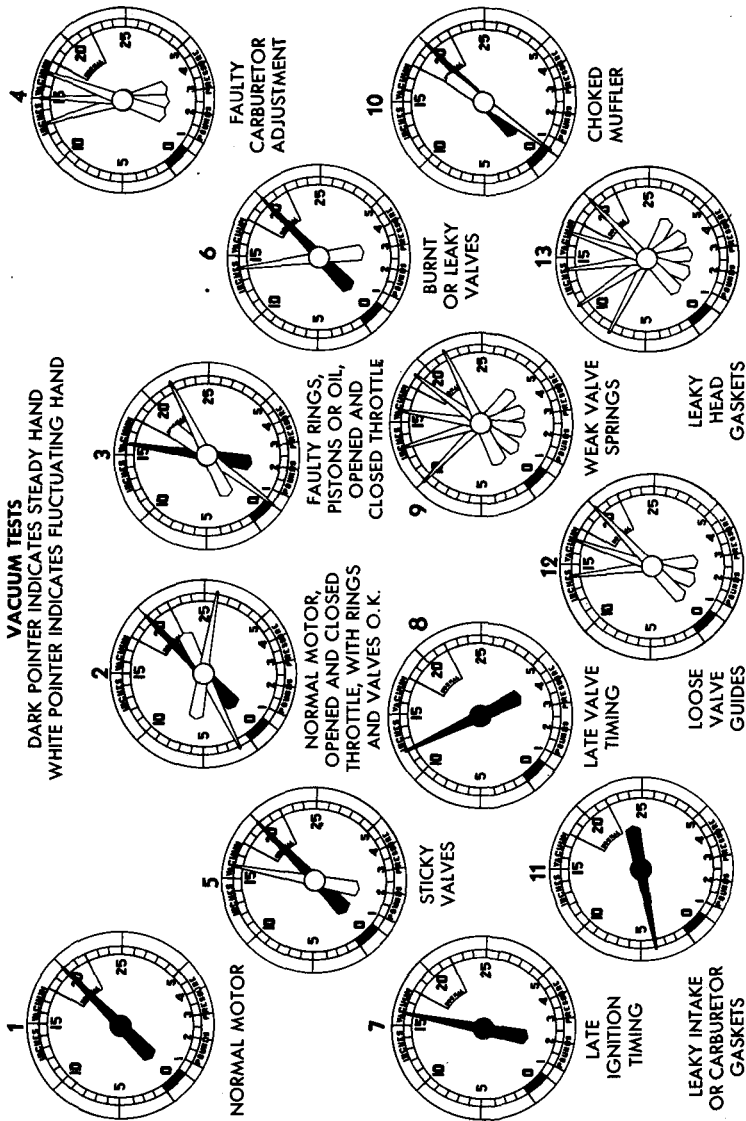

Figure 6—Dial Readings for Various Tests

VEHICULAR GENERAL PURPOSE UNIT EQUIPMENT

b. **Test With Engine Running.** Start engine and adjust the throttle stop screw so that engine is running at a minimum of 7 miles per hour in high gear; the pointer on the gage should register between 18 and 21 inches when the engine idles. Accelerate the engine by lifting the throttle arm and releasing it. The gage pointer should drop to 2 inches and recoil to 24 inches or more. If the recoil is not more than 24 inches, there is every indication of well-diluted oil in the engine crankcase and poorly sealing piston rings. Accelerate the engine to 30 miles per hour and hold steady. If the pointer on the gage fluctuates rapidly between 10, 21, and 22 inches, it is an indication that the valve springs are weak.

c. **Correct Setting of Ignition Timing.** Connect the gage to the intake manifold. Jack the rear wheels of the vehicle off the floor. Start the engine and set throttle stop screw until speedometer registers no more than 15 miles per hour and loosen distributor lock plate screw. Turn the distributor body in retard position until gage registers 16 or 17 inches. Turn distributor body to advance position until pointer on gage indicates the highest point, with pointer fluctuating ahead. Turn distributor body toward retard enough to remove the fluctuation and, when pointer is steady, tighten distributor lock plate. If the engine is in perfect condition, the gage will remain steady between 18 and 21 inches.

d. **Testing Fuel Pumps.** Connect the gage to the intake side of the fuel pump. Start engine and run at idling speed. The gage should read 8 inches or more. If the pointer indicates a lower vacuum, there is an air leak, a faulty diaphragm, or the glass bowl seal is not properly seated, or is worn. Any reading above 8 inches is normal.

Section VI

INDICATOR, WHEEL ALINEMENT, PORTABLE No. 41-I-130 (Wilco Products Co.)

13. DESCRIPTION.

a. The wheel alinement indicator is composed of 16 separate parts consisting of turn plates, pointers, brackets, clamps, anchor blocks, and head assembly to use in checking wheel alinement. Different combinations of the components are used in checking different vehicles.

14. CONTROLS AND GAGES (fig. 7).

a. **Pointers and Turn Plates.** The pointers are used in the geometry test indicating the angle on the scale of the turn plates.

b. **Head Assembly.**

(1) **LEVEL CONTROL KNOB.** The level control knob located on the

INDICATOR, WHEEL ALINEMENT, PORTABLE—No. 41-I-130

side of the head assembly is used for centering the air bubble for testing camber and caster.

(2) **LEVEL INDICATOR.** The level indicator located on face of the head assembly is a gage of the air-bubble type.

(3) **TAPE.** The tape is wound in the head assembly, and is used for measuring between the two front wheels in the toe-in test.

15. OPERATION.

a. **General.** The wheel alinement indicator is operated by attach-

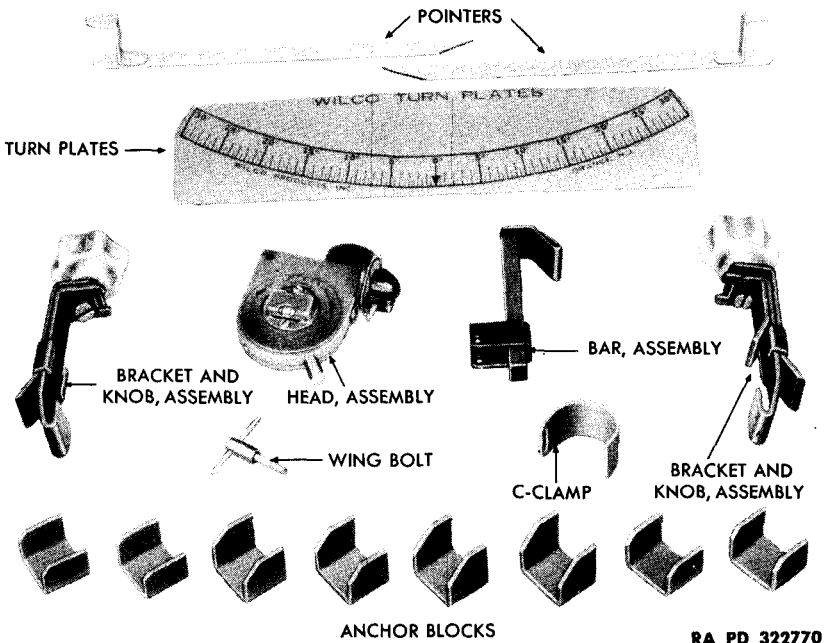

Figure 7—Wheel Alinement Indicator

ing the component parts used to the rim of the wheels to be checked. Tests of camber, caster, toe-in, and geometry require the use of various combinations of testing components.

b. **Camber Test.** Attach the bracket and knob assembly to the rims, at top center, of the wheels to be checked with the wheels straight ahead. Set the dial mark at zero. Attach the head assembly to the bar, and level the head by moving the head up and down until the air bubble in the level indicator is centered. Remove the head assembly from the bracket, and roll the wheels forward until the knob on the bracket assembly touches the floor. Position the head and bar assembly against the bracket. Turn the level adjusting knob in the direction required to

VEHICULAR GENERAL PURPOSE UNIT EQUIPMENT

center the air bubble; each turn represents one degree of camber—clockwise indicating positive, and counterclockwise indicating negative camber.

c. **Caster Test.** Attach the bracket and knob assembly to the rims at top center of the wheels to be checked, with the wheels straight ahead. Install the head assembly to the bar. Level the head by moving the head up and down until the air bubble in the level indicator is centered. Roll the wheels forward 180 degrees, or until the head assembly is at the extreme bottom center of wheel. Turn the wheels to right or left to extreme turn position and turn the level adjusting knob in the direction required to center the air bubble. Each turn represents one degree of caster, clockwise indicating positive, and counterclockwise indicating negative caster.

d. **Toe-in Test.** Attach the bracket and knob assemblies at the extreme front center of both front wheels, with the wheels in direct forward position. Attach the head assembly to the bracket on the right wheel, placing the C-clamp over the level adjusting knob. Using the C-clamp as a guide, release the tape in the head assembly across the front of the wheels, and attach tape to pin on bracket mounted on left front wheel, using the indentations in the knobs for holding the tape. Take tape reading at measuring mark of C-clamp. Note the reading, and roll the vehicle forward and over the tape until the gage is at the rear center of the wheels. Read the tape. If the measurement is greater than at the front, the difference between the front and rear measurements is the amount of toe-in. Set proper toe-in by adjusting the tie-rod.

e. **Geometry Test.** Attach the bracket and knob assemblies to both front wheels, with wheels in straight-ahead position. Roll the wheels forward until the brackets are at the extreme bottom center of wheels, and attach pointers to brackets. Place the turn plates on the floor opposite the brackets with the pointers on zero. Turn the outside wheel to 20 degrees, and observe the reading of the inside wheel. Then turn the wheels in the opposite direction until the outside wheel is set at 20 degrees. The inside wheel should read within one degree of the reading obtained above. If it does not, adjust the tie rods to obtain that reading. Turn the wheels straight ahead, and adjust toe-in.

Section VII**LIGHT, TIMING, NEON-TUBE TYPE—No. 41-L-1440**

(Peerless Instrument Co.)

(Bendix Radio Corp.)

16. DESCRIPTION.

a. The neon timing light (fig. 8) is designed for the purpose of timing the ignition on all types of gasoline engines. It is composed of a

LIGHT, TIMING, NEON-TUBE TYPE—No. 41-L-1440

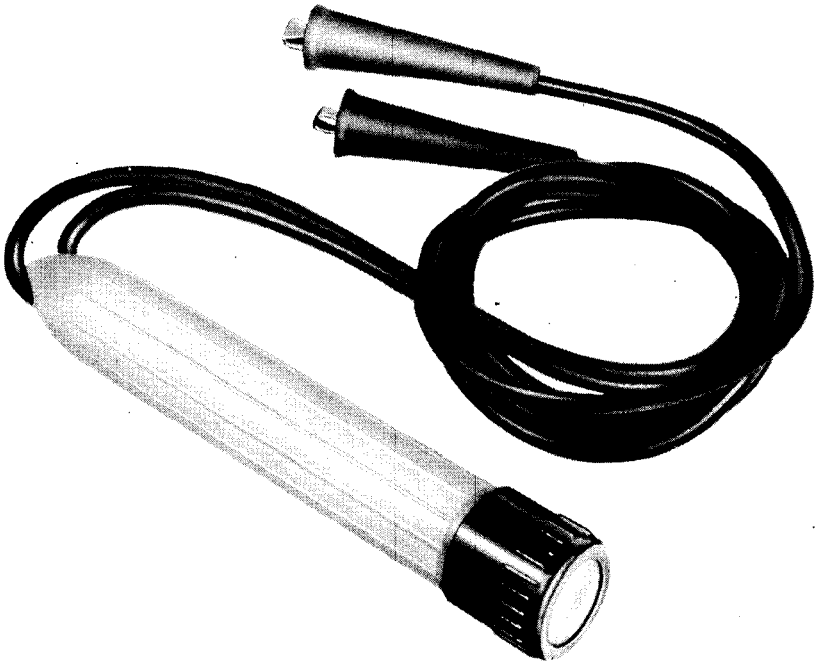

RA PD 322789

Figure 8—Neon Timing Lights

VEHICULAR GENERAL PURPOSE UNIT EQUIPMENT

body which holds the neon light tube and lens, and has two wire leads with insulated contact clips for connecting the light for the tests to be made.

17. OPERATION.

a. Preparation for Timing. Check all spark plugs and distributor points. Clean thoroughly and set proper gap.

b. Timing Ignition. Remove cover over inspection port on flywheel housing, and turn engine by hand until timing mark appears on flywheel. The rotor in the distributor will be opposite a high-tension terminal indicating the spark plug to be used for timing. Place a wide white mark directly over the timing mark (if marked TDC, do not cover the letters) and on the end of the pointer or at the center of inspection port hole. Warm up the engine to operating temperature at idling speed, and remove the wire from the No. 1 plug. Clip one light lead to No. 1 plug and ground the other lead to the chassis. The timing light will flash regularly as the plug fires. If the white mark on the flywheel shows up either above or below the pointer or center mark at inspection port hole, loosen the lock screw on the distributor, and move the distributor body (engine running) until the white marks appear exactly centered.

Section VIII**TESTER, BATTERY, UNIVERSAL—No. 17-T-5505**

(Allen Electric Co., Model No. 3-41)

(Hoyt Electric Co., Type CT-6)

18. DESCRIPTION.

a. There are two models of battery testers, both of which are universally used, the difference being in construction and operation.

b. Prod Type, Meter Attached (fig. 9). This tester is assembled as a unit. It consists of two adjustable, insulated prods to fit the terminals of any battery. One of the prods is equipped with a load switch for "OPEN CIRCUIT" voltage readings. A voltmeter is mounted on the handle of the tester, the dial is colored and is divided into "DEAD, DISCHARGED, and CHARGED" scale markings.

c. Prod Type With Selector (fig. 9). This tester is assembled in a metal case. It consists of test prods equipped with composition shunts which are insulated with shields. The prods are attached to lead wires of 5-foot length which are connected to the rheostat on the instrument panel. A plate selector with seven positions is mounted on the panel below the battery capacity meter which is calibrated with a colored zone scale to indicate active plate areas.

TESTER, BATTERY, UNIVERSAL—No. 17-T-5505

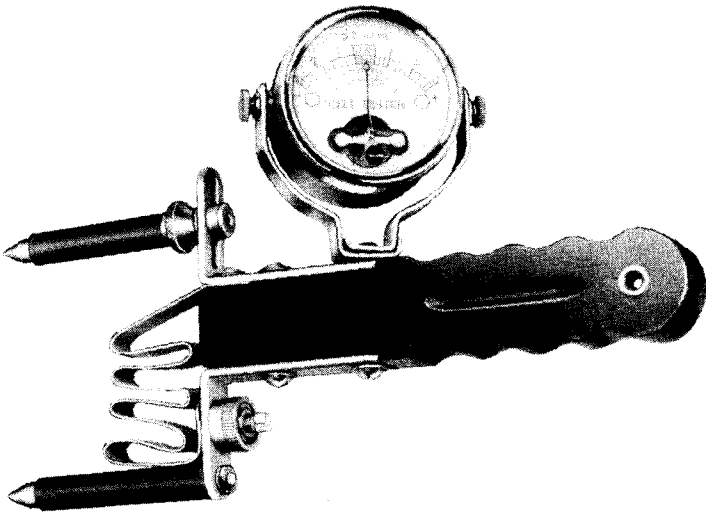
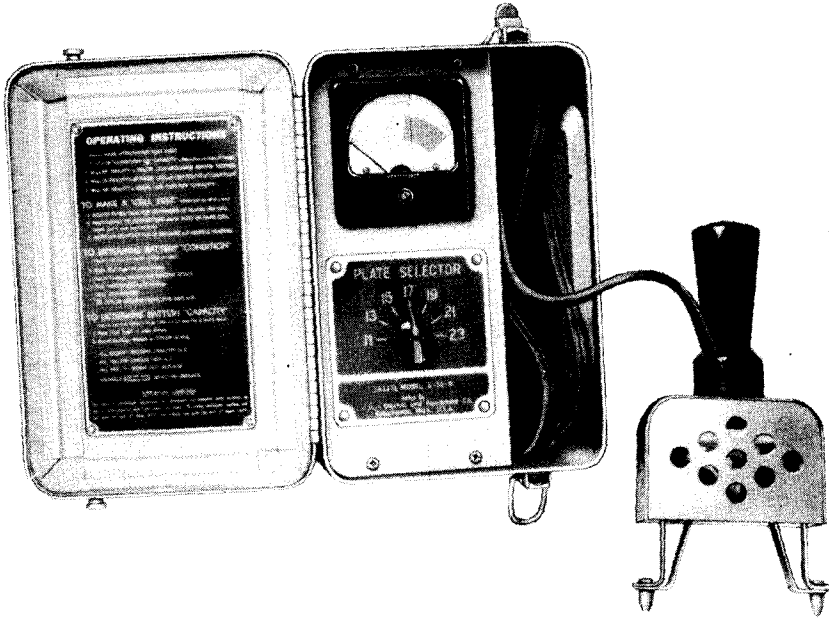

RA PD 322844

Figure 9—Battery Testers—Universal

THE ARMY LIBRARY
WASHINGTON, D.C.

VEHICULAR GENERAL PURPOSE UNIT EQUIPMENT

19. OPERATION.

a. **Prod Type, Meter Attached** (fig. 9). Adjust the prods to suit the battery to be tested. Scratch the surface of the battery terminal for good contact. Apply the prods and take reading of the meter. When using the instrument as a cell tester, the load switch nut must be screwed down tight on its seat. To read the open circuit voltage of a cell, loosen the knurled nut $\frac{3}{4}$ turn.

b. **Prod Type With Selector** (fig. 9). Adjust the plate selector to number of plates per cell of battery being tested. Place the prods to the terminals of the battery cell, maintain contact for 15 seconds, and observe the meter readings. The needle will register in the green zone for good capacity, yellow zone for unsafe capacity, and red zone for dead battery.

Section IX

TESTER, LOW-VOLTAGE CIRCUIT—No. 17-T-5575

(Electric Heat Control Co., Models Nos. 1-41 and 1-42)

20. DESCRIPTION.

a. The low-voltage circuit tester is a self-contained instrument mounted in a metal box which serves as a carrying case (fig. 10). It is designed for testing the battery generator circuit, including any current and voltage regulators, cut-out settings, and generator performance. The tester operates on the power generated into the battery of the vehicle system, and will test 6- or 12-volt systems.

21. CONTROLS AND INSTRUMENTS.

a. **Voltage Selector Switch** (fig. 11). The switch is located on the left side of the instrument panel above the regulator test selector, and is used for the selection of voltage required for the system being tested.

b. **Utility Switch** (fig. 11). The utility switch is located to the left and below the meter. It operates in two positions: to the left for voltage reading, and to the right for regulator test.

c. **Field Rheostat** (fig. 11). The field rheostat is located on the lower left side of the instrument panel. The rheostat is provided for controlling the voltage of generators at idling speed to check cut-out closing voltage.

d. **Regulator Test Selector** (fig. 11). The test selector is located at the right lower corner of the instrument panel. It is set to the test required before performing test. The push button located directly above controls the reading on the voltmeter.

e. **Polarity Switch** (fig. 11). The polarity switch is set to suit the polarity of the vehicle. Two movements control its operation. Moving switch to the left produces negative ground, to the right positive ground.

TESTER, LOW-VOLTAGE CIRCUIT—No. 17-T-5575

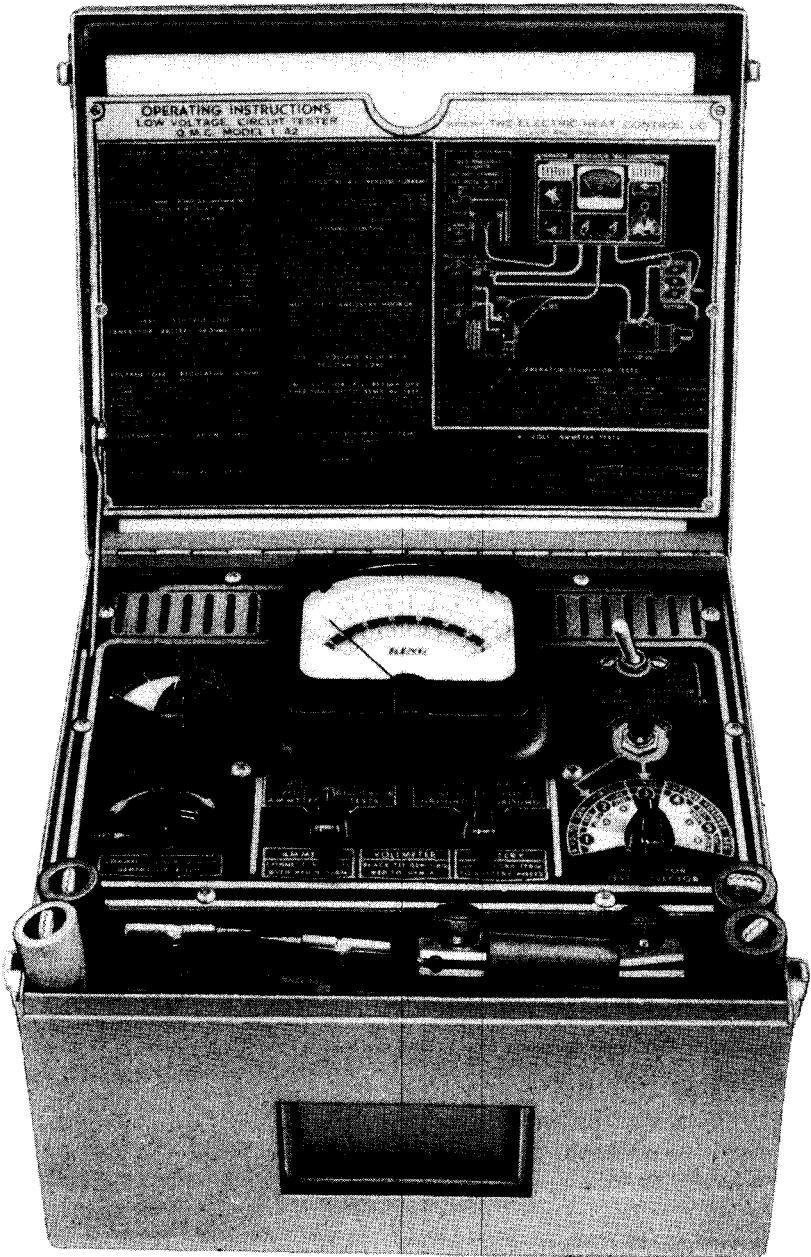

RA PD 322764

Figure 10—Low-voltage Circuit Tester

VEHICULAR GENERAL PURPOSE UNIT EQUIPMENT

f. **Dial Indicator** (fig. 11). The indicator is located in the center of the instrument panel directly over the utility and polarity switches. It is calibrated to the readings of the various tests, the reading being indicated by the pointer.

22. OPERATION.

a. **Generator-Regulator Test Connections** (fig. 12). Set the knob of the voltage selector switch to correspond to the voltage of the system being tested. Turn the utility switch in regulator test position, and place the polarity switch to suit ground polarity of the vehicle. Disconnect the wire from the regulator marked "B," and connect the shunt clip to the terminal. Connect the wire removed to the end terminal of the shunt clip, putting the shunt in series with the circuit being tested. Connect voltmeter lead tagged "ARM" to armature terminal of the generator, and the lead tagged "GRD" to the generator housing.

b. **Battery Test** (fig. 11). Set regulator test selector switch in No. 1 position. When operating the starting motor of vehicle with ignition "OFF," the reading in the yellow scale of the voltage indicator should not drop below 5.25 volts on 6-volt systems, or 10.5 volts on the red scale for 12-volt systems.

c. **Voltage Loss in Generator-Battery Ground Circuit** (fig. 11). Set the regulator test selector in No. 2A position; run the engine at 2000 revolutions per minute and press black push button. The reading on the voltmeter should not exceed 0.05 volt on the green scale.

d. **Voltage Loss In Regulator Ground** (fig. 11). Set regulator test selector switch in No. 2A position with engine running. Disconnect the voltmeter "GRD" test cable which is connected to the generator frame, connect to the regular frame and press black push button. The reading on the voltmeter should not exceed 0.05 volt, one division on the green scale. The ground cable is now in position for all the following tests.

e. **Voltage Loss in Charging Circuit** (fig. 11). Set regulator test selector in No. 2B position with engine running. Press the black button, and note voltage loss on the yellow scale of the voltmeter; maximum loss should not exceed 1 volt for under hood battery or 1.5 volts elsewhere.

f. **Current Regulator Test** (fig. 11). Set the regulator test selector switch in No. 3 position and run engine at 2000 revolutions per minute. Press black push button and note charging rate (amperes on black scale of voltmeter). The charging current should be equal to the rated capacity of the generator.

g. **Cut-out Relay Test** (fig. 11). Set the regulator test selector switch in No. 3 position. Gradually reduce the engine speed from 2000 revolutions per minute, push the black button, and note reverse current on the black scale; it should not exceed 5 amperes. Place the regulator test selector switch in No. 4 position, idle the engine and gradually in-

TESTER, LOW-VOLTAGE CIRCUIT—No. 17-T-5575

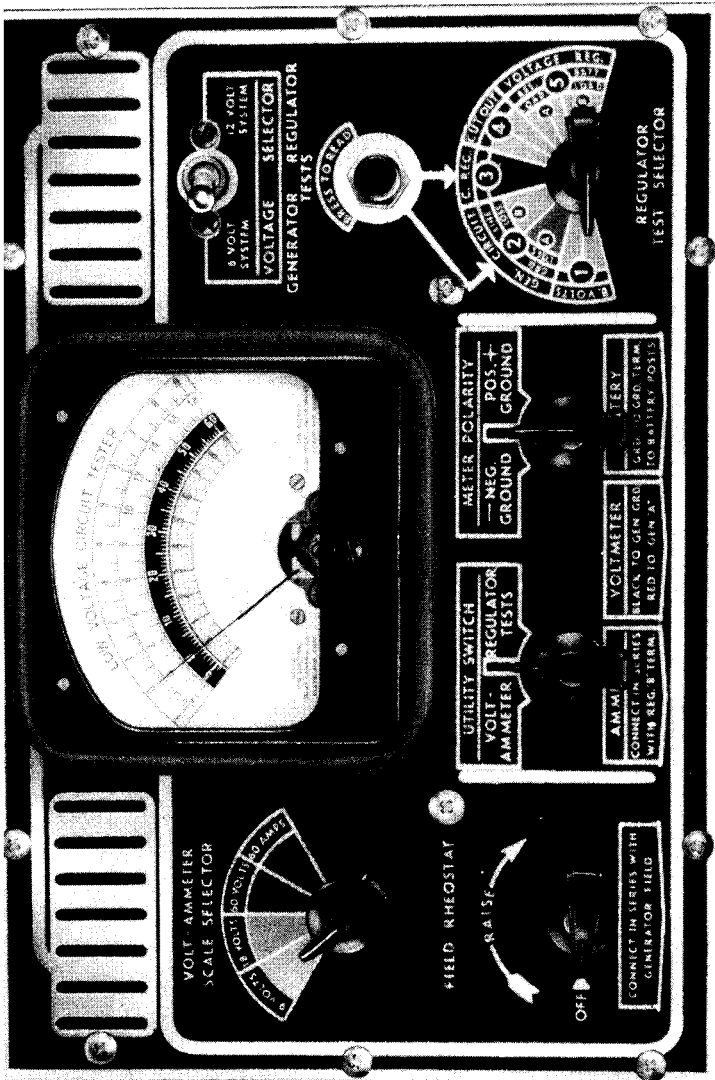

RA PD 322777

Figure 11—Tester Instrument Panel

VEHICULAR GENERAL PURPOSE UNIT EQUIPMENT

crease speed, then observe voltage at which cut-out points close. This will be indicated by the voltmeter pointer dropping back at the moment the cut-out points close. Closing voltage should be at least 0.5 volt under voltage setting of regulator.

h. Voltage Regulator Test, Resistance Load (fig. 11). Set the regulator test selector in No. 5A position and disconnect the battery lead from the end of shunt clip. Run engine at 2000 revolutions per minute

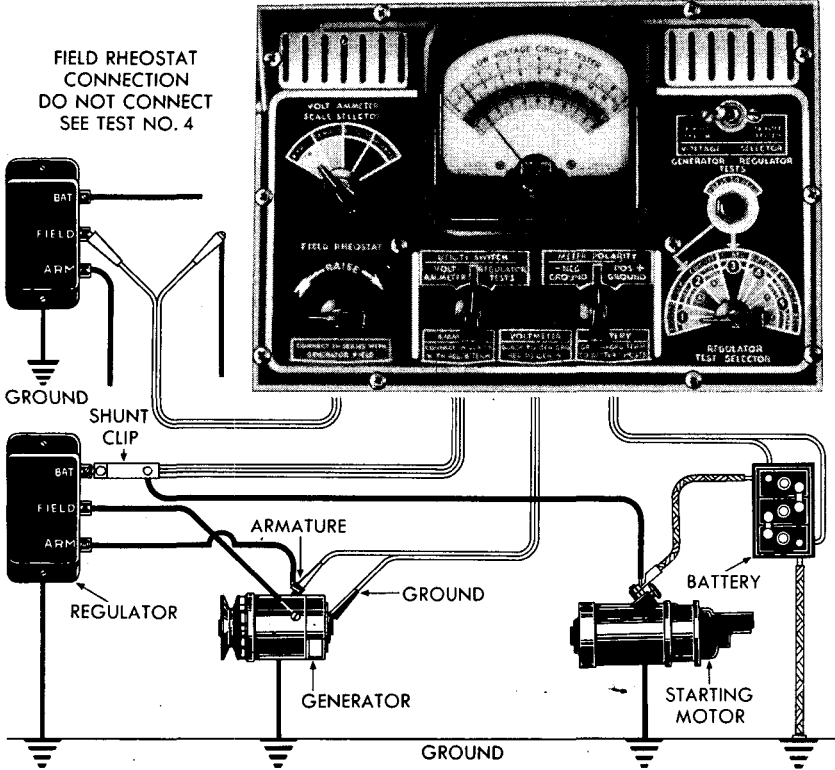

RA PD 322796

Figure 12—Generator-regulator Test Connections

for 5 minutes to allow voltage to stabilize, and note exact point at which the regulator limits the voltage. Read the yellow scale on the voltmeter for 6-volt systems, and the red scale for 12-volt systems.

i. Voltage Regulator Test, Battery Load (fig. 11). Set the regulator test selector in No. 5B position, and reconnect battery lead to end terminal of shunt clip. Run the engine at 2000 revolutions per minute for 5 minutes, then note voltage reading on the yellow scale for 6-volt systems, and on the red scale for 12-volt systems. On 6-volt systems this voltage should read from 6.5 to 7.6 volts.

TESTER, IGNITION CIRCUIT, HIGH-TENSION—No. 17-T-5520

Section X

**TESTER, IGNITION CIRCUIT, HIGH-TENSION—
No. 17-T-5520**

(Heyer Products Co., Model No. M-1)

23. DESCRIPTION.

a. The high-tension ignition circuit tester (fig. 13) is a self-contained testing instrument mounted in a steel box which also serves as a carrying case. All the wire leads necessary for the tests on a vehicle are included as integral parts of tester. It is designed to test 6- or 12-volt systems. Flashlight batteries located in the instrument operate the breaker contact meter; otherwise, no other power than that of the system being tested is required.

24. CONTROLS AND INSTRUMENTS.

a. **Coil Test Switch.** The switch is located to the right of the breaker contact meter, and is used when observing continuity of spark in coils, condensers, and spark plugs.

b. **Variable Spark Gap.** The spark gap is located in upper right corner of the instrument panel, and is adjustable by turning the control knob. The spark gap is used for observing continuity of spark in coils, condensers, and spark plugs.

c. **Breaker Test Switch.** The switch is located at the left of the pointer adjusting knob of the breaker contact meter. It is used in two positions: "ADJUST" when setting meter pointer, and at "READ" for observing meter readings.

d. **Breaker Contact Meter.** The meter indicates the readings of the tests in operation, and is adjustable. The pointer is set by turning the control knob directly below the center of the meter.

e. **Polarity Switch.** The polarity switch is set to match the ground polarity of the vehicle system.

f. **Condenser Switch.** The condenser switch is used in observing the effect on high-tension output and arcing at tester breaker contacts. It is movable to two positions: test condenser and vehicle condenser.

g. **Motor Switch.** The motor switch is located on the instrument panel directly below the coil test breaker and controls the motor which operates the breaker.

h. **Coil Test Breaker.** The breaker is located in the upper left corner of the instrument panel. It is enclosed with glass for observation of the effect on high-tension output and arcing of tester breaker contact.

25. OPERATION.

a. **Coil Output, Comparative Test (fig. 15).** Disconnect coil to distributor low-tension leads on the vehicle. Using the three low-tension

VEHICULAR GENERAL PURPOSE UNIT EQUIPMENT

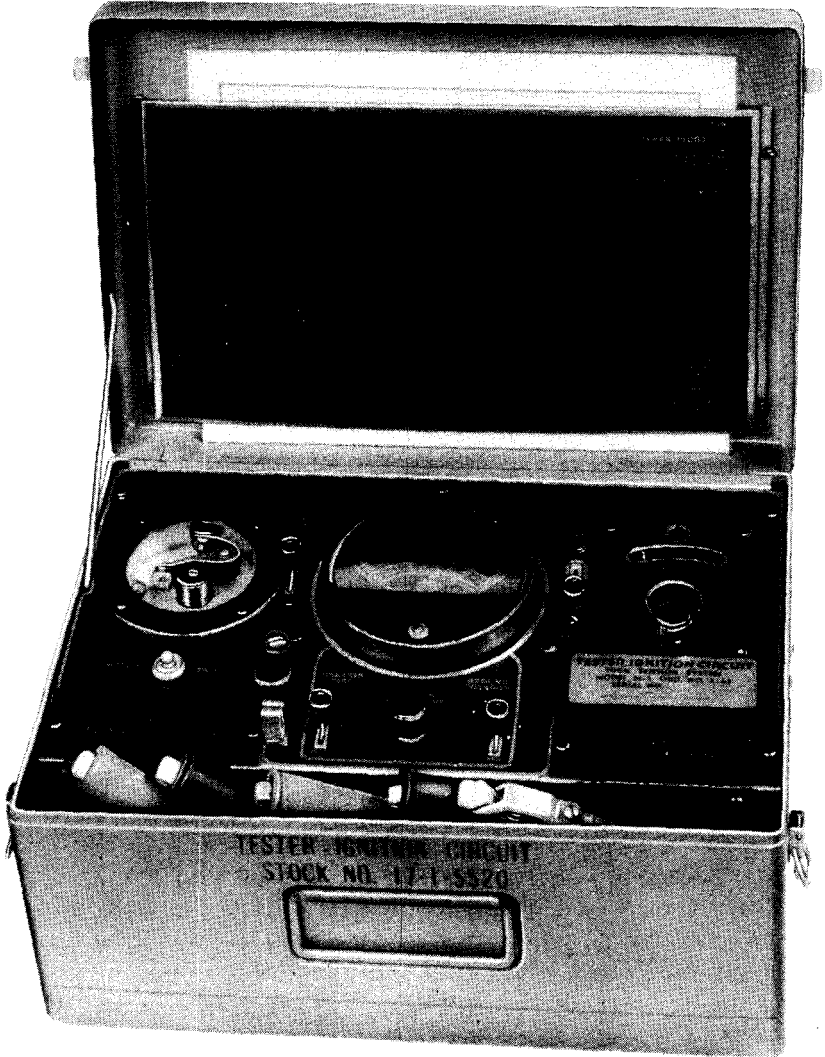

RA PD 322769

Figure 13—High-tension Ignition Circuit Tester

TESTER, IGNITION CIRCUIT, HIGH-TENSION—No. 17-T-5520

RA PD 322792



Figure 14—High-tension Ignition Tester Control Panel

VEHICULAR GENERAL PURPOSE UNIT EQUIPMENT

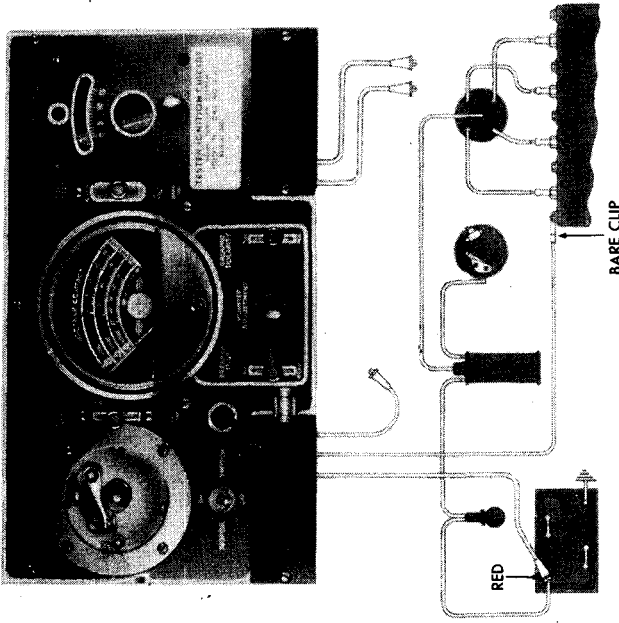

RA PD 322799

Figure 16—Condenser Comparative Test

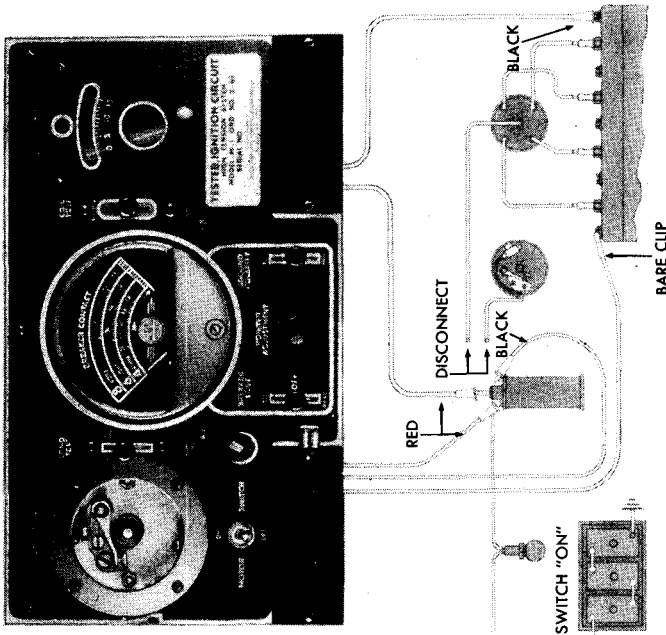

RA PD 322798

Figure 15—Coil Output Comparative Test

TESTER, IGNITION CIRCUIT, HIGH-TENSION—No. 17-T-5520

leads on the left side of the instrument, connect the "BLACK" lead to the distributor terminal of vehicle coil, the "BARE" clip to a good ground on the engine, and the "RED" clip to the battery terminal of the vehicle coil. Using the high-tension leads located on the right side of the instrument, connect the "RED" clip to the vehicle coil high-tension terminal, and the "BLACK" clip to a good ground on the engine. Turn the vehicle ignition switch "ON," and throw the coil test switch to test coil. Turn the motor switch "ON," and adjust variable spark gap to highest setting obtainable without missing. Move the coil test switch to vehicle coil, and observe continuity of spark.

b. Condenser, Comparative Test (fig. 16). Remove the vehicle condenser and insert in the clip located on the instrument panel to the left of the breaker test switch, and attach short test lead to pigtail terminal. Using the low-tension leads on the left side of the instrument, connect the "BARE" clip to a good ground on the engine, and the "RED" clip to battery or starter switch. Place the coil test switch at "TEST COIL" and turn motor switch "ON." Adjust variable spark gap to highest setting obtainable without missing, and move condenser test switch to "VEHICLE COND." Observe the effect on high-tension output and arcing at tester breaker contact.

c. Vehicle Breaker Test (fig. 17). Using the low-tension test leads on the left side of the instrument panel, connect "BLACK" clip to primary terminal of distributor, and the "BARE" clip to a good ground on the engine. Set the polarity switch to match the ground polarity of the vehicle system, and place the coil test switch in "TEST COIL" position. Close vehicle breaker contacts and turn vehicle ignition switch "ON." Hold the breaker test switch at "ADJUST," and set meter to line indicated by arrow. Move the breaker test switch to "READ" and operate engine at fast idle (500 rpm). Hold breaker test switch at "ADJUST" and set meter to line indicated by arrow. Hold breaker test switch at "READ," and observe cam angle of breaker contacts. Raise engine speed to 2500 revolutions per minute, and note any reduction in cam angle.

d. High-Tension Cables (fig. 18). Place the coil test switch in vehicle coil position. Disconnect spark plug cable and connect high-tension test lead (red clip) to end of spark plug cable. Connect high-tension test lead (black clip) to spark plug. Operate the engine at fast idle and place the variable gap at maximum setting obtainable without missing.

e. Spark Plugs (fig. 19). For the short-circuit test do not disconnect vehicle high-tension cables. Connect high-tension lead (black clip) to engine ground. Connect high-tension lead (red clip) to spark plug terminal. Open variable spark gap to 15 millimeters; operate engine at fast idle (500 rpm) and observe neon tube flashes. Regular flashes indicate correct firing, weak or irregular flashes indicate leak between

VEHICULAR GENERAL PURPOSE UNIT EQUIPMENT

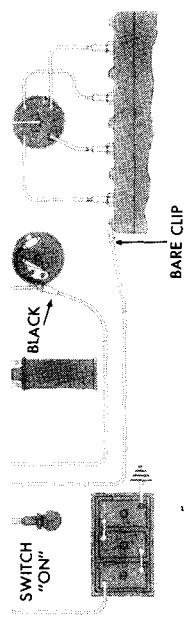
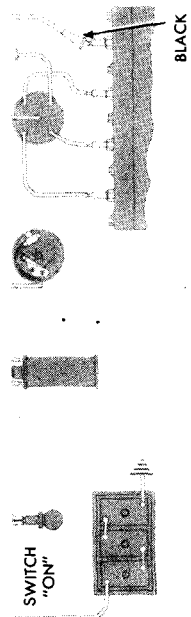
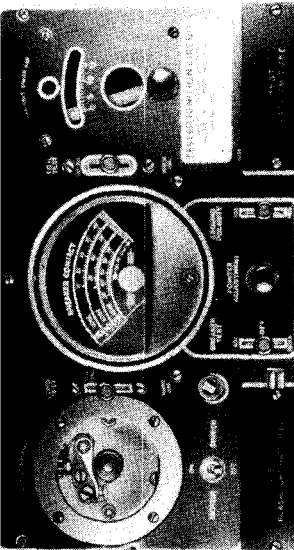
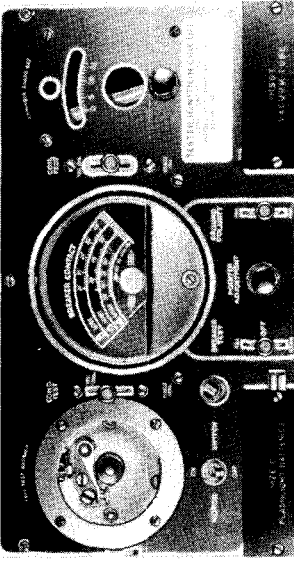

RA PD 322801

Figure 18—High-tension Cable Test

RA PD 322800

Figure 17—Vehicle Breaker Test

TESTER, DISTRIBUTOR, MOTOR-DRIVEN—No. 17-T-5540

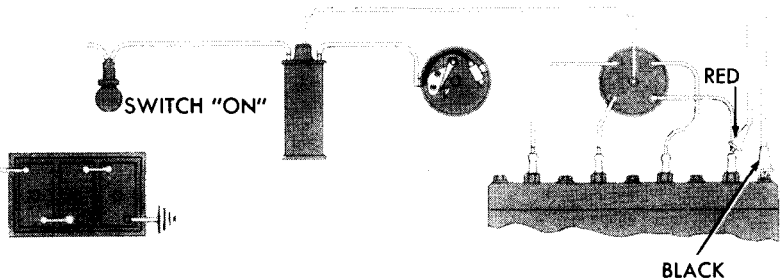
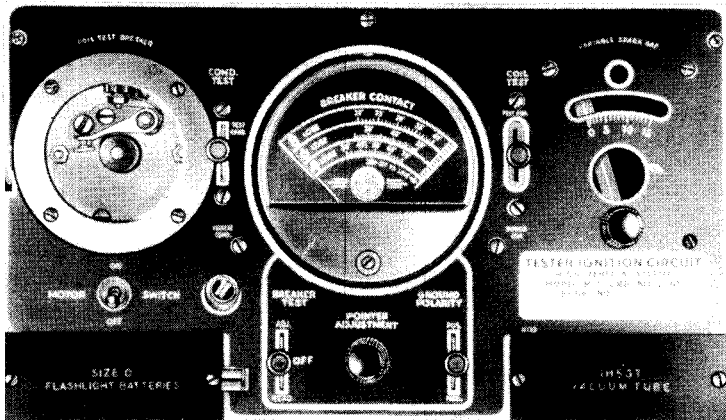

Figure 19—Spark Plug Test

RA PD 322802

vehicle high-tension cables or faulty distributor cap. For the resistance test clean and gap spark plugs. Close the variable spark gap and connect high-tension test lead (black clip) to engine ground. Connect high-tension test lead (red clip) to spark plug, and put engine at fast idle (500 rpm). Gradually open the variable spark gap and note at what setting (in millimeters) the spark stops jumping the gap. Spark plug resistance is proportionate to this gap setting.

Section XI

TESTER, DISTRIBUTOR, MOTOR-DRIVEN—No. 17-T-5540
(Lanagan & Hoke, Model No. 500)

26. DESCRIPTION.

a. The distributor tester is designed for both bench and floor operation; a steel cabinet protects tester when not in use, and acts as stand

VEHICULAR GENERAL PURPOSE UNIT EQUIPMENT

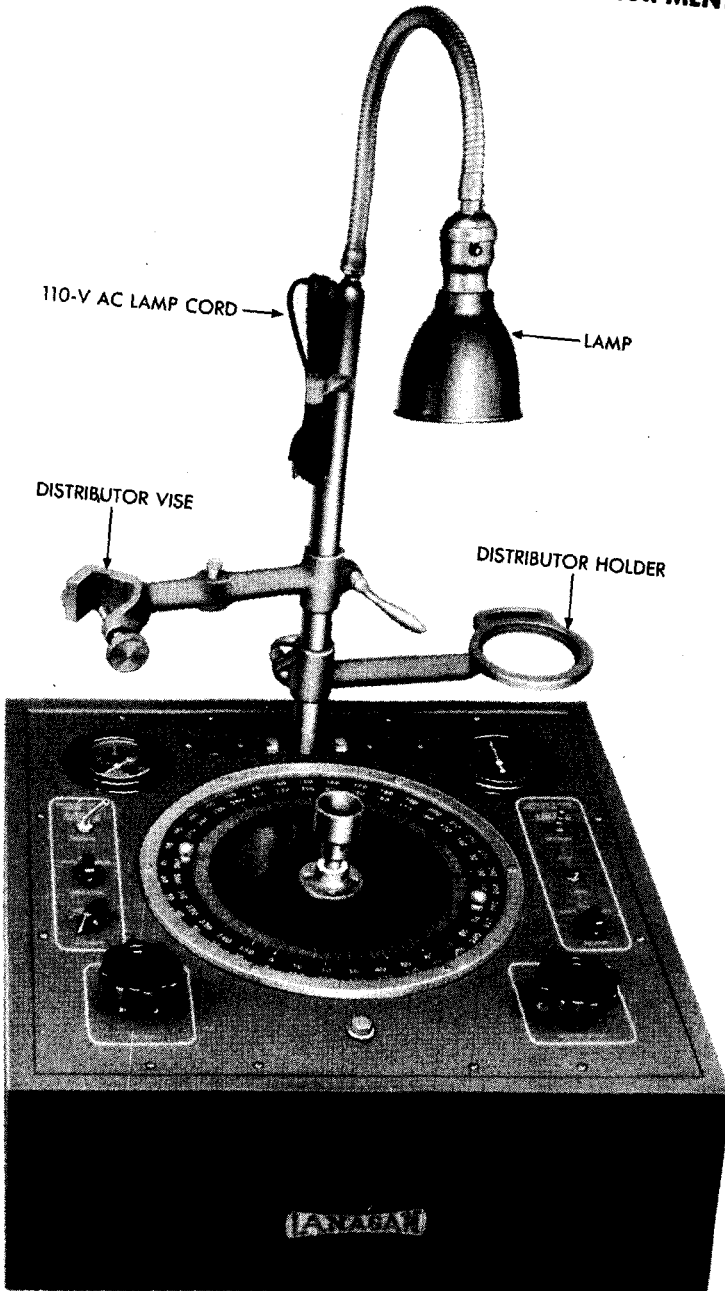

Figure 20—Distributor Tester

RA PD 322786

TESTER, DISTRIBUTOR, MOTOR-DRIVEN—No. 17-T-5540

when necessary. The tester is designed for a quick and accurate test of any ignition distributor from low to high speeds, and is operated on 110-volt, 60-cycle electrical supply ONLY. D-C current can be used only when a d-c converter is available. It is operated through the use of a series of controls and switches, a circular degree ring indicator, and an electric motor that drives the distributor under test. Light bars in various colors denote operating conditions.

27. CONTROLS AND INSTRUMENTS (fig. 21).

a. **Motor Switch.** The motor switch is located on the right side of the instrument panel directly under the pilot light. The switch controls the direction of rotation of the motor and the power supply. It is moved in two positions: to the left for distributors having left-hand rotation, and to the right for right-hand rotation.

b. **Rheostat, Motor Speed.** The rheostat is located in the lower right-hand corner of the instrument panel. It controls the speed of the electric motor. Speed of the motor is increased by turning the knob clockwise.

c. **Intensity Control.** The intensity control is located on the left side of the control panel directly opposite the motor switch. It controls the intensity of the light in both red and blue tubes. The amount of light is increased by turning the knob to the right to make the readings of the degree marks on the dial easier to read.

d. **Indicator Switch.** The switch is located on the left side of the instrument panel directly above the intensity control. It changes the circuit to allow cam angle degrees to be determined. The "break" position is used to find the breaker point opening, and the "make" position to find the angle that the points are closing.

e. **Vacuum Pump Knob.** The knob is located in the lower left-hand corner of the instrument panel, and operates the vacuum pump. The pump is connected to the vacuum advance mechanism on the distributor under test.

f. **Tachometer.** The tachometer is located in the upper right-hand corner of the instrument panel. The tachometer is calibrated to revolutions per minute, and is used in connection with the motor and control.

g. **Vacuum Gage.** The gage is located in the upper right-hand corner of the instrument panel and is calibrated 5 to 30 inches of vacuum. It is connected into the vacuum line, and registers when the vacuum pump is operated. The gage registers the number of degrees, advance or retard, produced at various vacuums.

h. **Circular Degree Ring.** The ring is located in the center of the instrument panel and is graduated both left and right, a full 360 degrees. The dial is graduated at each degree for accurate readings. Zero orientation is obtained by shifting the degree ring.

VEHICULAR GENERAL PURPOSE UNIT EQUIPMENT

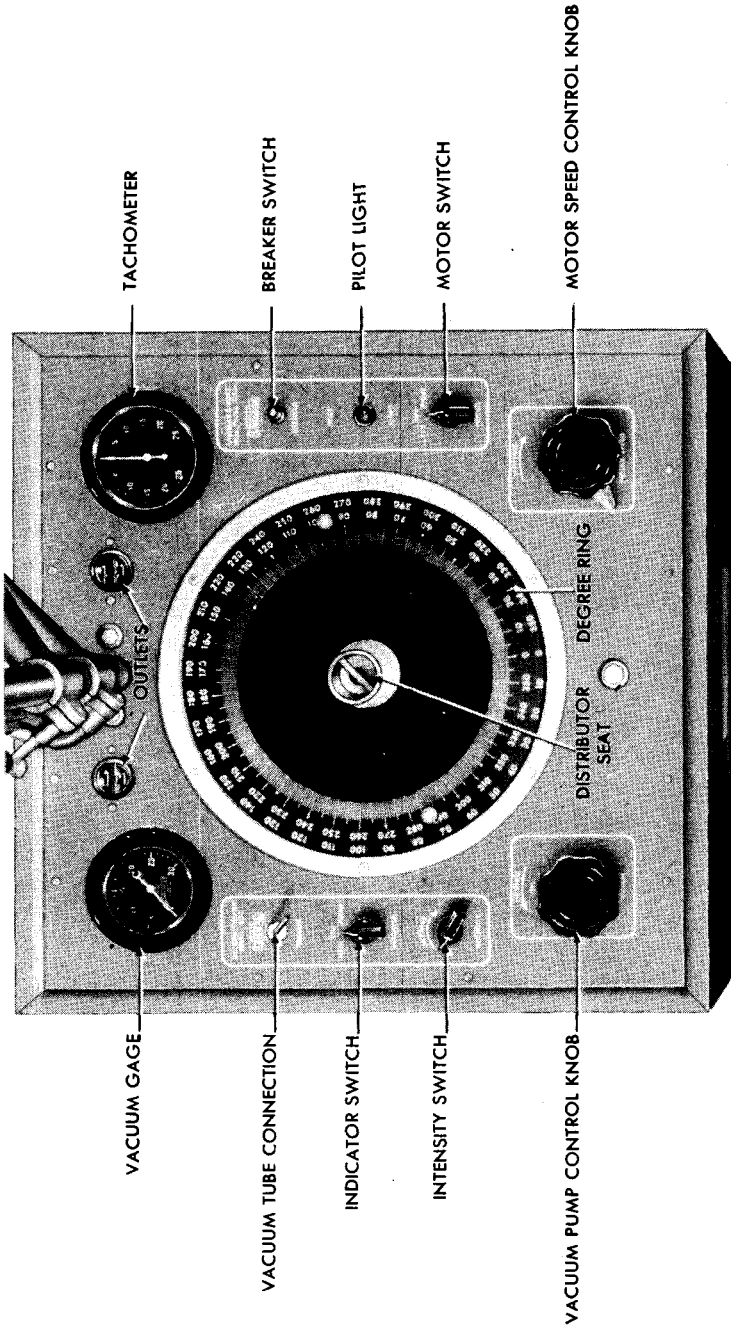

RA PD 312831

Figure 21—Instrument Panel

TESTER, DISTRIBUTOR, MOTOR-DRIVEN—No. 17-T-5540**28. OPERATION.**

a. **Preparation.** Place switches marked “indicator” and “motor” in the “OFF” position. Insert one plug of 10 foot a-c extension cord to any 110-volt, 60-cycle a-c outlet, and connect instrument lamp. Attach the distributor test lead to the terminal marked “breaker,” and slip hose over tube marked “vacuum.” Mount the distributor to be tested in the “vise arm.” Turn motor control switch to right or left, depending on the rotation of the distributor under test, and adjust the vise arm to permit free shaft travel at low speed. Tighten the vise arm so that weight is not on the drive shaft of the distributor.

b. **Cam Angle Test.** Turn the motor control switch to the right or left, depending on the rotation of the distributor. Turn the motor speed control to rotate distributor, and turn the indicator switch to “MAKE.” Turn the degree ring so that one of the red light bars centers exactly under the zero graduation of the ring, and turn the motor speed control until the tachometer registers 1000 revolutions per minute. Adjust intensity to give best definition of the red light bars. Each of these bars indicates the point at which the breaker points are making contact. Throw the indicator to “BREAK.” The positions of the light bars will change. Read the number of degrees to the left of zero that the first light bar appears, this will be the cam angle. The degrees to the right of zero at which the other light bar appears is the interval the points remain open. Adjust the points to the original settings that are given. The firing interval for any distributor can be determined by dividing 360 degrees by the number of cylinders that the distributor fires. *

c. **Worn Cam, Distributor Shaft, Bearing Shaft, and Bent Shaft.** The above conditions will cause one or more blue lights to appear; the number of degrees between red and blue light bars show the amount of change in the cam angle degrees due to the worn parts. If the shaft is moving left to right from center, the blue lights appear at left and right sides of the degree ring. With the motor at low speed, force the distributor shaft over to one side. The blue light bars will change accordingly. A tolerance of plus or minus two degrees is allowable. *NOTE: The blue bars always exist when the tester is operating, but flash in phase with the red light bars, and are not visible. They are only visible when a distributor condition causes them to flash out of phase.*

d. **Weak Breaker Springs.** When springs are weak, the lack of tension allows the movable point to bounce. This is indicated by one or more light bars appearing intermittently next to the original ones.

e. **Breaker Points or Plate Grounded or Shorted.** No lights appear.

VEHICULAR GENERAL PURPOSE UNIT EQUIPMENT

f. **Imperfect Setting of Cam Followers.** Run motor at 1000 revolutions per minute for 10 or 15 minutes to allow fiber rubbing block to wear to full length bearing surface. The cam angle will not remain constant if bearing is imperfect.

g. **Worn Breaker Arm Pin, Bushing, or Loose Pin in Breaker Plate.** Blue light bars will appear close to the red light bars. This indicates that the movable point is creeping.

h. **Worn Breaker Plate.** When the vacuum advance is operated the breaker plate will tilt.

OIL TUBE, DRIVE SHAFT

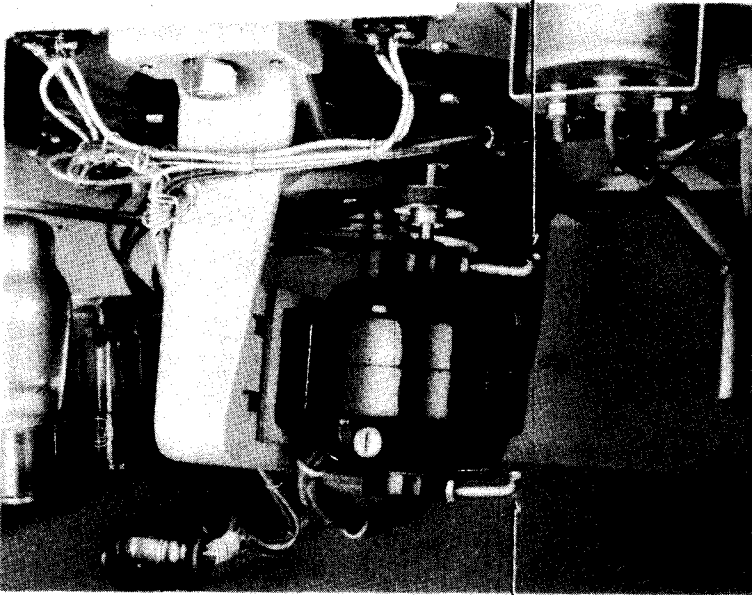

OIL TUBE, MOTOR

RA PD 322767

Figure 22—Motor Oiling Points

i. **Automatic Spark Advance.** Adjust motor speed to 300 revolutions per minute and turn the degree ring so one of the red light bars is on zero. Set the indicator switch on "MAKE," and run the motor to the specified speeds for starting, intermediate and high points. The degrees of advance of the red light bars on the degree ring should coincide with the values given for each of the three speeds. Variations of two degrees are allowable. As the speed increases, the advance will be in the direction opposite to that of rotation.

TESTER, DISTRIBUTOR, MOTOR DRIVEN—No. 17-T-5540

j. **Vacuum Spark Control.** Connect the hose from vacuum outlet to vacuum control mechanism, and run distributor at 1000 revolutions per minute. Set one red light bar to zero and operate the vacuum pump. The red light bars should retard or advance. The full angle or advance is reached when light bars will not move any further, regardless of increased vacuum.

k. **Synchronizing Double Breaker Distributors.** Mount the distributor as previously instructed, and ascertain the distributor rotation and cam angle value. Examine the distributor breaker plate to determine the movable and stationary breaker points. Attach the test leads

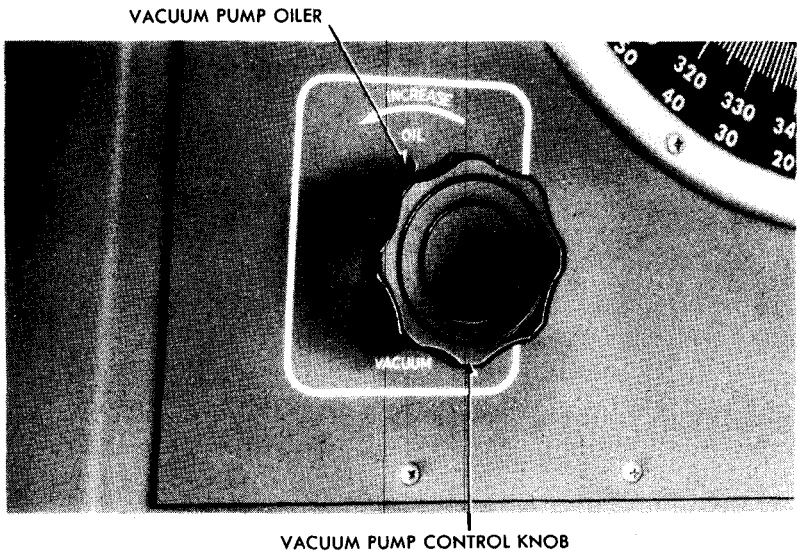

Figure 23—Vacuum Pump Oiler

RA PD 322774

to the stationary points, and adjust to the proper cam angle. Remove the test lead from stationary points, and connect to movable points. Adjust cam angle value of the movable points. Adjust the movable plate until the light bar indicates the correct relationship with the stationary points.

29. LUBRICATION.

a. There are three points of lubrication on the tester:

- (1) The motor must be oiled every two months with light machine oil (fig. 22).
- (2) The drive shaft bearing must be oiled every six months with light machine oil (fig. 22).
- (3) The vacuum pump must be oiled every three months (fig. 23).

VEHICULAR GENERAL PURPOSE UNIT EQUIPMENT

Section XII

WELDING OUTFIT, ELECTRIC ARC—No. 17-W-1715
(Hobart Mfg. Co., Model No. GR-300-S)

30. DESCRIPTION AND DATA.

a. **Description** (figs. 24, 25, and 26). The welding outfit is a gasoline engine-driven arc welder. It is self-contained, powered by a Chrysler Industrial, 6-cylinder, self-starting engine, connected directly to a welding generator of the multirange type, with four laminated main poles and interpoles. It is equipped with an auxiliary 3-kw power generator which provides power for lights and equipment such as lathes, grinders, drills, etc. Separate control panels are provided for the engine generator, welder, and auxiliary generator. An additional feature is the remote control which is easily attached, and used for controlling the welder at a distance from the machine. Convenience outlets provide easy connections for lighting and electrically driven equipment. The welder is compact in construction, and is designed with a lifting eye located on top of the welder. The welder can be used in a machine shop, or can be transported, complete with accessories, for field work.

b. **Data.**

(1) **WELDER ASSEMBLY.**

Weight (as shown) 2000 lb
Height 44 in.
Length 75¼ in.
Width 25 in.

(2) **ENGINE.**

Make Chrysler Industrial, 6-cylinder
Bore 3⅞ in.
Development 50 brake hp at 1500 rpm
Maximum torque 183 ft-lb at 1200 rpm
Firing order 1-5-3-6-2-4
Stroke 4¼ in.
Model T-118-502
Displacement 236.6 cu in.

(3) **WELDER.** Rate: 40 volts under 1-hour resistance load at 1500 revolutions per minute; current range 50 to 400 amperes.

31. CONTROLS.

a. **Engine Control Panel** (fig. 27). The panel is located to the right of the welding control panel on the right-hand side of the machine,

WELDING OUTFIT, ELECTRIC ARC—No. 17-W-1715

and consists of a cluster of the ignition switch, engine starting button, the governor control knob which controls the speed of the engine when the welder is in use, the oil pressure gage, and the engine temperature gage.

b. Generator Control Panel (fig. 28). This panel is located on the right side of the welder, directly over the generator, and consists of an ammeter, voltmeter, polarity reversing switch, two connecting stud assemblies, an outlet plug, a rheostat which controls the generator voltage, and multirange dual control, and wheel.

c. Multirange Control (fig. 28) controls 10 ranges of welding current and 100 steps of volt-ampere adjustment in each range for the selection of the arc characteristics, and is controlled by the insulated handwheel.

d. Auxiliary Control Panel (fig. 28). The panel is located on the right-hand side of the welder next to the generator control panel. It consists of two sets of 115-volt double receptacles, one set of 115-volt binding posts, one set of 6-volt binding posts, a battery ammeter, d-c voltmeter, d-c ammeter, a switch for the canopy lights, and the rheostat that controls the 115/120-circuit voltage.

e. Remote Control (fig. 29). The remote control is used when a welding job is some distance away from the welding machine and frequent adjustments are necessary. The volt-ampere adjuster is removed, and a two-conductor extension cord (rubber-covered), fitted with an attachment plug on one end and a socket on the other, is connected to the control panel and the volt-ampere adjuster.

f. Electric Fuel Pump. The fuel pump is electrically operated from the battery, and is of the autopulse type. It is automatically put in operation when the ignition switch is turned on. It is located on the left-hand side of welder, mounted on the shield (fig. 30).

32. OPERATION.

a. Starting Engine. Start the engine by turning ignition key to "ON" position, and press starting button until engine takes hold. Choke is automatic (fig. 27).

b. Starting Welding Generator. When the engine has warmed up at idling speed, set the governor at 1500 revolutions per minute which is the initial speed (fig. 27). Set the volt-ampere adjusting rheostat to maximum (fig. 28), which will bring the generator voltage to 85 volts open circuit. Connect the ground cables and plates and place the polarity switch in "UP" position when using powder fluxed metallic electrodes, and in "DOWN" position when using nonferrous rods and other electrodes.

c. Adjusting Electrical Current (fig. 28). The multirange dual control has ten primary ranges from 50 to 400 amperes, controlled by

VEHICULAR GENERAL PURPOSE UNIT EQUIPMENT

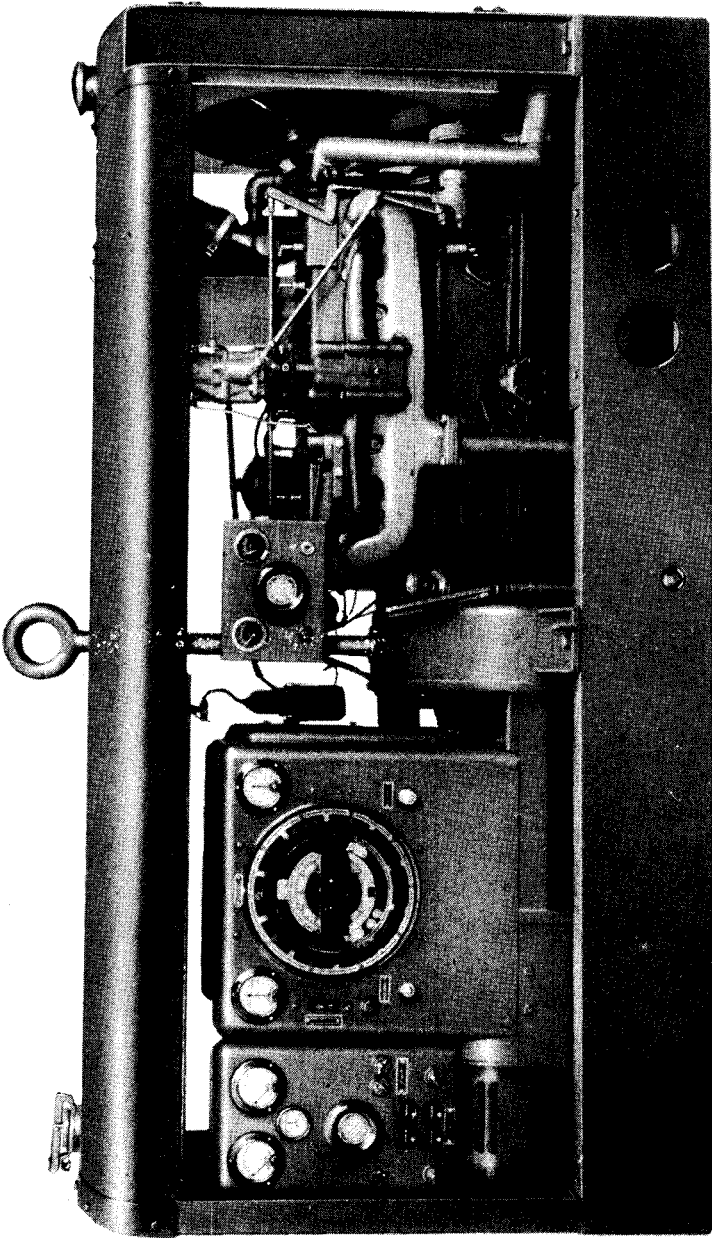

RA PD 322763

Figure 24—Welder—Right Side View

WELDING OUTFIT, ELECTRIC ARC—No. 17-W-1715

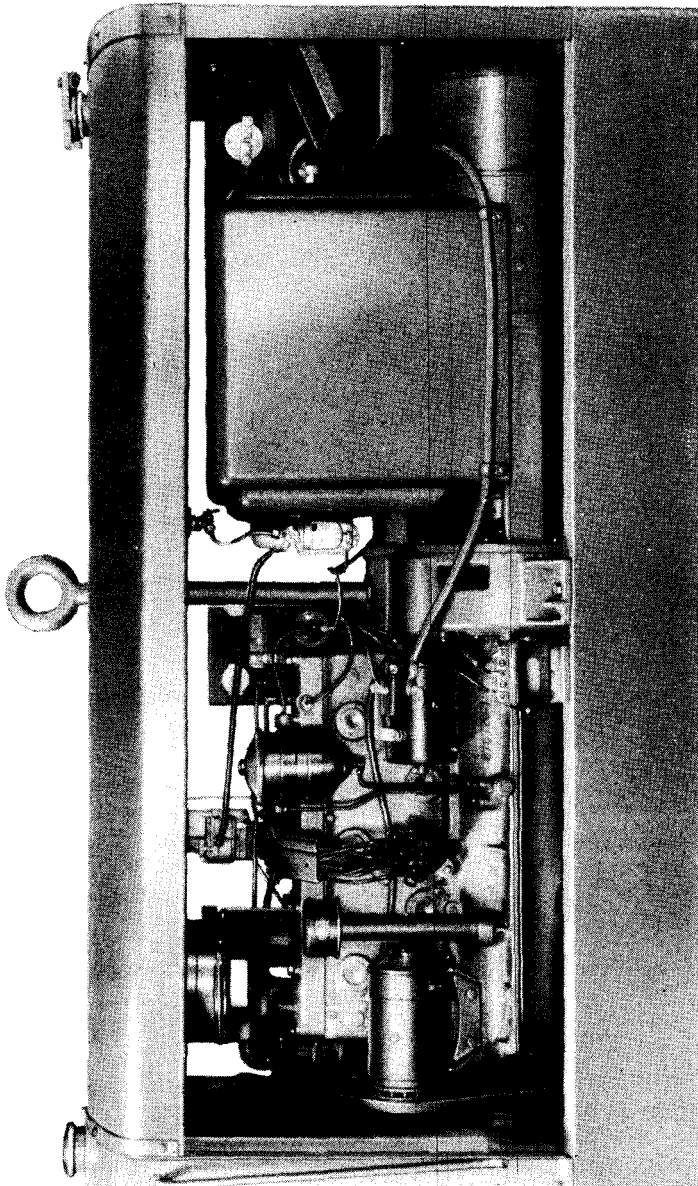

RA PD 322759

Figure 25—Welder—Left Side View

VEHICULAR GENERAL PURPOSE UNIT EQUIPMENT

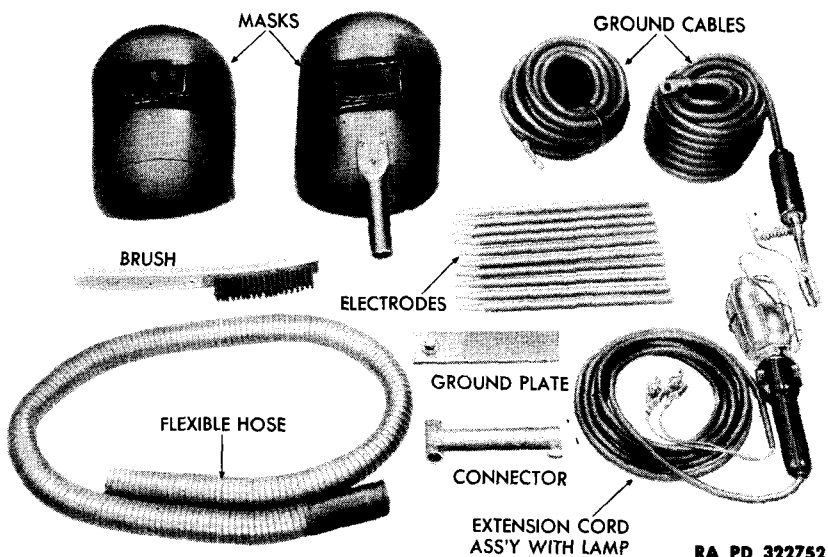

Figure 26—Welding Accessories

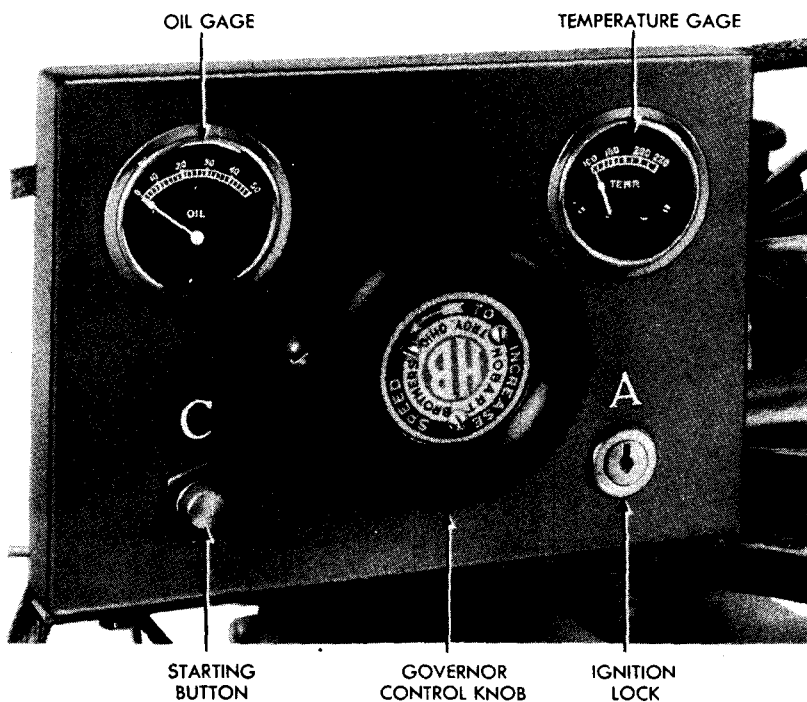
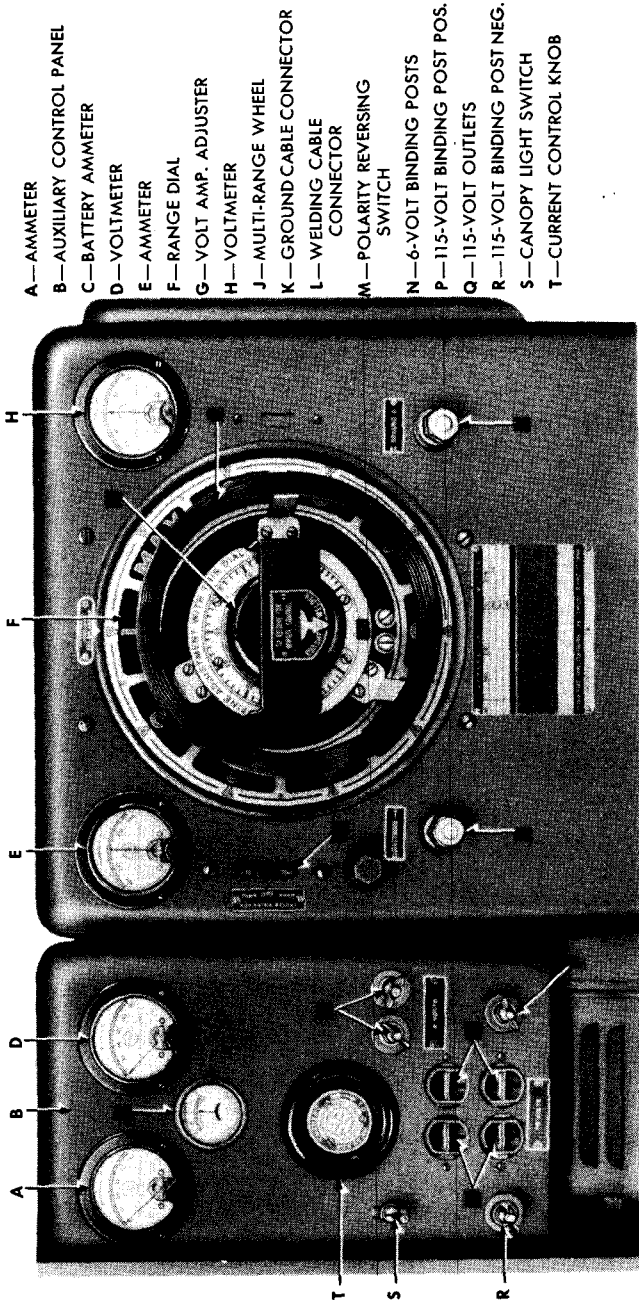

Figure 27—Engine Control Panel

WELDING OUTFIT, ELECTRIC ARC—No. 17-W-1715



RA PD 322845

Figure 28—Generator and Auxiliary Control Panel

VEHICULAR GENERAL PURPOSE UNIT EQUIPMENT

the range wheel. Set the range wheel at the minimum setting. Turn the wheel clockwise to increase the range to the amperes desired, making sure the arrow on the current range dial and the arrow on the panel coincide. Turn the volt-ampere adjuster for finer current adjustment. Never use an open-circuit voltage lower than 59 volts.

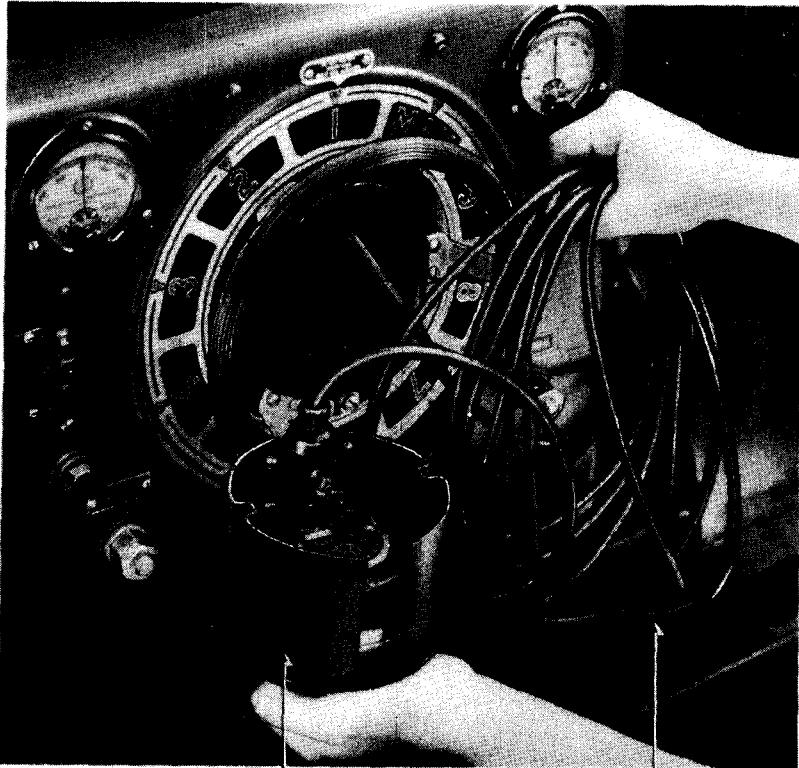

VOLTAGE CONTROL RHEOSTAT

50-FT. EXTENSION CABLE

RA PD 322826

Figure 29—Remote Control

d. **Auxiliary Power Generator** (fig. 28). Set the auxiliary generator rheostat in maximum position, turn the governor control until the ammeter reads 125 to 135 volts, open circuit, and gradually cut the voltage to 115 to 120 volts by turning the rheostat counterclockwise. The total connected load must not be over two horsepower, or the lights in excess of 2200 watts.

WELDING OUTFIT, ELECTRIC ARC—No. 17-W-1715

33. SERVICING.

a. **Carburetor.** The carburetor is of the downdraft type and has fixed jets. It is adjustable for idling speed only, by turning adjusting screw clockwise for lean, and counterclockwise for rich mixtures of gasoline. The float level should be $\frac{3}{4}$ inch below the top of the carburetor bowl. The accelerator pump must be adjusted to climatic conditions. The accelerating pump lever has three adjusting holes; insert the

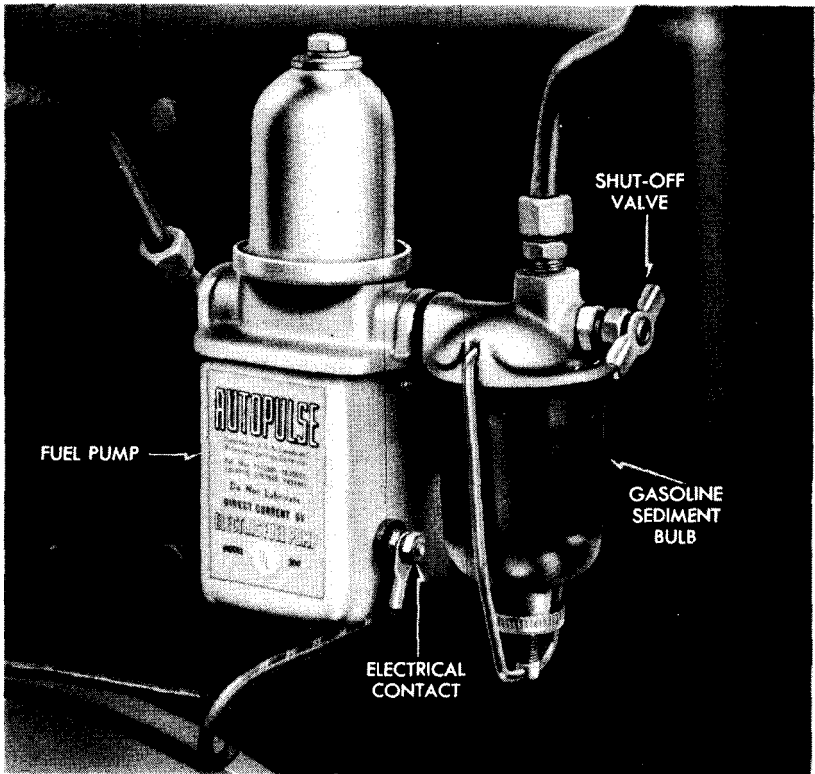

RA PD 322791

Figure 30—Electric Fuel Pump

pump rod in top hole for winter, center hole for intermediate, and bottom hole for summer setting.

b. **Governor.** Adjust the governor by backing the bumper adjusting screw (6, fig. 31) out two turns; reverse the operation by screwing in slowly to relieve surge.

c. **Governor Control Adjustments.** Adjust length of operating rod (1, fig. 31) so that movement of governor arm moves butterfly arm 15 degrees each side of center of carburetor. After adjusting length of rod, pull governor arm, with spring released, toward radiator. Turn

VEHICULAR GENERAL PURPOSE UNIT EQUIPMENT

butterfly to stop, and tighten clamping screw (2, fig. 31) on butterfly shaft. The approximate dimension (3, fig. 31) is for normal operation. To overcome uneven "surging" or "hunting," decrease dimension by turning screw one turn at a time. To increase engine speeds turn screw (4, fig. 31) to the right (clockwise). To decrease speed, turn screw to left (counterclockwise). Lock adjusting screw with nut after final setting. Adjust screw (5, fig. 31) to bring generator voltage to 80 volts open circuit with rheostat in "MAX" position.

d. **Automatic Choke.** Remove the air horn fitting from carburetor. Adjust the choke by inserting a No. 42. drill through the hole in the

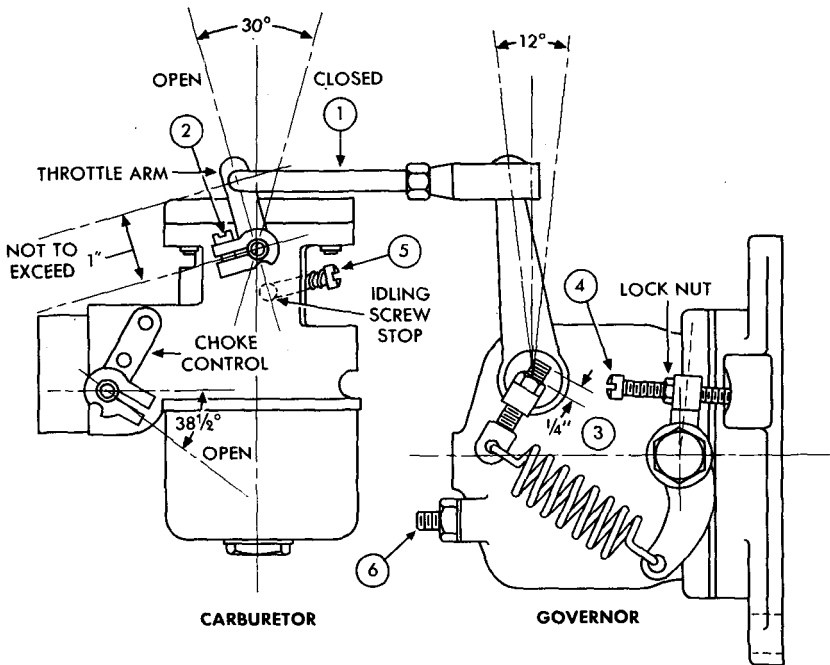

RA PD 322760

Figure 31—Engine Governor Control Adjustments

choke shaft, loosen the clamp screw and lift up on the choke rod until the rod in the air horn is fully closed. Tighten the clamp screw and remove drill. Replace the air horn fitting.

34. LUBRICATION.

a. **General.** Lubrication instructions for the welder are of definite purpose. The intervals indicated are for normal operating conditions. For extreme conditions of speed, heat, and dust, reduce intervals as warranted.

WELDING OUTFIT, ELECTRIC ARC—No. 17-W-1715

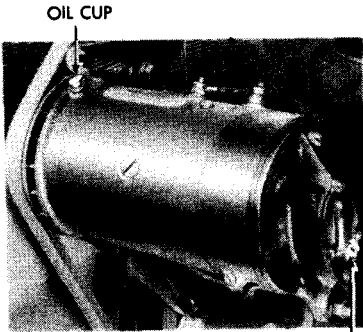

OIL CUP

OIL CUP

A. GENERATOR

2 Oil cups—6 drops OE daily

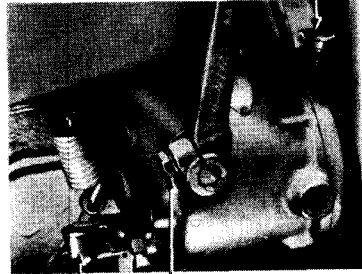

OIL CUP

OIL CUP GOVERNOR

D. GOVERNOR

2 Oil cups—keep filled with OE. Check daily

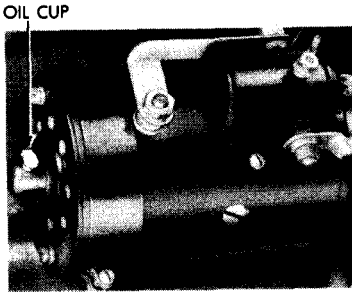

OIL CUP

B. CRANKING MOTOR

1 Oil cup—6 drops OE every 48 hours

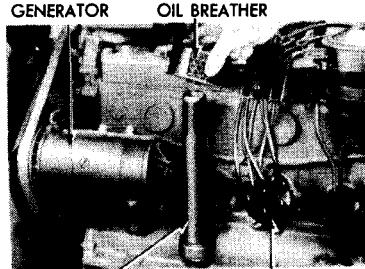

GENERATOR OIL BREATHER

OIL FILLER NECK

DISTRIBUTOR

E. CRANKCASE BREATHER

Reoil with OE every 48 hours

OIL FILLER NECK — Refill crankcase every 48 hours. Above +32° F, OE SAE 30; +32° F to 0° F, OE SAE 10; below 0° F, see OFSB 6-11

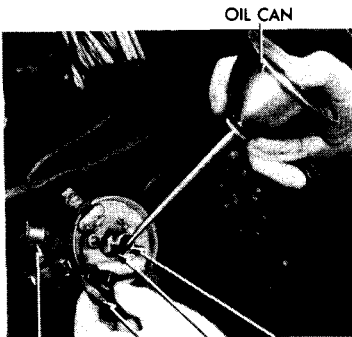

OIL CAN

DISTRIBUTOR SHAFT GREASE CUP

ROTOR

DISTRIBUTOR SHAFT WICK

DISTRIBUTOR SHAFT

C. DISTRIBUTOR SHAFT

1 Wick—2 drops OE every 48 hours
1 Grease cup—CG every 48 hours

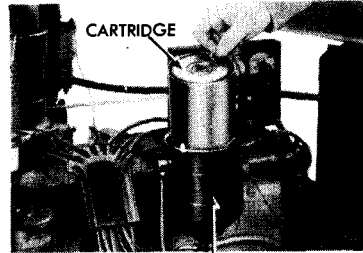

CARTRIDGE

OIL FILTER

F. OIL FILTER

Replace cartridge every 175 hours

Figure 32—Lubrication Points

VEHICULAR GENERAL PURPOSE UNIT EQUIPMENT

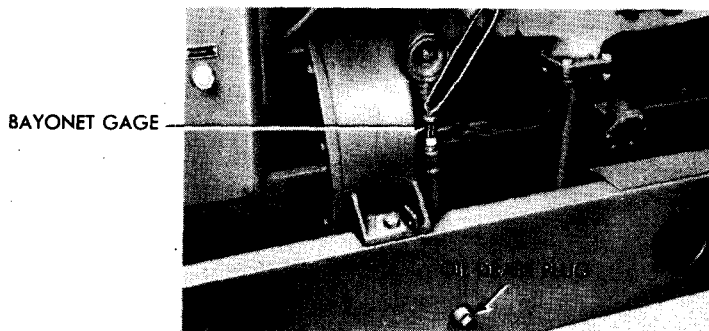

A. BAYONET GAGE—Check oil level daily
OIL DRAIN PLUG—Drain oil every 48 hours

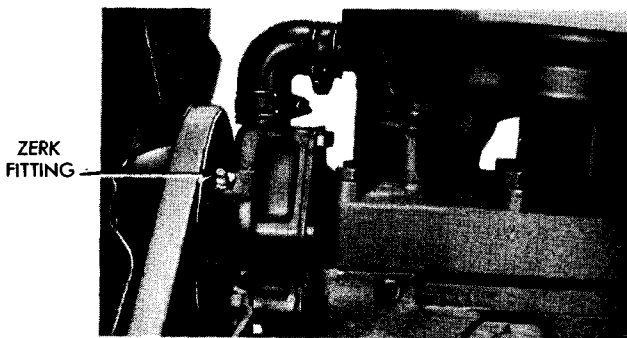

B. WATER PUMP—1 Zerk fitting
WP grease every 48 hours

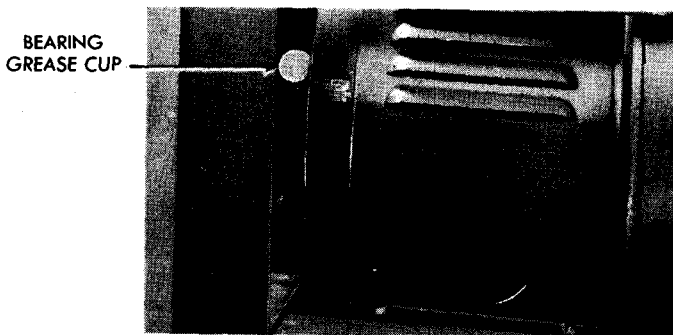

C. GENERATOR BEARING—1 Grease cup
WP grease 4 times annually

RA PD 322835

Figure 33—Lubrication Points

WELDING OUTFIT, ELECTRIC ARC—No. 17-W-1715

(1) **CLEANING.** Dry-cleaning solvent or Diesel fuel oil will be used to clean or wash all parts. Use of gasoline is prohibited. Dry all parts thoroughly before relubricating.

(2) **AIR CLEANER (OIL BATH TYPE).** Refill with used crankcase oil or OIL, engine. In temperatures ranging from 0°F to -40°F use OIL, hydraulic; below -40°F remove oil and operate dry. After every 48 hours of use, disassemble and wash all parts.

(3) **GENERATOR (A, fig. 32).** Apply six drops of OIL, engine, SAE 10, in the oil cups for the front and rear armature bearings, daily, when welder is in constant operation.

(4) **CRANKING MOTOR (B, fig. 32).** Apply six drops of OIL, engine, SAE 10, in the oil cup at front of the motor daily, when the welder is in constant operation.

(5) **DISTRIBUTOR (C, fig. 32).** Every 48 hours of operation, grease the distributor shaft through the grease cup located below the distributor head with GREASE, general purpose, No. 1, above +32°F; No. 0 from +32°F to 0°F; and No. 00 below 0°F (see OFSB 6-11). Lubricate breaker arm pivot and wick under the rotor with two drops of OIL, engine, SAE 30, above +32°F; SAE 10 from +32°F to 0°F; and OIL, lubricating, preservative, light, below 0°F.

(6) **GOVERNOR (D, fig. 32).** Check oil daily. Keep governor filled with OIL, engine, SAE 10. Two oil cups are used for filling, the cup on the side next to the belt pulley determining the oil level. Fill governor through the oil cup on top of the housing, keeping the lower cup open to provide an air vent.

(7) **CRANKCASE BREATHER (E, fig. 32).** Every 48 hours, wash breather. Reoil, after washing, with used crankcase oil or OIL, engine. From 0°F to -40°F use OIL, hydraulic. Below -40°F wash and replace dry.

(8) **OIL FILTER (F, fig. 32).** Every 48 hours, remove oil filter cartridge from housing, and clean and inspect.

(9) **CRANKCASE (E, fig. 32).** Daily, check oil level and add oil if necessary. Every 48 hours, when engine has been in constant use, drain crankcase when engine is hot and refill, using OIL, engine, SAE 30, above +32°F; OIL, engine, SAE 10, from +30°F to 0°F; and below 0°F, see OFSB 6-11. Check oil level with bayonet gage (A, fig. 33). Remove breather (E, fig. 32) to refill or add oil. Remove drain plug (A, fig. 33) to drain crankcase.

(10) **WATER PUMP (B, fig. 33).** Every 48 hours apply GREASE, water pump, through the Zerk fitting, using a grease gun.

(11) **GENERATOR BEARING (C, fig. 33).** Four times a year, grease the bearing through the grease cup, using GREASE, water pump.

VEHICULAR GENERAL PURPOSE UNIT EQUIPMENT



At fixing these things I'm a bear!"
Is the boast of Joe Dope - and
right there
He boldly attacks it
And pounds it and whacks it
Which drives Maintenance men
to despair!

*Give pieces needing repair
to Maintenance units*

Don't be a dope!
HANDLE EQUIPMENT RIGHT!

**COMPRESSOR, AIR, PORTABLE TYPE, 4 CUBIC FEET, GASOLINE
ENGINE-DRIVEN—No. 66-C-1380**

PART THREE

AIR COMPRESSORS

Section XIII

**COMPRESSOR, AIR, PORTABLE TYPE, 4 CUBIC FEET,
GASOLINE ENGINE-DRIVEN—No. 66-C-1380**

(Bendix Westinghouse, Model No. 221207)

35. DESCRIPTION.

a. This compressor is designed especially to inflate tires, and to operate a pneumatic-type grease gun. It is mounted in a carrier assembly with a single wheel to make the unit easily portable. The 4-cubic-foot, air-cooled compressor is belt-driven by a 1½-horsepower gasoline engine. The governor-controlled air pressure supplied by the unit is maintained between 105 pounds minimum and 130 pounds maximum. The tubular frame of the unit serves as the air storage reservoir. The unit is complete with hoses and fittings for tire inflation and lubrication.

36. CONTROLS AND INSTRUMENTS.

a. **Starting Pedal** (fig. 35). The starting pedal, located just above the compressor drive pulley of the engine, is operated by a quick downward push of the foot.

b. **Starting Pulley** (fig. 34). The starting pulley, which is an extension of the compressor driving pulley, is used to start the engine by a rope pull.

c. **Choke Lever** (fig. 39). The choke lever is located below the carburetor bowl on the air inlet. Pushing the lever to the right (or clockwise) chokes the engine, and to the left opens the choke.

d. **Stop Switch**. The stop switch consists of a metal strap with one end secured to the cylinder head, and the other end positioned so that it may be pressed down against the spark plug terminal, thus shorting the ignition and stopping the engine.

e. **Close-out Cock**. The close-out cock, located at the compressor end of the grease gun hose, is used to control the flow of pressure through the grease gun hose. It is open when the handle is at right angles to the line.

f. **Air Gage** (fig. 36). The air gage, located to the right of the feed valve, is used to determine the pressure of air desired in the tire inflation line.

g. **Fuel Shut-off Valve**. The fuel shut-off valve is located on the top of the fuel tank. It is opened by turning counterclockwise.

VEHICULAR GENERAL PURPOSE UNIT EQUIPMENT

RA PD 322833

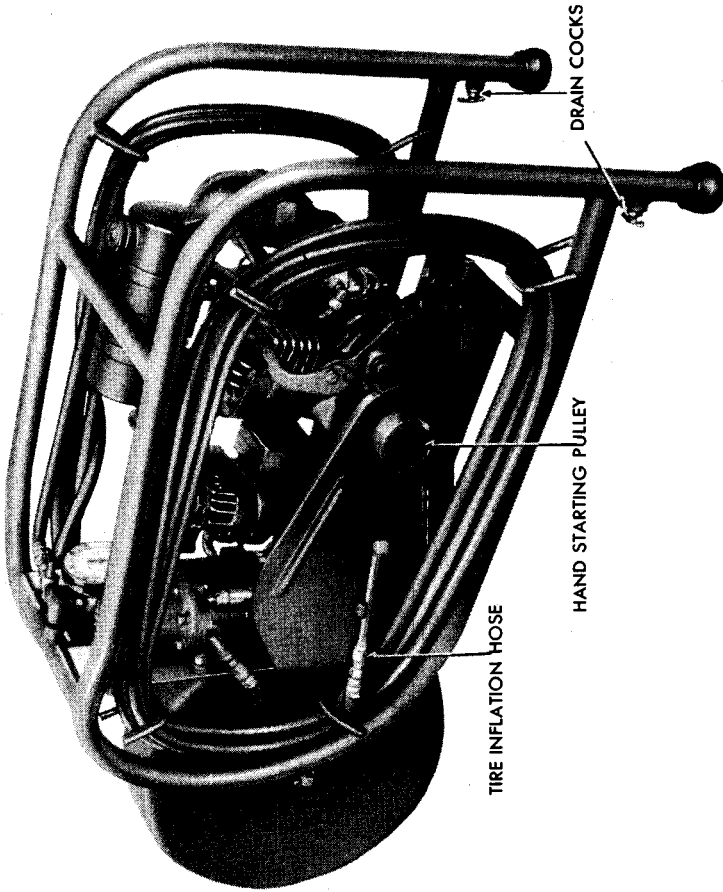
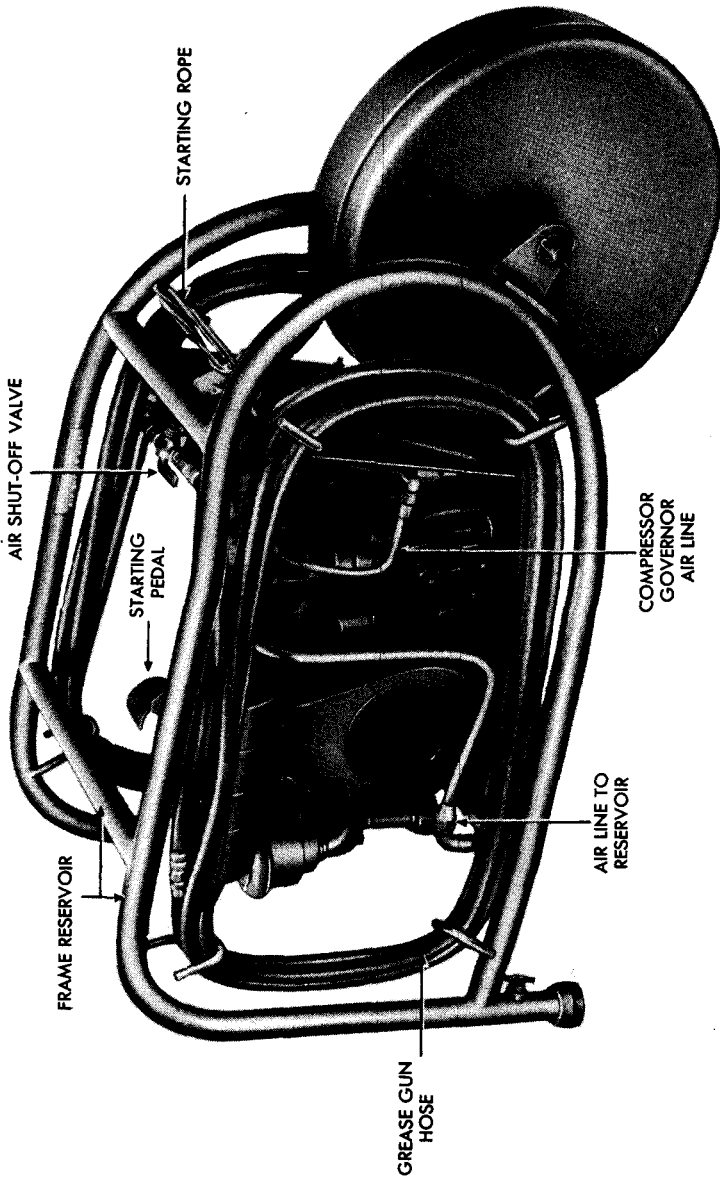

Figure 34—Air Compressor (Portable)—Left Side View

**COMPRESSOR, AIR, PORTABLE TYPE, 4 CUBIC FEET, GASOLINE
ENGINE-DRIVEN—No. 66-C-1380**



RA PD 322839

Figure 35—Air Compressor (Portable)—Right Side View

VEHICULAR GENERAL PURPOSE UNIT EQUIPMENT

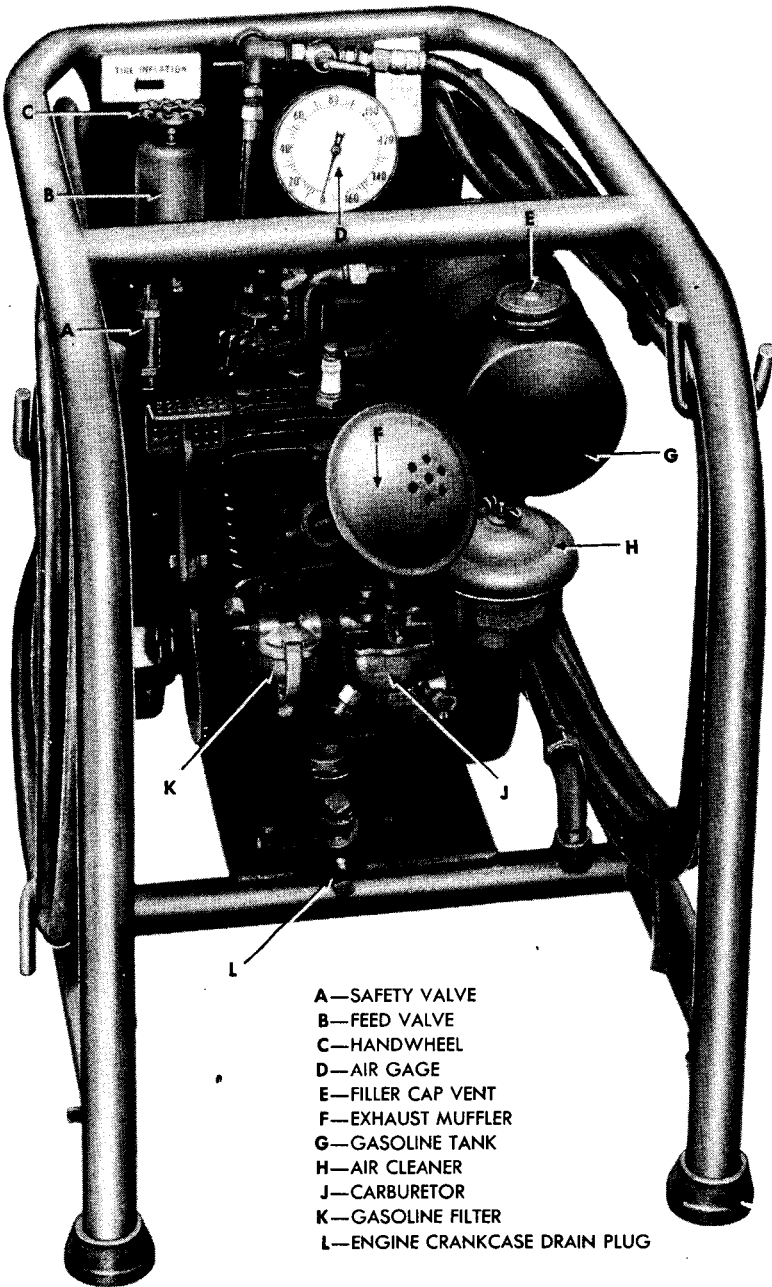

- A—SAFETY VALVE
- B—FEED VALVE
- C—HANDWHEEL
- D—AIR GAGE
- E—FILLER CAP VENT
- F—EXHAUST MUFFLER
- G—GASOLINE TANK
- H—AIR CLEANER
- J—CARBURETOR
- K—GASOLINE FILTER
- L—ENGINE CRANKCASE DRAIN PLUG

RA PD 322828

Figure 36—Air Compressor (Portable)—Rear View

**COMPRESSOR, AIR, PORTABLE TYPE, 4 CUBIC FEET, GASOLINE
ENGINE-DRIVEN—No. 66-C-1380**

37. OPERATION.

a. **Starting.** Open gasoline shut-off valve. Push the choke lever to full choke. Crank engine with rope starter by winding rope clockwise around pulley (with knot in the pulley notch at start of winding) and pulling rope with a quick steady pull; or crank engine with foot pedal starter by stepping down on starter pedal quickly. Open choke halfway, and if engine has not already started, crank engine again until it starts. As soon as engine warms up to the point where it is running smoothly, open choke all the way (counterclockwise).

b. **Stopping.** Press the stop switch strap against the spark plug terminal. Hold it there until motor stops firing. Close gasoline shut-off valve.

c. **Tire Inflation.** With engine running, close cut-out cock in grease gun line. Set feed valve so that desired pressure registers on air gage (fig. 38). Place tire inflation fitting against the tire valve and hold until the air gage returns to the desired pressure.

d. **Grease Gun Supply.** With motor running, attach grease gun hose to grease gun, and open cut-out cock in supply line. *NOTE: Pressure in grease gun line is governor-controlled at between 105 and 130 pounds. If in emergency grease gun line is also used to inflate tires, great care will have to be taken to avoid overinflation of tires.*

38. LUBRICATION.

a. These lubrication instructions are specified for normal operating conditions. Reduce intervals and lubricate more often under extreme heat or dust conditions and exposure to excessive amounts of moisture, any one of which may quickly destroy the protective qualities of the lubricants and require servicing to prevent malfunctioning or damage to materiel.

(1) **COMPRESSOR CRANKCASE** (fig. 37). Daily, check oil level and add oil if necessary. Every 48 hours of operation, drain crankcase and refill with OIL, engine, SAE 30, above +32°F; OIL, engine, SAE 10, from +30°F to 0°F; and below 0°F, see OFSB 6-11.

(2) **ENGINE CRANKCASE** (fig. 36). Every five hours of operation, check oil level and add oil if necessary. Daily, drain oil from crankcase and refill with OIL, engine, SAE 30, above +32°F; OIL, engine, SAE 10, from +32°F to 0°F; and below 0°F, see OFSB 6-11.

(3) **COMPRESSOR AIR STRAINER** (fig. 37). Every 48 hours, remove curled hair and wash with dry-cleaning solvent or Diesel oil. Recoil, after washing, with used crankcase oil or OIL, engine. From 0°F to -40°F use OIL, hydraulic; below -40°F, wash and replace dry.

(4) **ENGINE AIR CLEANER** (fig. 39). Daily, check oil level. Every 24 hours of operation, refill with used crankcase oil or OIL, engine.

VEHICULAR GENERAL PURPOSE UNIT EQUIPMENT

AIR STRAINER

COMPRESSOR GOVERNOR

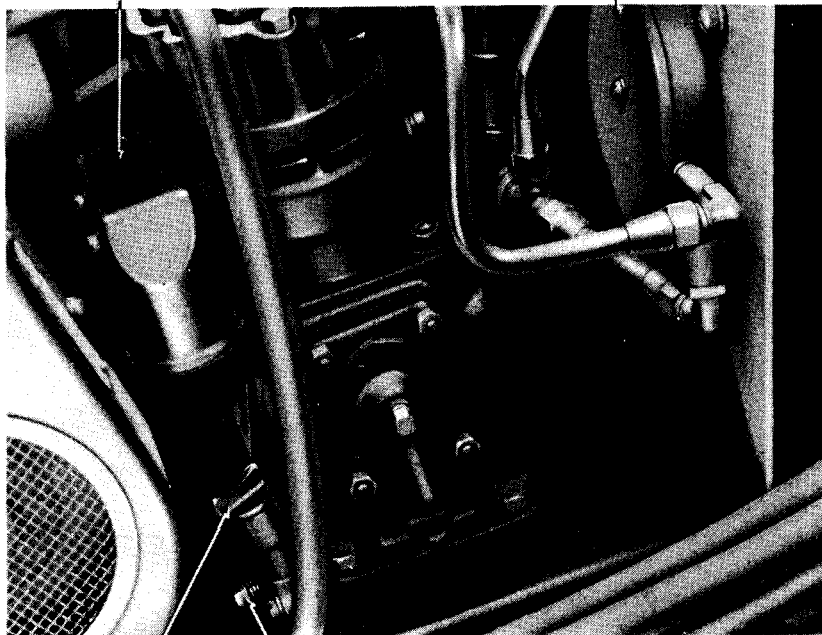

OIL FILLER NECK

OIL DRAIN

RA PD 322832

Figure 37—Lubrication Points

HANDWHEEL

AIR SHUT OFF VALVE

UNLOADER VALVE
ROCKER ARM

AIR GAGE

FEED
VALVE

ADJUSTING
NUT

SAFETY VALVE

RA PD 322840

Figure 38—Air Unloader, Air Adjusting Points, and Gage

**COMPRESSOR, AIR, PORTABLE TYPE, 4 CUBIC FEET, GASOLINE
ENGINE-DRIVEN—No. 66-C-1380**

From 0°F to -40°F use OIL, hydraulic; below -40°F remove oil and operate dry. Every 48 hours, disassemble and wash all parts with dry-cleaning solvent or Diesel oil.

39. SERVICING.

a. **Unloading Valve Clearance** (fig. 38). After each 100 hours of operation, check clearance between unloading valves and unloading valve rocker arm adjusting screws. Adjust clearance to 0.010-inch minimum, 0.015-inch maximum.

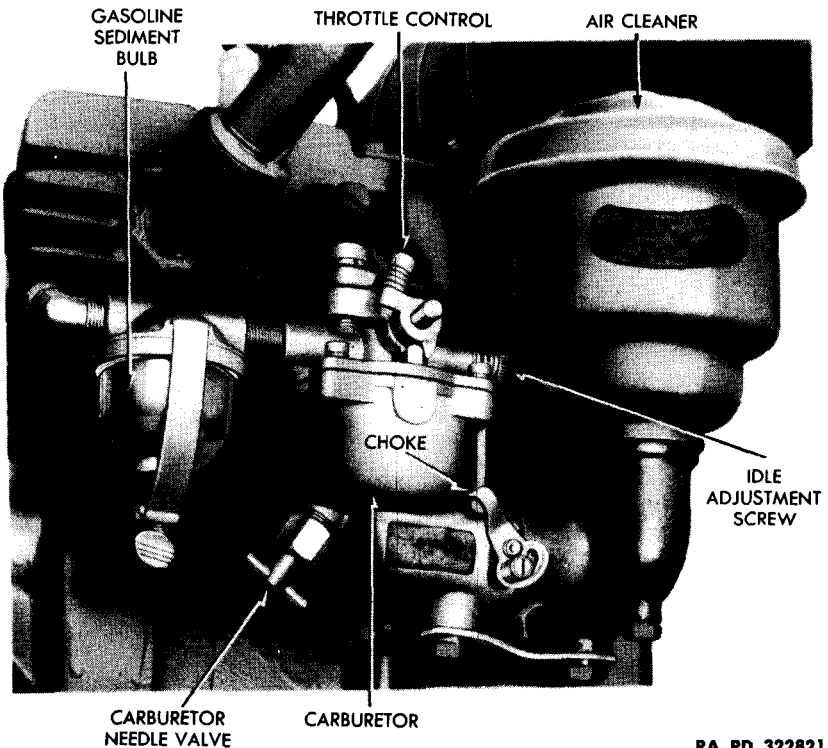

RA PD 322821

Figure 39—Carburetor

b. **Belt Tension.** Compressor drive belt tension should be such that there is 1/2-inch deflection when a pressure of about 10 pounds is applied to belt midway between pulleys. Adjust tension by loosening compressor mounting bolts and moving compressor in direction to correct deflection. Tighten mounting bolts.

c. **Compressor Governor Adjustments.** The compressor governor is set to cut out at 125 to 130 pounds, and to cut in at 105 to 115 pounds.

VEHICULAR GENERAL PURPOSE UNIT EQUIPMENT

(1) To raise pressure settings, remove cover from governor, loosen the adjusting screw lock nut, and turn adjusting screw in clockwise direction. Tighten adjusting screw lock nut.

(2) To lower pressure settings, use same procedure as in raising pressure settings, except to turn adjusting screw in counterclockwise direction.

(3) To increase range between cut-out and cut-in pressures, remove one or more shims from beneath the upper valve guide. To decrease range, install shims.

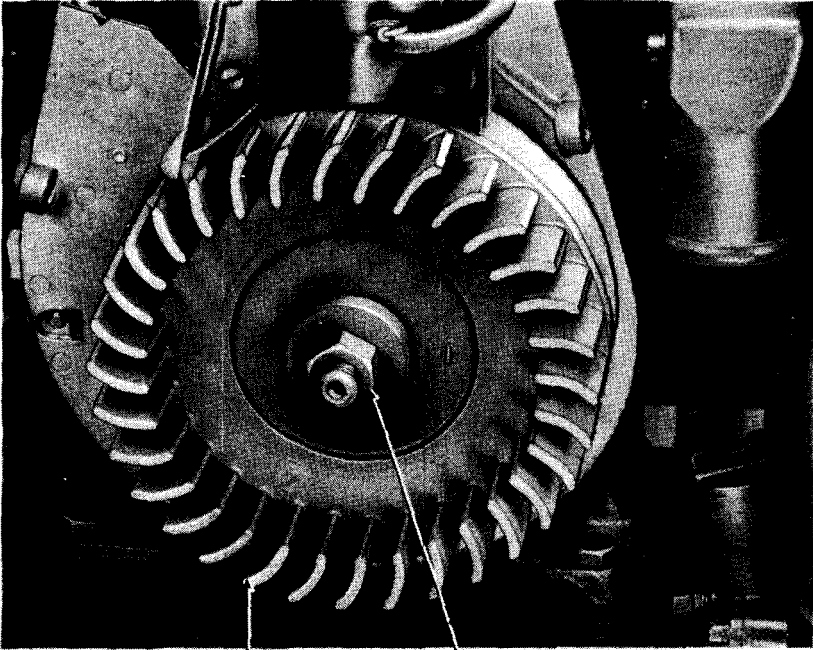

FLYWHEEL

CRANKSHAFT LOCK NUT

RA PD 322836

Figure 40—Flywheel Ready for Removal

d. **Safety Valve.** The safety valve is set to discharge at 175-pounds pressure. To adjust, loosen adjusting screw lock nut and turn adjusting screw clockwise to raise, or counterclockwise to lower the pressure. Tighten lock nut as soon as correct adjustment is reached.

e. **Carburetor Adjustments (fig. 39).**

(1) **NEEDLE VALVE.** Without engine running, turn fuel supply needle valve clockwise until it just seats. Open the needle valve by turning counterclockwise $\frac{1}{2}$ to $\frac{3}{4}$ of a turn. Start engine, and with engine warmed up to point where no choking is required, adjust needle valve further to the point where engine runs smoothly.

**COMPRESSOR, AIR, PORTABLE TYPE, 4 CUBIC FEET, GASOLINE
ENGINE-DRIVEN—No. 66-C-1380**

(2) **IDLE ADJUSTING SCREW.** Idle adjusting screw should be adjusted to the point at which the engine idles most smoothly. This is normally $\frac{1}{2}$ to $\frac{3}{4}$ of a turn open.

f. **Engine Speed Governor.** Normal engine speed is 3300 revolutions per minute. If it becomes necessary to correct governor setting, turn the speed adjusting thumb nut clockwise to decrease speed, and counterclockwise to increase speed.

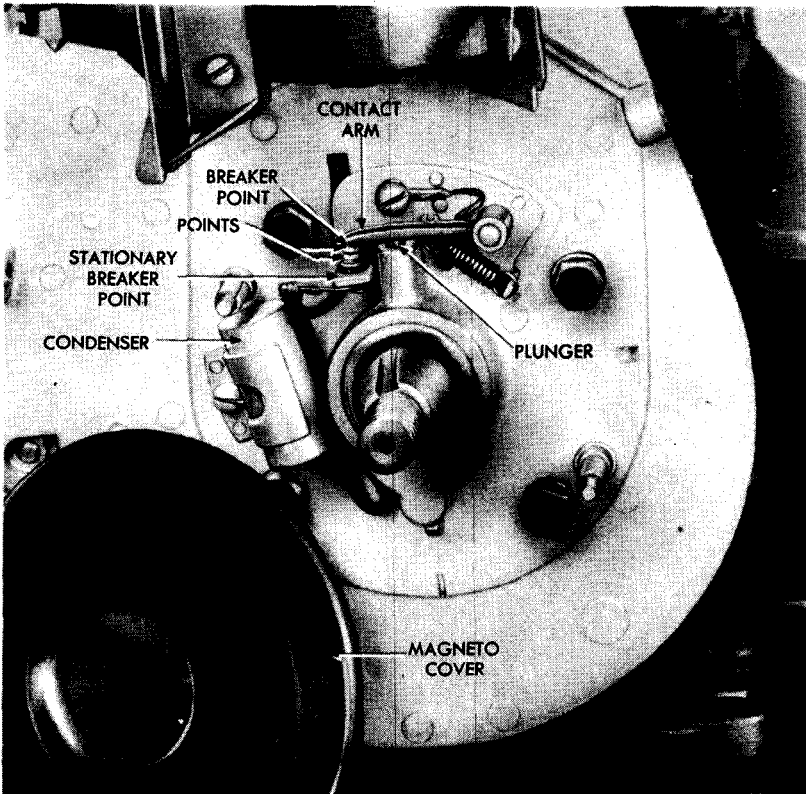

RA PD 322822

Figure 41—Magneto Adjustment Points

g. **Spark Plug.** Spark plug must be kept clean, and gap adjusted to 0.025 inch.

h. **Magneto Adjustment (figs. 40 and 41).** Remove the flywheel housing. Remove crankshaft lock nut, which holds the flywheel, turning nut to the left. Place a brass drift against the center of the crankshaft and hit a sharp blow with a mallet. Lift the flywheel from the crankshaft. Clean the stationary and movable breaker points, and adjust gap to 0.020 inch. Replace flywheel, crankshaft nut and flywheel cover.

VEHICULAR GENERAL PURPOSE UNIT EQUIPMENT

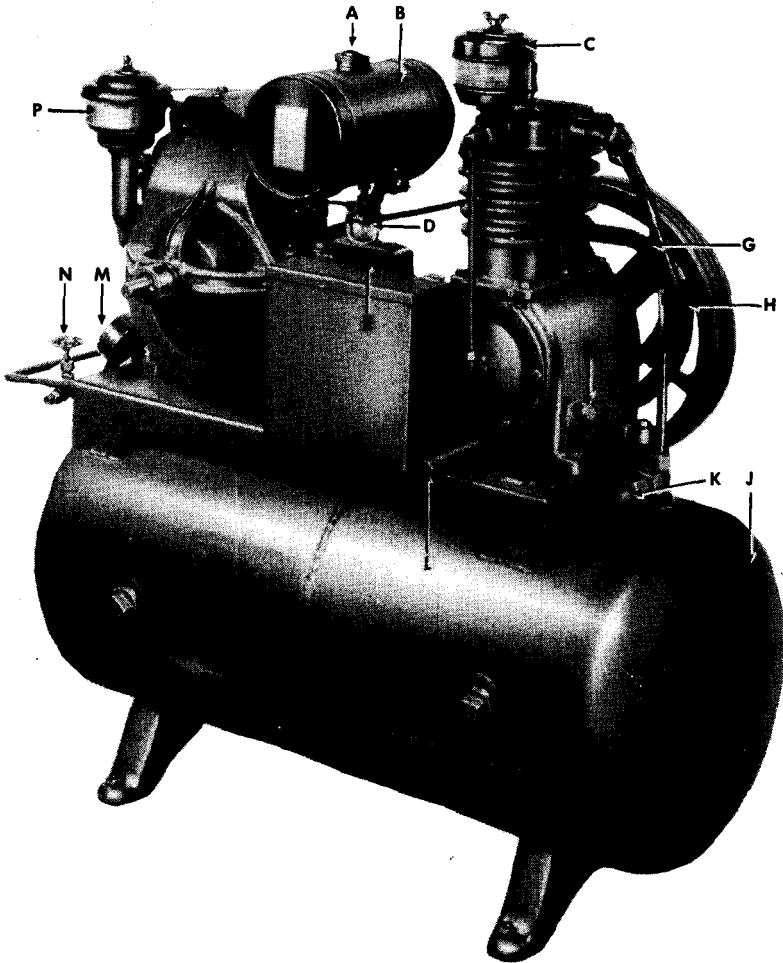

- A—FILLER CAP VENT
- B—GAS TANK
- C—COMPRESSOR AIR CLEANER
- D—GASOLINE SEDIMENT BOWL
- E—AUTOMATIC SWITCH
- F—COMPRESSOR OIL FILLER
- G—AFTERCOOLER

- H—INTERCOOLER
- J—AIR STORAGE TANK
- K—UNLOADER
- L—COMPRESSOR DRAIN PLUG
- M—AIR PRESSURE GAGE
- N—SHUT-OFF VALVE
- P—ENGINE AIR CLEANER

RA PD 322804

Figure 42—Air Compressor—Front View

**COMPRESSOR, AIR, PORTABLE, 6 CUBIC FEET, GASOLINE
ENGINE-DRIVEN—No. 66-C-1370**

Section XIV

**COMPRESSOR, AIR, PORTABLE, 6 CUBIC FEET,
GASOLINE ENGINE-DRIVEN—No. 66-C-1370**

(Kellogg, American Brake Shoe, Model No. GE320)

40. DESCRIPTION (figs. 42 and 43).

a. This compressor is designed to inflate tires. It is mounted on four legs welded to the air tank which supports the engine and compressor. The 6-cubic-foot, air-cooled compressor is belt-driven by a 1½-horsepower gasoline engine. Air pressure supplied by the unit is maintained at 175 pounds, and is controlled by an automatic switch. The unit is complete with hoses and fittings for tire inflation.

41. CONTROLS AND INSTRUMENTS.

a. **Starting Crank.** The starting crank is used by placing the crank into the pins on the crankshaft (fig. 42) located on the front of the engine, pressing in, and cranking the engine manually.

b. **Choke Lever (fig. 45).** The choke lever is located below the carburetor bowl on the air inlet. By turning lever clockwise, the engine is choked; turning counterclockwise, the choke opens.

c. **Stop Switch.** The stop switch is a metal strap, one end of which is mounted on the cylinder head, the other end positioned so that pressure, applied to the strap against the spark plug terminal, shorts the ignition and stops the engine.

d. **Air Gage (fig. 42).** The air gage is located between the two feed valves, and determines pressure of air desired in tire inflation lines.

e. **Fuel Shut-off Valve.** The fuel shut-off valve is located in the gasoline filter. It is opened by turning the valve lever counterclockwise.

42. OPERATION.

a. **Starting.** Open the fuel shut-off valve and push the choke lever clockwise to full choke (fig. 45). Place the starting crank over the crankshaft pins, and press the starter shaft into mesh with gear on crankshaft. Crank rapidly to prime and start engine. When engine starts, gradually open the choke valve counterclockwise until engine runs smoothly. Open choke fully when engine has warmed up.

b. **Stopping Engine.** Press stop strap switch against spark plug terminal; hold until engine stops firing. Close gasoline shut-off valve.

c. **Tire Inflation.** Set the air shut-off valve so that the desired pressure registers on the air gage. Place the tire inflation fitting against the tire valve, and hold until the air gage returns to the set pressure.

VEHICULAR GENERAL PURPOSE UNIT EQUIPMENT

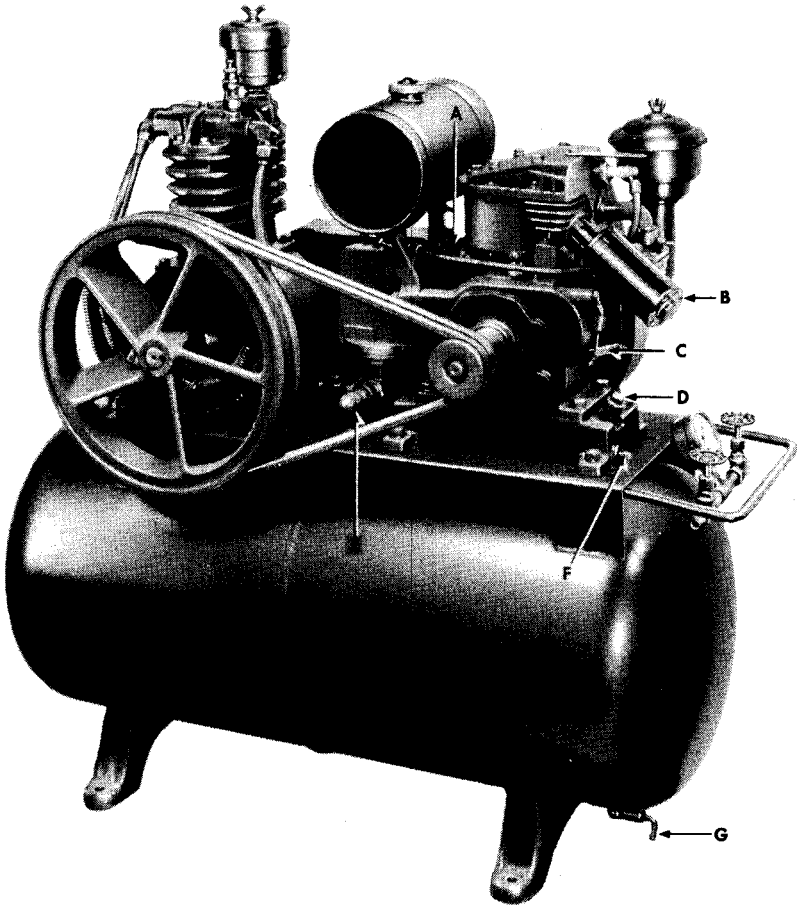

- A—ENGINE CRANKCASE BREATHER
- B—EXHAUST MUFFLER
- C—GOVERNOR LEVER
- D—ENGINE OIL FILLER
- E—SAFETY VALVE
- F—ENGINE OIL DRAIN PLUG
- G—AIR TANK DRAIN VALVE

RA PD 322824

Figure 43—Air Compressor—Rear View

COMPRESSOR, AIR, PORTABLE, 6 CUBIC FEET, GASOLINE ENGINE-DRIVEN—No. 66-C-1370

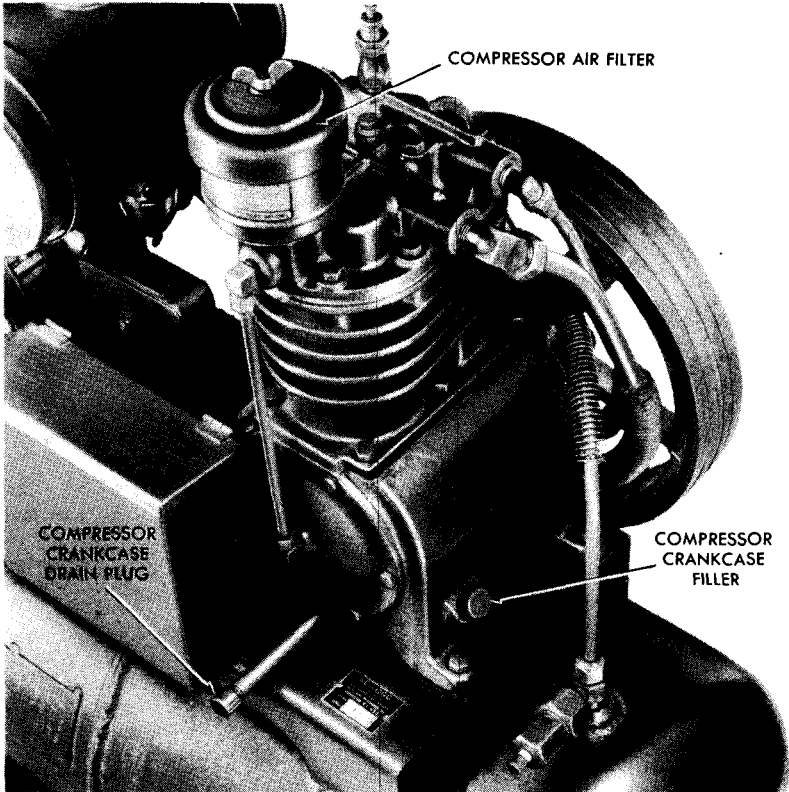

A. CRANKCASE—Check oil level daily. Refill every 48 hours, OE SAE 30 above +32° F., OE SAE 10 +32° F. to 0° F., and below 0° F., see OFSB 6-11. COMPRESSOR AIR FILTER—Check oil level daily. Empty weekly and refill with used crankcase oil or OE from 0° F. to -40° F. OH Below -40° F.

STARTER SPRING OIL CUP



B. STARTER SPRING—Oil every 3 months. One oil cup. 8 drops OE SAE 30.

RA PD 322823

Figure 44—Lubrication Points

VEHICULAR GENERAL PURPOSE UNIT EQUIPMENT

43. LUBRICATION.

a. These lubrication instructions are specified for normal operating conditions. Reduce intervals of lubrication under extreme heat or dust conditions and exposure to excessive moisture, any of which may quickly destroy the protective qualities of the lubricants and require servicing to prevent damage to and malfunctioning of the materiel.

(1) **COMPRESSOR CRANKCASE** (fig. 42). Daily, check oil level and add oil if necessary. Every 48 hours of operation, drain crankcase and refill with OIL, engine, SAE 30, above +32°F; OIL, engine, SAE 10, from +32°F to 0°F; and below 0°F, see OFSB 6-11.

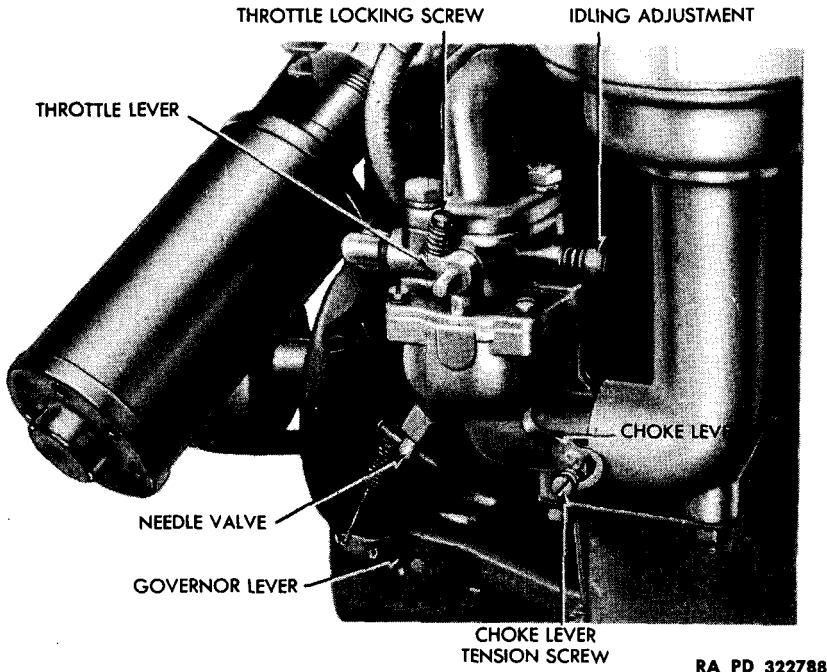

RA PD 322788

Figure 45—Carburetor Adjustments

(2) **ENGINE CRANKCASE** (A, fig. 44). Every 5 hours of operation, check oil level and add oil if necessary. Every 48 hours of operation, drain oil from crankcase and refill with OIL, engine, SAE 30, above +32°F; OIL, engine, SAE 10, from +32°F to 0°F; and below 0°F, see OFSB 6-11.

(3) **ENGINE AIR CLEANER** (fig. 42). Daily, check oil level. Every 24 hours of operation, refill with used crankcase oil or OIL, engine. From 0°F to -40°F, use OIL, hydraulic. Below -40°F, remove oil and operate dry. Every 48 hours, disassemble and wash all parts with SOLVENT, dry-cleaning, or OIL, Diesel.

COMPRESSOR, AIR, PORTABLE, 6 CUBIC FEET, GASOLINE ENGINE-DRIVEN—No. 66-C-1370

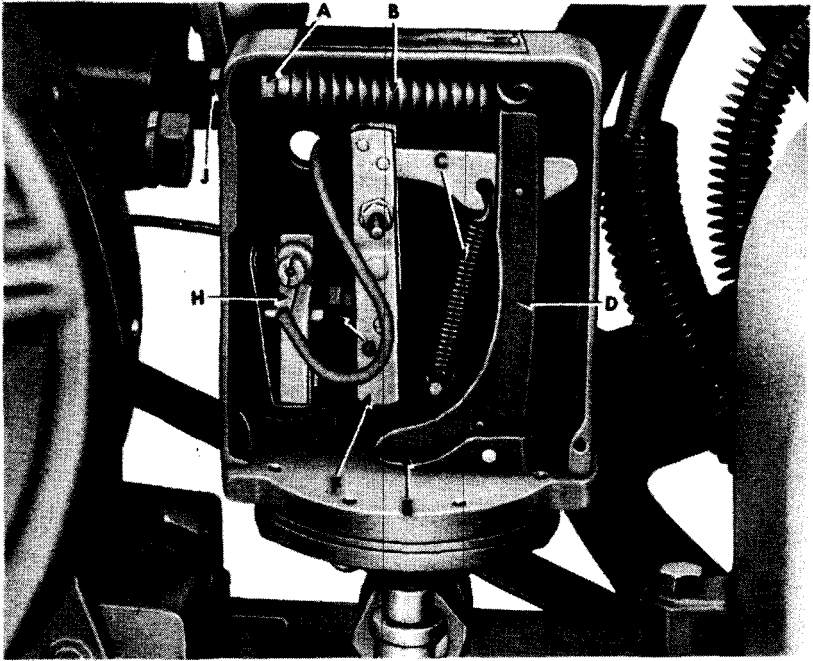

- A—SWITCH ADJUSTMENT LOCKING NUT
- B—TENSION SPRING
- C—TRIP SPRING
- D—MAIN LEVER ARM
- E—AIR PLUNGER
- F—TRIP LEVER
- G—MOVING CONTACT ASSEMBLY
- H—STATIONARY CONTACT ASSEMBLY
- J—SWITCH ADJUSTMENT SCREW

RA PD 322829

Figure 46—Automatic Switch Adjustment

(4) **COMPRESSOR AIR FILTER (A, fig. 44)**. Daily, check oil level. Every 24 hours of operation, refill with used crankcase oil or OIL, engine. From 0°F to -40°F, use OIL, hydraulic. Below -40°F, remove oil and operate dry. Every 48 hours, disassemble and wash all parts with SOLVENT, dry-cleaning, or OIL, Diesel.

(5) **CRANKCASE BREATHER (fig. 43)**. Every 48 hours, wash breather with SOLVENT, dry-cleaning, or OIL, Diesel. Recoil after washing with used crankcase oil or OIL, engine. From 0°F to -40°F, use OIL, hydraulic. Below -40°F, wash and replace dry.

(6) **ENGINE OIL FILTER**. Every 48 hours, remove filter element from housing. Clean and inspect.

(7) **FLYWHEEL OIL CUP (B, fig. 44)**. Every month, apply 8 drops of OIL, engine.

VEHICULAR GENERAL PURPOSE UNIT EQUIPMENT

44. SERVICING.

a. **Carburetor** (fig. 45). To adjust carburetor, close the needle valve by turning clockwise as far as possible. From the closed position, open needle valve from 1 to 1¼ turns. Start engine and warm up. With the choke wide open, turn the needle valve counterclockwise to the point at which the engine operates most smoothly. Adjust idling speed by turning idler adjusting screw (fig. 45) clockwise for reducing speed, and counterclockwise for increasing idling speed of engine.

b. **Governor**. NOTE: *Adjust the governor only if absolutely necessary.* Adjustment is made by hooking the throttle spring hooked to

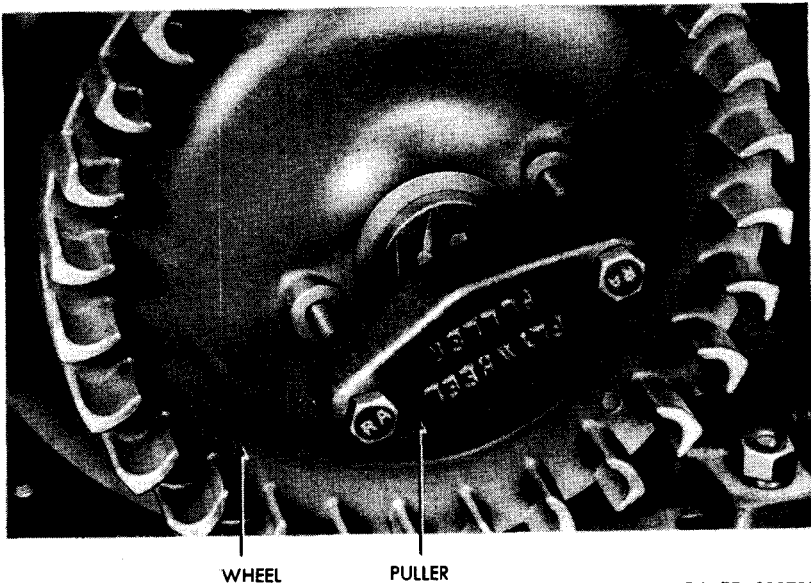

Figure 47—Wheel Puller Installed

the governor lever in one or two positions. For speeds of 2500 revolutions per minute or under, hook the spring in the cotter pin marked "LOW SPEED." For speeds over 2500 revolutions per minute, hook the spring in cotter pin marked "HIGH SPEED."

c. **Governor Lever** (fig. 45). With the carburetor hooked up to the governor lever and throttle link, loosen the screw holding the governor lever on the shaft and push lever forward as far as it will go. Hold in this position and turn governor shaft to the right (using pliers) until it strikes the stop in the crankcase. Tighten the screw which holds the lever to shaft until lever is snug. Push governor lever to the right as far as it will go, and tighten screw securely.

COMPRESSOR, AIR, PORTABLE, GASOLINE ENGINE-DRIVEN, 5 HORSEPOWER, 16 CUBIC FEET CAPACITY, WITH TANK AND HOSE—No. 66-C-1175

d. **Automatic Switch** (fig. 46). The automatic switch is adjustable only when the pressure gage is of known accuracy. If the gage is correct, the pressure can be raised or lowered by tightening or loosening the adjusting nut (fig. 46) at the end of the top tension spring.

e. **Magneto**. Remove the flywheel housing. Remove the pinion gear nut which holds the flywheel. Using an open-end wrench and tapping lightly with a mallet, remove the nut and install the puller (fig. 47) (provided with compressor) and pull the flywheel. The magneto is now exposed. To adjust the contact points, turn the crankshaft by hand, and note if points open and close properly. Close contact points and line up squarely by loosening the contact spring bolt. Move the contact spring assembly to line up with contact screw point and tighten bolt. To adjust contact spring tension, turn crankshaft until points are in open position, and place a $\frac{3}{16}$ -inch gage between contact spring and end of block. Tighten screws. Turn the contact screw to secure, and adjust to 0.020-inch gap. Tighten lock nut.

Section XV

COMPRESSOR, AIR, PORTABLE, GASOLINE ENGINE-DRIVEN, 5 HORSEPOWER, 16 CUBIC FEET CAPACITY, WITH TANK AND HOSE—No. 66-C-1175

(Curtis Mfg. Co., Model No. VG-959 QMC)

45. DESCRIPTION (figs. 48 and 49).

a. This is a general purpose compressor designed for tire inflation, and the operation of small pneumatic tools such as grease guns and paint spray guns. The compressor and driving engine are mounted on the air storage tank. At 610 revolutions per minute the compressor delivers 12 cubic feet of air per minute at 200-pound pressure. It is air-cooled and belt-driven by a single-cylinder, four-cycle gasoline engine of 5.25 horsepower at 2200 revolutions per minute. The air storage tank is equipped with multiple outlets to allow for the operation of more than one tool. The compressor is complete with hose and air fittings.

46. CONTROLS AND INSTRUMENTS.

a. **Starting Crank** (fig. 48). The starting crank, located on the flywheel housing on the right front side of the unit, engages the crankshaft starting gear nut when pushed in slightly, and disengages automatically when the engine starts.

b. **Stop Switch**. The stop switch is a strip of metal mounted on the intake elbow, in position with the spark plug terminal. When the free

VEHICULAR GENERAL PURPOSE UNIT EQUIPMENT

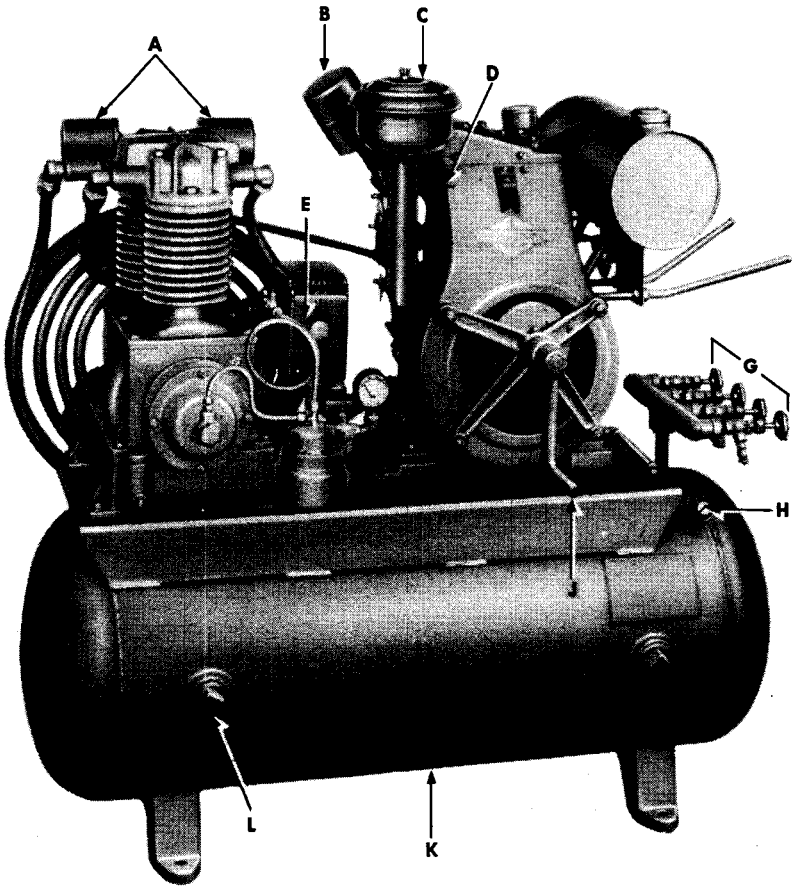

- A—COMPRESSOR AIR FILTER
- B—EXHAUST
- C—ENGINE AIR FILTER
- D—COMPRESSION RELEASE ROD
- E—UNLOADER ADJUSTMENT
- F—AIR PRESSURE GAGE
- G—AIR DELIVERY VALVES
- H—SAFETY VALVE
- J—STARTING CRANK HANDLE
- K—AIR STORAGE TANK
- L—DRAIN VALVE

RA PD 322837

Figure 48—Air Compressor—Front View

COMPRESSOR, AIR, PORTABLE, GASOLINE ENGINE-DRIVEN, 5 HORSEPOWER, 16 CUBIC FEET CAPACITY, WITH TANK AND HOSE—No. 66-C-1175

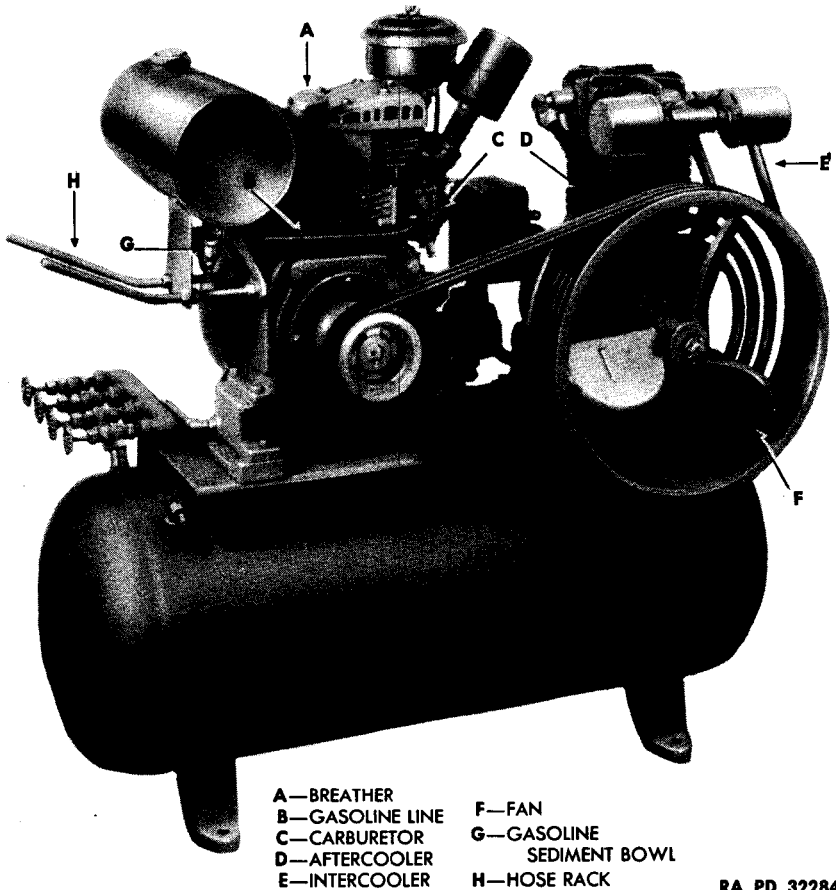

RA PD 322843

Figure 49—Air Compressor—Rear View

end is pressed against the end of the spark plug, it grounds the ignition system and stops the engine.

c. **Choke Lever** (fig. 50). The choke lever is mounted on the side of the carburetor housing immediately back of the air intake. It is hand-operated, and controls choking of the engine by moving in a clockwise direction.

d. **Throttle Lever** (fig. 50). The throttle lever is located above the bowl of the carburetor housing. It is adjustable by turning the throttle lever adjustment screw which moves the lever away from carburetor boss on control lever base to idle engine, and returning the lever to the boss to operate the engine on governed speed.

VEHICULAR GENERAL PURPOSE UNIT EQUIPMENT

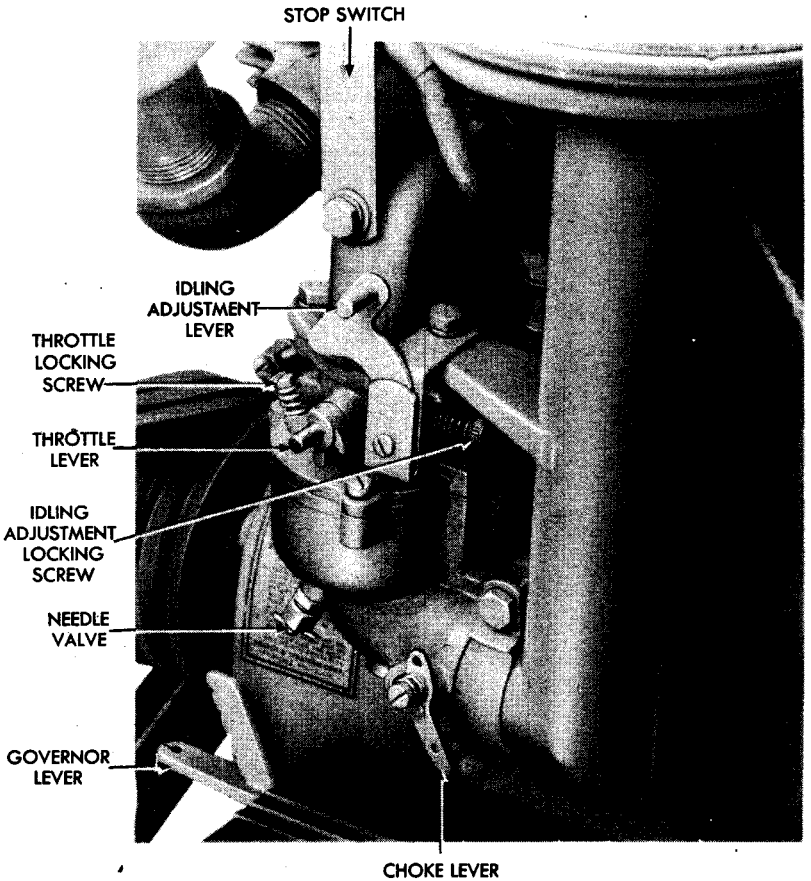

RA PD 322795

Figure 50—Carburetor Controls and Adjustment

e. **Governor Control Lever** (fig. 50). The governor control lever is mounted on the left side of the engine crankcase at the rear. It is adjustable by turning the adjustment nut clockwise to increase, and counterclockwise to decrease the engine speed.

f. **Air Gage** (fig. 48). This gage is mounted on the air pressure unloader in the air line at the front center of the unit, and registers the air pressure in the storage tank.

47. OPERATION.

a. **Starting.** Open gasoline shut-off valve in gas filter or gasoline tank. Close carburetor choke valve completely by turning choke lever (fig. 50), in a clockwise direction. Pull out the compression release rod as far as it will come. Press starter shaft into mesh gear with pinion on

**COMPRESSOR, AIR, PORTABLE, GASOLINE ENGINE-DRIVEN, 5
HORSEPOWER, 16 CUBIC FEET CAPACITY, WITH TANK
AND HOSE—No. 66-C-1175**

crankshaft. Crank rapidly, and as soon as enough momentum is gained, release the compression release rod. After motor starts, gradually open the choke valve by moving the choke lever in a counterclockwise direction until motor runs smoothly with choke valve wide open. (A warm motor does not require as much choking as a cold motor.)

b. Stopping. Press the stop strap against the spark plug terminal and hold down until engine has stopped firing. Release the stop strap and close gasoline shut-off valve.

48. LUBRICATION.

a. These lubrication instructions are specified for normal operating conditions. Reduce intervals and lubricate more often under extreme heat or dust conditions, or exposure to excessive amounts of moisture. Any of these may quickly destroy the protective qualities of the lubricants and necessitate servicing to prevent malfunctioning or damage to the equipment.

(1) **COMPRESSOR CRANKCASE** (A, fig. 51.) Daily, check oil level and add oil if necessary. Every 48 hours, when compressor has been in constant use, drain crankcase while compressor is hot and refill, using OIL, engine, SAE 30, above +32°F; OIL, engine, SAE 10, from +32°F to 0°F; and below 0°F, see OFSB 6-11. Remove drain plug (A, fig. 51) to drain crankcase.

(2) **ENGINE CRANKCASE** (B, fig. 51). Daily, check oil level and add oil if necessary. Every 48 hours, when engine has been in constant use, drain crankcase while engine is hot and refill using OIL, engine, SAE 30, above +32°F; OIL, engine, SAE 10, from +32°F to 0°F; and below 0°F, see OFSB 6-11. Remove breather to add or refill with oil. Remove drain plugs to drain crankcase (B and C, fig. 51).

(3) **COMPRESSOR AIR FILTER** (fig. 48). Refill with used crankcase oil or OIL, engine. In temperatures ranging from 0°F to -40°F, use OIL, hydraulic; below -40°F, remove oil and operate dry. After every 48 hours of use, disassemble and wash all parts.

(4) **ENGINE AIR FILTER** (fig. 48). Refill with used crankcase oil or OIL, engine. In temperatures ranging from 0°F to -40°F, use OIL, hydraulic; below -40°F, remove oil and operate dry. After every 48 hours of use, disassemble and wash all parts.

(5) **CRANKCASE BREATHER** (fig. 49). Every 48 hours wash breather. Reoil after washing with used crankcase oil or OIL, engine. From 0°F to -40°F, use OIL, hydraulic. Below -40°F, wash and replace dry.

(6) **CRANKSHAFT OIL CUP.** Every month, apply 8 drops of OIL, engine, with an oilcan.

VEHICULAR GENERAL PURPOSE UNIT EQUIPMENT

COMPRESSOR OIL FILLER

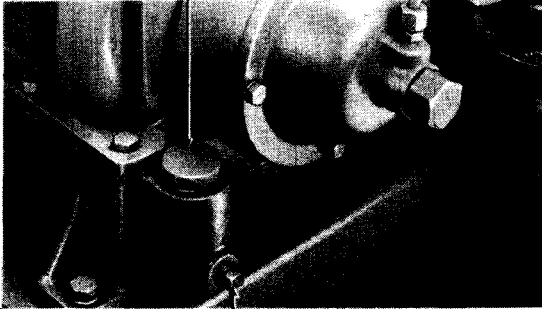

COMPRESSOR OIL DRAIN PLUG
A. COMPRESSOR CRANKCASE

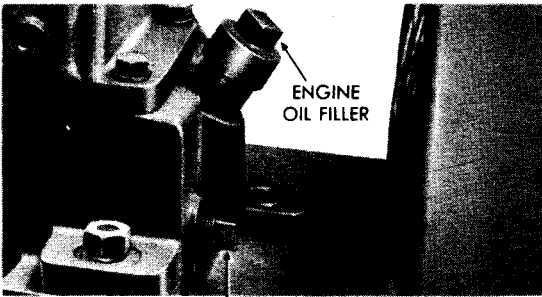

ENGINE OIL DRAIN PLUG
B. ENGINE CRANKCASE
CRANKSHAFT OIL CUP

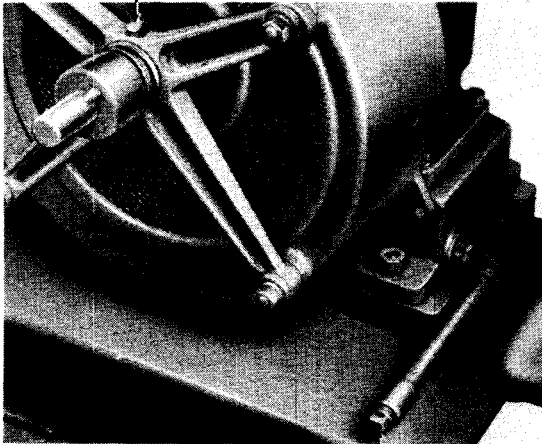

CRANKCASE OIL DRAIN PLUG
C. ENGINE CRANKCASE

RA PD 322842

Figure 51—Lubrication Points

**COMPRESSOR, AIR, PORTABLE, GASOLINE ENGINE-DRIVEN, 5
HORSEPOWER, 16 CUBIC FEET CAPACITY, WITH TANK
AND HOSE—No. 66-C-1175**

UNLOADER REGULATOR
ADJUSTING SCREW

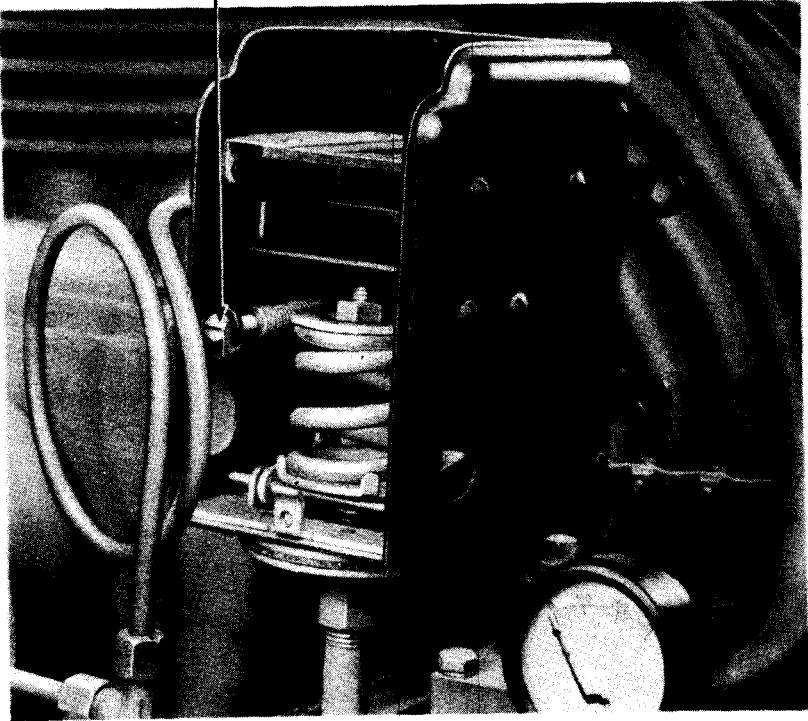

RA PD 322807

Figure 52—Automatic Switch

49. SERVICING.

a. **Carburetor** (fig. 50). The carburetor on this engine is of the gravity type. The gasoline supply is regulated by a needle valve (fig. 50). The throttle (fig. 50) is automatically controlled by the governor (fig. 50). To adjust the carburetor, close the needle valve completely by turning to the right, or clockwise, as far as possible. Do not screw up too tightly, or use force when closing needle valve, as needle valve may thus be damaged. From closed position, open needle valve 1 to 1¼ turns. After the engine has been started and warmed up, make final adjustment with the choke (fig. 50) wide open by turning the needle valve to the point at which motor operates most smoothly with full load. This setting will also take care of starting with use of the choke. When starting cold motor, if it is necessary to keep choke partially closed several minutes before engine runs smoothly, carburetor setting is too lean,

VEHICULAR GENERAL PURPOSE UNIT EQUIPMENT



FLYWHEEL

RA PD 322794

Figure 53—Flywheel Puller

and needle valve should be opened a notch or two (counterclockwise). The idling adjustment screw setting is about $\frac{1}{2}$ to $\frac{3}{4}$ of a turn open. Do not force screw against seat or damage to both will result.

b. **Governor** (fig. 50). The speed of the engine is automatically maintained under varying loads by a centrifugal governor. It is operated from the cam gear. The governor was carefully adjusted at the factory to maintain normal speed under load. Do not readjust unless absolutely necessary. It can be adjusted by reducing or increasing the tension of the governor spring. Turn governor nut to the right, or clock-

COMPRESSOR, AIR, PORTABLE, GASOLINE ENGINE-DRIVEN, 5 HORSEPOWER, 16 CUBIC FEET CAPACITY, WITH TANK AND HOSE—No. 66-C-1175

wise, to increase engine speed. Recommended engine speed is 2200 to 3200 revolutions per minute.

c. **Automatic Switch (fig. 52).** The automatic switch must be adjusted only when the pressure gage is of known accuracy. If the gage is correct, the pressure can be raised or lowered by tightening or loosening the adjusting nut at the end of the tension spring (fig. 52).

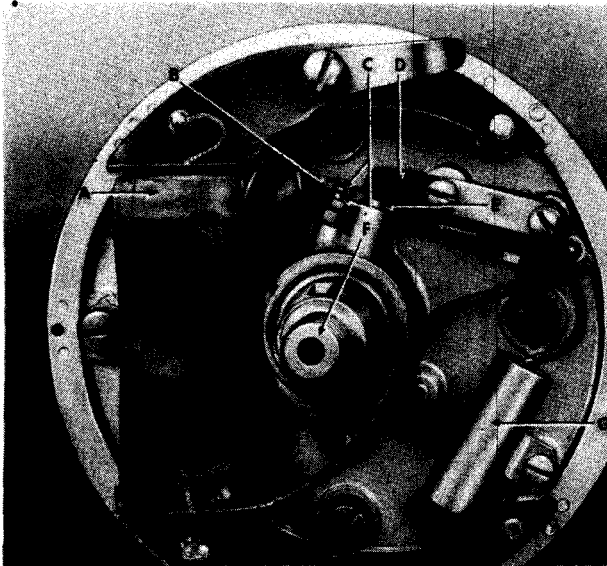

- A—ARMATURE
- B—GAP, 0.020"
- C—POINTS
- D—CONTACT BLOCK
- E—CAM ACTIVATED PLUNGER
- F—CRANKSHAFT
- G—CONDENSER

RA PD 322825

Figure 54—Magneto

d. **Magneto (fig. 54).** Remove the flywheel housing. Remove the pinion gear nut which holds the flywheel, using an open-end wrench and tapping lightly with a mallet. Remove the nut and install the puller (fig. 53) (provided with compressor) and pull the flywheel. The magneto is now exposed. To adjust the contact points (fig. 54), turn the crankshaft by hand and note if the points open and close correctly. Clean contact points and line up squarely by loosening the contact spring bolt. Move the contact spring assembly to line up with the contact screw point and tighten bolt. To adjust contact spring tension, turn crankshaft until points are in open position and place a $\frac{1}{16}$ -inch gage between contact point and end of block. Tighten screws. Turn the contact screw to secure and adjust to 0.020-inch gap. Tighten lock nut.

VEHICULAR GENERAL PURPOSE UNIT EQUIPMENT

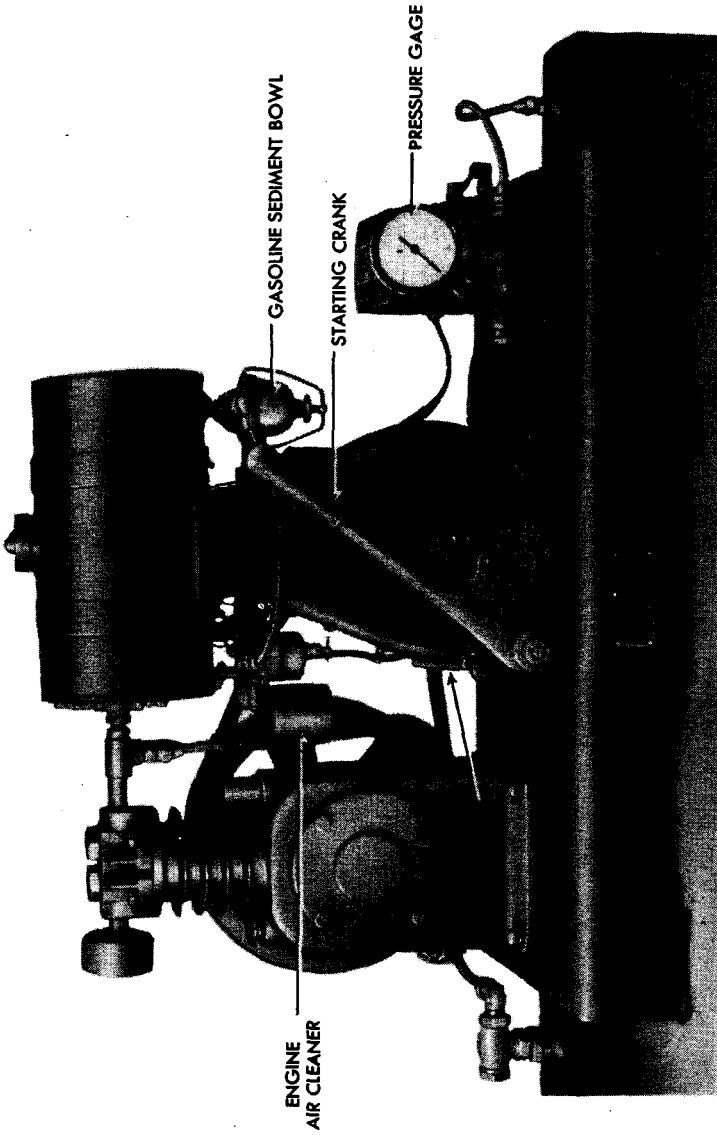

RA PD 322841

Figure 55—Air Compressor—front View

**COMPRESSOR, AIR, 3 CUBIC FEET, GASOLINE ENGINE-DRIVEN—
No. 66-C-1369**

Section XVI

**COMPRESSOR, AIR, 3 CUBIC FEET, GASOLINE ENGINE-
DRIVEN—No. 66-C-1369**

(Kellogg, American Brake Shoe)

50. DESCRIPTION (figs. 55 and 56).

a. This compressor is designed to inflate tires. It is mounted on legs welded to the air tank, which supports the engine and compressor. The 3-cubic-foot air-cooled compressor is belt-driven, and is powered by a gasoline engine. Air pressure supplied by the unit is controlled by an automatic switch. The unit is complete with air hose and fittings for tire inflation.

51. CONTROLS AND INSTRUMENTS.

a. **Starting Crank** (fig. 55). The starting crank is located in the front of the engine, and is mounted on the engine base. The crank is connected to the throttle and, when crank is lifted, the ratchet gear meshes with the crankshaft gear which turns the engine over.

b. **Choke Lever** (fig. 57). The choke lever is located on top of the carburetor on the air inlet. By turning the lever clockwise the engine is choked, and by turning counterclockwise the choke opens.

c. **Stop Switch.** The stop switch is a metal strap mounted on the cylinder head in position with the spark plug terminal. When pressure is applied, the strap contacts the plug terminal, which shorts the ignition system and stops the engine.

d. **Air Gage** (fig. 55). The air gage is mounted on a tee fitting in the air line connected to the automatic switch, and is used to determine the pressure of air desired in the air line.

e. **Fuel Shut-off Valve.** The fuel shut-off valve is located in the gasoline filter. It is opened by turning the lever counterclockwise.

52. OPERATION.

a. **Starting.** Open the fuel shut-off valve by pushing the choke lever clockwise to full choke. Engage the ratchet gear of the crank and crankshaft gear (fig. 55), and in an up-and-down motion crank rapidly to prime and start engine. When the engine starts, gradually open the choke valve counterclockwise until the engine runs smoothly. Open choke fully when engine has warmed up.

b. **Stopping Engine.** Press the stop strap switch against the spark plug terminal and hold down until engine stops firing. Close gasoline shut-off valve.

VEHICULAR GENERAL PURPOSE UNIT EQUIPMENT

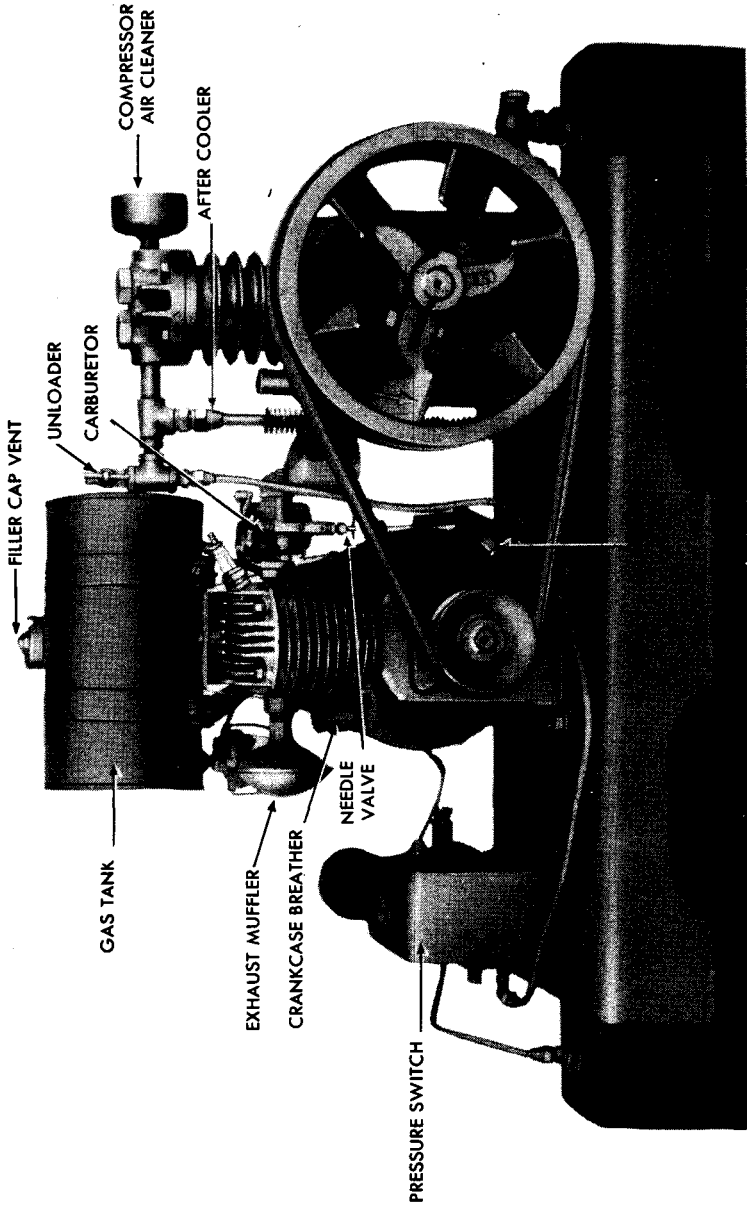

RA PD 322834

Figure 56—Air Compressor—Rear View

**COMPRESSOR, AIR, 3 CUBIC FEET, GASOLINE ENGINE-DRIVEN—
No. 66-C-1369****53. LUBRICATION.**

a. These lubrication instructions are specified for normal operation conditions. Reduce intervals of lubrication under extreme heat or dust conditions and exposure to excessive moisture, any of which may quickly destroy the protective qualities of the lubricants and necessitate servicing to prevent damage to and malfunctioning of the material.

(1) **COMPRESSOR CRANKCASE.** Daily, check oil level and add oil if necessary. Every 48 hours of operation, drain crankcase and refill with OIL, engine, SAE 30, above +32°F; OIL, engine, SAE 10, from +32°F to 0°F; and below 0°F, see OFSB 6-11.

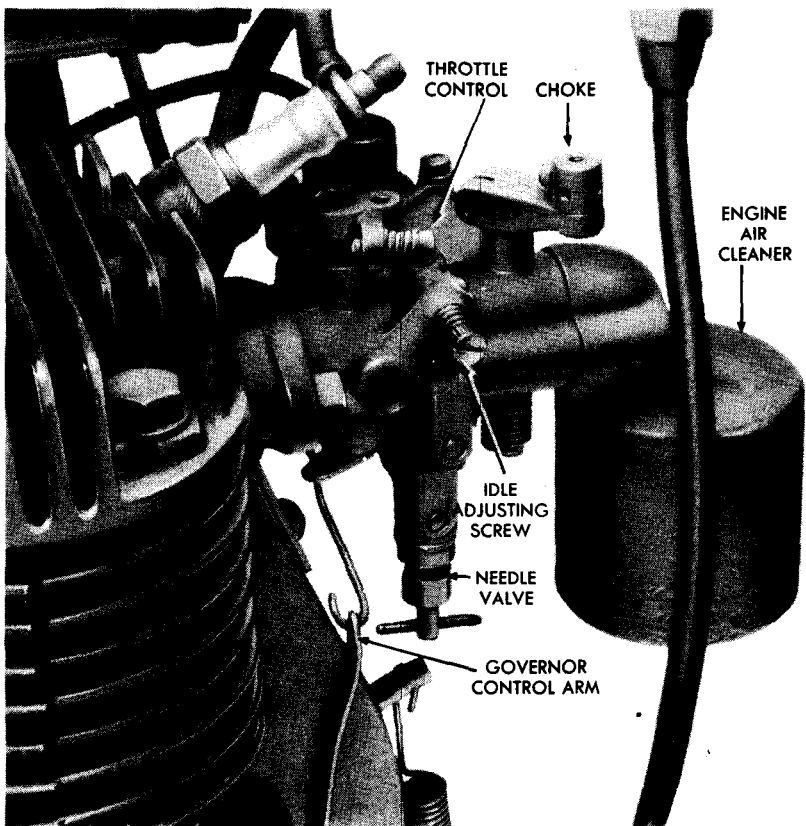

RA PD 322806

Figure 57—Carburetor Adjustments

(2) **ENGINE CRANKCASE** (fig. 56). Every 5 hours of operation check oil level and add oil if necessary. Every 48 hours of operation, drain oil from crankcase and refill with OIL, engine, SAE 30, above

VEHICULAR GENERAL PURPOSE UNIT EQUIPMENT

+32°F; OIL, engine, SAE 10, from +32°F to 0°F; and below 0°F, see OFSB 6-11.

(3) **COMPRESSOR AIR CLEANER** (fig. 56). Daily, check oil level. Every 24 hours of operation, refill with used crankcase oil or OIL, engine. From 0°F to -40°F, use OIL, hydraulic. Below -40°F, remove oil and operate dry. Every 48 hours, disassemble and wash all parts with SOLVENT, dry-cleaning, or OIL, Diesel.

(4) **ENGINE AIR CLEANER** (fig. 55). Daily, check oil level every 24 hours of operation, refill with used crankcase oil or OIL, engine. From 0°F to -40°F, use OIL, hydraulic. Below -40°F, remove oil and run dry. Every 48 hours, disassemble and wash all parts with SOLVENT, dry-cleaning, or OIL, Diesel.

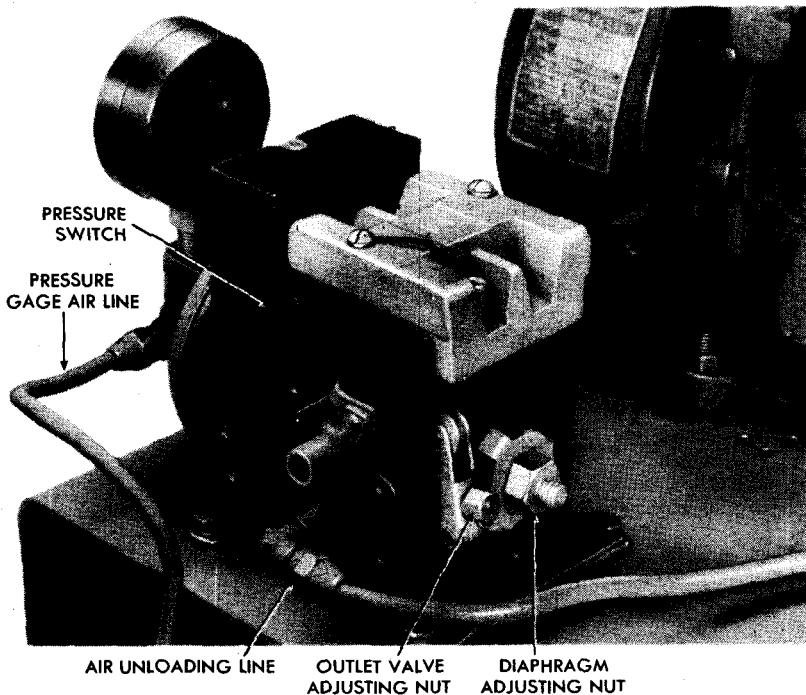

RA PD 322805

Figure 58—Automatic Switch

(5) **CRANKCASE BREATHER** (fig. 56). Every 48 hours, wash breather with SOLVENT, dry-cleaning, or OIL, Diesel. Reoil after washing with used crankcase oil or OIL, engine. From 0°F to -40°F, use OIL, hydraulic. Below -40°F, wash and replace dry.

54. SERVICING.

a. **Carburetor** (fig. 57). To adjust carburetor, close the needle valve by turning clockwise as far as possible. From the closed position

COMPRESSOR, AIR, 3 CUBIC FEET, GASOLINE ENGINE-DRIVEN—
No. 66-C-1369

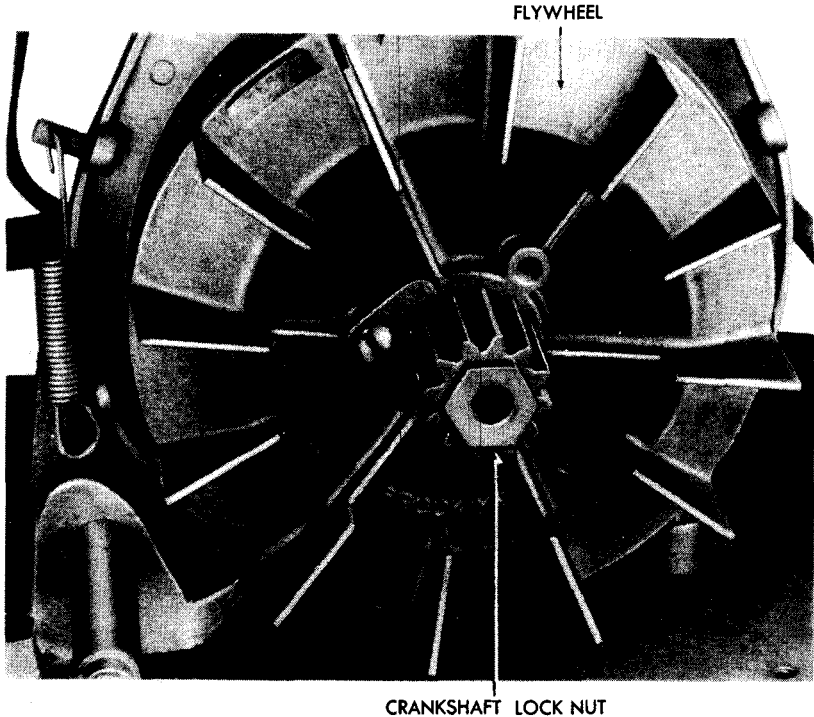

RA PD 322781

Figure 59—Flywheel Ready for Removal

open the needle valve 1 to 1¼ turns. Start engine and warm up. With the choke wide open, turn the needle valve counterclockwise to the point where the engine operates most smoothly. Adjust idling speed by turning the idle adjusting screw (fig. 57) clockwise for reducing speed, and counterclockwise for increasing idling speed of engine.

b. **Automatic Switch** (fig. 58). The automatic switch is adjustable only when the pressure gage is of known accuracy. If the gage is correct, the pressure can be raised or lowered by tightening or loosening the adjusting nut (fig. 58), at the end of the tension spring.

c. **Magneto** (figs. 59 and 60). Remove flywheel cover. Remove spanner lock holding nut to flywheel. Remove lock nut by turning nut to left. Remove flywheel by placing a brass drift at center of crankshaft, tapping lightly with a mallet to loosen flywheel. Clean magneto breaker points. Square points and adjust breaker points to 0.020 inch. Replace flywheel, crankshaft nut, and spanner lock.

VEHICULAR GENERAL PURPOSE UNIT EQUIPMENT

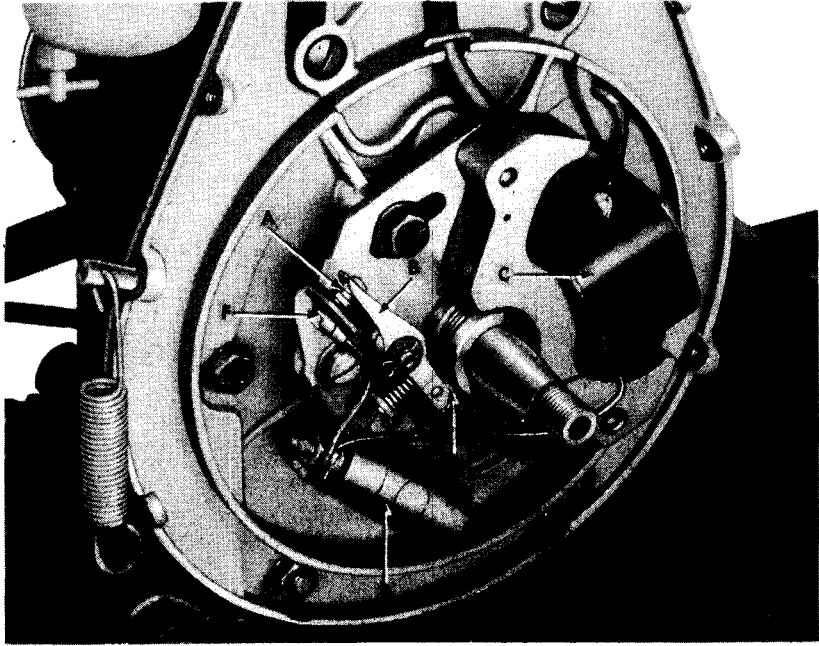

- A—POINTS
- B—CONTACT ARM
- C—ARMATURE
- D—CAM PLUNGER
- E—CONDENSER
- F—STATIONARY BREAKER POINT

RA PD 322830

Figure 60—Magneto Adjustments

PART FOUR
BATTERY CHARGERS

Section XVII

CHARGER, BATTERY—No. 17-C-8730

(Baldor Electric Co., Model No. F6T)

55. DESCRIPTION.

a. The battery charger is a compact unit in a steel cabinet designed for wall or bench mounting. The charger operates on 110- to 220-volt, 60-cycle, single-phase alternating current and is complete with accessories for immediate charging operations. Charging capacity of the charger is 1 to 12 batteries.

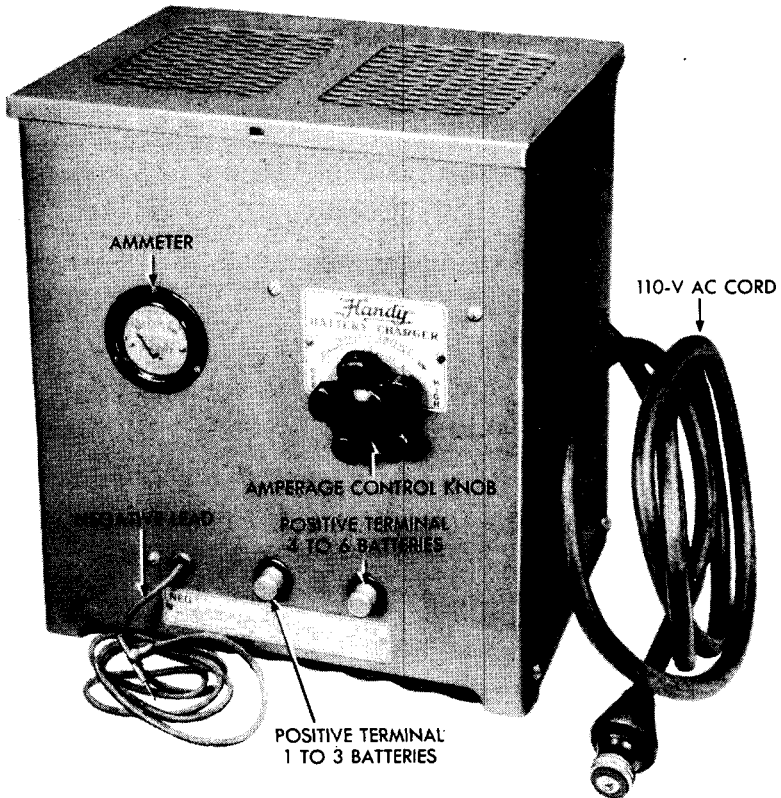

RA PD 322782

Figure 61—Battery Charger

VEHICULAR GENERAL PURPOSE UNIT EQUIPMENT

RA PD 322783

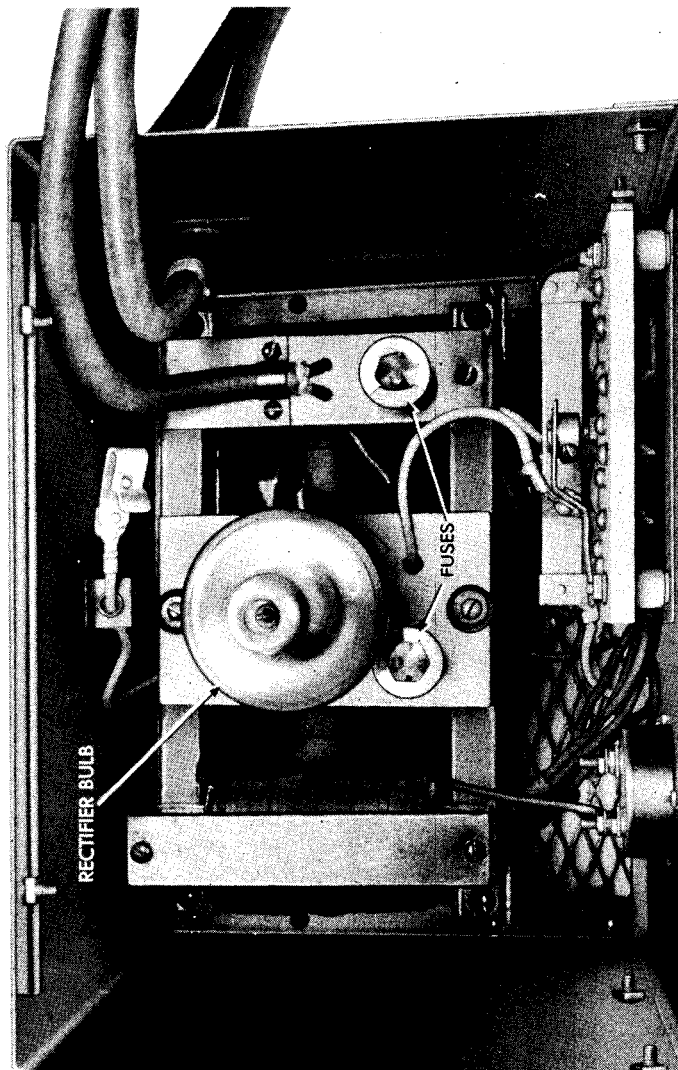

Figure 62—Rectifier Bulb and Fuses

CHARGER, BATTERY—No. 17-C-8730

56. CONTROLS AND INSTRUMENTS.

a. **Control Knob** (fig. 61). The control knob is located on the face of the charger, directly below the ammeter, and is used to control the rectifier bulb located inside the cabinet when charging batteries.

b. **Ammeter** (fig. 61). The ammeter is located on the face of the charger and is calibrated from 0 to 7 amperes for reading the charging rate of the batteries in charge.

c. **Rectifier Bulb** (fig. 62). The bulb is located inside the charger cabinet screwed into the mogul socket in the base of the charger. It is used in connection with the control knob and ammeter which determines proper amperage.

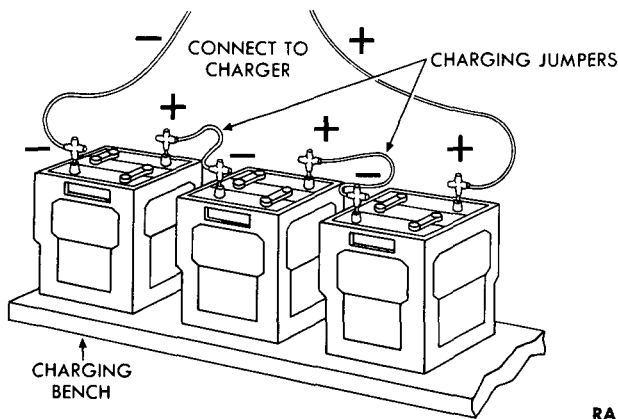

Figure 63—Connections for Battery Charging

57. OPERATION.

a. **Preparation of A-C Connection.** Mount the charger on wall or bench. Install porcelain bushing in hole on left side of charger and pull bare ends of extension cable through the bushing into the charger and splice, solder, and tape cable to the short leads marked "115-V, A-C" and "GRD." Wrap tape around the cable inside cabinet so cable will not pull out.

b. **Preparation of D-C Connection.** Install porcelain bushing in hole on right side of charger. Pull the bare ends of the charging lines through the bushing and connect red line to short lead marked "POS" and the black line to the short lead marked "NEG." After splice has been made, solder and tape each splice.

c. **Installing Rectifier Bulb and Fuses** (fig. 62). Open the top of charger cabinet and insert the two 15-ampere fuses into the sockets provided. Insert the rectifier bulb carefully into the mogul socket and tighten clamp screw. **NOTE:** Always grasp the base of the bulb, never

VEHICULAR GENERAL PURPOSE UNIT EQUIPMENT

the glass or stem. Attach the flexible lead with special clip to the metal stem which protrudes from the glass bulb.

d. **Connecting Batteries.** Connect the batteries in series (fig. 63) by driving connector points into the terminal posts of the batteries. One or twelve batteries can be connected for charging (fig. 64). After connections have been made, connect the charger leads to the batteries.

e. **Charging Batteries.** Plug extension into 110-volt power line. Start charger by turning the control knob to the right. The ammeter will indicate the current going into the batteries. Adjust the charging current to as near 6 amperes as possible, never over 7 amperes, indicated by the red danger portion of the ammeter scale. For single battery charge, keep the charging rate at 4 amperes and for two batteries $3\frac{1}{2}$

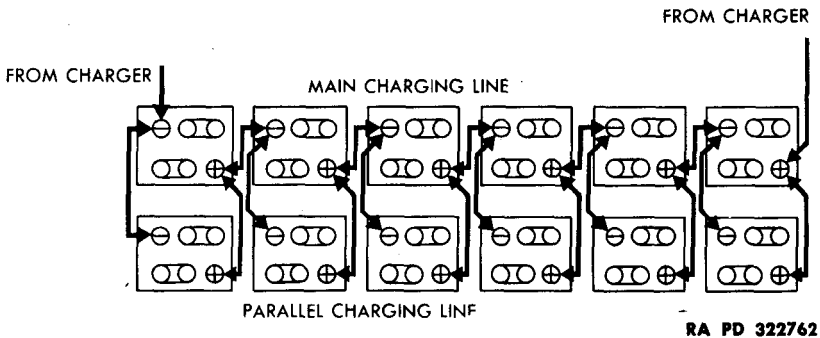

Figure 64—Parallel Charging Line

amperes. During the charge, as the batteries come up, the ammeter pointer will fall off from original adjustment. The falling off is indication that one or more batteries are coming up to full charge. Readjustment to original adjustment can be made. Check with hydrometer before doing so. Stop the charger by turning the control knob all the way to the left. The ammeter will not register and the rectifier bulb will not be lighted. **NOTE:** Do not stop charger by pulling extension from a receptacle.

Section XVIII

CHARGER, BATTERY, 300-WATT, 12-VOLT, GASOLINE ENGINE-DRIVEN—No. 17-C-8760

(Continental Motors, Models Nos. L-62, L-122, and L-322)

58. DESCRIPTION AND DATA.

a. **Description.** The 300-watt, 12-volt battery charger is a gasoline engine-driven unit. The engine is of the single-cylinder, L-head, internal combustion, air-cooled type, coupled to a generator with the

**CHARGER, BATTERY, 300-WATT, 12-VOLT, GASOLINE ENGINE-
DRIVEN—No. 17-C-8760**

RA PD 322768

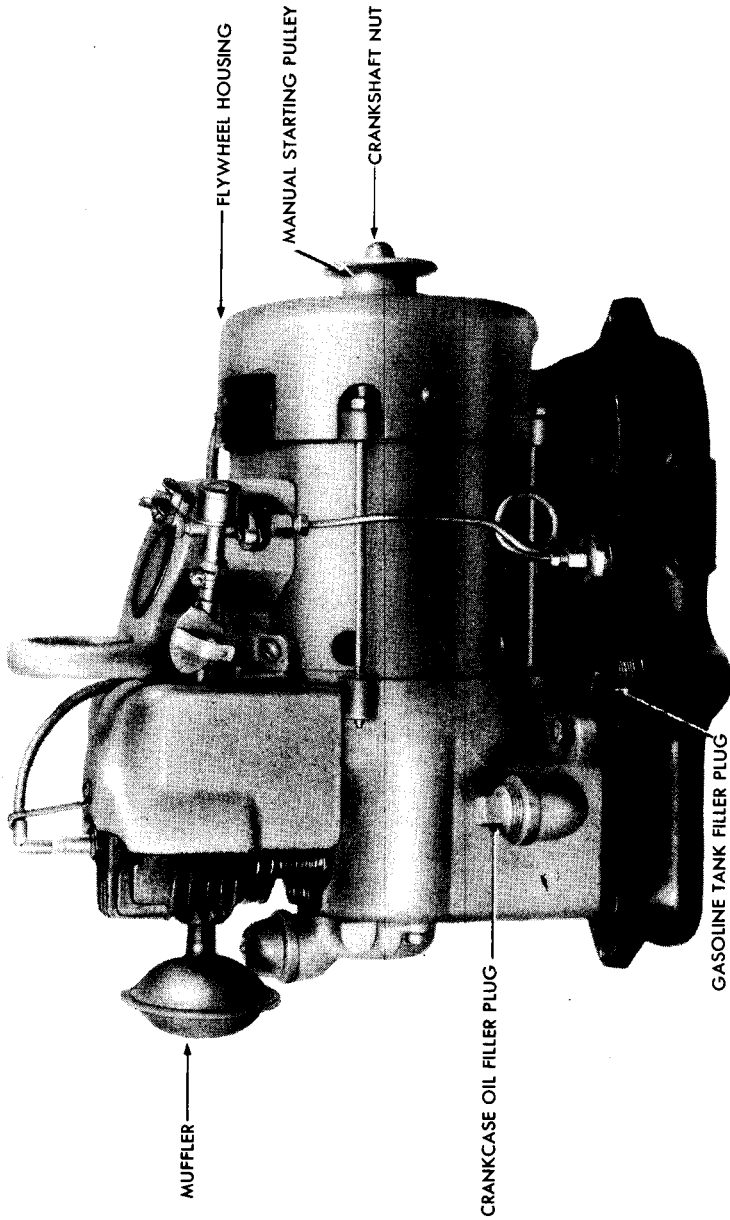

Figure 65—Battery Charger—300-watt, 12-volt

VEHICULAR GENERAL PURPOSE UNIT EQUIPMENT

armature wound directly on the engine crankshaft, and is of the direct-current type. Charging capacity is four batteries. The base of the charger is also the fuel supply tank.

b. Data.

Make and model	Continental L-62, L-122, and L-322
Engine	4-cycle, single-cylinder, L-head
Rating	1/2 hp
Bore	1 3/4 in.
Stroke	1 3/4 in.
Displacement	4.2 cu in.
Compression ratio	4.13 to 1
Fuel	Gasoline
Charger	D-C generator
Output voltage	15 volts d-c

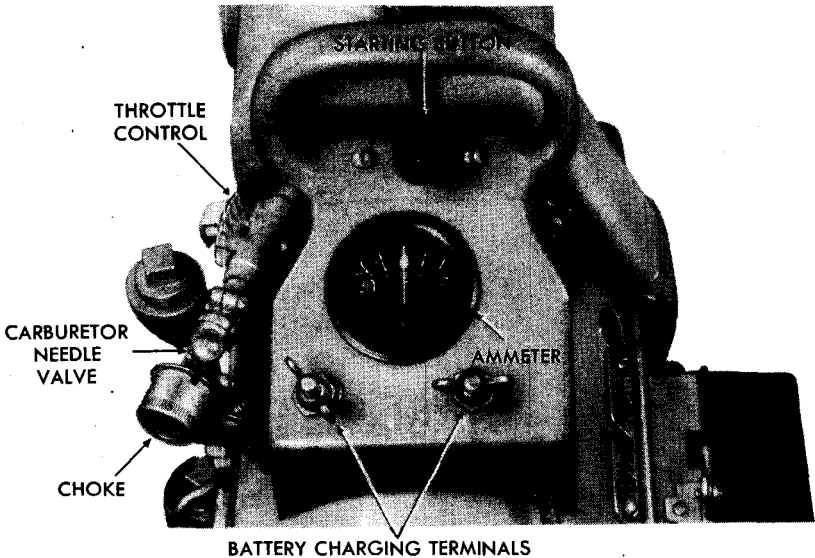

RA PD 322785

Figure 66—Controls and Instruments

59. CONTROLS AND INSTRUMENTS (fig. 66).

a. Starter Button. The starter button is located under the carrying handle of the charger, and operates through power supplied by the generator.

b. Manual Starting (fig. 65). The starting pulley is located at the rear of the armature shaft on the outside of the generator housing. It is operated by winding a rope around the pulley, pulling the rope with a quick steady motion to get cranking speed. Press starting button at the same time.

CHARGER, BATTERY, 300-WATT, 12-VOLT, GASOLINE ENGINE-DRIVEN—No. 17-C-8760

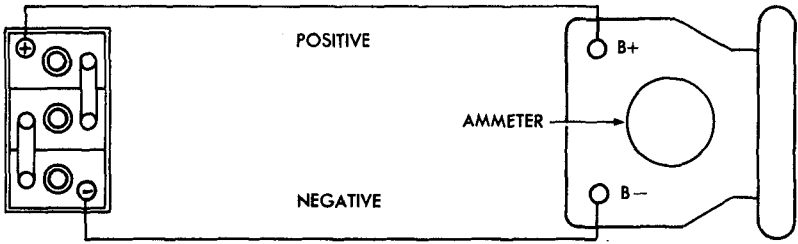

RA PD 322819

Figure 67—Diagram for Connecting to Charge Single Battery

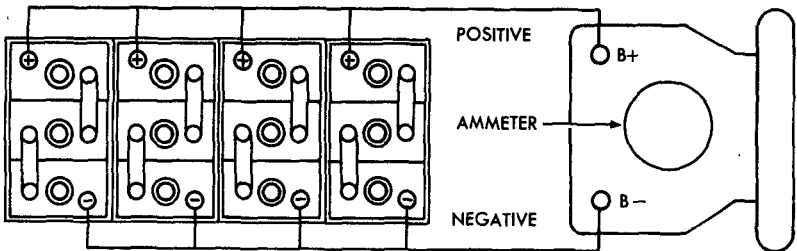

RA PD 322820

Figure 68—Diagram for Multiple Battery Charging

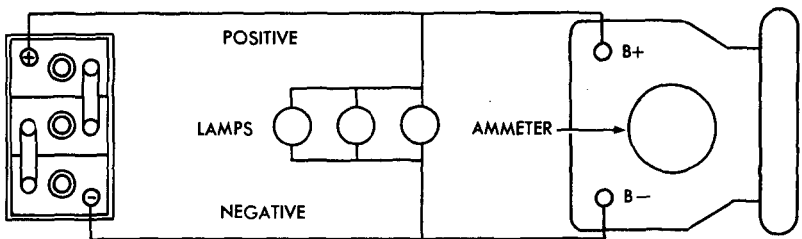

RA PD 322748

Figure 69—Diagram for Connections for a Light Line

VEHICULAR GENERAL PURPOSE UNIT EQUIPMENT

c. **Automatic Voltage Relay Cut-out** (fig. 71). The cut-out is located on the right side of generator. It controls the charger ignition by automatic grounding when batteries are fully charged, eliminating overcharge by stopping the charger.

d. **Gasoline Check Valve**. The valve is located in a tube extending into the gasoline tank. It prevents the engine from stalling by not

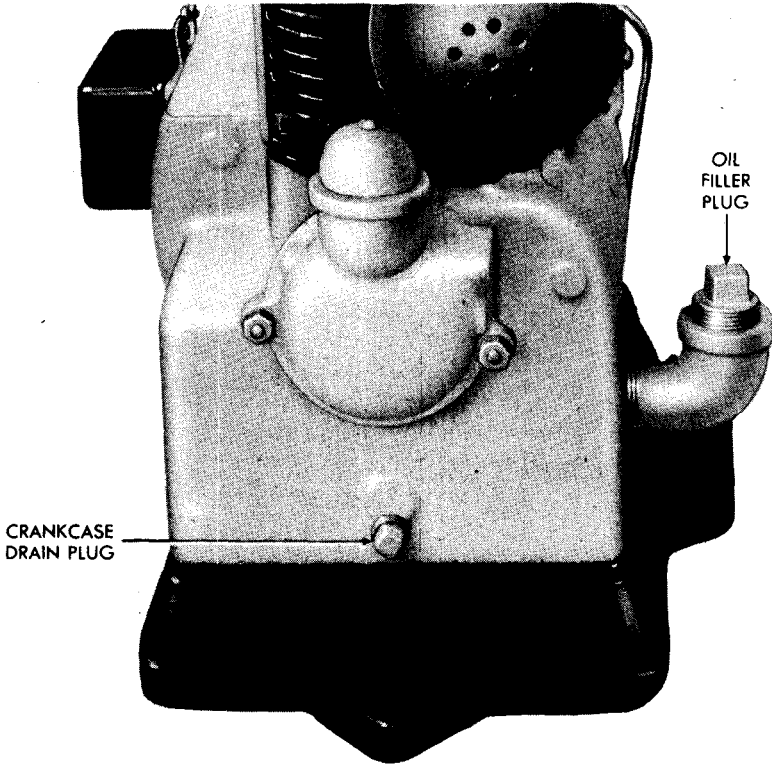

RA PD 322766

Figure 70—Oil Filler and Drain Plugs

allowing gasoline to flow back into the tank after the intake stroke. Operation is automatic.

e. **Ammeter** (fig. 66). The ammeter is located on top of the charger, below the starting button, and is calibrated for reading the charging rates in amperes, depending on the number of batteries in charge.

f. **Throttle Control** (fig. 66). The control is located in the fuel supply line next to the engine and is used to govern the speed of the engine to control the charging rate.

**CHARGER, BATTERY, 300-WATT, 12-VOLT, GASOLINE ENGINE-
DRIVEN—No. 17-C-8760**

60. OPERATION.

a. **Battery Connections** (figs. 67 and 68). Place the battery or batteries as close to the charger as possible. Use No. 4 wire, or larger, and connect battery leads to the terminals located on the instrument panel. *NOTE: The charger cannot be operated without a battery connected.*

b. **Starting.** Place the choke shutter (fig. 66) in a nearly closed position, and press the starting button. Gradually open the choke shutter after the engine is operating. Usual choking can be accomplished by holding the thumb and forefinger over choke opening. If the engine does not operate smoothly, adjust the carburetor needle valve by turning clockwise for lean mixture, and counterclockwise for rich mixture.

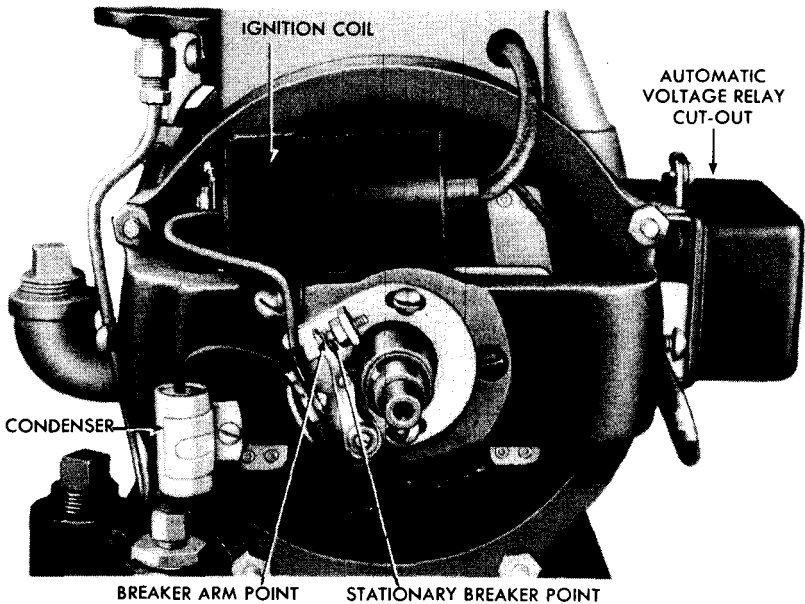

RA PD 322787

Figure 71—Ignition Coil Condenser and Breaker Points

61. LUBRICATION.

a. **Crankcase** (fig. 70). Daily, check oil level and add oil if necessary. Every 48 hours, when engine has been in constant use, drain crankcase while engine is hot and refill, using OIL, engine, SAE 30, above +32°F; OIL, engine, SAE 10, from +30°F to 0°F; and below 0°F, see OFSB 6-11. Remove drain plug (fig. 70) to drain crankcase.

62. SERVICING.

a. **Crankshaft Nut.** The crankshaft acorn nut at pulley should

VEHICULAR GENERAL PURPOSE UNIT EQUIPMENT

be tightened frequently to eliminate excessive play and whip of the crankshaft. This nut holds the armature and pulley in positive position with their relation to the fields and brush holder of the generator.

b. **Automatic Voltage Relay Cut-out** (fig. 71). If the charger is stopping before the batteries are fully charged, remove the cover of the relay cut-out. Increase the tension of the tension spring very slightly by placing a blunt instrument on the edge of the lower lug or spring holder and exerting downward pressure, bending lug slightly. The correct cutting out point may be determined by testing the batteries with a hydrometer. The correct gravity reading should be between 1.275 and 1.300. If the charger continues to operate after a full battery charge has been reached, reverse the operation of the blunt instrument and bend lug slightly upward to decrease the spring tension.

c. **Spark Plug**. Keep spark plug clean. Adjust gap to 0.025 inch.

d. **Ignition Adjustment** (fig. 71). Remove acorn nut holding pulley crankshaft (right-hand thread) and remove housing covering ignition coil, breaker, cam, and condenser. Clean and adjust breaker points to 0.020 inch, and replace cover, pulley, and acorn nut.

Section XIX

**CHARGER, BATTERY, PORTABLE, 12-VOLTS, 2000-WATTS,
GASOLINE ENGINE-DRIVEN—No. 17-C-9635**

(D. W. Onan & Sons, Model No. OTC-33B)

63. DESCRIPTION AND DATA (fig. 72).

a. **Description**. The portable battery charger is protected by a demountable, combination wooden and metal box, the top of which is a container for storing the accessories and instruction books used with the charger. The charger is a gasoline engine-driven unit. The engine is of the two-cylinder, horizontal opposed type, ignition furnished by a magneto generator unit. The generator is of the direct-current type, rated at 2000 watts. Receptacles for battery charging leads are located on the control box.

b. **Data**.

Make and model	Onan OTC-33B
Engine	4-cycle, 2-cylinder
Bore	2 ⁵ / ₈ in.
Stroke	2 ¹ / ₄ in.
Compression ratio	5 ³ / ₄ to 1
Fuel	Gasoline
Charger	D-C generator
Output voltage	15 volt d-c
Output amperage	130 maximum
Speed (governed)	2200 to 2400 rpm

**CHARGER, BATTERY, PORTABLE, 12-VOLTS, 2000-WATTS,
GASOLINE ENGINE-DRIVEN—No. 17-C-9635**

RA PD 322784

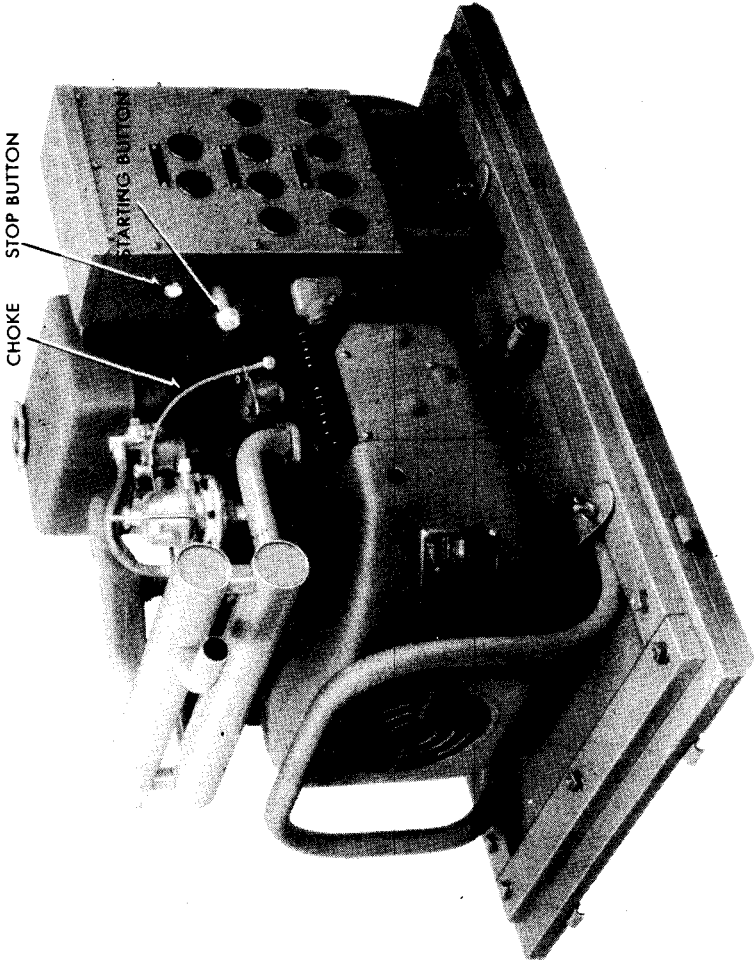
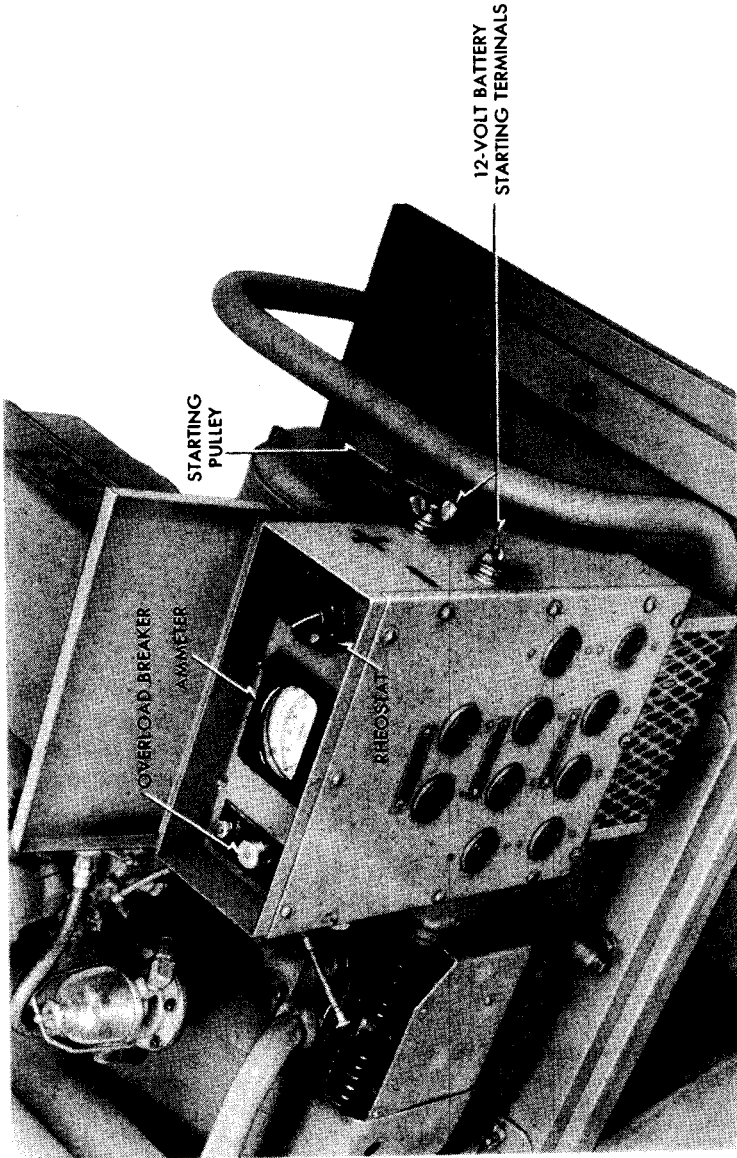

Figure 72—Portable Battery Charger

VEHICULAR GENERAL PURPOSE UNIT EQUIPMENT



RA PD 322765

Figure 73—Control Panel and Receptacle Box

**CHARGER, BATTERY, PORTABLE, 12-VOLTS, 2000-WATTS,
GASOLINE ENGINE-DRIVEN—No. 17-C-9635**

64. CONTROLS AND INSTRUMENTS.

a. **Starter Button** (fig. 72). The starter button is located on the side of the control box next to engine, protrudes from the case, and operates through power supplied through the generator.

b. **Manual Starter** (fig. 73). The starting pulley is located on the generator armature shaft on the outside of the generator housing. It is operated by winding a rope around the pulley, and pulling the rope with a quick motion to get cranking speed.

c. **Choke** (fig. 72). The choke is controlled by wire enclosed in flexible tubing with a pull button on one end. The flexible tubing is attached by clips on the carburetor and manifold, and is operated by pulling the button to close, and pushing the button to open the choke.

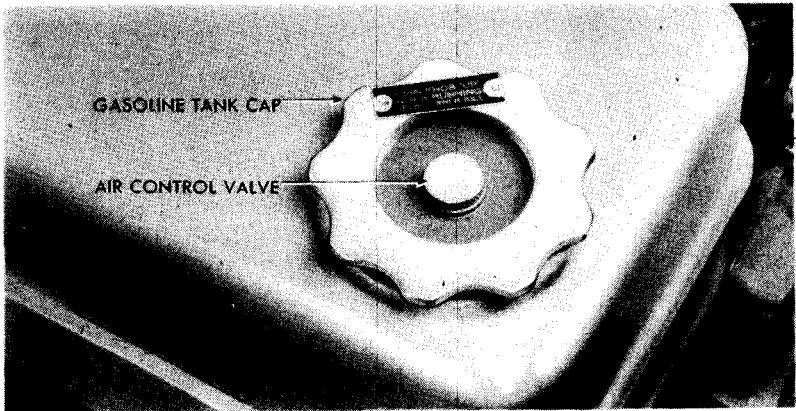

RA PD 322780

Figure 74—Gasoline Tank Air Control Valve

d. **Gasoline Control Valve.** This valve is located on the bottom of the gasoline tank at the extreme rear. It controls the gasoline flow from charger and reserve tanks. When handle is in down position the supply is cut off, when pointing in, the supply is running from charger tank, and when pointing out, supply is from reserve tank when used.

e. **Gasoline Tank Air Control Valve** (fig. 74). This valve is located on the top of the gasoline tank. When the engine is running the knob should be up, when idle the knob should be down.

f. **Stop Button.** The stop button is located on the side of the control panel directly above the starting button and is used for stopping the engine. When pressure is applied the engine stops.

g. **Rheostat** (fig. 73). The rheostat is located at the extreme left side of the control panel and is used for controlling the charge to the batteries.

VEHICULAR GENERAL PURPOSE UNIT EQUIPMENT

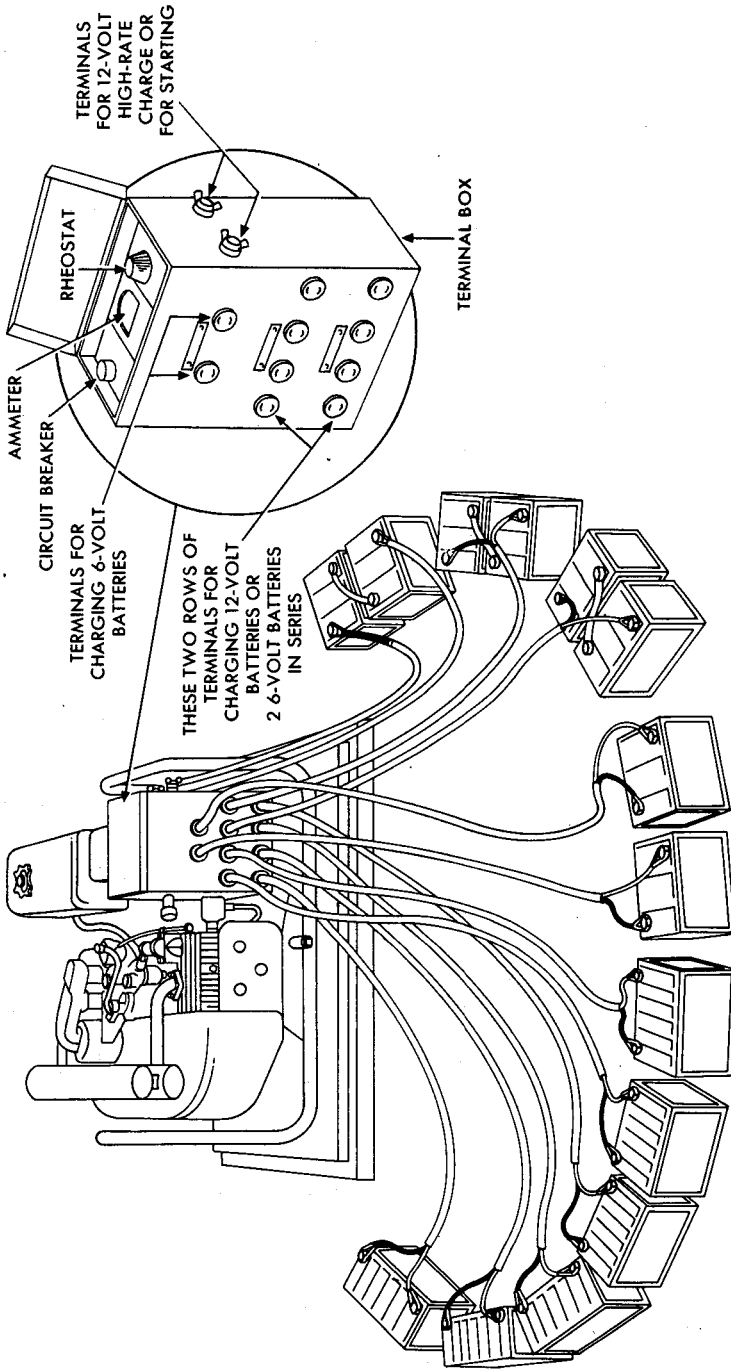

RA PD 322757

Figure 75—Battery and Charger Hook-up Diagram

**CHARGER, BATTERY, PORTABLE, 12-VOLTS, 2000-WATTS,
GASOLINE ENGINE-DRIVEN—No. 17-C-9635**

h. **Ammeter** (fig. 73). The ammeter is located in the center of the control panel, is calibrated to 150 amperes, and is used for reading the amperage of batteries.

i. **Overload Breaker** (fig. 73). The breaker is located at the extreme left side of the control panel. If the breaker trips due to overload, the button is pressed to reset.

65. OPERATION.

a. **Starting.** A 12-volt battery is necessary to start the engine. Attach leads from battery to the terminals located on the outside end

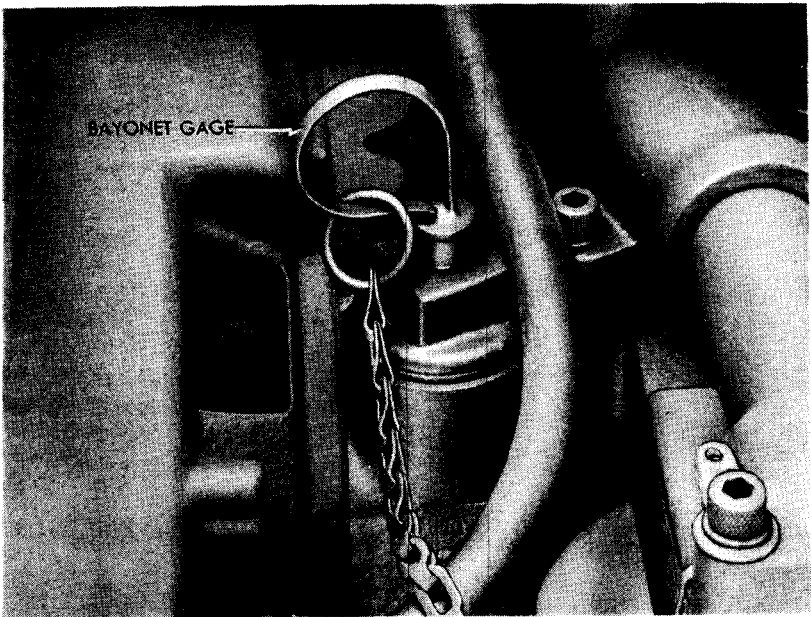

RA PD 322775

Figure 76—Bayonet Gage

of the control box (fig. 73). Open the fuel valve at bottom of gasoline tank, and open vent in the tank cap. Pull out the choke knob and press the starting button. Hold the button in and release, repeating until engine starts. Push the choke in. Disconnect the starting battery. For manual starting connect the starting battery. Wind a rope around the starting pulley and give the rope a strong steady pull. Choke in the same manner as described above.

b. **Charging Batteries** (fig. 75). Attach battery cables to the batteries and plug into the receptacles located in the control box. The 12-volt outlets are controlled by the rheostat located to the right of the

VEHICULAR GENERAL PURPOSE UNIT EQUIPMENT

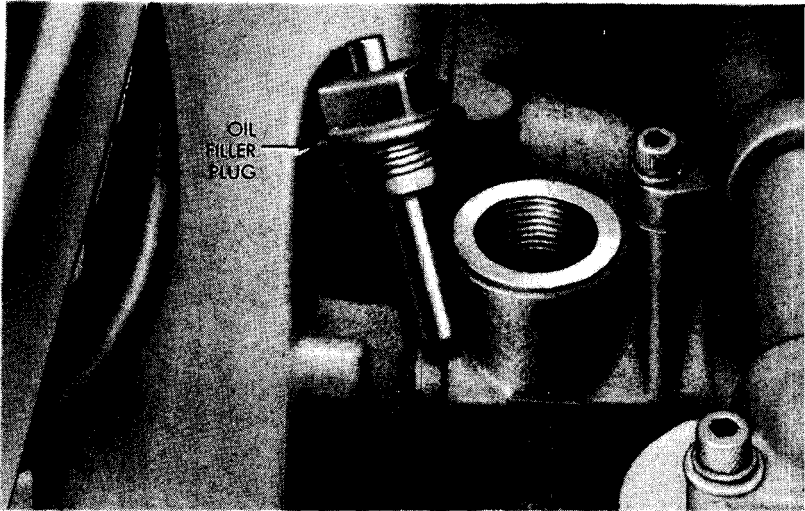

RA PD 322779

Figure 77—Oil Drain Plug Removed

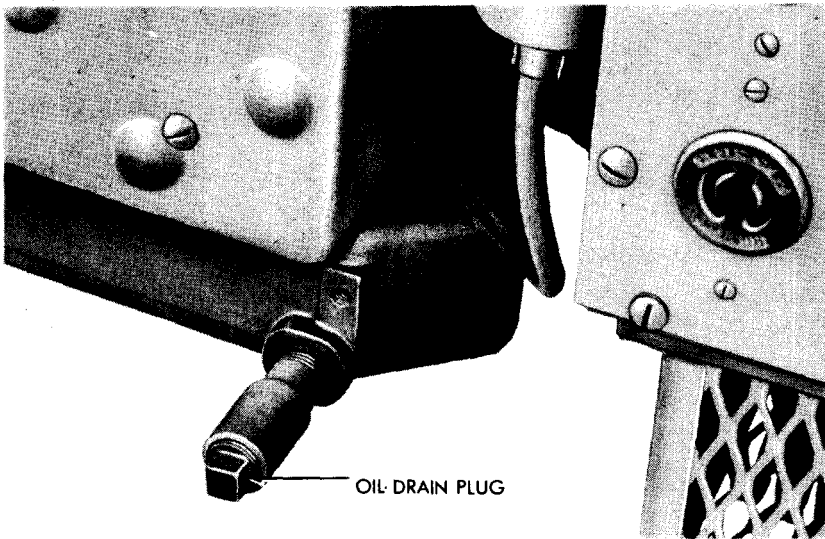

RA PD 322771

Figure 78—Oil Drain Plug

**CHARGER, BATTERY, PORTABLE, 12-VOLTS, 2000-WATTS,
GASOLINE ENGINE-DRIVEN—No. 17-C-9635**

ammeter. The ammeter registers the total output of amperage. If one battery is charged, the ammeter should register 20 amperes, and should increase in multiples of 20 for each battery being charged until a maximum capacity of 120 amperes is reached. Turn knob of rheostat in direction of the arrow for increasing voltage. If the overload breaker trips, press the button on the overload breaker and reset.

66. LUBRICATION.

a. **Crankcase** (figs. 76 and 77). Daily, check oil level and add oil if necessary. Every 48 hours, when engine has been in constant use,

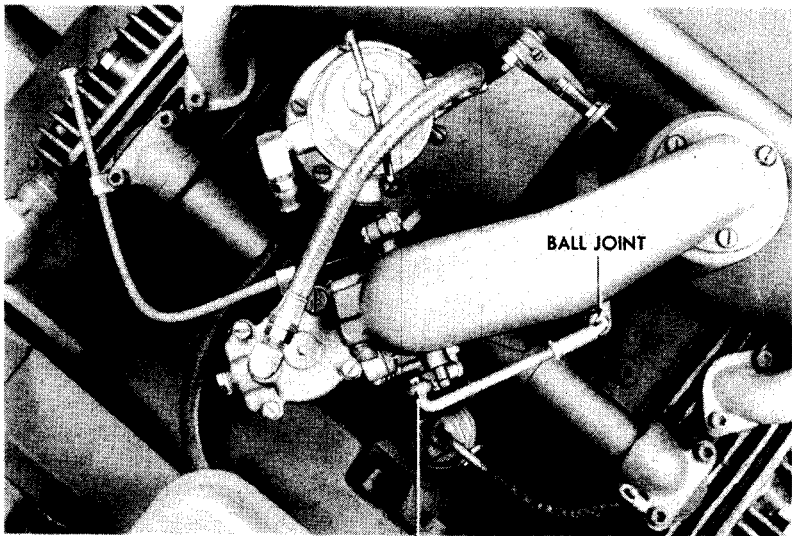

THROTTLE SHAFT BEARING

RA PD 322772

Figure 79—Miscellaneous Lubrication Points

drain crankcase while engine is hot and refill, using OIL, engine, SAE 30, above +30°F; OIL, engine, SAE 10, from +30°F to 0°F; and below 0°F, see OFSB 6-11. To drain, remove drain plug (fig. 78). Remove the bayonet gage (fig. 76). To fill, unscrew oil filler cap (fig. 77), and fill crankcase to capacity (2½ qt). Use the bayonet gage to determine the level of oil when partial change is made. The oil level should never be allowed to go below the level of the low mark on the bayonet gage.

b. **Air Cleaner.** Disassemble and wash parts in SOLVENT, dry-cleaning. Refill with used crankcase oil or OIL, engine. In temperatures ranging from 0°F to -40°F, use OIL, hydraulic; below -40°F, remove oil and operate dry.

VEHICULAR GENERAL PURPOSE UNIT EQUIPMENT

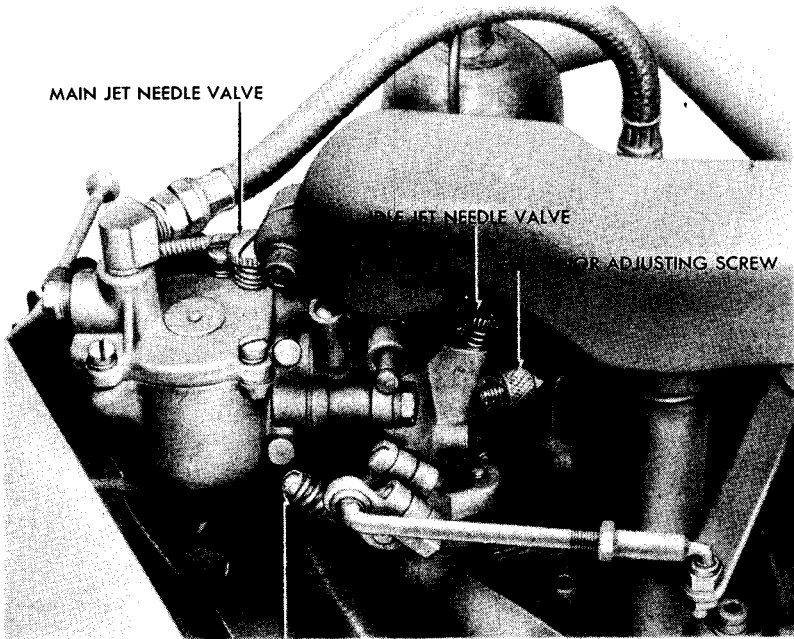

IDLING SPEED ADJUSTMENT

RA PD 322773

Figure 80—Carburetor and Governor Adjustment

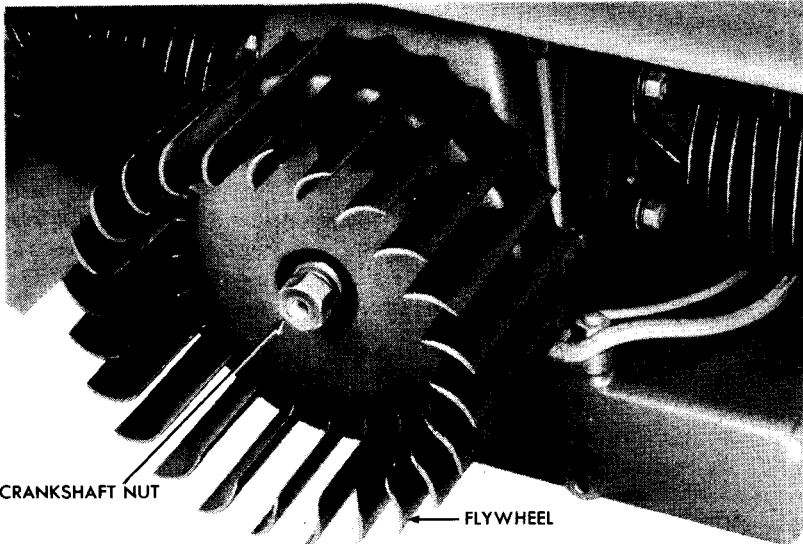

RA PD 322778

Figure 81—Flywheel in Position

**CHARGER, BATTERY, PORTABLE, 12-VOLTS, 2000-WATTS,
GASOLINE ENGINE-DRIVEN—No. 17-C-9635**

c. **Miscellaneous Lubrication Points** (fig. 79). Daily, place a drop of OIL, engine, SAE 10, on the following points: carburetor throttle shaft bearings, governor ball joint, and manual choke shaft.

67. SERVICING.

a. **Carburetor Adjustment** (fig. 80). There are two adjustments on the carburetor. One is the main jet and the other the idle mixture jet. Turn the main jet needle to the right for five turns, then turn it into the carburetor bowl until loss of engine speed occurs, then slowly re-

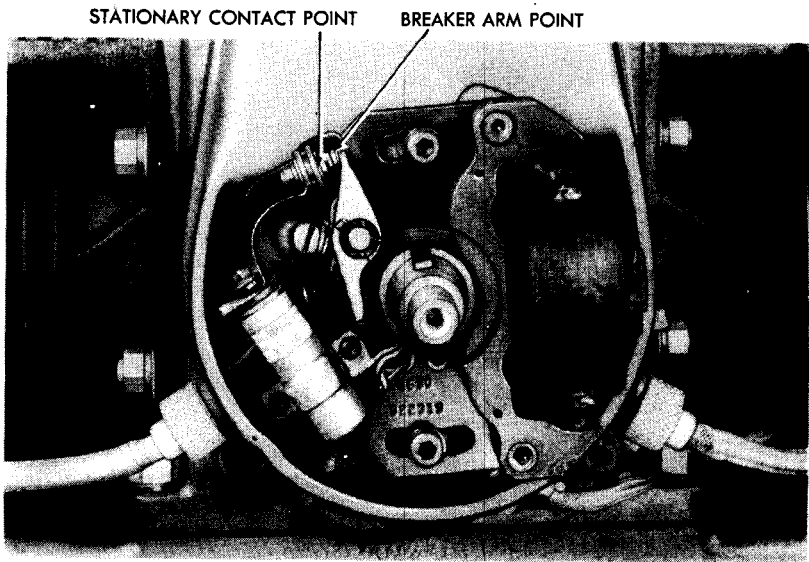

RA PD 322776

Figure 82—Magneto

open until engine regains maximum power. If the engine operates unevenly under no load or light load, turn the idle jet needle down into the carburetor body until it stops. Reopen slowly until the engine runs smoothly, readjust the idling speed by turning the idling speed adjustment stop screw in the necessary direction.

b. **Governor Adjustment** (fig. 80). Adjust the governor by turning the screw holding the spring on top of the governor to the right to decrease, and to the left to increase the speed of the engine.

c. **Magneto Adjustment.** Remove the four wing nuts and four safety screws which hold the charger to the frame, and lift the charger free. Remove the blower housing covering the flywheel by removing the three safety screws holding it to the engine housing. Remove the crank gear from the crankshaft by turning gear nut to the left. Place

VEHICULAR GENERAL PURPOSE UNIT EQUIPMENT

a brass drift of $\frac{1}{2}$ -inch diameter at the center of the crankshaft and tap sharply with a mallet, loosening the flywheel (fig. 81). Lift the flywheel from the crankshaft. The ignition points of the magneto consist of a stationary contact and a breaker arm mounted on the same plate. Clean the contact points and set the gap to 0.020 inch (fig. 82). Replace the flywheel, crankshaft crank gear, blower housing, and charger frame.

APPENDIX

Section XX

REFERENCES

68. PUBLICATIONS INDEXES.

a. The following publication indexes should be consulted frequently for latest changes to or revision of the publications given in this list of references and for new publications relating to materiel covered in this manual:

Introduction to Ordnance Catalog (explains SNL system)	ASF Cat. ORD-1 IOC
Ordnance publication for supply index (index to SNL's)	ASF Cat. ORD-2 OPSI
Index to ordnance publications (lists FM's, TM's, TC's and TB's of interest to Ordnance personnel, MWO's, OPSR's, BSD, S of SR's, OSSC's and OFSB's. Includes alphabetical listing of Ordnance major items with publications pertaining thereto)	OFSB 1-1
List of publications for training (lists MR's, MTP's, T/BA's, T/A's, and FM's, TM's, and TR's concerning training)	FM 21-6
List of training films, film strips and film bulletins (lists TF's, FS's, and FB's by serial number and subject) ..	FM 21-7
Military training aids (lists graphic training aids, models, devices, and displays)	FM 21-8

69. STANDARD NOMENCLATURE LISTS.

Cleaning, preserving and lubricating materials, recoil fluids, special oils, and miscellaneous related items ..	SNL K-1
Soldering, brazing and welding materials, gases and related items	SNL K-2
Electrical apparatus units and parts	SNL M-1
Electrical fittings	SNL H-4
Electrical piece material	SNL H-5
Pipe and hose materials	SNL H-6
Pipe, tubing, and hose	SNL H-7
Ordnance maintenance sets	SNL N-21
Tools, maintenance, for repair of automotive vehicles	SNL G-27
Tool sets for ordnance service command, automotive shops	SNL N-30
Tool sets—motor transport	SNL N-19

VEHICULAR GENERAL PURPOSE UNIT EQUIPMENT

70. EXPLANATORY PUBLICATIONS.

a. General.

Cleaning, preserving, lubricating, and welding materials, and similar items issued by the Ordnance Department	TM 9-850
Military motor vehicles	AR 850-15
Precautions in handling gasoline	AR 850-20
Standard military motor vehicles	TM 9-2800

a. Related Technical Manuals.

Automotive electricity	TM 10-580
Basic maintenance manual	TM 38-250
Electrical fundamentals	TM 1-455

c. Decontamination.

Chemical decontamination materials and equipment . .	TM 3-220
Decontamination of armored force vehicles	FM 17-59
Defense against chemical attack	FM 21-40

INDEX

A	Page No.	C	Page No.
Adapters and gaskets, description	6	Cam angle test	35
Adjustment		Camber test, portable wheel align- ment indicator	15
carburetor	58	Carburetor	
compressor governor	57	adjustment	58
magneto	59	servicing	
Air chuck assembly, description	11	electric arc welding outfit	45
Air cleaner lubrication		5 horsepower, 16 cubic feet air compressor	73
electric arc welding outfit	49	6 cubic feet air compressor	66
12-volt, 2000-watt battery charger	99	3 cubic feet air compressor	80
Air exhaust bag, maintenance	8	12-volt, 2000-watt battery charger	101
Air gage, description		Caster test of portable wheel align- ment indicator	16
5 horsepower, 16 cubic feet air compressor with tank and hose	70	Charger, battery, No. 17-C-8730	
4 cubic feet air compressor	51	controls and instruments	85
3 cubic feet air compressor	77	description	83
Air valve control, description	6	operation	85
Ammeter		Charger, battery, portable, 12-volt, 2000-watt, gasoline engine- driven, No. 17-C-9635	
description and functioning		controls and instruments	95
300-watt, 12-volt battery charger	90	description and data	92
2000-watt, 12-volt battery charger	97	lubrication	99
location	85	operation	97
Automatic switch, servicing		servicing	101
5 horsepower, 16 cubic feet air compressor	75	Charger, battery, 300-watt, 12-volt, gasoline engine-driven, No. 17-C-8760	
6 cubic feet air compressor	67	controls and instruments	88
Automatic choke, servicing	46	data	88
Automatic voltage relay cut-out		description	86
description and functioning	90	lubrication	91
servicing	92	operation	91
Auxiliary control panel, location and functioning	39	servicing	91
Auxiliary power generator, operation	44	Choke, lever, description and func- tioning	
B		5 horsepower, 16 cubic feet air compressor with tank and hose	69
Battery charger	82	4 cubic feet air compressor	51
Battery test	22	Circular degree ring, location and functioning	33
Battery tester, universal, No. 17-T-5505		Close-out cock, description	51
description	18	Coil test breaker, description	25
operation	20	Coil test switch, location and functioning	25
Breaker contact meter, functioning	25		
Breaker test switch, location and functioning	25		

VEHICULAR GENERAL PURPOSE UNIT EQUIPMENT

C—Cont'd	Page No.		Page No.
Compression test	11	Control knob, location and functioning	85
Compressor, air, portable, gasoline engine-driven, 5 horsepower, 16 cubic feet, with tank and hose, No. 66-C-1175		Controls and instruments	
controls and instruments.....	67	battery charger	
description	67	300-watt, 12-volt, gasoline engine-driven	85
lubrication	71	2000-watt, 12-volt, gasoline engine-driven	95
operation	70	distributor motor-driven tester..	33
servicing	73	electric arc welding outfit.....	38
Compressor, air, 3 cubic feet, gasoline engine-driven, No. 66-C-1369		gasoline engine-driven air compressors	
controls and instruments.....	77	5 horsepower, 16 cubic feet, with tank and hose, No. 66-C-1175	67
description	77	4 cubic feet, No. 66-C-1380..	51
lubrication	79	6 cubic feet, No. 66-C-1370..	61
operation	77	3 cubic feet, No. 66-C-1369..	77
servicing	80	high-tension ignition circuit tester	25
Compressor, air, portable type, 4 cubic feet, gasoline engine-driven, No. 66-C-1380		low-voltage circuit tester.....	20
controls and instruments.....	51	spark plug cleaner and tester...	6
description	51	Crankcase, lubrication	
lubrication	55	electric arc welding outfit.....	49
operation	55	2000-watt, 12-volt battery charger	99
servicing	57	Crankcase breather, lubrication	
Compressor, air, portable, 6 cubic feet, gasoline engine-driven, No. 66-C-1370		electric arc welding outfit.....	49
controls and instruments.....	61	5 horsepower, 16 cubic feet air compressor	71
description	61	6 cubic feet air compressor.....	65
lubrication	64	3 cubic feet air compressor.....	80
operation	61	Cranking motor, lubrication.....	49
servicing	66	Current regulator test	22
Compressor air cleaner, lubrication, 3 cubic feet air compressor.	79	Cut-out relay test	22
Compressor air filter, lubrication, 5 horsepower, 16 cubic feet air compressor	71		
Compressor air strainer, lubrication	55	D	
Compressor crankcase, lubrication		Description	
5 horsepower, 16 cubic feet air compressor	71	battery charger	83
4 cubic feet air compressor.....	55	combination vacuum and pressure gage	11
6 cubic feet air compressor.....	64	cylinder compression gage.....	10
3 cubic feet air compressor.....	79	distributor motor-driven tester..	31
Compressor governor, adjustment.	57	electric arc welding outfit.....	38
Condenser switch, description....	25	5 horsepower, 16 cubic feet gasoline engine-driven portable air compressor with hose	67
		high-tension ignition circuit tester	25

INDEX

D—Cont'd	Page No.		Page No.
Description—Cont'd		Gage, cylinder compression, No.	
kerosene spray engine cleaner . . .	8	41-G-124	
low-voltage circuit tester	20	assemblies	10
neon tube type timing light	16	description	10
portable wheel alinement indica-		operation	11
tor	14	Gap gages, description	6
6 cubic feet gasoline engine-		Gasoline engine-driven portable	
driven portable air compressor	61	type air compressor, 4 cubic feet,	
spark plug cleaner and tester . . .	6	No. 66-C-1380	51
3 cubic feet gasoline engine-		Generator, lubrication	49
driven air compressor	77	Generator control panel, location	
300-watt, 12-volt gasoline engine		and functioning	39
driven battery charger	86	Generator-regulator test connec-	
12-volt, 2000-watt gasoline en-		tions	22
gine-driven portable battery		Geometry test of portable wheel	
charger	92	alinement indicator	16
universal battery tester	18	Governor	
Dial indicator, description	22	lubrication	49
Distributor, lubrication	49	servicing	
E		electric arc welding outfit . . .	45
Electric fuel pump, description . . .	39	5 horsepower, 16 cubic feet	
Engine air cleaner, lubrication		air compressor	74
4 cubic feet air compressor	55	6 cubic feet air compressor . .	66
6 cubic feet air compressor	64	12-volt, 2000-watt battery	
3 cubic feet air compressor	80	charger	101
Engine cleaner, kerosene spray,		Governor control adjustment	45
No. 40-C-1008-20		Governor control lever	
description	8	description and functioning . . .	70
operation	9	servicing	66
Engine control panel, location and		H	
functioning	38	Head assembly, description	14
Engine crankcase, lubrication		High-tension cables, operation . . .	29
5 horsepower, 16 cubic feet air			
compressor	71	I	
4 cubic feet air compressor	55	Ignition timing	
6 cubic feet air compressor	64	correct setting	14
3 cubic feet air compressor	79	neon tube type timing light	18
Engine speed, governor, servicing.	59	Indicator, wheel alinement, port-	
F		able, No. 41-I-130	
Flexible assembly, description	10	controls and gages	14
Field rheostat, description	20	description	14
Fuel shut-off valve, location	51	operation	15
G		Indicator switch, location and	
Gage, combination vacuum and		functioning	33
pressure, No. 41-G-500		Intensity control, location and	
description	11	functioning	33
operation	12		

VEHICULAR GENERAL PURPOSE UNIT EQUIPMENT

K	Page No.	Page No.	
Kerosene spray engine cleaner, No. 40-C-1008-20		Neon tube type timing light, No. 41-L-1440	
description	8	description	
operation	9	operation	
L		O	
Light, timing, neon tube type, No. 41-L-1440		Oil filter, lubrication	49
description	16	Operation	
operation	18	battery charger	85
Low-voltage circuit tester, No. 17-T-5575		combination vacuum and pres- sure gage	
controls and instruments	20	correct setting of ignition	
description	20	timing	14
operation	22	vacuum lift test	12
Lubrication		cylinder compression gage,	
distributor motor-driven tester.	37	No. 41-G-124.....	11
electric welding outfit	46	distributor motor-driven tester..	35
4 cubic foot gasoline engine- driven air compressor	55	5 horsepower, 16 cubic feet gas- oline engine-driven portable air compressor with tank and hose	70
3 cubic feet gasoline engine- driven air compressor	79	4 cubic feet gasoline engine- driven portable type air comp- ressor	55
300-watt, 12-volt gasoline en- gine-driven battery charger...	91	high tension ignition circuit	
2000-watt, 12-volt gasoline en- gine-driven portable battery		tester	25
charger	99	kerosene spray engine cleaner..	9
M		low-voltage circuit tester.....	22
Magneto		neon tube type timing light....	18
adjustment	59	portable wheel alinement indi- cator, No. 41-I-130.....	15
servicing		6 cubic feet gasoline engine- driven portable air compressor..	61
5 horsepower, 16 cubic feet		spark plug cleaner and tester...	7
air compressor	75	3 cubic feet gasoline engine- driven air compressor.....	77
6 cubic feet air compressor...	67	300-watt, 12-volt gasoline en- gine-driven battery charger...	91
3 cubic feet air compressor...	81	12-volt, 2000-watt gasoline en- gine-driven portable battery	
12-volt, 2000-watt battery		charger	97
charger	101	universal battery tester.....	20
Maintenance of air exhaust bag ...	8	P	
Motor speed rheostat, location and functioning	33	Pointers and turn plates, descrip- tion	14
Motor switch		Polarity switch, description.....	20
description	25	Portable wheel alinement indicator	
location and functioning.....	33	No. 41-I-130	
Multirange control, description...	39	controls and gages.....	14
N			
Needle valve			
adjustment	58		
description	6		

INDEX

P—Cont'd	Page No.		Page No.
Portable wheel alinement indicator No. 41-I-130—Cont'd		Tester, low-voltage circuit No. 17-T-5575	
description	14	controls and instruments.....	20
operation	15	description	20
Pressure gage, description.....	6	operation	22
Push button, description.....	6	Testing spark plug gap.....	8
R			
Rectifier bulb		Throttle control, description and functioning	90
description and functioning....	85	Throttle lever, description and functioning	69
installation	85	Timing light, neon tube type, No. 41-L-1440	
Regulator test selector, description	20	description	16
Remote control, description.....	39	operation	18
Rigid assembly, description.....	10	Toe-in test of portable wheel aline- ment indicator	16
S			
Safety valve, servicing.....	58	U	
Sandblast cleaning spark plugs....	8	Universal battery tester, No. 17-T-5505	
Spark plug cleaner and tester, No. 40-C-1011		description	18
controls and instruments.....	6	operation	20
description	6	Utility switch, description.....	20
maintenance	8	V	
operation	7	Vacuum gage, location and func- tioning	33
Spark plugs, operation.....	29	Vacuum lift test.....	12
Starting pedal, location and functioning	51	Vacuum pump knob, location and functioning	33
Starting pulley, operation.....	51	Variable spark gap, location and functioning	25
Stop switch, description and functioning	51	Vehicle breaker test.....	29
Synchronizing double breaker distributors	37	Voltage regulator test.....	24
T			
Tachometer, location and function- ing	33	Voltage selector switch, descrip- tion	20
Tester, battery, universal, No. 17-T-5505		W	
description	18	Water pump, lubrication.....	49
operation	20	Welding outfit, electric arc, No. 17-W-1715	
Tester, distributor motor-driven, No. 17-T-5540		controls	38
controls and instruments.....	33	description and data.....	38
description	31	lubrication	46
lubrication	37	operation	39
operation	35	servicing	45
Tester, ignition circuit, high-ten- sion, No. 17-T-5520		Wheel alinement indicator, port- able, No. 41-I-130	
controls and instruments.....	25	controls and gages.....	14
description	25	description	14
operation	25	operation	15