

WAR DEPARTMENT TECHNICAL MANUAL

TM 9-340

240-mm Howitzers
M1918MI and M1918MIA1,
240-mm Howitzer Carriage
M1918A2, and Transport
Wagons M4 and M5



WAR DEPARTMENT

• *6 APRIL 1944*

RESTRICTED DISSEMINATION OF RESTRICTED MATTER—
The information contained in restricted documents and the essential characteristics of restricted materiel may be given to any person known to be in the service of the United States and to persons of undoubted loyalty and discretion who are cooperating in Government work, but will not be communicated to the public or to the press except by authorized military public relations agencies. (See also paragraph 18*b*, AR 380-5, 28 September 1942.)

WAR DEPARTMENT
Washington 25, D. C., 6 April 1944

TM 9-340, 240-mm Howitzers M1918MI and M1918MIA1, 240-mm Howitzer Carriage M1918A2, and Transport Wagons M4 and M5, is published for the information and guidance of all concerned.

[A.G. 300.7 (8 Jan 44)
O.O. 461/51378]

BY ORDER OF THE SECRETARY OF WAR:

G. C. MARSHALL,
Chief of Staff.

OFFICIAL:

J. A. ULIO,
*Major General,
The Adjutant General.*

DISTRIBUTION: Armies (10); Corps (10); SvC (10); Depts (10);
Def Comd (2); D (2); B (2).

(For explanation of symbols, see FM 21-6.)

CONTENTS

		Paragraphs	Pages
CHAPTER	1. INTRODUCTION	1- 4	4- 12
CHAPTER	2. HOWITZER, CARRIAGE, TRANSPORT WAGONS, CRANE, AND CLAMSHELL TRAILER	5- 81	13-186
SECTION	I. Description and functioning of howitzer	5- 7	13- 28
	II. Description and functioning of recoil mechanism	8- 9	28- 37
	III. Description and functioning of carriage	10- 17	37- 57
	IV. Description and functioning of transport wagons	18- 21	57- 75
	V. Description and functioning of truck-mounted crane and clamshell trailer	22- 23	75- 79
	VI. Operation	24- 37	80-116
	VII. Lubrication	38- 40	116-128
	VIII. Care and preservation.....	41- 50	128-143
	IX. Inspection and adjustment.....	51- 67	143-162
	X. Malfunctions and corrections....	68- 70	163-169
	XI. Disassembly and assembly	71- 81	170-186
CHAPTER	3. SIGHTING EQUIPMENT	82- 89	187-201
CHAPTER	4. AMMUNITION	90-102	202-222
CHAPTER	5. ORGANIZATIONAL SPARE PARTS AND ACCESSORIES	103-104	223-235
CHAPTER	6. STORAGE, PACKING, AND SHIPMENT	105-108	236-247
CHAPTER	7. PREPARATION OF MATERIEL FOR USE UNDER EXTREME CONDITIONS	109-113	248-250
CHAPTER	8. REFERENCES	114-117	251-252
INDEX		253-259

**240-MM HOWITZERS M1918MI AND M1918MIA1, 240-MM HOWITZER
CARRIAGE M1918A2, AND TRANSPORT WAGONS M4 AND M5**

CHAPTER 1

INTRODUCTION

1. SCOPE.*

a. This Technical Manual is published for the information of the using arms and services.

b. In addition to a description of the 240-mm Howitzers M1918MI and M1918MIA1, Howitzer Carriage M1918A2, and high-speed Transport Wagons M4 and M5, this manual contains technical information required for the identification, inspection, operation, and care of the materiel. Some deviation from standard nomenclature occurs herein as the Standard Nomenclature List had not been revised to include latest modifications of materiel at the time this manual was prepared.

c. This manual also contains description of ammunition and information on the identification, operation, and care of the sighting equipment, authorized for use with the 240-mm Howitzers M1918MI and M1918MIA1.

d. Certain disassembly and assembly operations, as well as adjustments and repairs of the materiel, that may be handled by the battery personnel are covered in this manual. Such work will be undertaken only under the supervision of an officer or the artillery mechanic.

e. In all cases where the nature of the repair, modification, or adjustment is beyond the scope or facilities of the battery personnel, the responsible ordnance service should be informed in order that trained personnel with suitable tools and equipment, may be provided or proper instructions issued for the performance of the work.

2. CHARACTERISTICS.

a. **Howitzer.** The 240-mm Howitzers M1918MI and M1918MIA1 (figs. 1 and 2) are short-barreled weapons, using separate-loading ammunition. They throw a 345-pound projectile at a muzzle velocity of 1,700 feet per second to a maximum range of approximately 16,400 yards. The rate of fire for rapid bursts is one round per minute; for prolonged firing it is one round every 2 minutes. The howitzer is equipped with a manually operated breech assembly and percussion type firing mechanism.

*To provide operating instructions with the materiel, this Technical Manual has been published in advance of complete technical review. Any errors or omissions will be corrected by changes or, if extensive, by an early revision.

INTRODUCTION

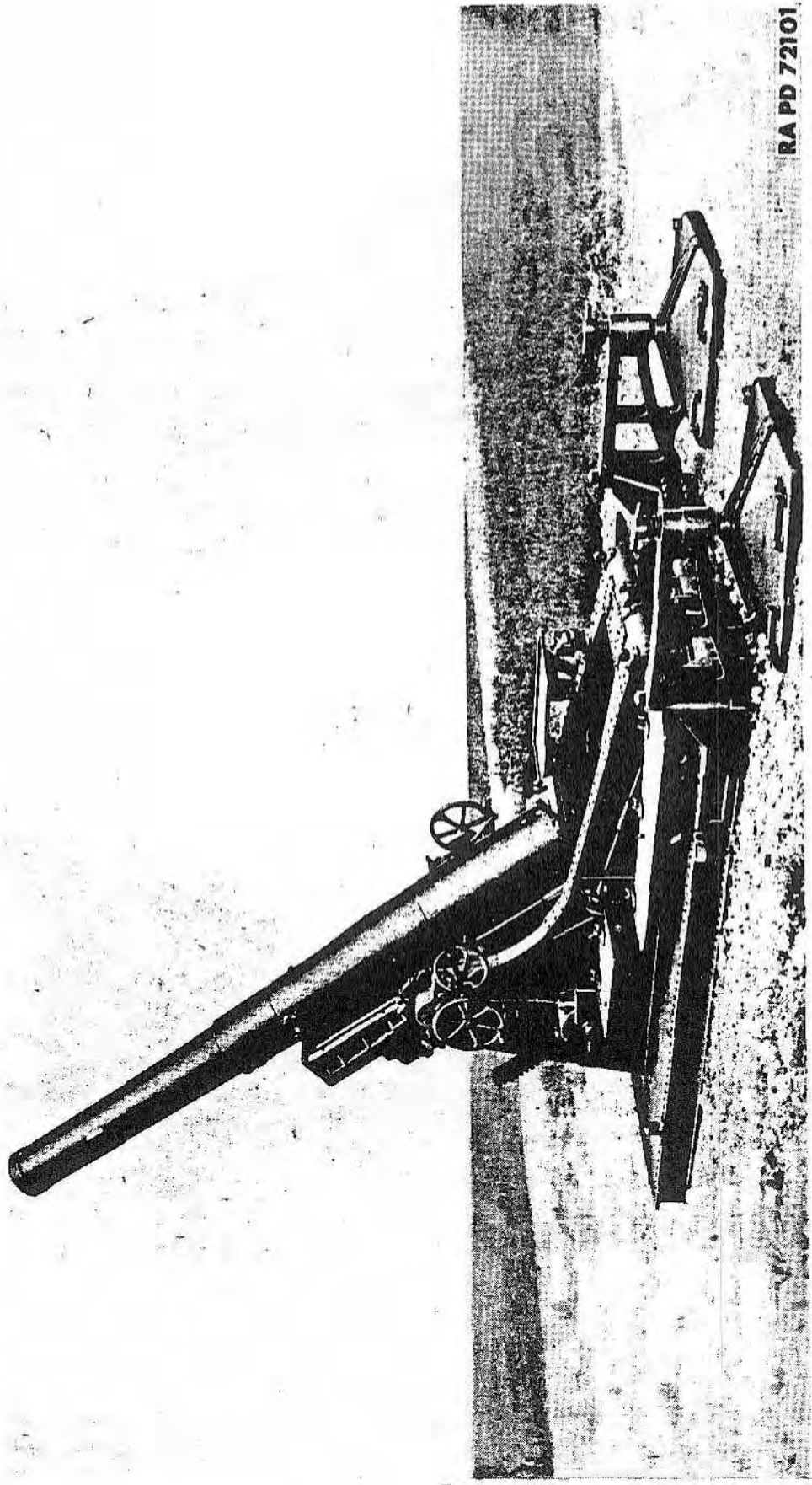

RA PD 72101

Figure 1 — 240-mm Howitzers M1918M1 and M1918M1A1, and Carriage M1918A2, Employed in Firing Position — Maximum Elevation

TM 9-340

2

240-MM HOWITZERS M1918M1 AND M1918M1A1, 240-MM HOWITZER
CARRIAGE M1918A2, AND TRANSPORT WAGONS M4 AND M5

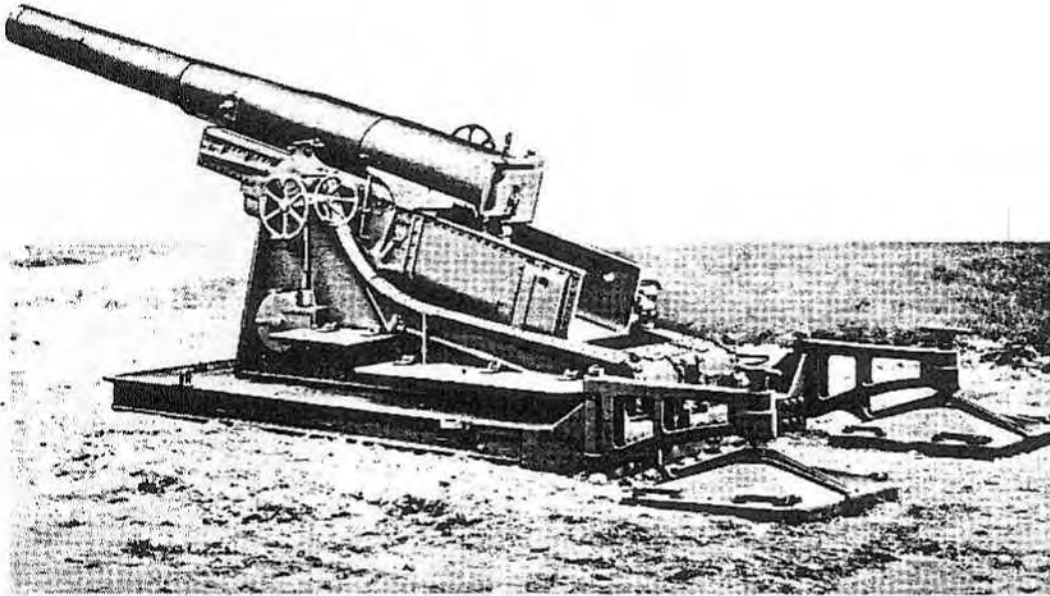

LEFT SIDE

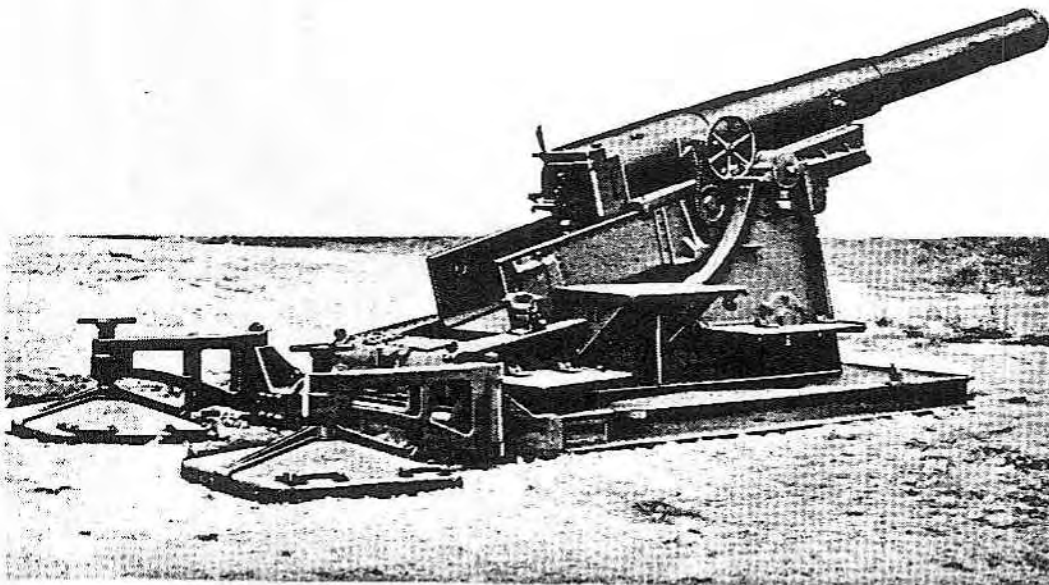

RIGHT SIDE

RA PD 72102

Figure 2 — 240-mm Howitzers M1918M1 and M1918M1A1, and Carriage M1918A2, Emplaced in Firing Position — Three-quarter Rear Views

INTRODUCTION

b. Carriage.

(1) The 240-mm Howitzer Carriage M1918A2 (figs. 1 and 2) consists of the platform, top carriage, sleigh, and cradle. When in firing position, the platform rests on the ground with the trunk portion imbedded in the ground to serve as a spade for absorbing the reaction of the recoiling parts. The platform is stabilized by two hinged outriggers resting on floats at the rear.

(2) The howitzer interlocks with the sleigh which houses the recoil mechanism. The howitzer has a range movement in elevation from 1 degree depression to 60 degrees elevation, and a traverse range of 10 degrees to the right or left of midposition.

(3) The howitzer is equipped with recoil mechanism of the Schneider hydropneumatic long recoil direct contact type, with which the howitzer is allowed sufficient length of recoil to insure stability at low angles of elevation. While the length of recoil is constant, the actual allowable recoil length ranges according to nitrogen pressure from 44.83 inches (1,138 mm) minimum to 46.73 inches (1,187 mm) maximum. The recoil fluid for the recoil cylinders and recuperator system is a 60-40 glycerine-water mixture. The recuperator cylinders also contain nitrogen under pressure.

c. **Transport Wagons.** Two high-speed transport wagons are used to transport the materiel. Transport Wagon M4 carries the howitzer, sleigh, and cradle assembled together as a single unit (fig. 3); while Transport Wagon M5 carries the top carriage and platform assembly (fig. 4). These transport wagons are of the 4-wheel trailer unsprung type, with dual wheels on the rear axle, provided with combat tires, air brakes, and electric blackout tail lights. When limbered to a prime mover, each transport wagon with load can be drawn at speeds up to 30 miles per hour on improved roads.

d. **Truck-mounted Crane M2.** The 20-ton capacity Truck-mounted Crane M2 (fig. 67), is provided for handling the howitzer and carriage assemblies when emplacing the materiel or mounting it on the transport wagons in traveling position. This crane is highly maneuverable and is transported at high speeds under its own power (par. 22).

e. **Clamshell Trailer M16.** A clamshell is provided with the crane for digging the pit in which the weapon platform is emplaced. This clamshell is transported in Clamshell Trailer M16 (par. 23).

3. DIFFERENCES AMONG MODELS.

a. **Howitzer.** The differences among the 240-mm Howitzers M1918, M1918MI, and M1918MIA1, as well as the means of identification of the various models, are given in paragraph 5.

240-MM HOWITZERS M1918MI AND M1918MIA1, 240-MM HOWITZER
CARRIAGE M1918A2, AND TRANSPORT WAGONS M4 AND M5

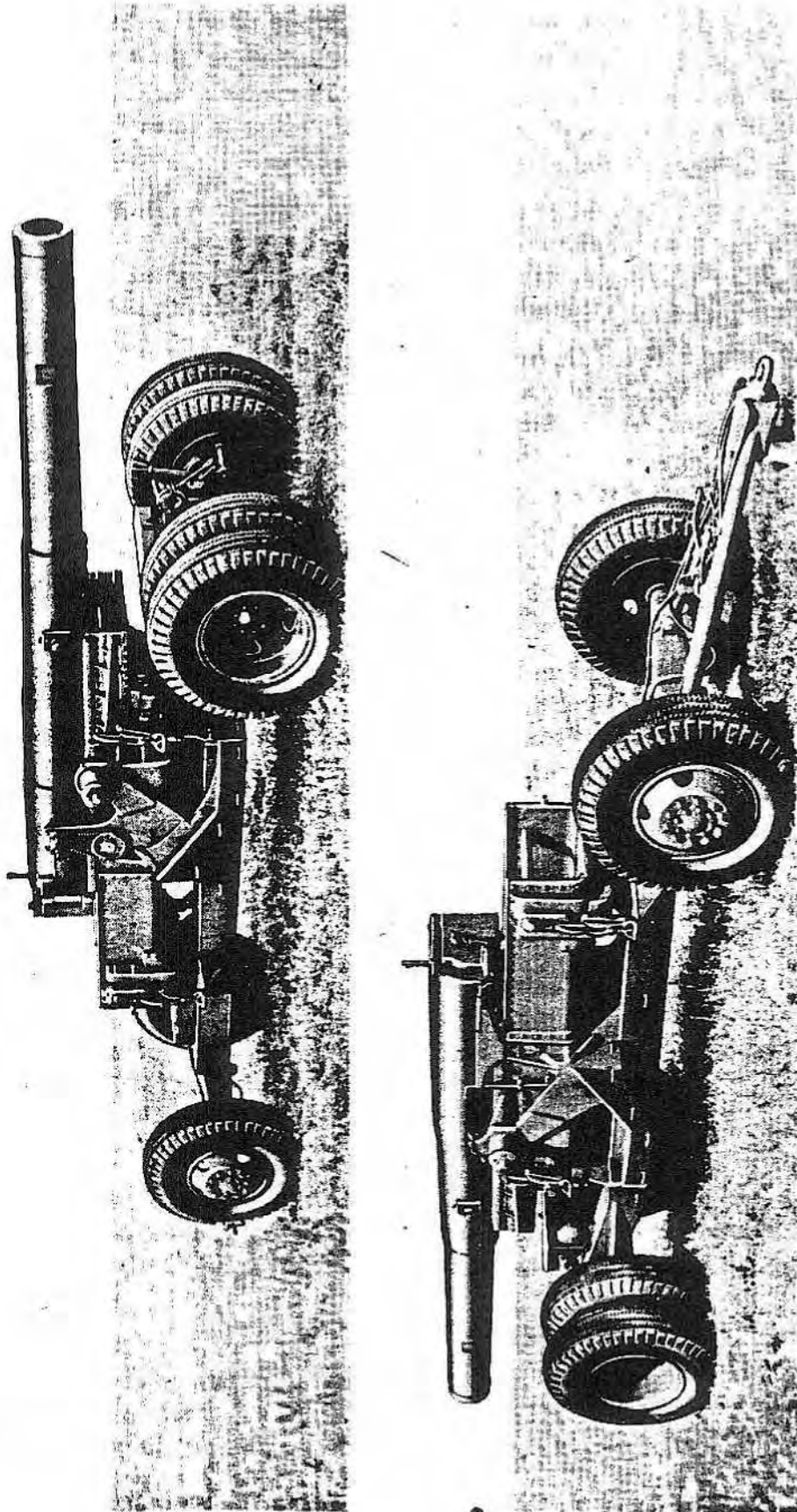

RA PD 72103

Figure 3 — Howitzer, Sleigh, and Cradle Assembly in Traveling Position on Transport Wagon M4 —
Three-quarter Front and Rear Views

INTRODUCTION

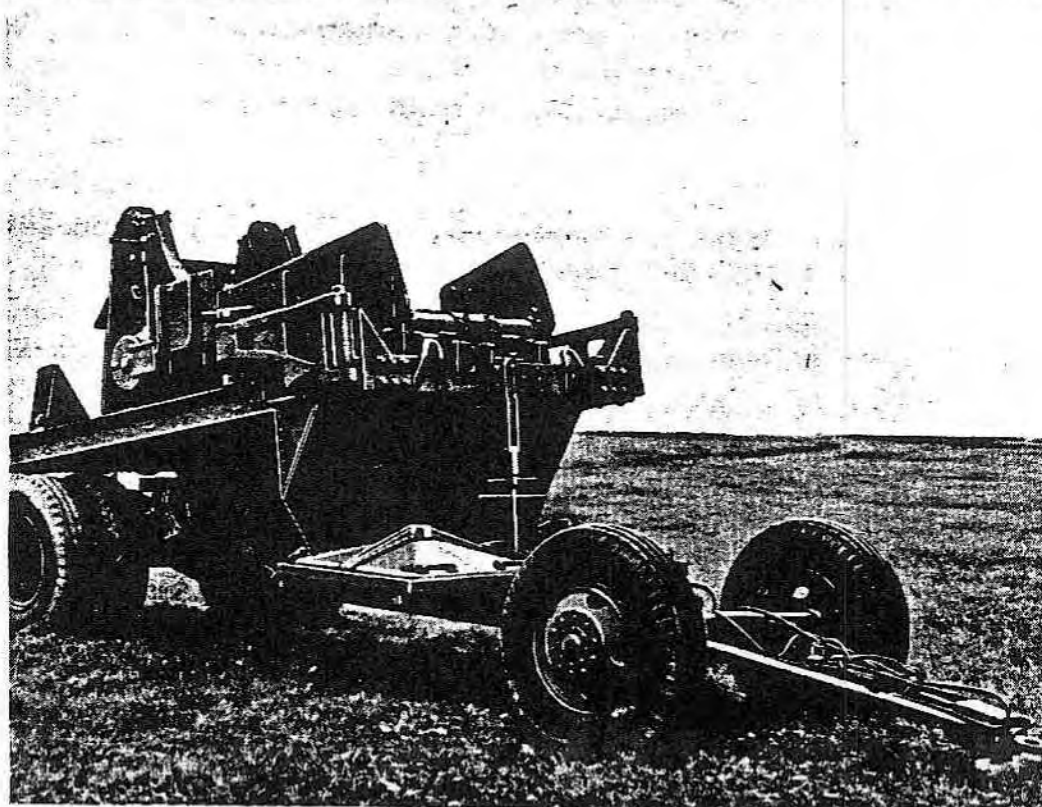
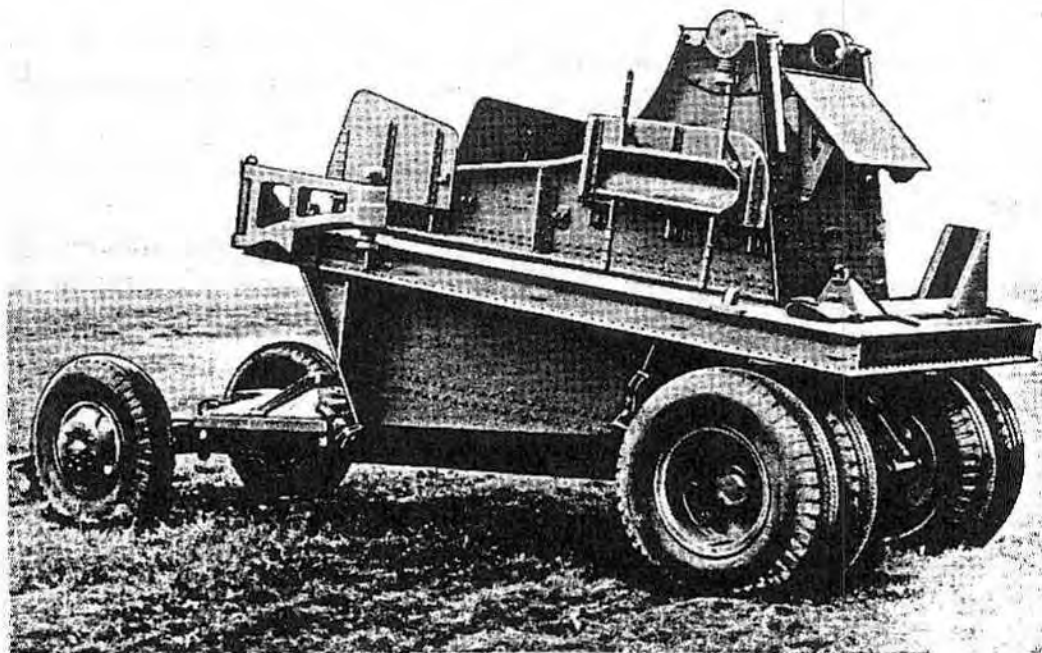

RA PD 72104

Figure 4 – Top Carriage and Platform Assembly in Traveling Position on Transport Wagon M5 – Three-quarter Front and Rear Views

240-MM HOWITZERS M1918MI AND M1918MIA1, 240-MM HOWITZER CARRIAGE M1918A2, AND TRANSPORT WAGONS M4 AND M5

b. Carriage.

(1) The 240-mm Howitzer Carriage M1918 was designed for slow-speed transportation. The materiel, when dismantled for transportation, was divided into four loads, namely, the howitzer, the sleigh and cradle, the top carriage, and the platform. Each load required a limber and its own transport wagon.

(2) When modified for high-speed transportation and designated M1918A2, certain brackets and mounting and transport equipment were altered or replaced by different type mechanism to adapt the materiel for loading on two high-speed transport wagons.

(3) The loading crane mechanism, rammer car, and shot truck used with the 240-mm Howitzer Carriage M1918, are not supplied with the 240-mm Howitzer Carriage M1918A2. Loading is accomplished by hand with this modified materiel.

c. Transport Wagons. The modified 240-mm Howitzers M1918MI and M1918MIA1 and Carriage M1918A2 are transported in two loads on high-speed Transport Wagons M4 and M5. These transport wagons are equipped with disk wheels and combat tires. They are also provided with air brakes and electric blackout tail-lights which are controlled from the prime movers.

4. DATA.

a. Weights, Dimensions, and Ballistics of the 240-mm Howitzers M1918MI and M1918MIA1.

Weight of howitzer	10,790 lb
Weight of breechblock	340 lb
Caliber	240 mm or 9.449 in.
Length of bore	19.75 calibers
Total length of howitzer.....	199.6 in.
Height, over-all at maximum elevation with weapon emplaced	192 in.
Powder chamber:	
Diameter	9.82 in.
Length	21.55 in.
Capacity	1,790 cu in.
Rifling:	
Length	156.369 in.
Number of grooves.....	68
Twist.....	Right-hand, one turn in 40 calibers at origin, increasing to one turn in 20 calibers at 24.369 inches from muzzle, and uniform there- after

INTRODUCTION

Muzzle velocity	1,700 ft per sec
Muzzle energy	6,920 ft-tons
Powder charge, kind	{ Nitrocellulose (NC) Nonhygroscopic (NH)
Density of loading	0.58
Maximum powder pressure	32,000 lb per sq in.
Weight of projectile	345 lb
Weight of powder charge	36 lb 7 oz
Travel of projectile in barrel	165.06 in.
Maximum range (approx.)	16,400 yd
Rate of fire:	
Rapid burst	1 round per min
Prolonged firing	1 round every 2 min
Length of recoil:	
Minimum	44.83 in. (1,138 mm)
Normal	44.88 in. (1,140 mm)
Maximum	46.73 in. (1,187 mm)
Recoil mechanism:	
Type	Hydropneumatic
Type of recoil fluid	60 per cent glycerin } by 40 percent water } volume
Recoil cylinder capacity	35¼ gal
Initial gas pressure at 70 F	568 lb per sq in.
Type of breechblock	Interrupted screw

b. General Data Pertaining to the 240-mm Howitzer Carriage M1918A2 and Transport Wagons M4 and M5.

Weights:

Howitzer, sleigh, and cradle assembly	21,787 lb
Howitzer	10,790 lb
Sleigh	5,747 lb
Cradle	5,250 lb
Top carriage and platform assembly	16,990 lb
Top carriage	8,640 lb
Platform	11,190 lb
Float	400 lb
Transport Wagon M4	7,950 lb
Transport Wagon M5	8,450 lb
Wheel, complete with tire	420 lb
Transport Wagon M4, with load	29,737 lb
Transport Wagon M5, with load	29,080 lb

TM 9-340

4

240-MM HOWITZERS M1918MI AND M1918MIA1, 240-MM HOWITZER CARRIAGE M1918A2, AND TRANSPORT WAGONS M4 AND M5

Dimensions:

Maximum width, traveling position:

Transport Wagon M4, with load	105 in.
Transport Wagon M5, with load (measured over outriggers)	107 in.

Maximum height, traveling position:

Transport Wagon M4, with load (measured to top of breech operating lever grip)	86 in.
Transport Wagon M5, with load (measured to top of trunnion bearing caps)	125 in.

Length over-all, traveling position:

Transport Wagon M4, with load	365 in.
Transport Wagon M5, with load	316 in.

Width of track, center to center of tire threads:

Front wheels	74½ in.
Rear wheels, inner	58½ in.
Rear wheels, outer	92 in.

Turning radius (outside front wheel)

Wheelbase

Road clearance (measured under front axle pivot pin)

Tire size

Tire air pressure

Air brake pressure

Maneuvers:

Elevation

Depression

Turns of handwheel for 1-degree movement in elevation

Turns of the quick-loading mechanism for 45-degree movement in elevation

Traverse to right or left of mid-position

Turns of handwheel for 1-degree movement in azimuth

c. Sighting Equipment.

Panoramic telescope

Quadrant sight

d. Fire Control Equipment.

Aiming circle

Azimuth instrument

B.C. telescope

CHAPTER 2

**HOWITZER, CARRIAGE, TRANSPORT WAGONS, CRANE,
AND CLAMSHELL TRAILER**

Section I

DESCRIPTION AND FUNCTIONING OF HOWITZER**5. 240-MM HOWITZERS M1918MI AND M1918MIA1.**

a. There are several models of 240-mm howitzers, which are designated M1918, M1918MI, and M1918MIA1. The M1918MI Howitzer differs from the M1918 Howitzer only by an increase in the exterior diameter of the tapered portion of the barrel forward of the hoop, necessitating the use of different front roller spindles and fastening screws when carried on early type transport wagon and limber having solid rubber tires.

b. The M1918 Howitzers are numbered 1 to 182, inclusive, and the M1918MI Howitzers from 183 to 330, inclusive, and are of Watervliet Arsenal manufacture. These howitzers were originally rifled alike, but a different form of rifling, in which the grooves are made slightly wider and the lands narrower, has been adopted, and when applied to the M1918MI Howitzer, they will be known as M1918MIA1. The M1918MI and M1918MIA1 Howitzers are further modified for high-speed transportation. The model number however, is not changed on these howitzers but they may be identified as follows:

(1) Both front rollers have been removed from the front end of the howitzer tube (fig. 5). These rollers were used in mounting and dismounting the howitzer when carried on the old type transport wagon and limber.

(2) Both rear rollers on the howitzer hoop have been removed and replaced by thimbles (fig. 5) which are used for lifting purposes when emplacing the weapon and when loading it on the transport wagon.

(3) Stamped on the rear face of the breechblock carrier are instructions not to open the breech at an elevation greater than 15 degrees (260 mils) (fig. 6). The previous instructions were not to open the breech at an elevation greater than 9 degrees 30 minutes, with the earlier type loading equipment.

c. The howitzers are marked on the muzzle end of the tube (fig. 7) with the caliber, number and model, name of manufacturer, year of manufacture, weight of howitzer, and initials of inspector. The breech face (fig. 8) is marked with the caliber, model, name of

240-MM HOWITZERS M1918MI AND M1918MIA1, 240-MM HOWITZER CARRIAGE M1918A2, AND TRANSPORT WAGONS M4 AND M5

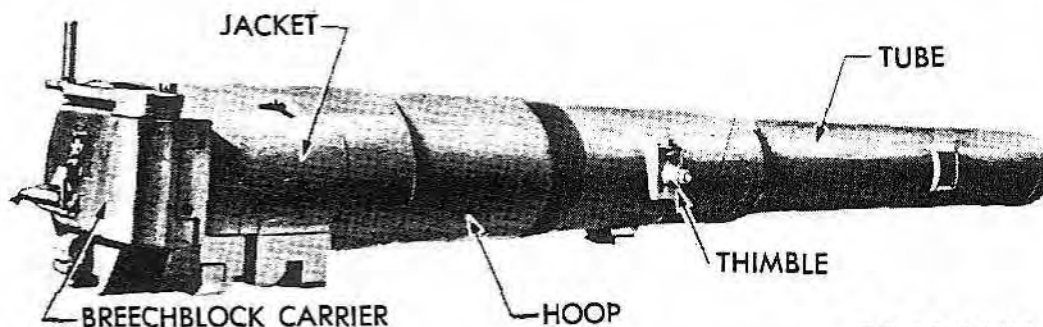

RA PD 22486

Figure 5 - The 240-mm Howitzers M1918M1 and M1918M1A1, With Breech Mechanism

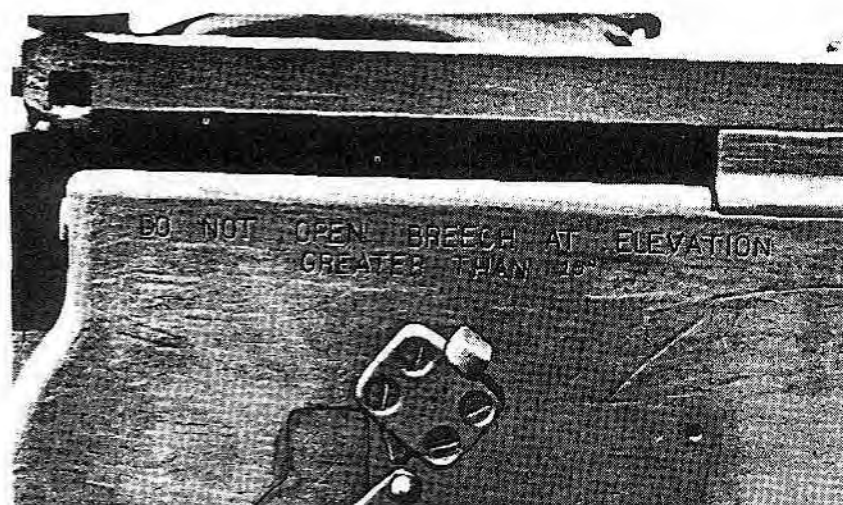

RA PD 72106

Figure 6 - Rear Face of Breechblock Carrier, Showing Caution on Opening Breech

manufacturer, year of manufacture, and the name of the manufacturer of the forgings. Horizontal and vertical center lines are scribed on the breech and muzzle faces for bore sighting purposes, and axis lines are marked on the left side of the breech and muzzle.

d. The barrel of the 240-mm Howitzers M1918MI and M1918-MIA1, is of the built-up type and consists of the tube, hoop, and jacket (fig. 5). The hoop and jacket are expanded by heat and then screwed on the tube and held rigid by shrinkage. The tube bore is slightly enlarged at the rear end to form the powder chamber. From this chamber to the muzzle, the bore is rifled with a right-hand twist of one turn in 40 calibers at origin of rifling, increasing to one turn in 20 calibers at 24.369 inches from the muzzle end, and uniform thereafter. The extreme end of the bore at the breech end

HOWITZER, CARRIAGE, TRANSPORT WAGONS, CRANE,
AND CLAMHELL TRAILER



RA PD 72107

Figure 7 — Muzzle End of Howitzer Tube, Showing Identification Markings

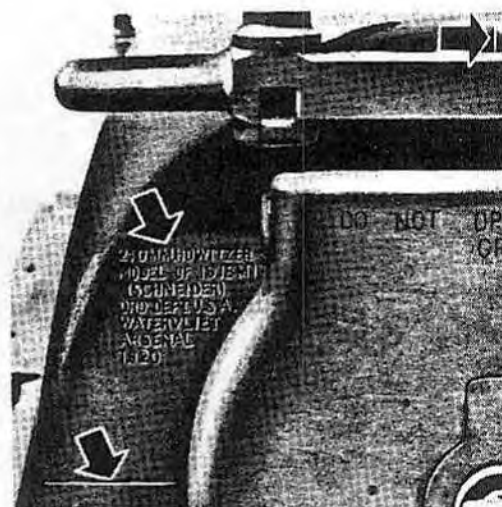

RA PD 72108

Figure 8 — Breech Face of Howitzer, Showing Identification Markings

of the tube is formed with threaded and plain sectors to receive the breechblock when in the closed position.

e. The howitzer has a thimble (fig. 9) on either side of the tube for mounting and dismounting purposes. These thimbles are retained in place on the supporting spindles with a slotted nut and cotter pin. The spindles fit into hollow box-like projections and are held in place by one screw each, which is prevented from turning by a lock bar at the top end.

f. A T-shaped lug on the bottom side of the hoop serves as a hold-down clip for the muzzle end of the howitzer.

g. The breech end of the howitzer is secured from longitudinal movement in the sleigh by means of locking wedges forced between the lugs on the bottom side of the jacket. These locking wedges are operated by a screw through an opening in the left side of the sleigh.

h. A lug is provided on the right side of the howitzer jacket to support the breechblock carrier. The operating lever latch plate fits into the breech face and secures the breech mechanism in closed position. The breech mechanism is held in open position by means of the operating lever latch bracket on the upper right side of the howitzer jacket.

i. Jacket dust cover, attached to either side of the howitzer jacket with machine screws, protects the interior of the sleigh.

j. Two leveling plates (fig. 10) are located at the top center

240-MM HOWITZERS M1918MI AND M1918MIA1, 240-MM HOWITZER CARRIAGE M1918A2, AND TRANSPORT WAGONS M4 AND M5

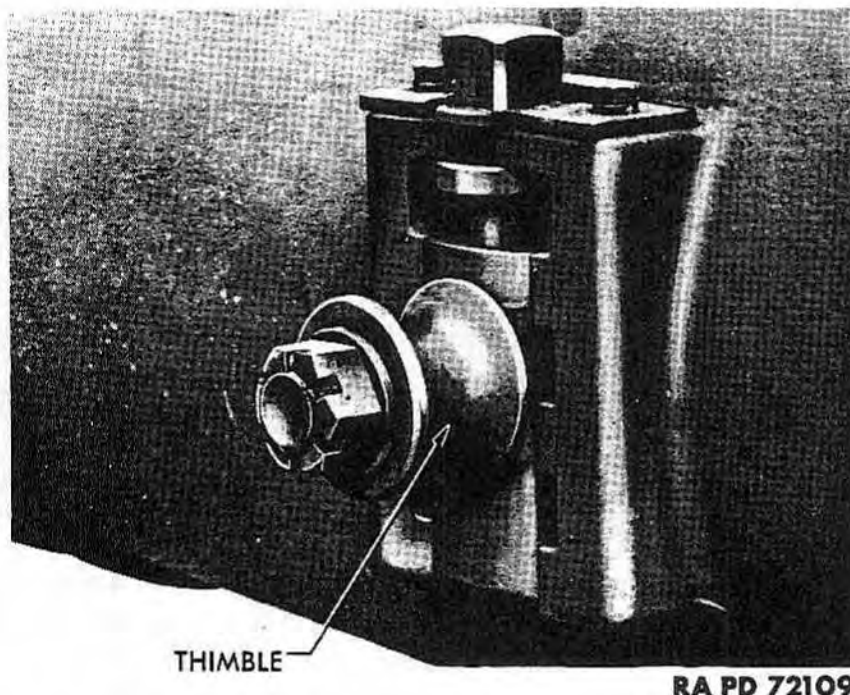

Figure 9 — Lifting Thimble on Side of Howitzer Hoop

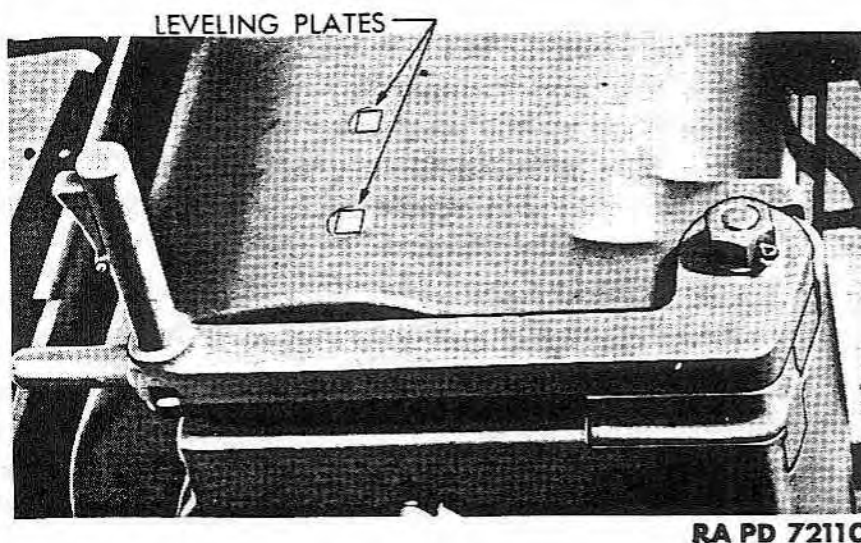

Figure 10 — Leveling Plate on Top of Howitzer Jacket

line of the jacket and form a level surface in alignment with the bore of the howitzer for applying a gunner's quadrant.

6. BREECH MECHANISM.

a. The breech mechanism (fig. 11) comprises the following parts: the breechblock, the breechblock carrier, the operating lever, the obturator assembly, the firing mechanism, and the percussion mecha-

HOWITZER, CARRIAGE, TRANSPORT WAGONS, CRANE,
AND CLAMSHELL TRAILER

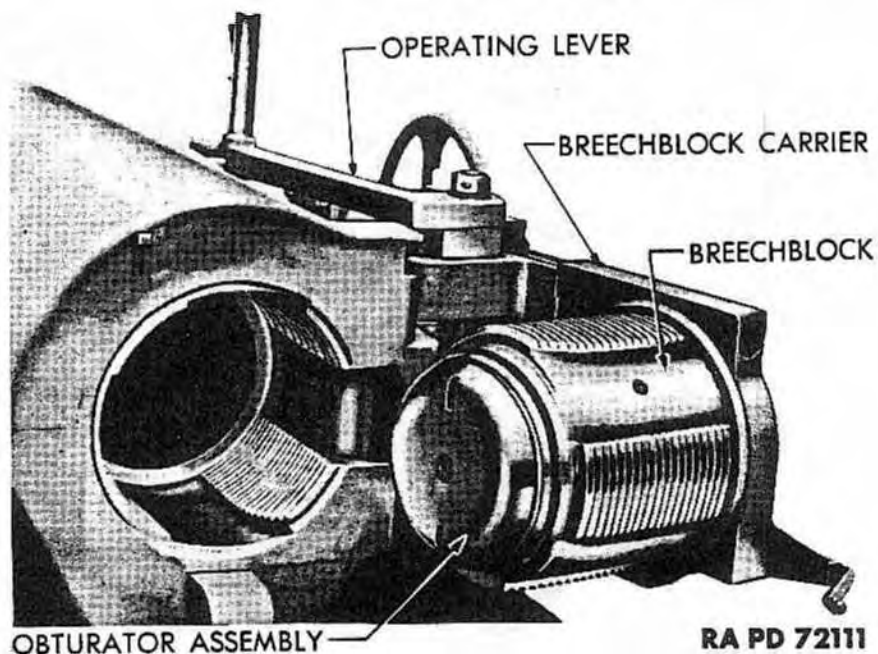

Figure 11 – Breech in Open Position

nism. The breech mechanism is hand-operated and designed for separate-loading ammunition.

b. Breechblock.

(1) The breechblock (fig. 12) is of the cylindrical interrupted screw type, with four threaded and four plain sectors. The arrangement of the threads permits the breechblock to be locked or unlocked by being rotated one-eighth of a turn. Suitable clearance is provided on the breechblock and in the breech recess to permit the breechblock to enter the breech recess without interference. The exterior threads of the breechblock are continuous at the rear for screwing into breechblock carrier, except at the point where the gear teeth are formed for rotating the breechblock by means of the rack.

(2) The breechblock is bored to receive the obturator spindle at the forward end and the rear end fits over the pintle in the breechblock carrier. A depression at the rear edge of this bore is formed into a cam surface to operate the firing mechanism safety plunger upon rotation of the breechblock.

(3) The breechblock assembling stud, located in the breech face of the breechblock, forms a stop to locate the breechblock in position for assembling the rack.

c. Obturator.

(1) The obturator assembly (fig. 13) consists of the obturator spindle with obturator spindle vent bushing, obturator spindle plug,

240-MM HOWITZERS M1918MI AND M1918MIA1, 240-MM HOWITZER
CARRIAGE M1918A2, AND TRANSPORT WAGONS M4 AND M5

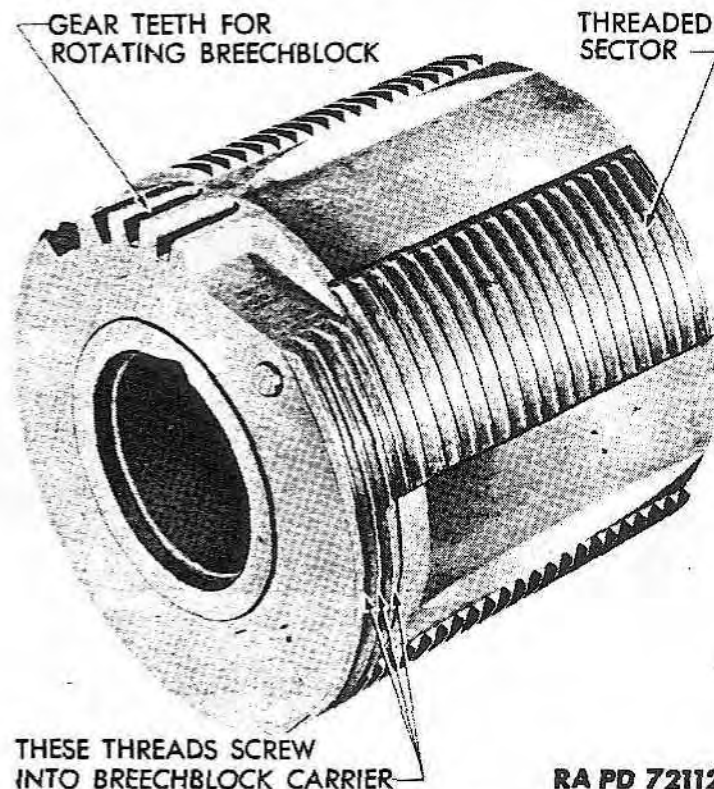

RA PD 72112

Figure 12 — Breechblock Showing Threads and Gear Teeth

and plug gasket, front and rear split rings, inner ring, filling-in disk, gas-check pad, and the obturator spindle spring together with its associated parts.

(2) The rings, pad, and disk are assembled under the head of the obturator spindle against the front face of the breechblock and serve to seal the rear of the powder chamber against the rearward escape of powder gases when the howitzer is fired. The obturator spindle is drilled centrally front to rear to permit flame from a primer, seated in the plug at the rear end of the spindle, to enter the powder chamber of the howitzer and ignite the charge to fire the weapon.

(3) The obturator spindle (fig. 14) has a mushroom-shaped head and cylindrical stem which fits into the pintle of the breechblock carrier. The rear surface of the head is slightly coned to fit the front split ring and gas-check pad. The rear end of the obturator spindle screws into the firing mechanism housing in the breechblock carrier, and is keyed in position to prevent unscrewing. Slots in the head of the obturator spindle are provided for using a wrench when removing and installing the spindle mechanism.

(4) The breech (rear) end of the spindle is threaded internally to receive the obturator spindle plug and gasket. The obturator spindle vent bushing is screwed very tightly into the front end, or

HOWITZER, CARRIAGE, TRANSPORT WAGONS, CRANE,
AND CLAMSHELL TRAILER

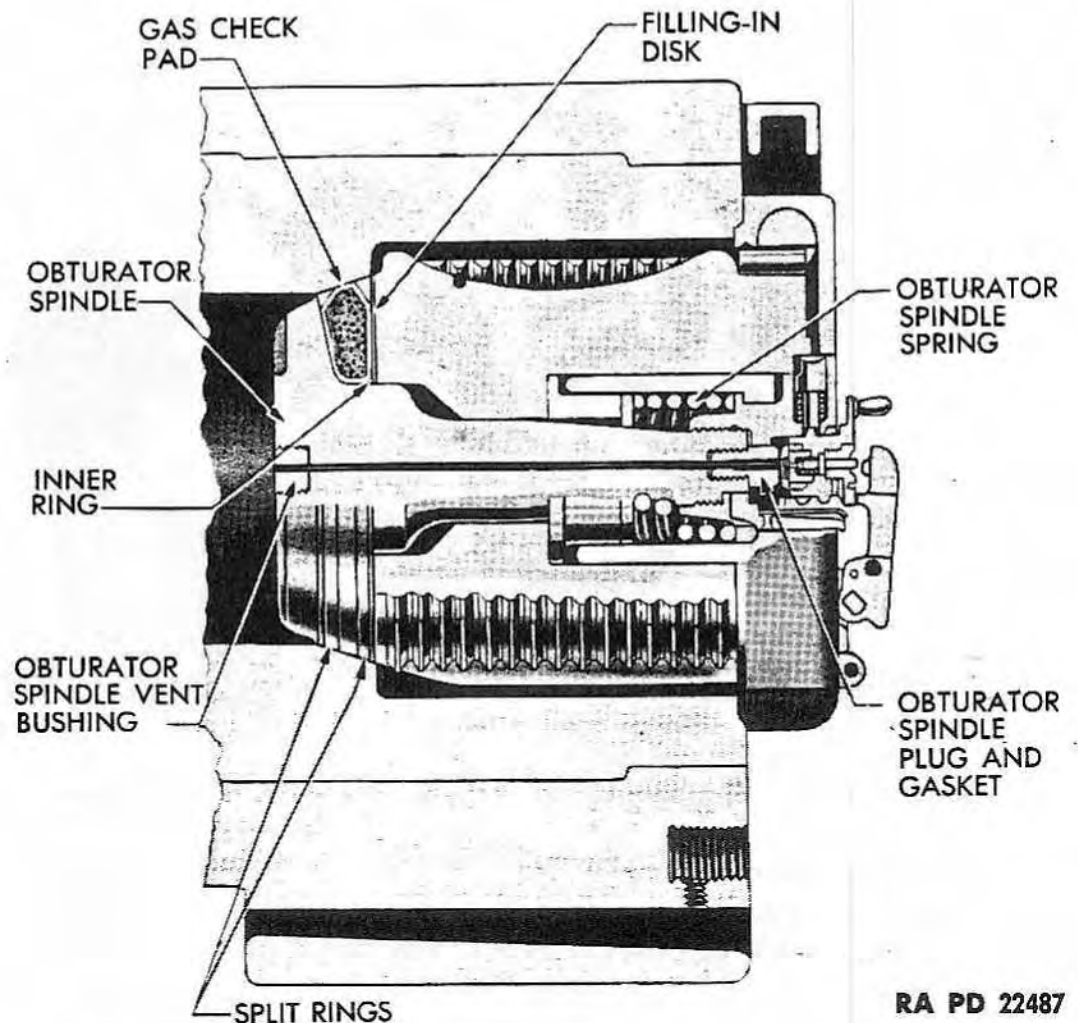

RA PD 22487

Figure 13 – Obturator Mechanism – Cut-away View

head of the obturator spindle. The vent hole, which conducts the flame from the primer, passes through the center of the bushing and the spindle and connects with the chamber in the obturator spindle plug.

(5) The gas-check pad is composed of three parts asbestos and one part nonfluid oil, enclosed in canvas or wire screen. The pad is subjected to extreme pressure when it is formed. When the weapon is fired, the chamber pressure forces the mushroom head of the obturator spindle to the rear, causing the gas-check pad to be compressed longitudinally and expanded radially. This causes the two outer split rings to be expanded, and to fit tighter against the gas-check pad seat, thus sealing the gases inside the powder chamber. The inner ring fits around the obturator spindle at the rear of the gas-check pad. It prevents the gas-check pad from being forced out between obturator

240-MM HOWITZERS M1918MI AND M1918MIA1, 240-MM HOWITZER CARRIAGE M1918A2, AND TRANSPORT WAGONS M4 AND M5

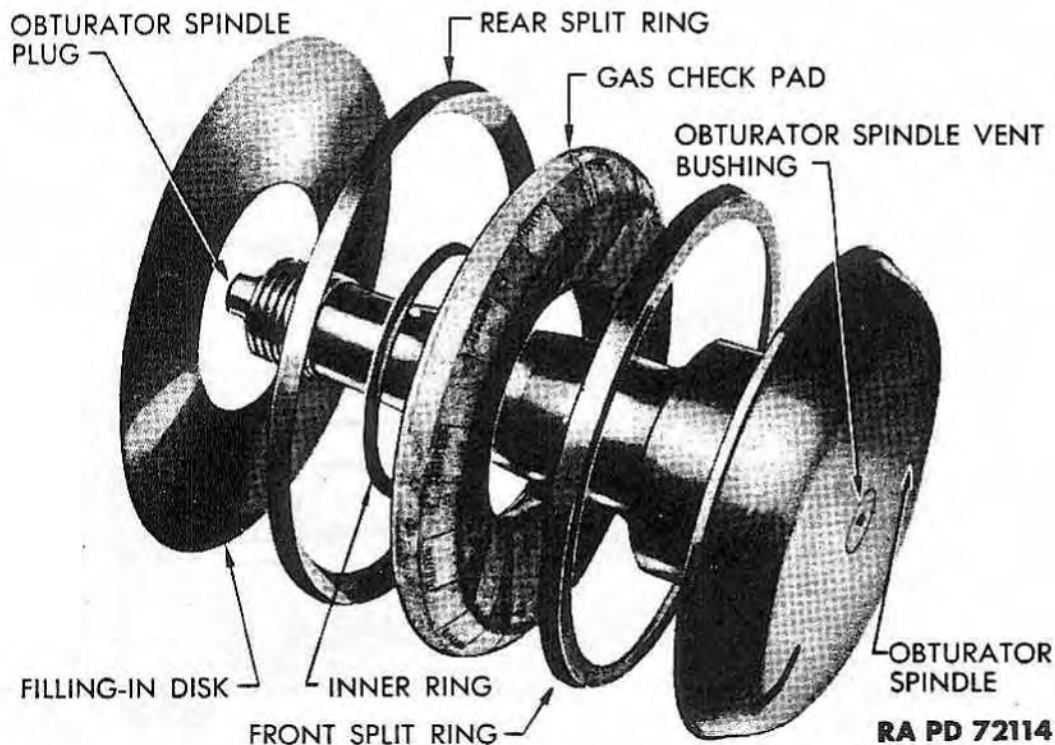

Figure 14 – Obturator Spindle Assembly – Exploded View

spindle and the filling-in disk. The pad is assembled on the obturator spindle between the mushroom-shaped head of the spindle and the filling-in disk, against the face of the breechblock.

(6) The filling-in disk (fig. 14) acts as a washer between the moving parts. It protects the gas-check pad from abrasion by the breechblock and the breechblock from abrasion by the rear split ring, and must never be omitted. An additional disk may be installed if necessary, to obtain a tighter seat for the gas-check pad.

(7) The front and rear split rings are triangular in cross section and are coned on the outer diameter to correspond to the angle of the gas-check seat in the chamber of the howitzer. They are made slightly larger in diameter than the point at which they are designed to seat, and being split, conform to the smaller diameter when compression is applied.

(8) The inner ring is similar to the front and rear split rings, but is not split. It protects the gas-check pad at the rear edge of its inner diameter.

(9) The obturator spindle spring is helical. It is located in the bore of the breechblock carrier between the front and rear spring seats (fig. 153). Its purpose is to provide the necessary force to hold the gas-check pad, rings, and disk firmly against the obturator spindle head.

HOWITZER, CARRIAGE, TRANSPORT WAGONS, CRANE,
AND CLAMSHELL TRAILER

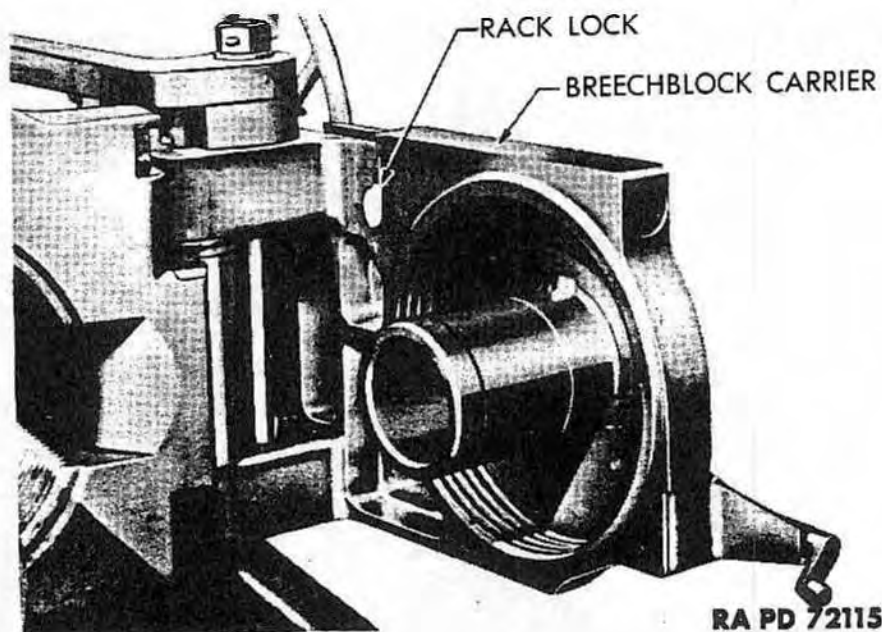

Figure 15 — Breechblock Carrier

(10) The obturator spindle spring front seat acts as a washer between the obturator spindle spring and spindle spring front seat collar. The collar fills the space between the front seat and the breechblock, providing required compression of the spring.

(11) The obturator spindle spring rear seat fills the space at the rear of the obturator spindle spring, and provides a seat for the spring against the firing mechanism housing.

d. Breechblock Carrier.

(1) The breechblock carrier (fig. 15) is a relatively thin-walled hinge member which supports the breechblock and its actuating parts. The breechblock carrier swings on the hinge lug of the howitzer jacket, and is secured in place by means of a suitable hinge pin. The operating lever shaft passes through an opening in the breechblock carrier to the rear of the breechblock carrier hinge pin and is retained in place by the operating lever shaft nut and cotter pin.

(2) The breechblock carrier hinge pin bushing is contained in a suitable opening in the upper lug of the breechblock carrier. The lower portion of this bushing rests upon the regulating plate and carries the weight of the breech mechanism. The bushing is held in place by the hinge pin bushing nut.

(3) The breechblock screws into a threaded recess in the muzzle face of the breechblock carrier, and turns through its arc of rotation upon a pintle formed in the center of the recess. This pintle is bored through the center to receive the obturator spindle spring and its

240-MM HOWITZERS M1918MI AND M1918MIA1, 240-MM HOWITZER CARRIAGE M1918A2, AND TRANSPORT WAGONS M4 AND M5

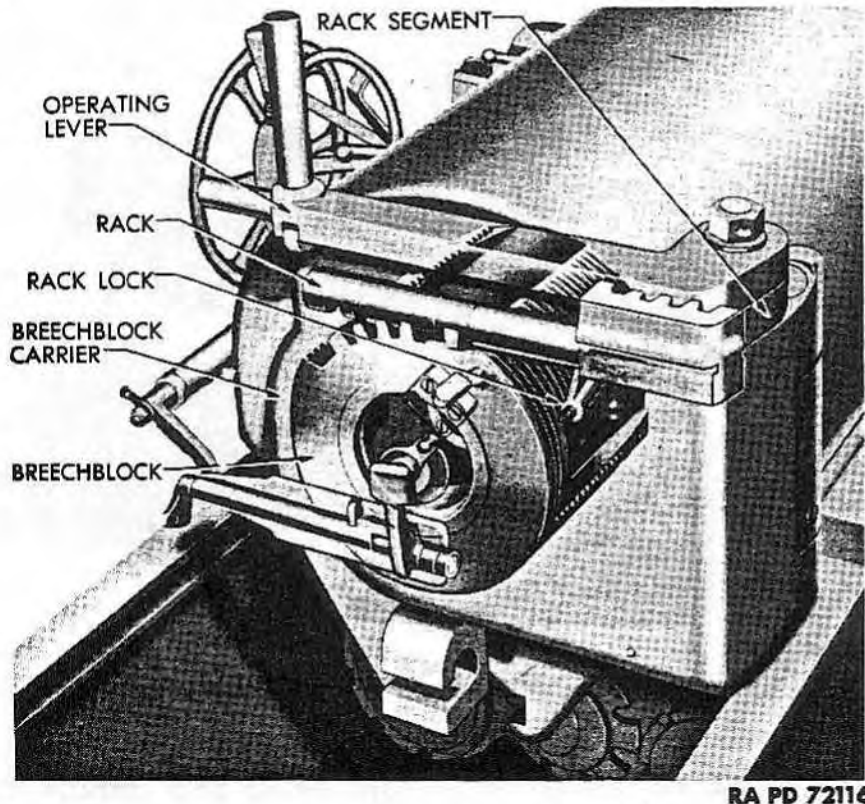

Figure 16 – Breech Mechanism – Phantom View

related parts at the front, while the rear contains the firing mechanism housing.

(4) The breechblock carrier assembling stud in the threaded recess forms a stop for a similar stud on the breechblock. These studs serve to locate the breechblock in the correct assembling position when it is installed in the breechblock carrier.

(5) A suitable hole provided in the breechblock carrier and extending from the right side into the interior, carries the rack for turning the breechblock. Turning of the breechblock when outside of the breech recess is prevented by means of a rack lock (fig. 15) and spring in the inclined pocket in the muzzle face of the breechblock carrier.

(6) The percussion hammer mechanism is mounted on the bottom part of the breech (rear) face of the breechblock carrier. The firing mechanism block latch is also attached to the upper right side of this surface of the breechblock carrier.

e. Breechblock Actuating Mechanism.

(1) **RACK.** The rack (fig. 16) is located in the upper part of the breechblock carrier and serves to rotate the breechblock for locking and unlocking purposes. This is accomplished by means of teeth at the

HOWITZER, CARRIAGE, TRANSPORT WAGONS, CRANE, AND CLAMSHELL TRAILER

inner end of the rack engaging similar teeth on the breechblock. Consequently, any endwise movement of the rack is transmitted to the breechblock, turning it to the open or closed position. Teeth at the outer end of the rack engage the gear teeth of the rack segment.

(2) **RACK SEGMENT.** The rack segment fits over the hub of the breech operating lever, and is keyed so that it turns with the lever. Teeth in the rack segment mesh with those in the outer end of the rack to actuate the rack.

(3) **RACK LOCK.** The rack lock is located in an inclined pocket in the front face of the breechblock carrier. When the breech is opened, the rack lock spring forces the rack lock upward, causing it to protrude beyond the face of the breechblock carrier. As the lock is raised, it engages with a slot in the under side of the rack, preventing the rack from movement until the breech is closed again.

(4) OPERATING LEVER.

(a) The operating lever performs the function of rotating the breechblock to disengage or engage it with the threads in the breech end of the barrel, and swinging the mechanism as a whole, about the hinge pin for opening and closing the breech.

(b) The operating lever is mounted on the operating lever shaft and engages with the shaft through three keys in the opening of the lever hub. The rack segment is keyed to the exterior of the hub, to operate with the operating lever.

(c) The outer end of the operating lever has both a horizontal and vertical grip to provide for grasping and rotating the lever. The vertical grip is hollow, and contains the operating lever handle, handle spring, and the operating lever handle spring plug which screws on the end of the handle and retains the parts within the grip. The operating lever handle nut fits over the top of the grip. The operating lever trigger is located in an opening at the side of the grip and pivots on the operating lever trigger screw between two projecting lugs. The short arm of the trigger projects into an opening in the side of the operating lever handle spring plug to operate the handle when the trigger is pressed, freeing the operating lever from the lever latch plate.

(5) **OPERATING LEVER SHAFT.** The shaft for the operating lever passes through a hole in the breechblock carrier, just to the rear of the hinge pin (fig. 17). The lower end of the shaft is provided with four gear teeth which engage with corresponding teeth in the hinge pin, to pull the carrier away from the breech face of the howitzer. The upper end of the shaft has three spaces which engage with the three keys in the end of the breech operating lever. One space is slightly wider than the others to insure correct assembly of the operating lever

240-MM HOWITZERS M1918MI AND M1918MIA1, 240-MM HOWITZER CARRIAGE M1918A2, AND TRANSPORT WAGONS M4 AND M5

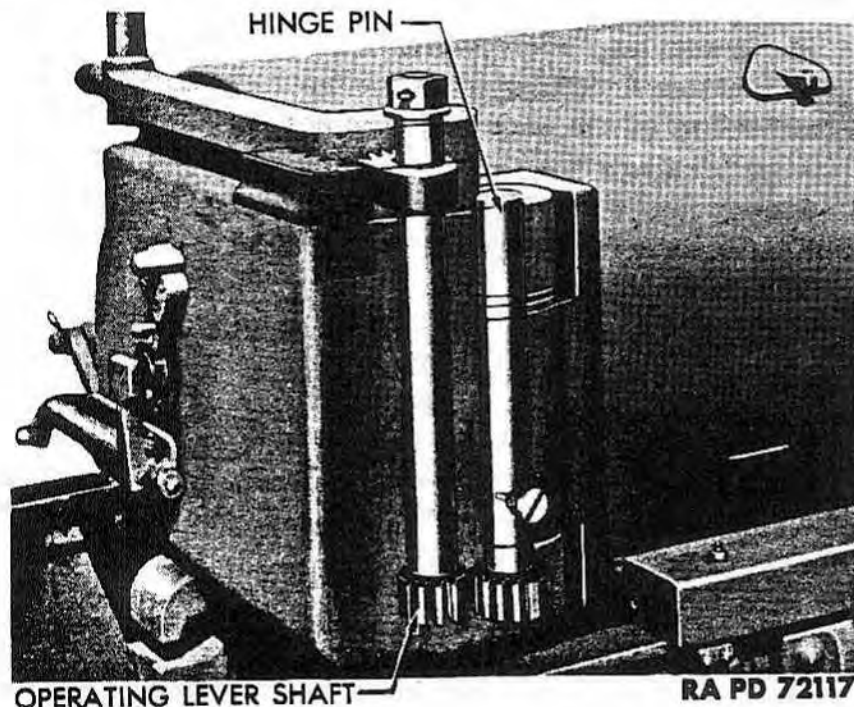

Figure 17 — Operating Lever Shaft and Breechblock Carrier Hinge Pin

on the shaft. The operating lever is secured to the shaft by means of a washer, nut, and cotter pin.

(6) **HINGE PIN.** The hinge pin (fig. 17) hinges the breechblock carrier to the howitzer jacket and extends upward through the hinge lugs of both the carrier and the jacket. A screw inserted through the hinge lug of the jacket and into the hinge pin keeps the hinge pin from turning, thus keeping the teeth at the lower end of the hinge pin in proper mesh with those on the operating lever shaft.

f. Firing Mechanism Housing.

(1) The firing mechanism housing (fig. 18) located in the breechblock carrier is threaded at both front and rear ends. The obturator spindle screws into the front and the firing mechanism into the rear.

(2) A projection at the top of the firing mechanism housing contains the firing mechanism safety plunger and spring. The safety plunger is retained in position by the firing mechanism housing screw.

(3) A keyway in the exterior of the housing on the lower side is provided for the firing mechanism housing key to be moved in and out of engagement with the obturator spindle. The key is retained in position by means of a stud on the firing mechanism housing key spring.

g. Firing Mechanism Housing Key. The firing mechanism housing key slides a short distance in the keyway in the firing mechanism

HOWITZER, CARRIAGE, TRANSPORT WAGONS, CRANE, AND CLAMSHELL TRAILER

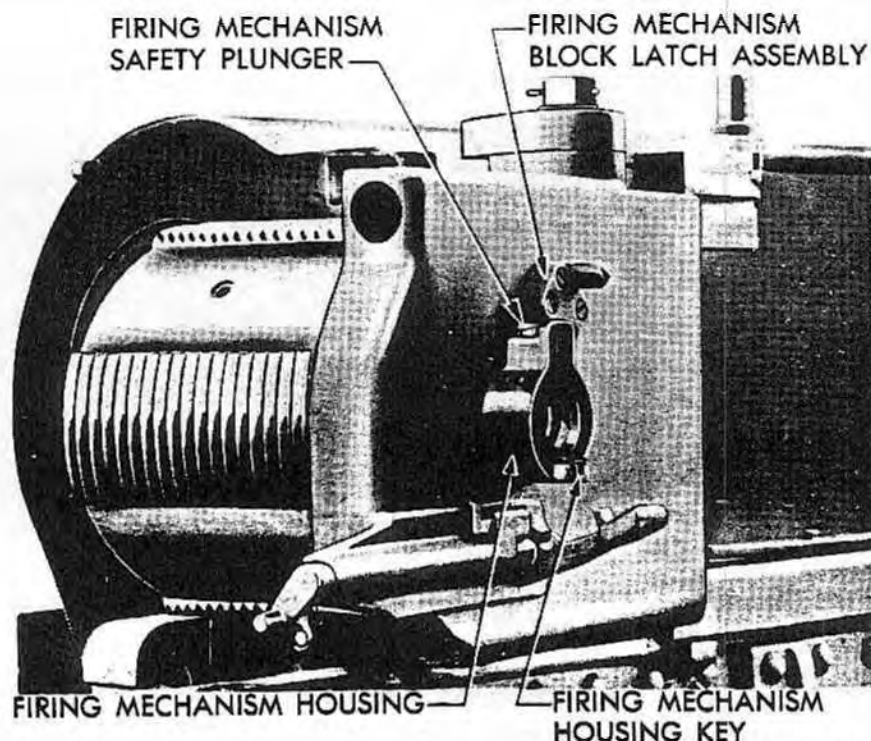

RA PD 72118

Figure 18 — Firing Mechanism Housing Partly Removed

housing to engage or disengage with the keyway in the end of the obturator spindle. The firing mechanism housing key spring is riveted to the key and the firing mechanism housing key spring stud is riveted to the spring.

h. Firing Mechanism Block Latch Assembly. The firing mechanism block latch with spring and handle is assembled to the firing mechanism block latch holder which is attached to the rear face of the breechblock carrier with four screws (fig. 18). Its purpose is to locate and lock the firing mechanism in proper position in the housing for firing the howitzer. The latch is beveled on one side for easy installation of the firing mechanism. When this mechanism is installed, its handle strikes the beveled side of the latch, depressing the latch against spring action and allowing the handle to pass. To remove the firing mechanism, the latch must be depressed by hand.

CAUTION: It is possible to insert the firing mechanism partially before closing the breechblock. This practice is strictly prohibited.

i. Percussion Mechanism.

(1) The percussion mechanism (fig. 19) is mounted on the lower rear face of the breechblock carrier and consists of the percussion hammer, percussion hammer operating shaft, operating shaft housing, and the percussion hammer lock bolt.

240-MM HOWITZERS M1918MI AND M1918MIA1, 240-MM HOWITZER CARRIAGE M1918A2, AND TRANSPORT WAGONS M4 AND M5

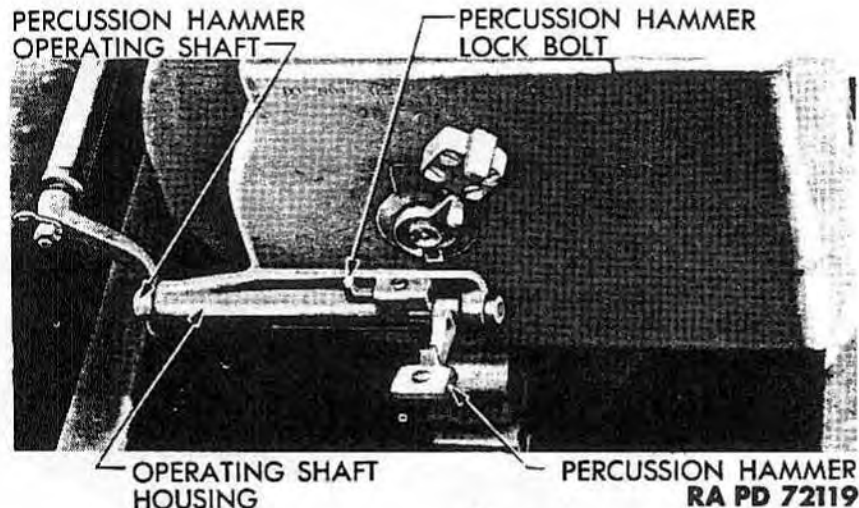

Figure 19 – Percussion Mechanism

(2) The percussion hammer is mounted on one end of the percussion hammer operating shaft and swings through an angle of 66 degrees. The mounting hole in the hub of the percussion hammer is formed with three square sides and one rounded side to insure correct assembly of the percussion hammer on the operating shaft. The hammer portion of the percussion hammer head is formed with a lug while a projection or spur below the lug provides a safety feature in connection with the rim on the rear face of the firing mechanism block. This prevents firing of the weapon unless the firing mechanism is fully screwed into position. A hole is provided in the side of the percussion hammer for engagement of the percussion hammer lock bolt to lock the percussion hammer in the traveling position.

(3) The percussion hammer and percussion hammer operating shaft assembly is supported by the percussion hammer operating shaft housing. The percussion hammer operating shaft is retained in the housing by the percussion hammer operating shaft collar and detent. A projecting arm at the outer end of the percussion hammer operating shaft is provided for attaching the lanyard and the round projection on the side of this arm contacts with the firing rod arm on the cradle for firing from the side of the weapon.

(4) The percussion hammer lock bolt operates in the square hole in the percussion hammer lock bolt housing. It contains the percussion hammer lock bolt spring which is secured by a screw in the recess in the bottom of the bolt. The spring recedes into the recess as the bolt is pressed into its seat in the housing. A round projection on the spring is provided to offer a slight resistance to the movement of the bolt by engaging into depressions in the bolt

HOWITZER, CARRIAGE, TRANSPORT WAGONS, CRANE,
AND CLAMSHELL TRAILER

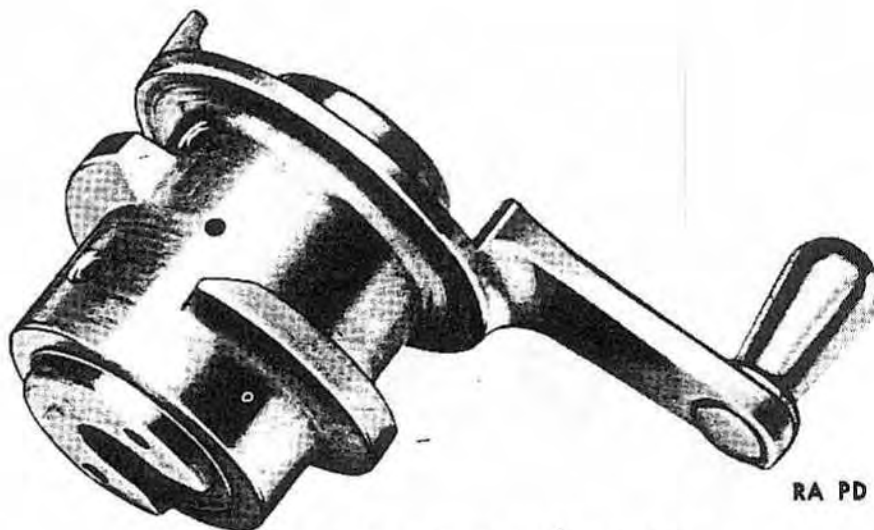

RA PD 72120

Figure 20 – Firing Mechanism M1918

seat and holds the bolt in the engaged or disengaged position. The slot in the upper side of the bolt receives the end of the percussion hammer lock bolt stop screw by which it is retained in the housing.

7. FIRING MECHANISM M1918.

a. The firing mechanism (fig. 20) is of the screw type, composed of the firing mechanism block assembly, firing pin, firing pin guide, firing pin housing, firing pin spring, and primer holder (fig. 21). Two safety set screws lock the primer holder and firing pin housing in position. The firing mechanism shoe is used under the safety set screw for the firing pin housing to prevent damaging the housing threads.

b. The firing mechanism block (fig. 21) consists of the block and handle and is threaded to screw into the firing mechanism housing, to a point where the handle passes the firing mechanism block latch with the breech closed.

c. The firing pin is supported by the firing pin guide. This pin, together with the firing pin spring, is retained in place at the rear by the firing pin housing.

d. The firing pin guide is located in the front end of the firing mechanism block and retained in place by the primer holder plug.

e. The firing pin housing is located at the rear end of the pin mechanism block and is retained in place by the firing pin housing screw. The firing mechanism shoe protects threads of the firing pin housing when the retaining set screw is tightened.

240-MM HOWITZERS M1918MI AND M1918MIA1, 240-MM HOWITZER
CARRIAGE M1918A2, AND TRANSPORT WAGONS M4 AND M5

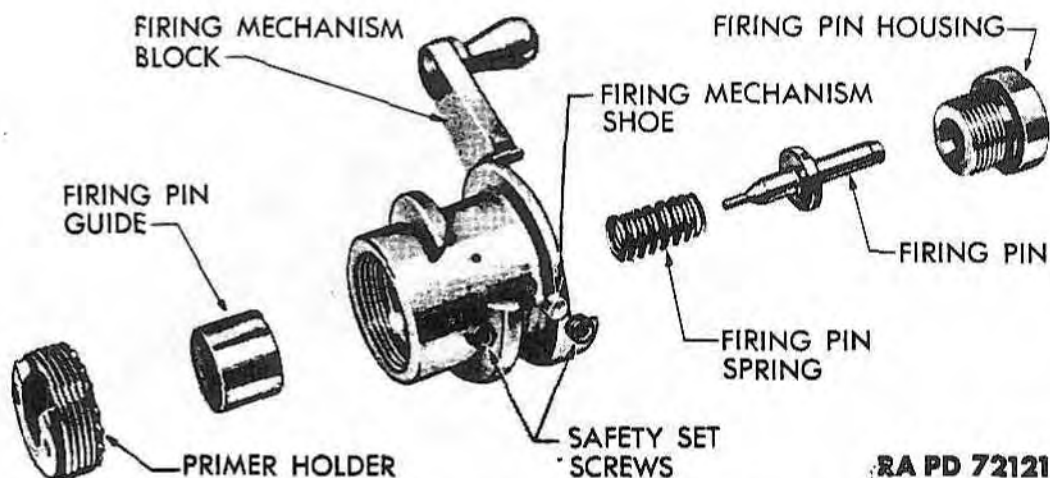

Figure 21 - Firing Mechanism - Exploded View

f. The firing pin spring forces the firing pin to the rear and prevents protrusion of the pin except by action of the percussion hammer. It also holds the primer in the primer holder.

g. The primer holder is located at the front end of the firing mechanism block and serves to hold the primer for firing the weapon.

Section II

DESCRIPTION AND FUNCTIONING OF
RECOIL MECHANISM

8. DESCRIPTION OF RECOIL MECHANISM.

a. The recoil system is of hydropneumatic constant recoil type (fig. 22). Actually, the recoil system is divided into two separate and distinct systems known as the recoil system and the recuperator (counterrecoil) system. The purpose of the recoil system is to absorb and control the energy created by the backward thrust of the weapon upon firing, and to check the movement of the recoiling mass in a gradual manner, thereby avoiding displacement of the carriage. The recuperator (counterrecoil) system, on the other hand, stores part of the recoil energy for returning the howitzer and sleigh from recoil to battery position, so that the weapon may be fired again.

b. The recoil and recuperator mechanism is housed in cylinders formed in the sleigh. The arrangement of these cylinders is illustrated in figure 23. The two upper cylinders form the recuperator reservoir and are connected by suitable passages with the lower center

HOWITZER, CARRIAGE, TRANSPORT WAGONS, CRANE,
AND CLAMHELL TRAILER

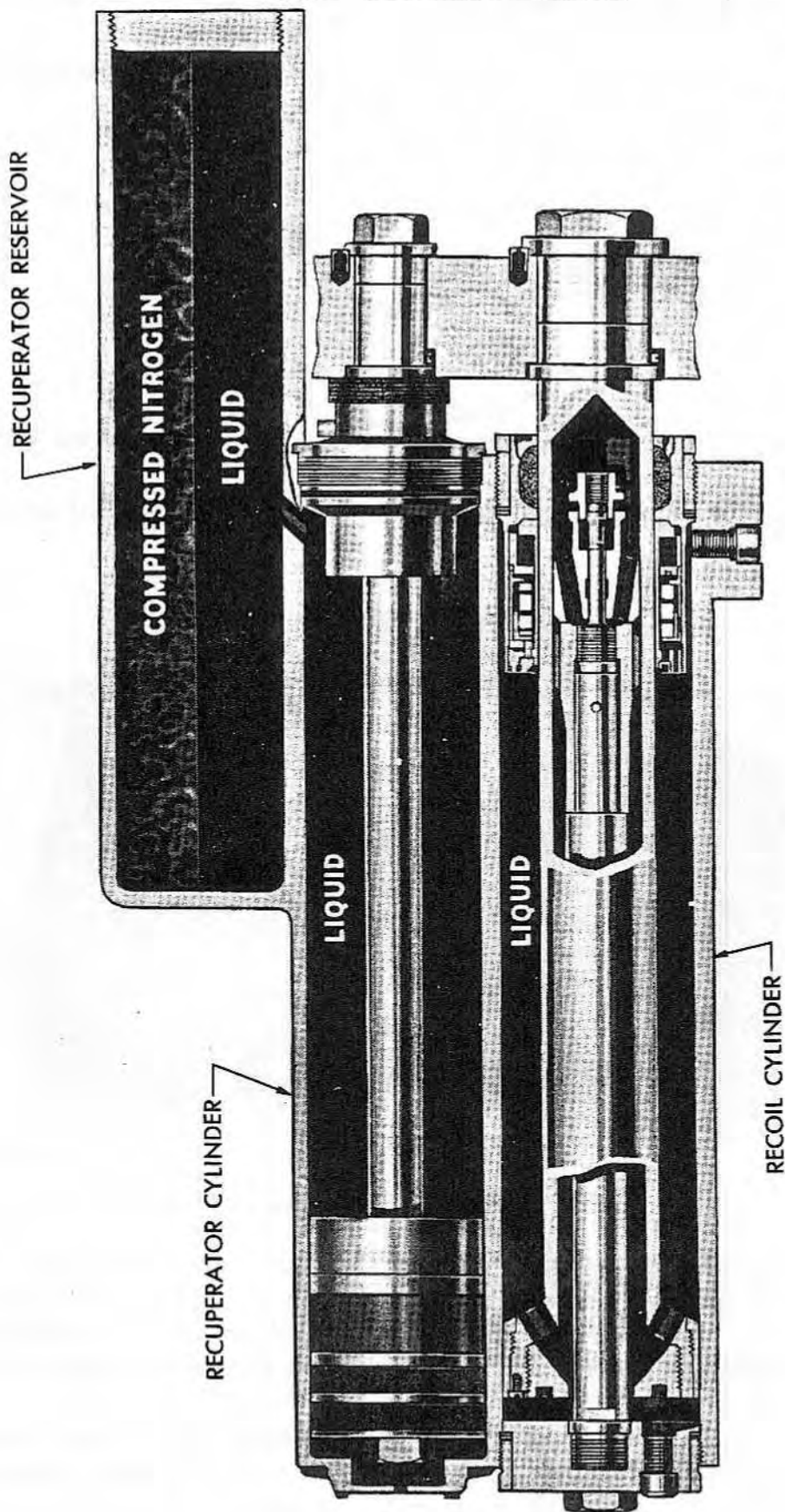

RA PD 72122

Figure 22 — Recoil System — Sectional View

240-MM HOWITZERS M1918MI AND M1918MIA1, 240-MM HOWITZER
CARRIAGE M1918A2, AND TRANSPORT WAGONS M4 AND M5

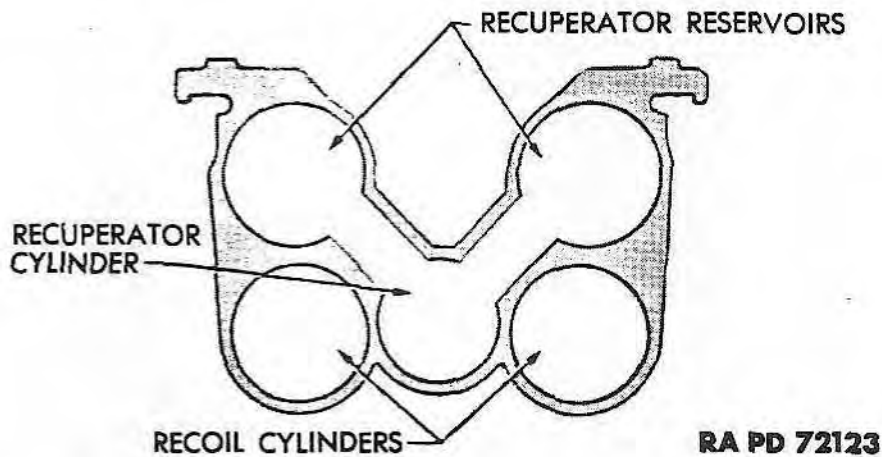

Figure 23 – Recoil and Recuperator Cylinders – General Arrangement

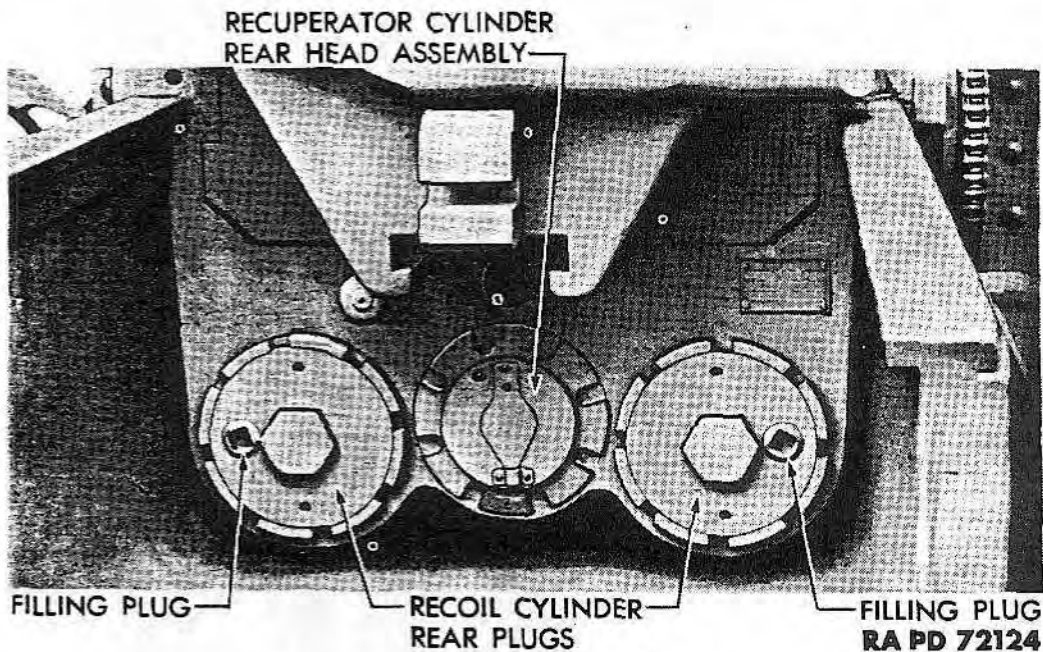

Figure 24 – Rear End of Sleigh

recuperator cylinder, which contains the recuperator mechanism. The two outer cylinders in the lower group are the recoil cylinders. The recoil cylinders are not interconnected and require separate filling. Three filling plugs are provided in each recoil cylinder for this purpose.

c. The recoil cylinders are completely full of liquid, except for a small void to allow for expansion. The recuperator cylinder is also full of liquid. The recuperator reservoir cylinders are only about

HOWITZER, CARRIAGE, TRANSPORT WAGONS, CRANE,
AND CLAMSHELL TRAILER

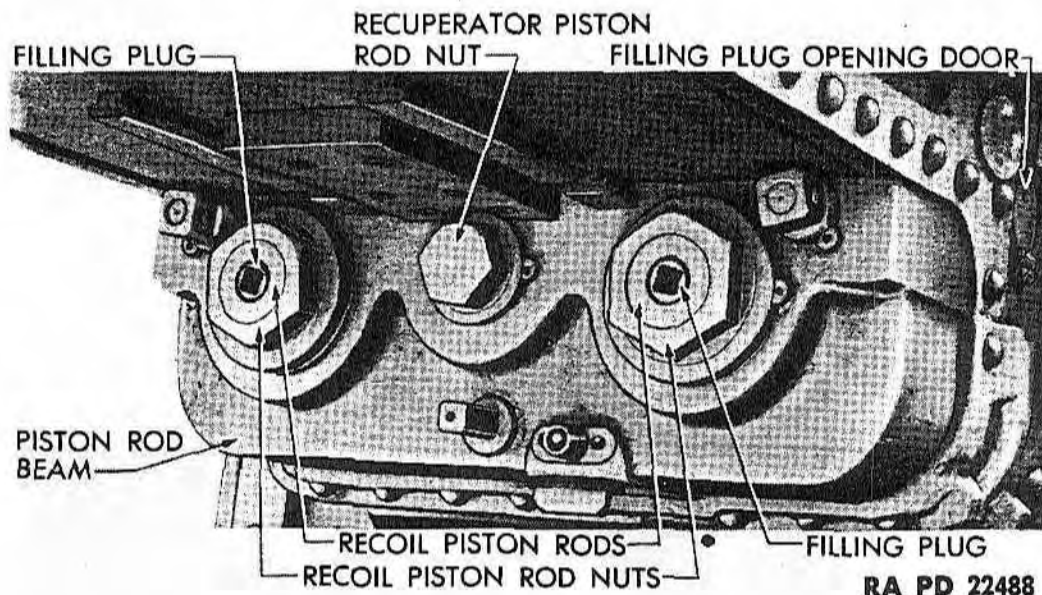

Figure 25 — Front End of Cradle

half full of liquid while the remaining space is filled with nitrogen under high pressure.

d. Recoil Mechanism.

(1) The front ends of the recoil cylinders are sealed by packing boxes containing numerous parts to prevent leakage past the recoil piston rods. The packing glands in the packing boxes are provided with an oilhole through which the recoil piston rod lubricating packings are oiled. A filling plug is provided at the side of the sleigh and near the front end of each recoil cylinder (fig. 25).

(2) The rear ends of the recoil cylinders are closed by the recoil cylinder rear plugs (fig. 24). These plugs are held in place by plug retainers screwed into the recoil cylinders and bearing against the rear plug washers, which prevent recoil liquid from being forced out through the rear plugs. Filling plugs with washers screw into the rear cylinder plugs.

(3) The recoil piston rods extend the full length of the recoil cylinders with the weapon in battery. The front ends of the recoil piston rods are attached to the piston rod beam by means of the recoil piston rod nuts and lock nuts (fig. 25), while the rear ends are enlarged to form the recoil pistons. The front end of each recoil piston rod also contains a filling plug for the recoil cylinders.

e. Throttling Rods and Return Valves.

(1) The two throttling rods (fig. 22) operate inside the recoil piston rods, and serve to control energy resulting from recoil.

240-MM HOWITZERS M1918MI AND M1918MIA1, 240-MM HOWITZER CARRIAGE M1918A2, AND TRANSPORT WAGONS M4 AND M5

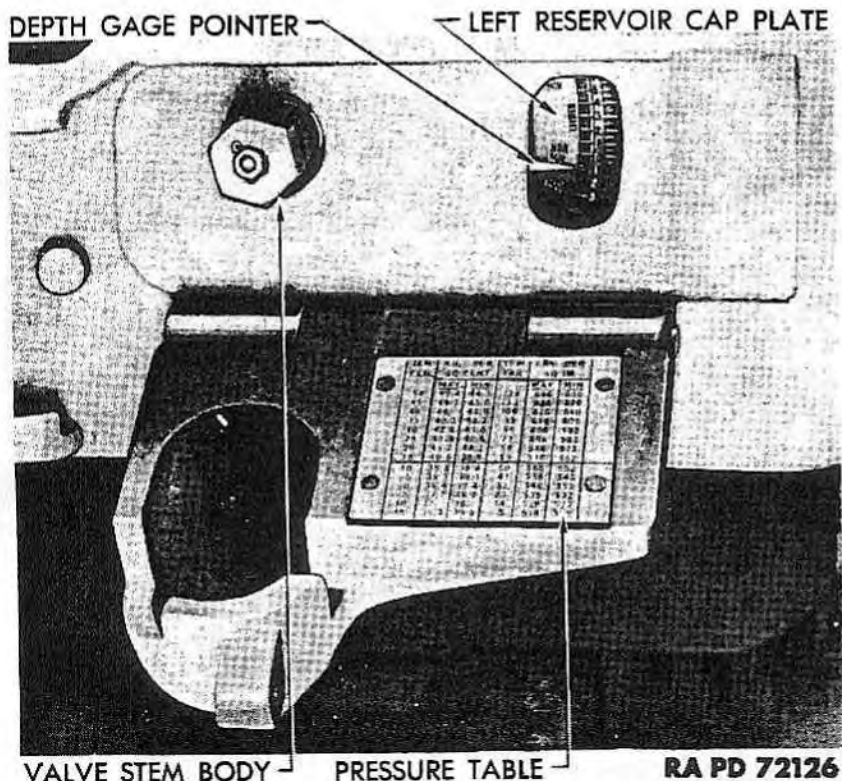

Figure 26 — Recuperator Pressure and Liquid Gage Assembly — External View

(2) The rear ends of the throttling rods are screwed into the rear cylinder plugs in the recoil cylinders, and the front ends are supported by the return valve seats. The throttling rods slide on fins slightly larger in diameter than the return valves.

(3) The return valves, one carried by each throttling rod, supply necessary auxiliary braking resistance when the howitzer is fired at low elevations. Return valve stops limit the forward movement of the return valves. The return valves have a sliding fit on the throttling rods and return valve stops.

f. Recuperator Mechanism.

(1) The recuperator mechanism operates independently of the recoil mechanism and is housed in the recuperator cylinder.

(2) The front end of the recuperator cylinder is sealed by the recuperator cylinder packing box mechanism. The rear end is closed by the rear cylinder head assembly (fig. 24). The recuperator cylinder rear head is provided with an oil cup and an air venthole. The air venthole permits air to be drawn into the cylinder during recoil and prevent a vacuum from forming behind the recuperator piston.

(3) The front end of the recuperator piston rod is attached to

HOWITZER, CARRIAGE, TRANSPORT WAGONS, CRANE,
AND CLAMSHELL TRAILER

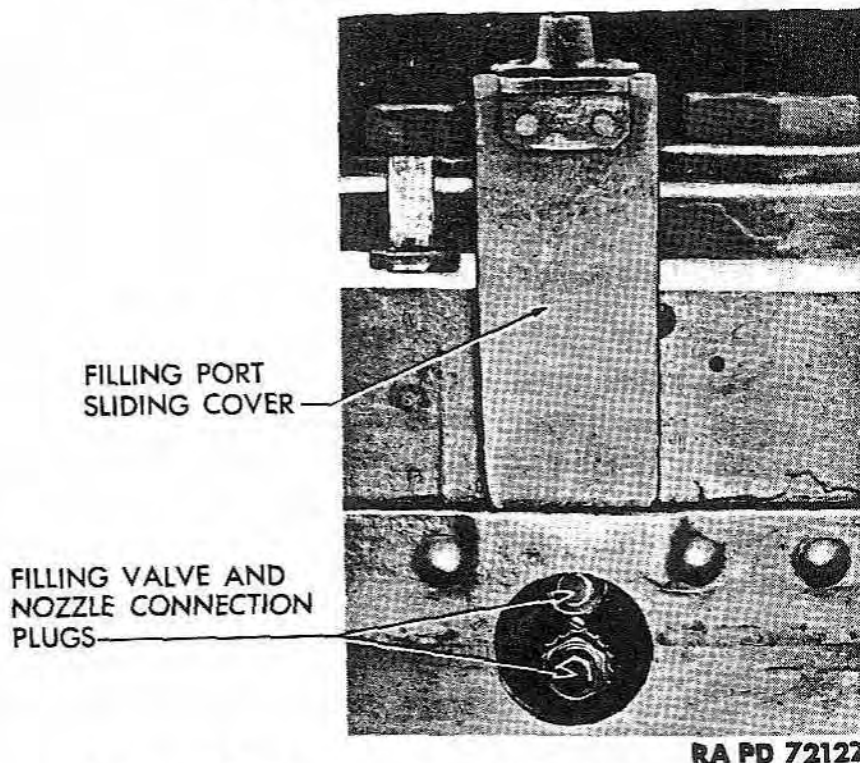

Figure 27 — Recuperator Filling Valve Plugs

the piston rod beam with a nut and lock nut (fig. 25) while the rear end carries the piston assembly.

(4) The recuperator buffer rings and buffer washer (fig. 22) limit the forward movement of the howitzer and sleigh as they return to battery position after recoil.

g. Recuperator Reservoirs.

(1) The two recuperator reservoirs (figs. 22 and 23) store liquid and nitrogen for the recuperator system. The ends of the recuperator reservoirs are closed by reservoir caps held in place by followers.

(2) The left reservoir cap contains the pressure and liquid gage assembly which is provided with a depth gage pointer, working in conjunction with a movable valve plate inside the reservoir, which registers the quantity of liquid in the system on a scale on the reservoir cap plate (fig. 26). A pressure gage adapter may be installed in the valve stem body for using a hydraulic pressure gage when testing the nitrogen pressure. The pressure table on the cap over the pressure and liquid gage assembly lists recuperator mechanism pressures for various temperatures.

(3) Passages between the recuperator reservoirs and recuperator cylinder permit flow of liquid between the recuperator cylinder and the reservoirs.

240-MM HOWITZERS M1918MI AND M1918MIA1, 240-MM HOWITZER CARRIAGE M1918A2, AND TRANSPORT WAGONS M4 AND M5

(4) A filling valve and nozzle connection plug assembly for filling the recuperator system is provided at the bottom of the sleigh near the front end and between the recuperator and left recoil cylinders (fig. 27). This assembly is made accessible by removing the filling port sliding cover.

9. FUNCTIONING OF THE RECOIL SYSTEM.**a. Recoil Action.**

(1) When the weapon is fired, the howitzer and sleigh recoil, carrying with them the throttling rods while the piston rods do not move. The liquid in the recoil cylinders, which is in front of the pistons, is forced through openings in the recoil pistons into the interior of the recoil piston rods, and out through the variable aperture formed by the throttling rods and the openings in the recoil piston rod throttling rings at the rear of the pistons (fig. 28).

(2) The diameter of the throttling rods is varied and continually changes the area of the aperture through the recoil piston rod throttling rings on recoil. This causes a resistance to the flow of liquid, which controls and limits the recoil to its normal amount. The length of recoil may be determined by means of the recoil pointer located on the left side of the cradle. The length of recoil is constant at all elevations.

(3) As the weapon recoils, liquid is also forced through the return valves, carried on the throttling rods, and fills the interior of the recoil piston rods in front of the return valves. The pressure of the liquid forces the return valves forward off their seats.

(4) As the howitzer and sleigh recoil, the recuperator cylinder recoils also. The recuperator piston remains fixed, and the tight packing of the head prevents flow of the liquid past the piston, so that the only outlet for it is through the communicating passages into the recuperator reservoirs. As the liquid is forced into the reservoirs, it compresses the nitrogen in the space above the liquid. This compressive effort assists in limiting the recoil movement.

b. Counterrecoil Action.

(1) Counterrecoil or return of the howitzer and sleigh to battery position is effected by the pressure of the compressed nitrogen in the recuperator reservoirs.

(2) As the recoil is completed, the compressed nitrogen expands and forces the liquid back into the recuperator cylinder between the recuperator piston and the recuperator cylinder packing box assembly at the front end of the recuperator cylinder (fig. 29). As the recuperator piston remains fixed, the force of the liquid against the recupera-

HOWITZER, CARRIAGE, TRANSPORT WAGONS, CRANE,
AND CLAMHELL TRAILER

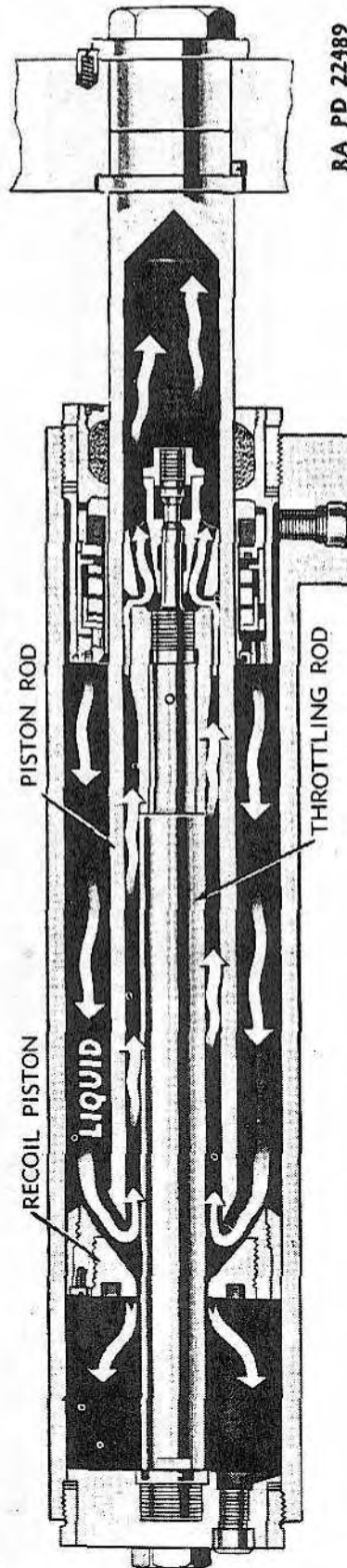
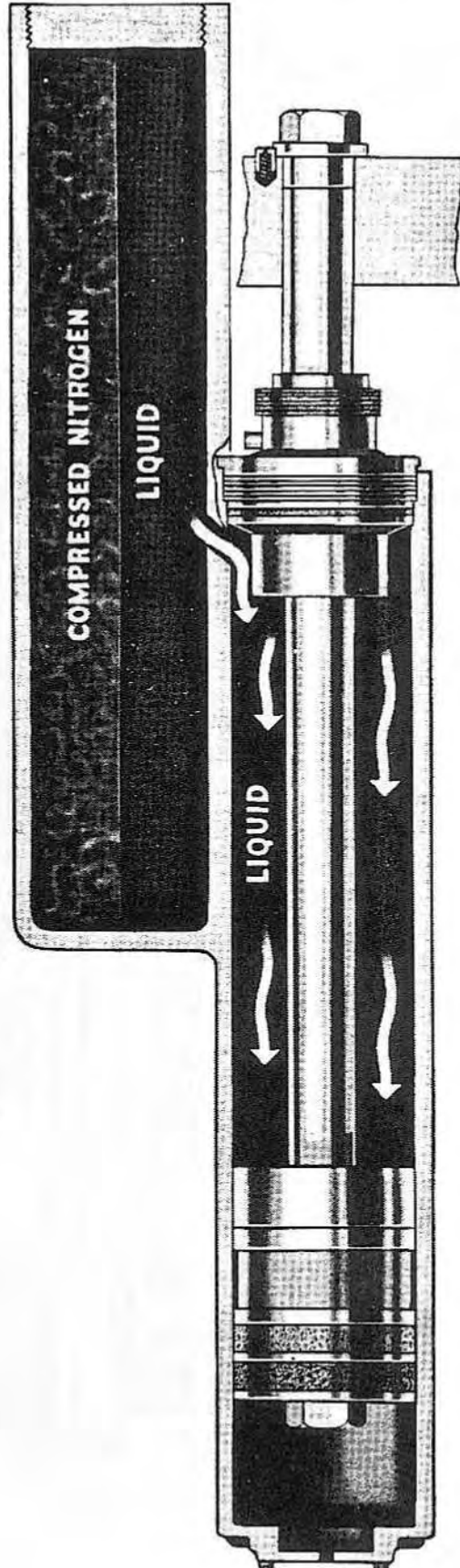

Figure 28 — Recoil Mechanism — Weapon in Recoil — Phantom View

240-MM HOWITZERS M1918MI AND M1918MIA1, 240-MM HOWITZER
CARRIAGE M1918A2, AND TRANSPORT WAGONS M4 AND M5



RA PD 72129

Figure 29 — Recuperator Mechanism — Weapon in Counterrecoil — Phantom View

HOWITZER, CARRIAGE, TRANSPORT WAGONS, CRANE, AND CLAMSHELL TRAILER

tor cylinder packing box assembly returns the howitzer and sleigh to battery position. As the weapon returns to battery position, it is stopped by the buffer rings and buffer washer, thus preventing metal-to-metal contact in battery.

(3) The energy of the compressed nitrogen in the recuperator system is sufficient to return the howitzer and sleigh to battery position when the weapon is at maximum elevation. Consequently, an excess of energy is present at low elevation, necessitating auxiliary braking resistance. This required additional resistance is supplied by the action of the return valves on the throttling rods in the recoil piston rods.

(4) As recoil is completed and counterrecoil begins, the direction of the flow of liquid in the recoil cylinders is reversed. The pressure of the liquid forces return valves to seat, causing the liquid to flow through the clearance space between the outside diameter of the return valves and the inner walls of the recoil piston rods. A resistance effort against the counterrecoiling mass is thus produced and, as the inside diameter of the piston rod traversed by the return valve is varied, the breaking resistance will at all times be of such proportions as to allow the howitzer and sleigh to return smoothly to battery. This opening through which the liquid must flow gradually decreases, so that near the end of counterrecoil, the opening is closed to such an extent that the return valve functions as a hydraulic buffer, thereby enabling the weapon to return to battery position at all elevations without shock.

Section III

DESCRIPTION AND FUNCTIONING OF CARRIAGE

10. GENERAL.

a. The 240-mm Howitzer M1918MI or M1918MIA1, is supported by and securely locked to the sleigh which contains the recoil mechanism. The sleigh and howitzer are, in turn, supported by the cradle, which is carried by the top carriage through trunnions (fig. 30).

b. The top carriage assembly, with howitzer, sleigh, and cradle, rests on the platform and is attached thereto through the pintle mechanism at the front and the holding-down sector and clips at the rear. The top carriage is further supported at the rear by two traversing roller assemblies. The elevating and traversing mechanisms are located at the left side of the top carriage.

c. The platform forms the base for the weapon and its controlling

240-MM HOWITZERS M1918MI AND M1918MIA1, 240-MM HOWITZER
CARRIAGE M1918A2, AND TRANSPORT WAGONS M4 AND M5

RA PD 22490

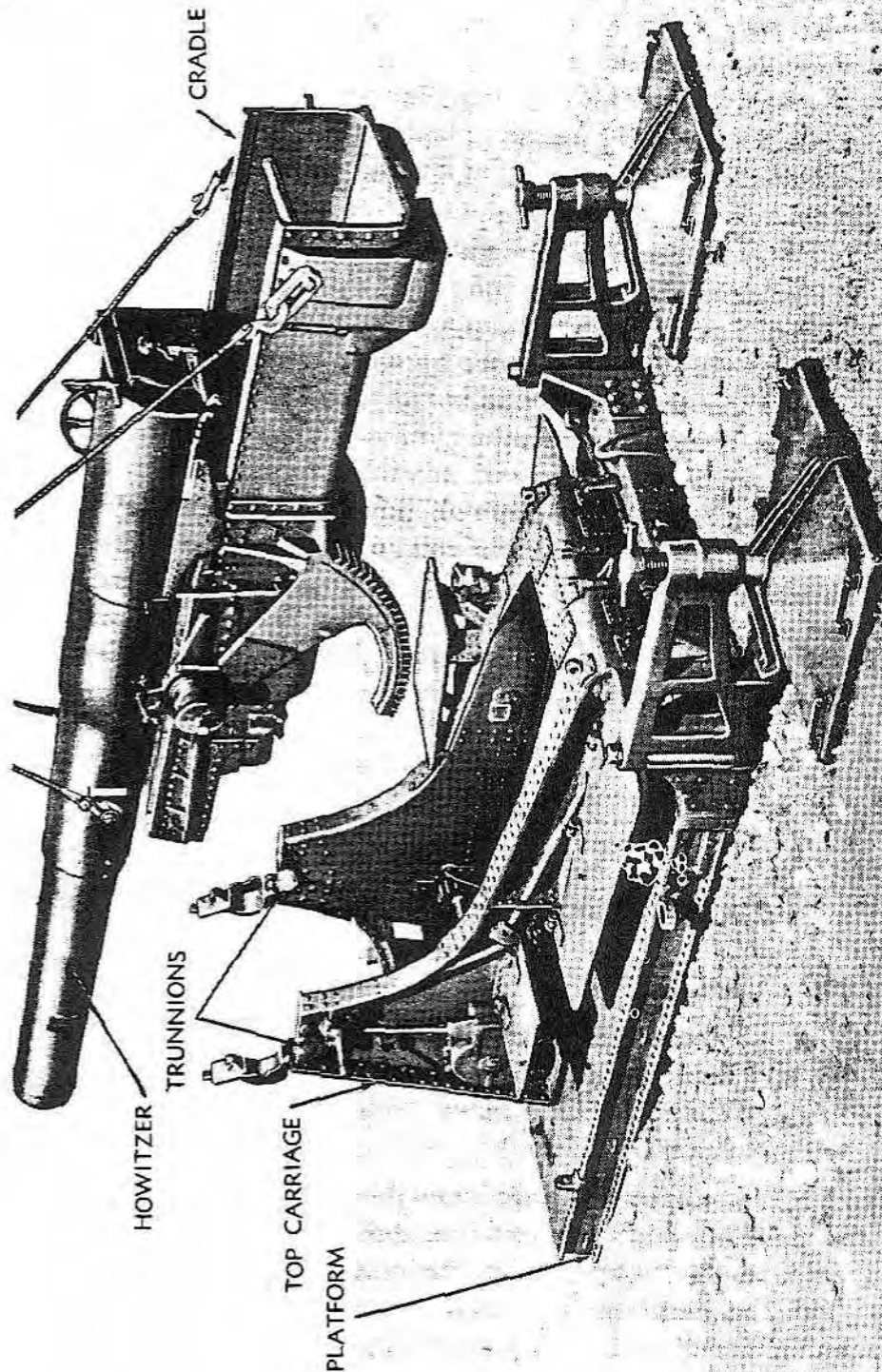
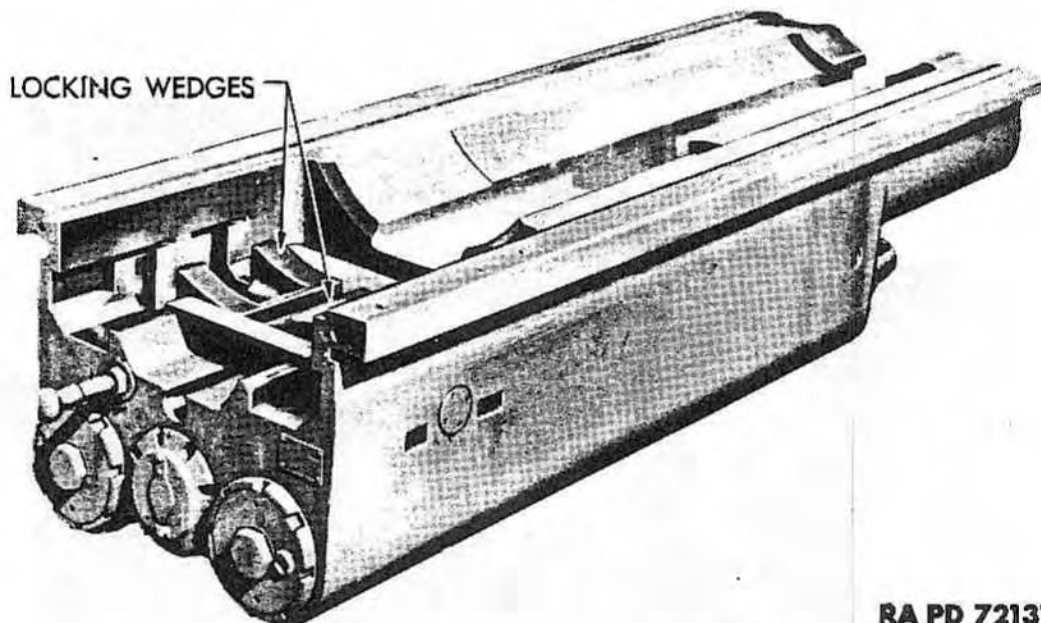

Figure 30 — View of Howitzer and Carriage, With Howitzer Removed

HOWITZER, CARRIAGE, TRANSPORT WAGONS, CRANE,
AND CLAMSHELL TRAILER



RA PD 72131

Figure 31 — Sleigh — Three-quarter Rear View

mechanisms. The lower portion of the platform, known as the trunk, is embedded in the ground to provide maximum firing stability (fig. 30).

11. SLEIGH.

a. The sleigh (fig. 31) supports the howitzer and houses the recoil mechanism. It is made from a forged steel block, in which five longitudinal cylinders are bored. The two upper cylinders, running about half the length of the sleigh form the recuperator reservoirs. The three lower cylinders run the full length of the sleigh; the outer ones are the recoil cylinders, and the center one the recuperator cylinder.

b. Sleigh liners, located at the under side of the top edges of the sleigh, slide on the recoil slide guides of the cradle and guide the cradle during recoil and counterrecoil.

c. Locking wedges secure the howitzer to the sleigh (fig. 32), preventing longitudinal movement of the howitzer in relation to the sleigh, and causing the howitzer and sleigh to move together as a unit in recoil and counterrecoil. These wedges are operated by screws, and are locked in the fully engaged position by a locking bolt which slides forward automatically into position at the end of the left-hand locking wedge. An additional safety device in the form of a wedge screw brake is provided to prevent rotation of the wedge screws without the use of a special wrench.

240-MM HOWITZERS M1918MI AND M1918MIA1, 240-MM HOWITZER
CARRIAGE M1918A2, AND TRANSPORT WAGONS M4 AND M5

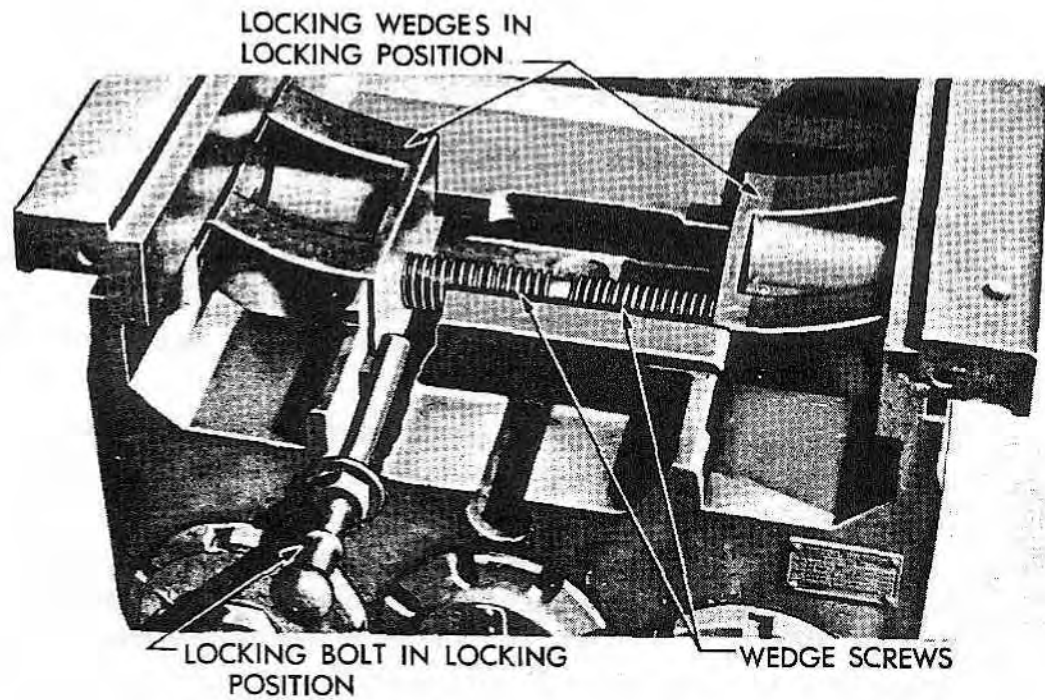
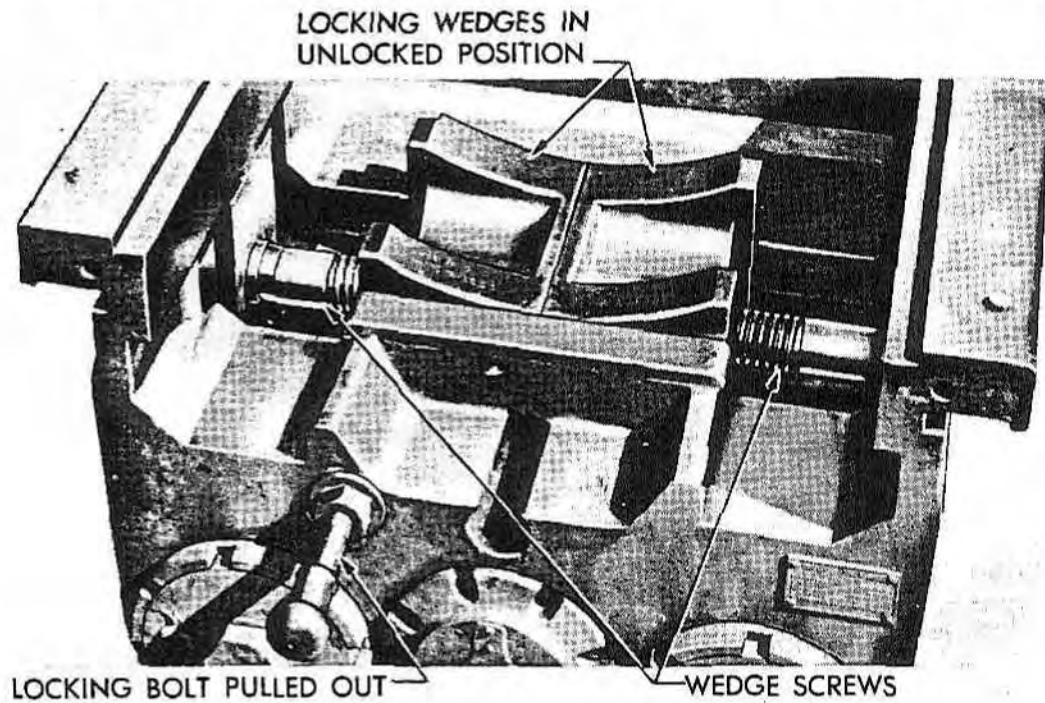
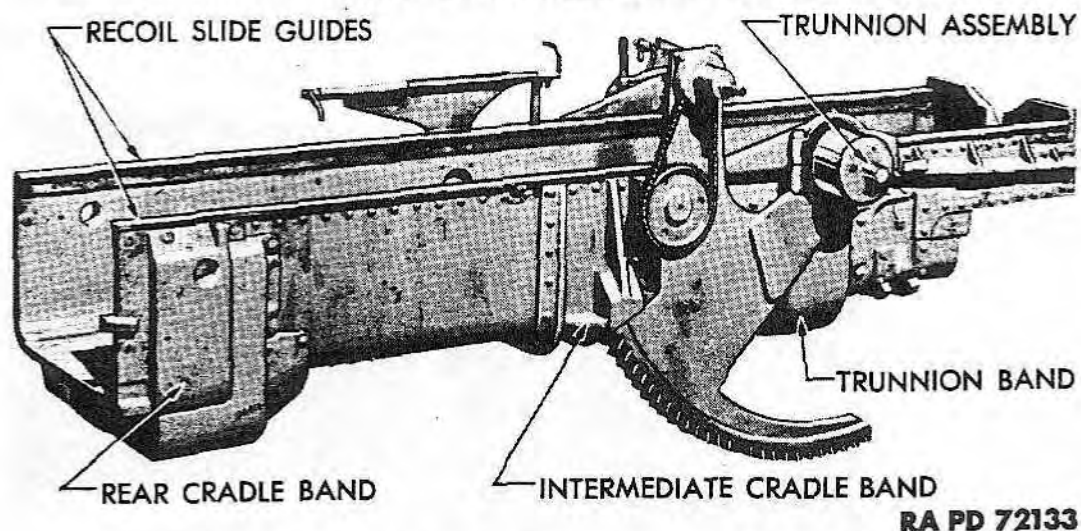

Figure 32 — Locking Wedges in Unlocked and Locking Positions

HOWITZER, CARRIAGE, TRANSPORT WAGONS, CRANE,
AND CLAMSHELL TRAILER



RA PD 72133

Figure 33 - Cradle - Three-quarter Rear View

12. CRADLE.

a. The cradle (fig. 33) is a U-shaped plate which supports the howitzer and sleigh. It is connected to the top carriage through the trunnion assemblies.

b. Recoil slide guides at the upper edges of the cradle provide a bearing surface on which the sleigh slides during recoil and counter-recoil. The trunnion band, intermediate cradle band, and rear cradle band give the cradle greater rigidity and support various assemblies on the cradle. The front end of the cradle is also stiffened by the front transom.

c. **Trunnion Band.** The trunnion band supports the main trunnion and auxiliary trunnion assemblies, which form the connection between the cradle and top carriage. The main trunnions transmit firing stresses to the top carriage, while the auxiliary trunnion assemblies support the tipping parts except during firing, facilitating elevation and depression of the howitzer and cradle. The auxiliary trunnions are fitted into bores concentric with the main trunnions. The auxiliary trunnions, with the roller bearings and trunnion end plates, remain with the howitzer and cradle assembly in traveling position.

d. **Intermediate Cradle Band.** The intermediate cradle band is located on the cradle bottom plate to the rear of the trunnion. The locking wedge key door (fig. 42) is attached to this band. Beveled surfaces on each side of the band bear on the upper ends of the elevating arcs. Through contact at these surfaces, reaction caused by firing is transmitted through the elevating gearing to the friction clutch. The firing rod bracket is also located on this band.

240-MM HOWITZERS M1918MI AND M1918MIA1, 240-MM HOWITZER
CARRIAGE M1918A2, AND TRANSPORT WAGONS M4 AND M5

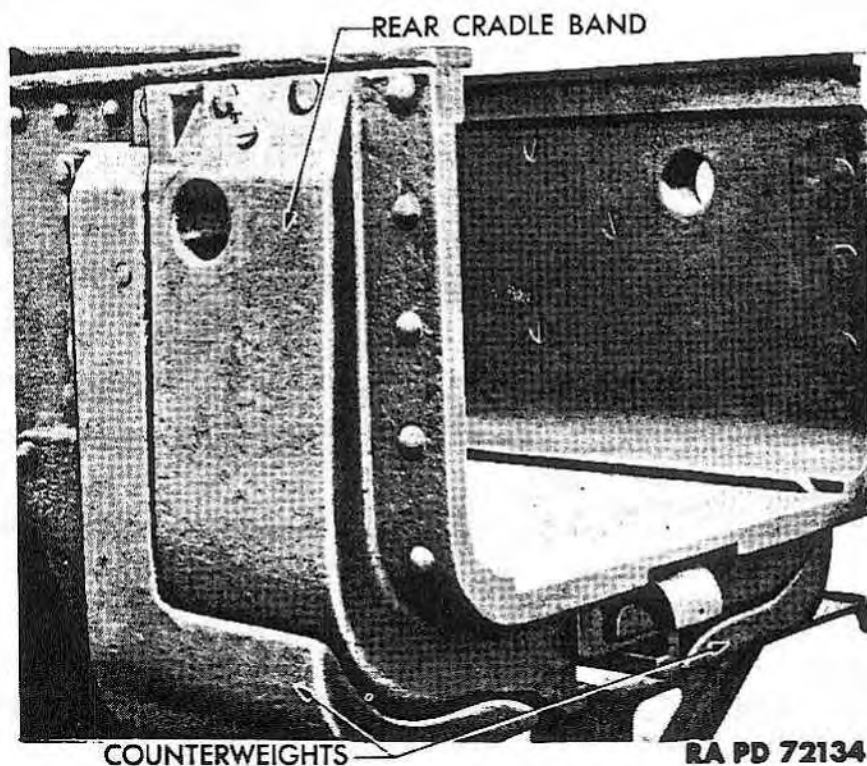

Figure 34 — Rear Cradle Band and Counterweights

e. **Rear Cradle Band.** The rear cradle band provides rigidity at the rear end of the bottom cradle plate. This band is made hollow to provide for pouring a quantity of lead into it to increase its weight. This lead, together with the right- and left-hand counterweights attached to the rear end of the cradle and rear cradle band, serves to balance the tipping parts (fig. 34).

f. **Cradle Elevating Stop.** The cradle elevating stop is riveted to the under side of the cradle bottom plate just forward of the rear band, and limits elevation of the howitzer to 60 degrees at which point the stop engages the cradle elevating stop in the trunk portion of the platform.

g. **Piston Rod Beam.** The piston rod beam is attached to the front lower part of the cradle bottom plate, and supports the front ends of the recoil piston rods and recuperator piston rod (fig. 25). Because of this arrangement, stresses caused by firing must be taken by the piston rod beam. The piston rod beam is secured in position by two locking bolts at the upper side and an operating screw at the lower side. On modified Carriages M1918A2, the addition of a reinforcing plate on the under side of the front end of the cradle prevents moving the piston rod beam forward.

HOWITZER, CARRIAGE, TRANSPORT WAGONS, CRANE,
AND CLAMHELL TRAILER

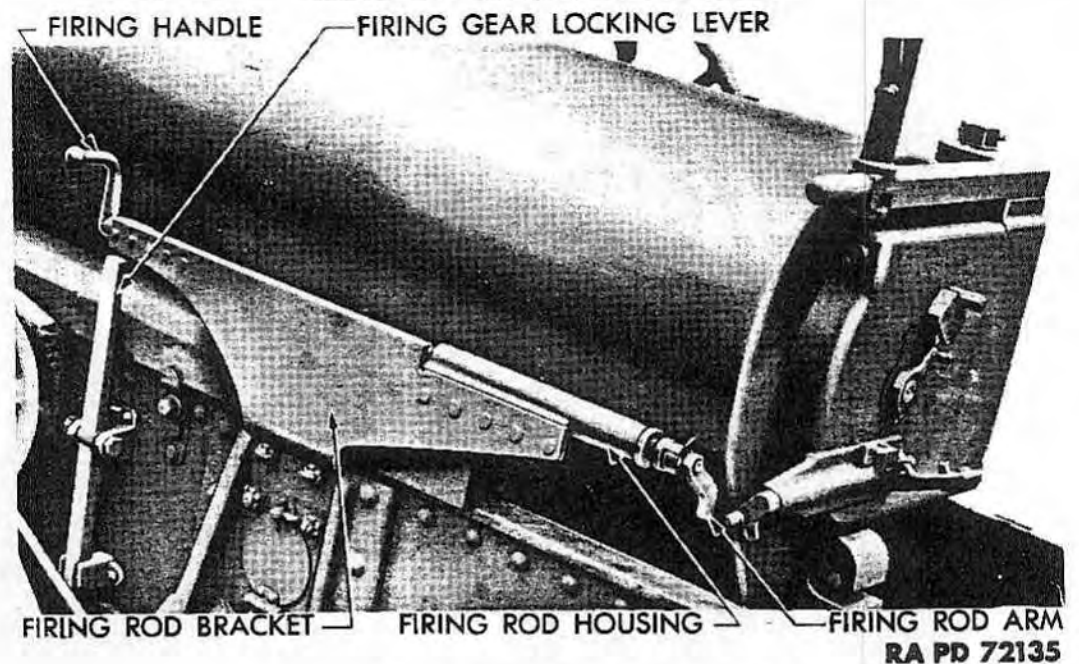

RA PD 72135

Figure 35 — Firing Gear Assembly

h. Firing Gear Assembly.

(1) The firing gear assembly is mounted on the left side of the intermediate cradle band (fig. 35). It provides a means of firing the howitzer from the side and is operated by pulling the firing handle sharply toward the rear. This causes the firing rod arm to hit the percussion hammer shaft attached to the breechblock carrier, and throws the percussion hammer against the firing pin.

(2) The firing gear assembly consists of the firing rod bracket, firing rod, firing rod housing, firing rod arm, firing handle, and related parts.

(3) The firing rod operates in the firing rod housing and the firing gear clutch bushing at the rear end, and is supported at the front by the firing rod handle guide on the firing rod bracket. The firing rod spring in the firing rod housing is compressed when the firing handle is pulled to the rear, and returns the firing gear to its original position after firing.

(4) The firing gear locking lever serves as a safety device to prevent premature firing of the howitzer until the intermediate cradle band rests on the ends of the elevating arcs. This is accomplished through the action of the left quick-loading mechanism lock rod which forces the upper end of the firing gear locking lever toward the cradle, preventing the firing rod from being pulled backwards.

(5) A lanyard attached to the percussion hammer operating shaft provides a means of firing the first few rounds to determine whether

TM 9-340
12

240-MM HOWITZERS M1918MI AND M1918MIA1, 240-MM HOWITZER
CARRIAGE M1918A2, AND TRANSPORT WAGONS M4 AND M5

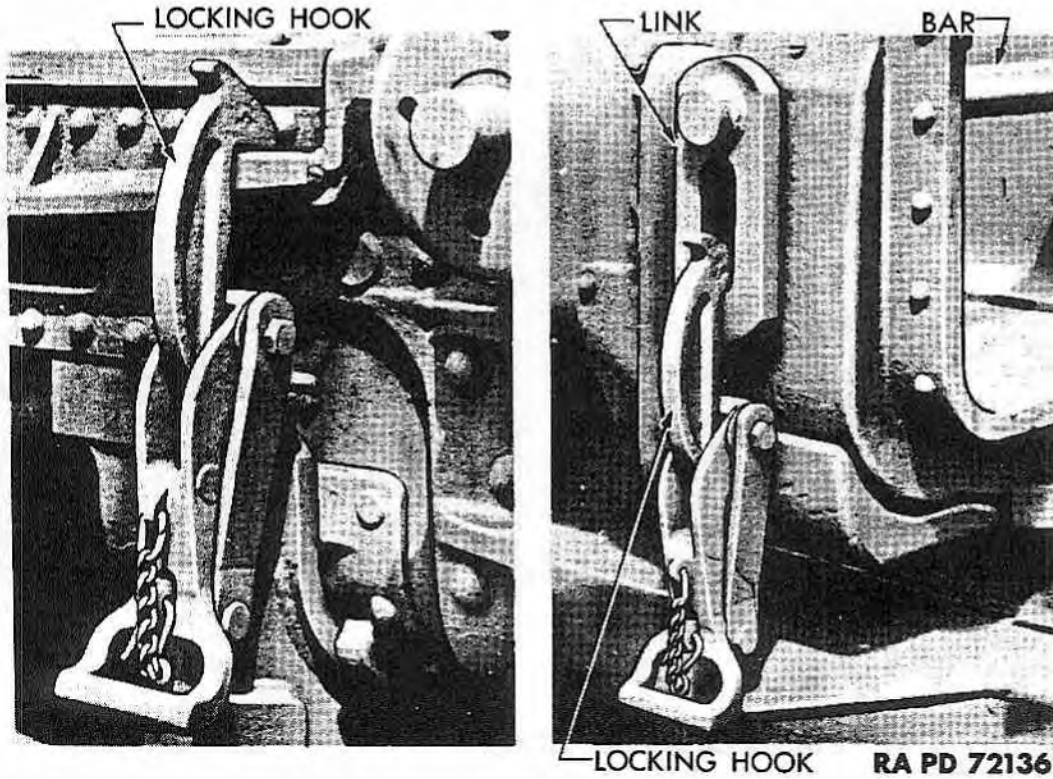

Figure 36 — Cradle Locked to Transport Wagon M4, for Traveling

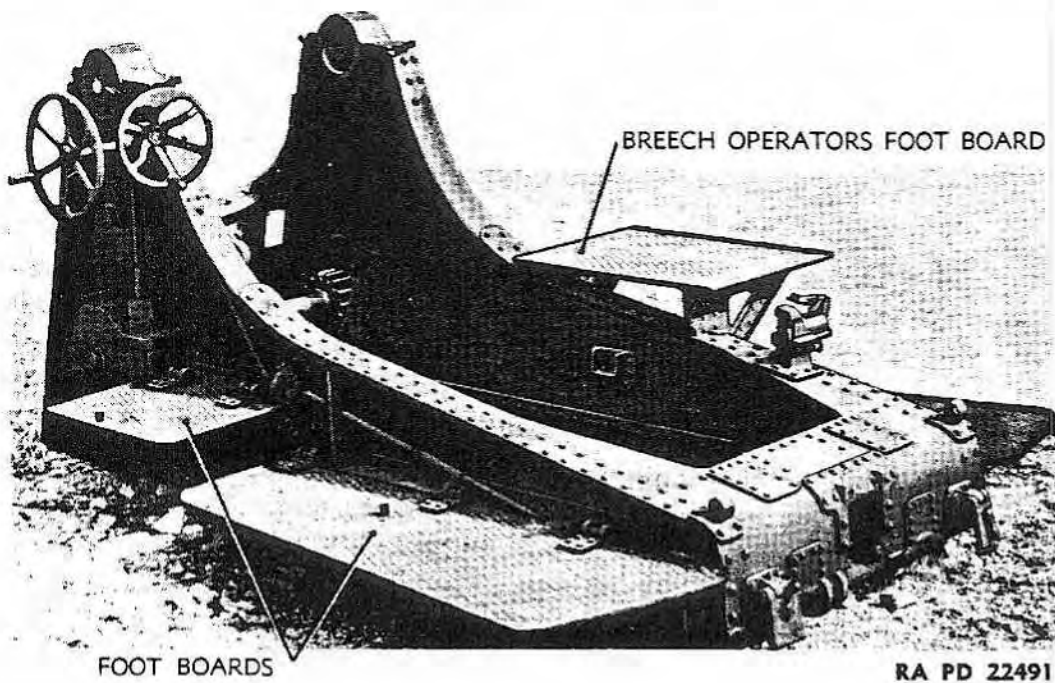

Figure 37 — Top Carriage — Three-quarter Rear View

HOWITZER, CARRIAGE, TRANSPORT WAGONS, CRANE,
AND CLAMSHELL TRAILER

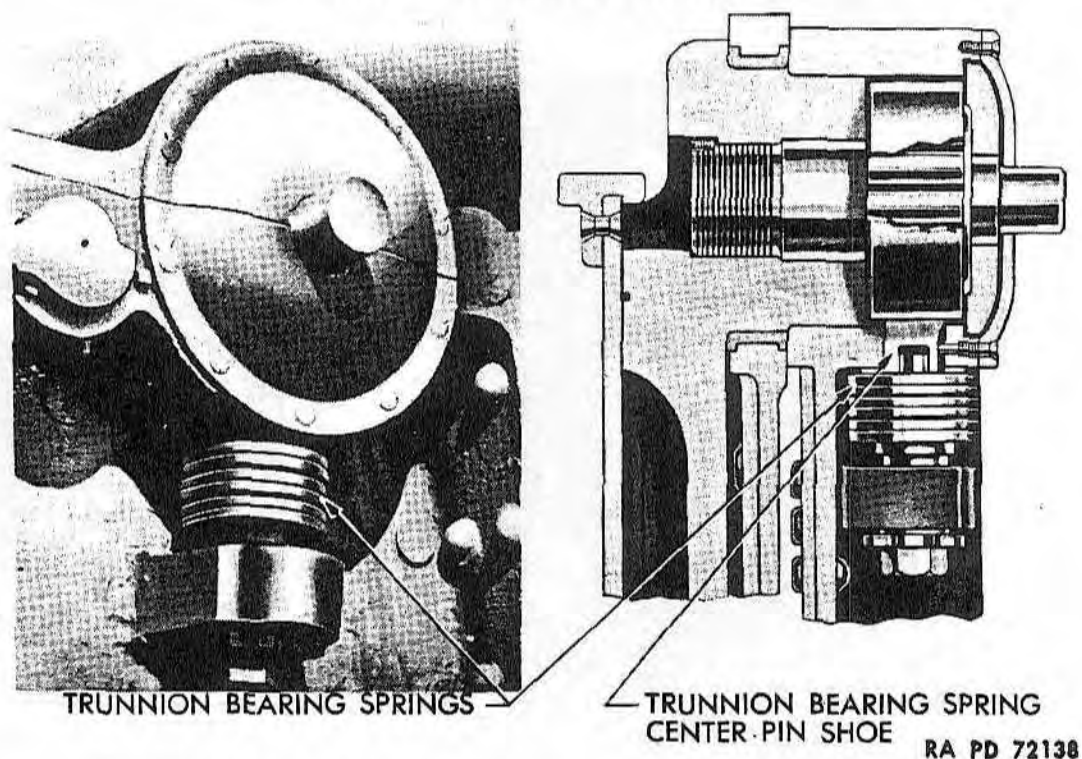

Figure 38 - Trunnion Bearing Mechanism

the carriage is operating properly, or to be used if the firing gear is out of order. When using the lanyard, care must be taken to make sure the cradle is in proper firing position as the firing gear locking lever is inoperative when the weapon is fired with the lanyard.

i. In traveling position, the cradle is securely locked to the Transport Wagon M4 by means of lugs and locking hooks (fig. 36). A bar passed through holes near the rear end of the cradle has a link at each end, to which locking devices on the wagon frame are attached. One of these links is removable while the other is welded to the bar.

13. TOP CARRIAGE.

a. The top carriage assembly (fig. 37) is composed of two top carriage flasks, top plate, bottom plate, and front plate with necessary connecting and stiffening angles and plates. It supports the cradle, howitzer, and sleigh through the trunnions on the cradle, and is secured to the platform through the pintle mechanism which transmits the load of the top carriage to the platform. The elevating and traversing mechanisms are mounted on the top carriage.

b. Trunnion Bearing Assemblies.

(1) The trunnion bearing assemblies, riveted to the top carriage flasks, consist principally of the trunnions of the cradle, auxiliary trunnion roller bearings, and trunnion bearing half covers.

240-MM HOWITZERS M1918MI AND M1918MIA1, 240-MM HOWITZER
CARRIAGE M1918A2, AND TRANSPORT WAGONS M4 AND M5

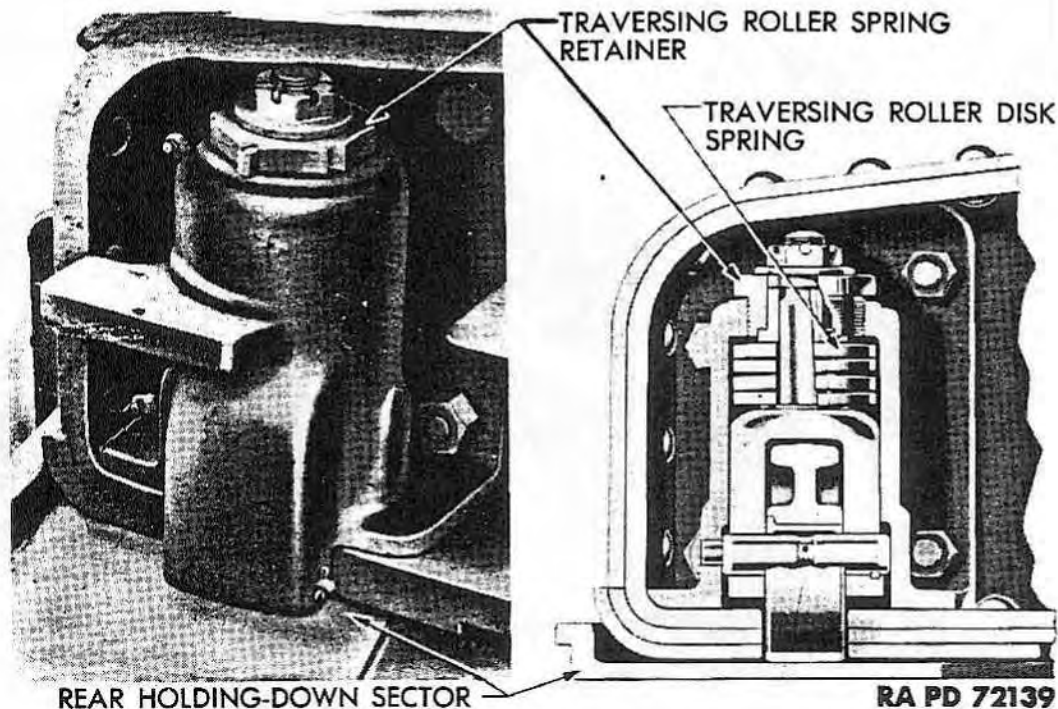

Figure 39 - Traversing Roller Assembly

(2) Trunnion end plates, on the outer ends of the auxiliary trunnions, hold the roller bearings in place. These plates are secured with lock screws.

(3) The roller bearings are enclosed in races supported by trunnion bearing spring center pin shoes, which rest on the trunnion bearing springs (fig. 38). With the trunnion bearing spring mechanism properly assembled and adjusted, the cradle trunnions are floated, bringing the load of the tipping parts on the auxiliary trunnions, thus reducing to a minimum the effort required to elevate or depress the weapon. When the howitzer is fired, the trunnion bearing springs are compressed, and the cradle trunnions forced down into contact with the bearing surfaces of the top carriage flasks which receive the full force of recoil. After the firing has taken place, the tipping parts return to their original floating position with the load on the auxiliary trunnions and roller bearings.

c. **Pintle Crown.** The pintle crown is built in the lower part of the top carriage, toward the front, and supports the top carriage on the pintle of the platform assembly.

d. **Traversing Roller Assembly.** Two traversing roller assemblies (fig. 39) support the rear end of the top carriage and transmit the load on the rear of the top carriage to the rear holding-down sector on the platform. When the howitzer is fired, the traversing

HOWITZER, CARRIAGE, TRANSPORT WAGONS, CRANE,
AND CLAMSHELL TRAILER

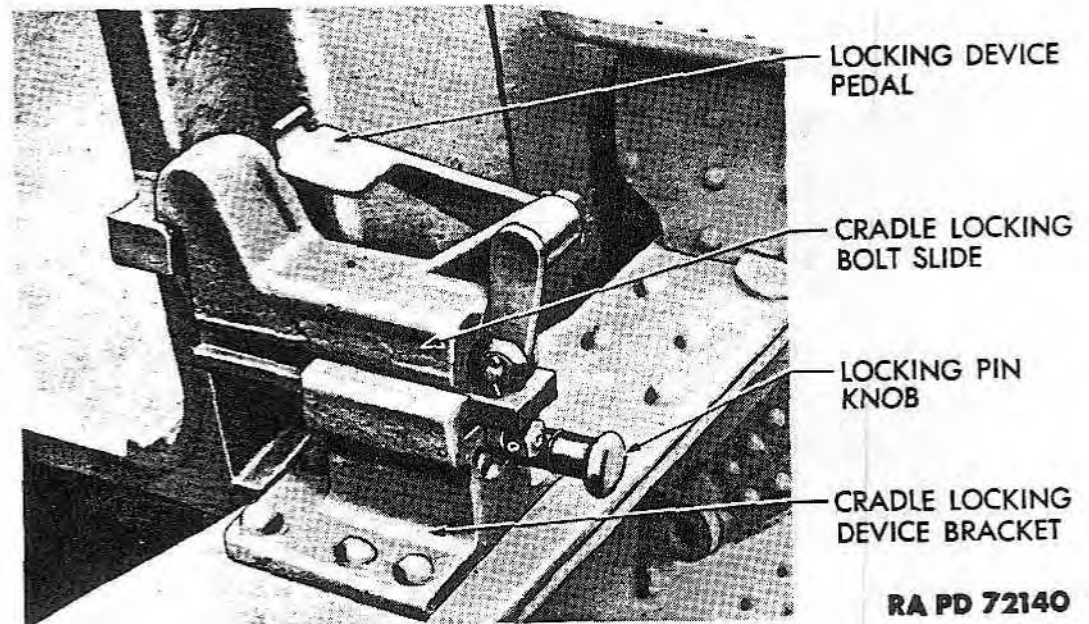

RA PD 72140

Figure 40 – Cradle Locking Bolt Slide Assembly

roller disk springs are compressed so that the top carriage bears directly on the rear holding-down sector, relieving the traversing roller assemblies of the firing load.

e. **Cradle Locking Bolt Slide.** The cradle locking bolt slide assembly (fig. 40), located on the right side of the carriage, automatically locks the cradle as the howitzer is brought to the loading position. The cradle is unlocked by stepping on the locking device pedal. To depress the howitzer below the loading angle, the cradle locking bolt slide with its mechanism is partially withdrawn after pulling out on the locking pin knob and moving the cradle locking bolt operating lever to release the cradle locking bolt slide. The slide assembly may be removed entirely from the locking device bracket when assembling the cradle to top carriage.

f. **Footboards.** Provision is made on the top carriage for several footboards used by the personnel in maneuvering the carriage and operating the weapon (fig. 37). Guides on the forward folding footboard provide a place for transporting the loading tray. All footboards fold up against the top carriage in traveling position except the breech operator's footboard which is carried at the front end of the top carriage.

g. **Miscellaneous Brackets.**

(1) The rear clip brackets (fig. 41) support the clips which secure the rear end of the top carriage to the platform.

(2) The traversing stop (fig. 41) prevents traversing motion of

240-MM HOWITZERS M1918MI AND M1918MIA1, 240-MM HOWITZER
CARRIAGE M1918A2, AND TRANSPORT WAGONS M4 AND M5

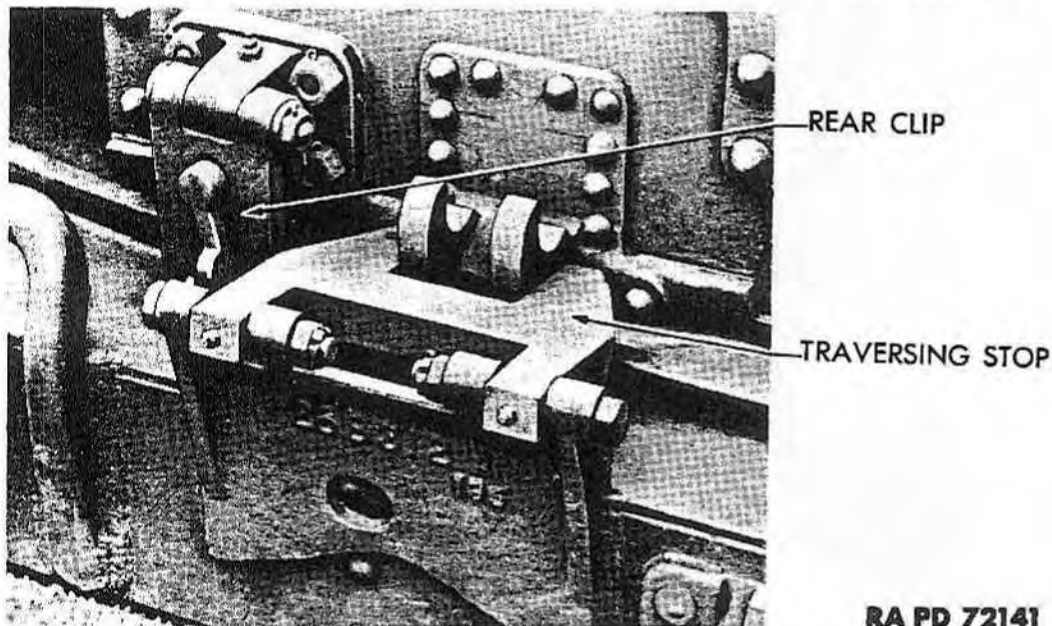

RA PD 72141

Figure 41 – Rear Clip and Top Carriage Traversing Stop

the top carriage, keeping it firmly in position when loaded on the transport wagon for traveling.

(3) A suitable bracket is provided on the left flask of the top carriage for attaching the air and liquid pumps.

(4) The firing mechanism bracket inside the left flask of the top carriage near the lower traversing gear case, supports two sheaves for guiding the lanyard so that it may be brought out through a slot in the flask. This permits using the lanyard from the outside.

14. ELEVATING MECHANISM.

a. The elevating mechanism (fig. 42) is located on the left side of the top carriage. Range of elevation from -1 degree to 60 degrees is controlled by stops on the cradle, top carriage, and platform.

b. Approximately one and one-half turns of the elevating handwheel are required to elevate or depress the howitzer and other tipping parts 1 degree.

c. Movement of the elevating handwheel is transmitted through the handwheel shaft and bevel gears, the elevating worm shaft, worm and worm wheel, and the friction clutch to the elevating arc pinions and shaft and elevating arcs.

d. When the carriage is in transit, the elevating arcs are locked to the cradle by a lock mechanism located on the plate connecting the two elevating arcs.

HOWITZER, CARRIAGE, TRANSPORT WAGONS, CRANE,
AND CLAMSHELL TRAILER

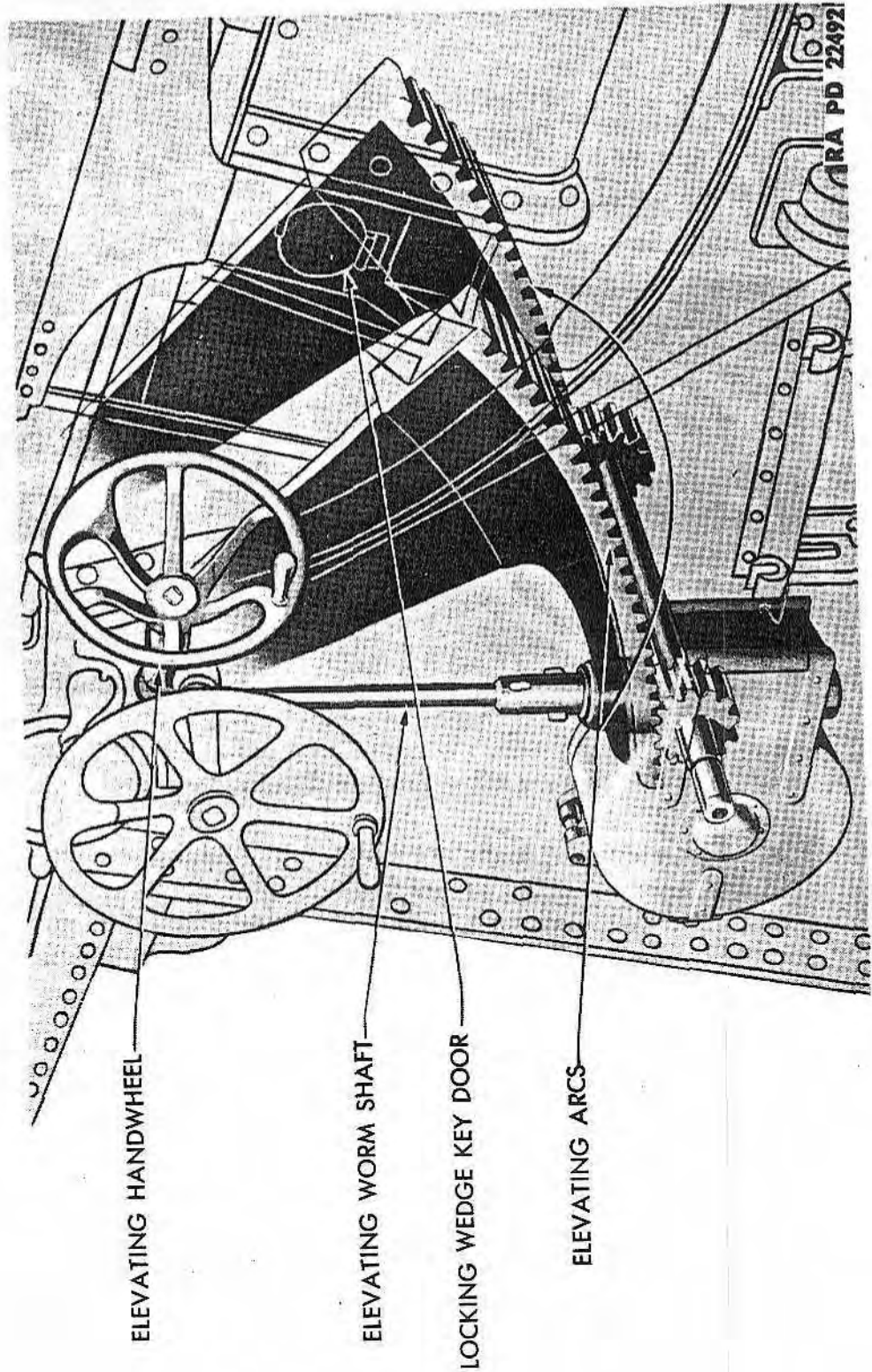

Figure 42 — Elevating Mechanism — Phantom View

240-MM HOWITZERS M1918MI AND M1918MIA1, 240-MM HOWITZER
CARRIAGE M1918A2, AND TRANSPORT WAGONS M4 AND M5

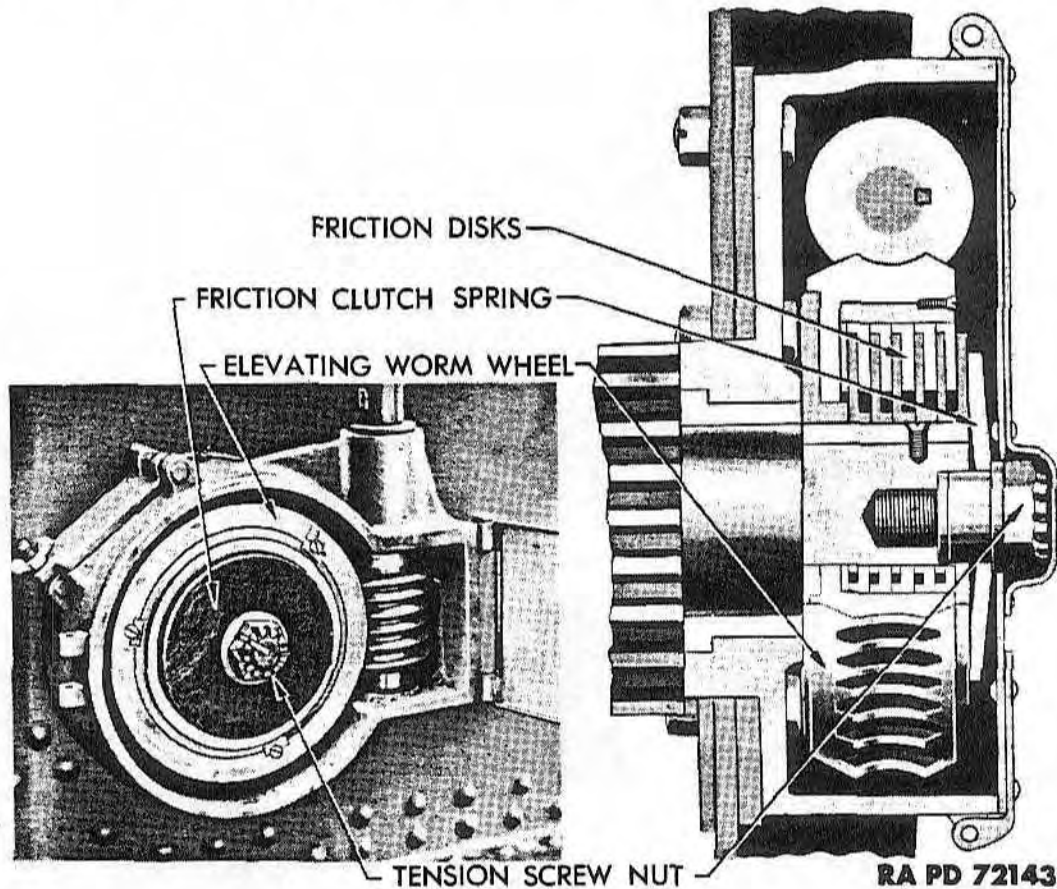

Figure 43 - Friction Clutch Assembly

e. The elevating arms are pivoted in bushings on the cradle trunnion and are connected across underneath the cradle by a connecting plate. The left elevating arm bearing is designed to permit attachment of the sight which is actually supported on the left-hand auxiliary trunnion.

f. The elevating arcs bear against lugs on the intermediate cradle band, and when the howitzer is fired, the tendency to rotate is transmitted directly from these lugs to the ends of the elevating arcs, the elevating arc pinions, and to the friction clutch.

g. A friction clutch (fig. 43) is incorporated in the elevating mechanism to relieve stresses on the elevating gearing during firing and maneuvering. The friction clutch is contained within the elevating worm wheel and is composed of bronze and steel friction disks, friction clutch spring, and a tension screw nut.

15. QUICK-LOADING GEAR MECHANISM.

a. The quick-loading gear mechanism (fig. 44) provides for rapid

HOWITZER, CARRIAGE, TRANSPORT WAGONS, CRANE,
AND CLAMSHELL TRAILER

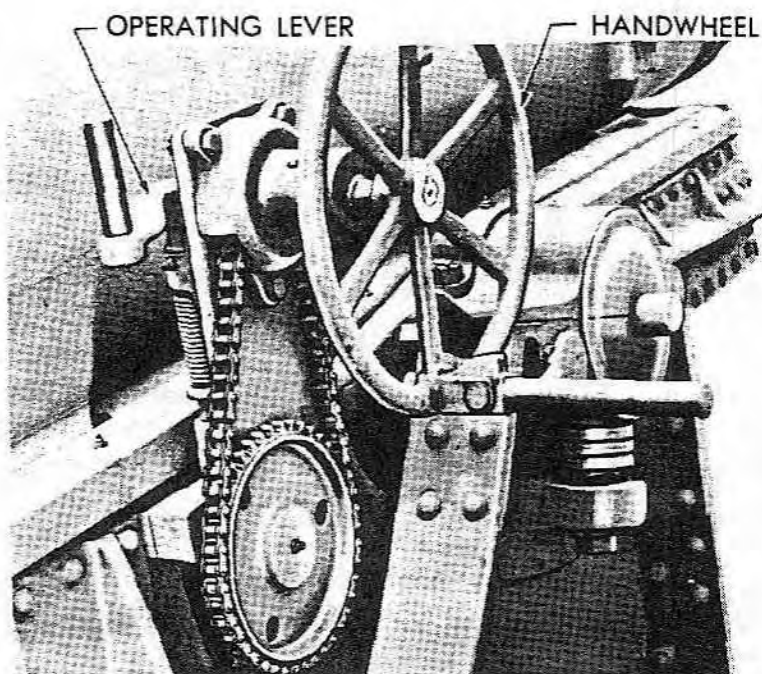

RA PD 72144

Figure 44 – Quick-loading Gear Mechanism

elevation or depression of the howitzer. Four and two-tenths turns of the handwheel elevate or depress the howitzer 45 degrees.

b. The quick-loading gear mechanism is attached to the right elevating arm and moves with this arm. It consists of a handwheel, attached to the handwheel shaft on which a sprocket is keyed. A roller chain on this sprocket and the quick-loading gear sprocket transmits movement from the handwheel through the hub pinion and quick-loading arc on the right side of the cradle.

c. The elevating arm also carries the quick-loading gear operating lever and vertical gear shaft which operate the left quick-loading mechanism lock rod. This rod serves to lock the elevating arcs against the lugs on the intermediate cradle bands; it also operates the firing gear locking lever.

16. TRAVERSING MECHANISM.

a. The traversing mechanism (fig. 45) is located on the left side of the top carriage and controls movement of the howitzer in azimuth. Range of traverse is 10 degrees either side of midposition. Approximately $13\frac{1}{2}$ turns of the handwheel traverse the carriage through 1 degree in azimuth.

b. As the traversing handwheel is operated, motion is transmitted

240-MM HOWITZERS M1918MI AND M1918MIA1, 240-MM HOWITZER CARRIAGE M1918A2, AND TRANSPORT WAGONS M4 AND M5

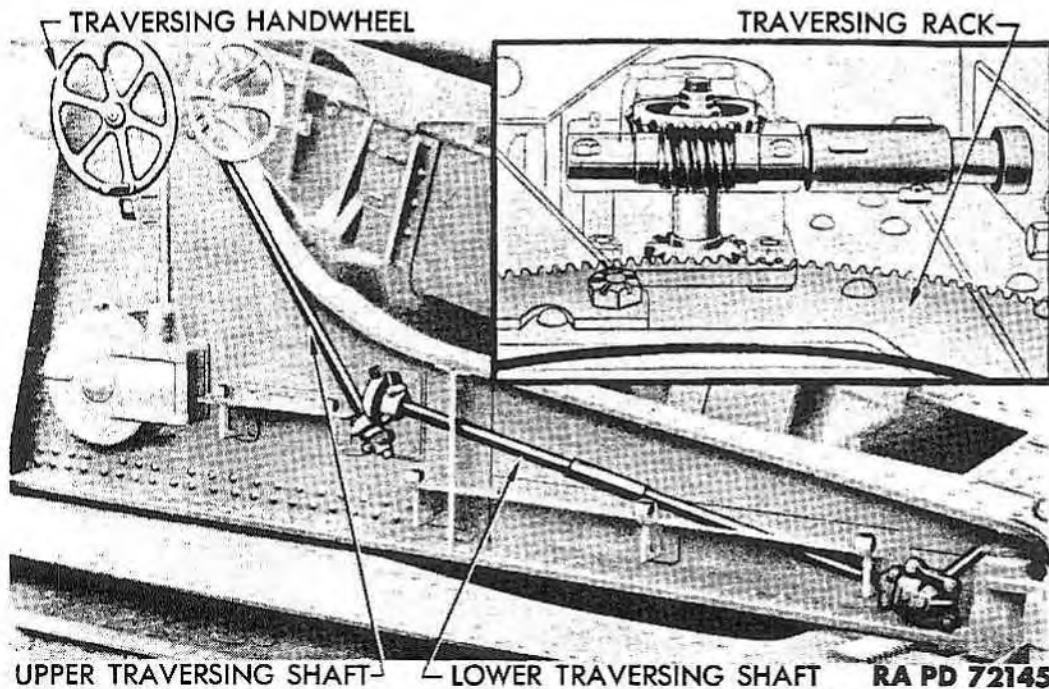

Figure 45 – Traversing Mechanism

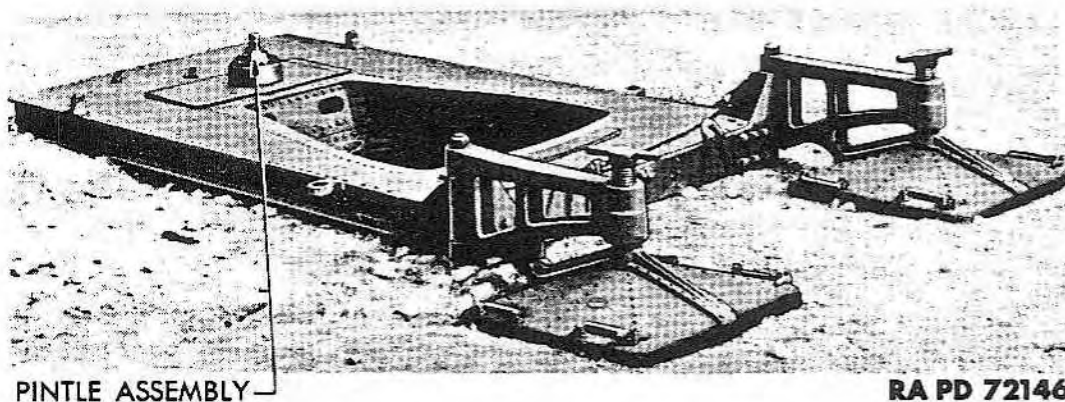

Figure 46 – Platform – Three-quarter Rear View – Emplaced

through the handwheel shaft, the upper and lower traversing shafts, the traversing worm shaft outer end extension, the traversing worm, traversing worm wheel, and traversing pinion to the traversing rack attached to the platform.

c. The traversing mechanism is supported in housings provided with bearings: at the handwheel by the elevating and traversing gear case, and the upper traversing gear case; at the intermediate gears

HOWITZER, CARRIAGE, TRANSPORT WAGONS, CRANE,
AND CLAMSHELL TRAILER

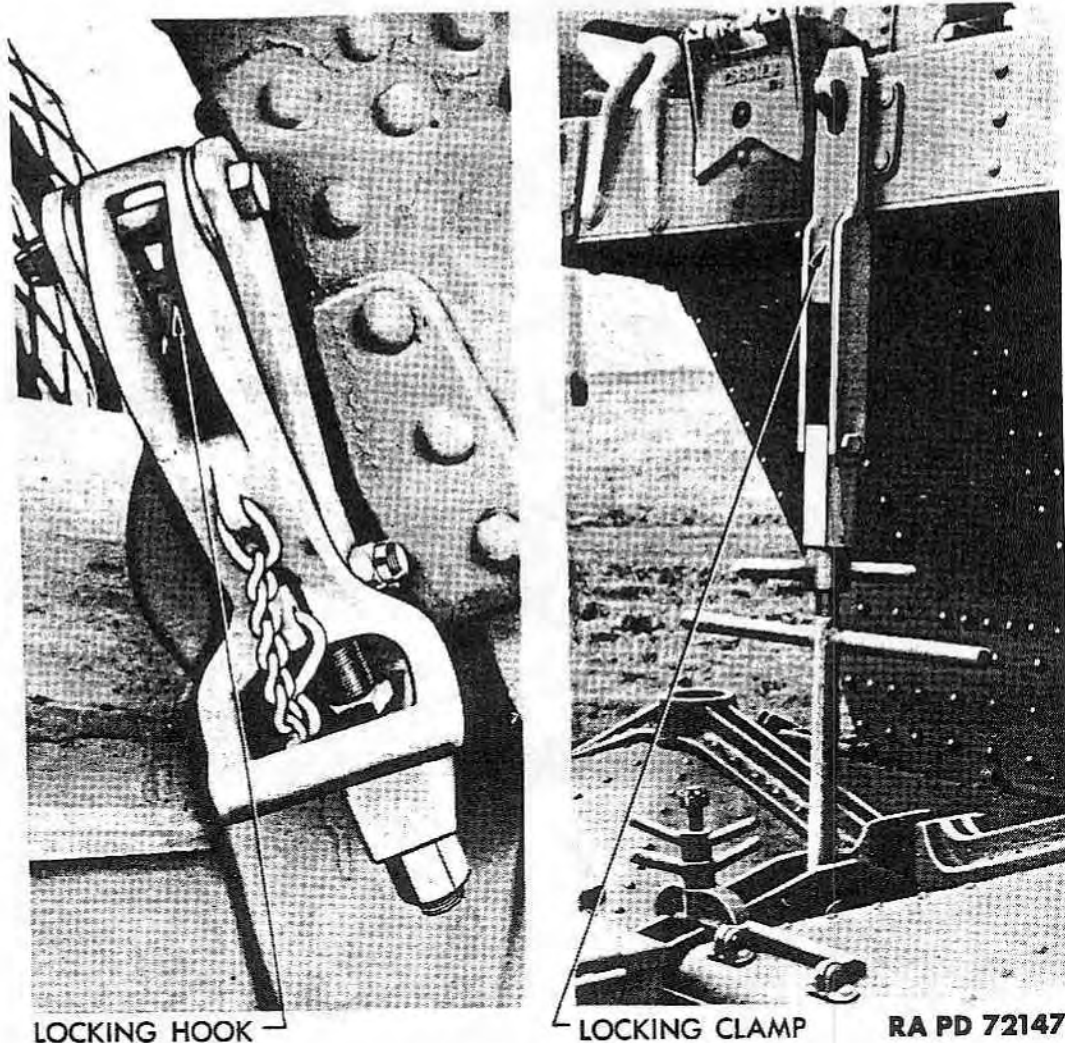

Figure 47 – Platform Locked to Transport Wagon M5, for Traveling

by the middle traversing gear housing; at the lower traversing gears by the lower traversing gear case, all of which are attached to the left flask of the top carriage. The traversing worm and worm wheel are enclosed by the worm and worm wheel housing supported by the top carriage bottom plate.

17. PLATFORM.

a. The platform (fig. 46) is made up of a top and bottom plate, each of which is provided with an opening for the cradle to tip in at high elevation. A pintle socket, containing the pintle assembly on which the top carriage pivots, is riveted to the platform near the front. At the rear end of the platform the traversing rack, the rear holding-down sector, and the locking bracket assembly are attached.

240-MM HOWITZERS M1918MI AND M1918MIA1, 240-MM HOWITZER
CARRIAGE M1918A2, AND TRANSPORT WAGONS M4 AND M5

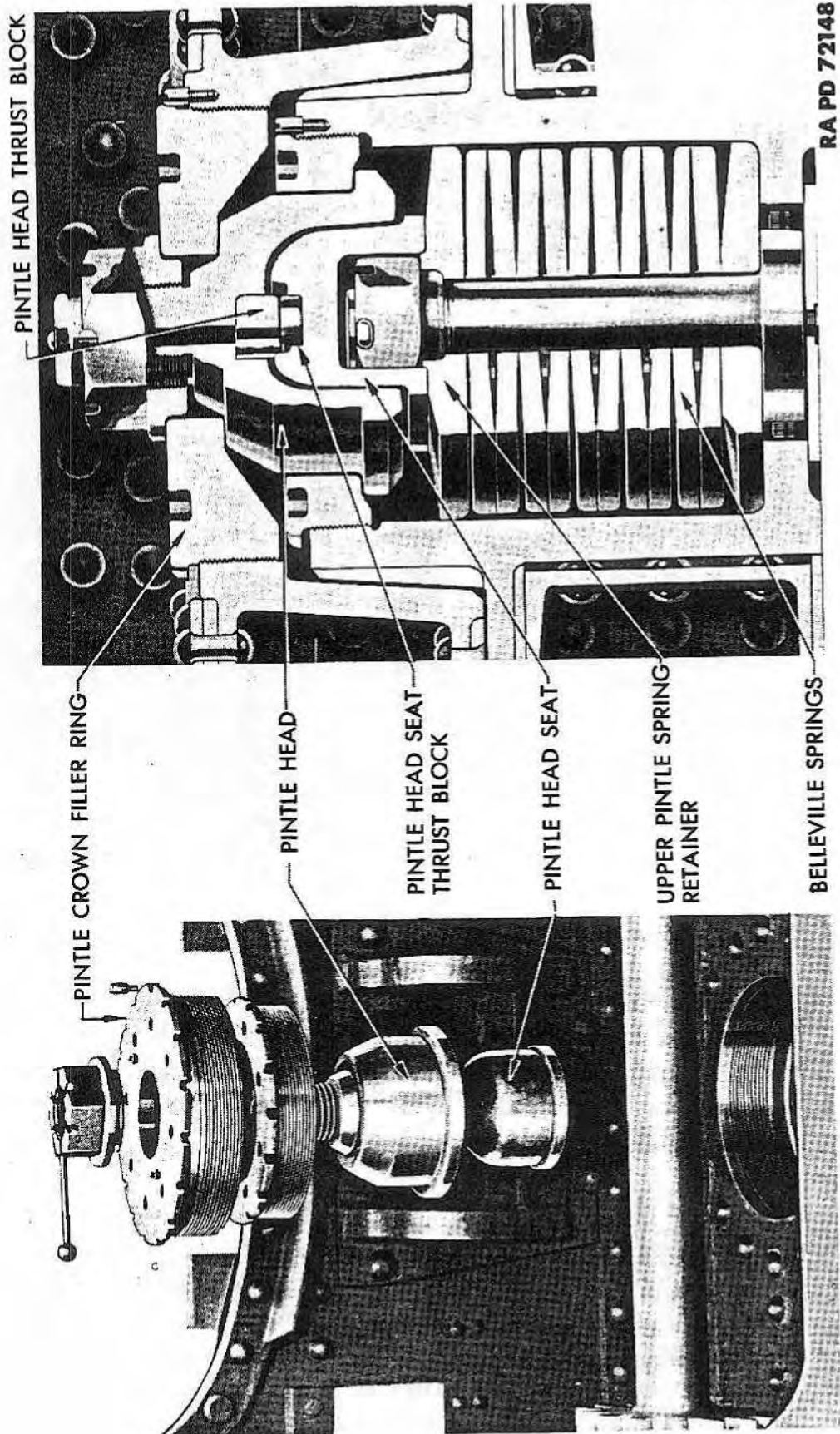

Figure 48 — Main Pintle Mechanism

HOWITZER, CARRIAGE, TRANSPORT WAGONS, CRANE,
AND CLAMSHELL TRAILER

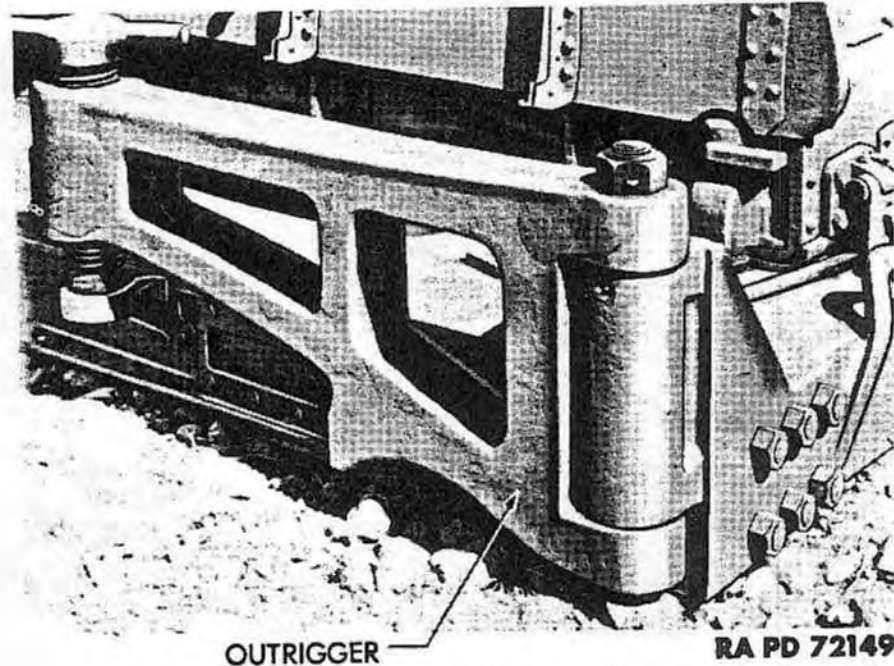

Figure 49 – Outrigger in Traveling Position

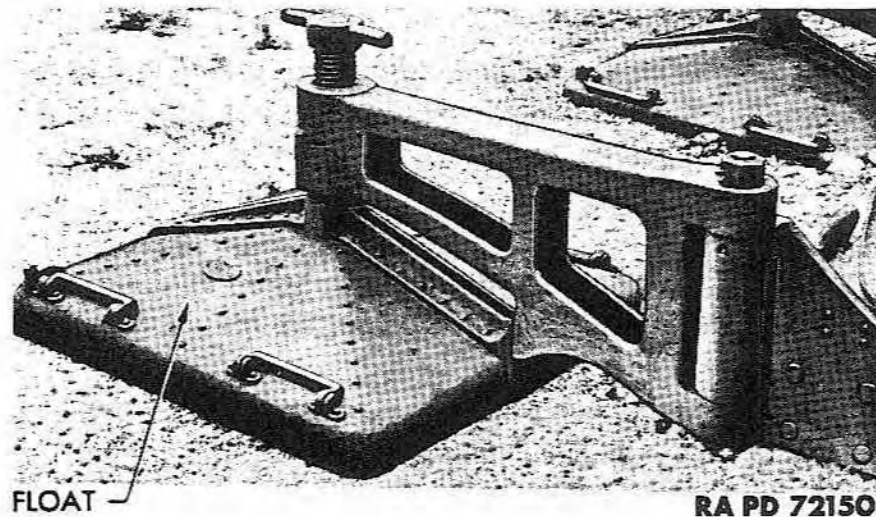

Figure 50 – Float in Firing Position

b. The trunk section of the platform is riveted to the base. In firing position, this section is emplaced in the ground and serves as a spade to prevent movement of the platform during firing. The platform trunk is so constructed that the howitzer, when elevated and recoiling, may tip into it. The cradle elevating stop, limiting elevation to 60 degrees, is attached to the inside of the front plate of the trunk.

c. In traveling position, the platform is locked to the Transport

240-MM HOWITZERS M1918MI AND M1918MIA1, 240-MM HOWITZER CARRIAGE M1918A2, AND TRANSPORT WAGONS M4 AND M5

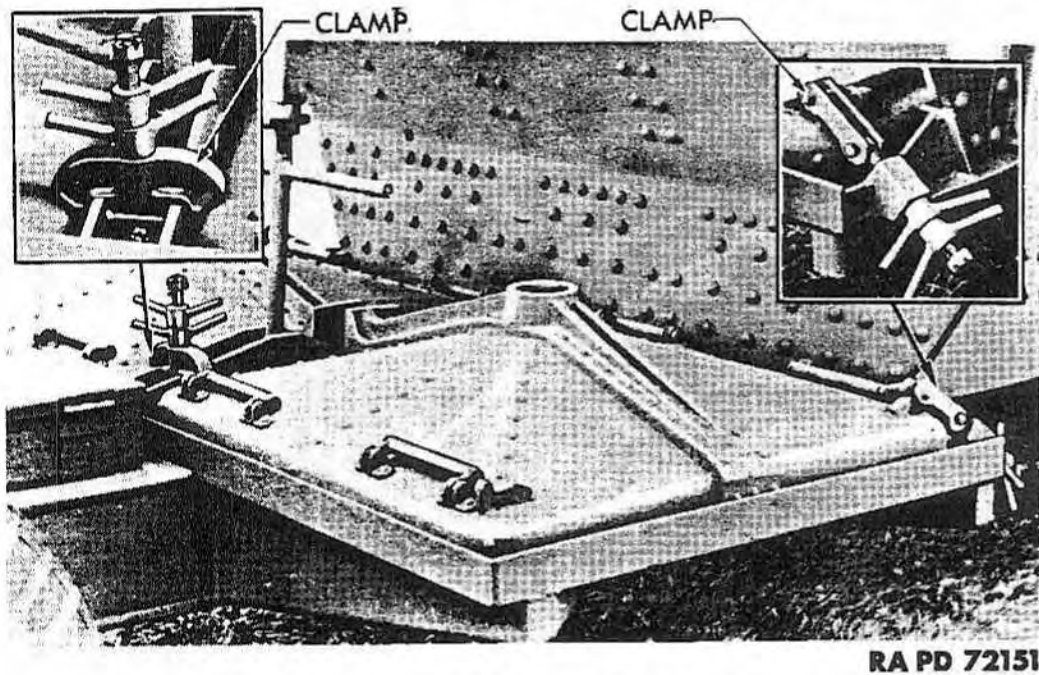

Figure 51 – Outrigger Floats in Traveling Position

Wagon M5, by means of locking hooks at the rear and a locking clamp at the front (fig. 47).

d. Suitable clamps are provided on the top front surface of the platform for carrying the loading ramp.

e. **Main Pintle Mechanism.**

(1) The main pintle mechanism (fig. 48) is located in the pintle socket, which is riveted to the platform. The Belleville springs of the pintle mechanism rest on a supporting disk in this socket, and are held in place by the pintle spring retaining bolt, spring retainer, and nut.

(2) Clearance between the top carriage and platform places the greater portion of the weight of the top carriage and howitzer on the main pintle mechanism; this weight is transmitted through the pintle crown filler ring, pintle head, pintle head thrust block, pintle head seat thrust block, and pintle head seat to the upper pintle spring retainer and springs. When the howitzer is fired, the pintle springs are compressed by the downward thrust on the top carriage so the bottom plate of the top carriage is in contact with the outer raised surface of the pintle socket plate, riveted to the top plate of the platform.

(3) Clearance between the top carriage and the platform should be 0.08 inch. The pintle crown filler ring is adjustable to maintain this clearance.

**HOWITZER, CARRIAGE, TRANSPORT WAGONS, CRANE,
AND CLAMSHELL TRAILER**

f. Outriggers.

(1) Two outrigger assemblies are attached to the rear end of the platform. When resting on the floats (fig. 50), they give stability to the mount, especially at extreme traverse positions during firing.

(2) The outrigger arms are retained in brackets on the platform by means of hinge pins. Screws in the outer ends of the outrigger arms contact the yokes of the outrigger floats, and provide adjustment for maintaining stability on uneven ground, or when the floats are forced into the ground by firing. In traveling position, the outrigger arms fold against the platform and are held in place by turning the screws into recesses provided for that purpose (fig. 49).

g. Floats.

(1) The outrigger floats are placed under the outrigger arm screws when the materiel is emplaced in firing position (fig. 50). Yokes riveted to the floats provide a bearing surface for the screws of the outriggers.

(2) In traveling position, the outrigger floats are carried on the transport wagon with the platform, and are retained thereto by means of clamps (fig. 51).

Section IV

**DESCRIPTION AND FUNCTIONING OF
TRANSPORT WAGONS**

18. TRANSPORT WAGONS.

a. General.

(1) Two high-speed Transport Wagons M4 and M5 are used to transport the materiel. Transport Wagon M4 carries the howitzer, sleigh, and cradle assembly, while the top carriage and platform assembly are carried on the M5 Transport Wagon.

(2) The transport wagons (fig. 52) are similar in appearance and construction, consisting of a welded box-type frame supported by front and rear axle assemblies. A drawbar assembly with lunette provides for attaching a prime mover. Each wagon is equipped with six pneumatic tires on disk wheels and rims, air brakes, at the rear wheels only and electric blackout tail lights.

(3) Power for the air brakes and current for the tail lights are supplied from the prime movers through air lines and cable connections respectively. The brakes may also be applied by hand for parking the vehicles.

TM 9-340
18

240-MM HOWITZERS M1918MI AND M1918MIA1, 240-MM HOWITZER
CARRIAGE M1918A2, AND TRANSPORT WAGONS M4 AND M5

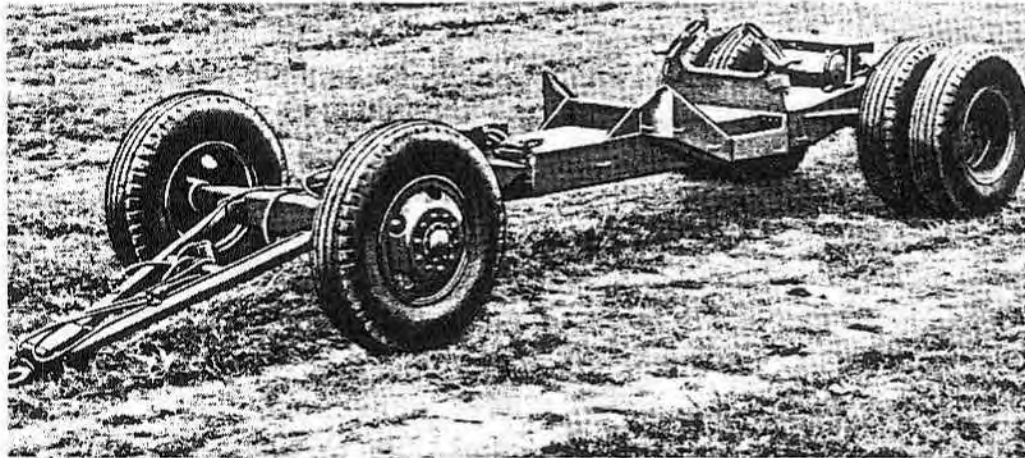

CANNON TRANSPORT WAGON M4

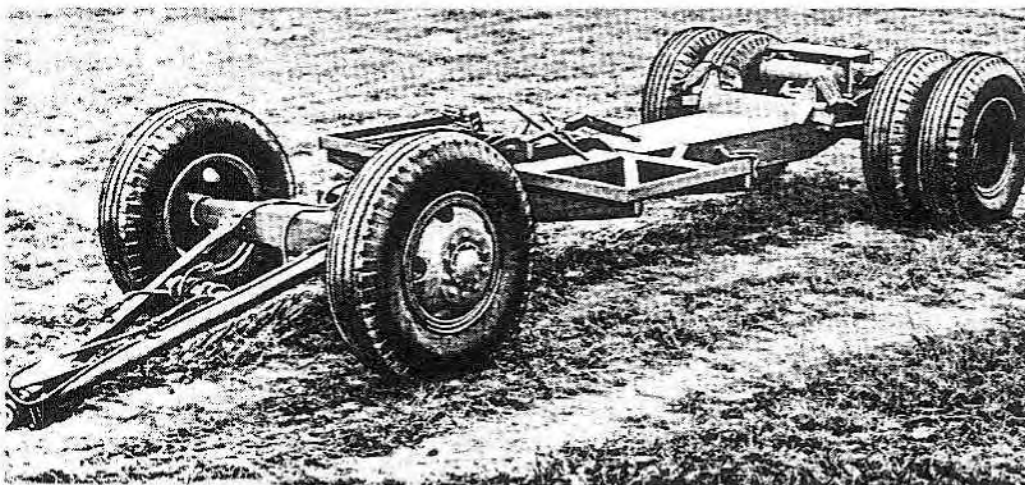

CARRIAGE TRANSPORT WAGON M5

RA PD 72152

Figure 52 – Transport Wagons M4 and M5 – Three-quarter Front
Views – Left Side

HOWITZER, CARRIAGE, TRANSPORT WAGONS, CRANE,
AND CLAMSHELL TRAILER

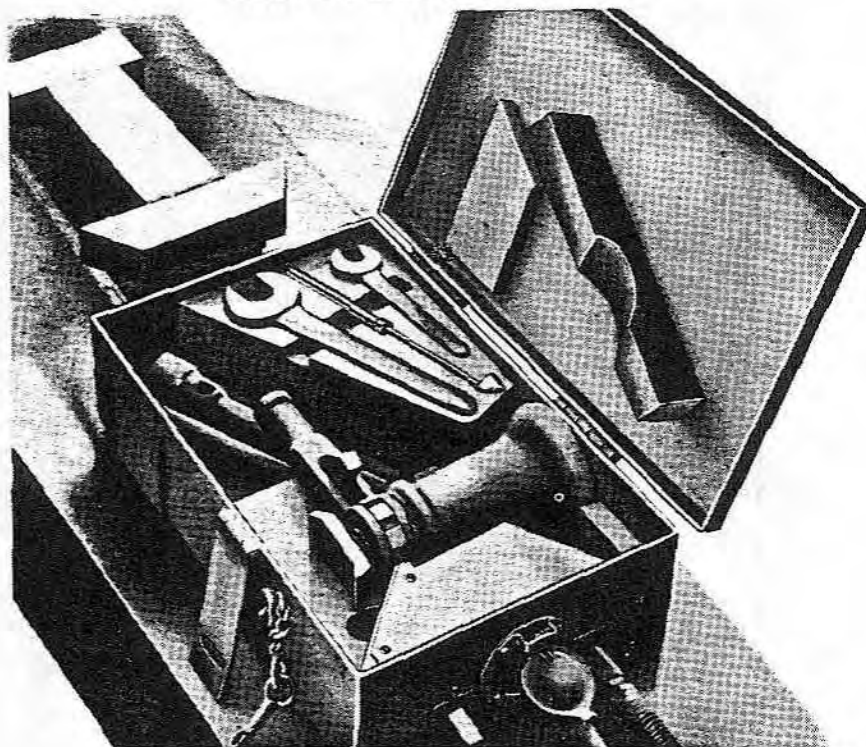

RA PD 72153

Figure 53 – Transport Wagon Tool Chest

(4) Each transport wagon carries a tool chest with a jack, tire pressure gage, and other essential tools (fig. 53). There is also storage space in the tool chest for the jumper cable for any materiel towed by the transport wagon. A wire socket for cable connection to the prime mover is mounted in the tool chest, and an additional socket is mounted on the rear of the frame to provide for cable connection to other equipment which may be towed by the transport wagon.

(5) A pintle assembly is provided on the rear of the transport wagon frame for towing other loads.

b. Frames.

(1) The frames of the transport wagons are of welded box-type construction, and are attached directly to the axles, as there are no springs on the transport wagons. Two supports on the Transport Wagon M4, together with the clamping hooks, hold the cradle assembly in place (fig. 54). The rear support is bolted to the wagon frame and conforms to the shape of the cradle. Box-like guards at the sides of the frame protect the elevating arcs during transport.

(2) The frame of Transport Wagon M5 is designed to carry the platform with top carriage attached, and the outrigger floats are carried on a wider portion near the front of the frame.

TM 9-340
18

240-MM HOWITZERS M1918MI AND M1918MIAT, 240-MM HOWITZER
CARRIAGE M1918A2, AND TRANSPORT WAGONS M4 AND M5

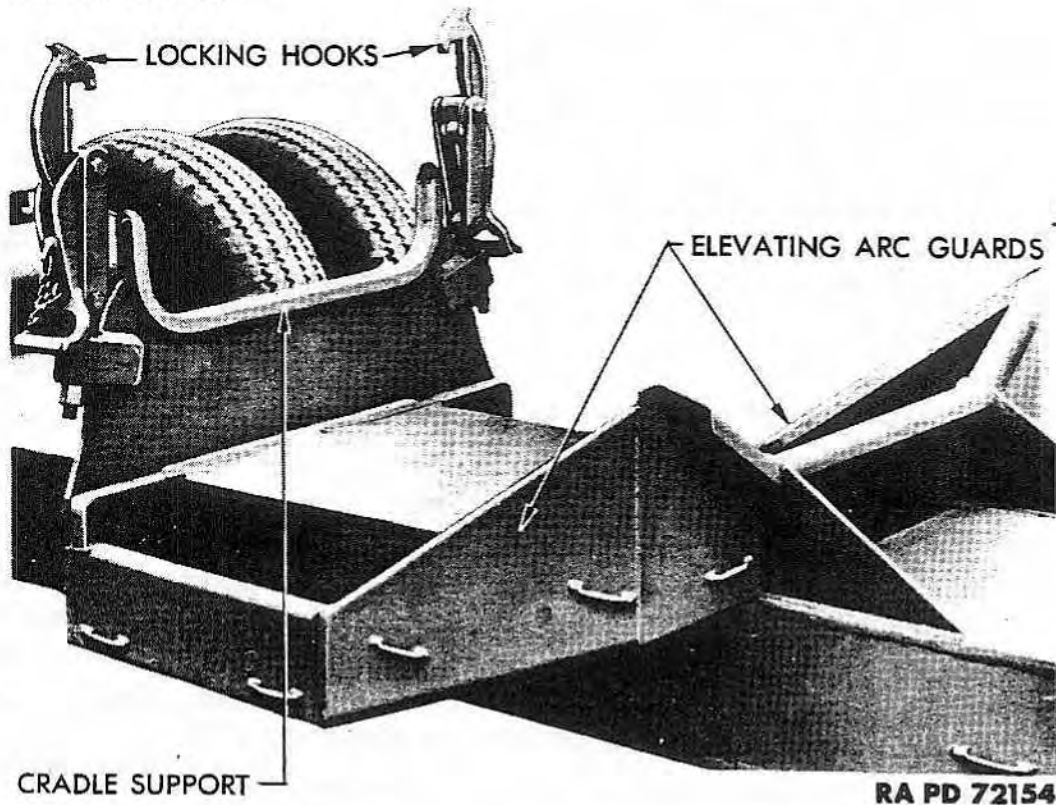
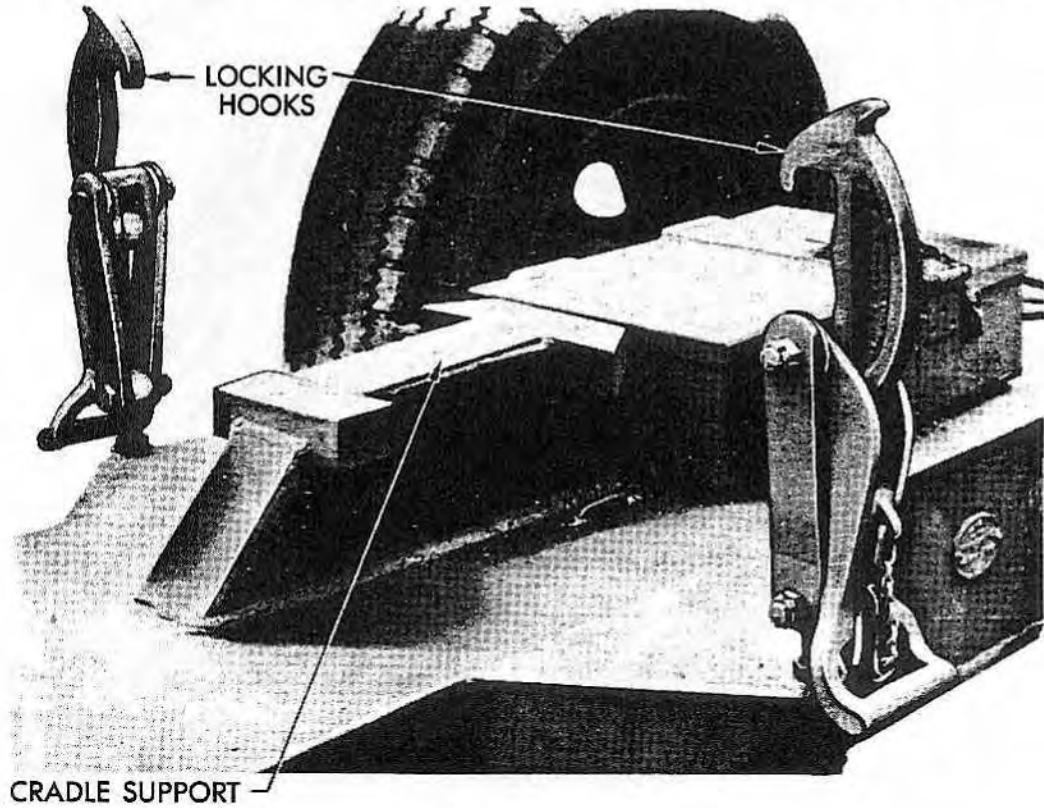

Figure 54 — Cradle Supports and Locking Mechanism on Transport Wagon M4

HOWITZER, CARRIAGE, TRANSPORT WAGONS, CRANE,
AND CLAMSHELL TRAILER

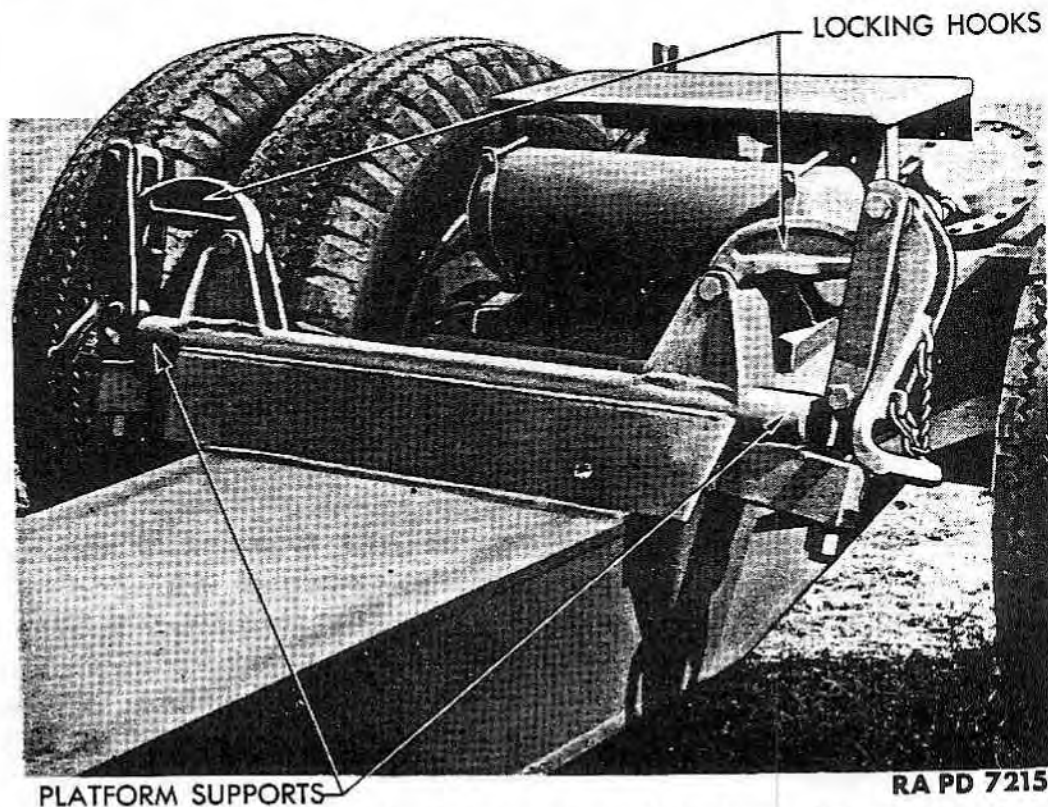
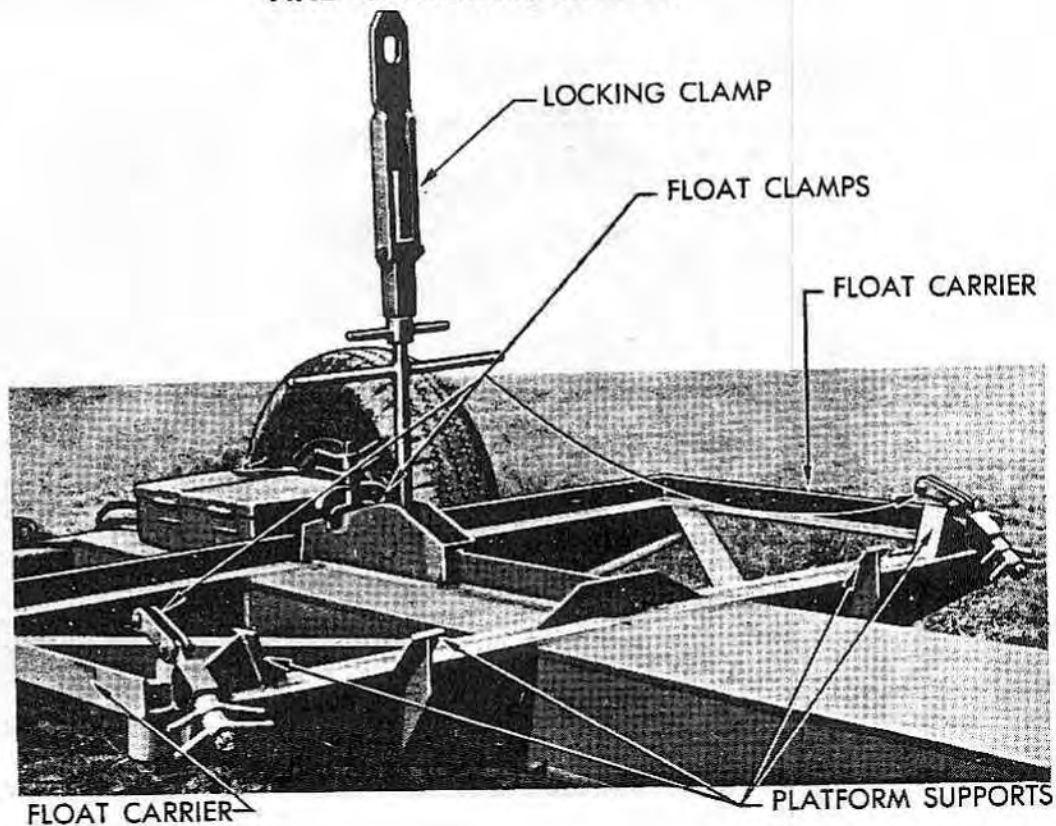
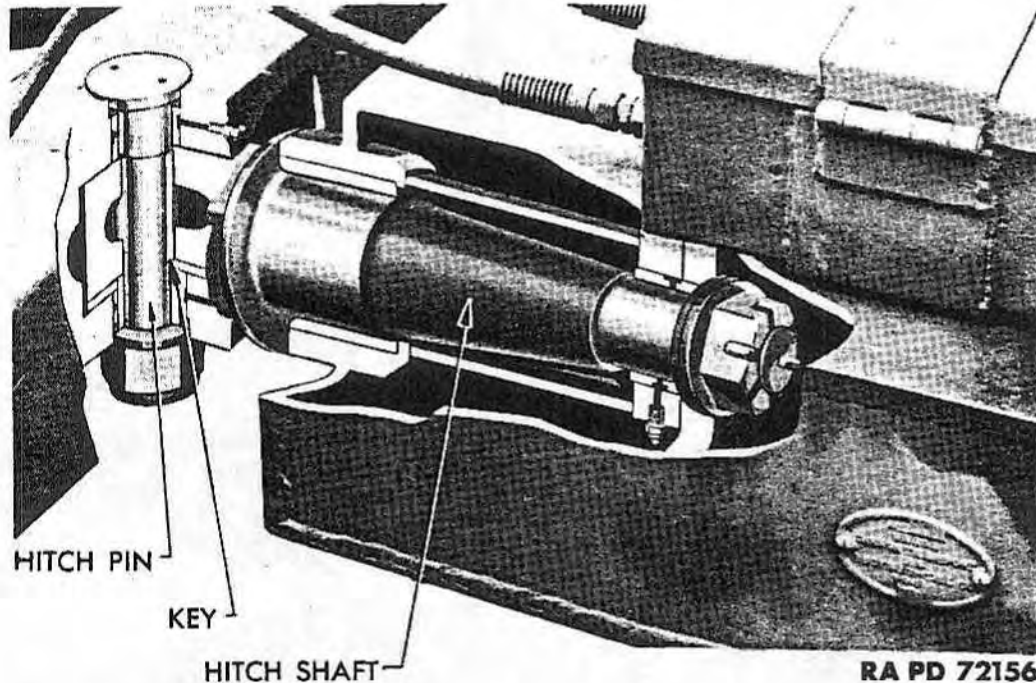

Figure 55 — Platform and Float Supports and Locking Mechanism on Transport Wagon M5

240-MM HOWITZERS M1918MI AND M1918MIA1, 240-MM HOWITZER
CARRIAGE M1918A2, AND TRANSPORT WAGONS M4 AND M5



**Figure 56 — Front Axle Connection to Frame of Transport Wagon —
Cut-away View**

(3) Locking devices for securing the loads are provided on the frames (fig. 55). On the Transport Wagon M4, there are two front and two rear locking hooks (fig. 54). Those at the front engage links on a bar passed through the rear end of the cradle, and those at the rear engage lugs on the sides of the cradle. On Transport Wagon M5, there are two locking hooks at the rear, engaging lugs on the trunk section of the platform, and a screw-type locking clamp at the front engages a lug on the platform plate. The floats are held in place by suitable clamps at opposite corners.

c. Front Axle.

(1) The front axle of each transport wagon is attached to the front end of the frame by means of a hitch pin and a hitch shaft (fig. 56) which permit the axle to swing for turning and also to oscillate to compensate for uneven road conditions. The hitch shaft is supported in suitable bushings in the front end of the wagon frame, and is retained in place by a nut at the rear end. The hitch pin is keyed to the front end of the hitch shaft and operates in bushings in the front axle. The front wheels are mounted on hubs on the front axle.

(2) The drawbar assembly is attached to the front axle by means of bolts and cotter pins.

HOWITZER, CARRIAGE, TRANSPORT WAGONS, CRANE,
AND CLAMSHELL TRAILER

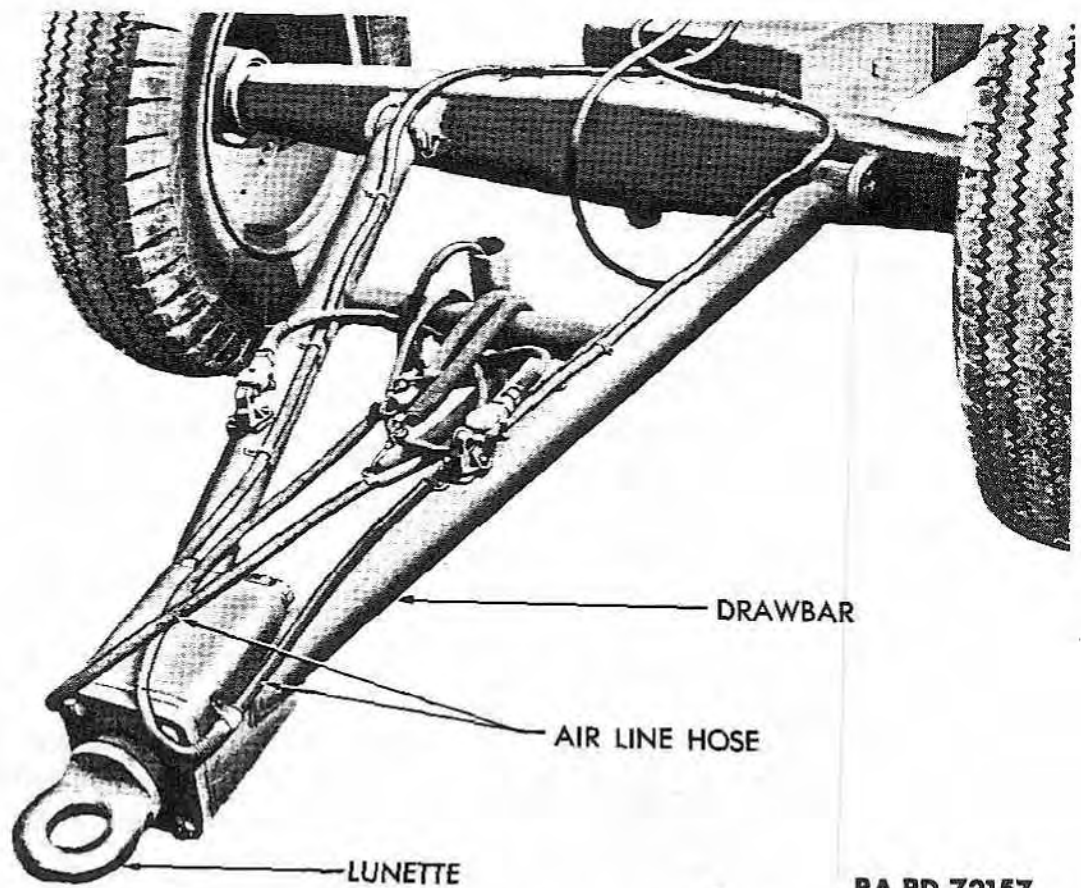
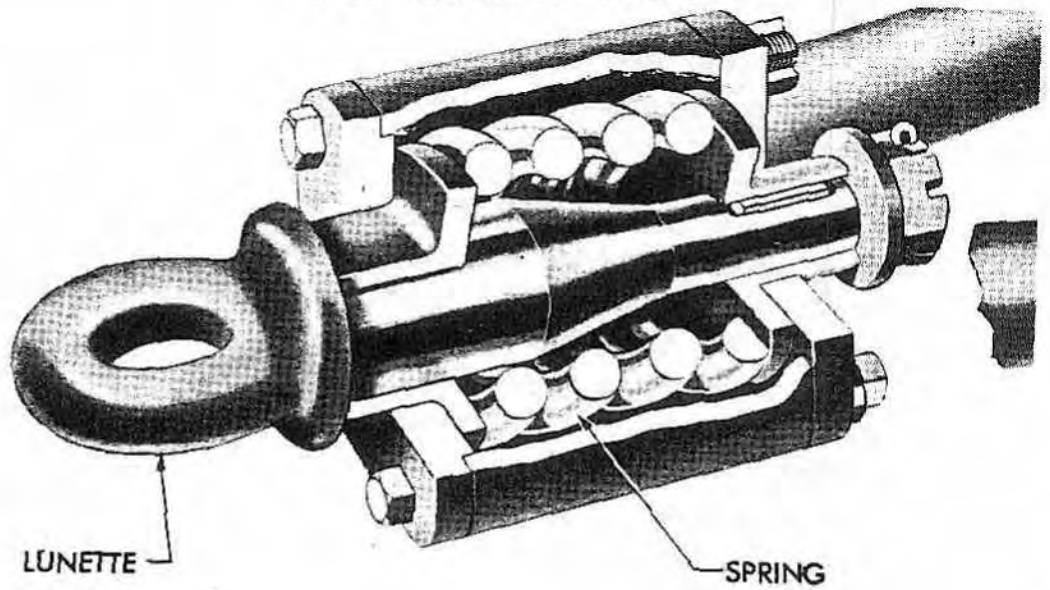

RA PD 72157

Figure 57 - Drawbar Assembly

240-MM HOWITZERS M1918MI AND M1918MIA1, 240-MM HOWITZER CARRIAGE M1918A2, AND TRANSPORT WAGONS M4 AND M5

d. Drawbar Assembly.

(1) The drawbar assembly for both transport wagons is of welded tubular construction, and is A-shaped (fig. 57). A spring-loaded lunette is provided at the front for attaching a prime mover. Air line hoses connecting the brake system to the prime mover are secured to the drawbar assembly by straps with machine screws. The hose connections engage dummy couplings on the drawbar when detached from the prime mover.

(2) The jumper cable plug for the prime mover is placed in a suitable container on the drawbar cross piece when detached from the prime mover.

e. Rear Axle. The rear axle is attached to the end piece of the transport wagon frame by means of U-bolts. Dual wheels are mounted on the rear axle.

19. BRAKES.

a. General.

(1) Braking on the Transport Wagons M4 and M5 is supplied by an air brake system which actuates the brake mechanism at the rear wheels. Application of the air brakes is controlled from the prime mover.

(2) The brakes are of the internal expanding type, having an upper and lower brake shoe, to which brake linings are attached (fig. 60). When the brakes are applied, either by the air actuating system, or by hand, the linings contact the surface of the brake drums to bring the vehicle to a stop. When air pressure is released, or the hand lever placed in the off position, brake shoe return springs return the brake shoes to normal position.

b. The air actuating system includes equipment on the prime mover, such as the air compressor, hose couplings, and cut-out cocks, as well as various units on the transport wagon, as described below.

(1) The air tank, relay-emergency valve, and air filters for the air brake system are mounted on the top rear of the wagon frame (fig. 58). A cover protects the relay-emergency valve and air filters. Air brake diaphragms are mounted on brackets attached to the rear of the frame.

(2) The relay-emergency valve relays brake action from the prime mover to the transport wagon brakes. It also provides for automatic application of the brakes in the event of a break-in-two between the prime mover and transport wagon.

(3) The air tank stores air for applying the transport wagon brakes for service and emergency brake application. A drain cock

HOWITZER, CARRIAGE, TRANSPORT WAGONS, CRANE,
AND CLAMSHELL TRAILER

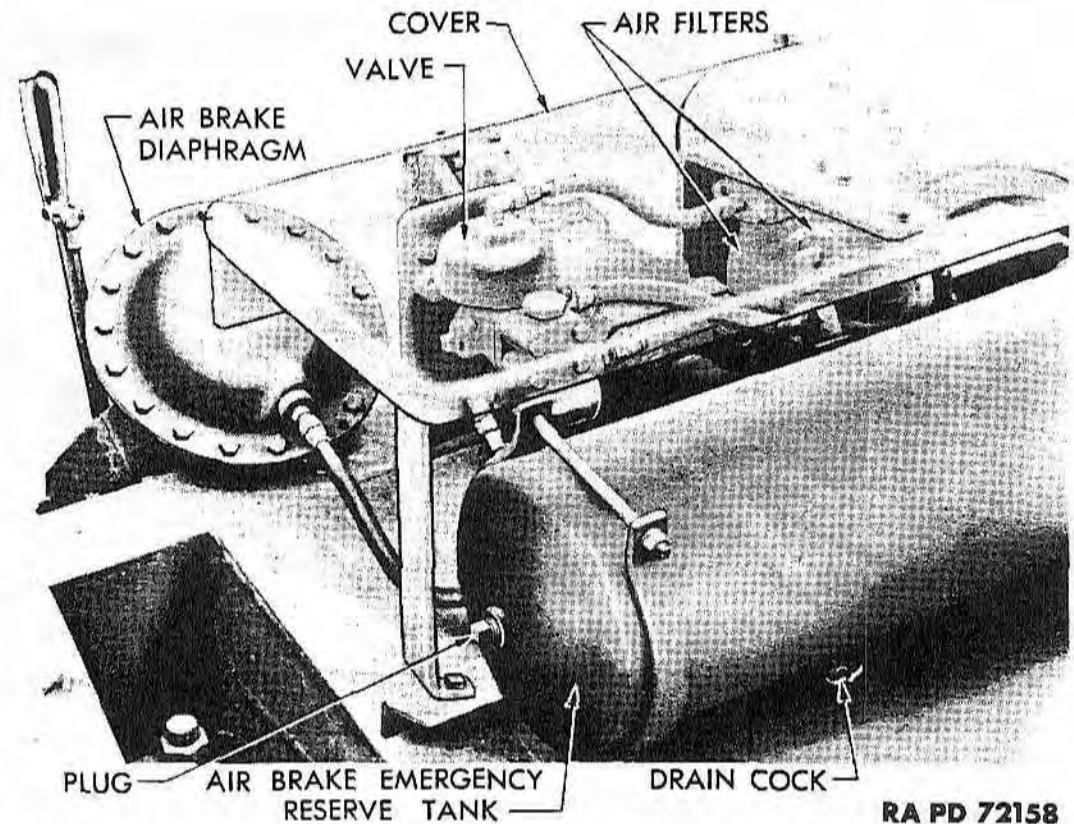

RA PD 72158

**Figure 58 – Emergency Relay Valve, Air Filters, and Air Tank –
Phantom View**

at the under side of the tank is provided for draining moisture from the tank; a plug at each end of the tank may be removed to relieve pressure if the brakes should become locked.

(4) Two air filters are provided, one for the service air line and one for the emergency air line. The purpose of the air filters is to remove any dust particles from the compressed air before it enters the relay-emergency valve.

(5) Two air brake diaphragms, one for each brake, are mounted on brackets attached to the rear of the transport wagon frame. The diaphragms actuate the slack adjusters to apply the brakes.

(6) The slack adjusters are mounted on the brake cam shafts which are supported on the axle (fig. 62). They form the connection between the brake diaphragms and the brake shoe actuating mechanism. The slack adjusters also provide a quick and simple means of adjusting the brakes.

(7) AIR LINES.

(a) The service air line (fig. 59) is identified by the word "SERVICE" on the coupling which engages the hose from the prime

240-MM HOWITZERS M1918MI AND M1918MIA1, 240-MM HOWITZER CARRIAGE M1918A2, AND TRANSPORT WAGONS M4 AND M5

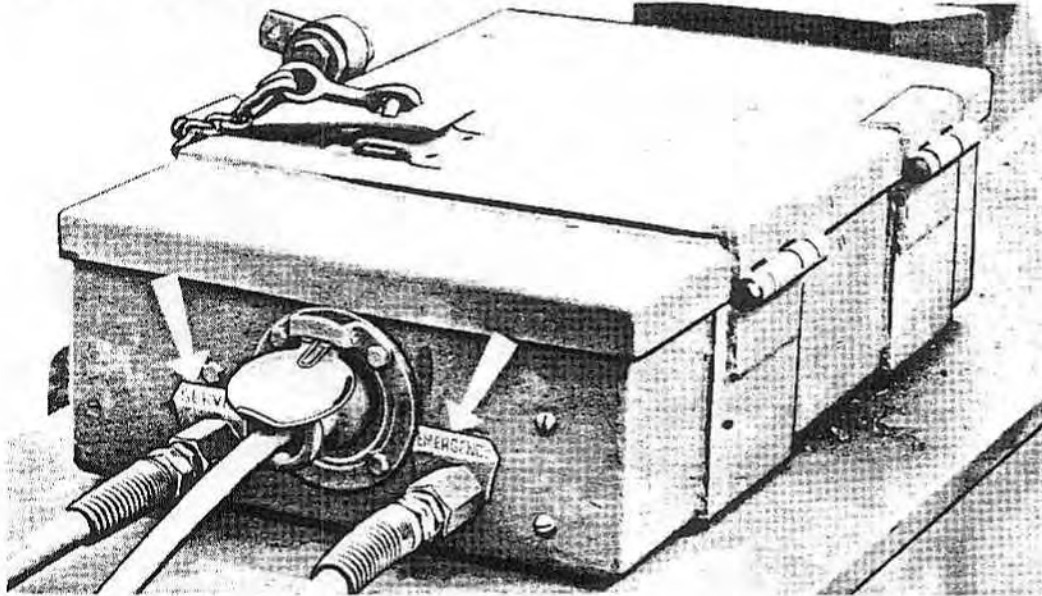

RA PD 72159

Figure 59 – The Service and Emergency Air Lines Are Identified by Name Plates on the Tool Chest

mover. It is connected to one of the air filters on the rear of the frame. This air line supplies air pressure to operate the relay portion of the relay-emergency valve.

(b) The emergency air line (fig. 59), identified by "EMERGENCY" on the coupling, connects the emergency line of the prime mover and the other air filter on the rear of the frame. Through this air line, the transport wagon air tank is kept charged at all times.

CAUTION: In making air line hose couplings between vehicles, the flexible hoses must be crossed over each other to prevent locking of the brakes.

(c) The air lines are piped from front to rear through the hollow frame of the transport wagons.

c. Brake Mechanism.

(1) The brake mechanism, located at the rear wheels, includes the brake shoes, with brake linings, brake shoe pivot pins, brake shoe return springs, and the brake cam shafts, together with their related parts (fig. 60).

(2) When the brakes are applied, the brake cams are rotated and spread the brake shoes apart, causing the brake linings to contact the inner surface of the brake drums and thus stop the wheels from turning. Brake shoe return springs, hooked to the brake shoes, return the shoes to normal position as the brakes are released.

HOWITZER, CARRIAGE, TRANSPORT WAGONS, CRANE,
AND CLAMSHELL TRAILER

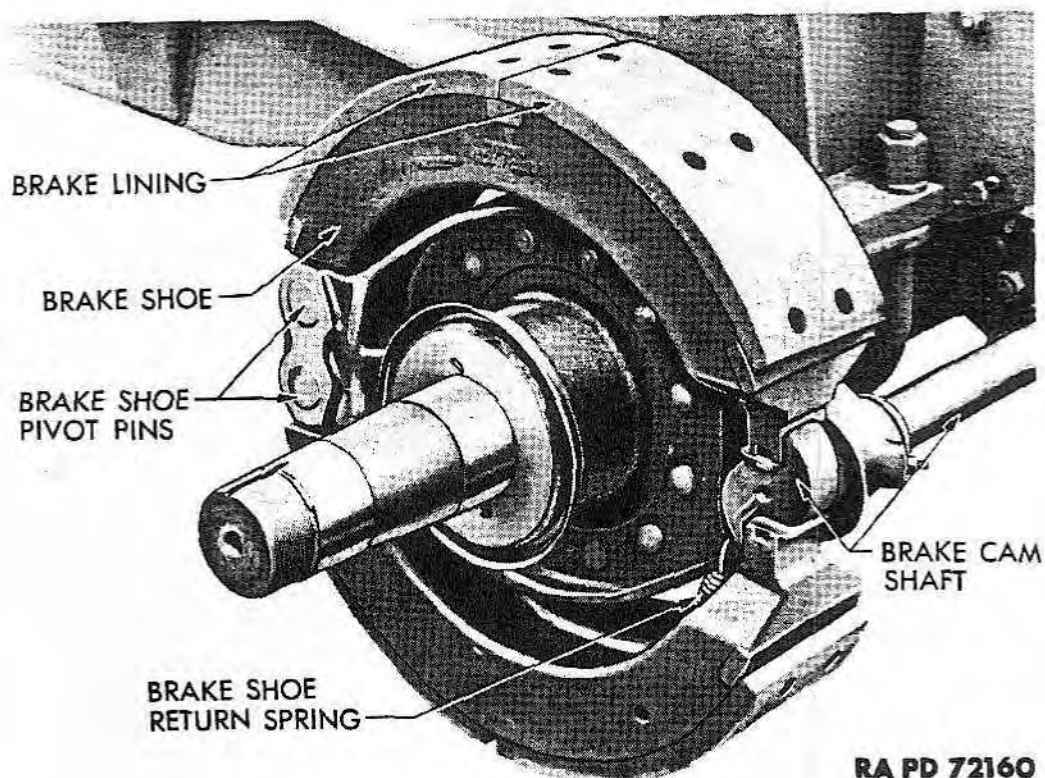

RA PD 72160

Figure 60 – Brake Mechanism

d. Functioning of Air Brakes.

(1) FILLING THE AIR BRAKE EMERGENCY RESERVE TANK.

(a) When the transport wagon air lines are connected to the prime mover and the cut-out cocks are opened, air passes through the emergency line and enters the bottom of the lower or emergency portion of the relay-emergency valve (fig. 61). It raises the lower diaphragm, breaking the service seal, and flows upward to the transport wagon reserve air tank, building up a pressure equal to the prime mover air tank pressure.

(b) With pressure on both sides of the lower diaphragm thus equalized, the emergency valve spring holds the diaphragm up to close the emergency seal. It also holds the emergency valve away from its seat. The emergency line thus keeps the transport wagon air tank charged at all times.

(2) SERVICE BRAKE APPLICATION.

(a) When the brakes are applied, pressure is introduced into the

240-MM HOWITZERS M1918MI AND M1918MIA1, 240-MM HOWITZER
CARRIAGE M1918A2, AND TRANSPORT WAGONS M4 AND M5

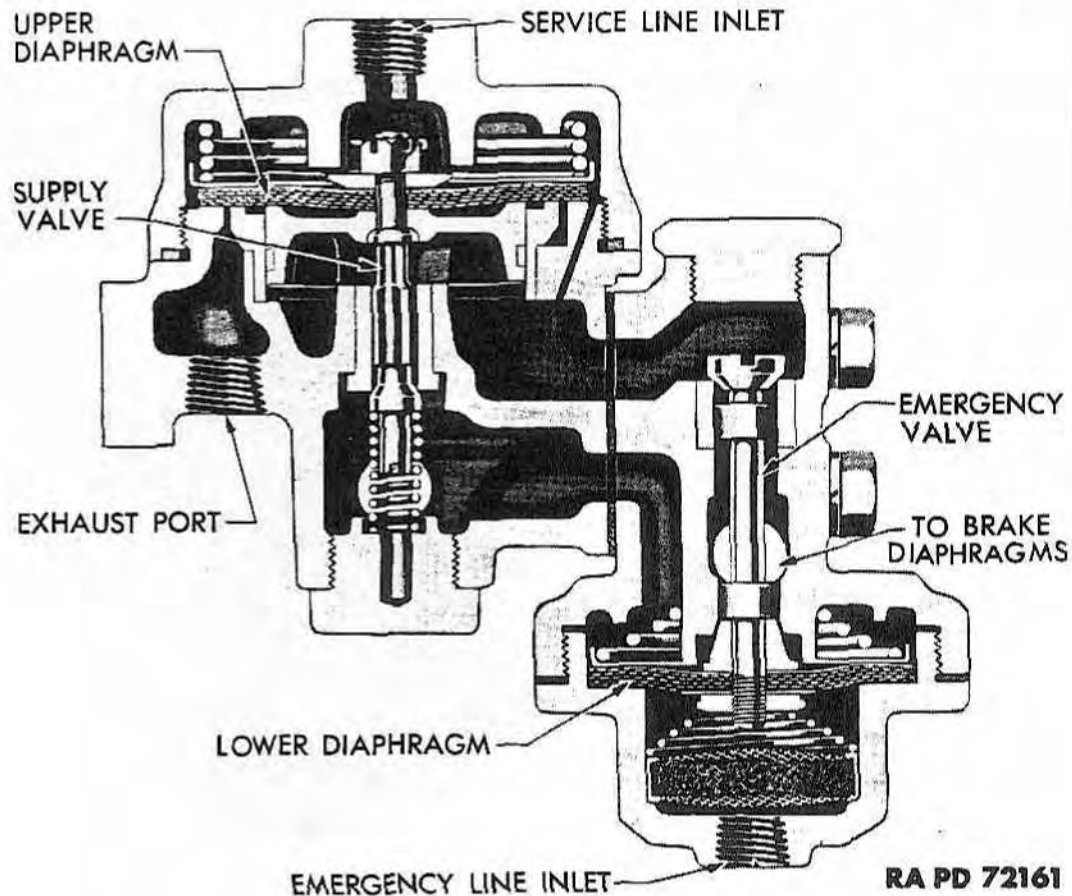

Figure 61 — Emergency Relay Valve — Sectional View

top or relay portion of the relay-emergency valve (fig. 61). This deflects the upper diaphragm downward, sealing the exhaust port and unseating the supply valve, allowing tank air pressure to pass upward around its stem and thence past the unseated emergency valve to the air brake diaphragms, applying the brakes.

(b) When air brake diaphragms pressure has built up equal to that on top of the upper relay valve diaphragm, the supply valve spring forces the supply valve up to its seat to close off further air from the air tank. This movement still leaves the exhaust sealed by the diaphragm. If a greater application is made at the brake valve, these actions are repeated to increase the pressure accordingly.

(c) If the brake valve is partially released, the drop in pressure above the upper diaphragm allows the greater air brake diaphragm pressure beneath it to lift the relay valve diaphragm, breaking the exhaust seal and passing sufficient brake diaphragm pressure to equal the service line pressure. Then, the relay valve diaphragm is again deflected downward to prevent further exhaust. Complete release

HOWITZER, CARRIAGE, TRANSPORT WAGONS, CRANE,
AND CLAMSHELL TRAILER

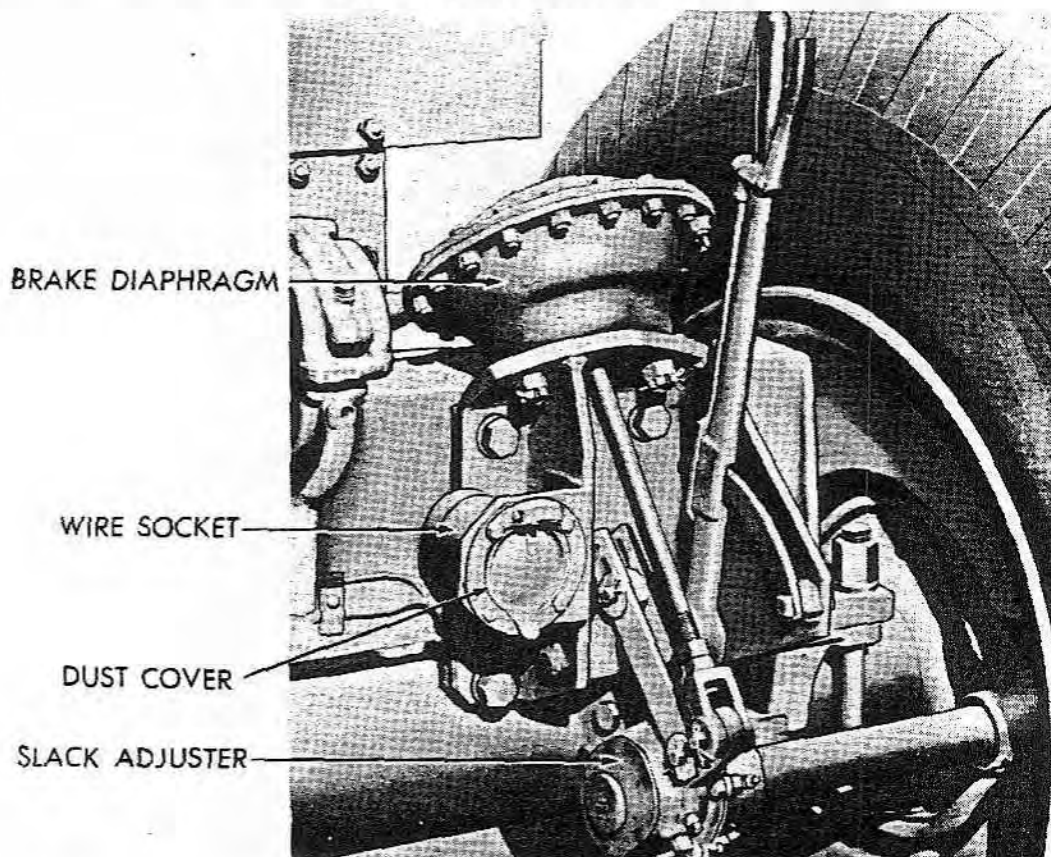

RA PD 22493

Figure 62 – Air Brake Diaphragm and Slack Adjuster in Mounted Position

allows all the air brake diaphragm pressure to escape, leaving the valve in the released position.

(3) **EMERGENCY BRAKE APPLICATION.**

(a) Should the transport wagon break away from the prime mover, or the emergency air line hose burst, the sudden reduction in pressure will remove the pressure from below the lower diaphragm in the relay-emergency valve (fig. 61).

(b) The result will be that the pressure from the transport wagon air tank will act upon the upper side of the lower relay valve diaphragm, deflecting it downward. This will break the emergency seal and permit air from the transport wagon air tank to flow upward around the emergency valve stem and thus produce an emergency application of the transport wagon brakes.

(c) At the same time, the emergency valve will be drawn downward to its seat by the movement of the diaphragm, cutting off any opportunity for air to escape by way of the exhaust. Also, the service seal will be closed so that the brake will be held applied without leakage through the ruptured emergency line.

240-MM HOWITZERS M1918MI AND M1918MIA1, 240-MM HOWITZER
CARRIAGE M1918A2, AND TRANSPORT WAGONS M4 AND M5

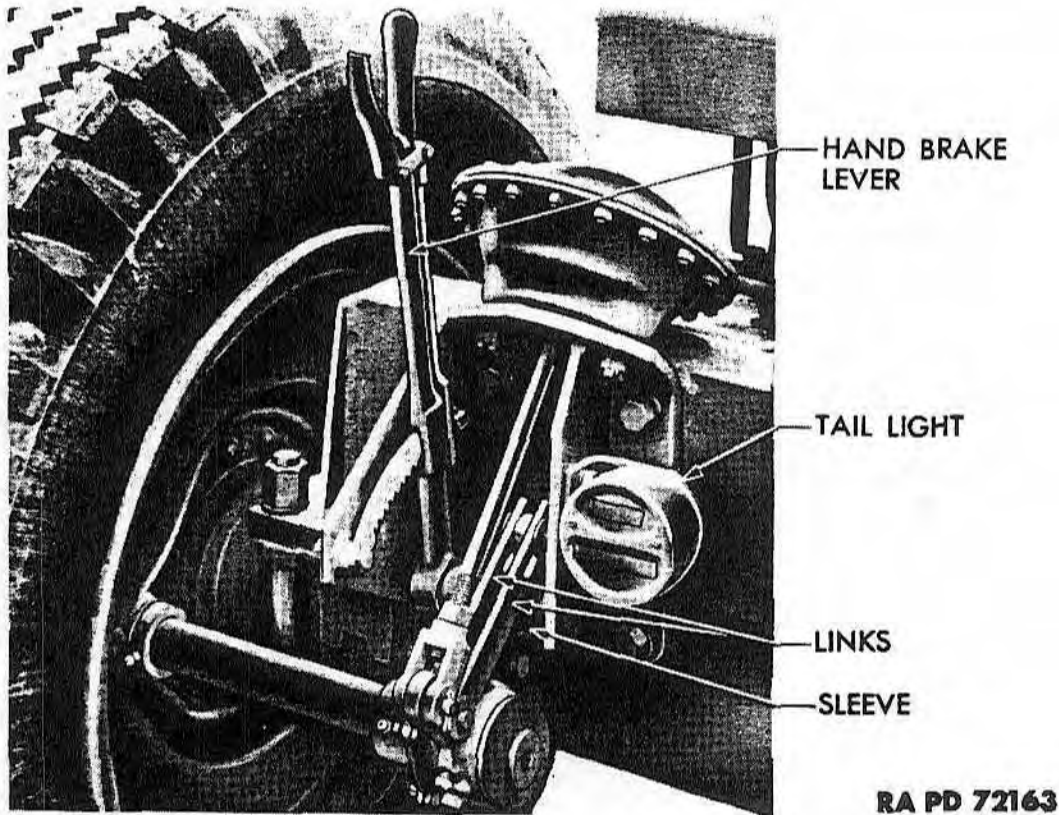

Figure 63 — Hand Brake Mechanism — Left Side

(4) AIR BRAKE DIAPHRAGMS.

(a) The air brake diaphragms (fig. 62) comprise two dished plates between which is a diaphragm made of oilproof rubberized fabric. The diaphragm is airtight and responds to slight variations in pressure. The diaphragm divides the chamber into two halves, known as the nonpressure and pressure sides.

(b) Spring action on the nonpressure side of the diaphragm holds the push rod plate against the diaphragm in its released position, forcing the diaphragm into the pressure side. When compressed air enters the pressure side, it forces the diaphragm and push rod plate toward the nonpressure side.

(c) A brake push rod is fastened to the push rod plate, and power exerted against the diaphragm of the air brake diaphragm and push rod plate forces the push rod out. The yoked outside end of the push rod is hinged to the slack adjuster, which acts as a lever to rotate the brake cam shaft. This in turn causes the cams to spread the brake shoes, expanding them to apply the brake linings to the braking surface inside the brake drums.

**HOWITZER, CARRIAGE, TRANSPORT WAGONS, CRANE,
AND CLAMSHELL TRAILER**

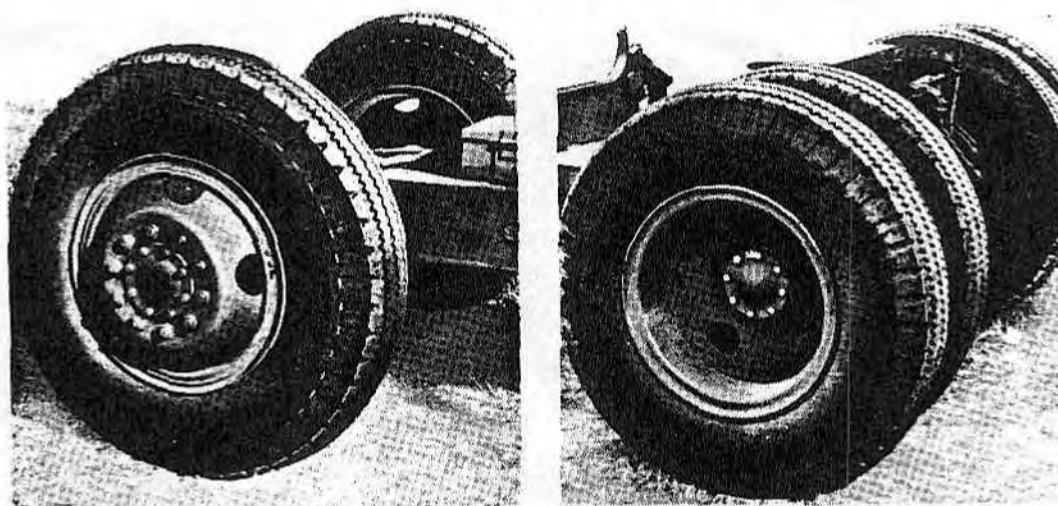

FRONT WHEELS

REAR WHEELS

RA PD 72164

Figure 64 — Front and Rear Wheel Assemblies

e. Hand Brakes.

(1) A hand lever (fig. 63) is provided for each brake on Transport Wagons M4 and M5, for parking the vehicles. The lower end of the hand brake lever is mounted on a sleeve, which in turn is pivoted on a pin in the air brake diaphragm bracket. An arm on the hand lever sleeve is connected to the slack adjuster by suitable links. The hand lever latch engages the latch plate, mounted on the air brake diaphragm bracket for keeping the brakes applied.

(2) The spring-loaded hand grip lever is attached to the upper end of the brake lever and is connected to the latch, which operates against the latch plate.

(3) When the hand brake is applied, the hand lever rotates the lever sleeve, which, in turn operates the slack adjuster to rotate the brake cam shaft and apply the brakes. The air brake diaphragm push rod is also attached to the slack adjuster, but because of the design of the links between the slack adjuster and hand lever sleeve, the hand brake mechanism is not affected when the brakes are applied by air.

20. ELECTRICAL EQUIPMENT.

a. The electrical equipment on Transport Wagons M4 and M5 includes for each vehicle a rear blackout tail light, a wire socket in the front of the tool chest, and a wire socket mounted on the right air brake diaphragm bracket, together with the wires connecting these units and the jumper cable.

240-MM HOWITZERS M1918MI AND M1918MIA1, 240-MM HOWITZER
CARRIAGE M1918A2, AND TRANSPORT WAGONS M4 AND M5

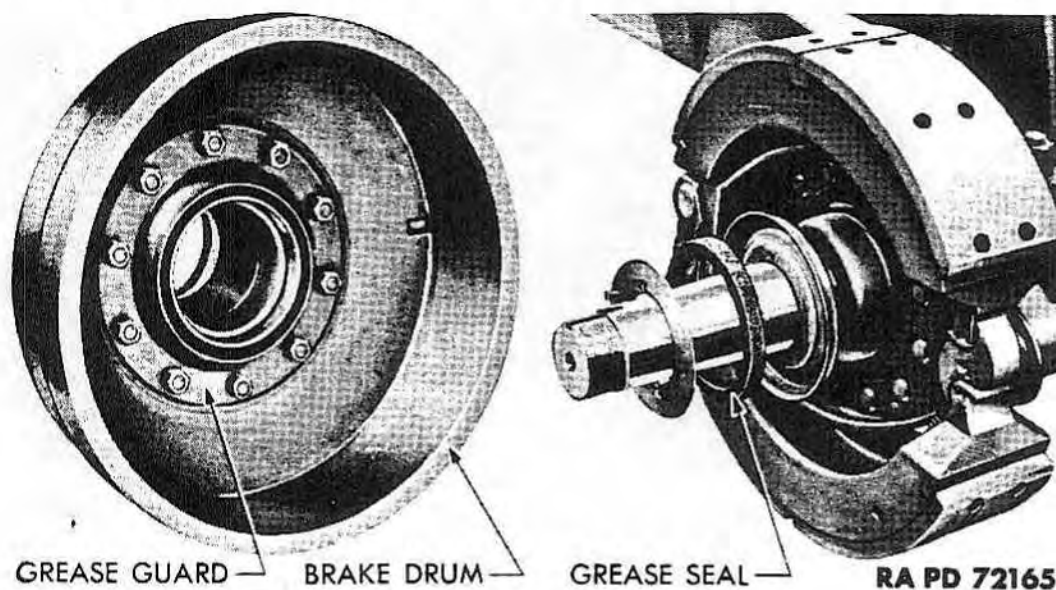

Figure 65 – Brake Drum Removed and Grease Seal Disassembled

(1) The electric blackout tail light is mounted on the left air brake diaphragm bracket, and is connected by wires to the wire socket in the front of the tool chest (fig. 63).

(2) The wire socket in the front of the tool chest receives the plug of the jumper cable from the prime mover. A dust cover is held in place by a spring when the socket is not in use.

(3) The wire socket on the right air brake diaphragm bracket is connected to the one in the front of the tool chest; it may be used for attaching a cable to supply current to equipment towed by the transport wagon. This socket is also provided with a spring locked dust cover (fig. 62).

(4) The wires connecting the sockets and blackout tail light are held in place at the rear end of the frame by means of clamps and machine screws. Both the electric wires and the air lines extending from the front to the rear of the transport wagon are carried within the hollow frame.

21. WHEELS, HUBS, AND TIRES.

a. **Wheels.** Six wheels are used on each transport wagon, two on the front axle and four on the rear axle (fig. 64). The wheels are dish-shaped disks with tire rims riveted and welded to them. Each front wheel is attached to the hub with ten wheel stud nuts; the dual wheels on the rear are both secured on the same studs by ten wheel stud nuts for each wheel. The wheel retaining nuts on the left side of the transport wagons have left-hand threads.

HOWITZER, CARRIAGE, TRANSPORT WAGONS, CRANE,
AND CLAMSHELL TRAILER

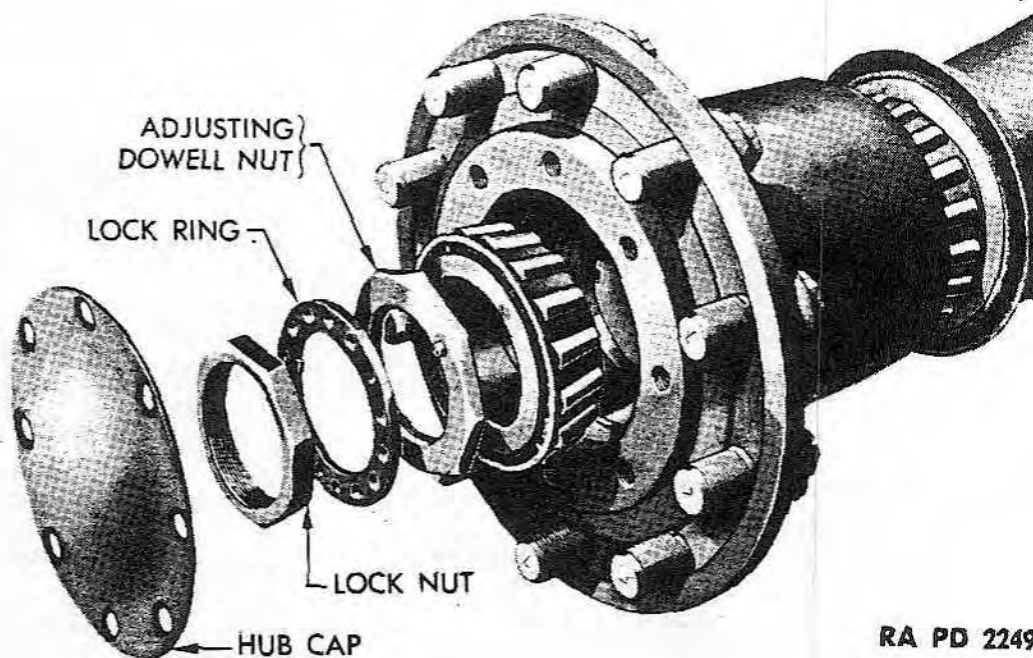

RA PD 22494

Figure 66 – Hub Assembly – Exploded View

h. Hubs.

(1) The hubs are supported on the bearing surfaces of the axle spindles by tapered roller bearings. The brake drums and grease guards for the rear wheels are bolted to the inner surface of the hub flange (fig. 65), while the wheels are fastened to the outer surface of the flange by studs and nuts.

(2) The inner bearing of each wheel seats against a shoulder inside the hub. This bearing is reached for greasing and inspection by removing the hub from the spindle.

(3) The grease seal and retaining parts (fig. 65) for each wheel are fastened directly to the axle, and operate against a machined surface inside of the hub.

(4) The outer bearing and the entire hub assembly are secured to the spindle, and are adjusted by means of an adjusting dowel nut, a lock ring, and a hexagonal lock nut (fig. 66). The adjusting dowel nut is screwed against the outer bearing until the bearings are properly adjusted. This nut is provided with a dowel which enters the appropriate hole of the lock ring, which is placed next to it on the spindle. The lock ring, in addition to having a number of holes near its circumference, has a lug in its inner circumference shaped to fit the groove in the upper surface of the spindle. This lug serves to keep the lock ring from turning on the spindle.

240-MM HOWITZERS M1918MI AND M1918MIA1, 240-MM HOWITZER
CARRIAGE M1918A2, AND TRANSPORT WAGONS M4 AND M5

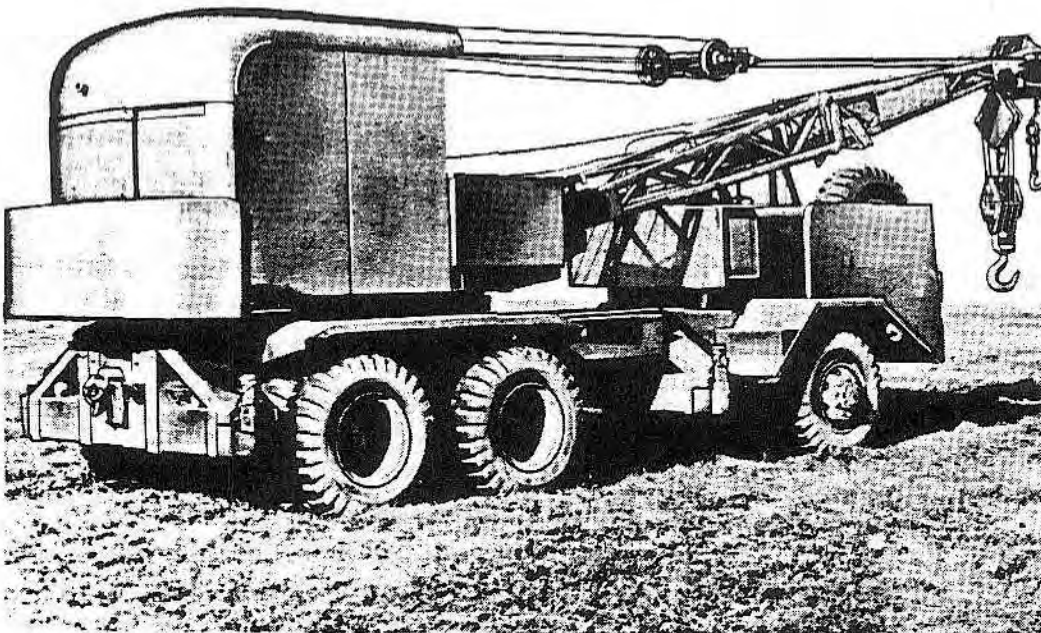
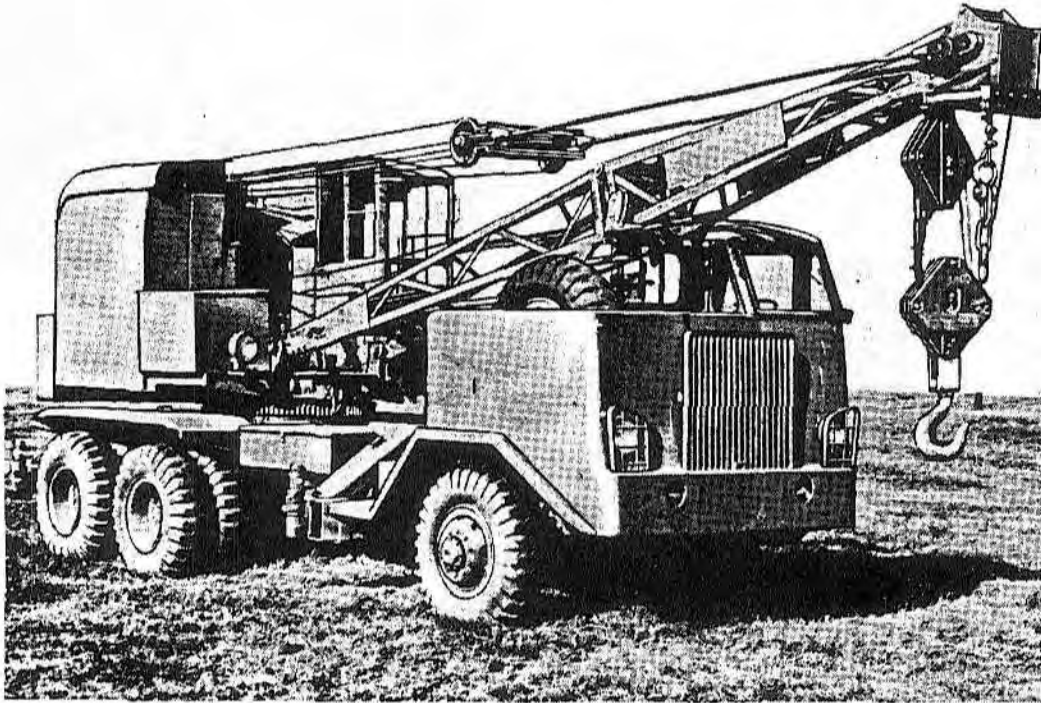

RA PD 72167

Figure 67 — Truck-mounted Crane M2 — Three-quarter Front and
Rear Views

**HOWITZER, CARRIAGE, TRANSPORT WAGONS, CRANE,
AND CLAMSHELL TRAILER**

(5) The lock nut is placed on the spindle after the lock ring has been seated, and screwed tightly on the spindle. A hub cap, fastened over the outer end of the bore of the hub by eight screws, protects the inside of hub against the entrance of dirt and other foreign matter.

c. **Tires and Tubes.** Each wheel is equipped with pneumatic combat tires, 13.00 by 24 inches, with heavy-duty inner tubes of the same size. The recommended tire pressure is 85 pounds in each tire. The tires are held on the rims by means of locking rings.

Section V

**DESCRIPTION AND FUNCTIONING OF TRUCK-MOUNTED
CRANE AND CLAMSHELL TRAILER**

22. TRUCK-MOUNTED CRANE M2.

a. The Truck-mounted Crane M2 is a portable, rubber tired unit, that is, a crane, mounted on a carrier or truck (figs. 67 and 68). It is designed for loading and unloading the two transport wagons, and to operate the clamshell bucket in digging the pit for the trunk portion of the platform.

b. The power flows from the engine in a direct straight-line-drive to the tandem rear axles, and to the front axle from a transfer case by means of a propeller shaft. All six wheels are drivers, and the two rear axles are equipped with dual wheels and tires.

c. The high-speed transmission provides five speeds forward and one in reverse. Mounted midship is a 2-speed auxiliary transmission which may be used in combination with the high-speed transmission to give 10 speeds forward, and 2 in reverse. This range delivers power for steep grades, off- and on-the-road tough jobs.

d. The air brakes are of heavy-duty, 2-shoe type, controlled through air brake diaphragms which actuate constant lift cams.

e. To eliminate chassis movement during crane or clamshell operations, a locking device is provided in the cab to keep the brake pedal depressed, and the brakes applied as long as desired.

f. Proper tire pressure must be maintained, and to make it as easy as possible to do this, an outlet is provided near the reserve air tank on the outside of the chassis frame.

g. Power for the crane operation is transmitted from the crane engine (not truck engine) by means of a multiple strand roller chain to the center drive pinion which, in turn, powers directly the hoist

TM 9-340
22

240-MM HOWITZERS M1918MI AND M1918MIAT, 240-MM HOWITZER
CARRIAGE M1918A2, AND TRANSPORT WAGONS M4 AND M5

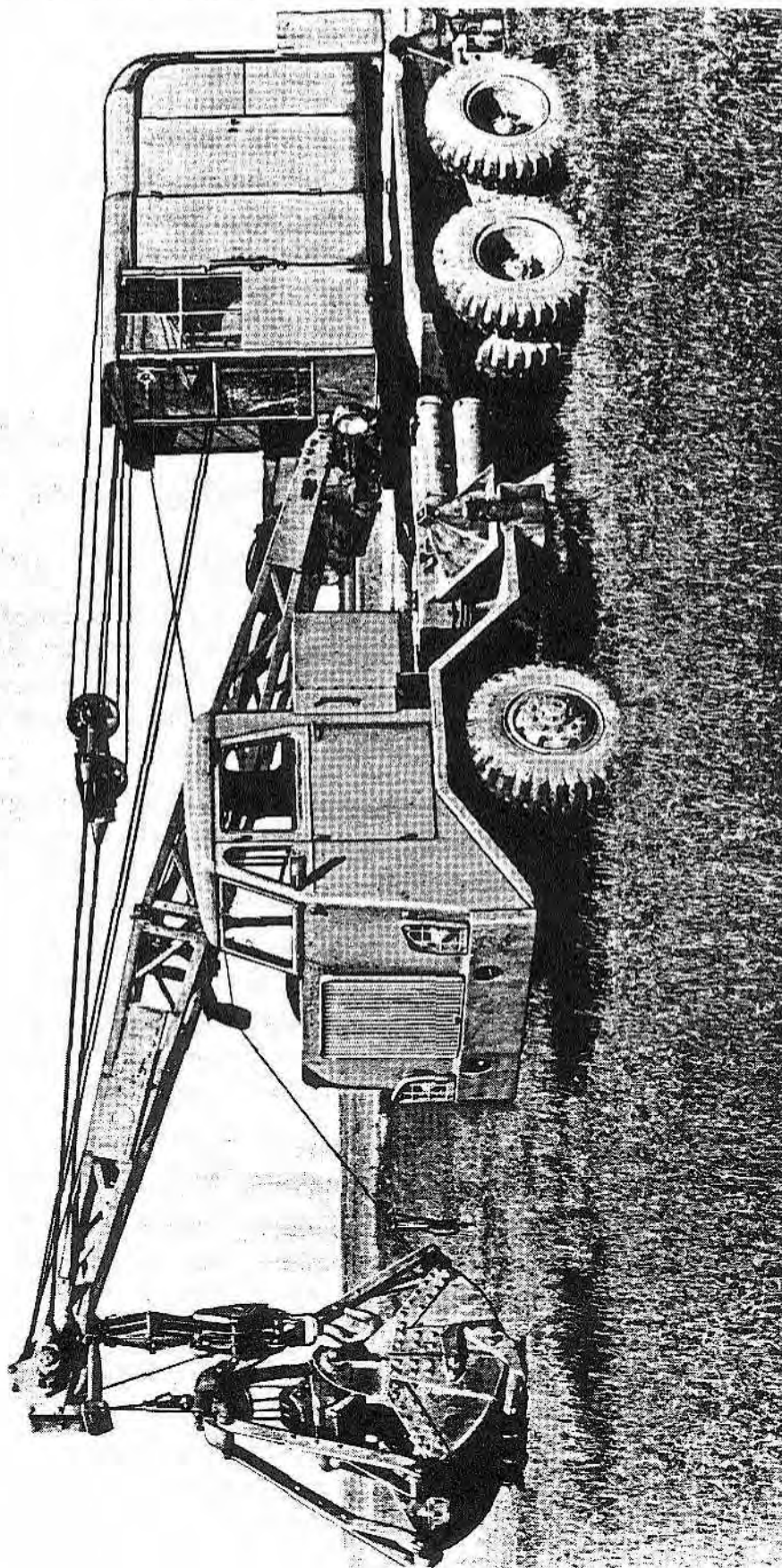

RA PD 72168

Figure 68 — Truck-mounted Crane M2, With Clamshell Attached

HOWITZER, CARRIAGE, TRANSPORT WAGONS, CRANE,
AND CLAMSHELL TRAILER

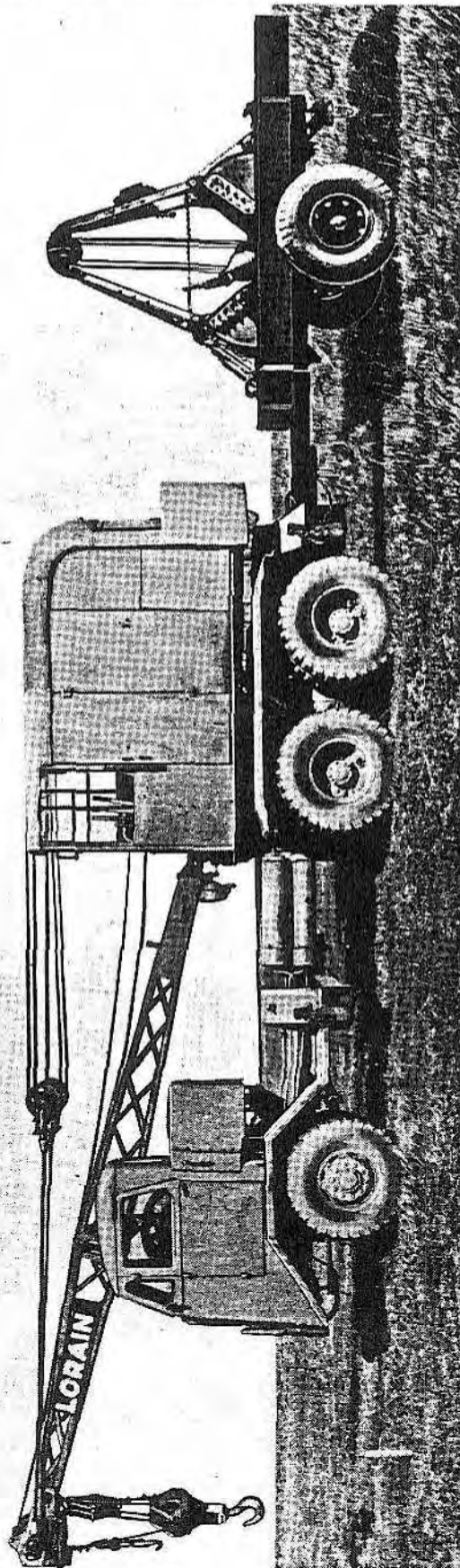

RA PD 72169

Figure 69 — Truck-mounted Crane M2, and Clamshell Trailer M16

240-MM HOWITZERS M1918MI AND M1918MIA1, 240-MM HOWITZER
CARRIAGE M1918A2, AND TRANSPORT WAGONS M4 AND M5

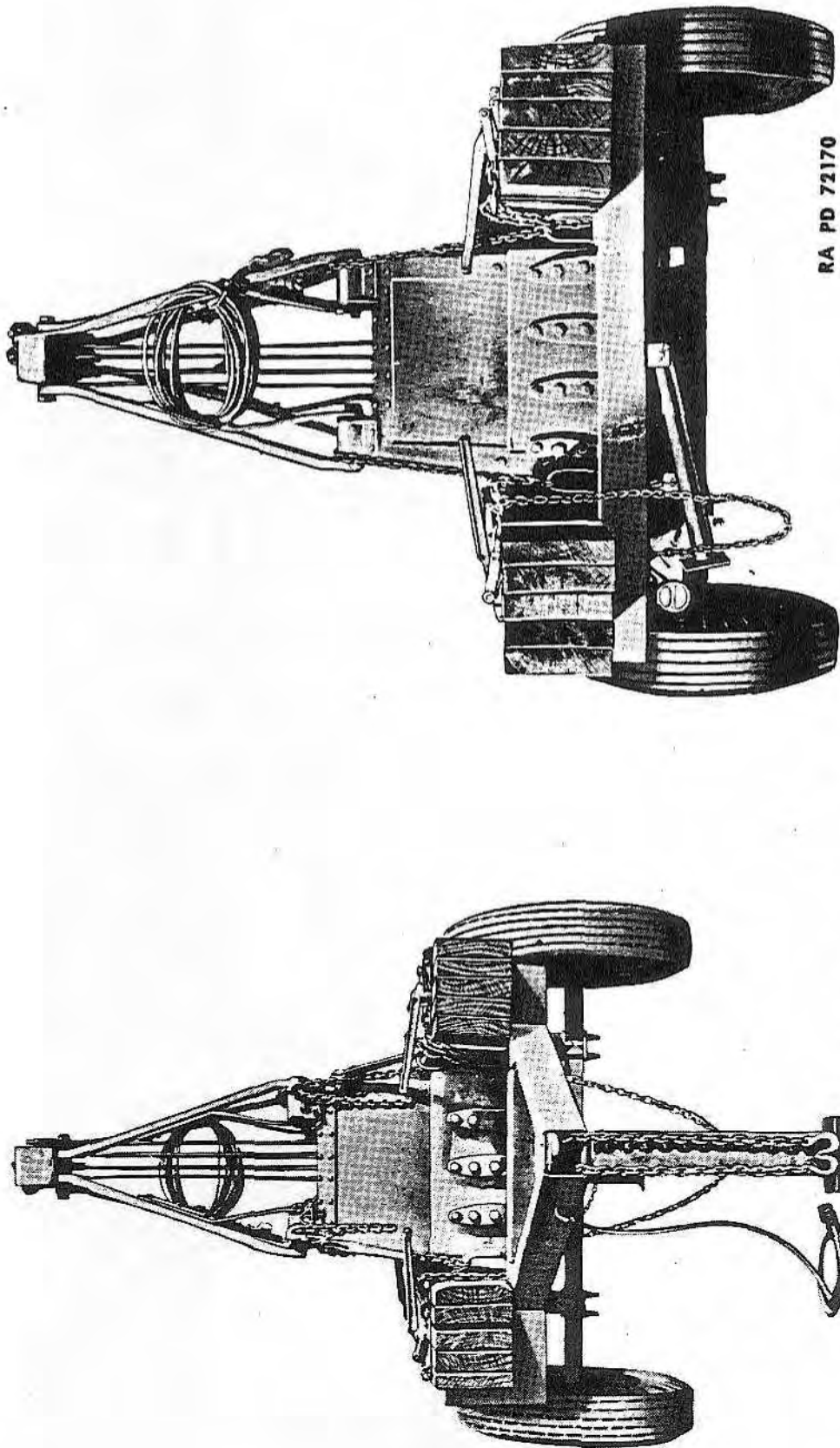

Figure 70 — Clamshell Trailer M16 — Front and Rear Views

HOWITZER, CARRIAGE, TRANSPORT WAGONS, CRANE, AND CLAMSHELL TRAILER

and swing shafts. Full power may be concentrated on either, or spread in the proper balance and relationship for synchronized, simultaneous operations.

(1) The hoist shaft is powered directly by the center drive pinion. The hoisting and holding drums are mounted side by side on the shaft.

(2) The swing shaft is powered directly by the center drive pinion, and supports two swing drums. The twin disk clutch on the end of the swing shaft transmits power for the boom derricking device. Derricking is accomplished by engaging the twin disk clutch on the end of the swing shaft.

(3) The boom hoist drum is connected to a ratchet and pawl device keyed to the end of the hoist shaft.

(4) The rear counterweight is designed for removal to reduce total weight for long moves or because of soft ground travel.

23. CLAMSHELL TRAILER M16.

a. The Clamshell Trailer M16 (figs. 69 and 70) is designed to transport the clamshell bucket and planks used with the Truck-mounted Crane M2.

b. The clamshell bucket is used to dig the pit for the trunk portion of the platform.

c. The planks are used to provide footing for the crane when particularly marshy or muddy ground is encountered.

d. The frame is mounted on a single 2-wheel, dead axle, equipped with semielliptical springs with top helper springs.

e. The frame is built extra wide to afford brackets along each side in which the planks are carried, held in place by load binders.

f. Other features consist of the following:

(1) A fixed drawbar with lunette provided for attachment to the crane.

(2) Front and rear support legs hold the trailer when disconnected from the crane.

(3) Blackout tail and stop lights with blackout switch are connected through jumper cable with plug-in for connection with crane.

(4) Four chock blocks are supplied to hold trailer wheels in position when disconnected from crane.

240-MM HOWITZERS M1918MI AND M1918MIA1, 240-MM HOWITZER
CARRIAGE M1918A2, AND TRANSPORT WAGONS M4 AND M5

Section VI

OPERATION

24. INTRODUCTION.

a. This section outlines the operation of the weapon and carriage. It also prescribes precautions to be taken for the protection of the personnel and materiel. Many of the operations described herein are performed simultaneously. This section is not to be construed as a *Field Manual on the service of the piece.*

25. TO PLACE IN FIRING POSITION.

a. As the organizations to be equipped with the 240-mm howitzer materiel will receive the howitzer and the platform mounted in traveling position on two Transport Wagons M4 and M5, the first consideration should be to emplace the weapon in order to familiarize the personnel with the necessary operations. The weapon is emplaced in the following order: *First, the pit is prepared and the platform and top carriage assembly is emplaced in firing position; next, the howitzer, sleigh, and cradle assembly is mounted in position on the top carriage.* The details of these operations are outlined below.

b. **Preparation of Pit.** Select a piece of level ground and clear it of all obstacles within a radius of about 25 feet from where the pit is to be dug to facilitate maneuvering the materiel and truck-mounted crane. Then lay out the plan of the pit with template No. 1 (fig. 71) and, with the crane and clamshell, dig the pit for the platform trunk (fig. 72). The final shaping of the pit will be accomplished with hand shovels or spades, using the angle, depth, and plan templates shown in figure 73, for laying it out. Templates Nos. 2 and 3 are used to determine the proper shape and depth of the pit. A space around the pit and large enough for the platform, should be made approximately level by using a straight board and testing level.

c. **Emplacing Platform and Top Carriage Assembly.**

(1) Maneuver the M5 Transport Wagon with load (top carriage and platform) alongside of pit in convenient position for unloading. Also place floats under crane truck outriggers (fig. 74).

(2) Remove covers and unhook the locking hook at each side and the locking clamp at the front of the transport wagon (fig. 75).

(3) Attach the lifting sling to the top carriage and platform assembly. Two loops at the rear end of the platform and suitable eyes at the inner side of the front plate on the top carriage, are provided for

HOWITZER, CARRIAGE, TRANSPORT WAGONS, CRANE,
AND CLAMSHELL TRAILER

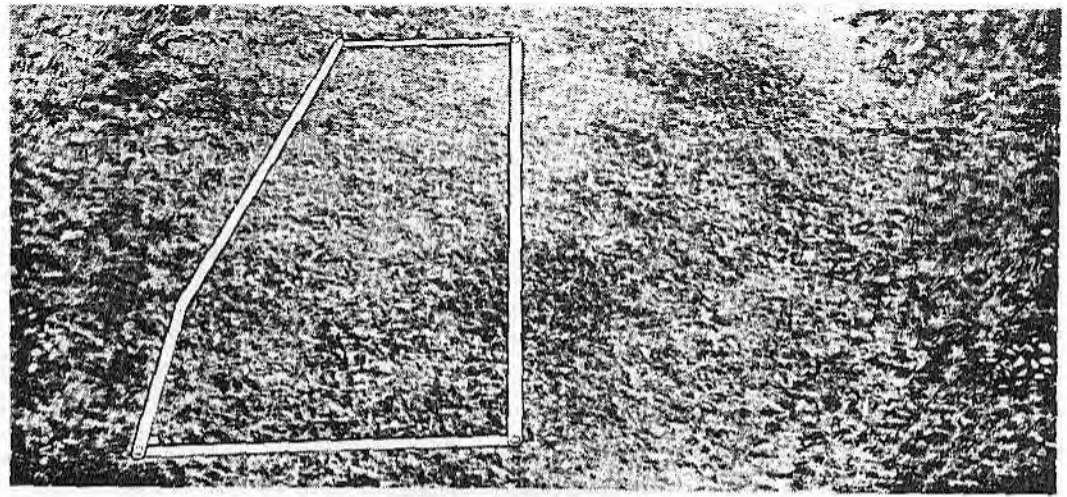

STEP A

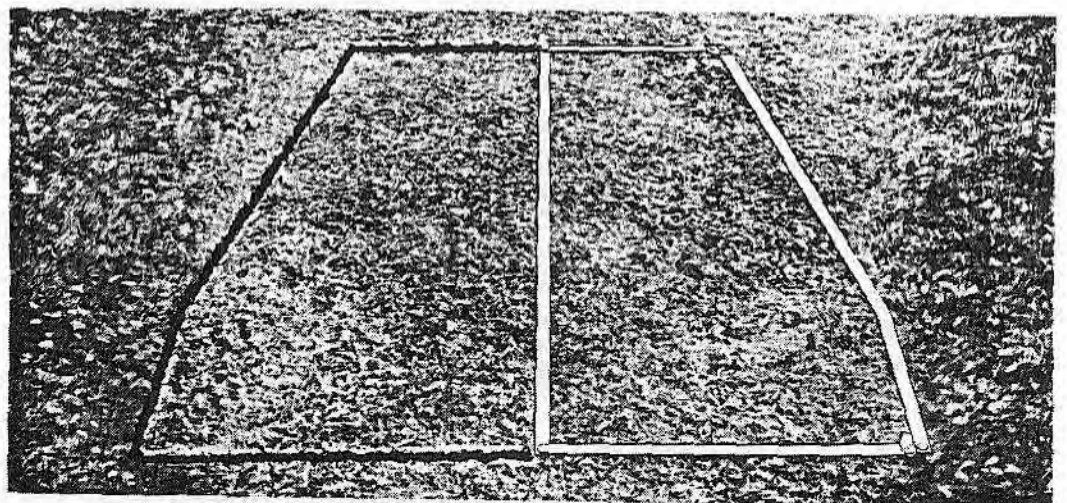

STEP B

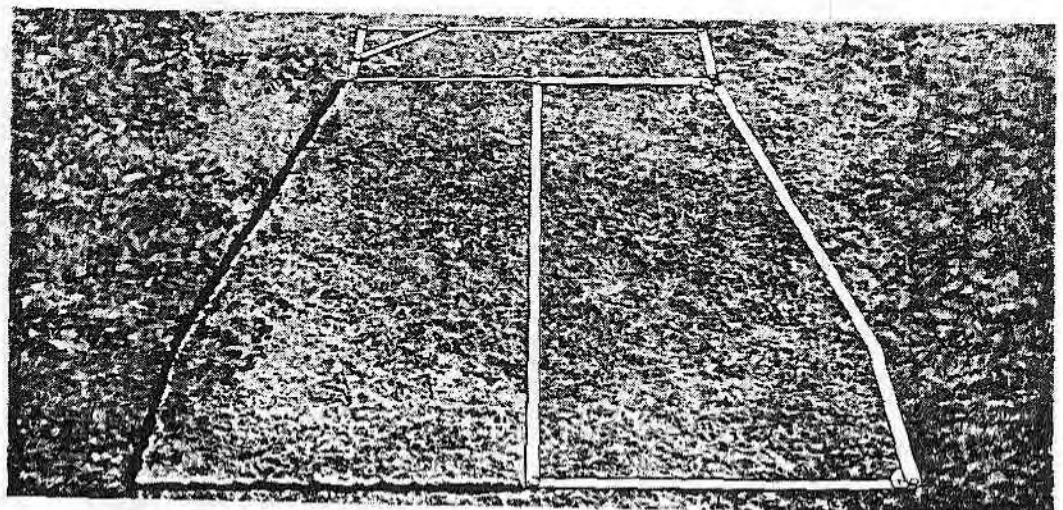

STEP C

RA PD 72171
Figure 71 — Laying Out Plan of Pit With Template No. 1

TM 9-340
25

240-MM HOWITZERS M1918MI AND M1918MIA1, 240-MM HOWITZER
CARRIAGE M1918A2, AND TRANSPORT WAGONS M4 AND M5

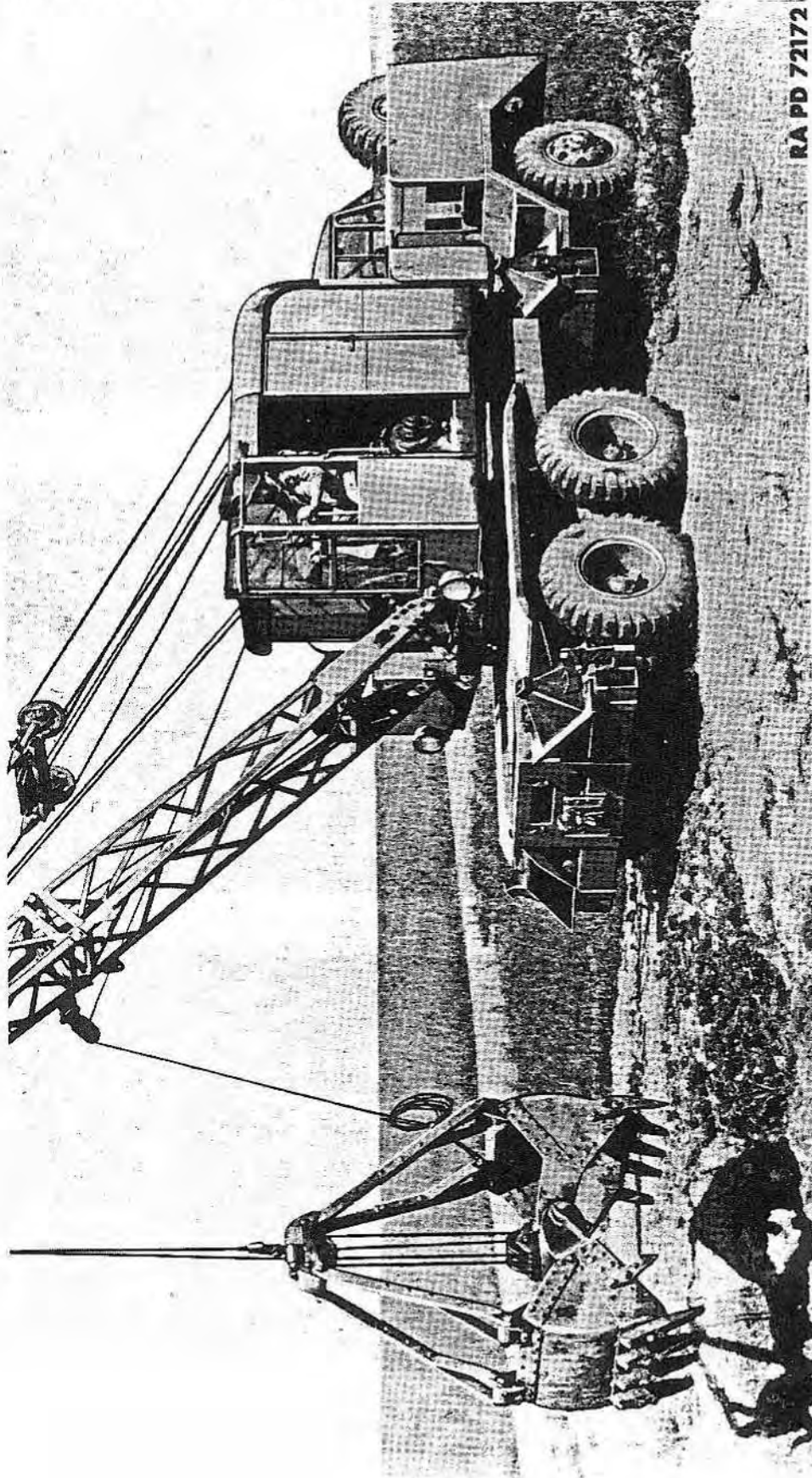

RA PD 72172

Figure 72 — Digging Pit With Crane and Clamshell

**HOWITZER, CARRIAGE, TRANSPORT WAGONS, CRANE,
AND CLAMSHELL TRAILER**



RA PD 72173

**Figure 73 — Checking Shape and Depth of Pit With Templates
Nos. 2 and 3**

240-MM HOWITZERS M1918MI AND M1918MIA1, 240-MM HOWITZER CARRIAGE M1918A2, AND TRANSPORT WAGONS M4 AND M5

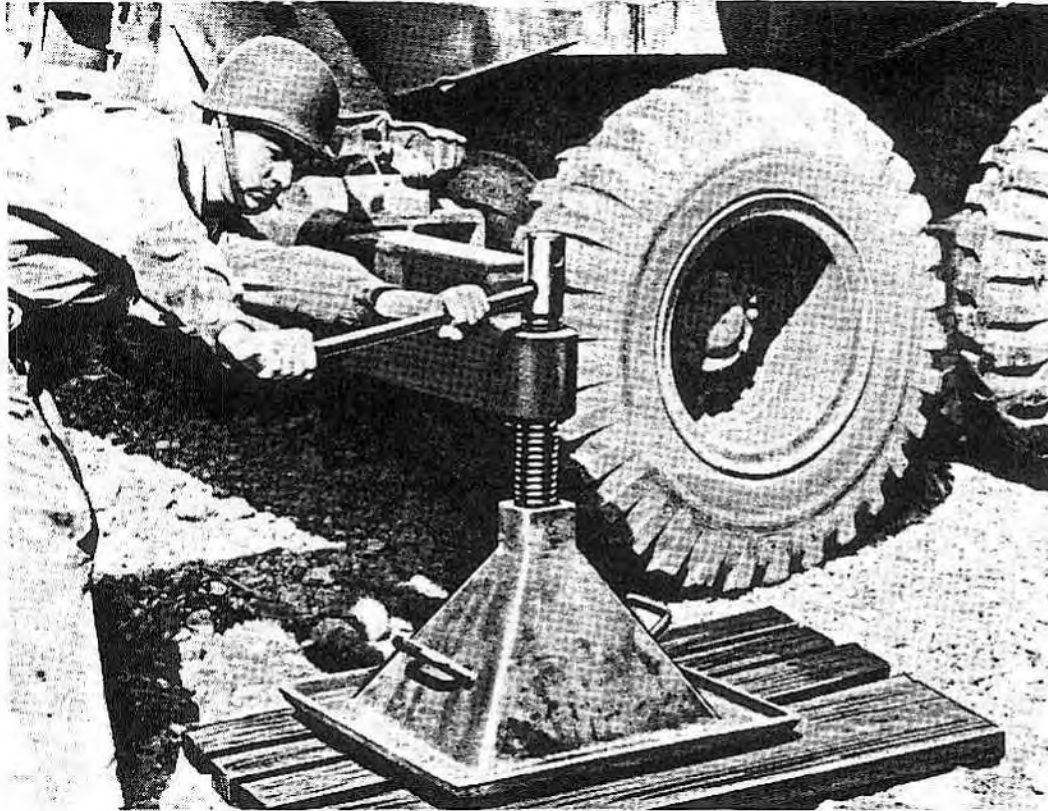

RA PD 72174

Figure 74 — Placing Float Under Outrigger on Crane Truck

attaching the lifting sling to the mechanism. Attach shorter sections of slings to eyes on top carriage and longer sections to loops on platform.

(4) Maneuver the truck-mounted crane in position on the opposite side of the pit from the transport wagon and attach the lifting hook of the crane to the sling on the top carriage and platform assembly (fig. 76).

(5) With the aid of the crane, lift the top carriage and platform assembly off the transport wagon and place it in position in the pit (fig. 77).

(6) Tamp the ground down firmly around the platform trunk and under the platform. In soft soil, the platform should be inclined slightly to the rear as the greatest weight and reaction from firing comes on the forward end.

(7) Remove the floats from the transport wagon with the crane and place them in position at the rear of the platform (fig. 79).

(8) Unscrew the swinging arm screws in the outer ends of the outriggers to release them from the brackets on the platform. Then place the swinging arms of the outriggers in position over the floats

HOWITZER, CARRIAGE, TRANSPORT WAGONS, CRANE,
AND CLAMSHELL TRAILER

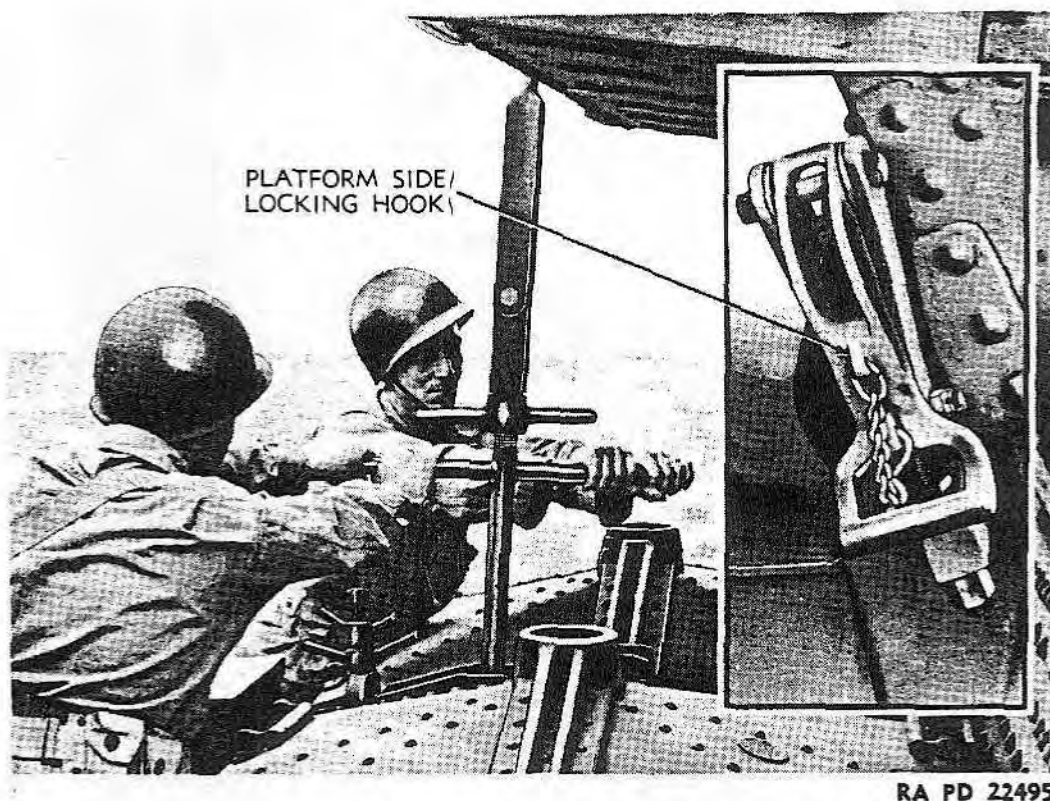

RA PD 22495

Figure 75 – Loosening Platform Locking Clamp

and turn down the swinging arm screws (fig. 78). The screws should be kept tight against the floats when firing, but no attempt should be made to use them as jacks for leveling the platform.

NOTE: The floats are designed to increase the effective length of the platform and thereby diminish the tendency of the front part of the platform to lift off the ground when firing at low elevation. The floats should ordinarily be placed parallel with the platform (fig. 79). When the howitzer is to be fired in either extreme traversed position, the float on the side toward which the breech points may be moved to a position more nearly parallel with the top carriage to provide greater firing stability.

- (9) Install elevating and traversing handwheels.
- (10) Remove the shell loading tray and the loading ramp.
- (11) Place all footboards in operating position. To release the hinged footboards, pull out on the knob and swing the lock lever to release the footboard (fig. 80).
- (12) Move Transport Wagon M5 a safe distance out of the way. The truck-mounted crane should remain in position for unloading the howitzer, sleigh, and cradle assembly.

TM 9-340
25

240-MM HOWITZERS M1918MI AND M1918MIA1, 240-MM HOWITZER
CARRIAGE M1918A2, AND TRANSPORT WAGONS M4 AND M5

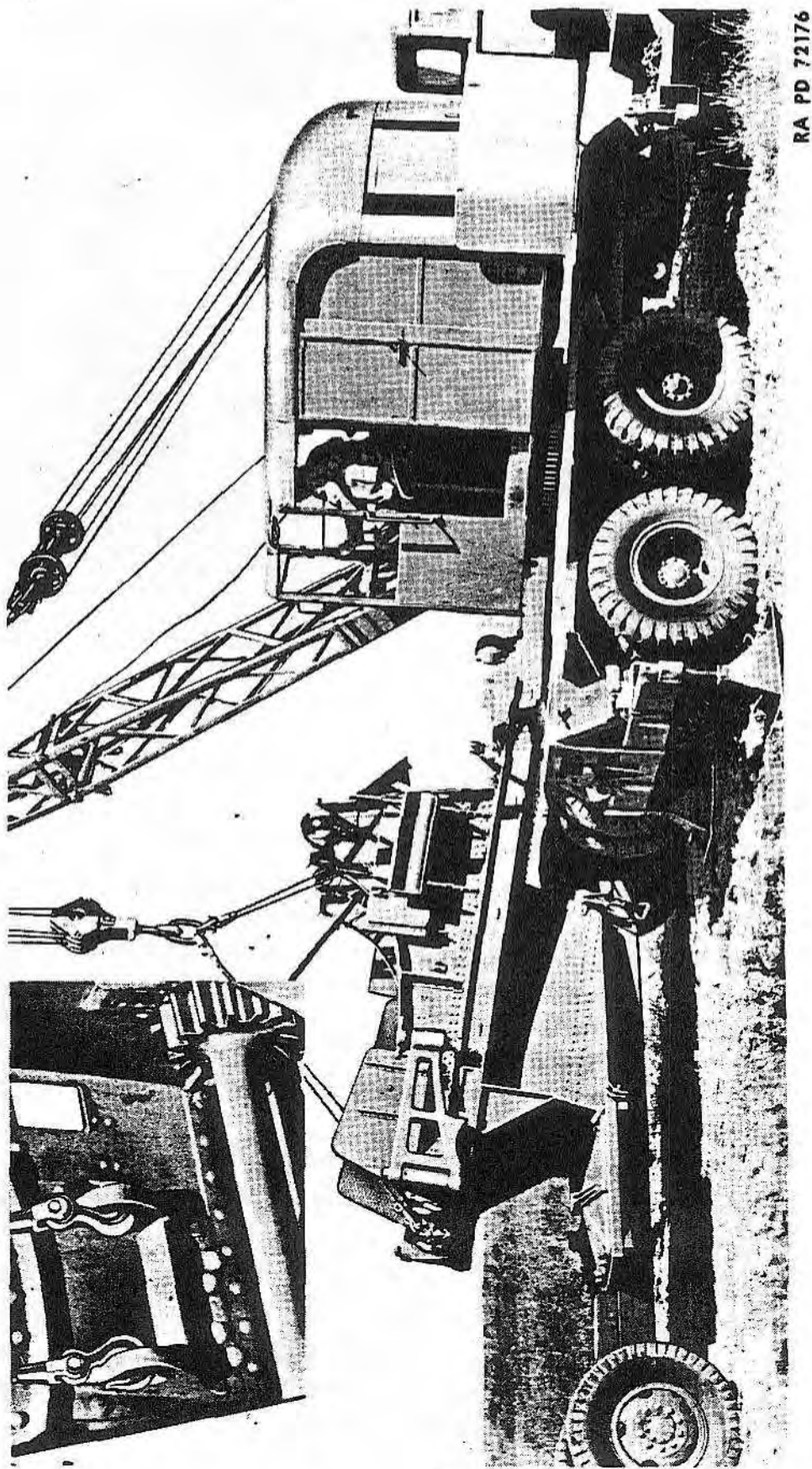

RA PD 72176

Figure 76 — Removing Top Carriage and Platform Assembly From Transport Wagon

HOWITZER, CARRIAGE, TRANSPORT WAGONS, CRANE,
AND CLAMSHELL TRAILER

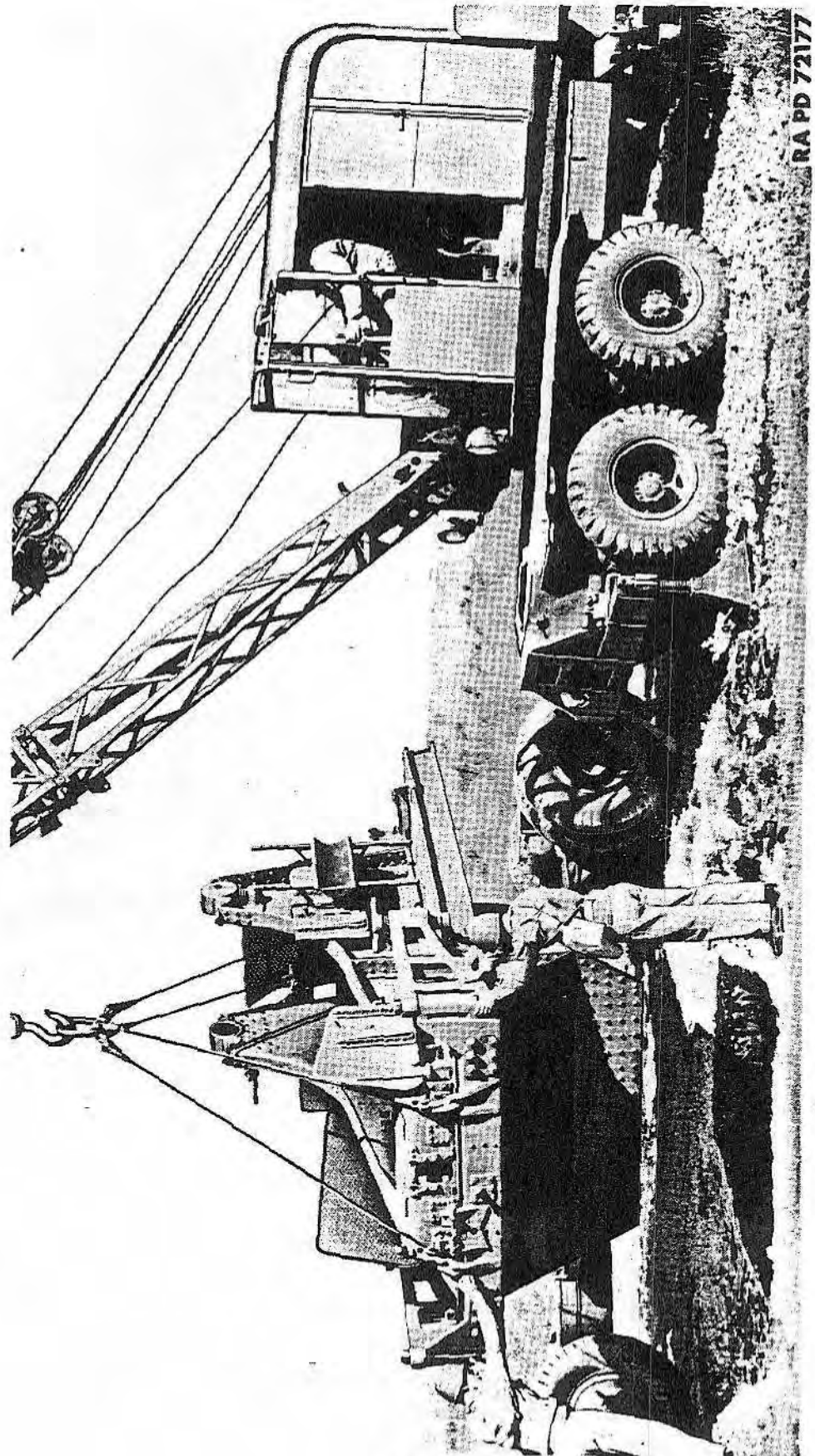
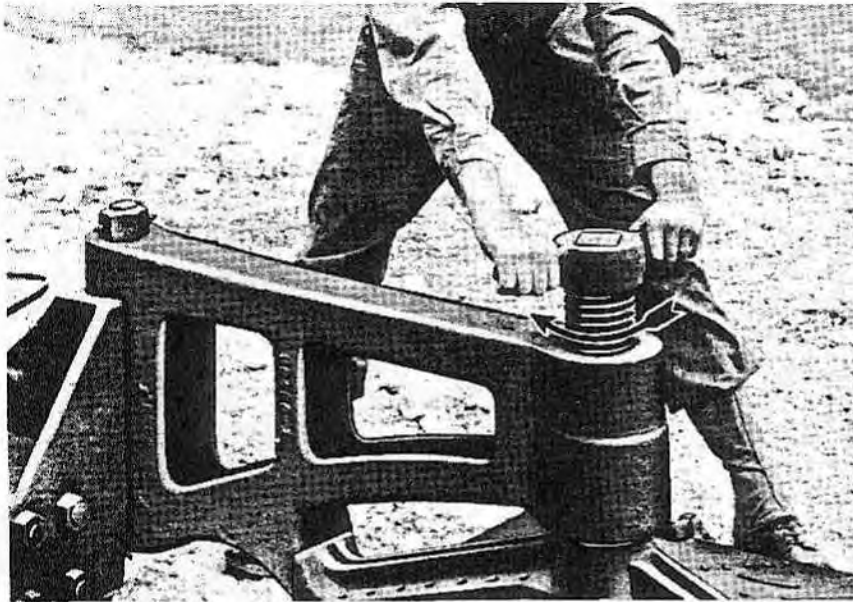

Figure 77 — Placing Top Carriage and Platform Assembly Over Pit

240-MM HOWITZERS M1918MI AND M1918MIA1, 240-MM HOWITZER CARRIAGE M1918A2, AND TRANSPORT WAGONS M4 AND M5



RA PD 72178

Figure 78 — Turning Swinging Arm Screw Down on Float

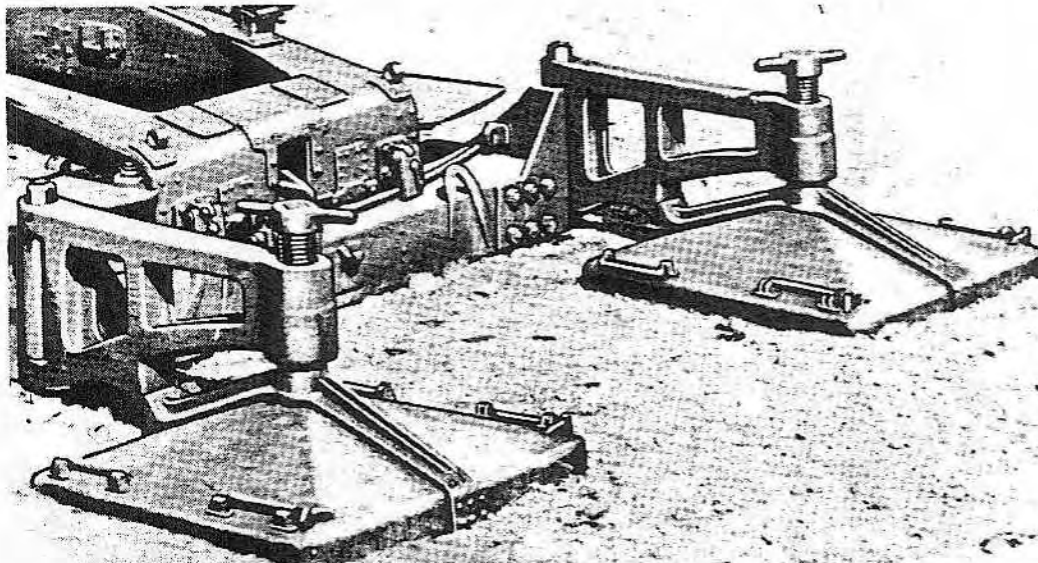

RA PD 72179

Figure 79 — Position of Floats for Ordinary Firing of Howitzer

(13) To disconnect the prime mover from the transport wagon, first set the hand brakes on the transport wagon. Then, close the angle cocks at the rear end of the prime mover and disconnect the air lines. Connect the air line couplings to the dummy couplings on the drawbar (fig. 81). This must be done to keep sand and dirt out of the air lines. Also disconnect the jumper cable from the prime mover (fig. 81), and place the plug in the container on the drawbar. Next, disconnect

HOWITZER, CARRIAGE, TRANSPORT WAGONS, CRANE,
AND CLAMSHELL TRAILER

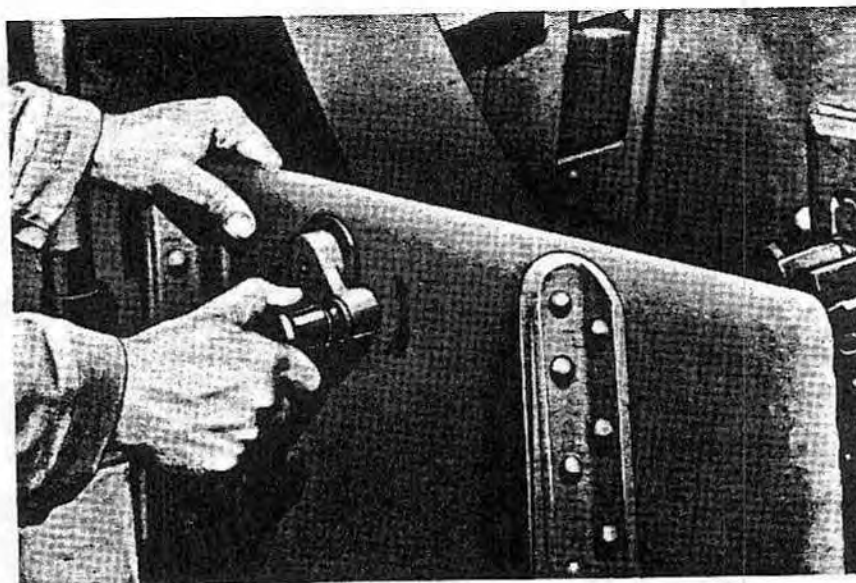

RA PD 72180

Figure 80 — Releasing Footboard

the lunette of the transport wagon drawbar from the pintle on the prime mover.

d. Mounting of Howitzer.

(1) Maneuver the M4 Transport Wagon with load (howitzer, sleigh, and cradle) alongside of the platform and top carriage assembly in convenient position for unloading.

(2) Unlock and turn back the trunnion bearing caps on the top carriage. To unlock these caps, push in on the trunnion bearing cap locking pin plunger (fig. 82) and turn the left trunnion bearing cap locking pins to the left (counterclockwise) and the right trunnion bearing cap locking pins to the right (clockwise), as far as possible against the stops.

(3) Disengage the cradle lock. To do this, pull out on the knob of the locking lever and swing the lever to the left until the locking pin engages the second hole from the left in the bracket. Then slide the cradle lock assembly to the outer position on the supporting bracket (fig. 83).

(4) Remove covers and unhook the two locking hooks at each side of the transport wagon (fig. 84).

(5) Attach the lifting sling to the howitzer and cradle assembly, attaching the shorter sections of the sling to the thimbles on the howitzer and the longer sections to the links on the crossbars in the rear end of the cradle (fig. 85).

240-MM HOWITZERS M1918MI AND M1918MIA1, 240-MM HOWITZER
CARRIAGE M1918A2, AND TRANSPORT WAGONS M4 AND M5

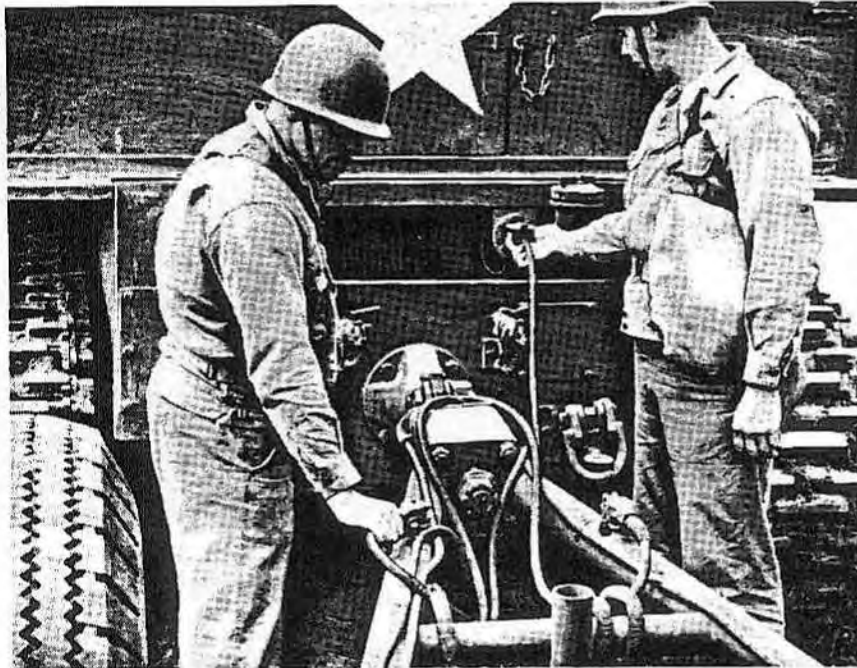

RA PD 72181

Figure 81 — Disconnecting Prime Mover From Transport Wagon

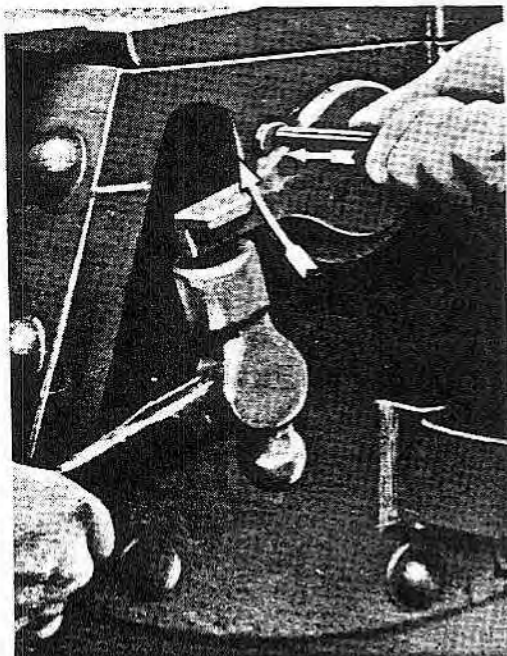

LOCK PIN IN LOCKED POSITION

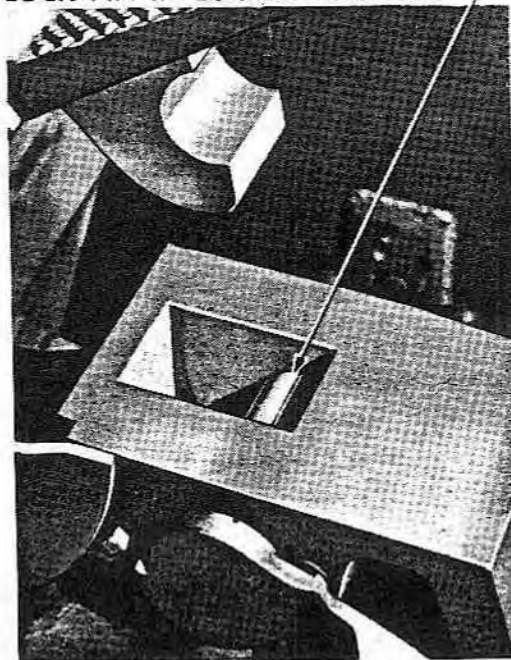

RA PD 72182

Figure 82 — Unlocking Trunnion Bearing Caps

**HOWITZER, CARRIAGE, TRANSPORT WAGONS, CRANE,
AND CLAMSHELL TRAILER**

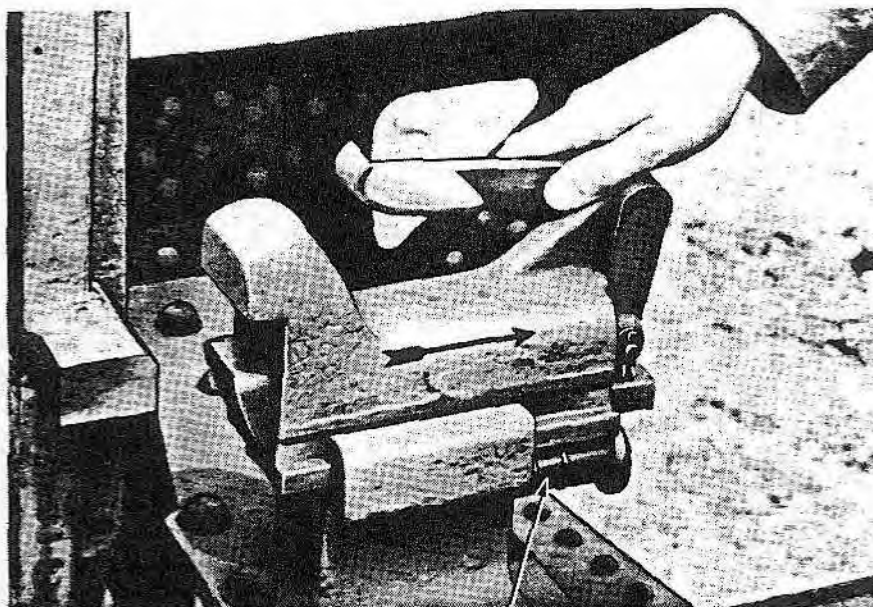

**CRADLE LOCKING LEVER PIN
IN EXTREME LEFT (HOLE) POSITION**

RA PD 72183

Figure 83 – Moving Cradle Lock to Outer Position



RA PD 72184

Figure 84 – Detaching Locking Hook From Cradle

(6) With the truck-mounted crane in the same position as for emplacing the top carriage and platform assembly, attach the lifting hook of the crane to the sling on the howitzer and cradle assembly.

(7) With the aid of the crane, lift the howitzer, sleigh, and cradle assembly off the transport wagon (fig. 85) and place it in position

240-MM HOWITZERS M1918MI AND M1918MIA1, 240-MM HOWITZER
CARRIAGE M1918A2, AND TRANSPORT WAGONS M4 AND M5

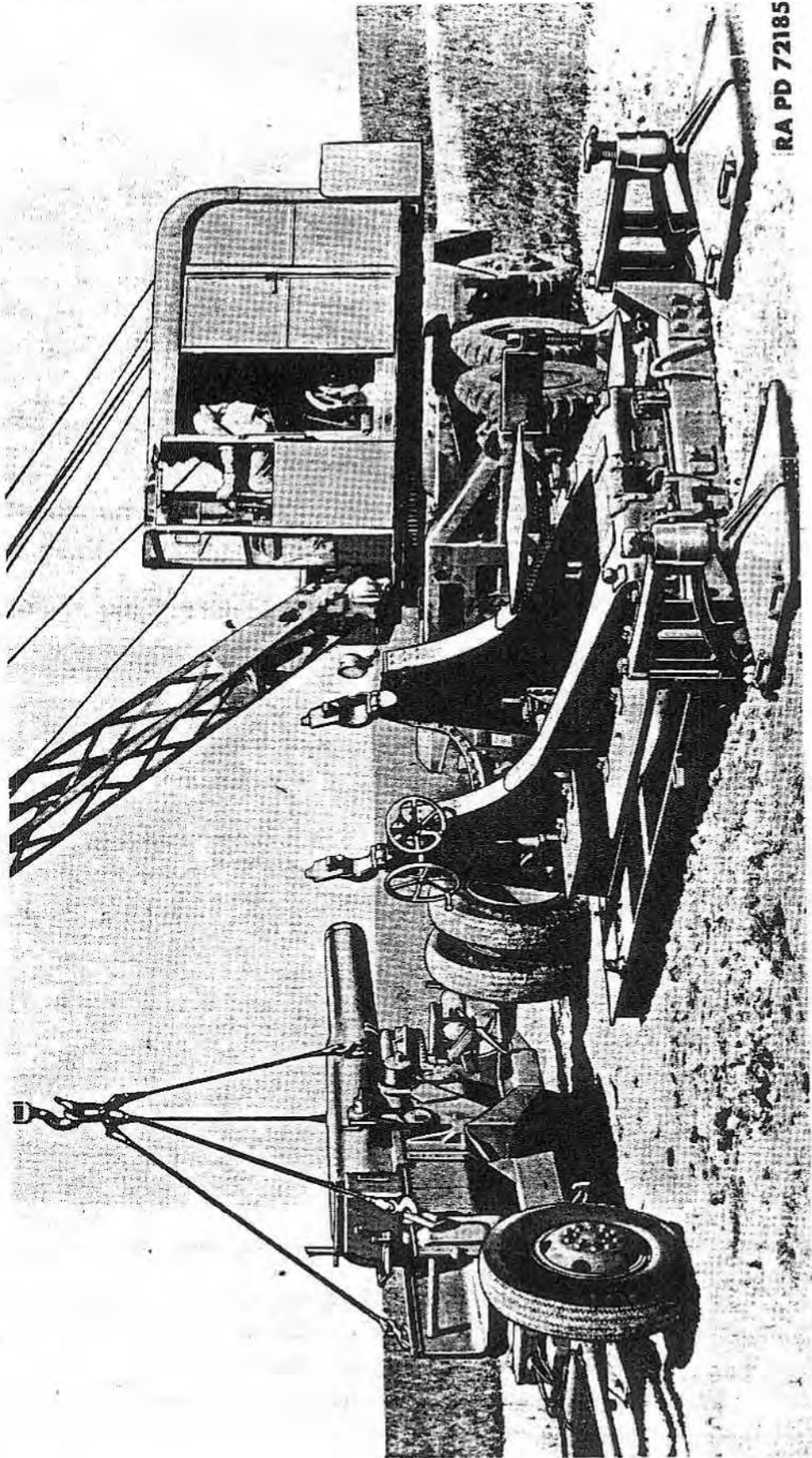

Figure 85 — Removing Howitzer, Sleigh, and Cradle Assembly From Transport Wagon

HOWITZER, CARRIAGE, TRANSPORT WAGONS, CRANE,
AND CLAMSHELL TRAILER

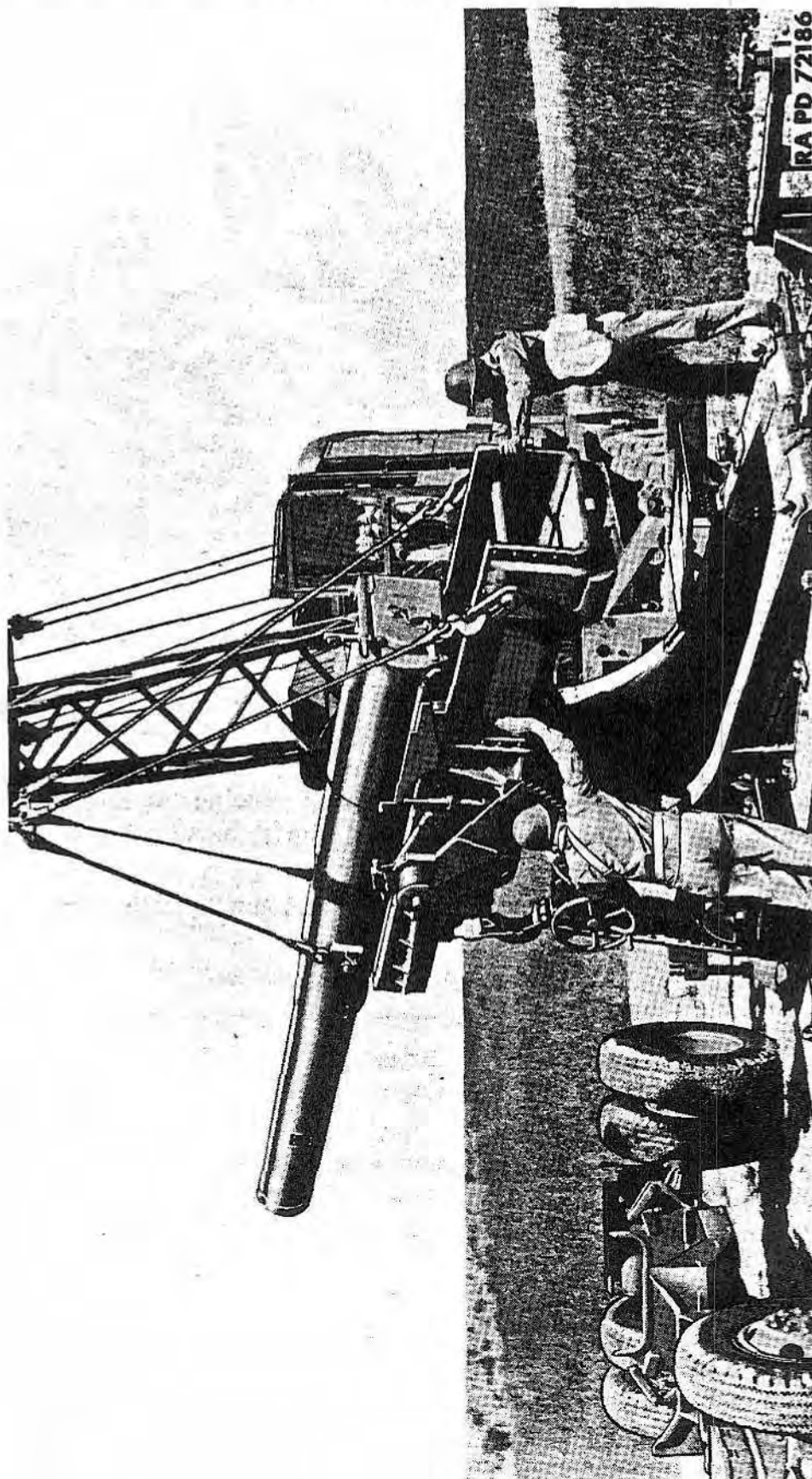

Figure 86 — Mounting Howitzer, Sleigh, and Cradle Assembly on Top Carriage

240-MM HOWITZERS M1918MI AND M1918MIA1, 240-MM HOWITZER
CARRIAGE M1918A2, AND TRANSPORT WAGONS M4 AND M5



RA PD 72187

Figure 87 – Elevating and Traversing the Howitzer

on the top carriage (fig. 86). Turn the elevating handwheel slightly if necessary to mesh elevating pinions with elevating arcs.

(8) Swing the trunnion bearing caps in position over the trunnion bearings and lock the caps by turning the left locking pin to the right (clockwise) and the right locking pin to the left (counterclockwise) against the stops.

(9) Install the cradle lock with the locking lever in the extreme right position.

(10) Install quick-loading handwheel.

(11) Disengage the traversing lock at rear end of platform.

(12) Attach the quadrant sight to the left-hand elevating arm bearing cap with the sight bracket in position over the auxiliary trunnion.

(13) Move Transport Wagon M4 and truck-mounted crane a safe distance out of the way. Disconnect prime mover from transport wagon if desired as outlined in subparagraph c (13), above.

26. TO TRAVERSE.

a. The traversing handwheel is located on the left side of the top carriage in front of the elevating handwheel (fig. 87). The range of traverse is 10 degrees to the right or left of midposition or center line of the platform. Approximately $13\frac{1}{2}$ turns of the handwheel traverse the top carriage through 1 degree in azimuth.

**HOWITZER, CARRIAGE, TRANSPORT WAGONS, CRANE,
AND CLAMSHELL TRAILER**

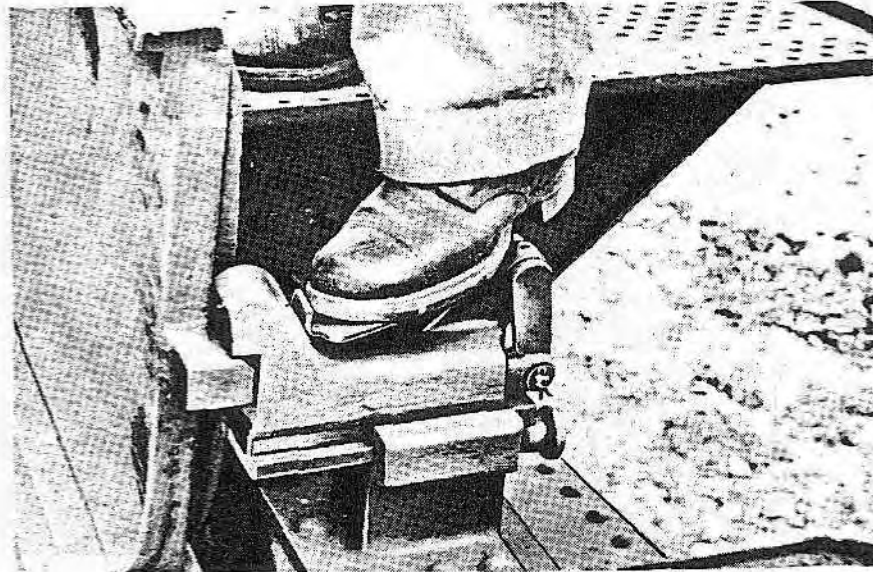

RA PD 72188

Figure 88 – Disengaging Cradle Locking Bolt

27. TO ELEVATE.

a. The elevating handwheel is located at the left side of the top carriage back of the traversing handwheel (fig. 87). The range of elevation is from 1 degree depression to 60 degrees elevation. Approximately 1½ turns of the handwheel will elevate or depress the howitzer and other tipping parts 1 degree.

b. Before the howitzer and cradle can be elevated, it will be necessary to disengage the cradle locking bolt slide. To do this, step on the locking device pedal (fig. 88) to disengage the cradle locking bolt from the lug on cradle. When depressing the howitzer and cradle, the lug on the cradle will automatically release the cradle locking bolt to engage the cradle locking bolt slide.

c. Elevating for quick loading is accomplished by means of the quick-loading mechanism as follows:

(1) Disengage the elevating lock lever which is located just below the bottom of the cradle and attached to the quick-loading arc connecting plate. To operate this lock, pull on the knob and move the elevating lock lever down and to the left as far as it will go (fig. 89).

(2) Pull the quick-loading gear operating lever toward the handwheel, and at the same time, turn the quick-loading handwheel to accomplish the desired results (fig. 90).

240-MM HOWITZERS M1918MI AND M1918MIA1, 240-MM HOWITZER
CARRIAGE M1918A2, AND TRANSPORT WAGONS M4 AND M5

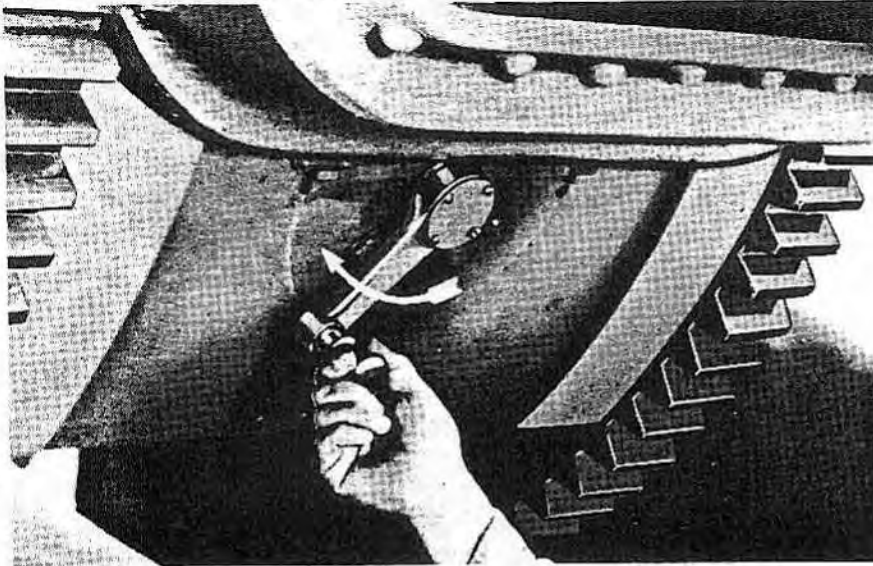

RA PD 72189

Figure 89 – Disengaging Elevating Lock Lever

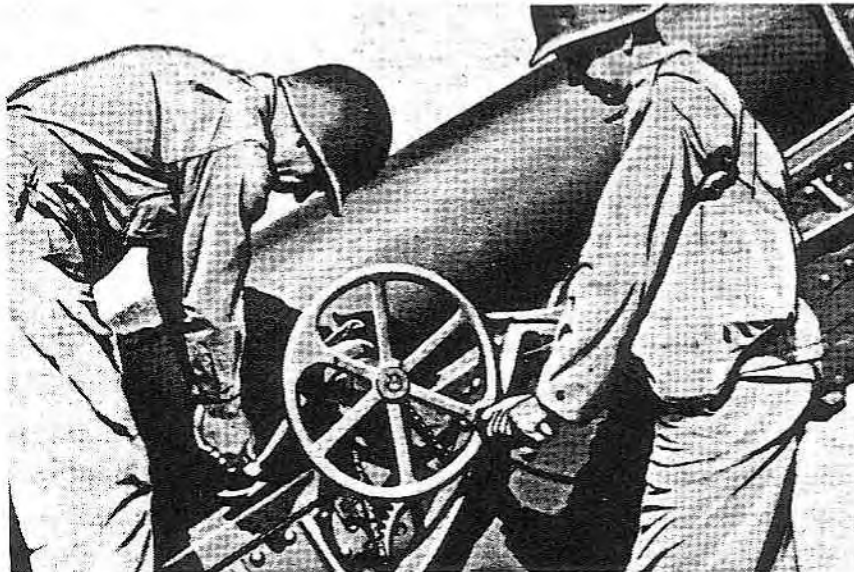

RA PD 72190

Figure 90 – Operating Quick-loading Mechanism

28. TO OPERATE THE BREECH MECHANISM.

a. To Open the Breech.

- (1) Release the percussion hammer by moving the percussion hammer lock bolt to the left (fig. 91).
- (2) Raise the firing mechanism block latch and unscrew the firing mechanism by turning it to the left (fig. 92).
- (3) Grasp the breech operating lever at the grip portion, depress the operating lever trigger, and pull the lever to the rear and around

HOWITZER, CARRIAGE, TRANSPORT WAGONS, CRANE,
AND CLAMSHELL TRAILER



PERCUSSION HAMMER
LOCK BOLT PERCUSSION
HAMMER
RA PD 22496

**Figure 91 — Disengaging
Percussion Hammer Lock Bolt**

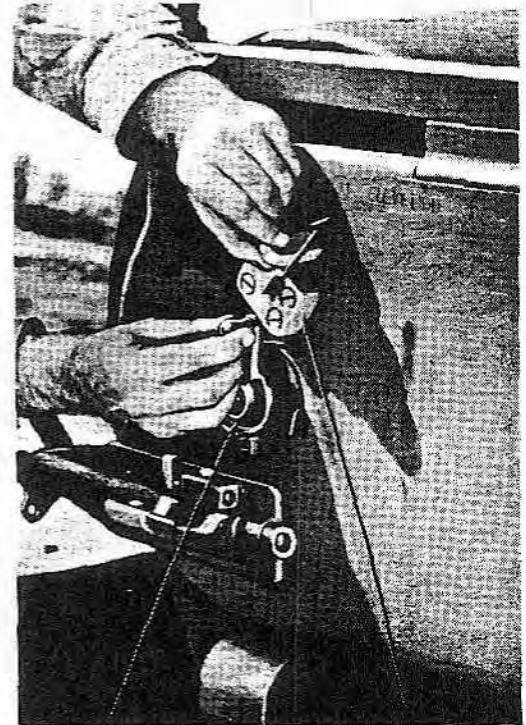

FIRING
MECHANISM FIRING MECHANISM
BLOCK LATCH
RA PD 22497

**Figure 92 — Disengaging Firing
Mechanism Block Latch**

until the operating lever handle engages with the operating lever latch bracket on the howitzer jacket (fig. 93).

(4) In the first part of its movement, the operating lever mechanism operates the rack which turns the breechblock to disengage its threads from those in the breech recess of the howitzer tube.

(5) The instant the breechblock carrier moves away from the breech face of the howitzer, the rack lock under the action of its spring slides upward in its inclined seat and protrudes from the muzzle face of the carrier. This allows the lock to engage in the groove in the rack and locks it, thereby preventing the breechblock from turning while outside of the breech recess.

CAUTION: To avoid accident, the breech should never be opened when the howitzer is at an elevation greater than that for loading, 15 degrees.

b. To Close the Breech.

(1) Grasp the vertical grip of the breech operating lever in such a manner as to depress the operating lever trigger into the grip, and release the operating lever handle from the operating lever latch bracket on the howitzer jacket.

240-MM HOWITZERS M1918MI AND M1918MIA1, 240-MM HOWITZER
CARRIAGE M1918A2, AND TRANSPORT WAGONS M4 AND M5

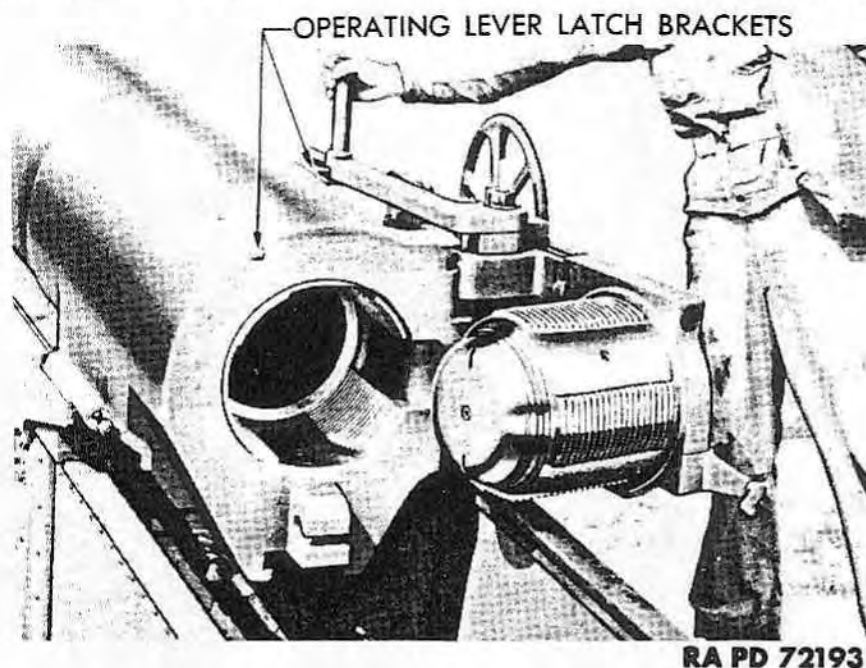

Figure 93 – Opening the Breech

(2) Swing the operating lever with the breech mechanism around until the breechblock carrier strikes the breech face of the howitzer (fig. 94) and continue to move the operating lever until it engages with the latch plate on the breech face of the howitzer.

(3) The forward end of the rack lock, projecting from the front face of the breechblock carrier, strikes the breech face of the howitzer and is pushed back in its seat, freeing the rack. The rack moves to the left, turning the breechblock and engaging its threads with those in the breech recess in the howitzer as the operating lever continues to move toward the closed position. The operating lever comes to rest when the handle engages with the operating lever latch on the breech face of the howitzer.

(4) Install the firing mechanism by screwing it in the firing mechanism housing, turning it to the right, until its handle passes the firing mechanism block latch.

(5) Swing the percussion hammer upward close to the firing mechanism and lock it in position by moving the percussion hammer lock bolt to the right.

29. POINTS TO BE OBSERVED BEFORE FIRING.

a. After the weapon has been properly emplaced and before firing, a special inspection will be made to determine that the following conditions exist:

HOWITZER, CARRIAGE, TRANSPORT WAGONS, CRANE,
AND CLAMSHELL TRAILER

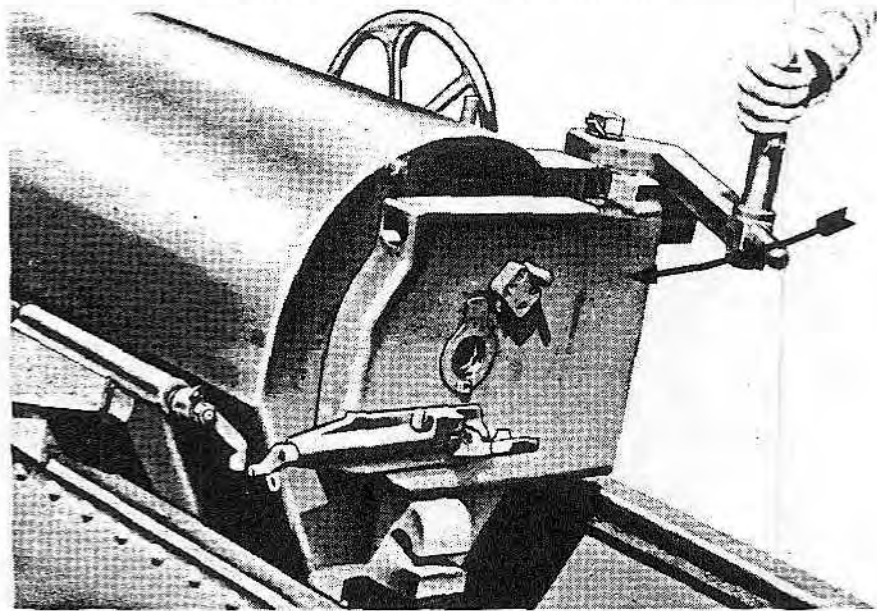

RA PD 72194

Figure 94 – Closing the Breech

- (1) Inside of howitzer is clean and dry, and breech mechanism is clean and well oiled.
- (2) The percussion hammer is unlocked from the traveling position.
- (3) The obturator vent is clean.
- (4) The howitzer is properly locked in the sleigh.
- (5) All parts of the weapon are well lubricated according to the lubrication instructions.
- (6) The recoil slide guides on the cradle are clean and lubricated.
- (7) The proper amount of liquid is in both recoil and recuperator systems.
- (8) The pressure in the recuperator system is as prescribed, and the sleigh is in full firing position.
- (9) The recoil and recuperator piston rod nuts are screwed up tight, and the piston rod beam is firmly locked to the cradle.
- (10) The sight is securely attached and properly adjusted.
- (11) The elevating lock lever for the elevating arms is unlocked and secured in its position.
- (12) The firing mechanism functions properly.
- (13) The trunnion bearing caps are properly locked.
- (14) The cradle trunnions are floating on the roller bearings resting on the Belleville springs.

240-MM HOWITZERS M1918MI AND M1918MIA1, 240-MM HOWITZER CARRIAGE M1918A2, AND TRANSPORT WAGONS M4 AND M5

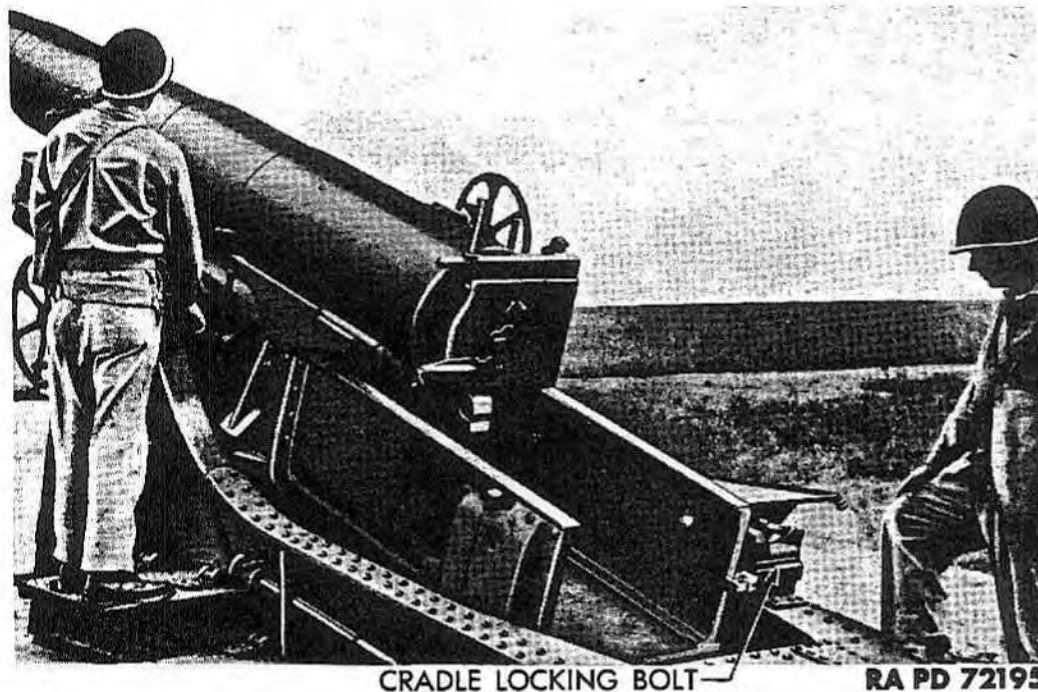

Figure 95 — Depressing Howitzer and Cradle To Engage Cradle Lock

(15) The elevating pinions and arcs are clean and well lubricated and the elevating and quick-loading mechanisms work easily.

(16) The friction clutch in the elevating worm wheel is properly adjusted.

(17) The pintle head nut is screwed down and the spring pin is in place.

(18) The traversing gearing is working properly, and the pinion and rack are free from dirt or gravel.

(19) The path of the traversing rollers is free from dirt or gravel.

(20) The rear clips are in place and properly locked.

(21) The traversing lock at the rear of the platform is disengaged to permit traversing of the top carriage.

(22) The screws in the swinging arms of the outriggers are down in the sockets of the floats.

(23) The floats are set on level ground.

(24) The platform is firmly set and the gravel or dirt well tamped under it.

(25) All the footboards are down and securely fastened.

**HOWITZER, CARRIAGE, TRANSPORT WAGONS, CRANE,
AND CLAMSHELL TRAILER**



RA PD 72196

Figure 96 – Installing Loading Ramp

30. TO LOAD.

a. Lower the weapon to an elevation suitable for loading (about 15 degrees) or until the cradle lug engages cradle lock (fig. 95). Remove the firing mechanism and open the breech. Latch the percussion hammer in the released position by means of the percussion hammer lock bolt.

b. Swab the powder chamber and breech recess. If a charge has been fired, wipe off the powder residue from the obturator spindle head, gas-check pad, gas-check seat, and the threaded sectors of the breech recess and breechblock with a wiping cloth slightly dampened with oil. Clean the primer vent with the vent cleaning bit. Whenever the rate of fire permits, inspect the bore for burning fragments of powder bags or other objects, and for bore injuries. In night firing, swab the bore with water.

c. Place the loading ramp in position with the lug under the front end in the breech recess (fig. 96).

d. **Prepare the Projectile.** Verify the type, weight, and lot number of the projectile and examine it carefully for defects. Remove the grommet and inspect the rotating band with special care; remove any burs with a file. Clean the entire surface of the projectile with a piece of wiping cloth. Sand or dirt on the projectile might cause premature detonation when the piece is fired and will cause undue wear on the bore.

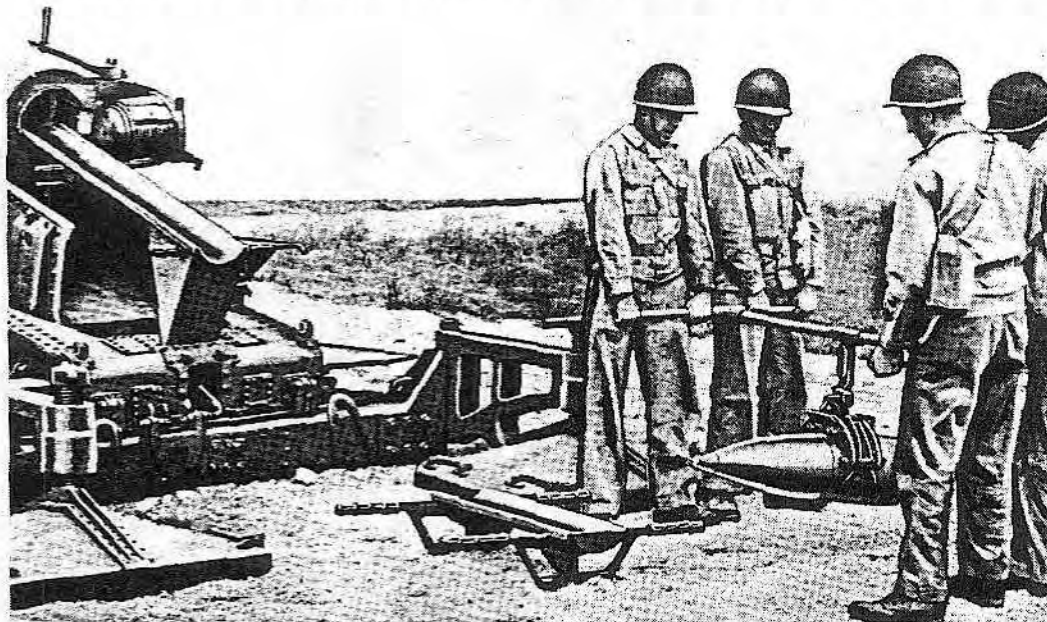
240-MM HOWITZERS M1918MI AND M1918MIA1, 240-MM HOWITZER CARRIAGE M1918A2, AND TRANSPORT WAGONS M4 AND M5

RA PD 72197

Figure 97 – Bringing Up the Projectile

e. **Fuze the Projectile.** Unscrew the eyebolt lifting plug from the fuze socket. Insert the designated fuze, being careful that it is fitted with its felt or rubber washer. Screw the fuze in place by hand. Give the fuze its final seating with the fuze wrench. No great force should be used. If there is any difficulty in seating the fuze, it should be removed and another one inserted. If the same trouble is encountered with the second fuze, the shell should be rejected. After seating the fuze, set it in preparation for firing.

f. Bring up the projectile on the loading tray and place it on the loading ramp (fig. 97). Grasp the handles of the tray and raise it with the front slightly above the rear. Get a firm grip on the handles as a projectile may be dropped easily if the tray is not carried in the proper position. Exercise extreme care that the fuze does not come in contact with any objects.

CAUTION: *The projectile will not be brought to the rear of the weapon until after the weapon has returned to battery.*

g. Place the rammer head squarely against the base of the projectile and slide it off the loading tray onto the loading ramp (fig. 98). Then push the projectile slowly up the loading ramp until it has cleared the threads of the breech recess. Next, ram the projectile into position in the tube with a powerful stroke (fig. 99). It is important that projectiles be rammed in place with a uniform force since variations in the ramming force will cause slight variations in the range. It is also important to avoid damage to the rotating bands

HOWITZER, CARRIAGE, TRANSPORT WAGONS, CRANE,
AND CLAMSHELL TRAILER

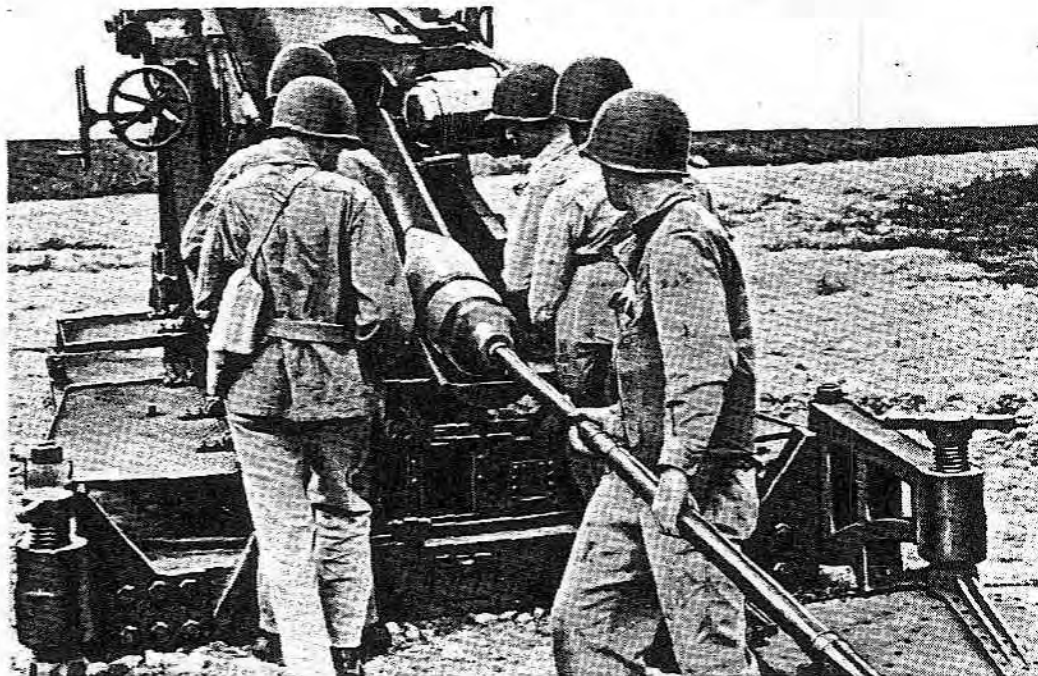

RA PD 72198

Figure 98 – Transferring Projectile From Loading Tray to Loading Ramp

on the projectile as such damage is likely to cause erratic flight of the projectile.

h. Prepare the Propelling Charge. For description and preparation for firing of the propelling charge, see paragraph 98. Bring the prepared propelling charge up to the breech immediately after the projectile has been rammed.

CAUTION: An exposed propelling charge will not be near the weapon at any other time.

i. Load the Propelling Charge. The loading tray is not required. Place the charge on the loading ramp with the igniter end to the rear and push it in the howitzer tube until the base of the charge is flush with the rear end of the powder chamber (fig. 100). To insure ignition of the charge, the igniter pad must come directly in front of the vent when the breech is closed.

j. Close the Breech. To insure transmission of the flash from the primer to the charge, the obturator spindle head must come in contact with the base of the charge when the breech is closed, must push the charge forward to its final position, and must remain in contact with it.

31. TO FIRE.

a. Insert a percussion type primer in the firing mechanism (fig. 101). The primer case is inserted into the primer holder by press-

240-MM HOWITZERS M1918MI AND M1918MIA1, 240-MM HOWITZER CARRIAGE M1918A2, AND TRANSPORT WAGONS M4 AND M5

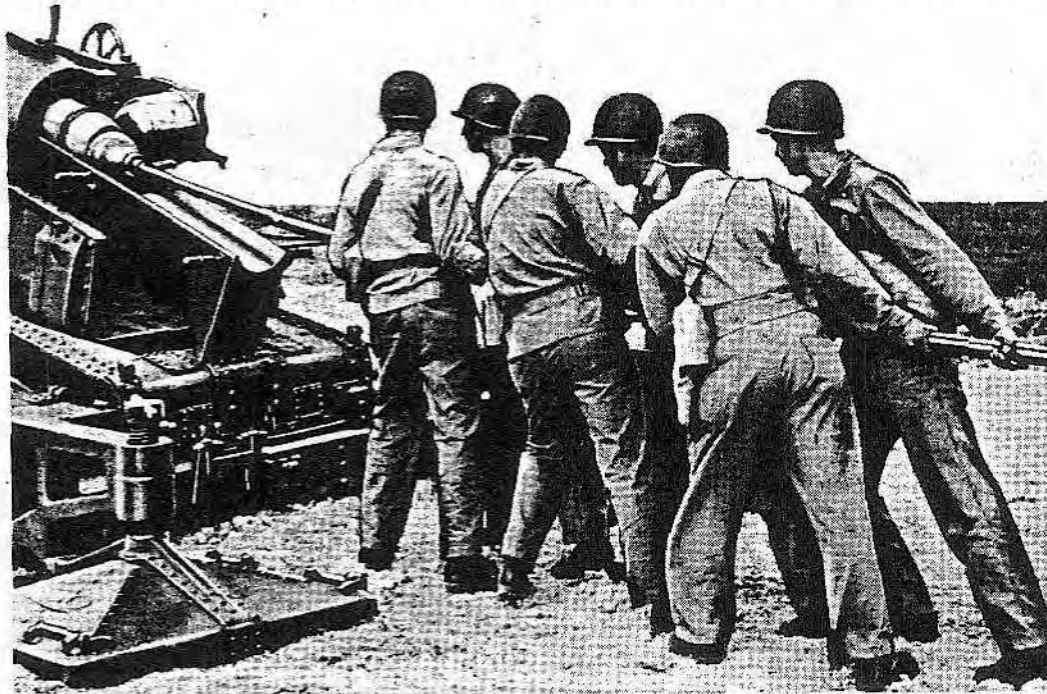

RA PD 72199

Figure 99 – Ramming the Projectile

ing the head of the case downward firmly against the firing pin guide so that the rim of the case slides under the edges of the slot in the primer holder. The primer is then held in position by the pressure of the firing spring.

b. Should the primer be slightly oversize, or the primer holder dirty, the primer will stick before it is properly seated. Force should not be exerted. Remove the primer and clean the primer holder, or insert another primer.

c. Insert the firing mechanism in the firing mechanism housing, taking care that the front end of the primer has entered the obturator spindle plug. Seat the mechanism by turning the firing mechanism handle in a clockwise direction until it has engaged the latch. If the mechanism will not seat properly, the primer may be oversize, or its seat in the plug or in the primer holder may be dirty, or the breech may not be fully closed.

CAUTION: Make certain that the firing mechanism is screwed all the way into position and latched. Despite safety devices, it is possible to fire the piece even though the firing mechanism is not completely in its proper firing position. If this occurs, damage to the breech and injury to the personnel may result.

d. Attach the lanyard and move the percussion hammer lock bolt to the left, away from the percussion hammer. If the percus-

**HOWITZER, CARRIAGE, TRANSPORT WAGONS, CRANE,
AND CLAMSHELL TRAILER**

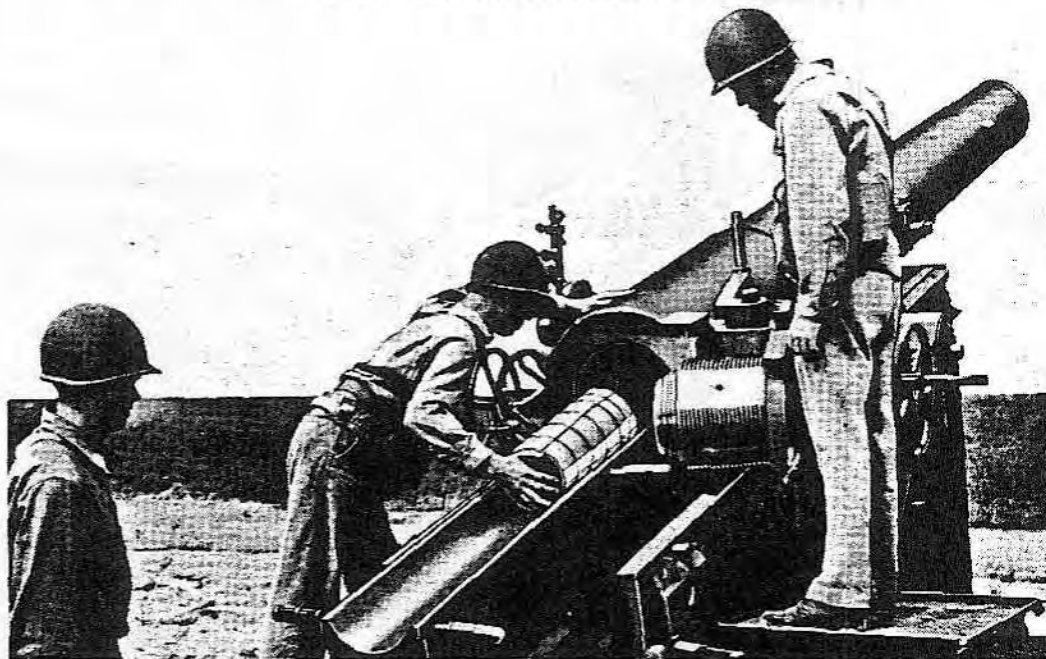

RA PD 72200

Figure 100 – Loading the Propelling Charge



RA PD 72201

Figure 101 – Installing Primer in Firing Mechanism

sion hammer lock bolt is disengaged from the percussion hammer when the lanyard is attached, to prevent premature firing, hold the percussion hammer with one hand while attaching the lanyard (fig. 102).

e. Firing is effected from the side of the carriage by movement

240-MM HOWITZERS M1918MI AND M1918MIA1, 240-MM HOWITZER
CARRIAGE M1918A2, AND TRANSPORT WAGONS M4 AND M5



RA PD 72202

Figure 102 – Holding Percussion Hammer While Attaching Lanyard

of the firing rod, or from the side or rear by means of a lanyard attached to the outer end of the percussion hammer operating shaft (fig. 103). Grasp the lanyard with the right hand and, without raising the hand, pull with a quick, strong pull prolonged sufficiently to insure the percussion hammer hitting the firing pin. The lanyard will be pulled from a position as near the piece as is convenient, and sufficiently out of the line of recoil to insure safety. Care must be exercised in pulling the lanyard not to injure the firing mechanism parts.

f. If a long lanyard is used, it will be attached immediately before, and detached immediately after, the round is fired.

32. POINTS TO BE OBSERVED DURING FIRING.

a. Observe the movement of the weapon in recoil. It should be smooth with uniformly decreasing velocity. The point of maximum recoil should be reached without shock. Then the recuperator (counterrecoil) system should return the weapon completely into battery without shock. If uneven, jerky movement or shock is observed, or if the weapon will not return fully to battery, inspect the recoil mechanism to determine the cause.

b. Check the recoil mechanism to determine if there is any leakage of liquid.

c. Measure the length of recoil for the first round and at intervals

**HOWITZER, CARRIAGE, TRANSPORT WAGONS, CRANE,
AND CLAMSHELL TRAILER**

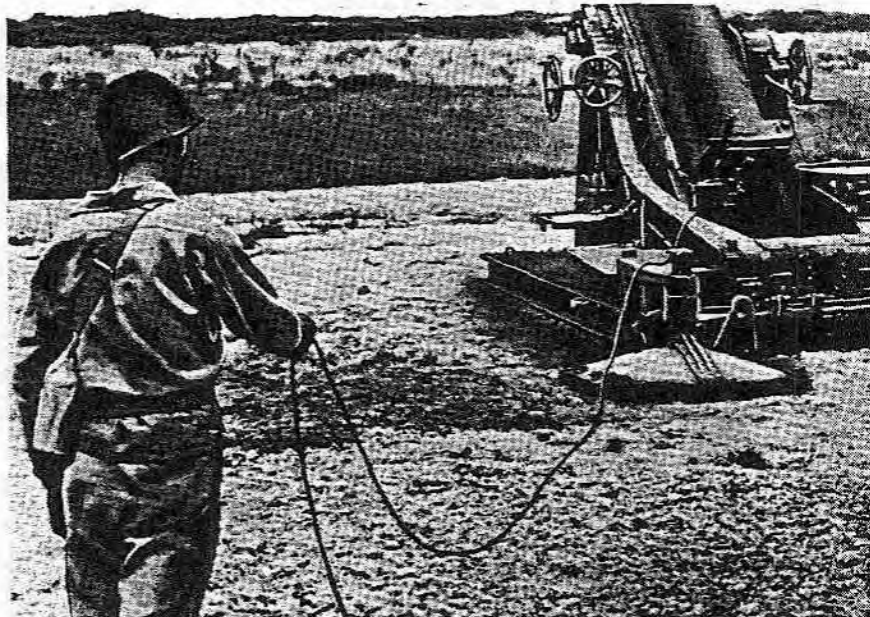

RA PD 72203

Figure 103 – Firing the Howitzer

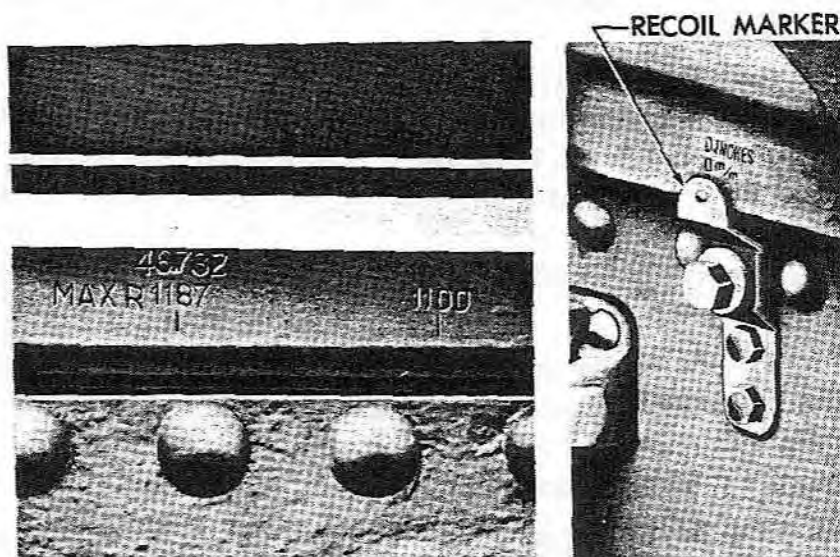

RA PD 72204

Figure 104 – View of Recoil Marker and Maximum Recoil Markings

during firing, when practicable. Excessive recoil will cause damage to the mechanism.

d. If the length of recoil does not fall within the limits designated, check the recoil and recuperator system as outlined in subparagraph e, below, and take the necessary corrective measures.

e. **To Measure Length of Recoil.**

(1) The length of recoil is measured by a recoil marker on the

240-MM HOWITZERS M1918MI AND M1918MIA1, 240-MM HOWITZER CARRIAGE M1918A2, AND TRANSPORT WAGONS M4 AND M5

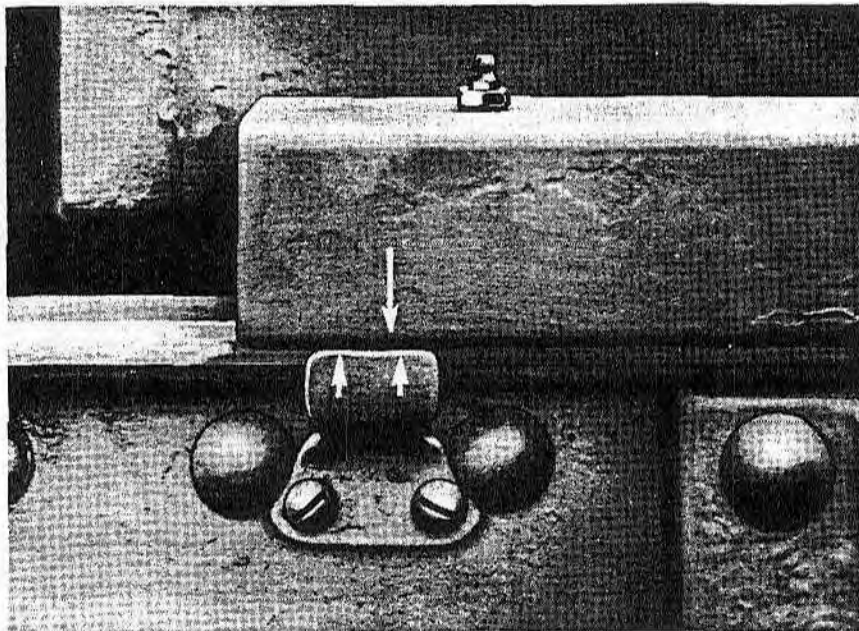

RA PD 72205

Figure 105 – Battery Position Indicator

left side of the cradle (fig. 104). An adjusting marker nut regulates the pressure of the marker point against the sleigh during recoil. The latter traces a line through a heavy smear of grease or other substance placed on the scale which is stamped on the sleigh. The scale is graduated in inches and millimeters. The maximum recoil permissible is 46.73 inches (1,187 mm) and the minimum 44.83 inches (1,138 mm).

(2) A battery position indicator, which shows when the howitzer has returned to battery, is located on the right side of the cradle (fig. 105). If the line on the sleigh does not lie between the two lines on the cradle, the howitzer must not be fired.

(3) If the recoil is too long, after making sure that the recoil cylinders are full of liquid, the nitrogen pressure in the recuperator reservoir should be measured and the liquid lever tested.

CAUTION: After firing, the liquid and nitrogen in the recuperator reservoirs become mixed, and it is necessary to wait at least 20 minutes before testing the liquid level to permit the nitrogen to separate from the liquid.

(4) If the nitrogen pressure is less than normal for the temperature, reestablish the pressure.

(5) Test the liquid in the recuperator mechanism after placing the howitzer in a perfectly level position lengthwise and crosswise. Turn the depth gage pointer until liquid emerges from the pressure

HOWITZER, CARRIAGE, TRANSPORT WAGONS, CRANE, AND CLAMSHELL TRAILER

gage adapter. The position of the depth gage pointer on the scale indicates the amount of liquid to be added or withdrawn.

(6) If, after making the above test, the recoil is still too long, notify the ordnance maintenance company.

33. TO UNLOAD.

a. **Service Rounds.** No unloading rammer is provided for use with this materiel for unloading service rounds of ammunition. When it is desired to unload the piece, the projectile may be fired out of the weapon.

b. **Dummy Projectile.** To unload the dummy projectile, lower the weapon to a convenient elevation (about 15 deg) and, with the loading ramp in place, remove the projectile with a dummy projectile extractor. Place the hook of the extractor in the recess in the base of the dummy projectile and engage the hook on the shoulder. Then jerk the projectile to release the band stuck in the forcing cone. Push the projectile forward and repeat if necessary. Use the extractor to guide the projectile onto the loading ramp.

34. TO REMOVE A FUZE FROM A SHELL.

a. If, for any reason, a projectile which has been fuzed is not to be fired, the fuze will be removed. Reset the fuze to "SAFE" if so designed. Start the unscrewing operation with the fuze wrench; complete the unscrewing of the fuze by hand.

CAUTION: If the adapter starts to unscrew with the fuze, the unscrewing must be stopped at once and the shell disposed of as directed by the officer in charge.

35. TO PLACE IN TRAVELING POSITION.

a. Loading Howitzer on Transport Wagon.

(1) If weapon has been fired, clean, dry, and oil the bore and chamber, and disassemble, clean, and oil the breech and firing mechanism. For disassembly of these units, refer to chapter 2, section XI.

(2) Remove panoramic telescope and the quadrant sight.

(3) Move Transport Wagon M4 along one side of the weapon and the truck-mounted crane on the other side in a convenient position for loading the materiel.

(4) Swing the percussion hammer up in traveling position and lock by moving the percussion hammer lock bolt to the right (fig. 106). Also secure the elevating arms by the elevating lock plunger.

240-MM HOWITZERS M1918MI AND M1918MIA1, 240-MM HOWITZER
CARRIAGE M1918A2, AND TRANSPORT WAGONS M4 AND M5

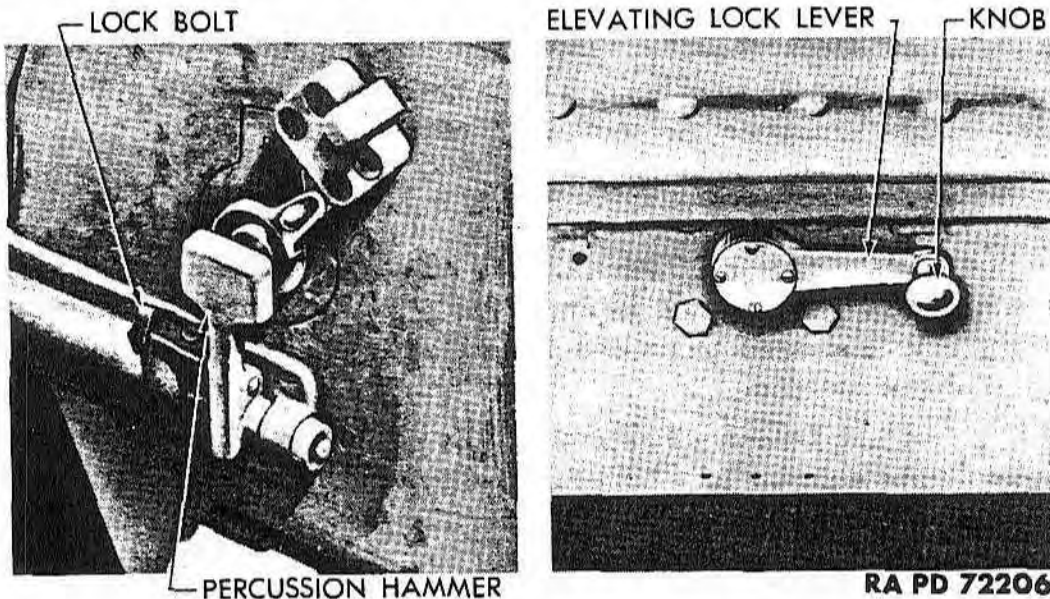

Figure 106 — Percussion Hammer and Elevating Lock Plunger in Traveling Position

To do this, pull out on the locking pin knob and swing the elevating lock lever all the way to the right (counterclockwise) (fig. 106).

(5) Engage the traversing lock at rear end of platform to keep top carriage in position.

(6) Remove quick-loading handwheel and place it in the platform trunk.

(7) Disengage the cradle lock by pulling out on the knob, swinging the lock lever to the left until the locking pin engages the second hole from the left in the bracket, and pulling the lock mechanism to the outer position on the bracket.

(8) Unlock and turn back the trunnion bearing caps on the top carriage. To unlock these caps, push in the trunnion bearing cap locking pin plunger and turn the left trunnion bearing cap locking pin to the left (counterclockwise) and the right trunnion bearing cap locking pin to the right (clockwise) as far as possible against the stops.

(9) Install the cross bar with links at the rear end of the cradle (fig. 107). Then attach the lifting sling to the howitzer and cradle assembly, attaching it to the thimbles on the howitzer and the links of the cross bar in the rear end of the cradle (fig. 86).

(10) Attach the lifting hook of the crane to the sling and lift the howitzer, sleigh, and cradle assembly off the top carriage and place it in traveling position on the transport wagon (fig. 85).

HOWITZER, CARRIAGE, TRANSPORT WAGONS, CRANE, AND CLAMSHELL TRAILER

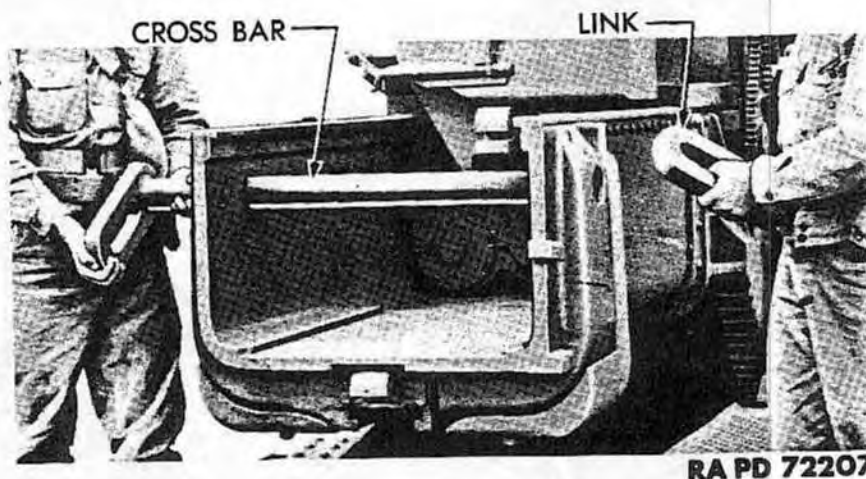

Figure 107 — Installing Cross Bar at Rear End of Cradle

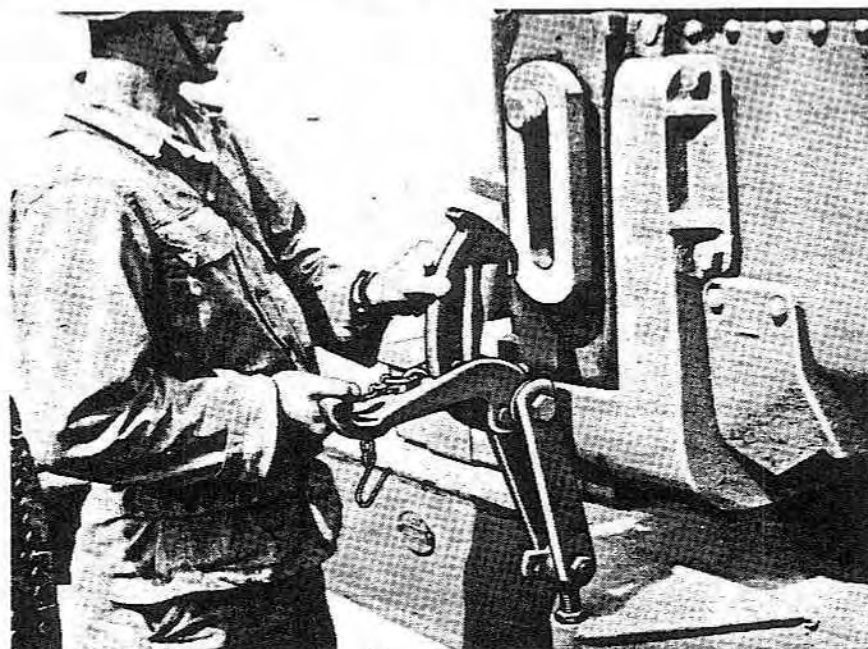

Figure 108 — Attaching Locking Hook to Cradle Cross Bar Link

(11) Attach the two locking hooks at each side of the transport wagon to retain the howitzer assembly in position (fig. 108).

(12) Cover the howitzer assembly with the covers provided for that purpose and move the transport wagon with load out of the way.

h. Loading Platform and Top Carriage Assembly on Transport Wagon.

(1) Move Transport Wagon M5 into a convenient loading position alongside the platform assembly.

240-MM HOWITZERS M1918MI AND M1918MIA1, 240-MM HOWITZER CARRIAGE M1918A2, AND TRANSPORT WAGONS M4 AND M5

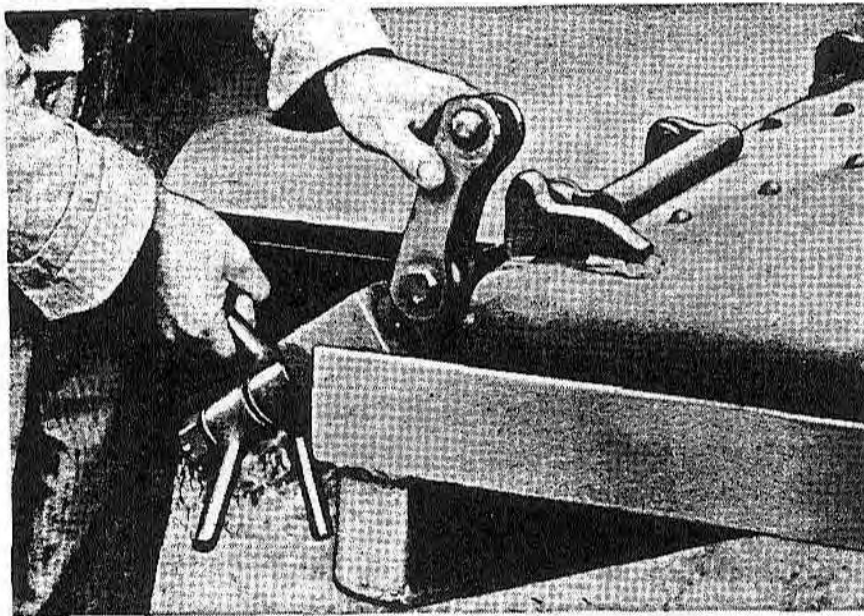

RA PD 72209

Figure 109 — Fastening Float Locking Clamp

(2) Raise all footboards to traveling position. Place breech operators footboard in traveling position on front end of top carriage (fig. 4).

(3) Remove elevating and traversing handwheels and place them in the platform trunk. The elevating handwheel is removed after pressing together the latch springs in the hub. The traversing handwheel with its shaft is removed after pressing upon the latch under the shaft and unscrewing the collar.

(4) Unscrew the swinging arm screws in the outer ends of the outriggers to release them from the floats. Then swing the arms to traveling position and turn the screws down to engage them with the brackets on the platform.

(5) Mount the two floats on the transport wagon and secure with the locking clamps (fig. 109).

(6) Attach the lifting sling to the top carriage and platform assembly. Two loops at the rear end of the platform and suitable eyes at the inner side of the front plate on the top carriage are provided for attaching the lifting sling to the mechanism.

(7) With the hook of the crane attached to the lifting sling (fig. 77), lift the top carriage and platform assembly out of the pit and place it in traveling position on the transport wagon (fig. 76). Before mounting the platform assembly on the transport wagon, place the two rear locking hooks in the position shown in figure 110.

(8) Attach the locking hooks at the sides and the locking clamp

**HOWITZER, CARRIAGE, TRANSPORT WAGONS, CRANE,
AND CLAMSHELL TRAILER**

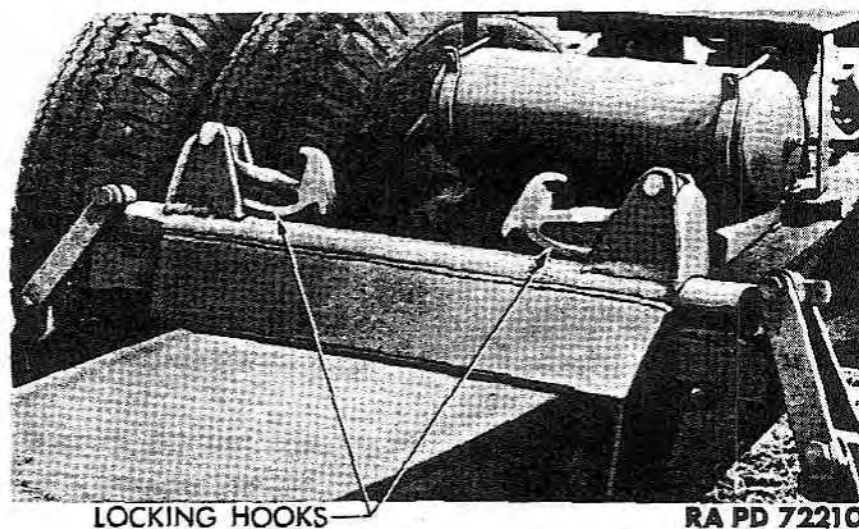

Figure 110 – Loading Position of the Locking Hooks on Transport Wagon M5

at the front of the transport wagon to retain the top carriage and platform assembly in traveling position.

(9) Install the loading tray and loading ramp in position on the footboard and the platform respectively (fig. 4).

(10) Cover the top carriage and platform assembly with the cover provided for that purpose.

e. Attach Clamshell Trailer M16 to truck-mounted crane, and load clamshell in trailer (fig. 69).

36. POINTS TO BE OBSERVED BEFORE TRAVELING.

a. After the howitzer and platform assemblies have been loaded on their respective transport wagons, a special inspection will be made to determine whether the following conditions exist:

(1) The transport wagons are properly attached to the prime movers.

(2) The air line hoses and jumper cables are properly connected to the prime movers.

(3) Apply all brakes to make sure they are operating. Also check to see that the rear blackout lights are operating properly.

(4) The tires are properly inflated.

(5) The howitzer, sleigh, and cradle assembly and the top carriage and platform assembly are properly secured to their respective transport wagons.

(6) The floats are in place and properly secured.

240-MM HOWITZERS M1918MI AND M1918MIA1, 240-MM HOWITZER CARRIAGE M1918A2, AND TRANSPORT WAGONS M4 AND M5

- (7) The top carriage traversing lock is engaged.
- (8) All footboards on the top carriage are turned up and locked and the breech operator's footboard is securely fastened in front.
- (9) The loading tray and loading ramp are in traveling position and the loading ramp securely fastened.
- (10) The trunnion bearing caps are turned back in position and locked.
- (11) The swinging arms of the outriggers are swung up to the sides of the platform and the screws turned down into the sockets provided for that purpose.
- (12) The elevating lock plunger in the connecting plate of the elevating arm is inserted in the socket on the cradle plate and the handle properly locked.
- (13) The breech mechanism of the howitzer is closed and the percussion hammer locked in traveling position by the lock bolt.
- (14) All covers for the howitzer and carriage assemblies are in place and properly strapped.
- (15) All other parts are in good condition and not damaged or broken.
- (16) A report of any repairs needed must be made immediately to the officer in charge of the materiel or to the commanding officer of the ordnance maintenance company.

37. BRAKE OPERATION.

a. The proper functioning of the brake control system is of vital importance. Wheels should be free from brake drag, and the wheel bearings should be properly adjusted to prevent drag due to loose bearings.

b. Before starting the vehicles, release hand brakes on the transport wagon. Also observe the air pressure gage on the prime mover to determine the air pressure in the air brake emergency reserve tank. This pressure must be 70 pounds or more before the air brakes can develop their full effectiveness.

c. When applying the brakes for an ordinary stop, the brakes should be applied as hard at the very start as the speed and road conditions will permit, and then graduated off as the speed is reduced, so that at the end of the stop very little pressure remains in the air brake diaphragms.

CAUTION: To avoid injury to the personnel, to insure safe road transportation, and to prevent jackknifing of the load, the driver should have the load under control at all times by avoiding any slack between

**HOWITZER, CARRIAGE, TRANSPORT WAGONS, CRANE,
AND CLAMSHELL TRAILER**

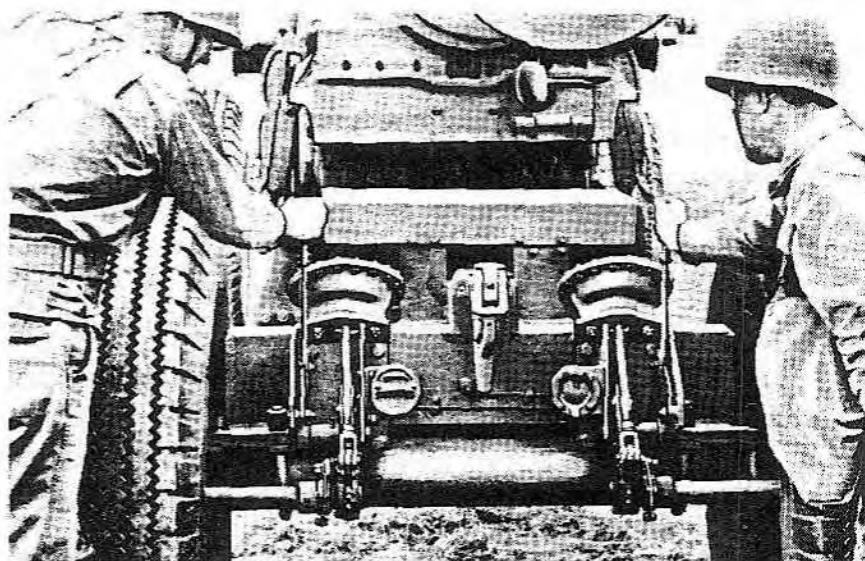

RA PD 72211

Figure 111 – Applying Hand Brakes on Transport Wagon

the load and the prime mover. On down grades, curves, and rough or slippery roads, the speed should be held to 10 miles per hour or less depending on conditions. When applying the brakes for a slowdown or stop, always apply the brakes on the load before applying the brakes on the prime mover.

d. The air brakes are designed so that when the lever of the brake valve is moved to the limit of its stroke, an emergency application results, which will stop the vehicles in the shortest possible time. This heavy brake application should be reserved for emergency stops and not employed in ordinary brake service.

e. In the event of a break-in-two between the prime mover and the transport wagon, keep the brakes applied on the prime mover until a stop is made. Then hold the prime mover with the hand brake while closing the cut-out cocks in the service and emergency lines to prevent further loss of air, after which the brake system will recharge and restore full braking power to the prime mover. Be sure to open the cut-out cocks after recoupling is made.

f. After a break-in-two has occurred between the transport wagon and prime mover, the transport wagon brakes can be disengaged by releasing the air from the transport wagon air tank or by building up the emergency line pressure equal to that in the transport wagon tank. This is accomplished by air pressure from the prime mover.

g. If it is necessary to move a transport wagon without recoupling the air connection to the prime mover after a break-in-two has occurred, a plug at the end of the transport wagon air tank must be

**240-MM HOWITZERS M1918MI AND M1918MIA1, 240-MM HOWITZER
CARRIAGE M1918A2, AND TRANSPORT WAGONS M4 AND M5**

removed to release the transport wagon brakes. Be sure to install the plug after the brakes have been released.

h. When parking the transport wagons, apply the hand brakes by pulling down on the hand brake levers, and at the same time releasing the handle latch levers to allow the brakes to remain in the engaged position (fig. 111). When releasing the hand brakes, simply release the hand lever latches and move the levers up to the disengaged position.

i. When detaching the transport wagons from the prime movers, close the air cocks on the prime movers and disconnect the air lines. Then attach the air line couplings to the dummy couplings on the drawbars, to keep sand and dirt out of the air lines.

Section VII

LUBRICATION

38. INTRODUCTION.

a. General.

(1) Lubrication is an essential part of preventive maintenance, determining to a great extent the serviceability of parts and assemblies. *Satisfactory operation and long life of the materiel are not assured unless the materiel is kept clean and well lubricated.*

(2) Apply sufficient lubricants, but avoid wasteful practices. Excessive lubrications will result in dust accumulations on some moving parts and, if not removed, may cause wear and malfunctioning. Particular attention should be given to the lubrication of sliding surfaces of the breech mechanism and to other bearing surfaces which contain no oilholes, plugs, or fittings.

(3) Operate lubricating devices slowly, maneuvering the parts while they are being lubricated to insure proper distribution of the lubricant to the bearing surfaces. Keep all exposed parts clean and well lubricated. The materiel should always be lubricated after washing. Do not use high-pressure washing system for artillery materiel.

(4) Should an oiler valve stick and prevent the passage of oil, loosen it with a piece of wire pushed through the hole. Do not use a piece of wood; it might splinter. Care should be taken not to damage the valve. In cleaning lubrication fittings, the necessary wiping should be done with a piece of firm cloth and no lint be allowed to remain in any opening.

**HOWITZER, CARRIAGE, TRANSPORT WAGONS, CRANE,
AND CLAMSHELL TRAILER**

b. **Identification of Lubrication Points.** Oilholes and similar lubricating fittings should be marked with a circle about $\frac{3}{4}$ inch in diameter painted with synthetic gloss-red enamel, in order that they may be readily located.

NOTE: Do not paint the fittings themselves.

c. **Cleanliness.** Care must be taken when cleaning any oil compartment or bearing surface to insure the complete removal of all residue or sediment, and to prevent dirt or other foreign matter from entering. Make sure all oilholes and fittings are clean before applying lubricant.

d. **Climate.** Operation under special climatic and atmospheric conditions, such as the extreme heat and humidity of the tropics, or arctic cold, make necessary special treatment of the materiel. This special treatment may vary with the prevailing conditions and the seasons, and is to be applied at the discretion of the ordnance officer. Before lubricating materiel for arctic conditions, thoroughly remove all old lubricant. It is not necessary to clean out old lubricant when materiel prepared for arctic conditions is to be lubricated for warmer climates.

e. **Cold Weather.** For lubrication and service below 0 degrees F, refer to chapter 7.

39. LUBRICATION ORDER.

a. War Department Lubrication Orders Nos. 145 and 145A (formerly War Department Lubrication Guides Nos. 145 and 145A) (figs. 112, 113, 114, and 115) prescribes first and second echelon lubrication maintenance. Lubrication to be performed by ordnance maintenance personnel is covered by the maintenance manual.

b. A Lubrication Order is placed on or is issued with each item of materiel, and is to be carried with it at all times. In the event the materiel is received without an order, the using arms shall immediately requisition a replacement from the Commanding Officer, Fort Wayne Ordnance Depot, Detroit 32, Michigan.

c. Lubrication instructions on the order are binding on all echelons of maintenance and there shall be no deviations, except as indicated in subparagraph d, below.

d. Service intervals specified on the order are for normal operating conditions. These intervals will be reduced under extreme conditions such as excessively high or low temperatures, prolonged periods of high-speed operation, continued operation in sand or dust, immersion in water, or exposure to moisture, any one of which may quickly destroy the protective qualities of the lubricant.

240-MM HOWITZERS M1918MI AND M1918MIA1, 240-MM HOWITZER CARRIAGE M1918A2, AND TRANSPORT WAGONS M4 AND M5

No. 145

(This material covered by 2 Guides, No. 146 and No. 145A)

LUBRICATION GUIDE

WAR DEPARTMENT ORDNANCE DEPARTMENT

**HOWITZER, 240-mm, M1918M1, M1918MIA1
CARRIAGE, HOWITZER, 240-mm, M1918A2
WAGON, TRANSPORT, CANNON, M4
WAGON, TRANSPORT, CARRIAGE, M5**

To clean parts, use SOLVENT, dry-cleaning, or Oil, fuel, Diesel. Dry before lubricating. Swab gun bore as well as breech and firing mechanism after removal of gas check pad from obturator spindle with a solution of 1/2 pound of SODA ash, to each gallon of warm water or with a thick suds of issue soap and warm water. Rinse with clear water and dry thoroughly before oiling.

NOTE— See Reverse Side for Lubrication Points on RIGHT SIDE of CARRIAGE

Clean fittings before applying lubricant. Lubricate after washing. Reduce intervals under severe operating conditions.

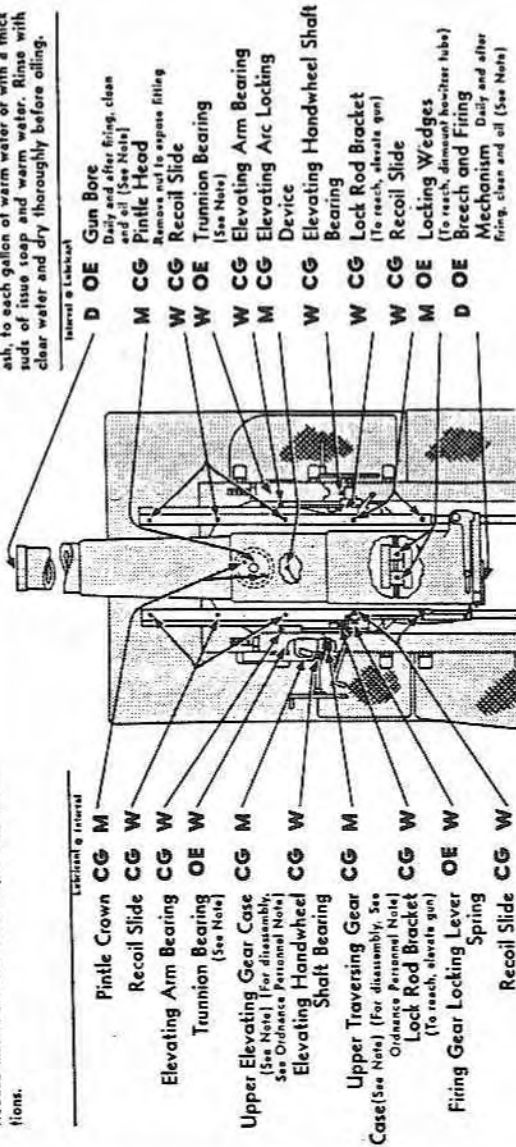

HOWITZER, CARRIAGE, TRANSPORT WAGONS, CRANE,
AND CLAMSHELL TRAILER

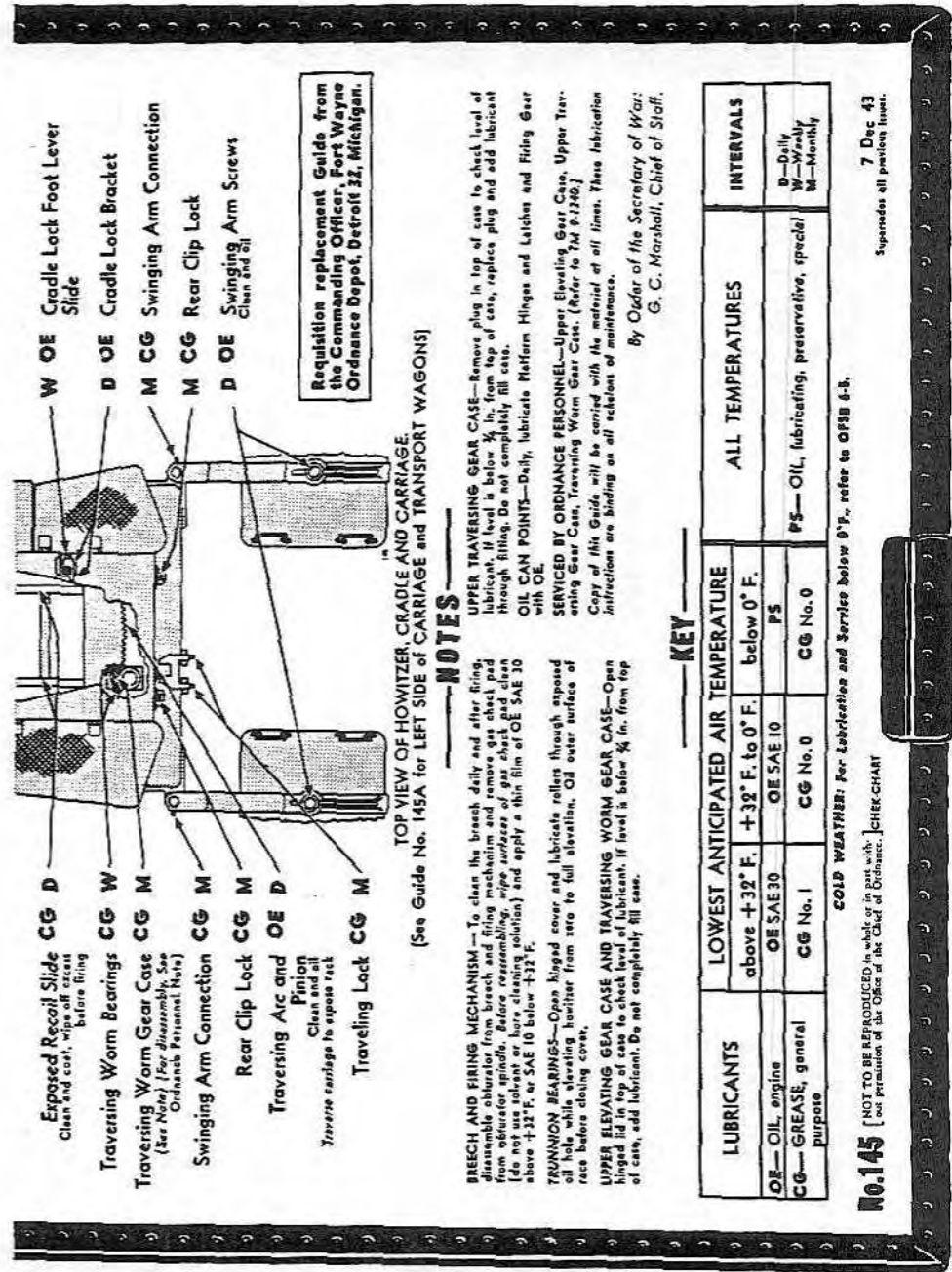

TOP VIEW OF HOWITZER, CRADLE AND CARRIAGE
(See Guide No. 145A for LEFT SIDE OF CARRIAGE AND TRANSPORT WAGONS)

NOTES

BREACH AND FIRING MECHANISM—To clean the breach daily and after firing, disassemble obturator from breach and firing mechanism and remove gas check pad from obturator spindle. Before reassembly, wipe surfaces of gas check pad clean (do not use solvent or hose cleaning solution) and apply a thin film of OE SAE 30 above +32°F, or SAE 10 below +32°F.

TRUSSION BEARINGS—Open hinged cover and lubricate rollers through spaced oil hole while elevating howitzer from zero to full elevation. Oil water surface of race before closing cover.

UPPER ELEVATING GEAR CASE AND TRAVERSING WORM GEAR CASE—Open hinged lid in top of case to check level of lubricant. If level is below ¼ in. from top of case, add lubricant. Do not completely fill case.

UPPER TRAVERSING GEAR CASE—Remove plug in top of case to check level of lubricant. If level is below ¼ in. from top of case, replace plug and add lubricant through fitting. Do not completely fill case.

OIL CAN POINTS—Daily, lubricate Platform Hinges and Leashes and Firing Gear with OE.

SERVICED BY ORDNANCE PERSONNEL—Upper Elevating Gear Case, Upper Traversing Gear Case, Traversing Worm Gear Case. (Refer to TM 9-1286.)

Copy of this Guide will be carried with the material at all times. These lubrication instructions are binding on all echelons of maintenance.

By Order of the Secretary of War:
G. C. Marshall, Chief of Staff.

KEY

LUBRICANTS	LOWEST ANTICIPATED AIR TEMPERATURE		ALL TEMPERATURES	INTERVALS
	above +32° F.	+32° F. to 0° F.		
OE—Oil, engine	OE SAE 30	OE SAE 10	PS	D—Daily W—Weekly M—Monthly
CG—Grease, general purpose	CG No. 1	CG No. 0	PS—Oil, lubricating, preservative, special	

COLD WEATHER: For Lubrication and Service below 0° F., refer to OFS 4-5.

No. 145 [NOT TO BE REPRODUCED in whole or in part without permission of the Chief of Ordnance.] CHECK CHART

7 Dec 43
Supersedes all previous issues.

Figure 112 — Lubrication Order

RA PD 22505

240-MM HOWITZERS M1918MI AND M1918MIA1, 240-MM HOWITZER
CARRIAGE M1918A2, AND TRANSPORT WAGONS M4 AND M5

WAR DEPARTMENT
ORDNANCE DEPARTMENT

LUBRICATION GUIDE

No. 145
(This material covered by 2 Guides, No. 145 and No. 145A)

**HOWITZER, 240-mm, M1918M1, M1918M1A1
CARRIAGE, HOWITZER, 240-mm, M1918A2
WAGON, TRANSPORT, CANNON, M4
WAGON, TRANSPORT, CARRIAGE, M5**

SNL D-35.

Clean fittings before applying lubricant.
Lubricate after washing.
Reduce intervals under severe operating conditions.

NOTE— See Reverse Side for Lubrication Points reached from TOP of HOWITZER, CRADLE and CARRIAGE

Requisition replacement Guide from the Commanding Officer, Fort Wayne Ordnance Depot, Detroit 32, Michigan.

To clean parts, use SOLVENT, dry-cleaning, or OIL, fuel, Diesel. Dry before lubricating.

For detailed instructions, refer to TM 9-340.

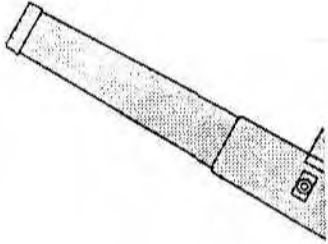

HOWITZER, CARRIAGE, TRANSPORT WAGONS, CRANE,
AND CLAMSHELL TRAILER

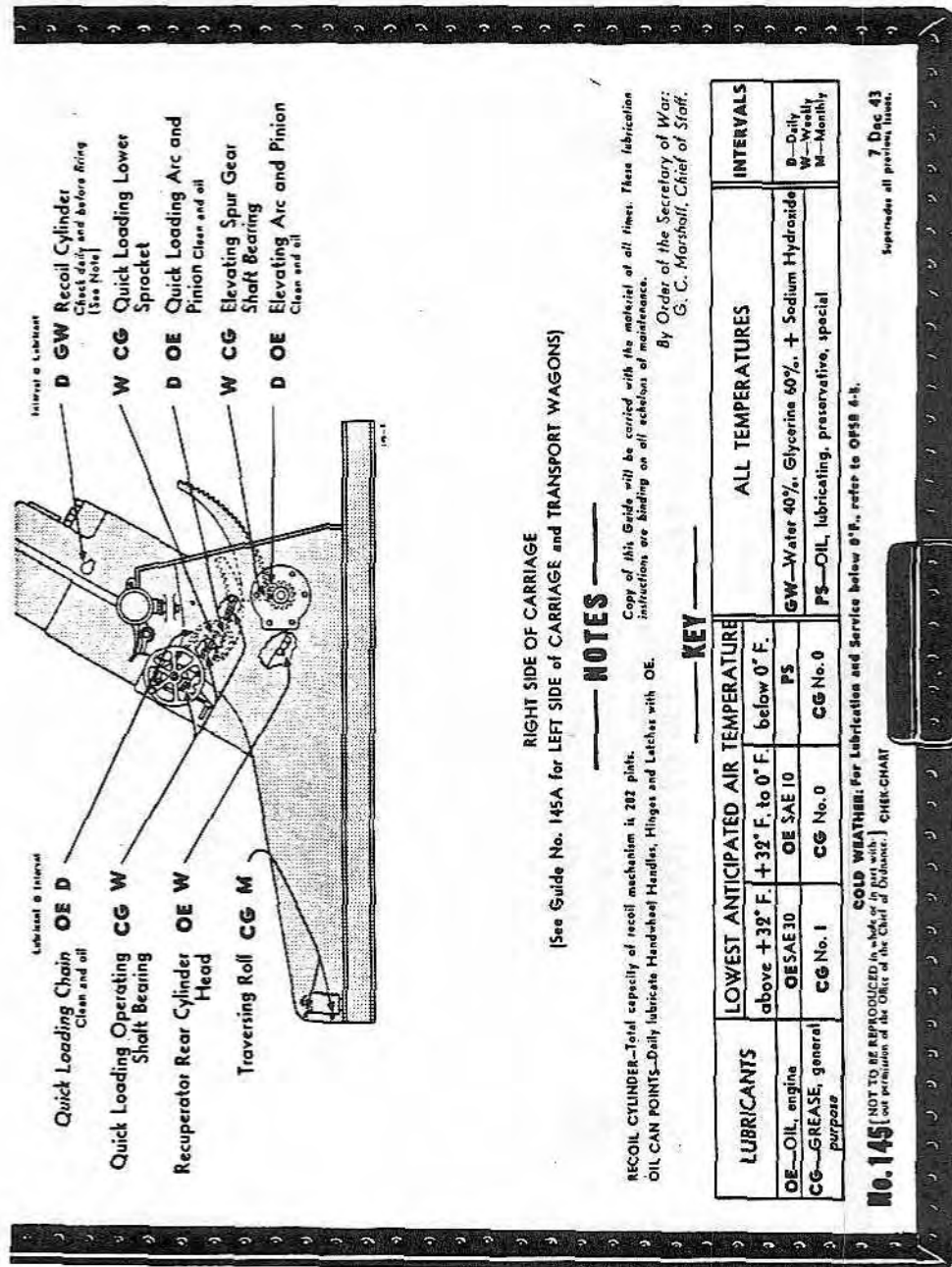

Figure 113 — Lubrication Order

240-MM HOWITZERS M1918MI AND M1918MIA1, 240-MM HOWITZER CARRIAGE M1918A2, AND TRANSPORT WAGONS M4 AND M5

WAR DEPARTMENT ORDNANCE DEPARTMENT LUBRICATION GUIDE

(This material covered by 2 Guides, No. 145A and No. 145B)



HOWITZER, 240-mm, M1918M1, M1918MIA1
CARRIAGE, HOWITZER, 240-mm, M1918A2
WAGON, TRANSPORT, CANNON, M4
WAGON, TRANSPORT, CARRIAGE, M5



For detailed instructions, refer to TM 9-340.

SNL D-15.
Clean fittings before applying lubricant. Lubricate after washing.
Reduce intervals under severe operating conditions.

Requisition replacement Guide from the Commanding Officer, Fort Wayne Ordnance Depot, Detroit 32, Michigan.

To clean parts, use SOLVENT, dry-cleaning, or OIL, fuel, Diesel. Dry before lubricating.

NOTE— See Reverse Side for Lubrication Points on TRANSPORT WAGONS

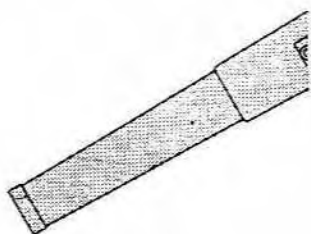

240-MM HOWITZERS M1918MI AND M1918MIA1, 240-MM HOWITZER CARRIAGE M1918A2, AND TRANSPORT WAGONS M4 AND M5

(This material covered by 3 Guides, No. 145 and No. 145A)

No. 145A

WAR DEPARTMENT LUBRICATION GUIDE

ORDNANCE DEPARTMENT



**HOWITZER, 240-mm, M1918M1, M1918MIA1
CARRIAGE, HOWITZER, 240-mm, M1918A2
WAGON, TRANSPORT, CANNON, M4
WAGON, TRANSPORT, CARRIAGE, M5**



For detailed instructions, refer to TM 9-340.

NOTE— See Reverse Side for Lubrication Points on LEFT SIDE of CARRIAGE

To clean parts, use SOLVENT, dry-cleaning, or OIL, fuel, Diesel. Dry before lubricating.

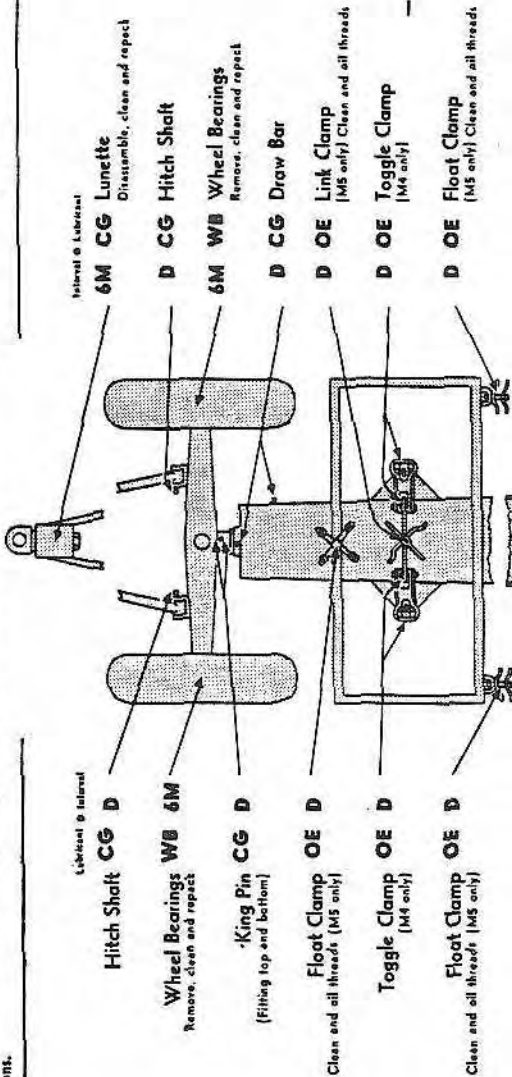

HOWITZER, CARRIAGE, TRANSPORT WAGONS, CRANE,
AND CLAMSHELL TRAILER

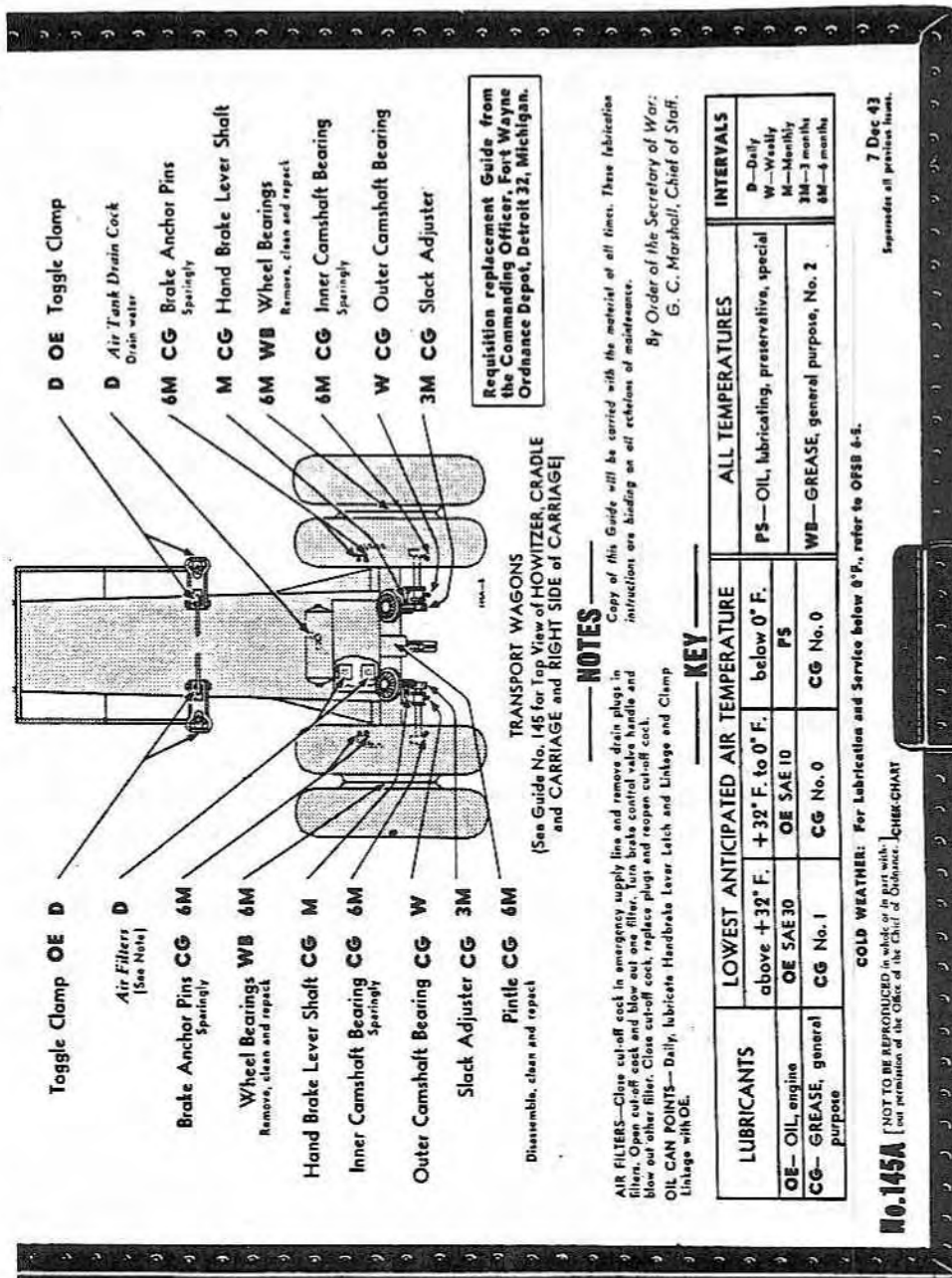

RA PD 22508

Figure 115 — Lubrication Order

240-MM HOWITZERS M1918MI AND M1918MIA1, 240-MM HOWITZER CARRIAGE M1918A2, AND TRANSPORT WAGONS M4 AND M5

e. Lubricants are prescribed in the "Key" in accordance with three temperature ranges: above +32 F; +32 F to 0 F; and below 0 F. When to change grades of lubricants is determined by maintaining a close check on operation of the materiel during the approach to change-over periods, especially during initial action. Sluggish action is an indication of lubricants thickening and the signal to change to grades prescribed for the next lower temperature range. Ordinarily it will be necessary to change grades of lubricants *only when air temperatures are consistently in the next higher or lower range*, unless malfunctioning occurs sooner due to lubricants being too thin or too heavy.

f. Lubrication Equipment.

(1) Each piece of materiel is supplied with lubrication equipment adequate to maintain the materiel. This equipment will be cleaned both before and after use.

(2) Lubrication guns will be operated carefully and in such manner as to insure a proper distribution of the lubricant.

g. **Points of Application.** Lubrication fittings, grease cups, oilers and oilholes are readily identifiable on the materiel by a red circle. Such lubricators and the surrounding surface will be wiped clean before lubricant is applied.

h. **Cleaning.** To clean parts, use dry-cleaning solvent, or Diesel fuel oil. Dry before lubricating. Swab gun bore as well as breech and firing mechanism after removal of gas-check pad from obturator spindle with a solution of 1/2 pound of soda ash to each gallon of warm water or with a thick suds of issue soap and warm water. Rinse with clear water and dry thoroughly before oiling.

i. **Air Filters.** Daily, remove drain plugs after closing cut-off cock on emergency supply line. Open cut-off cock to evacuate one filter, close cut-off cock. Operate brake control valve to service remaining air filter.

j. **Breech and Firing Mechanism.** To clean the breech daily and after firing, disassemble obturator from breech and firing mechanism and remove gas-check pad from obturator spindle. Before reassembling, wipe surfaces of gas-check pad clean (*do not use solvent or bore cleaning solution*) and apply a thin film of SAE 30 engine oil, above +32 F or SAE 10 below +32 F.

k. **Elevating Worm Gear Case.** Open hinged doors, clean and coat worm and worm wheel.

l. **Lower Traversing Gear Case and Intermediate Traversing Gear Case.** Remove plug in top of case to inspect lubricant level. If

HOWITZER, CARRIAGE, TRANSPORT WAGONS, CRANE, AND CLAMSHELL TRAILER

level is below $\frac{3}{4}$ inch from top of case, replace plug and add lubricant through fitting. Do not completely fill case.

m. Piston Rod Packing Boxes and Piston Rod Beam. These points are enclosed in a housing on the forward end of cradle. To reach, unscrew the three large nuts on recoil mechanism pistons, install crank on retracting screw, and retract housing until oilers are exposed. Lubricate with technical grade castor oil.

n. Recoil and Recuperator Cylinders. Total capacity of recoil mechanism is 282 pints.

o. Trunnion Bearings. Open hinged cover and lubricate rollers through exposed oilhole while elevating howitzer from zero to full elevation. Oil outer surface of race before closing cover.

p. Upper Elevating Gear Case and Traversing Worm Gear Case. Open hinged lid in top of case to check level of lubricant. If level is below $\frac{3}{4}$ inch from top of case, add lubricant. Do not completely fill case.

q. Upper Traversing Gear Case. Remove plug in top of case to check level of lubricant. If level is below $\frac{3}{4}$ inch from top of case, replace plug and add lubricant through fitting. Do not completely fill case.

r. Wheel Bearings. Remove bearing cone assemblies from hub. Wash bearing, cones, spindle, and inside of hub, and dry thoroughly. Do not use compressed air. Wet the spindle and inside of hub and hub cap with No. 2, general purpose grease, to a maximum thickness of $\frac{1}{16}$ inch only to retard rust. Lubricate bearings with No. 2 general purpose grease, with a packer, or by hand, kneading lubricant into all spaces in the bearing. Use extreme care to protect the bearings from dirt, and immediately reassemble and replace wheel. Do not fill hub or hub cap. The lubricant in the bearing is sufficient to provide lubrication until the next service period. Any excess might result in leakage into the drum. Adjust bearings in accordance with instructions in paragraph 66.

s. Oilcan Points. Daily, lubricate handbrake lever latch and linkage and clamp linkage, platform hinges and latches, firing gear, traversing and elevating shaft universal joints, handwheel handles, and miscellaneous hinges and latches with SAE 30 engine oil, above +32 F, SAE 10 from +32 F, to 0 F, and special preservative lubricating oil below 0 F.

t. Serviced By Ordnance Personnel.

(1) UPPER ELEVATING GEAR CASE AND UPPER TRAVERSING GEAR CASE, LOWER TRAVERSING GEAR CASE, INTERMEDIATE TRAV-

240-MM HOWITZERS M1918MI AND M1918MIA1, 240-MM HOWITZER CARRIAGE M1918A2, AND TRANSPORT WAGONS M4 AND M5

ERSING GEAR CASE, AND TRAVERSING WORM GEAR CASE. Every 6 months, disassemble units. Wash gears and interior of cases and repack to prescribed level with No. 1 general purpose grease, above +32 F and No. 0 below +32 F.

40. REPORTS AND RECORDS.

a. **Reports.** Unsatisfactory performance of materiel will be reported to the ordnance officer responsible for maintenance.

b. **Records.** A complete record of seasonal change of lubricants and recoil oils will be kept in the Artillery Gun Book for the materiel.

Section VIII

CARE AND PRESERVATION

41. GENERAL.

a. It is of vital importance that all parts of the materiel be kept in proper operating condition in order that the weapon be ready for immediate service. The proper use of tools and accessories and lubricating, cleaning, and preserving materials provided with the howitzer, carriage, and transport wagons will enable personnel to keep the materiel in proper working condition.

b. Proper lubrication with lubricants and intervals prescribed in section VII is essential to the care and preservation of the weapon. Examinations should be made periodically to insure that lubricants are reaching the parts for which they are intended.

c. The howitzer, carriage, and sighting equipment covers should be used when traveling or when the howitzer is not in service. When inactive for a limited length of time, the materiel should be prepared for storage as described in chapter 6.

d. In disassembly, assembly, and inspection, extreme care must be exercised to prevent dust, dirt, and other foreign matter from entering mechanisms of the howitzer and carriage.

e. All organizational spare parts, tools, and accessories should be kept in an orderly manner in the chests and containers provided, so that they can be quickly located when required. Items which are susceptible to rust or corrosion must be cleaned thoroughly after use and coated with a film of oil. Organizational spare parts for the howitzer and carriage should be maintained as complete as possible at all times. They should also be checked with lists in standard nomenclature lists, and all items used for replacement or which are missing should be replaced immediately.

**HOWITZER, CARRIAGE, TRANSPORT WAGONS, CRANE,
AND CLAMSHELL TRAILER**

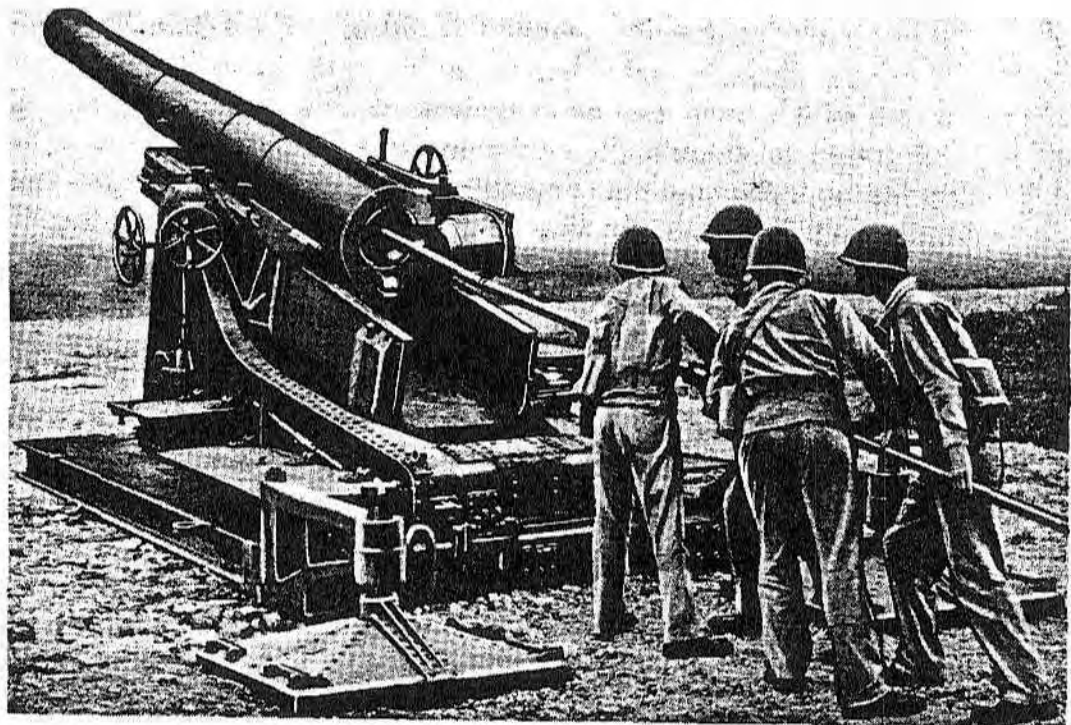

Figure 116 – Swabbing the Howitzer Bore

RA PD 72215

f. Should an enemy shell burst near the weapon or after the howitzer has been under fire, it must be determined that the weapon has not been damaged to a dangerous degree before further use of the howitzer. Damage of a serious nature should be reported to ordnance maintenance personnel.

g. When the howitzer and carriage is used in hot or cold climates or under extreme conditions of sand, dust, or water, refer to chapter 7.

42. HOWITZER.

a. Tube.

(1) Immediately after firing, clean the bore to insure complete removal of powder residue and primer salts. Under no circumstances will the howitzer remain without cleaning after it has been fired. Swab the bore with a cleaning solution of $\frac{1}{2}$ pound of soda ash, to each gallon of water. Rinse with clean warm water. After drying thoroughly with burlap, a film of oil will be applied with clean dry burlap. If soda ash, is not available, a soap sponging solution will be prepared by dissolving 1 pound of castile soap in 4 gallons of water. If castile soap is not available, issue soap may be used as a substitute. The soap should be shaved from the bar to facilitate dissolving. It should then be added to the water and the water heated until the soap is dissolved. The water should be stirred as

240-MM HOWITZERS M1918MI AND M1918MIA1, 240-MM HOWITZER CARRIAGE M1918A2, AND TRANSPORT WAGONS M4 AND M5

quietly as possible to prevent foaming. To avoid the necessity of handling large receptacles, as much soap as is required for all the water to be used can be dissolved in one pail of water. This concentrated soap solution can then be added to water in other receptacles to make up the prescribed proportions. Special precautions must be taken to rinse the bore thoroughly before drying if government issue soap is used in the solution, because of the possibility of soap leaving a gummy residue, and of corrosion from the presence of free caustic in the soap. In an emergency, water alone, preferably hot, may be used for cleaning. The cleaning process will be repeated daily for 3 days or more, until there is no longer any evidence of sweating. A uniform gray appearance is indicative of a clean bore.

(2) Daily, clean the bore by thoroughly wiping with clean burlap or wiping cloths and oiling the bore (fig. 116) with oil prescribed in the lubrication section (sec. VII). Every 5 days, unless evidence of rusting requires more frequent application, the bore will be cleaned with dry-cleaning solvent, and wiped dry before the film of oil is renewed.

(3) Before firing, wipe the bore with clean, dry burlap or wiping cloths, to insure that it is clean and dry.

(4) During firing, whenever the rate of fire permits, examine the bore for powder fouling.

(5) Extreme care must be taken to prevent injury to the gas-check seat, as bruises will affect the seating of the split rings and may cause leakage of gas and burning of the gas-check pad, resulting in serious erosion. The gas-check pad is susceptible to moisture, causing formation of rust on the gas-check seat. The gas-check pad should be wiped clean with a dry cloth, and then oiled lightly with clean cloth wet with engine oil (SAE 30 above +32 F, or SAE 10 below +32 F). Excess oil causes rapid deterioration; therefore the gas-check pad should not be soaked in oil. Never clean the gas-check pad with dry-cleaning solvent. *CAUTION: When cleaning the tube and breech assemblies, care should be taken that no dry-cleaning solvent ever comes in contact with the gas-check pad.*

(6) The surface of the leveling plates should be protected against injury. Do not place tools or other articles upon these surfaces. Any necessary repairs to these plates will be made by ordnance maintenance personnel.

b. Breech Mechanism.

(1) The breech mechanism should be kept clean and the parts well lubricated. Since no provision is made for lubricating the breech, it is necessary to disassemble the mechanism and clean and

HOWITZER, CARRIAGE, TRANSPORT WAGONS, CRANE,
AND CLAMSHELL TRAILER



Figure 117 — Cleaning the Primer Seat

oil. When the howitzer is not being fired, all metal surfaces should be wiped clean and the film of oil renewed daily to prevent rusting.

(2) Every 5 days, unless evidence of rusting requires more frequent application, all metal surfaces will be cleaned with dry-cleaning solvent, applied with a clean cloth and wiped dry before renewing the oil film. It is important, in applying the solvent, not to allow it to touch the gas-check pad, as absorption by the canvas cover will cause softening of the pad.

(3) The primer seat and venthole in the obturator spindle should receive careful attention to prevent powder fouling. In cleaning, use the vent cleaning tools provided for this purpose (figs. 117 and 118). The slightest accumulation of fouling in the primer seat will cause the primer to enter with difficulty, and like difficulty will be experienced in extraction, with the possibility of the breakage of parts.

(4) Whenever possible, the breech should be kept covered to protect it from dust and grit.

(5) The breechblock should rotate smoothly. If it does not, or if an unusual effort is required to operate it, disassemble the breech mechanism (par. 77), and examine the parts to determine the cause. If correction of the difficulty is beyond the scope of the using arms, the ordnance maintenance personnel will be notified.

(6) Parts that are likely to be deformed by accidental injury, due to their prominence, are the operating lever, percussion hammer operating shaft with its housing, and the percussion hammer. The parts most likely to become broken in service are the various springs, rack,

240-MM HOWITZERS M1918MI AND M1918MIA1, 240-MM HOWITZER
CARRIAGE M1918A2, AND TRANSPORT WAGONS M4 AND M5

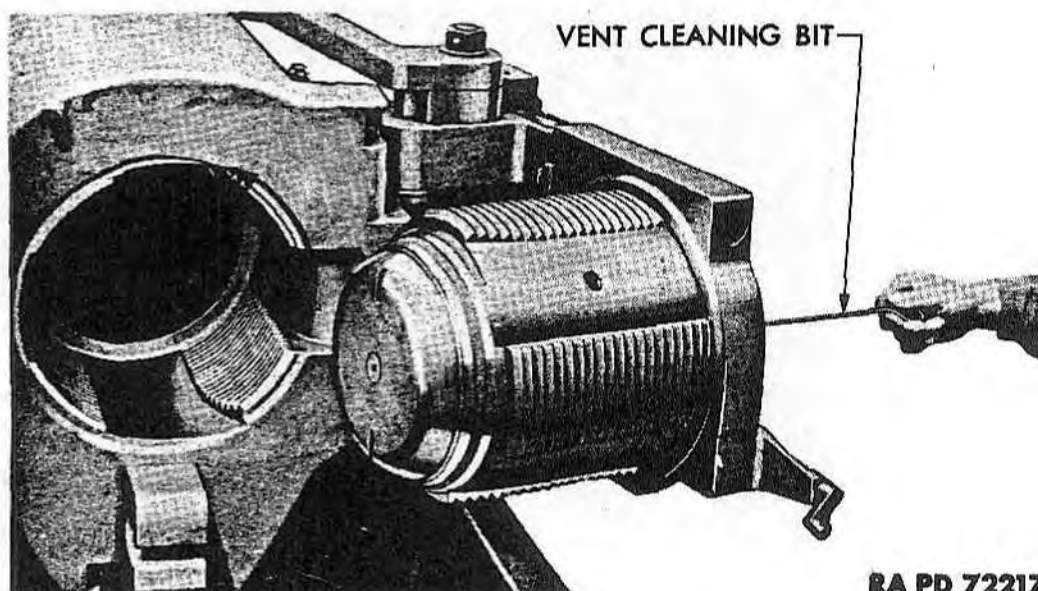

RA PD 72217

Figure 118 – Cleaning the Obturator Spindle Vent

rack segment, operating lever shaft, hinge pin, and the firing mechanism.

CAUTION: In assembly or disassembly, do not use a steel hammer or other steel tool directly on any part of the mechanism. A brass drift, or wood block may be held against the part or a copper or hide-faced hammer may be used to prevent deforming the parts.

c. Firing Mechanism.

(1) When the howitzer is not being fired the mechanism should be disassembled, cleaned, and the film of oil renewed daily. Dry-cleaning solvent, should be used for cleaning the parts at least every 5 days before renewing the oil film.

(2) Fouling of the firing pin or the use of too heavy oil may cause the weapon to misfire, especially in cold weather, when the oil congeals.

43. CARRIAGE.

a. General.

(1) The care and preservation of the carriage in service includes proper cleaning, thorough periodic lubrication, and tightening of loosened parts. When traveling, it calls for proper attachment of the units to the transport wagons, secure locking of accessories and equipment in the traveling position, and full protective use of covers.

(2) All bearing surfaces, screw threads, and exterior parts must be kept as clean as conditions will permit. Exposed gear teeth and bearing

HOWITZER, CARRIAGE, TRANSPORT WAGONS, CRANE,
AND CLAMSHELL TRAILER

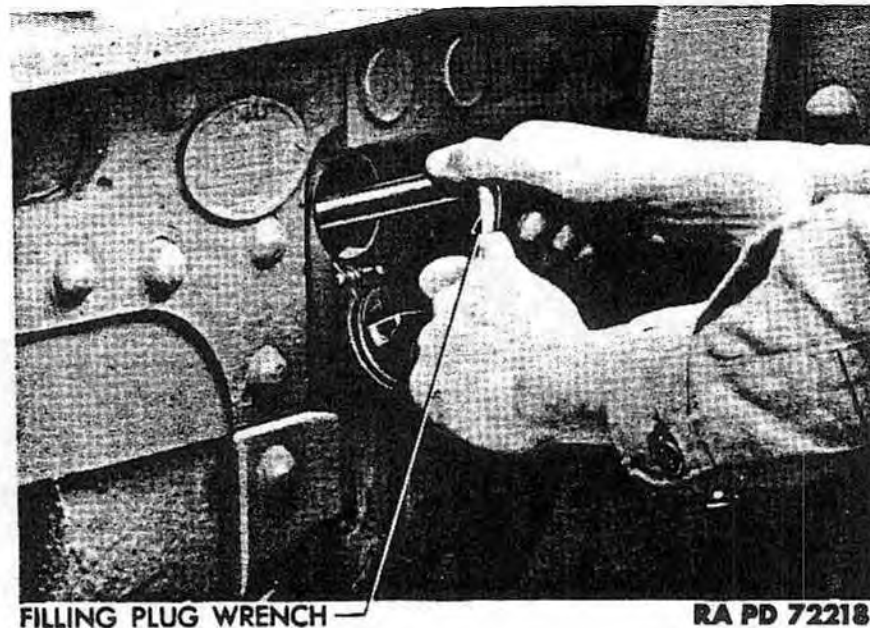

FILLING PLUG WRENCH —

RA PD 72218

Figure 119 — Removing Recoil Cylinder Filling Plug

surfaces require special attention. Bolts, screws, and nuts must be tight and locking devices properly secured wherever provided. Cotter pins must be properly spread.

44. RECOIL AND RECUPERATOR LIQUIDS.

a. The recoil fluid for the recoil cylinders and recuperator system is a glycerine-water mixture, prepared in clean, dry containers as follows:

(1) 60 parts by volume glycerine, grade A, USP.; 40 parts by volume distilled water; 1 ounce of sodium hydroxide, CP (NaOH) pellets added to each 3 gallons of the mixture. *CAUTION: Caustic soda (lye) must not be used. The liquid should be strained through a clean piece of linen or muslin before using.*

(2) No attempt will be made to change the above glycerine-water formula for any reason. Increase of the sodium hydroxide content above that specified will destroy leather or other packings. Glycerine-water recoil fluid should be replaced with fresh fluid whenever it is found necessary to drain cylinders. Only in extreme cases of *emergency* may the old liquid be strained and used to refill recoil mechanisms. Used liquid should be conserved for use in preparing cold weather sponging solution, but its alkali content prohibits its use as a radiator or cooling system antifreeze.

b. Approximately 8½ gallons of liquid are required to fill each recoil cylinder. Approximately 18½ gallons of liquid are required to

240-MM HOWITZERS M1918MI AND M1918MIA1, 240-MM HOWITZER CARRIAGE M1918A2, AND TRANSPORT WAGONS M4 AND M5



RA PD 72219

Figure 120 – Filling the Recoil Cylinder With Liquid

fill the recuperator system. **CAUTION:** *The glycerine-water mixture used in the recoil mechanism must be neutral. Before filling the mechanism, test the mixture with blue litmus paper provided for that purpose. If the litmus paper remains blue, the mixture is neutral; but if it turns pink, add chemically pure sodium hydroxide until the acids in the glycerine are neutralized, which will be indicated when the litmus paper retains its blue color.*

c. Liquids for both systems will be carried ready mixed in the closed containers provided for them, and will be carefully protected from dirt or other foreign substance.

45. FILLING RECOIL CYLINDERS WITH LIQUID.

a. The two recoil cylinders are filled separately, the method being identical for each cylinder.

b. Elevate the howitzer 1 or 2 degrees.

c. Open the filling plug opening door of the cradle and remove the filling plug (fig. 119) with the filling pug wrench provided for this purpose. Also remove the filling plug in the front end of the recoil piston rod.

d. Place the tube of the funnel through the filling plug opening door into the filling hole of the recoil cylinder. Pour the filtered liquid into the funnel until it flows through the filling hole in the front end of the recoil piston rod (fig. 120). Allow all air to escape from the mechanism and install the filling plugs.

e. Depress the howitzer until the cradle is (level) in the horizontal position. Remove the front filling plug from the recoil piston rod, and

**HOWITZER, CARRIAGE, TRANSPORT WAGONS, CRANE,
AND CLAMSHELL TRAILER**

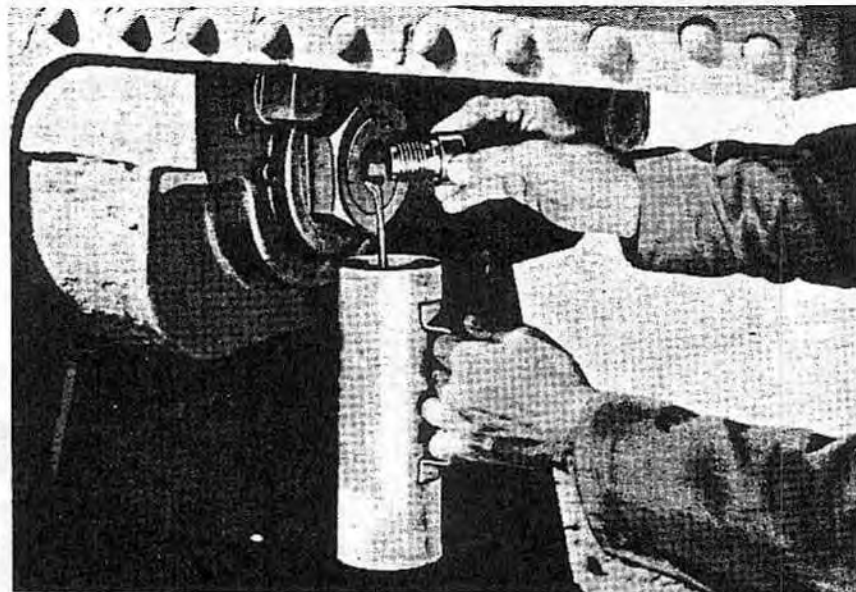

Figure 121 — Draining Liquid From Recoil Cylinder for Void

drain from the cylinder 0.67 pint of liquid (fig. 121), after which install the filling plug. This should leave the proper void to take care of the expansion of the liquid.

46. FILLING THE RECUPERATOR SYSTEM.

a. General.

(1) The recuperator system contains liquid and nitrogen under pressure. The composition of the liquid is described in paragraph 44. Commercial tubes charged with nitrogen at 2,000 pounds pressure per square inch are issued for establishing the required pressure in the recuperator reservoirs.

(2) The liquid should be drained from the system and the recuperator cylinder and reservoirs cleaned every 6 months or oftener if necessary by the ordnance maintenance company. If the action of the howitzer during recoil and counterrecoil indicates the necessity for draining and cleaning, the ordnance officer will be notified.

(3) The same pipes, valves, and connections are used for filling the recuperator system with liquid or nitrogen, except that when charging with nitrogen, the filling pipe is attached to the gas cylinder instead of the liquid pump.

b. Filling the Recuperator System With Liquid.

(1) Depress the howitzer until the cradle is (level) in the horizontal position.

240-MM HOWITZERS M1918MI AND M1918MIA1, 240-MM HOWITZER CARRIAGE M1918A2, AND TRANSPORT WAGONS M4 AND M5

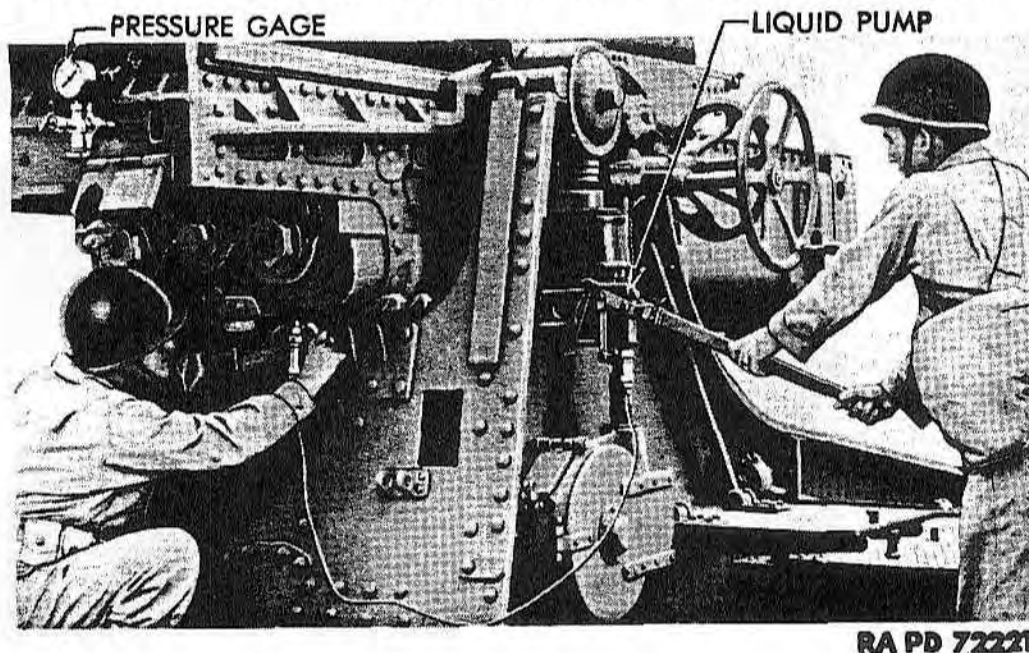

Figure 122 — Filling Recuperator System With Liquid

(2) Attach the liquid pump to the bracket located on the left side of the top carriage (fig. 122).

(3) Remove the valve body cap and attach the pressure gage adapter and pressure gage to the valve stem body, and set the pointer on the zero graduation of the left reservoir cap plate. Then remove the nozzle connection plugs.

(4) Attach one end of the filling pipe to the liquid pump and attach the other end of the pipe to the nozzle connection (fig. 122). Fill the liquid pump with liquid. Open the filling valve by loosening the filling valve spindle slowly with the wrench provided for this purpose.

(5) Pump the liquid into the cylinders with an even stroke (fig. 122). After pumping what is thought to be the required amount of liquid to fill the system to normal, close the filling valve by tightening the filling valve spindle.

(6) Open the valve directly under the pressure gage; then turn the adapter handle until it comes in contact with and opens the valve in the valve stem body (fig. 123). This will cause the liquid in the recuperator cylinders to escape past the adapter needle valve. If the liquid escaping has the consistency of a heavy mist, the recuperator has the required amount of liquid. If nothing but air escapes, it indicates that more liquid is required. If only liquid escapes, keep the valve open until it has the consistency of a heavy mist.

(7) The quantity of liquid in the recuperator system may be de-

HOWITZER, CARRIAGE, TRANSPORT WAGONS, CRANE,
AND CLAMSHELL TRAILER

RA PD 72222

Figure 123 – Checking Liquid Level in Recuperator Reservoir

terminated by means of the pointer and graduation of the left reservoir cap plate. To do this, open the adapter needle valve to allow liquid to escape and at the same time slowly move the pointer up and down until a position is found where the escaping liquid will have the consistency of a heavy mist. When this position is found, leave the pointer set and close the adapter needle valve. From the location of the pointer and the graduations, the quantity of liquid in the recuperator system may be determined.

(8) Remove the filling pipe from the nozzle connection and the liquid pump. Remove the liquid pump from the bracket on the top carriage.

(9) Remove the pressure gage and pressure gage adapter and install the valve body cap and nozzle connection plugs.

c. Testing Nitrogen Pressure in Recuperator System.

(1) When testing the nitrogen pressure in the recuperator system, the pressure gage and adapter are first assembled to the valve stem body with the adapter needle valve closed. Then the adapter handle is slowly screwed in until it comes in contact with and opens the valve in the valve stem body (fig. 124). This allows the pressure of nitrogen in the recuperator system to be registered by the pressure gage. Care must be exercised when taking nitrogen pressure to operate the adapter handle slowly in order that the pressure gage will not be strained by the sudden force of nitrogen applied to it. Also tap the gage with the fingers to be sure that the gage hand operates freely.

(2) The normal condition of the recuperator system is determined by the initial pressure and by the amount of the liquid contained

240-MM HOWITZERS M1918MI AND M1918MIA1, 240-MM HOWITZER CARRIAGE M1918A2, AND TRANSPORT WAGONS M4 AND M5

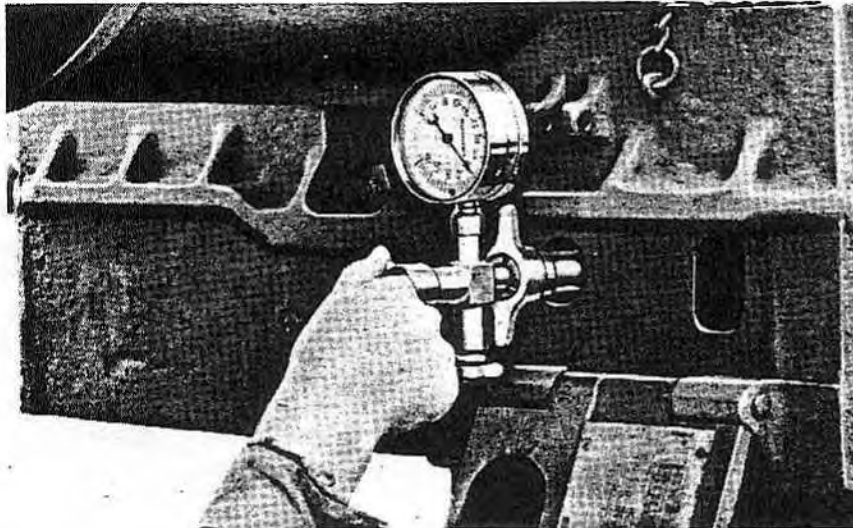

RA PD 72223

Figure 124 – Testing Nitrogen Pressure in Recuperator System

therein. At 15 C or 59 F, the initial pressure should be 576 pounds per square inch.

(3) Since a temperature variation of 7 C from normal will cause a variation of 1 kilogram per square centimeter (a change of 1.13 pounds per square inch per degree Fahrenheit) it will be seen that the change in temperature of the nitrogen in the reservoirs caused by a long firing period, or variations in temperature of the outside air, will cause a change in pressure which must be allowed for.

(4) A pressure table is fastened to the inside of the cap over the adapter valve, which should be consulted when regulating the pressure in the recuperator reservoirs. The table gives the maximum and minimum pressures and corresponding temperatures in both English and metric units. The pressure table and pressure gage are used as a check in the operation of the recuperator system before firing. The pressure as given in the table must be maintained at all times.

d. Filling the Recuperator System With Nitrogen.

(1) Remove the valve body cap and attach the pressure gage adapter and pressure gage to the valve stem body.

(2) Attach one end of the filling pipe in the nitrogen cylinder and the other end to the nozzle connection (fig. 125), making sure that all connections are tight; a little grease applied to the threads of the connections will act as a seal to prevent small leaks.

(3) Open the valve on the nitrogen cylinder; then open the filling valve slowly by turning the valve spindle (fig. 125). Allow the nitrogen to enter the system until the pressure gage registers a pressure

**HOWITZER, CARRIAGE, TRANSPORT WAGONS, CRANE,
AND CLAMSHELL TRAILER**

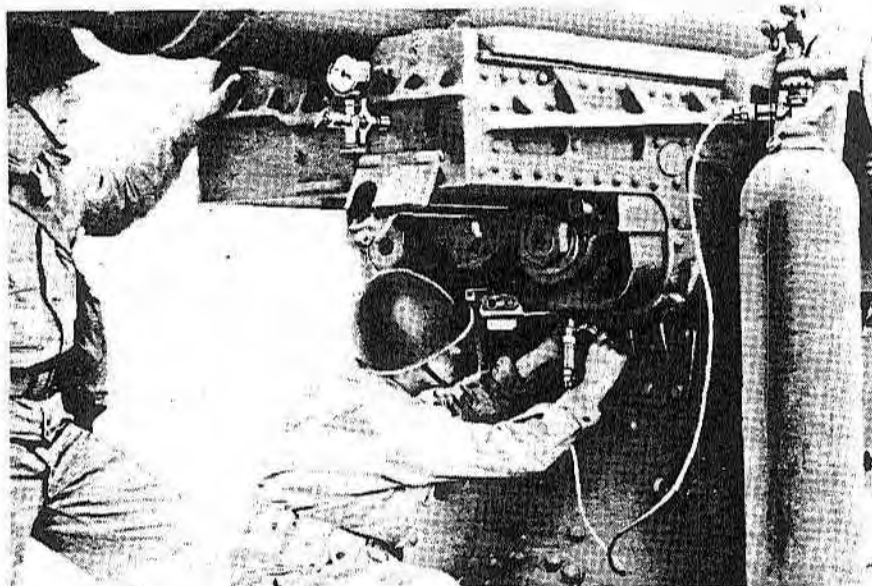

RA PD 72224

Figure 125 – Filling Recuperator System With Nitrogen

of 576 pounds per square inch at 70 F. Close the filling valve by turning the valve spindle, after closing the valve on the nitrogen cylinder.

(4) Remove the filling pipe from the nitrogen cylinder and the nozzle connection.

(5) Remove the pressure gage and pressure gage adapter, and install the valve body cap and nozzle connection plug.

e. Filling Recuperator System With the Air Pump.

(1) The air pump is to be used only in emergencies when nitrogen is not available, or when only a very small amount of air is needed to stabilize pressure in the recuperator system. The method employed is similar to that of using the liquid pump.

(2) Install the air pump in the bracket on the left side of the top carriage.

(3) Remove the valve body cap and attach the pressure gage adapter and pressure gage to the valve stem body. Remove the nozzle connection plug.

(4) Attach one end of the filling pipe to the air pump and the other end to the nozzle connection. Open the filling valve by turning the filling valve spindle with the wrench provided for that purpose.

(5) Pump air into the system with even strokes of the pump, until the pressure gage registers a pressure of 576 pounds per square inch. Close the filling valve by turning the filling valve spindle.

TM 9-340

46-47

240-MM HOWITZERS M1918MI AND M1918MIA1, 240-MM HOWITZER CARRIAGE M1918A2, AND TRANSPORT WAGONS M4 AND M5

(6) Remove the filling pipe from the air pump and the nozzle connection, and remove the air pump from the bracket on the top carriage.

(7) Remove the pressure gage and pressure gage adapter, and install the valve body cap and nozzle connection plugs.

47. CLEANERS, ABRASIVES, AND PRESERVATIVES.

a. The following cleaners and abrasives are prescribed for use with the 240-mm howitzer and carriage. See TM 9-850 for full information on these materials.

ALCOHOL, ethyl

BURLAP, jute, 8-oz (40 in. wide)

CLOTH

CLOTH, abrasive, aluminum-oxide

CLOTH, wiping

LIME, hydrated

PAPER, lens, tissue

PAPER, flint

REMOVER, paint and varnish

SOAP, castile

SOAP, liquid, lens cleaning

SODA ASH

SOLVENT, dry-cleaning

SPONGE

WASTE, cotton

b. The following lubricants and preservatives are used in the care and preservation of the 240-mm materiel. See TM 9-850 for full information on the use of these materials.

COMPOUND, rust-preventive, light, heavy, and thin film

GLYCERINE, U.S.P.

GREASE, general purpose, No. 1, and No. 0

GREASE, general purpose, No. 2

GREASE, graphite, light

OIL, castor, technical grade

OIL, engine, SAE 30, and SAE 10

OIL, lubricating, for aircraft instruments and machine guns

OIL, lubricating, preservative, special

OIL, neutral

**HOWITZER, CARRIAGE, TRANSPORT WAGONS, CRANE,
AND CLAMSHELL TRAILER**

48. PAINTS AND RELATED MATERIALS.

a. The following paints and related materials are required for the care and preservation of the 240-mm materiel. See TM 9-850 for full information on the use of these supplies.

ENAMEL, synthetic, gloss-black
ENAMEL, synthetic, gloss-red
ENAMEL, synthetic, lusterless, O.D.
ENAMEL, synthetic, stenciling, lusterless, blue-drab
LEAD, red, dry
LEAD, white, basic carbonate
VARNISH, shellac, orange

49. MISCELLANEOUS MATERIALS AND TOOLS.

a. The miscellaneous materials and tools listed below are required in the care and preservation of the 240-mm materiel. See TM 9-850 for full information on their use.

BRUSHES,

artist, camel's-hair, No. 1
flowing, skunk's-hair, No. 5 (2)
mottling, No. 1/2
paint, metal bound, flat (medium grade), No. 3 (4)
sash-tool, oval, No. 1 (2 7/32-by 1 3/4-in.)
sash-tool, oval, No. 3 (1 3/32-by 2 1/8-in.)
scratch, wire, painter's, curved back
varnish, oval, No. 4

CHALK, white, railroad

NEEDLES, sacking

PALM, sailmaker's

SODIUM HYDROXIDE, A.C.S. pellets

TWINE

50. TRANSPORT WAGONS.

a. **General.** The care and preservation of the Transport Wagons M4 and M5, includes proper cleaning, thorough periodic lubrication, tightening of loosened parts, proper care of the brake system, and care of the tires.

b. The transport wagons should be kept as clean as conditions will permit, and painted surfaces protected with proper paint. Unpainted surfaces must be kept free from rust.

240-MM HOWITZERS M1918MI AND M1918MIA1, 240-MM HOWITZER CARRIAGE M1918A2, AND TRANSPORT WAGONS M4 AND M5**c. Tires.**

(1) Whenever practicable, the tires should be kept covered from the direct rays of the sun.

(2) The air pressure should be maintained at 85 pounds. Check the pressure, before towing the wagons, at normal atmospheric temperature. Do not release air after the wagon has been towed and the tires are warm. Pressures will return to normal as the tires cool, when the wagon is stopped.

(3) Grease and oil will deteriorate the rubber tires. Keep them clean at all times by washing with soap and warm water.

(4) Cuts, abrasions, nail holes, etc., should be repaired as soon as possible. A cut through the tread or side wall rubber to the plies will allow water and dirt to enter, which will rot the cords and result in tire failure.

(5) Combat tires, when punctured, are to be repaired as soon as possible. The amount of travel that can be placed on a punctured tire is limited.

(6) Tires may be rotated to different positions on the wagons to allow them to wear evenly. Uneven tire wear may indicate bent spindles or bogie axles; report to ordnance maintenance personnel.

d. Care of Brake System.

(1) It is vitally important that sand, grit, and other foreign material be kept out of the air brake system. Immediately after detaching the air lines from the prime mover, attach them to the dummy couplings on the drawbar assembly.

(2) Keep all hose connections tight, and inspect periodically for air leaks in the system (par. 58). Ruptured or damaged air line hoses or damaged hose connections should be replaced with new parts, according to the following instructions:

(a) Cut the hose to the correct length, making sure that the ends are cut square.

(b) Assemble the spring and nut of the hose connector over the hose, and assemble the connector sleeve over the hose with its outer edge $\frac{3}{8}$ inch from the end of the hose.

(c) Force the end of the hose over the tube of the connector body. Join the body and the nut of the hose connector and draw the nut up to impress the castellated edges of the hose connector sleeve into the hose to make a tight joint. Avoid screwing the connector fittings too tight, as too much pressure will crush the hose connector sleeve and damage the fittings.

HOWITZER, CARRIAGE, TRANSPORT WAGONS, CRANE, AND CLAMSHELL TRAILER

(3) Open the drain cock at the bottom of the air brake emergency reserve tank daily to drain off accumulated moisture, as it affects the efficient operation of the brake system.

(4) See that air brake diaphragm pushrod travel is kept to a minimum, so that air consumption by the brakes is not excessive. This necessitates keeping the brakes properly adjusted at all times (par. 65).

(5) See that proper air pressure is in the reserve air tank before moving transport wagons.

e. **Care of Wheels and Hubs.** Wheels must be kept in proper alinement to avoid excessive tire wear. Instructions for adjusting the wheel bearings are given in paragraph 66. Bent wheels or wheel spindles will be reported to ordnance maintenance personnel.

f. **Electrical Equipment.** Keep electrical connections clean and tight. See that clamps securing wires to transport wagons are kept in place by the retaining screws.

g. **Locking Hooks, Clamps, and Locking Devices.** All mechanisms provided for locking the materiel in traveling position must be kept in good working condition.

Section IX

INSPECTION AND ADJUSTMENT

51. PURPOSE.

a. Inspection of the weapon is vital. Thorough, systematic inspection is the best insurance against an unexpected breakdown at the critical moment when maximum performance is absolutely necessary. Never let materiel run down. Keep it in first class fighting condition by vigilant inspection.

b. The purpose of inspection is to determine by critical examination, the condition of the materiel, the need of repairs and adjustments, and to insure its serviceability and proper functioning. The immediate aim of inspection is trouble prevention which includes:

(1) Detecting evidence of improper treatment received by materiel before delivery to the using arms.

(2) Detecting faulty or careless operation and care.

(3) Determining when replacement of parts is necessary due to ordinary wear, breakage, or defective parts.

240-MM HOWITZERS M1918MI AND M1918MIA1, 240-MM HOWITZER CARRIAGE M1918A2, AND TRANSPORT WAGONS M4 AND M5

52. GENERAL.

a. Inspection should always be accompanied by corrective measures to remedy any deficiencies or defects found. When properly carried out, inspection and necessary corrective maintenance will insure the maximum rehabilitation and performance of the materiel.

b. The results of inspections should be noted in the Artillery Gun Book (O.O. Form 5825) by the inspector. Any unusual condition which might result in improper operation, damage to materiel, or injury to personnel, will be remedied immediately.

c. Suggestions for improvement in design, maintenance, safety, and efficiency of operation prompted by chronic failure or malfunction of the weapon, spare parts or equipment, should be forwarded to the Office, Chief of Ordnance, Field Service Division, Maintenance Branch.

53. INSPECTION ON RECEIPT OF MATERIEL AND SPARE PARTS.

a. Upon receipt of materiel, it is the responsibility of the officer in charge to ascertain that the materiel is complete and in sound operating condition. A record should be made of any missing parts and any malfunction, and the condition should be corrected as quickly as possible.

54. INSPECTION OF THE HOWITZER.

a. In the inspection of the materiel, the following general points will be carefully noted:

(1) **ARTILLERY GUN BOOK (O.O. FORM 5825).** At each inspection the inspector will examine the gun book to make sure that this record has been kept up to date and that all entries have been properly made. The gun book record will also serve to inform the inspector as to the number of rounds fired, maintenance, seasonal change of lubrication, and the completed Modification Work Orders.

(2) **LUBRICATION.** Lubricating fittings should be properly identified with a red circle. Bearing and sliding surfaces, hinge joints, latches, and other movable parts should be clean, free from rust and other foreign matter, and well lubricated. Proper seasonal lubricants should be used and materiel should be lubricated at proper intervals in accordance with W.D. Lubrication Orders Nos. 145 and 145A. Excess oil and grease should be wiped off. No dirt or other abrasives should be in lubricants.

**HOWITZER, CARRIAGE, TRANSPORT WAGONS, CRANE,
AND CLAMSHELL TRAILER**

(3) **NAME PLATES.** Lettering on name plates and direction plates should be legible.

(4) **SAFETY FEATURES.** The firing mechanism block latch assembly on the breechblock carrier and the locking hooks and links on the cradle and carriage and transport wagons should be inspected for functioning.

(5) **OPERATING MECHANISMS.** All operating mechanisms are to be inspected for ease of operation, backlash, and proper lubrication.

(6) **PAINTING.** If paint has deteriorated or become damaged, leaving exposed portions of bare metal, the materiel should be repainted.

(7) Inspect covers for weapon and fire control equipment.

(8) **EQUIPMENT.** Accessories, tools, spare parts, and equipment should be inspected for completeness and serviceability.

(9) **EXERCISING.** Ascertain when the weapon was last exercised if not fired recently.

**Parts To Be Inspected
in Order of Inspection**

The howitzer as a unit.

Points To Observe

Note the general appearance of the weapon. Test the smoothness of operation of the breech mechanism for both opening and closing. Test the firing mechanism by firing two primers. Disassemble the breech mechanism (par. 77). Clean all parts thoroughly and inspect for wear or damage. Replace all parts found unfit for further service. See item on breechblock carrier assembly. Note general appearance of the howitzer bore for wear and deformation of the lands and grooves, pitting and pastilles; examine for evidence of powder fouling and rust. Do not confuse coppering of the bore with powder fouling. A clean bore is not necessarily a shiny bore, and may frequently have a dull gray appearance. A shiny polished bore may indicate that abrasives have been used. If such conditions are found, notify ordnance maintenance personnel.

240-MM HOWITZERS M1918MI AND M1918MIA1, 240-MM HOWITZER CARRIAGE M1918A2, AND TRANSPORT WAGONS M4 AND M5

Parts To Be Inspected in Order of Inspection	Points To Observe
Breech recess and breechblock.	Check for scores, burs, or bruises on the threads of the breech recess and breechblock. Note the condition of the gear teeth that engage the rack. Examine the bore of the breechblock for rust or other defects.
Breechblock carrier assembly.	Examine the pintle in the center of the carrier for burs or bruises. Note whether the firing mechanism housing is free from scratches. Check the gear teeth of the rack for burs or indentations, and the rack lock and spring for rust or gummy deposits. If the rack lock spring is weak, replace it with a new one. Examine the parts of the operating lever and check for rust and burs or bruises.
Obturator assembly.	Check for erosion of the venthole and primer chamber. Examine the obturator spindle for burs or bruises on the threaded portion and see that the mushroom head is free from rust and scratches. Look for bruised split rings or filling in disk, damaged gas-check pad, and broken or weak obturator spring. Replace worn, damaged, or broken parts.
Firing mechanism.	Disassemble and clean the parts of the firing mechanism (pars. 75 and 76). Examine the threaded portion of the block for scores or bruises. Note the condition of the firing pin and firing pin spring. Replace bent or damaged firing pin, or a weak or broken firing pin spring. After assembling the firing mechanism, check the action of the spring and test the primer holder by inserting a primer and noting the ease with which it is inserted and withdrawn.

**HOWITZER, CARRIAGE, TRANSPORT WAGONS, CRANE,
AND CLAMSHELL TRAILER**

Parts To Be Inspected in Order of Inspection	Points To Observe
Percussion mechanism.	Check for smoothness of operation. Note whether the safety lug on the percussion hammer makes proper contact with the rim of the firing mechanism and that it is not bruised or worn beyond the limit of safety. See that the rounded portion of the percussion hammer strikes the firing pin of the firing mechanism when the percussion mechanism is operated. Check the action of the percussion hammer lock bolt to see that it holds the percussion hammer securely in the traveling position.

55. INSPECTION OF CARRIAGE.

a. Observe general condition of the carriage as a whole. All exposed parts should be clean and well lubricated. Pay particular attention to condition of paint and general state of preservation. Examine condition of welds, rivets, plates, and bolts for breaks, cracks, loose, broken, or missing parts. Drain holes should be clean and unobstructed. All set screws and cotter pins should be in place. Exposed gear and bearing surfaces must be clean, free from rust, and properly lubricated. Rack teeth must not be burred or chipped. All parts must be properly adjusted and tightened. Hinges, latches, pins, and other moving parts must be properly lubricated and free from rust.

b. Inspection of the Various Units of the Carriage.

Parts To Be Inspected in Order of Inspection	Points To Observe
Sleigh and recoil mechanism.	Check to see that the howitzer is securely locked to the sleigh to prevent longitudinal movement of the weapon in the sleigh. See that the level of liquid in the recoil cylinders and recuperator reservoirs is correct (pars. 45 and 56 b), and that the nitrogen pressure in the recuperator system is 576 pounds per square inch at 70 F (par. 46 c). Check for oil leakage at the front and rear packings of the recoil and recuperator cylinders and

240-MM HOWITZERS M1918MI AND M1918MIA1, 240-MM HOWITZER CARRIAGE M1918A2, AND TRANSPORT WAGONS M4 AND M5

Parts To Be Inspected in Order of Inspection	Points To Observe
Cradle.	<p>the front of the recuperator reservoirs. Slight leaks which occur during firing or when the weapon is inactive are not serious and do not necessarily indicate loose packings. Excessive leakage of liquid will be reported to the ordnance maintenance personnel. See that the venthole in the recuperator cylinder rear head is open.</p> <p>Examine the surface of the cradle recoil slide guides to see that they are clean and free from scratches or bruises and that they are receiving proper lubrication. Check the piston rod beam to see that it is securely locked in place. Test the action of the firing gear at the left side of the cradle.</p>
Elevating mechanism.	<p>Elevate and depress the howitzer throughout the full range of elevation. Note whether the mechanism operates smoothly without binding or excessive backlash. Examine the arcs and pinions for excessive wear, burs, or bruises. See that the handwheel is securely fastened to the shaft.</p>
Friction clutch.	<p>Test the action of the friction clutch in the elevating mechanism; there should be sufficient slippage to relieve strain on the elevating arcs during firing or maneuvering. However, the disks should be so adjusted (par. 62) that the howitzer does not elevate more than 4 degrees when fired.</p>
Quick-loading mechanism.	<p>Check the elevating lock lever and the quick-loading gear operating lever for proper functioning. Note whether the roller chain has excessive slack and adjust if necessary (par. 63).</p>
Traversing mechanism.	<p>Traverse the howitzer throughout full range and note smoothness of operation. See that all parts are well lubri-</p>

HOWITZER, CARRIAGE, TRANSPORT WAGONS, CRANE, AND CLAMSHELL TRAILER

Parts To Be Inspected in Order of Inspection

Points To Observe

Traversing rollers.	<p>cated and that mechanism operates without binding or excessive backlash. Note the condition of the teeth of the traversing rack and check for burrs or bruises and dirt or other foreign material in the rack segment.</p> <p>Note whether mechanisms operate smoothly and that proper clearance exists between the top carriage and rear holding-down sector. A clearance of 0.08 inch should be maintained between these parts. Adjust if necessary (par. 64 b).</p>
Main pintle.	<p>Check the main pintle assembly for proper clearance between the top carriage bottom plate and the outer raised surface of the pintle socket plate. A clearance of 0.08 inch should be maintained between these parts. Adjust if necessary (par. 64 c).</p>
Trunnion assemblies.	<p>Check the effort required to elevate howitzer when loaded and unloaded. Excessive effort indicates that the trunnion bearings are not correctly adjusted (par. 61).</p>
Footboards.	<p>Examine all locking levers to see that they are in working order.</p>
Platform.	<p>See that the drain holes in the trunk section of the platform are open.</p>

56. SIGHTING EQUIPMENT.

a. **General.** It is most important in the inspection of sighting equipment to check for completeness. Any missing parts should be noted and action be initiated for immediate replacement. Note any evidence of improper handling or usage. Instruments which indicate incorrectly, or do not function properly after authorized tests (par. 84 f) are to be reported to ordnance maintenance personnel.

b. Inspect instruments for security on carriage and alinement with gun bore. Handwheels and knobs should be inspected for ease of operation, and be free from binding and backlash. Clamp and wing

240-MM HOWITZERS M1918MI AND M1918MIA1, 240-MM HOWITZER CARRIAGE M1918A2, AND TRANSPORT WAGONS M4 AND M5

nuts should be serviceable. Scales should be legible. Inspect for adjustment of telescope mount and serviceability of level vials. Optical instruments should be free from parallax. Field of view should be clear and sharp. Note condition of eyeshields, covering caps and filters.

c. Inspect optical elements. Look through the instrument to detect evidences of chipping, fungus, separation, or dirt on lenses or prisms.

d. Inspect instrument cases and accessories for condition and serviceability.

57. INSPECTION OF TRANSPORT WAGONS.

a. **General.** Note general appearance of transport wagons and whether they are painted in accordance with regulations. See that lubrication fittings are painted red, that they are clean and functioning properly. Note whether drawbar assembly is properly attached to the axle, and that the drawbar bolts are not excessively worn. Test the hand brake levers as well as the action of the air brake system. See that electrical connections are clean and tight, and that wire connections are in good condition. Test the blackout tail lights.

b. Units To Be Checked When Inspecting Transport Wagons.

Parts To Be Inspected in Order of Inspection	Points To Observe
Drawbar assembly.	Note condition of the lunette to see that it is not excessively worn, and that it is properly attached. Check the drawbar bolts for excessive wear and proper lubrication. See that the dummy hose couplings are securely fastened to the drawbar assembly.
Front axle.	Note whether axle turns and oscillates freely at end of frame without binding. Check for proper lubrication.
Frame.	Note general appearance of frames and check for breaks or cracks. On the cannon transport wagon, see that the bolts retaining the cradle support in place are tight.
Rear axle.	See that the nuts on the U-bolts securing axle to the frame are tight.
Locking devices.	Note condition of locking hook and clamp assemblies and all other apparatus provided for locking materiel in traveling position. See that nuts are tight and cotter pins installed wherever required.

**HOWITZER, CARRIAGE, TRANSPORT WAGONS, CRANE,
AND CLAMSHELL TRAILER**

**Parts To Be Inspected
in Order of Inspection**

Points To Observe

Electrical equipment.

Look for burrs or bruises on threaded portions of screws. See that all locking devices are properly adjusted (par. 67). Defective parts should be reported to ordnance maintenance personnel.

Check to see that all electrical connections are clean and tight and that connecting wires are in good condition. Test the blackout tail lights and see that the lenses are clean. Check the retaining screws for the clamps which secure wires to transport wagons to see that they are all in place and tight. Note condition of plugs and wire sockets to see that they are clean and make proper connection. Check the condition of the jumper cable.

58. BRAKE MECHANISM.

a. **General.** Inspection of the brake mechanism includes checking the general condition of all parts, and testing the various units for proper functioning and for leakage of air in the system. Supporting brackets must be securely retained in position. The hand brake mechanism must be checked as well as the air system.

b. Procedure for Inspecting Brake Mechanism.

**Parts To Be Inspected
in Order of Inspection**

Points To Observe

Brake linings.

Note the condition of the linings by observing them from the inner side of the wheels. Check for proper clearance between the lining and the drum by inserting a thickness gage from the inner side of the wheel.

Air lines and fittings.

Examine the air line hose and fittings to see that they are in good condition. Test for leakage by applying soapsuds to the hose and hose connections and watching for bubbles to form when pressure is built up in the air system. See that all connections are clean. Check couplings and the dummy couplings on the drawbar.

**240-MM HOWITZERS M1918MI AND M1918MIA1, 240-MM HOWITZER
CARRIAGE M1918A2, AND TRANSPORT WAGONS M4 AND M5**

**Parts To Be Inspected
in Order of Inspection**

Points To Observe

Relay-emergency valve.

Test the application-release portion for leakage by charging the transport wagon emergency reserve tank and applying soapsuds to the exhaust port; if there is air leakage with the brakes released, the intake valve is not seating properly; if air leaks with the brakes applied, the relay valve diaphragm is fractured or is not seating properly. With the air tank charged, disconnect the emergency hose between the prime mover and the transport wagon; the transport wagon brakes should apply immediately if the emergency portion is functioning properly. Apply soapsuds to the emergency hose coupling that has been disconnected to determine whether the emergency valve is seating properly. If the leakage on any of the above tests causes the formation of a bubble of greater diameter than 3 inches in 3 seconds, or if the transport wagon brakes fail to apply automatically when the emergency is disconnected, a report will be made to the ordnance maintenance personnel.

Air brake diaphragms.

Apply the brakes and test for leakage by applying soapsuds around the outer edge and also around the clamping bolts of the air brake diaphragm. Measure the distance the push rods travel when the brakes are applied; the recommended maximum stroke when brakes are properly adjusted is $\frac{3}{4}$ inch. If the maximum stroke exceeds $1\frac{3}{4}$ inch, the brakes should be readjusted.

Air tank.

Open the drain cock at the bottom of the air brake emergency reserve tank to release any condensation of moisture in the tank.

Air filters.

The strainer (fig. 126) in the air filters should be removed after dismounting

HOWITZER, CARRIAGE, TRANSPORT WAGONS, CRANE,
AND CLAMSHELL TRAILER

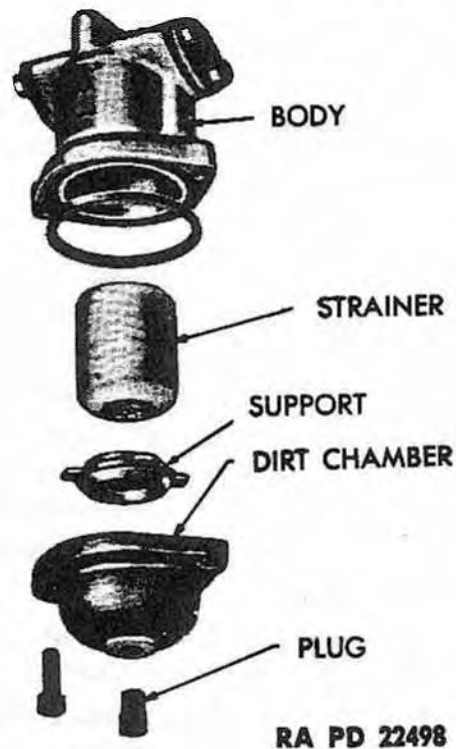

Figure No. 126—Air Filter,
—Exploded View

Parts To Be Inspected
in Order of Inspection

Hand brakes.

59. WHEELS, HUBS, AND TIRES.

a. General. Inspection of the wheels, hubs, and tires includes checking the wheels for proper alinement and wheel bearing adjust-

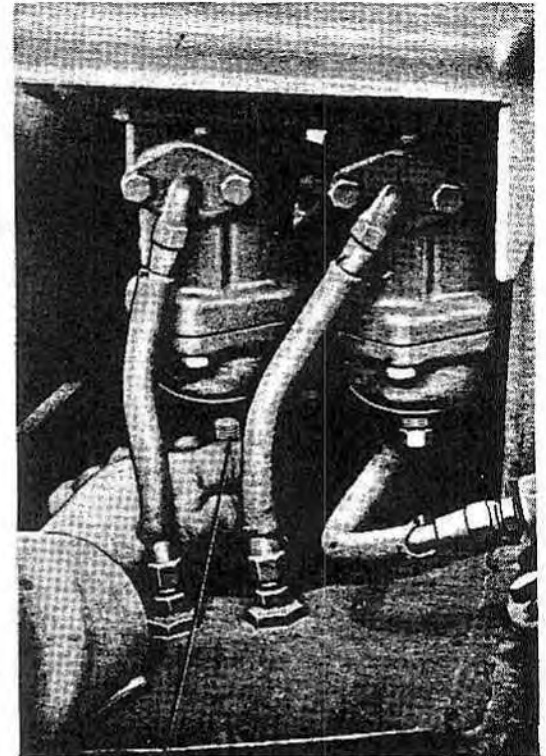

Figure No. 127—Draining
Air Filter

Points To Observe

the dirt chamber, and cleaned periodically in order to prevent dust particles from entering the system. The drain plugs in the air filters should be removed frequently to release any condensation of moisture (fig. 127).

Apply the hand brakes and observe whether the mechanism works properly to make contact between the brake lining and the drum. See that the levers operate without excessive effort, and that the latches engage the racks to hold the brakes in the on position. Adjust brakes if necessary (par. 65).

240-MM HOWITZERS M1918MI AND M1918MIA1, 240-MM HOWITZER CARRIAGE M1918A2, AND TRANSPORT WAGONS M4 AND M5

ment, checking for proper lubrication of the wheel bearings, careful examination of the tires for excessive wear, and cleaning foreign substances from the tires. Note that all retaining nuts are in place and tight.

b. Procedure for Inspection.

Parts To Be Inspected in Order of Inspection	Points To Observe
Wheels.	Note whether wheels are clean and painted according to regulations. Check for bent or damaged wheels or rims. See that all nuts retaining wheels to hubs are in place and tight; left wheels have nuts with left-hand threads. Bent or damaged wheels should be replaced.
Hubs.	Remove the eight cap screws and lock washers that secure the hub cap and remove the hub cap and gasket, being careful not to damage the gasket. Check to see that the wheel bearings are lubricated. Examine the inner ends of the hubs to determine whether lubricant is passing the seals at the inner ends of the hubs. Jack up wheels and test bearing adjustment. Adjust bearings if necessary (par. 66).
Tires.	Note condition of tires and check for proper inflation: a pressure of 85 - pounds should be maintained in all tires. This is especially important before traveling. Clean small stones or gravel from the treads and remove any accumulation of grease or road oil from the surface of the tires.

60. ADJUSTMENT OF FIRING MECHANISM.

a. Proper adjustment of the primer holder is necessary to prevent excessive rebound of the firing mechanism when the weapon is fired. If the primer holder is screwed too far into the firing mechanism block, allowing the handle of the firing mechanism block to go too far past the firing mechanism block latch, the primer may be forced so far into the obturator spindle plug that the forward end of the primer may be crimped. The blowback that results is liable to cause the

HOWITZER, CARRIAGE, TRANSPORT WAGONS, CRANE,
AND CLAMSHELL TRAILER

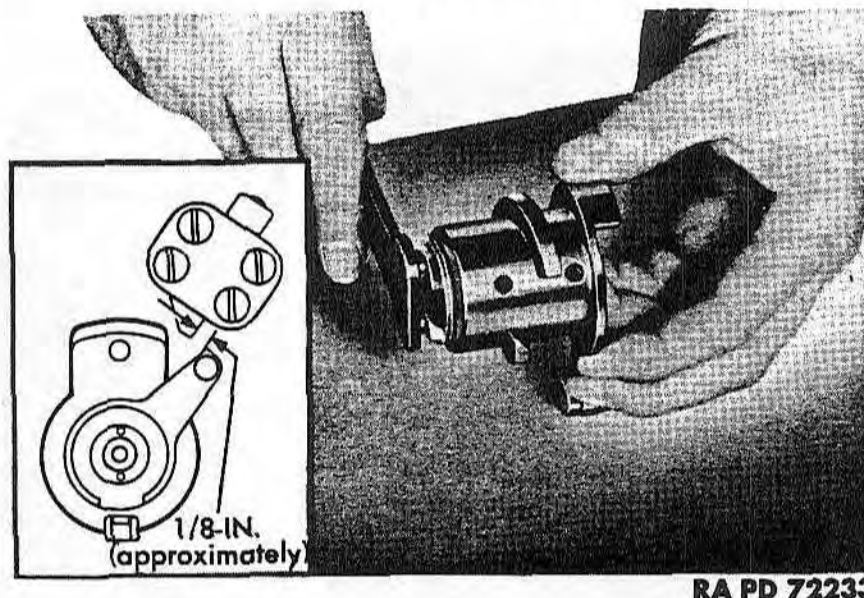

RA PD 72233

Figure 128 — Adjusting Firing Mechanism Primer Holder

firing mechanism to unscrew out of position, forcing the block handle back against the block latch with sufficient force to bend or break the handle. To prevent such a condition, the primer holder should be adjusted in or out of the firing mechanism block as required to permit the handle of the firing mechanism block to move approximately $\frac{1}{8}$ inch past the firing mechanism block latch when the firing mechanism is screwed as far as possible in the firing mechanism housing (fig. 128).

61. ADJUSTMENT OF TRUNNION SPRINGS.

a. When the howitzer is fired, the trunnions should contact the main trunnion bearings. At other times, the auxiliary roller bearings should support the cradle and weapon assembly. This condition is insured by proper adjustment of the trunnion bearing springs.

b. To adjust the Belleville springs, first remove the lock screw with a screwdriver; then turn the roller race adjusting screw at the lower end of the trunnion bearing assembly so that the howitzer may be easily elevated or depressed by the quick-loading handwheel (fig. 129). A $1\frac{5}{8}$ -inch wrench will be required to turn the adjusting screw. When proper adjustment has been made, install the lock screw, screwing it in tight with a screwdriver.

62. ADJUSTMENT OF FRICTION CLUTCH.

a. The friction clutch in the elevating mechanism should have sufficient slippage to relieve strain on the elevating arc during firing

240-MM HOWITZERS M1918MI AND M1918MIA1, 240-MM HOWITZER
CARRIAGE M1918A2, AND TRANSPORT WAGONS M4 AND M5

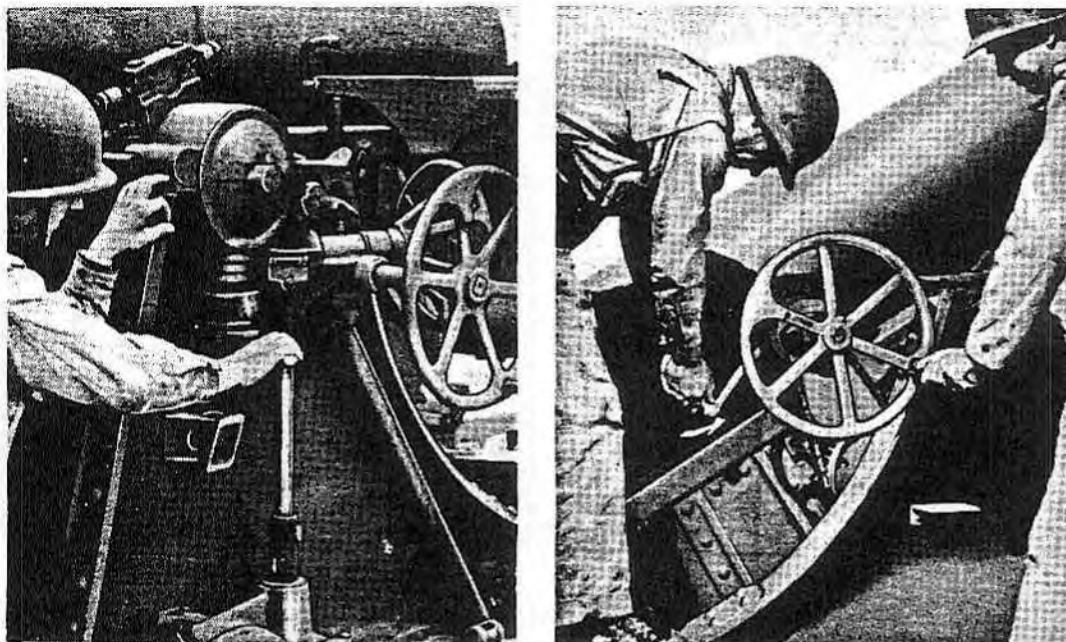

Figure 129 — Adjusting Trunnion Bearing Springs

or maneuvering. However, the disks should be so adjusted that the howitzer does not elevate more than 4 degrees when fired.

b. To make the correct adjustment, proceed as follows:

(1) Elevate or depress the howitzer with the elevating handwheel as far as possible.

(2) Open the elevating gear case cover after removing the gear case cover lock pin, and remove the cotter pin from the tension screw nut.

(3) Turn the tension screw nut using the friction nut wrench to compress the Belleville spring, until the effort of a strong man on the elevating handwheel will just cause the disks to slip (fig. 130).

(4) After making this adjustment, elevate and depress the weapon rapidly, making sudden stops from time to time. No shifting should occur under this operating condition.

(5) Install cotter pin in the tension adjusting screw nut, close the gear case cover, and install the gear case cover lock pin.

63. ADJUSTMENT OF QUICK-LOADING MECHANISM ROLLER CHAIN.

a. Excessive slack in the roller chain of the quick-loading mechanism may be eliminated by turning the bushing in the gear shaft bracket.

**HOWITZER, CARRIAGE, TRANSPORT WAGONS, CRANE,
AND CLAMSHELL TRAILER**

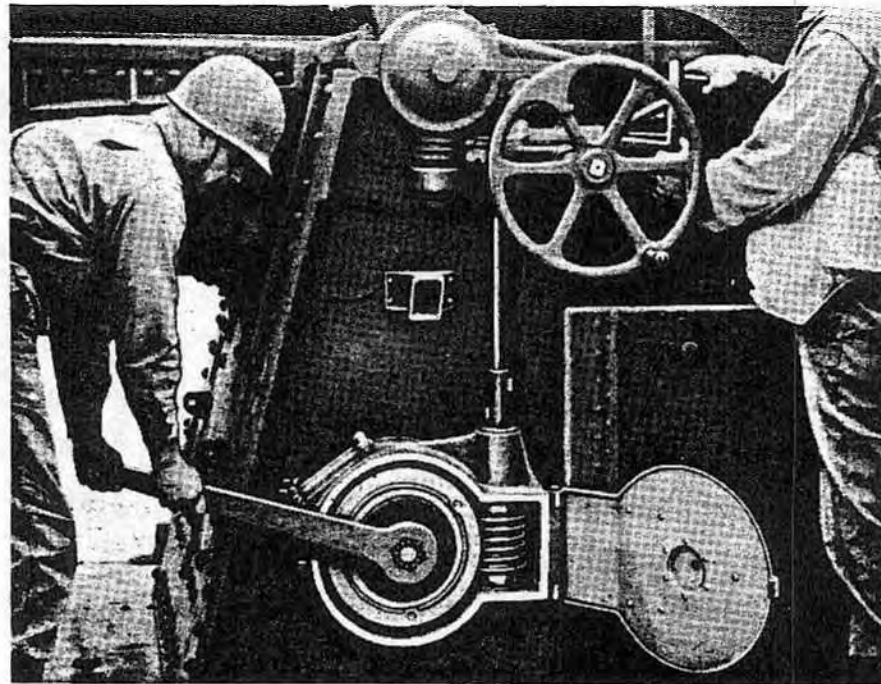

RA PD 72235

Figure 130 — Adjusting Friction Clutch

b. First, remove the quick-loading gear shaft bracket bushing securing key from the handwheel shaft, and remove the nut from the end of the shaft, using $1\frac{7}{16}$ -inch wrench. Pull the handwheel shaft and gear shaft bracket bushing out (tapping the shaft with a wood block or hide-faced hammer if necessary) until the bushing is removed from its slots (fig. 131). Then turn the bushing until nearly all the slack in the roller chain is removed, and insert it in the correct slots to hold it in the desired position. Care must be exercised to remove just enough slack to maintain ease of operation.

c. When correct adjustment of the chain has been established, move the handwheel shaft into position with the shoulder of the shaft against the face of the bushing. Install the nut on the handwheel shaft and the bushing retaining key.

64. ADJUSTMENT OF TRAVERSING ROLLER AND PINTLE.

a. These adjustments are made with the howitzer and cradle in position on the top carriage, and must provide for the same clearance at both front and rear of the top carriage. The correct amount of clearance is 0.08 inch. With the proper adjustment, the top carriage, cradle, and howitzer are supported at three points when the weapon is maneuvered, and when it is fired, the top carriage is forced down so that it bears on the holding-down sector at the rear and the pintle socket plate at the front.

240-MM HOWITZERS M1918MI AND M1918MIA1, 240-MM HOWITZER
CARRIAGE M1918A2, AND TRANSPORT WAGONS M4 AND M5

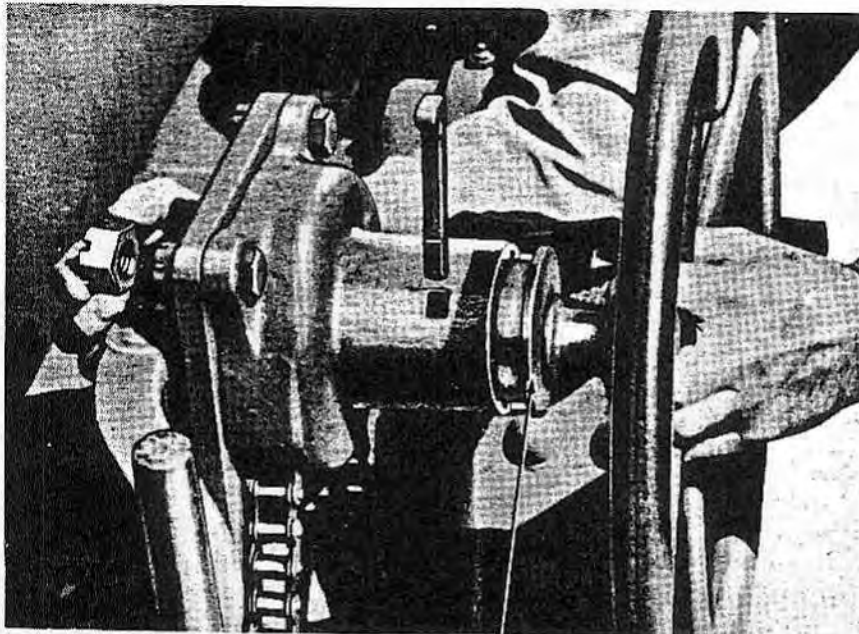

QUICK-LOADING GEAR
SHAFT BRACKET BUSHING—

RA PD 72236

Figure 131 – Adjusting Roller Chain in Quick-loading Mechanism

b. Adjust the traversing roller assemblies. Both traversing roller assemblies are adjusted in the same manner.

(1) Remove the traversing roller spring retainer locking screw with a screwdriver (fig. 132).

(2) Turn the retainer (fig. 132) one way or the other until an 0.08-inch thickness gage may be inserted between the top carriage and the rear holding-down sector (fig. 132). A special end wrench ($3\frac{3}{8}$ -inch opening) will be required to turn the retainer, or if a wrench is not available it may be turned with a brass drift and hammer.

(3) With the adjustment completed, install the retainer lock screw, turning it in tight.

c. Pintle Adjustment.

(1) Remove the cotter pin from the pintle head nut and loosen the pintle head nut, using a $4\frac{1}{8}$ -inch wrench.

(2) Turn the pintle crown filler ring one way or the other to permit insertion of an 0.08-inch thickness gage between the top carriage bottom plate and the outer raised surface of the pintle socket plate (fig. 133). The pintle wrench is provided for turning the pintle crown filler ring.

(3) When the correct adjustment has been made, tighten the pintle head nut and install the cotter pin.

**HOWITZER, CARRIAGE, TRANSPORT WAGONS, CRANE,
AND CLAMSHELL TRAILER**

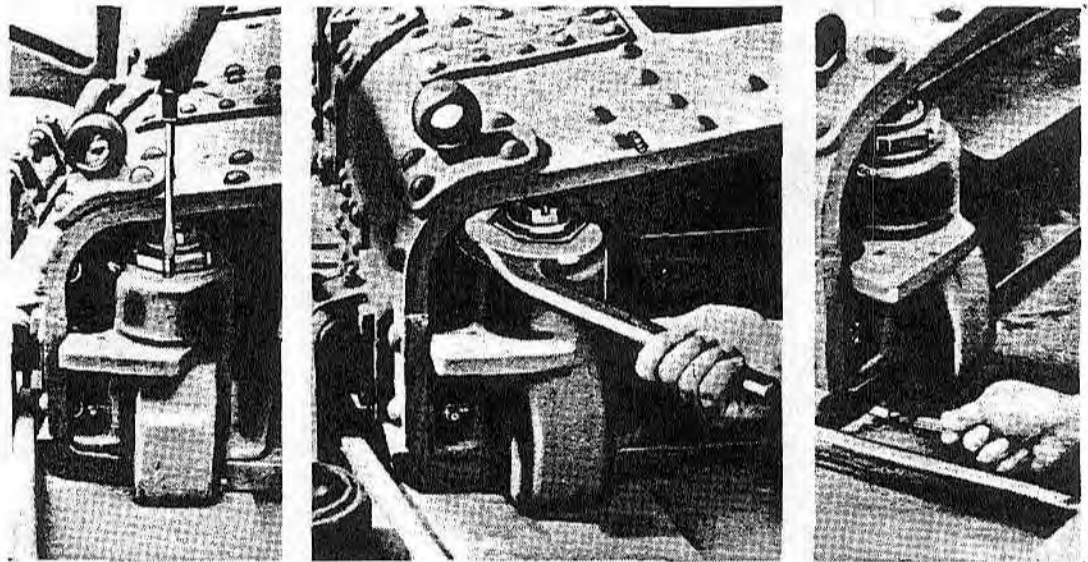

RA PD 72237

Figure 132 – Adjusting Traversing Roller Assembly

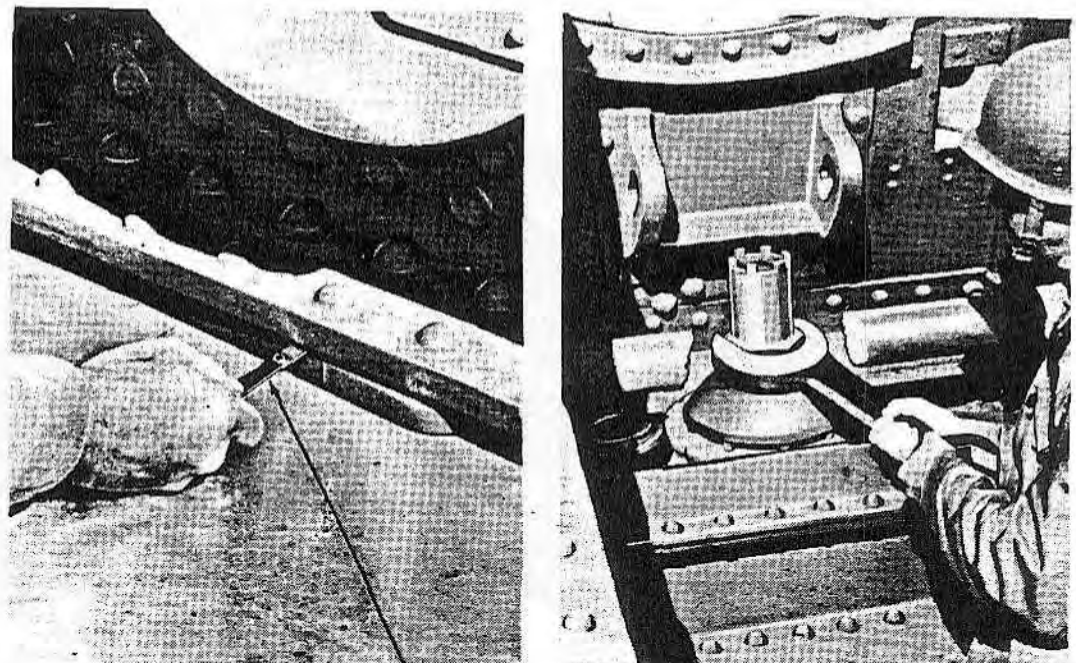

THICKNESS GAGE

RA PD 22500

Figure 133 – Adjusting Main Pintle

65. BRAKE ADJUSTMENT.

- a. Release the air brakes; release the hand brake for the brake to be adjusted, and apply the hand brake for the other brake.
- b. Place the jack under the transport wagon axle so it will raise only the wheel on which the brake is to be adjusted. Raise the axle far enough to permit the wheel and tire assembly to be rotated.

240-MM HOWITZERS M1918MI AND M1918MIAT, 240-MM HOWITZER
CARRIAGE M1918A2, AND TRANSPORT WAGONS M4 AND M5

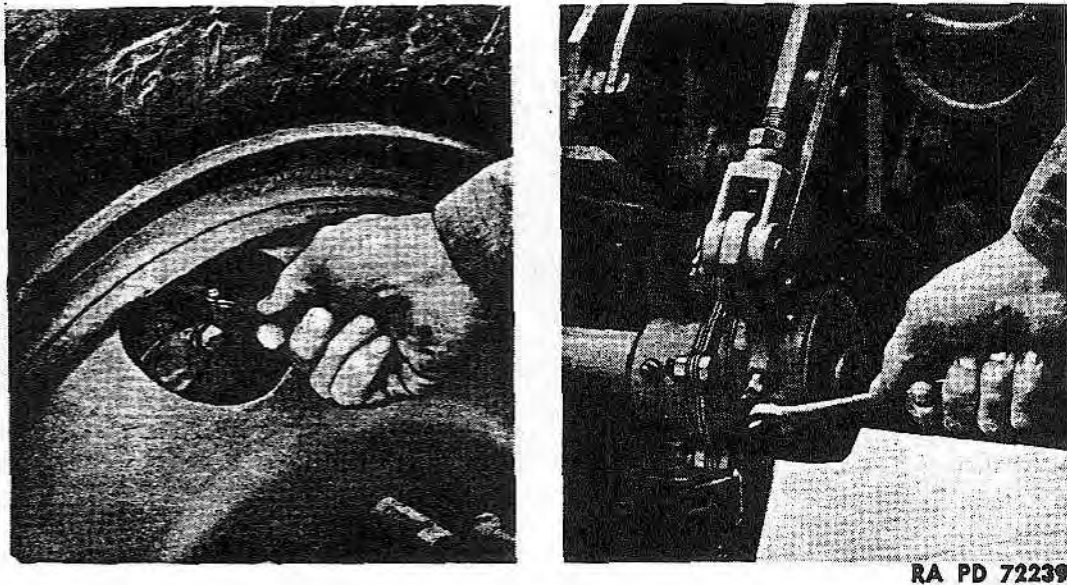

Figure 134 — Adjusting the Brakes

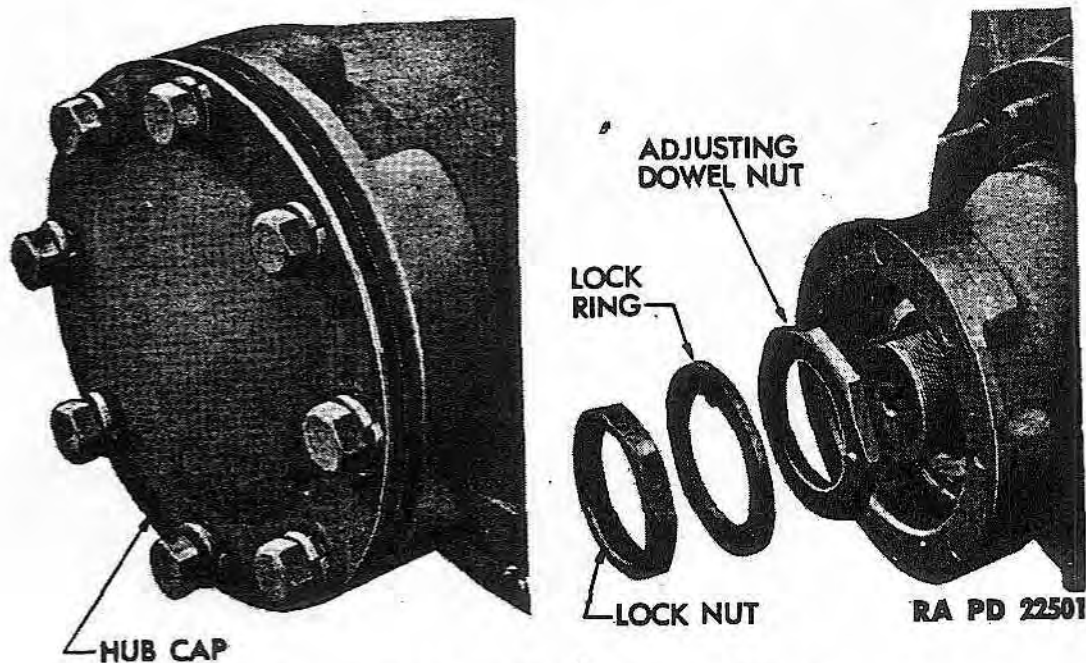

Figure 135 — Wheel Bearing Nuts

c. Turn the adjusting screw, which protrudes from the slack adjuster, in a clockwise direction until the wheel and tire assembly cannot be rotated. A 1/2-inch wrench will be required to turn the adjusting screw. Then back off the adjustment slightly, until the wheel and tire assembly may be rotated freely. With the brakes properly adjusted, there will be a clearance of 0.025 inch to 0.050 inch between the brake linings and the brake drum.

STORAGE, PACKING, AND SHIPMENT

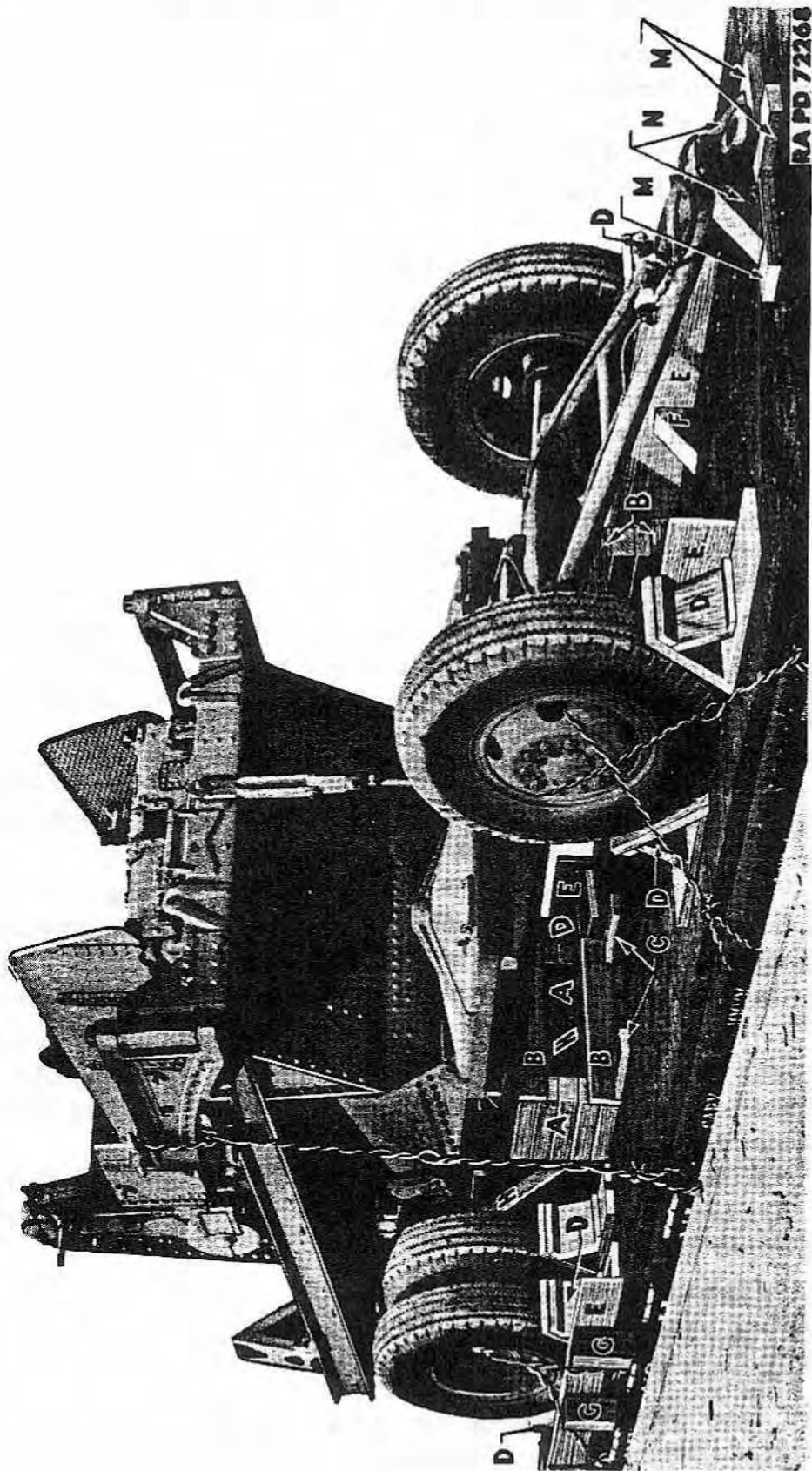

Figure 191 — Method of Blocking Transport Wagon M5, for Shipment by Rail

240-MM HOWITZERS M1918MI AND M1918MIA1, 240-MM HOWITZER CARRIAGE M1918A2, AND TRANSPORT WAGONS M4 AND M5

(7) **STAKES G (SIX STAKES G REQUIRED).** Six stakes G will be located in stake pockets of flat car, three against sideboard E at each rear wheel. If necessary, place wedges between stakes and stake pockets to keep stakes tight. Drive one 40-penny nail in each stake directly below stake pocket with head even with outside of stake pocket.

(8) **BRACES H (FOUR BRACES H REQUIRED).** Four braces H will be located against the rear axle, one at each side in front between axle and blocks A, and one at each side of center at rear. Each brace will be cut to fit snugly against the axle at one end and against the car floor at the other end. Nail to car floor with five 30-penny spikes driven from top side and two at one side. Toe-nail spikes at side.

(9) **SUPPORTS J (TWO SUPPORTS J REQUIRED).** Two supports J will be located at outer edges of rear braces H and nailed to braces H with five 20-penny nails and to car floor with five 20-penny nails.

(10) **CLEAT K (ONE CLEAT K REQUIRED).** Cleat K will be located across two rear braces H between rear axle and upper ends of supports J and nailed to braces H with five 16-penny nails at each end.

(11) **CLEATS L (TWO CLEATS L REQUIRED).** Two cleats L will be located one at end of each rear brace H, and nailed to car floor with sixteen 30-penny spikes.

(12) **BLOCKS M (THREE BLOCKS M REQUIRED).** Three blocks M will be placed one under the square portion of drawbar back of the lunette, and one at each side of the forward block M (fig. 191). Nail each of these blocks to car floor with six 30-penny spikes.

(13) **BLOCKS N (TWO BLOCKS N REQUIRED).** Two blocks N will be located one on each side of and against the square portion of the drawbar back of lunette, on top of side blocks M and nailed to blocks M and the car floor with five 30-penny spikes.

CAUTION: Do not place blocks N too snugly against drawbar, as the drawbar must be free enough for slight movement forward or back to prevent buckling.

(14) **STRAPPING.**

(a) The tool chest of transport wagon will be secured with metal banding ($\frac{3}{4}$ in., 0.025) (fig. 193).

(b) Eight strands of No. 8 gage black annealed wire will be located over the frame of transport wagon and through holes cut in car floor, and around beam of flat car. This wire goes under the rear of the tool chest (fig. 193).

STORAGE, PACKING, AND SHIPMENT

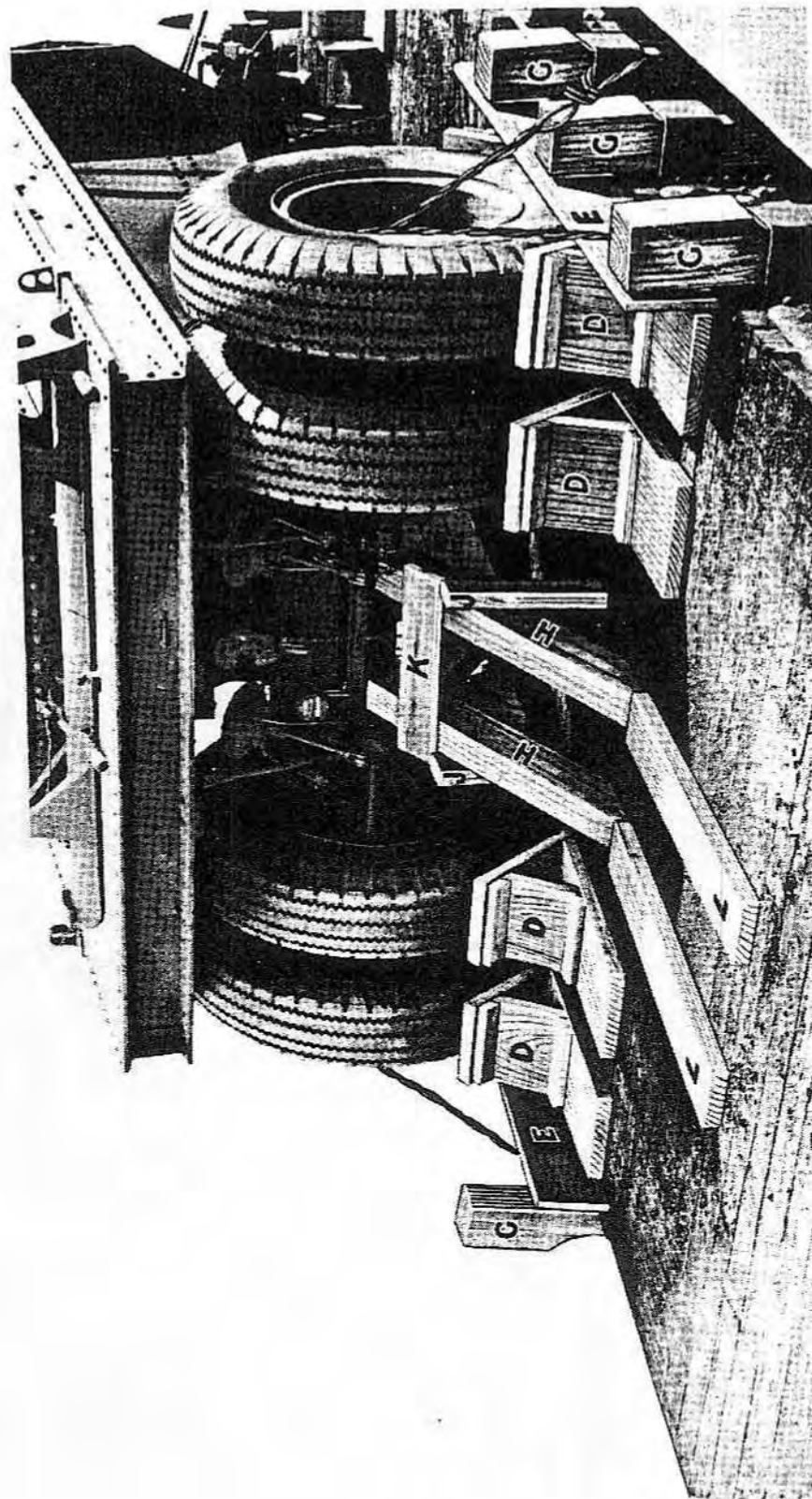

RA PD 72269

Figure 192 — Method of Blocking Rear End of Transport Wagons M4 and M5, for Shipment by Rail

240-MM HOWITZERS M1918MI AND M1918MIA1, 240-MM HOWITZER
CARRIAGE M1918A2, AND TRANSPORT WAGONS M4 AND M5

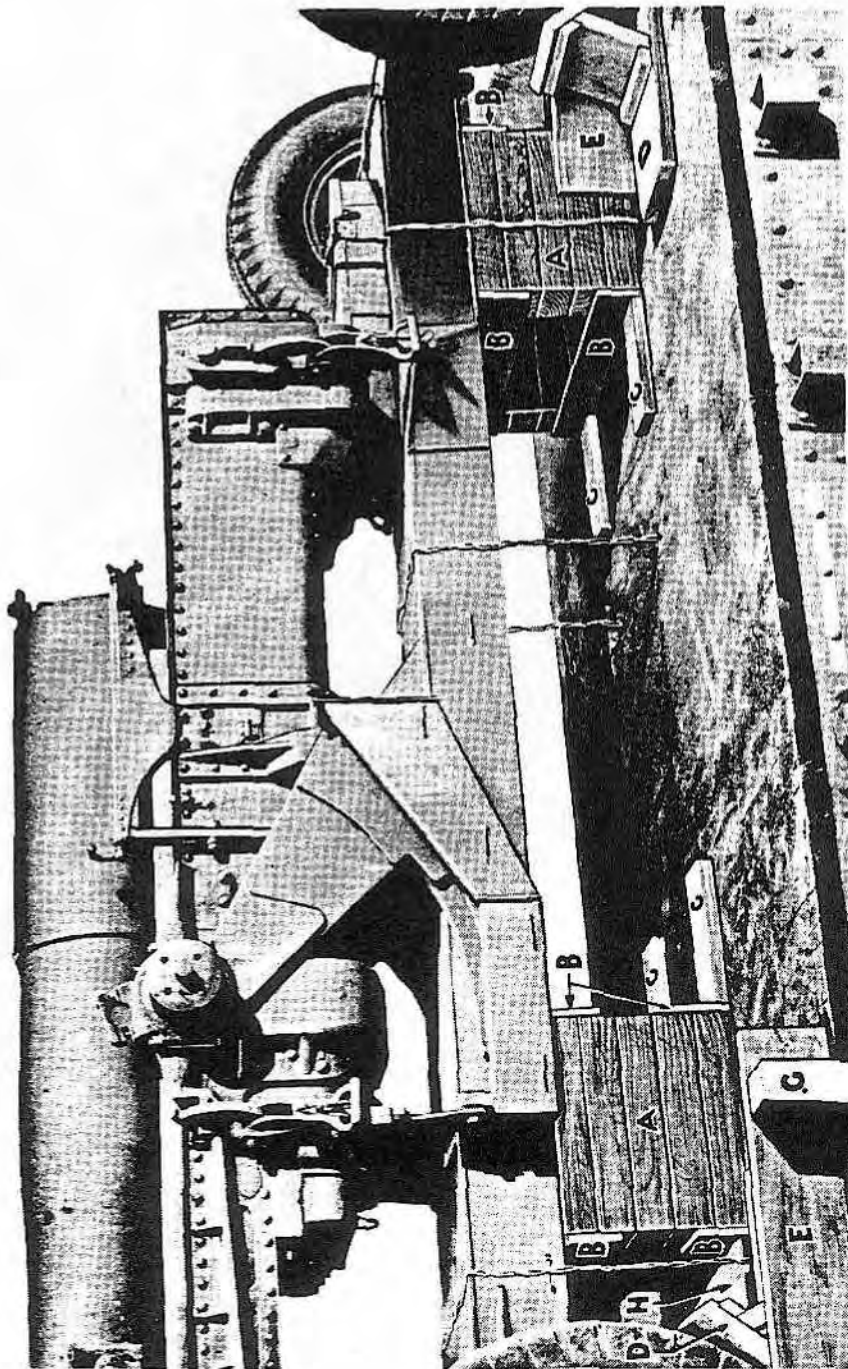

RA PD 72270

Figure 193 — Method of Strapping Transport Wagon M4, for Shipment by Rail

STORAGE, PACKING, AND SHIPMENT

(c) Eight strands of No. 8 gage black annealed wire will be located over rear of frame, just back of rear blocks A, through holes cut in car floor and around beam of car (figs. 191 and 193).

(d) On Transport Wagon M4, eight strands of No. 8 gage black annealed wire will be located over frame in front of elevating arc portions, through holes cut in car floor and around beam of car (fig. 193).

(e) On Transport Wagon M5, eight strands of No. 8 gage black annealed wire will be located around each outrigger arm and through stake pocket, at side of flat car (fig. 191). Twist-tie the wire snug against the parts, but do not draw too tight.

(f) If the construction of the flat car is such that wires cannot be kept tight around some portion of the car when installed in the manner just described, two pieces of wire may be installed over each axle of the transport wagon, through holes cut in the car floor and around the under carriage of the car. Wires should go straight down from the parts to be secured, rather than at an angle.

(g) Secure each wheel by passing wire consisting of eight strands of No. 8 gage black annealed wire through two openings in the wheels and securing the wires to the stake pockets on each side of the car. Twist-tie with rod or bolt enough to remove slack. The openings in the wheels through which the wire passes should be approximately the same distance from the car floor.

107. PREPARATION FOR ACTION.

a. **Inspection.** A general inspection of the howitzer, carriage, and transport wagon will be made upon arrival at destination and the following noted before blocking is removed:

- (1) All traces of oil and grease, as might be shown on floor of open top railroad car, will be investigated to determine the origin or cause.
- (2) Evidence of excessive shock.
- (3) Shifting of materiel from original position.
- (4) Broken or unlocked padlocks or seals.
- (5) Damage due to hoisting slings or rigging.
- (6) General appearance of materiel (corrosion, etc.).
- (7) Evidence of damage by tampering while in transit. (If evidence of unauthorized tampering is apparent, a complete inspection and investigation, both external and internal, shall be made.

b. **Preparation.** Upon removal from limited storage, the materiel will be prepared for action as follows:

- (1) All covers will be removed from the materiel.

240-MM HOWITZERS M1918MI AND M1918MIA1, 240-MM HOWITZER
CARRIAGE M1918A2, AND TRANSPORT WAGONS M4 AND M5

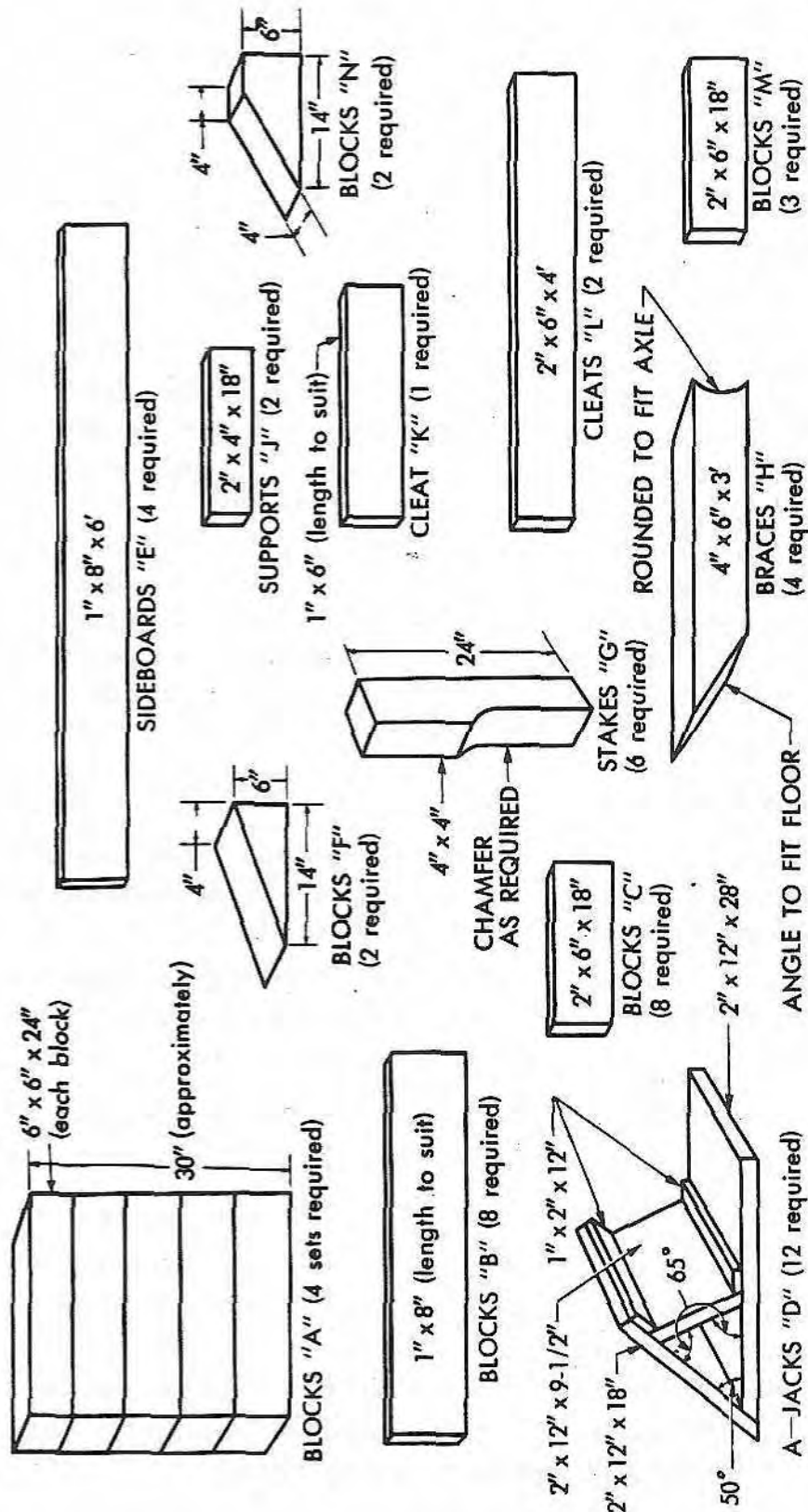

RA PD 72271

Figure 194 — Blocking Requirements for Transport Wagons M4 and M5

STORAGE, PACKING, AND SHIPMENT

- (2) Remove rust-preventive compound from exterior surfaces with dry-cleaning solvent.
- (3) Disassemble and clean materiel. Lubricate in accordance with W. D. Lubrication Orders 145 and 145a.
- (4) Any items noted by a tag attached to the materiel as needing repair or replacement will be replaced or repaired.
- (5) Tire pressure will be checked and tires inspected to see that they are in serviceable condition.

108. LIMITED STORAGE INSTRUCTIONS.

a. Preparation. Preparation for limited storage is the same as outlined in paragraph 105.

b. Tires. All tires will be cleaned, inspected, and properly inflated. Tires requiring repairing or retreading will be replaced with serviceable tires. Materiel will not be stored on floors, cinders, or other surfaces which are soaked with oil or grease. Any oil, grease, gasoline, or kerosene which comes in contact with tires under any circumstances will be washed off immediately.

c. Inspections. Periodical inspection will be made of the materiel while in storage. This inspection includes among other things, examination of the condition of rust-preventives, missing parts, and need for repairs. If the materiel is found to be corroding at any part, the entire howitzer and carriage will be rustproofed as described in paragraph 105.

TM 9-340
109-111

240-MM HOWITZERS M1918M1 AND M1918M1A1, 240-MM HOWITZER CARRIAGE M1918A2, AND TRANSPORT WAGONS M4 AND M5

CHAPTER 7

PREPARATION OF MATERIEL FOR USE UNDER EXTREME CONDITIONS

109. GENERAL.

a. The purpose of this chapter is to provide instructions for the care and lubrication of materiel operating in extreme conditions. Such information is useful for both operating and maintenance personnel to avoid poor performance and/or total functional failure, and in some instances, damage to both materiel and personnel.

110. EXTREME HIGH TEMPERATURES.

a. The materiel will be lubricated as prescribed for temperatures above 32 F. The tires will be checked frequently during traveling to make sure that the pressure is not deviating appreciably from the prescribed pressure. The liquid in the recoil and recuperator cylinders, and oil levels in gear cases will be checked.

NOTE: Extreme high temperature is often accompanied by other adverse conditions. Refer to paragraphs 112 and 113.

111. SUB-ZERO TEMPERATURES.

a. General.

(1) Since metals contract when the temperature decreases, and expand when the temperature increases, the clearances between bearing surfaces are considerably less at sub-zero than at higher temperatures. In preparing artillery for sub-zero temperature operation, care must be taken to make certain that parts are aligned properly and normal clearances exist, not only in bearings, but also in mechanisms employing packings around rotating or reciprocating shafts and rods. Lack of attention to this may result in binding which will make mechanisms stiff or inoperative regardless of the lubricant used. Scored or roughened bearings and other rubbing surfaces, such as cams and recoil slides also interfere with easy action and should be smoothed in preparing artillery materiel for low-temperature operation.

(2) Cleanliness is imperative. Rust, dirt, gummy oil, and grease in bearing clearances, reduced by low temperature, interfere with proper distribution of lubricant, thus causing stiff action, if not complete stoppage. In winterizing materiel, therefore, assemblies and mechanisms must be disassembled sufficiently to permit thorough removal of old oil, grease, and foreign matter. Cleaning is most efficiently done by washing with dry-cleaning solvent, employing brushes and scrapers where necessary. Care must be taken not to overlook

PREPARATION OF MATERIEL FOR USE UNDER EXTREME CONDITIONS

cleaning small items that may appear insignificant. Field experience has proved that neglect in cleaning small linkages, bearings, and other similar parts may cause malfunctioning and stoppages in sub-zero weather.

(3) Placing of materiel in proper mechanical condition requires time for necessary disassembly, repair, and cleaning and must be carefully done. The approach of low temperatures must be anticipated far enough in advance to permit completion of the conditioning before the onset of sub-zero temperatures.

b. **Lubricants.** The lubricants to be used are prescribed in the lubrication section (sec. VII).

c. **Operation.** To insure adequate lubrication and satisfactory performance of artillery materiel in cold weather, the following instructions must be followed when sub-zero temperatures are expected:

(1) **PLAIN JOURNAL BEARINGS AND BUSHINGS.** It is preferable to disassemble these bearings, not only to remove thoroughly all heavy oil, but also to test for adequate clearances between shaft and bearing.

(2) **ELEVATING ARCS, TRAVERSING RACK AND HANDWHEEL SHAFTS.** Snow will frequently collect on these parts. This will cake under pressure of the gears, forming ice which interferes with elevating and traversing. The snow must be removed by vigorous brushing with a stiff bristle or wire brush before manipulation of the piece is attempted.

(3) **FIRING MECHANISM.** Extreme cleanliness and the sparing application of oil are requirements. Clean thoroughly and apply oil by wiping the rubbing surfaces of the firing pin and attendant parts with a clean cloth which has been wet with the oil and wrung out.

(4) **HOWITZER BORE.**

(a) Cleaning of a cold tube after firing cannot be accomplished in the normal manner at temperature below +32 F because the water will freeze in the tube. If cleaning can be done with the tube hot, and hot water is available, normal soap, or soda ash solutions can be used. Otherwise, it will be necessary to add alcohol, or as an emergency alternative, glycerine, or antifreeze compound to the solution. To ten parts by volume of cleaning solution, add the number of parts of one of the antifreezes shown below.

Temperature, F	Alcohol	or Glycerine	or Compound Antifreeze
20	2	2½	2
10	4	5	3⅓
0	6½	6½	5
-15	9	10	7¼
-30	16	13	10
-40	27	16	12

240-MM HOWITZERS M1918MI AND M1918MIA1, 240-MM HOWITZER CARRIAGE M1918A2, AND TRANSPORT WAGONS M4 AND M5

(b) In applying light lubricating preservative oil to the bore after cleaning, care must be taken to work the oil in well so that it will reach all surfaces of the lands and grooves. When howitzer is brought into a heated shop, condensation will occur on all metal surfaces. After the howitzer reaches shop temperature, the tube and all other bright parts must be wiped dry and recoated with oil to prevent rusting.

(c) When materiel is protected with a canvas or other type cover, moisture will form on the metal surfaces. To prevent rusting, the cover must be removed at least weekly and all surfaces thoroughly dried and coated with light lubricating preservative oil.

(5) **RECOIL MECHANISM.** Recoil mechanisms using 60 percent glycerine and 40 percent water will in general operate satisfactorily at sub-zero temperatures. Below 0 F, counterrecoil may become abnormally slow. Careful cleaning of recoil slides and application of prescribed low-temperature lubricants will usually correct this condition.

(6) **SIGHTING INSTRUMENTS.** Instruments now being manufactured and issued are lubricated for low-temperature operation. Such instruments need no special lubrication service.

112. EXCESSIVELY MOIST OR SALTY ATMOSPHERE.

a. When the materiel is not in active use, the unpainted metal parts, including the bore and recoil slide of the cradle and the breech mechanism, will be kept heavily oiled, and will be inspected daily for traces of the formation of rust. The materiel will be lubricated more frequently than is prescribed for normal service. The breech and muzzle covers must be kept in place as much of the time as firing conditions permit.

b. In excessively salty atmosphere, the oil used will be changed often as the salt has a tendency to emulsify the oil and destroy its rust-preventive qualities.

113. EXCESSIVELY SANDY OR DUSTY CONDITIONS.

a. If considerable dust is present when the piece is to be operated, the lubricant will be removed from the elevating arcs and traversing rack, and pinions and the teeth of these parts will remain dry until the action is over. If the surfaces are dry, there will be less wear than when coated with a lubricant contaminated with grit.

b. The recoil slides must be kept as free of grit and dirt as is possible. The breather hole in the rear head of the recuperator cylinder must be kept open. The breech and muzzle covers must be kept in place as much of the time as firing conditions permit.

CHAPTER 8
REFERENCES

114. PUBLICATIONS INDEXES.

The following publications indexes should be consulted frequently for latest changes or revisions of references given in this chapter and for new publications relating to materiel covered in this manual:

- a. Introduction to Ordnance Catalog (explaining SNL system) ASF Cat.
ORD 1 IOC
- b. Ordnance Publications for Supply Index (index to SNL's) ASF Cat.
ORD 2 OPSI
- c. Index to Ordnance Publications (listing FM's, TM's, TC's, and TB's of interest to ordnance personnel, OPSR, MWO's, BSD, S of SR's, OSSC's, and OFSB's; and includes Alphabetical List of Major Items with Publications Pertaining Thereto OFSB 1-1
- d. List of Publications for Training (listing MR's, MTP's, T/BA's, T/A's, FM's, TM's, and TR's concerning training FM 21-6
- e. List of Training Films, Film Strips, and Film Bulletins (listing TF's, FS's, and FB's by serial number and subject) FM 21-7
- f. Military Training Aids (listing Graphic Training Aids, Models, Devices, and Displays) FM 21-8

115. STANDARD NOMENCLATURE LISTS.

a. Ammunition.

- Ammunition instruction material for antiaircraft, harbor defense, heavy field, and railway artillery, including complete round data SNL P-8
- Charges, propelling, separate loading, 6-inch to 240-mm, inclusive, for harbor defense, heavy field, and railway artillery SNL P-2
- Fuzer, primers, blank ammunition, and miscellaneous items for antiaircraft, harbor defense, heavy field, and railway artillery SNL P-7
- Projectiles, separate loading, 6-inch to 240-mm, inclusive, for harbor defense, heavy field, and railway artillery, including complete round data SNL P-1
- Service fuzes and primers for pack, light and medium field, aircraft, tank, and antitank artillery SNL R-3

TM 9-340
115-117

240-MM HOWITZERS M1918MI AND M1918MIA1, 240-MM HOWITZER CARRIAGE M1918A2, AND TRANSPORT WAGONS M4 AND M5

- b. Cleaning, preserving, and lubricating materials; recoil fluids; special oils, and miscellaneous related items SNL K-1
 - c. **Howitzer Materiel.**
 - Crane, truck mounted, M2 (in preparation) SNL G-172
 - Howitzer, 240-mm, M1918MI and M1918-MIA1; and Carriage, howitzer, 240-mm M1918A2 ORD 7 SNL D-35
 - Wagon, transport cannon, M4
 - Wagon, transport Carriage, M5
 - Major items of heavy field artillery SNL D-1
 - d. **Sighting and Fire Control Equipment.**
 - Circle, aiming, M1 SNL F-160
 - Instrument, azimuth, M1918 (mils) SNL F-149
 - Light, instrument, M9 (for telescope, panoramic, M6) SNL F-205
 - Posts, aiming SNL F-35
 - Quadrant, gunner's, M1918 (mils) SNL F-13
 - Sight, quadrant, M1918A1 ORD 8 SNL F-24
 - Telescope, B.C., M1915 and M1915A1 SNL F-9
 - Telescope, panoramic, M6 (mils) ORD 7 SNL F-22
- 116. EXPLANATORY PUBLICATIONS.**
- a. Ammunition, general TM 9-1900
 - b. Cleaning, preserving, lubricating, and welding materials and similar items issued by the Ordnance Department TM 9-850
 - c. **Maintenance and Repair.**
 - Decontamination TM 3-220
 - Defense against chemical attack FM 21-40
 - Maintenance and care of pneumatic tires and rubber treads TM 31-200
 - Maintenance: General OFSB 4-1
 - d. **Miscellaneous.**
 - Auxiliary fire control instruments (field glasses, eyeglasses, telescopes, and watches) TM 9-575
 - Crane, truck-mounted, M2 (to be prepared) TM 9-768
 - Field artillery fire control instrument TM 6-220
 - Fire control and position finding FM 4-15
- 117. FIRING TABLES.**
- a. Firing tables and trajectory charts (complete listing of the latest revisions) SNL F-69
 - b. Howitzer, 240-mm, M1918 and modifications FT 240-B-2

INDEX

A	Page		Page
Abrasives, care and preservation.....	140	Axle, front	
Accessories, description	223	description and functioning	62
Adapter, pressure gage, description	223	inspection	150
Adjustments		Axle, rear	
air filter and air tank	152	description and functioning	64
brakes	159	inspection	150
corrective measures and inspec- tion results	145		
cradle and platform locking assemblies	162	B	
firing mechanism	154	Barrow, shot, description	223
friction clutch	155	Bearings, plain journal, operation in sub-zero temperatures	249
general discussion	145	Bearings, wheel, lubrication	127
pintle	157	Bit, vent cleaning	223
purpose of	143	Blackout tail light, replacement of sealed beam units	187
quadrant sight M1918A1	196	Blocking transport wagons on flat cars	239
roller chain	156	Blocks for rail shipment	239
traversing roller	157	Bore sight	199
trunnion springs	155	Bore sighting	200
upon receipt of materiel	145	Boresafe fuzes (See Fuzes, boresafe)	
wheel bearings	161	Brakes	
Aiming post M1	196	adjustment	159
Aiming post light M14	197	application	
Air filters, inspection	152	emergency brakes	69
Air lines, transport wagons		service brakes	67
emergency air line	66	care and preservation	142
service air line	65	description and functioning	
Ammunition		brake mechanism	67
authorized rounds	205, 206	brakes	65, 71
care, handling, and preservation	204	inspection	
classification and identification...	202	brake mechanism	151
firing tables	202	hand brakes	153
general discussion	202	malfunctions and corrections	168, 169
lot number	203	operation (brake system)	114
marking for shipment	221	rail shipment (hand brakes).....	239
packing data	220	wheel clearance	237
painting and marking	203	Breech	
preparation for firing	207	closing of	97, 103
propelling charges	210	inspection	146
unloading of service rounds.....	109	opening of	96
Arcs, elevating (See Elevating arc)		(See also Operating lever)	
Artillery Gun Book (O.O. Form 5825)	144, 223	Breech cover M27	224
Assembly		Breech covers, domestic shipment..	237
breech mechanism	175	Breech mechanism	
firing mechanism	174	care and preservation	130
general discussion	170	cleaning	236
operating lever	171	description and functioning	16
percussion mechanism	180		

TM 9-340

240-MM HOWITZERS M1918MI AND M1918MIA1, 240-MM HOWITZER CARRIAGE M1918A2, AND TRANSPORT WAGONS M4 AND M5

B — Cont'd	Page		Page
Breech mechanism — Cont'd		Carriages	
disassembly and assembly	175	care and preservation	132
does not operate freely	165	characteristics	7
lubrication	126	data	11
operation	96	differences among models	10
Breech ring, malfunctions and		inspection	147
corrections	166	malfunctions and corrections.....	166
Breechblock		operation	81
description and functioning		organizational spare parts	223
actuating mechanism	22	Characteristics of materiel.....	4, 7
breechblock	17	Charges, propelling	
carrier	21	description	213, 215
eye rope	232	general discussion	210
lifting eye	226	Chest, metal gun section	224
failure to operate	165	Clamps (transport wagons)	143
inspection	146	Clamshell trailer (See Trailer M16, clamshell)	
malfunctions and corrections 165, 166		Cleaning	
Breechblock mechanism		all parts	126
assembly and installation	179	in sub-zero temperatures	248
disassembly	175	storage, packing, and shipment....	236
Bushings, plain journal, operation		Cleaning reamer, primer seat.....	232
in sub-zero temperatures	249	Clearance (rail shipment), brake	
		wheel	237
C		Clutch, friction	
Care and preservation		adjustment	155
bore sight	199	description and functioning	50
brake system	142	inspection	148
breech mechanism	130	Counterrecoil	
carriage	132	malfunctions and corrections 167, 168	
clamps, locking hooks, and		operation in sub-zero	
locking devices	143	temperatures	250
cleaners, abrasives and pre-		Covers (accessories)	
servatives	140	description	224
firing mechanism	132	installation (breech and muzzle) 237	
general discussion	128	Cradle	
howitzer tube	129	description and functioning	
paints and related materials	141	bands	
quadrant sight M1918A1	196	intermediate	41
recoil cylinders	134	rear	42
recuperator system	135	cradle	41
sighting equipment	187	elevating stop	42
tools and equipment	141	locking bolt slide	47
transport wagons	141	inspection	148
under unusual climatic conditions 250		Crane, truck-mounted (See Truck- mounted crane M2)	
wheels and hubs	143	Cylinder, compressed gas	226
Carriage cover M523	224		

INDEX

D	Page	D	Page
Data		Elevating mechanism	
ammunition	220	description and functioning	48
carriage	11	difficulty in elevating	167
howitzers	10	inspection	148
rail shipment	238	operation	95
transport wagons M4 and M5.....	11	Equipment	
Description		lubrication	126
accessories	223	(See also Electrical equipment)	
aiming post	196, 197	F	
bore sight	199	Filter, air, adjustment	152
boresafe fuzes	215	Fire control equipment, data.....	12
brakes	64	Firing the howitzer	
breech mechanism	21	failure to fire	163, 164
breechblock	17	firing	103
breechblock actuating mechanism	22	points to be observed before.....	99
carriage	38	preparation of ammunition	207
clamshell trailer	80	Firing gear assembly, description	
cradle bands	41	and functioning	43
elevating mechanism	48	Firing mechanism	
firing mechanism	24	adjustment	154
front axle	62	assembly	174
main pintle mechanism	56	care and preservation	132
obturator	17	cleaning	236
panoramic telescope		description and functioning 24, 25, 27	
extension 14-inch	193	disassembly	173
M6	190, 192	housing key extractor	226
quadrant sight	190, 191	inspection	146
quick-loading gear mechanism....	50	malfunctions and corrections 163, 164	
recoil system	34	operation in sub-zero	
top carriage	45	temperatures	249
truck-mounted crane	75	Firing mechanism wrench	235
wheels, hubs, and tires	72	Firing tables	202
Diaphragms, air brake, inspection....	152	Floats, outrigger	58
Disassembly		Footboards (carriage)	
breech mechanism	175	description and functioning.....	47
firing mechanism	173	inspection	149
general discussion	170	Frames	
operating lever	170	description and functioning	59
percussion mechanism	180	inspection	150
Drawbar assembly		Fuze, P.D., M46	215
description and functioning	64	Fuze, P.D., M47	216
malfunctions and corrections	168	Fuze, P.D. M51A3, w/booster	
E		M21A2	217
Electrical equipment		Fuze, time, mechanical, M67	
care and preservation	143	w/booster M21A1	218
description and functioning	72	Fuze, time, mechanical, M67A1	
inspection	151	w/booster, M2A1	219
Elevating arc, operation in sub-		Fuzes	
zero temperatures	249	description	215
		removal from shell	109

240-MM HOWITZERS M1918MI AND M1918MIA1, 240-MM HOWITZER CARRIAGE M1918A2, AND TRANSPORT WAGONS M4 AND M5

G	Page	I	Page
Gage, pressure (See Pressure gage)		Identification of ammunition....	202, 203
Gage, thickness	231	Inspection	
Gas-check pad	165	air brake diaphragms, filters,	
Gas-check seat	130	and tanks	152
Gases, escape of	165	brake mechanism	151
Gear cases, lubrication	126, 127	breech, breechblock, and breech-	
Gear mechanism, quick-loading		block carrier assembly	146
(See Quick-loading gear		carriage	147
mechanism)		cradle and quick-loading	
		mechanism	148
		electrical equipment	151
		elevating mechanism and friction	
		clutch	148
		firing mechanism	146
		footboards and platform	149
		general discussion	145
		howitzer	144
		locking devices	150
		main pintle	149
		obturator assembly	146
		percussion-mechanism	147
		periodical (limited storage)	247
		preparation for action	245
		purpose of	143
		railroad cars	237
		sleigh and recoil mechanism	147
		spare parts	144
		storage, packing and shipment....	237
		traversing mechanism	148
		traversing rollers and trunnion	
		assemblies	149
		upon receipt of materiel	145
		wheels, hubs, and tires	153
		L	
		Lanyard M7, steel cable	231
		Leakage, excessive, front and rear	
		packing	167
		Leather articles, care and	
		preservation	189
		Lever, operating (See Operating	
		lever)	
		Lifting sling, description	233
		Litmus paper, w/vial and container	231
		Loading, materiel on railroad car....	237
		Loading ramp (See Ramp, loading)	
		Loading the howitzer, preparation	
		of projectile	101
H			
Handwheel shaft, operation in sub-			
zero tempartures	249		
Howitzer bore, operation in sub-			
zero temperatures	249		
Howitzer cover M93	224		
Howitzers			
characteristics	4		
data	10		
description and functioning	13		
differences among models	7, 13		
elevating and traversing			
difficulties	167		
emplacement	81		
failure to fire	163, 164		
firing	103		
inspection	144		
loading	101		
malfunctions and corrections			
carriage	166		
howitzer	163		
mounting	189		
operation	81		
organizational spare parts	223		
placing in traveling position.....	109		
points to be observed			
before firing	99		
during firing	106		
unloading service rounds	109		
Hubs			
care and preservation	143		
description and functioning	73		
inspection	153		
installation	184		
removal	183		
Hydrometer w/bag and case,			
description	231		

INDEX

L — Cont'd	Page	Page	
Loads (rail shipment), data.....	238	Obturator spindle and hinge pin bushing nut wrench	235
Locking assemblies, cradle and platform, adjustment	162	Oiler (CLGX1A)	231
Locking devices		Opener, container	231
care and preservation	143	Operating lever, removal and dis- assembly	170
inspection	150	Operation	
Lot number, ammunition	203	bore sight	199
Lubricants		breech mechanism	
preparation for use under		closing of breech	97
unusual conditions.....	249, 250	opening of breech	96
sighting equipment	189	in high temperatures	248
Lubrication		in sub-zero temperatures	249
by ordnance personnel	127	quadrant sight M1918A1; pano- ramic telescope M6	193
equipment	126	to elevate	95
identification of lubrication		to traverse	94
points	117	(See also under <i>specific items</i>)	
instructions	116	Optical parts, care and preservation	189
lubrication orders	117, 247	Outriggers	
materiel	126	description and functioning	58
oilcan points	127	(See also <i>Float, outrigger</i>)	
points of application	126		
reports and records	128	P	
special (extreme climates)	117	Packing (See <i>Storage, packing, and shipment</i>)	
storage, packing and shipment....	236	Painting	
(See also <i>Lubricants</i>)		identification of ammunition	203
M		storage, packing, and shipment....	236
Maintenance, general information..	170	Paints and related materials	141
Malfunctions and corrections		Percussion mechanism	
carriage	166	assembly and disassembly	180
howitzer	163	description and functioning	25
transport wagons	168	inspection	147
Marking, ammunition.....	202, 203, 221	malfunctions and corrections	165
Markings, weight-zone	204	Pintle	
Measure 15-5316A	231	adjustment	157
Models, ammunition, identification		inspection	149
of	202	Pintle crown	46
Mounting of howitzer	189	Pintle mechanism, main	56
Muzzle cover M36	224	Pintle wrench	235
N		Piston rod beam, description and functioning	42
Nitrogen		Pit, howitzer emplacement	81
filling recuperator system with....	138	Platform	
testing of pressure	137	description and functioning	53
O		inspection	149
Obturator			
assembly and installation	179		
damp or fouled spindle vent.....	164		
description and functioning	17		
disassembly	175		
inspection	147		

240-MM HOWITZERS M1918MI AND M1918MIA1, 240-MM HOWITZER CARRIAGE M1918A2, AND TRANSPORT WAGONS M4 AND M5

P - Cont d	Page	Page	
Platform and top carriage assembly, loading on transport wagon	111	Recoil measuring length of	107
Powder temperature thermometer w/case	234	recoil action	34
Preservation (See Care and preservation)		Recoil cylinder liquid	134
Preservatives	140	Recoil cylinders, lubrication of	127
Pressure gage	226	Recoil mechanism description	28
Pressure gage adapter (See Adap- ter, pressure gage)		operation in sub-zero tempera- tures	250
Primer, defective	163	Recoil system functioning	34
Primer seat, obturator spindle, care and preservation	131	malfunctioning and correction.....	166
Primer seat cleaning reamer.....	232	Recuperator cylinder filling with liquids	135
Primers, percussion	219, 220	lubrication of	127
Projectile, dummy, unloading of....	109	Recuperator mechanism, descrip- tion	32
Projectile, dummy, 356-lb, Mk. I, 240-mm Howitzer M1918MI and M1918MIA1	210	Recuperator reservoirs	33
Projectiles fuzing	102	Recuperator system care and preservation	135
preparation	101	filling	138, 139
Propelling charge abnormal condition	164	testing nitrogen pressure	137
preparation and loading	103	Roller assembly, traversing (See Traversing roller)	
Pump, air, w/lever	231	Roller chain, quick-loading mecha- nism, adjustment	156
Pump, liquid, w/lever	232	Rounds of ammunition, authorized	206
Q		S	
Quadrant sight M1918A1 adjustments, care, preservation, and tests	196	Shell tongs	234
description	190, 191	Shells empty for sand loading	210
operation	193	high-explosive	207
R		Shipment (See Storage, packing, and shipment)	
Railroad cars inspection	237	Sideboards E	239
handling	238	Sighting equipment care and preservation	187
Rammer (and sponge), hand	233	data	12
Ramp, loading description	232	general discussion	187
rail shipment	237	inspection	149
Reports and records Artillery Gun Book (O.O. Form 5825)	144	lubricants	189
field reports of accidents	222	(See also under specific items)	
lubrication	128	Sleigh, description and functioning	39
		Sling, lifting	233
		Spare parts description	223
		inspection	144

INDEX

S — Cont'd	Page		Page
Sponge (bore), description	233	Transport wagons	
Sponge cover M4	224	blocking on flat cars	239
Steel cable lanyard M7	23	care and preservation	141
Storage, packing and shipment		characteristics	7
loading materiel on railroad car..	237	data	11
limited storage instructions	247	description and functioning	58
preparation for		differences among models	10
action	245	inspection	150
domestic shipment	236	malfunctions and corrections.....	168
Strapping (loading materiel on		strapping M4 and M5	245
railroad car)	242	Transportation	
		loading howitzer on transport	
		wagon	109
		points to be observed before	
		traveling	113
		Traversing	
		difficulty in	167
		howitzer	94
		Traversing mechanism	
		description and functioning	51
		inspection	148
		Traversing rack, operation in sub-	
		zero temperatures	249
		Traversing roller	
		adjusting wrench	235
		adjustment	157
		description and functioning	46
		inspection	149
		Truck-mounted crane M2	
		characteristics	7
		description and functioning.....	75
		Trunnion assemblies, inspection.....	149
		Trunnion band	41
		Trunnion bearing assemblies	
		description and functioning	45
		lubrication of bearings	127
		Trunnion springs	155
		Tube, howitzer	129
		W	
		War department lubrication orders	117
		Wheels, transport wagon	
		alinement	143
		description and functioning	72
		inspection	153
		installation	184
		malfunctions and corrections.....	169
		removal	183
		Wrenches, description	234, 235

