

**TM 9-1750J**

**WAR DEPARTMENT**

**TECHNICAL MANUAL**

**ORDNANCE MAINTENANCE  
POWER UNIT ACCESSORIES  
FOR MEDIUM TANKS  
M3A4 AND M4A4**

**MAY 12, 1943**

**DECLASSIFIED**

**Auth: NND 775128  
By NNHP NARS 3-3-78**

**REGRADED UNCLASSIFIED  
AUTHORITY OF DOD DIR.  
BY RAKWS 0**

This record was previously  
allocated to RG 319 (Entry  
No. 382) and is now assigned  
to RG 287.

**FOR ORDNANCE PERSONNEL ONLY**

**RESTRICTED**

**TECHNICAL MANUAL**  
**No. 9-1750J**

**WAR DEPARTMENT**  
**Washington, May 12, 1943**

**ORDNANCE MAINTENANCE**  
**POWER UNIT ACCESSORIES FOR MEDIUM TANKS**  
**M3A4 AND M4A4**

Prepared under the direction of the  
**Chief of Ordnance**  
 (with the cooperation of the Chrysler Corporation)

**CONTENTS**

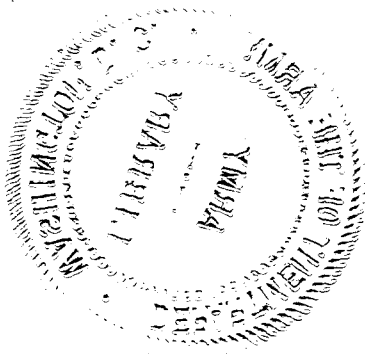
	Paragraphs	Pages
CHAPTER 1. INTRODUCTION .....	1- 5	3- 12
CHAPTER 2. FUEL SYSTEM .....	6- 33	13- 99
SECTION I. Description of system .....	6- 9	13- 16
II. Trouble shooting .....	10- 15	17- 23
III. Carburetor .....	16- 23	24- 46
IV. Fuel pump .....	24- 30	47- 83
V. Fuel filter, automatic fuel shut-off valve, and fuel tanks .....	31- 33	84- 99
CHAPTER 3. POWER UNIT LUBRICATING SYSTEM .....	34- 46	100-153
SECTION I. Description of system .....	34- 37	100-111
II. Trouble shooting .....	38	112-113
III. Lubricating oil pumps .....	39- 40	114-132
IV. Lubricating oil filters .....	41	133-146
V. Lubricating oil lines, oil cooler and oil supply tank .....	42-44	147-151
VI. Limits and tolerances .....	45- 46	152-153
CHAPTER 4. COOLING SYSTEM .....	47- 65	154-217
SECTION I. Description of system .....	47- 50	154-155
II. Trouble shooting .....	51- 52	156-157
III. Water pumps .....	53- 55	158-196
IV. Radiator, pressure vent valve, thermostats, water manifolds, water distributor tube, and fan .....	56- 63	197-215
V. Fits and tolerances .....	64- 65	216-217

9 031787

PROPERTY OF U. S.

**ORDNANCE MAINTENANCE—POWER UNIT ACCESSORIES  
FOR MEDIUM TANKS M3A4 AND M4A4**

	Paragraphs	Pages
CHAPTER 5. CLUTCH (MODEL M4A4) .....	66- 77	218-256
SECTION I. Description of clutch .....	66- 69	218-229
II. Trouble shooting .....	70	230-231
III. Disassembly .....	71- 72	232-238
IV. Inspection of parts .....	73	239-240
V. Assembly .....	74- 75	241-254
VI. Fits and tolerances .....	76- 77	255-256
CHAPTER 6. CLUTCH (MODEL M3A4) .....	78- 90	257-274
SECTION I. Description of clutch .....	78- 81	257-260
II. Trouble shooting .....	82	261
III. Disassembly .....	83- 84	262-264
IV. Inspection of parts .....	85	265-266
V. Assembly .....	86- 88	267-272
VI. Fits and tolerances .....	89- 90	273-274
CHAPTER 7. ELECTRICAL SYSTEM .....	91-122	275-369
SECTION I. Description of system .....	91- 95	275-276
II. Trouble shooting .....	96- 97	277-279
III. Starter circuit and starter motor ..	98-103	280-311
IV. Generator circuit and generator ..	104-118	312-358
V. Power unit sending units and gages .....	119-122	359-369
CHAPTER 8. REFERENCES .....	123-124	370-372
INDEX .....		373-381



CHAPTER 1

INTRODUCTION

	Paragraph
Scope .....	1
Arrangement .....	2
Differences among models .....	3
Maintenance allocation .....	4
References .....	5

**1. SCOPE.**

a. This manual is published for the information and guidance of ordnance maintenance personnel. It contains detailed instructions for inspection, disassembly, assembly, maintenance, and repair of the power unit accessories for Medium Tanks M3A4 and M4A4 supplementary to those in the field and technical manuals prepared for the using arms. This manual does not contain information which is intended primarily for the using arms since such information is available to ordnance maintenance personnel in 100-series technical or field manuals.

**2. ARRANGEMENT.**

a. This manual contains a description of and procedures for removal, trouble shooting, inspection and testing, disassembly, repair, and installation of the fuel system, cooling system, lubricating system, clutch and electrical system.

**3. DIFFERENCES AMONG MODELS.**

a. **Fuel System.** All of the medium tank engine power units used in the Tank M3A4, as well as power units M4A4-1001 to, and including, M4A4-2304 were equipped with fuel pump mounted on the distributor end of the crankcase (fig. 17). Power units M4A4-2305, and above, incorporate a fuel pump mounted on the distributor end of No. 4 engine (fig. 18).

b. **Cooling System.** Choke type thermostats, mounted in the cylinder head adapter of each individual engine, were incorporated in the M4A4 power unit, from serial number M4A4-1001 to, and including, M4A4-3211. Power units M4A4-3212, and above, incorporate a bypass type of thermostat.

c. **Lubricating System.** All M4A4 power units are equipped with two absorption type oil filters, mounted on No. 1 engine. On vehicles with serial number M4A4-18171, and above, a full flow strainer type of oil filter, located in the rear of the fighting compartment (fig. 95), was added. The two absorption type filters are still retained.



**ORDNANCE MAINTENANCE—POWER UNIT ACCESSORIES  
FOR MEDIUM TANKS M3A4 AND M4A4**

d. **Clutch.** The clutch, of the fully enclosed type, was used on power unit serial number M4A4-1001 to, and including, M4A4-4412. Power units M4A4-4413, and above, use a clutch of the ventilated type.

e. **Electrical System.** On all M3A4 power units and on M4A4 power units from serial number M4A4-1001 to, and including, M4A4-2304, the generator was mounted on No. 2 engine and driven by No. 2 engine water pump drive belt. The generator of power units M4A4-2305, and above, is mounted in the fighting compartment and belt-driven from the propeller shaft.

**4. MAINTENANCE ALLOCATION.**

a. **Scope.** The scope of maintenance and repair by the crew and other units of the using arms is determined by the availability of suitable tools, availability of necessary parts, capabilities of the mechanics, time available, and the tactical situation. All of these are variable and no exact system of procedure can be prescribed.

b. **Allocation of Maintenance.** Indicated below are the maintenance duties for which tools and parts have been provided for the using arm personnel. Other replacements and repairs are the responsibility of ordnance maintenance personnel but may be performed by using arm personnel when circumstances permit, within the discretion of the commander concerned. Echelons and words as used in this list of maintenance allocations are defined as follows:

**SECOND ECHELON:** Line organization regiments, battalions, companies, detachments, and separate companies (first and second echelons).

**THIRD ECHELON:** Ordnance light maintenance companies, ordnance medium maintenance companies, ordnance divisional maintenance battalions, and post ordnance shops.

**FOURTH ECHELON:** Ordnance heavy maintenance companies and service command shops.

**FIFTH ECHELON:** Ordnance base regiments, ordnance bases, arsenals, and manufacturers' plants.

**SERVICE:** (Including preventive maintenance) (par. 23 a (1) and (2), AR 850-15) (10-6-42) Consists of servicing, cleaning, lubricating, tightening bolts and nuts, and making external adjustment of subassemblies or assemblies and controls.

**REPLACE:** (par. 23 a (4), AR 850-15) (10-6-42) Consists of removing the part, subassembly or assembly from the vehicles and replacing it with a new or reconditioned or rebuilt part, subassembly or assembly, whichever the case may be.

**INTRODUCTION**

**REPAIR:** (par. 23 a (3) and (5), in part, AR 850-15) (10-6-42) Consists of making repairs to, or replacement of, the part, subassembly or assembly that can be accomplished without completely disassembling the subassembly or assemblies, and does not require heavy welding, or riveting, machining, fitting and/or alining or balancing.

**REBUILD:** (par. 23 a (5), in part, and (6) AR 850-15) (10-6-42) Consists of completely reconditioning and replacing in serviceable condition any unserviceable part, subassembly, or assembly of the vehicle, including welding, riveting, machining, fitting, alining, balancing, assembling and testing.

**NOTE:** Operations allocated will normally be performed in the echelon indicated by "X." Operations allocated to the echelons as indicated by "E" may be accomplished by the respective echelons in emergencies only.

	ECHELONS			
	2nd	3rd	4th	5th
<b>BOXES AND RACKS, AMMUNITION</b>				
Boxes, ammunition—replace . . . . .	x			
Boxes, ammunition—repair . . . . .		x		
Racks, ammunition—replace . . . . .	x			
Racks, ammunition—repair . . . . .		x		
<b>CONTROLS, BRACKETS AND LEVERS</b>				
Brackets and levers—replace . . . . .	x			
Brackets and levers—repair . . . . .		x		
Controls and linkage—replace . . . . .	x			
Controls and linkage—repair . . . . .		x		
<b>DRIVE, FINAL (GEAR TRAIN ASSEMBLY) (ONE-PIECE)</b>				
*Drive, final, gear train assembly—replace . . . . .		x		
Drive, final, gear train assembly—repair . . . . .		x		
Drive, final, gear train assembly—rebuild . . . . .			E	x
<b>DIFFERENTIAL, CONTROLLED, CARRIER ASSEMBLY AND SUBASSEMBLY</b>				
Differential, controlled, assembly—replace . . . . .		x		
Differential, controlled, assembly—repair . . . . .		E	x	
Differential, controlled, assembly—rebuild . . . . .			E	x
Drum, steering brake—replace . . . . .		x		
Drum, steering brake—repair . . . . .			x	
Shoe, steering brake—replace . . . . .	x			
Shoe, steering brake—repair (reline) . . . . .		x		

\*The second echelon is authorized to remove and reinstall engine and transmission assemblies, transfer units, controlled differential assembly and other items marked by an asterisk. However, when it is necessary to replace an item marked by an asterisk with a new or rebuilt part, subassembly or unit assembly, the assembly marked by an asterisk may be removed from the vehicle by the second echelon only after authority has been obtained from a higher echelon of maintenance.

**ORDNANCE MAINTENANCE—POWER UNIT ACCESSORIES  
FOR MEDIUM TANKS M3A4 AND M4A4**

	ECHELONS				
	REDUCTION, FINAL	2nd	3rd	4th	5th
Hub, sprocket—replace . . . . .		X			
Hub, sprocket—repair . . . . .			X		
Hub, sprocket—rebuild . . . . .				E	X
Reduction assembly, final drive—replace . . . . .		X			
Reduction assembly, final drive—repair . . . . .			X		
Reduction assembly, final drive—rebuild . . . . .				E	X
Sprocket—replace . . . . .		X			
Sprocket—rebuild . . . . .				E	X
<b>TRANSMISSION ASSEMBLY</b>					
Brakes, parking—replace . . . . .		X			
Brakes, parking—repair (reline) . . . . .			X		
*Transmission assembly—replace . . . . .			X		
Transmission assembly—repair . . . . .			X		
Transmission assembly—rebuild . . . . .				E	X
<b>DRIVE, FINAL (GEAR TRAIN ASSEMBLY) (THREE-PIECE)</b>					
*Drive, final, gear train assembly—replace . . . . .			X		
Drive, final, gear train assembly—repair . . . . .			X		
Drive, final, gear train assembly—rebuild . . . . .				E	X
<b>DIFFERENTIAL, CONTROLLED, CARRIER ASSEMBLY</b>					
Differential, controlled, assembly—replace . . . . .			X		
Differential, controlled, assembly—repair . . . . .			E	X	
Differential, controlled, assembly—rebuild . . . . .				E	X
<b>DIFFERENTIAL, CONTROLLED, SUBASSEMBLY</b>					
Differential, controlled, subassembly—replace . . . . .			X		
Differential, controlled, subassembly—repair . . . . .			E	X	
Differential, controlled, subassembly—rebuild . . . . .				E	X
Drum, steering brake—replace . . . . .			X		
Drum, steering brake—repair . . . . .				X	
Shoe, steering brake—replace . . . . .		X			
Shoe, steering brake—repair (reline) . . . . .			X		
<b>REDUCTION, FINAL</b>					
Hub, sprocket—replace . . . . .		X			
Hub, sprocket—repair . . . . .			X		
Hub, sprocket—rebuild . . . . .				E	X
Reduction, final drive—replace . . . . .		X			
Reduction, final drive—repair . . . . .			X		
Reduction, final drive—rebuild . . . . .				E	X
Sprocket—replace . . . . .		X			
Sprocket—rebuild . . . . .				E	X

\*The second echelon is authorized to remove and reinstall engine and transmission assemblies, transfer units, controlled differential assembly and other items marked by an asterisk. However, when it is necessary to replace an item marked by an asterisk with a new or rebuilt part, subassembly or unit assembly, the assembly marked by an asterisk may be removed from the vehicle by the second echelon only after authority has been obtained from a higher echelon of maintenance.

INTRODUCTION

	ECHELONS			
	2nd	3rd	4th	5th
<b>TRANSMISSION ASSEMBLY</b>				
Brake, parking—replace	X			
Brake, parking—repair (reline)		X		
*Transmission assembly—replace		X		
Transmission assembly—repair		X		
Transmission assembly—rebuild			E	X
<b>ELECTRICAL SYSTEM</b>				
Battery—service, replace and recharge	X			
Battery—repair		X		
Battery—rebuild			E	X
Box, apparatus (generator control)—replace	X			
Box, apparatus (generator control)—repair		X		
Box, apparatus (generator control)—rebuild			X	
Box, battery—replace	X			
Box, battery—repair		X		
Box, terminal—replace	X			
Box, terminal—repair		X		
Box, turret collector ring—replace	X			
Box, turret collector ring—repair		X		
Box, turret collector ring—rebuild			X	
Brackets, mounting and supports—replace	X			
Brackets, mounting and supports—repair		X		
Breakers, circuit—replace	X			
Breakers, circuit—repair		X		
Breakers, circuit—rebuild			X	
Cables, battery—replace	X			
Cables, battery—repair		X		
Conduits—replace	X			
Filters, generator—replace	X			
Filters, generator—repair		X		
Generator, auxiliary assembly—replace	X			
Generator, auxiliary assembly—repair		X		
Generator, auxiliary assembly—rebuild			E	X
Lamps, all—service or replace	X			
Lamps, all—repair		X		
Siren—replace	X			
Siren—repair		X		
Siren—rebuild			X	

\*The second echelon is authorized to remove and reinstall engine and transmission assemblies, transfer units, controlled differential assembly and other items marked by an asterisk. However, when it is necessary to replace an item marked by an asterisk with a new or rebuilt part, subassembly or unit assembly, the assembly marked by an asterisk may be removed from the vehicle by the second echelon *only after authority has been obtained from a higher echelon of maintenance.*

**ORDNANCE MAINTENANCE—POWER UNIT ACCESSORIES  
FOR MEDIUM TANKS M3A4 AND M4A4**

	ECHELONS			
	2nd	3rd	4th	5th
<b>ELECTRICAL SYSTEM (Cont'd)</b>				
Solenoids—replace	X			
Solenoids—repair		X		
Switches—replace	X			
Switches—repair		X		
Switches—rebuild			X	
Wires—replace	X			
<b>ENGINE</b>				
Bearings, connecting rod—replace		E	E	X
Bearings, crankshaft—replace		E	E	X
Breather, crankcase—service and replace	X			
Breather, crankcase—repair		X		
Carburetor and governor assemblies—replace (Governor must be set after installation)	E	X		
Carburetor and governor assemblies—repair		X		
Carburetor and governor assemblies—rebuild			X	
Clutch assembly—replace	X			
Clutch assembly—repair		X		
Clutch assembly—rebuild			E	X
Coils, ignition—replace	X			
Controls and linkage, carburetor, and choke—service and replace	X			
Controls and linkage, carburetor, and choke—repair		X		
Cooling system—service	X			
Damper, vibration—replace	X			
Distributor assemblies—service and replace	X			
Distributor assemblies—repair		X		
Distributor assemblies—rebuild			X	
*Engine, multibank assembly—replace		X		
Engine, multibank assembly—repair		X		
Engine, multibank assembly—rebuild			E	X
Fan assembly—replace	X			
Fan assembly—repair		X		
Fan assembly—rebuild			E	X
Filters, fuel—service and replace	X			
Filters, fuel—repair		X		
Filters, ignition circuit—replace	X			
Filters, ignition circuit—repair		X		

\* The second echelon is authorized to remove and reinstall engine and transmission assemblies, transfer units, controlled differential assembly and other items marked by an asterisk. However, when it is necessary to replace an item marked by an asterisk with a new or rebuilt part, subassembly or unit assembly, the assembly marked by an asterisk may be removed from the vehicle by the second echelon *only after authority has been obtained from a higher echelon of maintenance.*

INTRODUCTION

	ECHELONS			
	2nd	3rd	4th	5th
ENGINE (Cont'd)				
Filters, oil (bypass)—service and replace	x			
Filters, oil (bypass)—repair		x		
Flywheel assembly—replace	x			
Flywheel assembly—repair		x		
Flywheel assembly—rebuild			E	x
Gaskets, cylinder head—replace	x			
Gaskets, exhaust and intake manifold—replace	x			
Gear, camshaft—replace		E	x	
Heads, cylinder—replace		x		
Heads, cylinder—repair			x	
Lines, fuel—replace	x			
Lines, fuel—repair		x		
Lines, oil (external)—replace	x			
Lines, oil (external)—repair		x		
Manifolds, exhaust and intake—replace	E	x		
Manifolds, exhaust and intake—repair		x		
Mounts, engine—replace	x			
Pan, oil—clean and replace gaskets	x			
Pistons and rings—replace		E	E	x
Plugs, spark—replace	x			
Plugs, spark (two-piece)—repair		x		
Pump assemblies, fuel—replace	x			
Pump assemblies, fuel—repair		x		
Pump assemblies, fuel—rebuild			x	
Pump assemblies, water—replace	x			
Pump assemblies, water—repair		x		
Pump assemblies, water—rebuild			x	
Pump assembly, oil, pressure, and scavenger—replace and repair		x		
Pump assembly, oil, pressure, and scavenger—rebuild			E	x
Radiator assembly—replace	x			
Radiator assembly—repair		x		
Radiator assembly—rebuild			E	x
Starter assembly—replace	x			
Starter assembly—repair		x		
Starter assembly—rebuild			x	
Strainer, fuel—service and replace	x			
Strainer, fuel—repair		x		
Thermostat, water—replace	x			
Units, signal, oil (sending)—replace	x			
Units, signal, water (sending)—replace	x			

**ORDNANCE MAINTENANCE—POWER UNIT ACCESSORIES  
FOR MEDIUM TANKS M3A4 AND M4A4**

	ECHELONS			
	2nd	3rd	4th	5th
<b>EXTINGUISHING SYSTEM, FIRE</b>				
Controls, remote—replace (CO <sub>2</sub> ) . . . . .	x			
Controls, remote—repair (CO <sub>2</sub> ) . . . . .		x		
Cylinders (CO <sub>2</sub> )—replace . . . . .	x			
Cylinders (CO <sub>2</sub> )—repair or recharge . . . . .		x		
Extinguishers, fire, assembly—replace and refill (CCl <sub>4</sub> ) . . . . .	x			
Extinguishers, fire, assembly—rebuild (CCl <sub>4</sub> ) . . . . .			E	x
Lines and nozzles (CO <sub>2</sub> )—replace . . . . .	x			
Lines and nozzles (CO <sub>2</sub> )—repair . . . . .		x		
<b>FUEL SYSTEM</b>				
Cleaners, carburetor, air—replace . . . . .	x			
Cleaners, carburetor, air—repair . . . . .		x		
Filter—service or replace . . . . .	x			
Filter—repair . . . . .		x		
Lines, valves and fittings—replace . . . . .	x			
Lines, valves and fittings—repair . . . . .	E	x		
Tanks, fuel—replace . . . . .	x			
Tanks, fuel—repair . . . . .		x		
<b>HULL</b>				
Bracket, engine support—replace . . . . .			E	x
Doors and cover plates—replace . . . . .	x			
Doors and cover plates—repair . . . . .		E	x	
Guards, mud—replace . . . . .	x			
Guards, mud—repair . . . . .		x		
Hull—repair . . . . .		x		
Hull—rebuild . . . . .			E	x
Insulation and padding—replace . . . . .	x			
Periscope—replace . . . . .	x			
Periscope—repair . . . . .		x		
Periscope—rebuild . . . . .			E	x
Seats—replace . . . . .	x			
Seats—repair . . . . .		x		
<b>INSTRUMENTS AND PANELS</b>				
Instruments—replace . . . . .	x			
Instruments—repair . . . . .		x		
Instruments—rebuild . . . . .			E	x
Panel and connections—replace . . . . .	x			
Panel and connections—repair . . . . .		x		

**INTRODUCTION**

	ECHELONS			
	2nd	3rd	4th	5th
<b>LUBRICATION SYSTEM</b>				
Cooler, oil, engine and transmission—replace . . . . .	x			
Cooler, oil, engine and transmission—repair . . . . .		x		
Cooler, oil, engine and transmission—rebuild . . . . .			E	x
Filter, engine oil—replace . . . . .	x			
Filter, engine oil—repair . . . . .		x		
Lines, oil, engine and transmission—replace . . . . .	x			
Lines, oil, engine and transmission—repair . . . . .		x		
Tank, engine oil—replace . . . . .	x			
Tank, engine oil—repair . . . . .		x		
<b>SHAFT, PROPELLER, AND UNIVERSAL JOINT ASSEMBLY</b>				
Shaft, propeller, and universal joint assembly— replace . . . . .	x			
Shaft, propeller, and universal joint assembly— repair . . . . .		x		
Shaft, propeller, and universal joint assembly— rebuild . . . . .			E	x
<b>SUSPENSION SYSTEM, TRACK</b>				
Bearings and seals, bogie and idler wheels—replace . . . . .	x			
Bogie components—replace . . . . .	x			
Bogie components—repair . . . . .		x		
Bogie components—rebuild . . . . .			E	x
Bracket, idler—replace . . . . .	E	x		
Bracket, idler—repair . . . . .		x		
Bracket, idler—rebuild . . . . .			E	x
Roller and bracket assembly, track supporting— replace . . . . .	x			
Roller and bracket assembly, track supporting— repair . . . . .		x		
Roller and bracket assembly, track supporting— rebuild . . . . .			E	x
Track assembly—replace or repair . . . . .	x			
Track assembly—rebuild . . . . .			E	x
Wheels, bogie—replace . . . . .	x			
Wheels, bogie—repair (replace tire) . . . . .		x		
Wheels, idler—replace . . . . .	x			
Wheels, idler—repair . . . . .		x		
Wheels, idler—rebuild . . . . .			E	x



**ORDNANCE MAINTENANCE—POWER UNIT ACCESSORIES  
FOR MEDIUM TANKS M3A4 AND M4A4**

	ECHELONS			
	2nd	3rd	4th	5th
<b>TURRET ASSEMBLY</b>				
Basket, turret—replace and repair . . . . .		x		
Basket, turret—rebuild . . . . .			E	x
Brake assembly—replace . . . . .	x			
Brake assembly—repair . . . . .		x		
Mechanism, traversing (manual)—replace . . . . .	x			
Mechanism, traversing (manual)—repair . . . . .		x		
Mechanism, traversing (manual)—rebuild . . . . .			x	
Ring, turret—replace . . . . .		E	x	
Turret assembly—replace or repair . . . . .		x		
Turret assembly—rebuild . . . . .			E	x
<b>VEHICLE ASSEMBLY</b>				
Tank assembly—service and preventive maintenance . . . . .	x			
Tank assembly—rebuild (with serviceable assemblies) . . . . .			x	E

**5. REFERENCES.**

a. The last chapter of this manual lists all technical manuals, standard nomenclature lists, and publications relative to the materiel described herein.

**CHAPTER 2**  
**FUEL SYSTEM**

**Section I**  
**DESCRIPTION OF SYSTEM**

	Paragraph
Description .....	6
Tabulated data and specifications .....	7
Second echelon operations .....	8
Echelon break-down of maintenance .....	9

**6. DESCRIPTION.**

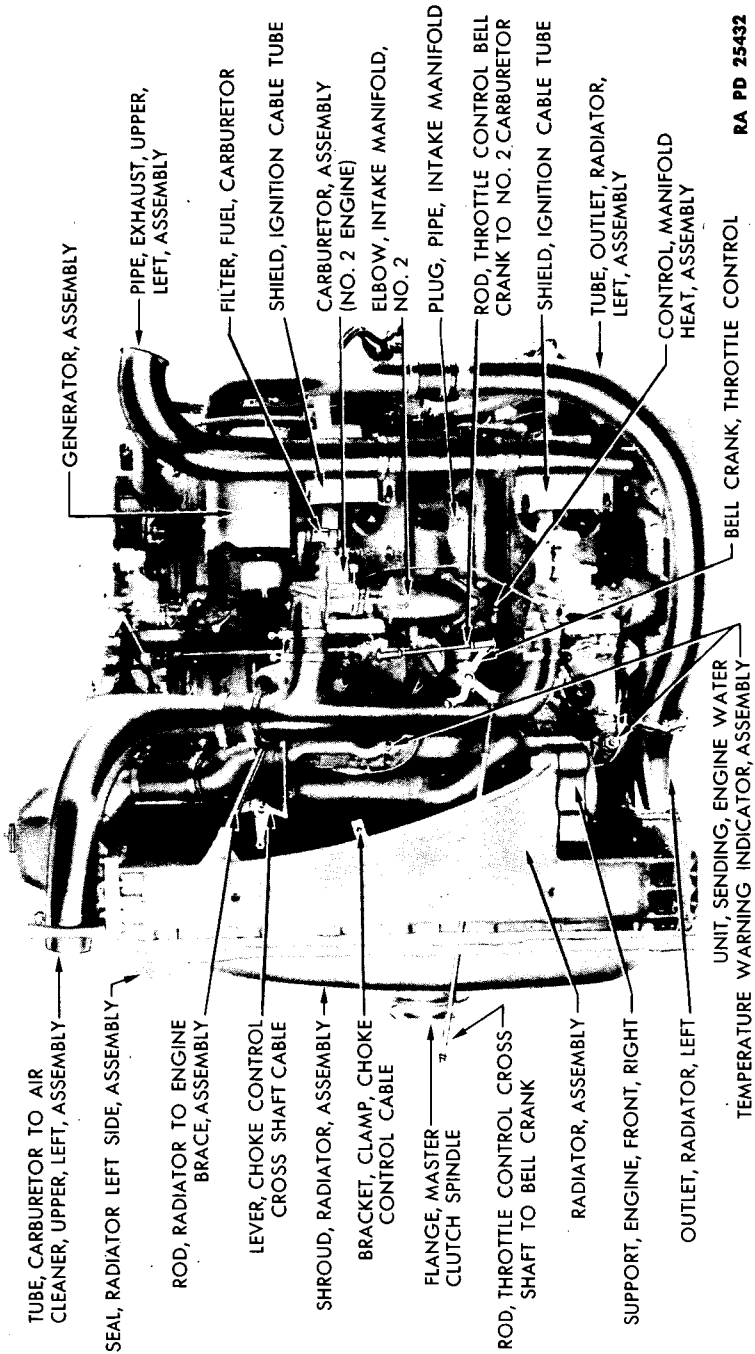
a. The fuel system consists of two fuel tanks, two manually controlled fuel shut-off valves, an automatic fuel shut-off valve, a fuel filter, a fuel pump, five carburetors, two air cleaners and the necessary fuel system lines, tubes, and controls. The fuel tanks supply the fuel that passes through the fuel filter, the fuel pump, through fuel tubes to the carburetors, then, through the intake manifolds to the cylinders. Air is supplied to the carburetors by the two air cleaners which are interconnected in such a manner that should one air cleaner be clogged, the other air cleaner will supply the air to all five of the carburetors. The fuel is preheated before entering the cylinders. While the engine is cold, exhaust gases are passed through openings in a jacket surrounding the inlet manifold, thus raising the temperature of the manifold and heating the fuel. As soon as the engine warms up, this passage is closed. This is accomplished by means of a heat control valve (fig. 1). This valve is automatic in its action, being actuated by a thermostat, and requires no attention.

**7. TABULATED DATA AND SPECIFICATIONS.**

**a. Carburetor.**

Type .....	Downdraft
Make .....	Carter
Models .....	T-A, T-B
Dimensions:	
Flange size .....	1/2 in. SAE
Throttle bore .....	1 11/16 in.
Main Venturi .....	1 11/32 in.
Float setting .....	5/64 in. below top surface of carburetor body casting
Vents:	
Outside .....	None
Inside .....	Balance vent tube 0.218 in. inside diameter
Fuel intake needle .....	Triangular, horizontal, No. 48 drill

**ORDNANCE MAINTENANCE—POWER UNIT ACCESSORIES  
FOR MEDIUM TANKS M3A4 AND M4A4**



RA PD 25432

**Figure 1—M3A4 and M4A4 (Multiple Water Pump Type) Power Unit—Left Side**

## DESCRIPTION OF SYSTEM

## Idle orifice tube:

Jet size	0.0276 in.
Idle passage air bleed in air horn, size	0.055 in.
Idle economizer in body, size	0.054 in.

## Idle ports:

Upper port; slot type, length	0.235 in.
Upper port; slot type, width	0.052 in.
Top of port	0.158 in.—0.162 in. above top edge of valve
Lower port (for idle adjustment screw), diameter	0.053 in.—0.057 in.

Set idle adjustment . . . . . For 750 rpm idling speed

Main metering jet . . . . . Calibrated to flow 312—316 cu cm per min

## Main vent:

Fuel chamber to vent tube well, diameter	0.063 in.
Invent tube plug, diameter	0.0433 in.

Vent tube side holes	1—0.0354 in. diameter, $\frac{3}{32}$ in. from end
	1—0.0354 in. diameter, $\frac{1}{8}$ in. from end
	1—0.0236 in. diameter, $\frac{1}{2}$ in. from end
	1—0.0236 in. diameter, $1\frac{1}{32}$ in. from end
	1—0.0157 in. diameter, $1\frac{15}{32}$ in. from end

Step-up jet, diameter . . . . . 0.0433 in.

## Accelerating pump:

Type	Vacuum operated
Stroke	Nonadjustable
Pump intake passage check ball seat, diameter	0.115 in.—0.120 in.
Pump discharge passage check ball seat, diameter	0.062 in.—0.065 in.
Pump discharge jet, diameter	0.0374 in.
Choke. Offset, butterfly type valve with compensating (poppet) air valve	
Choke lever, location	On carburetor air horn
Filter type	Edge

## b. Fuel Pump.

Type	Gerotor
Make	Eaton

## Direction of rotation:

Accessory shaft driven (multiple water pump type)	Clockwise
Camshaft driven (single water pump type)	Counterclockwise
Drive	$\frac{1}{2}$ in. spline, SAE aircraft standard
Pressure	4—6 $\frac{1}{2}$ lb

## Speed:

Accessory shaft driven	0.840 to 1 of crankshaft speed
Camshaft driven	Crankshaft speed

**ORDNANCE MAINTENANCE—POWER UNIT ACCESSORIES  
FOR MEDIUM TANKS M3A4 AND M4A4**

c. Fuel Filter.

Type ..... Edge  
Make ..... Zenith  
Model No. .... F 311—1¾ in.

d. Automatic Fuel Shut-off Valve.

Type ..... Solenoid  
Make ..... General Controls  
Model ..... PV-1

e. Fuel Tanks.

Capacity ..... Approximately 80 gal each  
Insulation ..... Metal foil  
Outlets ..... 2 in each tank

**8. SECOND ECHELON OPERATIONS.**

a. In view of the fact that many second echelon operations are often performed by ordnance maintenance personnel, the information is not repeated in this manual. Therefore, ordnance maintenance personnel should refer to TM 9-754, January 21, 1943, for this information.

**9. ECHELON BREAK-DOWN OF MAINTENANCE.**

a. Refer to paragraph 4.

**CHAPTER 2**  
**FUEL SYSTEM (Cont'd)**

**Section II**  
**TROUBLE SHOOTING**

	Paragraph
Carburetor .....	10
Fuel pump .....	11
Fuel filter .....	12
Automatic fuel shut-off valve .....	13
Fuel tank cap .....	14
Air cleaners .....	15

**10. CARBURETOR.**

**a. Carburetor Floods.**

<b>Possible Cause</b>	<b>Possible Remedy</b>
Needle seat worn or dirty.	Replace and adjust float level or clean.
Incorrect float level.	Adjust.
Float level pin retainer broken.	Replace (par. 18 d).

**b. Throttle Valve Does Not Open Fully.**

Valve binds in flange.	Replace governor.
Governor spring broken.	Replace governor.

**c. Lack of Fuel in Carburetors.**

Clogged carburetor fuel filter.	Remove element (par. 18 f) and clean.
Improper fuel pump on engine.	Replace with correct fuel pump (par. 24).

**d. Choke Does Not Operate Properly.**

Choke rod not properly adjusted.	Adjust (TM 9-754, Jan. 21, 1943, par. 73).
Valve will not close because of dirt.	Clean choke valve and air horn.

**e. Pump Piston Inoperative.**

Sticking pump piston.	Remove (par. 18 b) and clean.
Worn or sticky plunger.	Replace (par. 18 b) or clean.

**f. Main Metering Jet Inoperative.**

Jet clogged with dirt.	Remove (par. 18 g) and clean.
------------------------	-------------------------------

**ORDNANCE MAINTENANCE—POWER UNIT ACCESSORIES  
FOR MEDIUM TANKS M3A4 AND M4A4**

**11. FUEL PUMP.**

**a. Pressure Drops.**

<i>Possible Cause</i>	<i>Possible Remedy</i>
Pressure relief valve spring broken.	Replace (par. 26 d).
Primer or bearing pad worn.	Replace (par. 26 d).

**b. Leaks.**

Damaged gaskets.	Replace.
Loose connection.	Tighten.

**12. FUEL FILTER.**

**a. Leaks.**

Damaged gasket.	Replace.
Loose connections.	Tighten.

**b. Excessive Dirt Reaching Carburetor.**

Fuel filter element disk damaged.	Replace element.
Fuel filter element retaining nut loose.	Tighten.

**c. Fuel Does Not Reach Carburetor.**

Fuel filter clogged.	Remove element and clean; remove magnet from filter and blow filings off magnet.
----------------------	--

**13. AUTOMATIC FUEL SHUT-OFF VALVE.**

**a. Valve Will Not Open.**

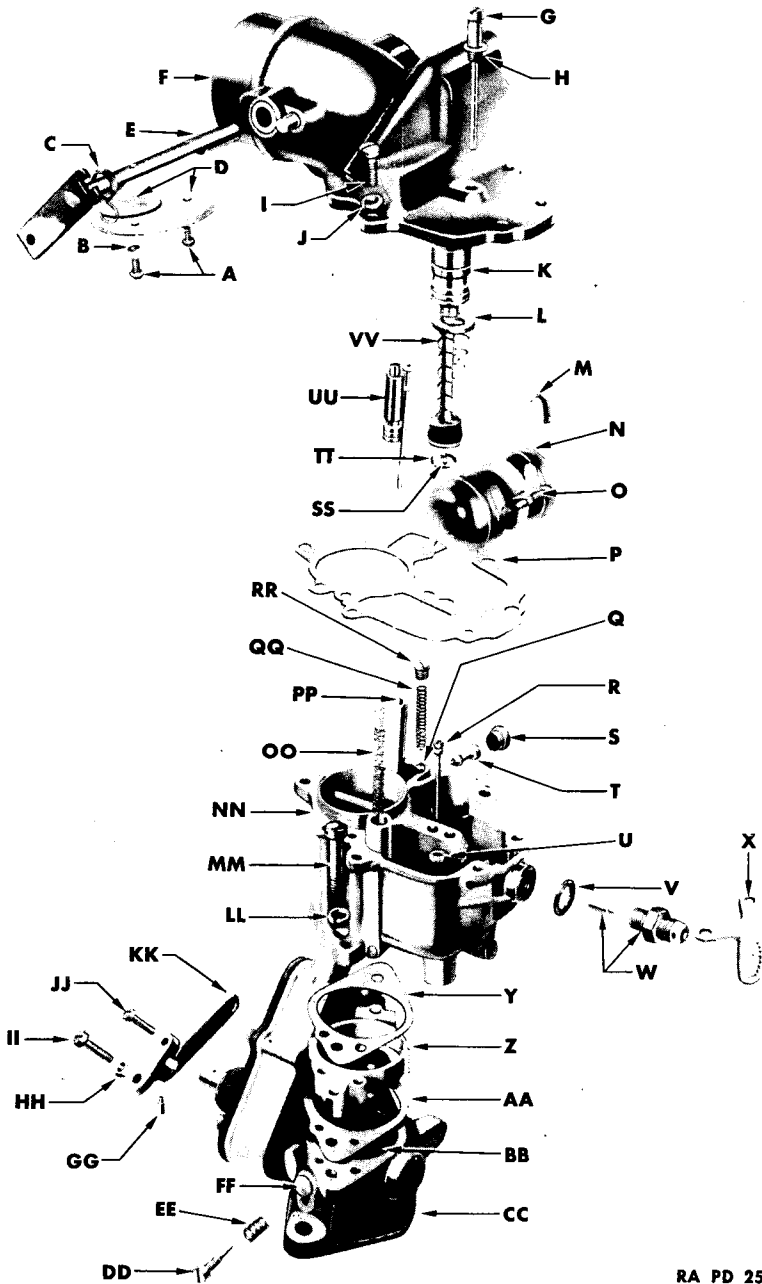
Low voltage due to discharged battery.	Check battery and recharge.
Connectors or wiring not properly connected.	Tighten connectors and check wiring.
Open circuit.	Connect ammeter in series with electric circuit to magnet assembly. If ammeter fails to register with closed circuit to magnet, replace magnet assembly (par. 32 c and e).
Grounded coil.	Using the ohmmeter method the magnet assembly should register between 25.0 and 29.0 ohms on cold coil at normal surrounding temperatures. If the readings are greater than 29 ohms or less than 25 ohms, replace the magnet assembly (par. 32 c and e).

**TROUBLE SHOOTING**

Possible Cause	Possible Remedy
Ignition switch open or inoperative.	Check contacts and ignition switch position.
<b>b. Valve Will Not Close.</b>	
Ignition switch not breaking circuit to magnet assembly.	Check contacts and ignition switch position.
Foreign matter or dirt on valve seat ring.	Disassemble and clean valve (par. 32 c and d).
Damaged armature and valve disk assembly.	Replace (par. 32 c and e).
Manual reset mechanism holding valve open.	Turn on ignition switch momentarily or push valve reset stem upward.
<b>c. External Leakage Around Magnet Flange.</b>	
Flange screws not properly tightened.	Tighten flange screws evenly.
Damaged diaphragm.	Disassemble valve and replace diaphragm (par. 32 c and e).
<b>d. External Leakage Around Reset Stem.</b>	
Damaged packing ring.	Replace (par. 32 c and e).
<b>14. FUEL TANK CAP.</b>	
<b>a. Ventholes Clogged (Cap with Eight Ventholes in Top).</b>	
Ventholes clogged with dirt.	Wipe with cloth or disassemble cap, and wash vent.
CAUTION: Do not blow the ventholes clear with air as that would only force the dirt into the vents.	
<b>b. Ventholes Clogged (Cap with Large Dust Cover on Top).</b>	
Ventholes clogged with dirt.	Disassemble cap and wash vent or remove dust cover and blow dirt out of vents.
<b>c. Cap Leaks.</b>	
Leaky float.	Replace cap.
<b>15. AIR CLEANERS.</b>	
<b>a. Air Does Not Pass Through Cleaner.</b>	
Dirt accumulated in mesh.	Clean and service air cleaner (par. 23 c).
Air leaking at air cleaner tube joints.	Tighten all hose clamps.



ORDNANCE MAINTENANCE—POWER UNIT ACCESSORIES  
FOR MEDIUM TANKS M3A4 AND M4A4



RA PD 25337

Figure 2—Parts of M3A4 Carburetor

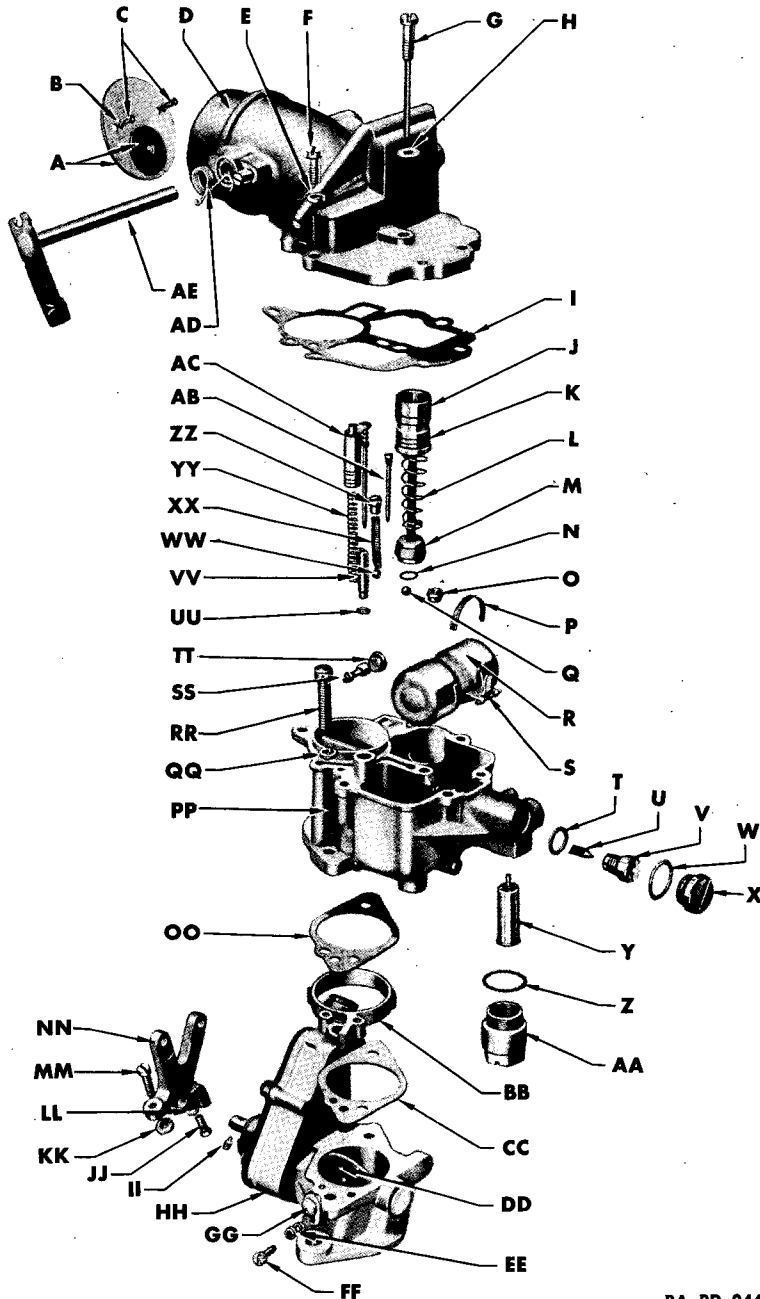
## TROUBLE SHOOTING

- A—SCREW, CARBURETOR CHOKE VALVE
- B—WASHER, LOCK, CARBURETOR CHOKE VALVE SCREW
- C—SPRING, PULL BACK, CARBURETOR CHOKE
- D—VALVE, CHOKE, CARBURETOR, ASSEMBLY
- E—LEVER, CARBURETOR CHOKE, W/SHAFT, ASSEMBLY
- F—HORN, AIR, CARBURETOR, W/PIN, ASSEMBLY
- G—TUBE, CARBURETOR MAIN VENT, W/PLUG, ASSEMBLY
- H—GASKET, CARBURETOR MAIN VENT TUBE PLUG
- I—SCREW, CARBURETOR AIR HORN TO BODY
- J—WASHER, LOCK, CARBURETOR AIR HORN ATTACHING SCREW
- K—PISTON, PUMP, CARBURETOR
- L—RETAINER, SPRING, CARBURETOR PUMP PISTON PIN
- M—RETAINER, PIN, CARBURETOR FLOAT LEVER
- N—FLOAT, CARBURETOR, W/LEVER, ASSEMBLY
- O—PIN, CARBURETOR FLOAT LEVER
- P—GASKET, BODY, CARBURETOR
- Q—BALL, CHECK, CARBURETOR PUMP DISCHARGE
- R—TUBE, CARBURETOR IDLE ORIFICE, W/PLUG, ASSEMBLY
- S—PLUG, RIVET, CARBURETOR PUMP JET
- T—JET, PUMP, CARBURETOR
- U—JET, MAIN METERING, CARBURETOR, W/GASKET, ASSEMBLY
- V—GASKET, SEAT, CARBURETOR NEEDLE
- W—NEEDLE, CARBURETOR, W/SEAT, ASSEMBLY
- X—LOCK, NEEDLE SEAT, CARBURETOR
- Y—GASKET, FLANGE, CARBURETOR BODY
- Z—INSULATOR, CARBURETOR BODY TO FLANGE AND GOVERNOR
- AA—GASKET, CARBURETOR FLANGE
- BB—VALVE, THROTTLE, CARBURETOR
- CC—FLANGE, CARBURETOR, W/GOVERNOR, ASSEMBLY
- DD—SCREW, ADJUSTMENT, CARBURETOR IDLE
- EE—SPRING, CARBURETOR IDLE ADJUSTMENT SCREW
- FF—PLUG, CARBURETOR IDLE PORT
- GG—SCREW, CARBURETOR THROTTLE LEVER
- HH—NUT, LOCK, CARBURETOR THROTTLE LEVER ADJUSTING SCREW
- II—SCREW—ADJUSTING, CARBURETOR THROTTLE LEVER
- JJ—SCREW, CLAMP, CARBURETOR THROTTLE LEVER
- KK—LEVER, CARBURETOR THROTTLE, ASSEMBLY
- LL—WASHER, LOCK, CARBURETOR BODY FLANGE ATTACHING SCREW
- MM—SCREW, ATTACHING, CARBURETOR BODY FLANGE
- NN—BODY, CARBURETOR
- OO—SPRING, CARBURETOR STEP-UP PISTON
- PP—JET, CARBURETOR STEP-UP, W/GASKET, ASSEMBLY
- QQ—SPRING, CHECK, CARBURETOR PUMP
- RR—PLUG, CARBURETOR PUMP DISCHARGE PASSAGE
- SS—BALL, CHECK, CARBURETOR PUMP INTAKE
- TT—RING, RETAINER, CARBURETOR PUMP INTAKE CHECK BALL
- UU—PISTON, STEP-UP, W/PLATE AND ROD, ASSEMBLY
- VV—SPRING, CARBURETOR PUMP PISTON PIN

RA PD 25337B

**Legend for Figure 2—Parts of M3A4 Carburetor**

ORDNANCE MAINTENANCE—POWER UNIT ACCESSORIES  
FOR MEDIUM TANKS M3A4 AND M4A4



RA PD 24489

Figure 3—Parts of M4A4 Carburetor

**TROUBLE SHOOTING**

**A**—VALVE, CHOKE, CARBURETOR, ASSEMBLY  
**B**—WASHER, LOCK, CARBURETOR CHOKE VALVE SCREW  
**C**—SCREW, CARBURETOR CHOKE VALVE  
**D**—HORN, AIR, CARBURETOR, W/PIN, ASSEMBLY  
**E**—WASHER, LOCK, CARBURETOR AIR HORN TO BODY SCREW  
**F**—SCREW, CARBURETOR AIR HORN TO BODY  
**G**—TUBE, CARBURETOR MAIN VENT, W/PLUG, ASSEMBLY  
**H**—GASKET, CARBURETOR MAIN VENT TUBE PLUG  
**I**—GASKET, CARBURETOR BODY  
**J**—PISTON, PUMP, CARBURETOR  
**K**—RETAINER, SPRING, CARBURETOR PUMP PISTON PIN  
**L**—SPRING, CARBURETOR PUMP PISTON PIN  
**M**—PLUNGER, CARBURETOR PUMP, W/ROD, ASSEMBLY  
**N**—RING, RETAINER, CARBURETOR PUMP INTAKE CHECK BALL  
**O**—JET, MAIN METERING, CARBURETOR, W/GASKET, ASSEMBLY  
**P**—RETAINER, PIN, CARBURETOR FLOAT LEVER  
**Q**—BALL, CHECK, CARBURETOR PUMP INTAKE  
**R**—FLOAT, CARBURETOR, W/LEVER, ASSEMBLY  
**S**—PIN, CARBURETOR FLOAT LEVER  
**T**—GASKET, SEAT, CARBURETOR NEEDLE  
**U**—NEEDLE, CARBURETOR  
**V**—SEAT, NEEDLE, CARBURETOR  
**W**—GASKET, PLUG, CARBURETOR NEEDLE SEAT PASSAGE  
**X**—PLUG, PASSAGE, CARBURETOR NEEDLE SEAT  
**Y**—ELEMENT, CARBURETOR FILTER  
**Z**—GASKET, CARBURETOR FILTER BODY PLUG  
**AA**—PLUG, CARBURETOR FILTER BODY  
**BB**—INSULATOR, CARBURETOR BODY TO FLANGE AND GOVERNOR  
**CC**—GASKET, CARBURETOR FLANGE  
**DD**—VALVE, THROTTLE, CARBURETOR  
**EE**—SPRING, CARBURETOR IDLE ADJUSTMENT SCREW  
**FF**—SCREW, ADJUSTMENT, CARBURETOR IDLE  
**GG**—PLUG, CARBURETOR IDLE PORT  
**HH**—FLANGE, CARBURETOR, W/GOVERNOR, ASSEMBLY  
**II**—SCREW, CARBURETOR THROTTLE LEVER  
**JJ**—SCREW, CLAMP, CARBURETOR THROTTLE LEVER  
**KK**—NUT, LOCK, CARBURETOR THROTTLE LEVER ADJUSTING SCREW  
**LL**—WASHER, LOCK, CARBURETOR THROTTLE LEVER CLAMP SCREW  
**MM**—SCREW, ADJUSTING, CARBURETOR THROTTLE LEVER  
**NN**—LEVER, THROTTLE, CARBURETOR, ASSEMBLY  
**OO**—GASKET, FLANGE, CARBURETOR BODY  
**PP**—BODY, CARBURETOR  
**QQ**—WASHER, LOCK, CARBURETOR BODY FLANGE ATTACHING SCREW  
**RR**—SCREW, ATTACHING, CARBURETOR BODY FLANGE  
**SS**—JET, PUMP, CARBURETOR  
**TT**—PLUG, RIVET, CARBURETOR PUMP JET  
**UU**—GASKET, CARBURETOR STEP-UP JET  
**VV**—JET, STEP-UP, CARBURETOR  
**WW**—BALL, CHECK, CARBURETOR PUMP DISCHARGE  
**XX**—SPRING, CHECK, CARBURETOR PUMP  
**YY**—SPRING, CARBURETOR STEP-UP PISTON  
**ZZ**—PLUG, CARBURETOR PUMP DISCHARGE PASSAGE  
**AB**—TUBE, CARBURETOR IDLE ORIFICE, W/PLUG, ASSEMBLY  
**AC**—PISTON, STEP-UP, W/PLATE AND ROD, ASSEMBLY  
**AD**—SPRING, PULL-BACK, CARBURETOR CHOKE  
**AE**—LEVER, CARBURETOR CHOKE, W/SHAFT, ASSEMBLY

RA PD 24489B

**Legend for Figure 3—Parts of M4A4 Carburetor**

**ORDNANCE MAINTENANCE—POWER UNIT ACCESSORIES  
FOR MEDIUM TANKS M3A4 AND M4A4**

**Chapter II  
FUEL SYSTEM (Cont'd)**

**Section III  
CARBURETOR**

	Paragraph
Description .....	16
Removal .....	17
Disassembly .....	18
Inspection and cleaning of parts .....	19
Assembly .....	20
Installation .....	21
Governor .....	22
Carburetor air cleaners .....	23

**16. DESCRIPTION.**

a. The carburetors (figs. 2 and 3) are of the conventional downdraft type except for external differences such as the angle air horn, the 90-degree elbow entrance that forms an integral part of the assembly, and the built-in velocity governor. The five carburetors that supply fuel to the engines are the same except for differences in shape and location of the choke and throttle levers. All five carburetors are controlled by one set of controls (figs. 9, 10, 11, and 12). The operation of the carburetor is maintained through five circuits, namely, float circuit, low speed or idling circuit, high speed circuit, pump circuit, and choke circuit.

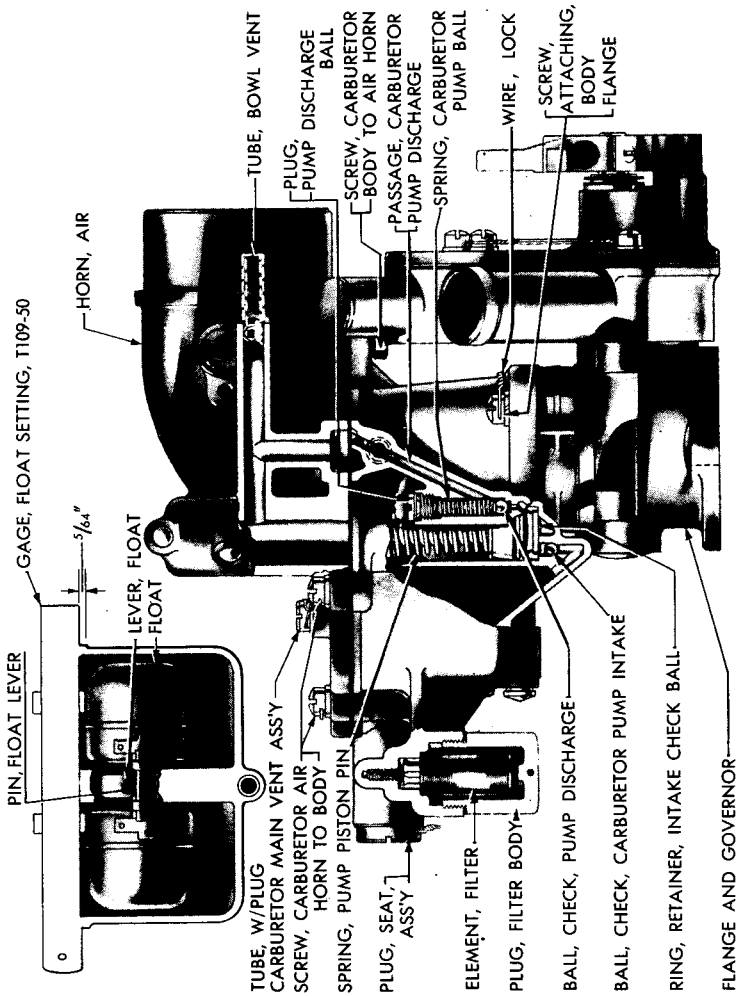
**b. Float Circuit (fig. 4).**

(1) The float circuit consists of the carburetor body, float, float pin, and needle and seat assembly. Because the body has a center section (that acts as a baffle to prevent the splashing of fuel in the body), the float is divided into two sections. The body vent leads to the accelerating pump jet to supply relief air to the pump jet and prevent pull-over at constant throttle (fig. 4). The float level adjustment controls the amount of reserve fuel in the carburetor body.

**c. Idling Circuit (fig. 5).**

(1) All fuel for the idling operation is supplied through the main metering jet (fig. 6). Fuel from the float chamber flows down through the main metering jet to the main metering well, and, for idling, is drawn up from the well, through the calibrated idle orifice tube assembly and through the cross passage (fig. 5). NOTE: The central part of the

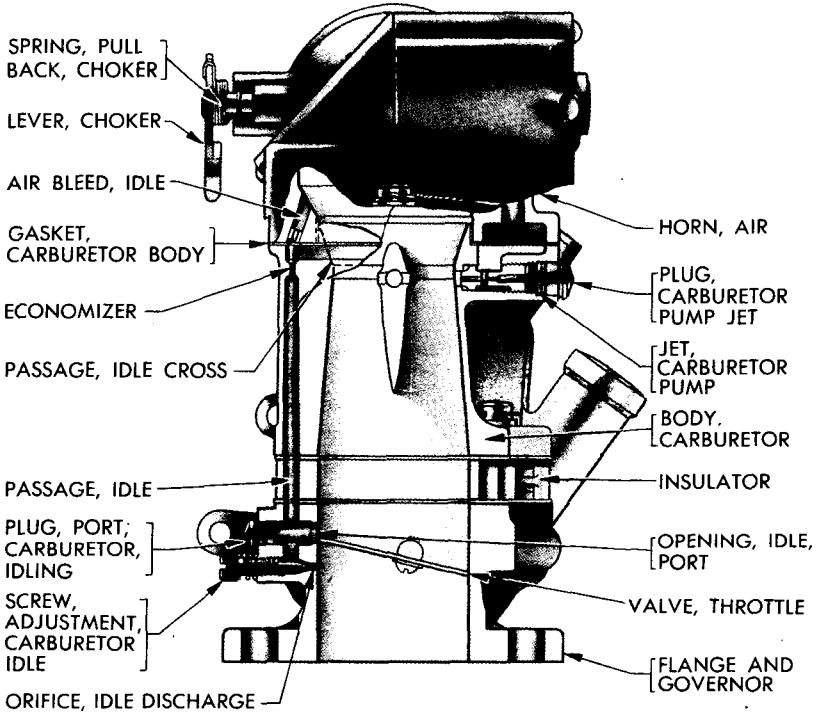
**CARBURETOR**



RA PD 25254

**Figure 4—Carburetor Float Circuit**

**ORDNANCE MAINTENANCE—POWER UNIT ACCESSORIES  
FOR MEDIUM TANKS M3A4 AND M4A4**



RA PD 25255

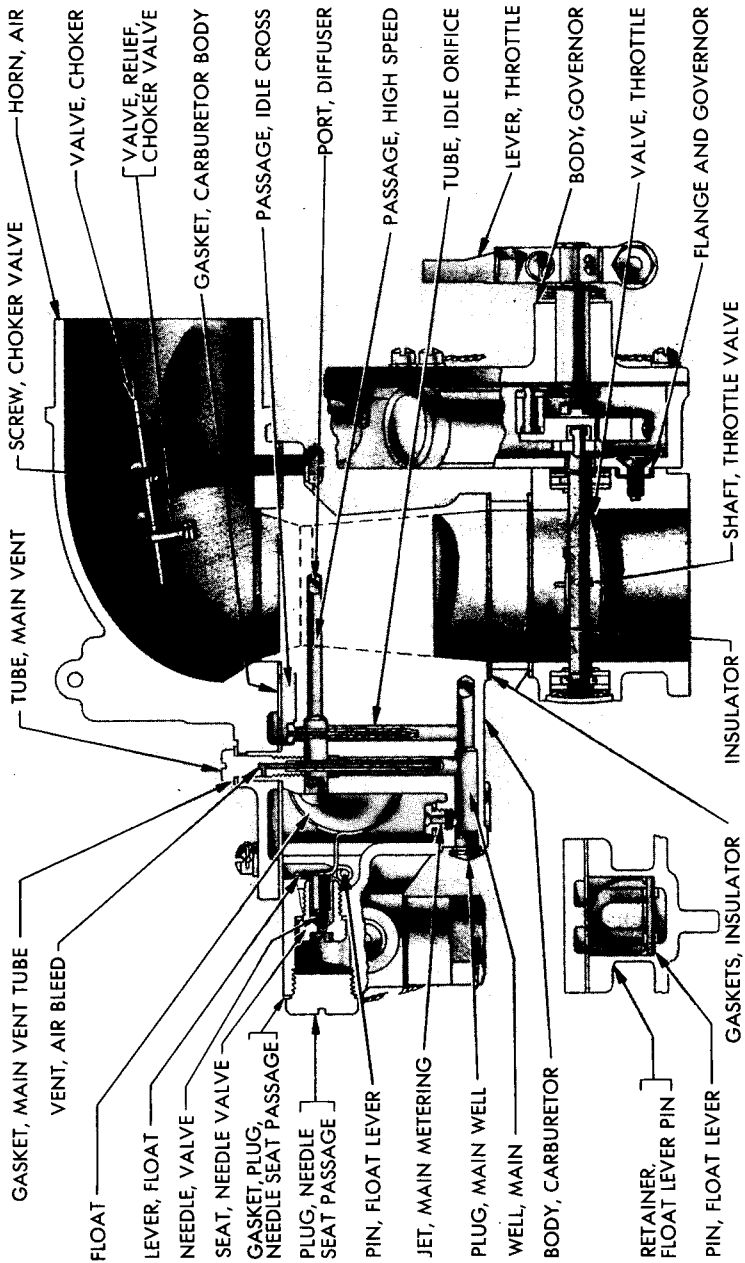
**Figure 5—Carburetor Idling Circuit**

body gasket forms the upper side of the cross passage and must be air-tight at all times to prevent a lean low speed condition. The idle passage air bleed is a small opening from the air horn directly above the economizer. It measures the air for the low speed circuit. The air mixes with the fuel at that point and the mixture is carried down through the economizer and through the idle passage (fig. 5) by the idle adjusting screw and the discharge orifice. The idle adjusting screw and the idle discharge orifice are located near the throttle valve (fig. 5). The throttle valve is almost closed at idling speed, creating a very high suction at the edge of the valve.

**d. High Speed Circuit (fig. 6).**

(1) As the throttle valve is opened (fig. 6), fuel from the float chamber flows down through the main metering jet into the metering well and up around the main vent tube assembly across the high speed passage (which is part of the carburetor body) where it mixes, at the diffuser ports, with the air being drawn through the air horn (fig. 6). **CAUTION:** The main vent tube assembly is installed in the vertical

CARBURETOR



RA PD 25253

Figure 6—Carburetor High Speed Circuit



**ORDNANCE MAINTENANCE—POWER UNIT ACCESSORIES  
FOR MEDIUM TANKS M3A4 AND M4A4**

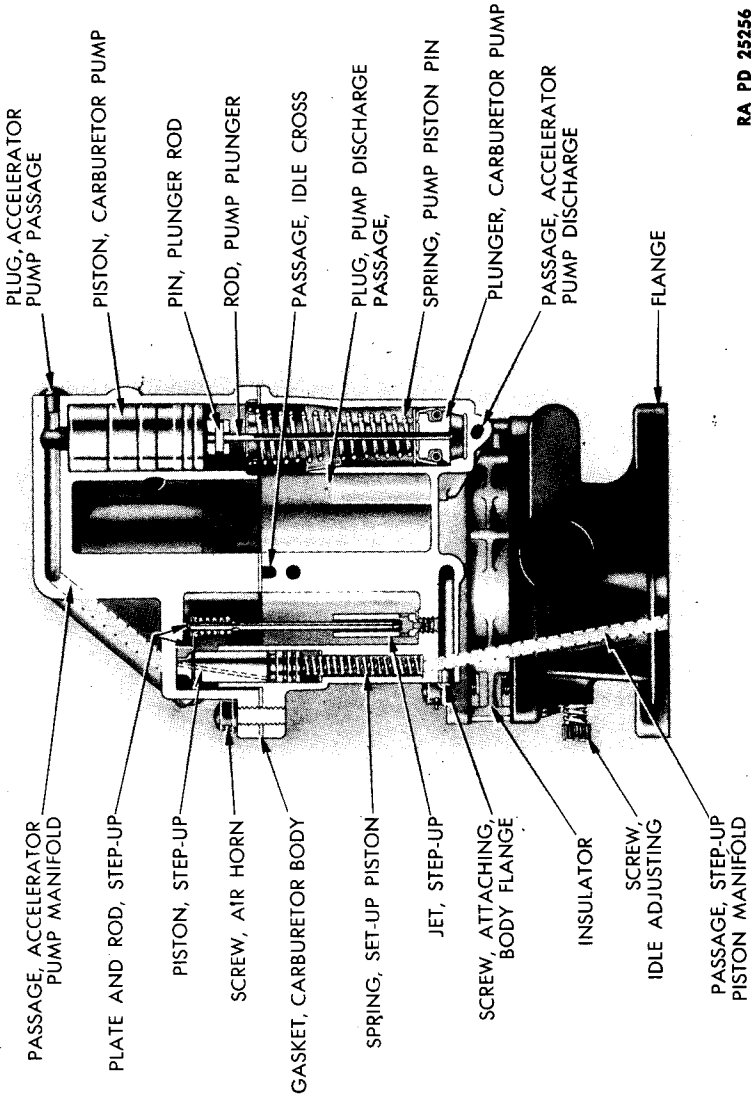
position through the carburetor air horn, and the head of the tube seals the upper surface of the body cover. It is important that no leaks occur at that location as a leaky condition would allow air to bleed into the body and around the threads to the high speed passage, affecting the entire high speed range (fig. 6). Air from the carburetor body is bled through a small hole inside the body cover to the main vent tube assembly, then downward through the tube and out through the side holes into the vertical column of fuel that has been metered by the main metering jet into the bottom of the carburetor body (fig. 6). Under quick acceleration or heavy load mixture requirements, more fuel is required to maintain the correct mixture for proper engine performance. This extra fuel supply is controlled by a vacuum step-up system which is operated by the intake manifold vacuum through a passage in the carburetor body that connects the step-up piston and the intake manifold. To seal the carburetor flange to the intake manifold and not obstruct the step-up piston vacuum passage, a specially cut gasket is used. This gasket is notched out and forms the connection between the intake manifold and the passage in the carburetor.

(2) When the engine is idling, the throttle is closed and the vacuum in the intake manifold is high. This high vacuum is maintained through the step-up piston manifold passage to the under side of the step-up piston (fig. 7). Atmospheric pressure bearing down on the step-up piston forces the piston down against the pressure of the step-up piston spring. As the step-up piston is connected to the rod assembly, and the lower end of the rod is a needle valve, the piston being forced down will cause the rod to seal in the step-up piston jet and shut off the fuel flowing from the carburetor body into the main metering well, so that the only fuel supplied is through the main metering jet (fig. 6). When the throttle valve is opened quickly, through quick acceleration or heavy load requirements, the vacuum in the intake manifold will drop, reducing the air pressure on top of the step-up piston and allowing the step-up piston spring to force the piston up. This will allow the rod of the step-up piston jet to raise and open the jet so that fuel can flow from the carburetor body through the step-up jet and into the main metering well with the fuel from the main metering jet. This will allow enough fuel to take care of engine operation under quick acceleration or heavy load requirements. **CAUTION:** If the vacuum step-up piston spring shows signs of mutilation or if there is any doubt about its operating correctly, it should be replaced.

**e. Pump Circuit (fig. 7).**

(1) A combination vacuum and spring-operated accelerator pump is included in the pump circuit, vacuum for the intake of the fuel into

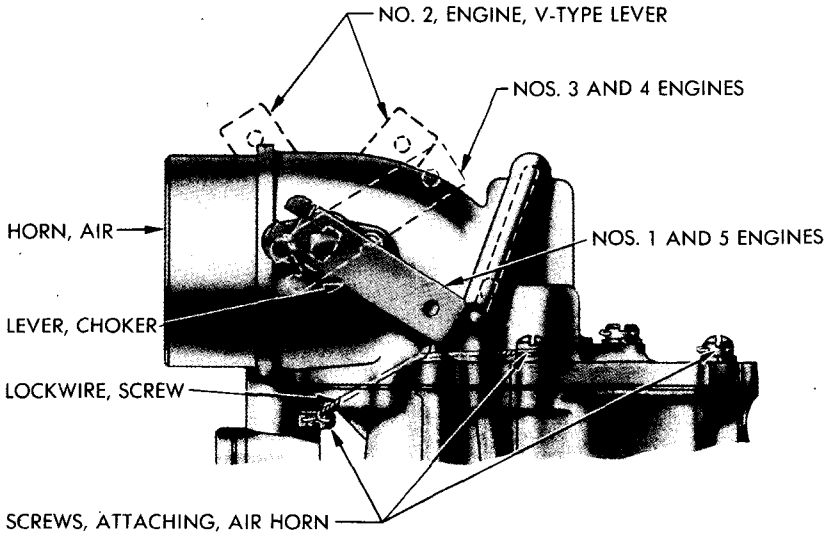
**CARBURETOR**



**Figure 7 — Carburetor Pump Circuit**

RA PD 25256

**ORDNANCE MAINTENANCE—POWER UNIT ACCESSORIES  
FOR MEDIUM TANKS M3A4 AND M4A4**



RA PD 25252

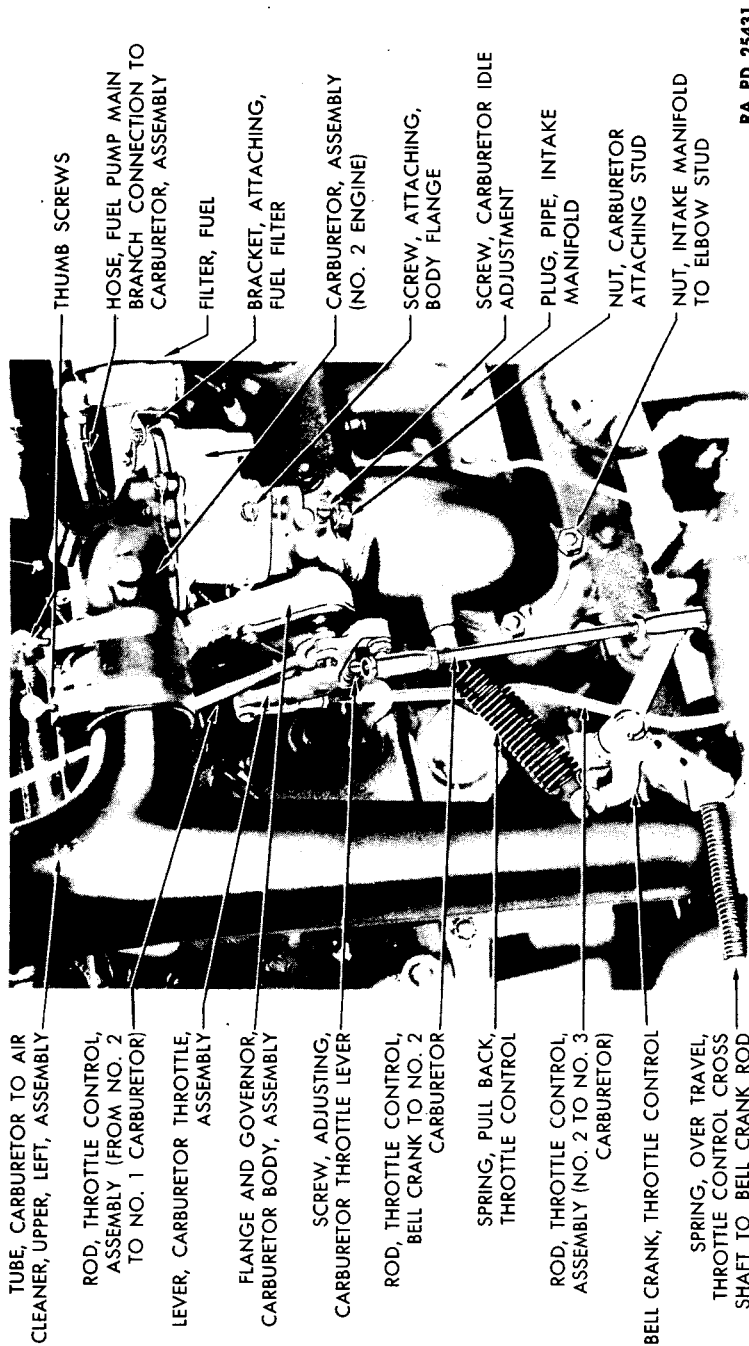
**Figure 8—Carburetor Choke Circuit**

the pump and spring load for the discharge. When the engine is started, a vacuum is formed in the intake manifold and maintained in the pump manifold passage (fig. 7) which is in the body of the carburetor and connects the pump piston with the intake manifold. Vacuum on the top of the piston and air pressure on the bottom force the piston up into the cylinder against the pressure of the pump spring. This upward movement of the piston raises the pump plunger, allowing the fuel to flow from the carburetor body through the pump inlet and into the pump cylinder (fig. 4). On quick acceleration, the vacuum in the intake manifold drops and allows the pump spring to overcome the air pressure on the pump piston and to push the pump plunger down. This action exerts pressure on the fuel, closing the pump inlet ball check, opening the pump discharge ball check and forcing the fuel out through the pump discharge jet into the air horn (fig. 5) of the carburetor. Here the fuel mixes with the air to form a mixture for quick acceleration of the engine.

**f. Choke Circuit (fig. 8).**

(1) The choke circuit consists of a butterfly valve in the air horn of the carburetor (fig. 6). When this valve is closed manually, by operating the choke control lever, the valve prevents the air from entering the carburetor, while the throttle valve remains partly open, maintaining the intake manifold vacuum up in the carburetor so that a very

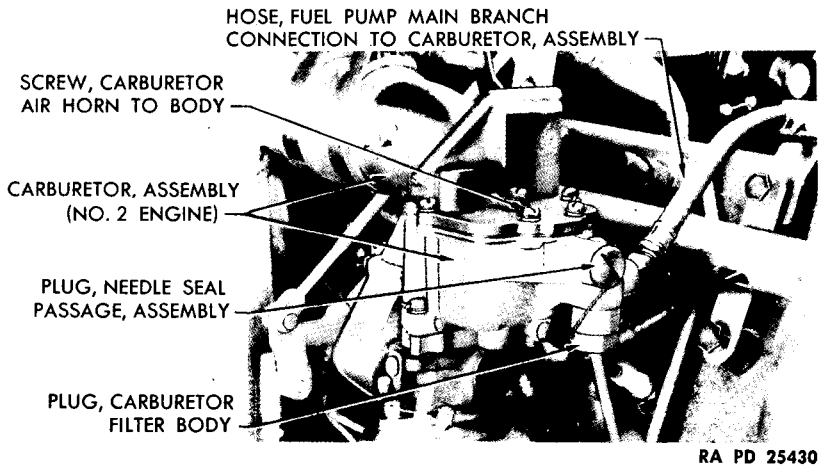
CARBURETOR



RA PD 25431

Figure 9—No. 2 Carburetor and Controls—Removable Filter

**ORDNANCE MAINTENANCE—POWER UNIT ACCESSORIES  
FOR MEDIUM TANKS M3A4 AND M4A4**



RA PD 25430

**Figure 10—Carburetor—Integral Type of Filter**

rich mixture of fuel will enter the engine for cold engine starting. To prevent flooding of the carburetor if the choke valve is closed while the engine is running, a relief valve is located in the choke valve.

**17. REMOVAL.**

a. Refer to TM 9-754, January 21, 1943 (par. 71 b), for removal procedure.

**18. DISASSEMBLY.**

- CHISEL, forked, small
- DRIFT, small
- FILE, mill, fine
- HAMMER, ball peen, 1/2-lb
- PLIERS, long, thin nosed
- PLIERS, side cutting
- PUNCH, center

- SCREWDRIVER
- WRENCH, 9/16-in.
- WRENCH, open-end, 1 3/16-in.
- WRENCH, open-end, 1-in.
- WRENCH, socket, main metering jet

a. **Remove Carburetor Air Horn** (figs. 2 and 3).

- PLIERS, side cutting
- SCREWDRIVER

Remove the lock wires from the four air horn to carburetor body screws, from the body to air horn screw, and from the main vent tube with side cutting pliers. Remove the five screws and the main vent tube with a screwdriver. On Tank M3A4 carburetors and on Tank M4A4 carburetors up to, and including, power unit serial number M4A4-2304, remove the needle seat lock. Lift the air horn assembly off the

**CARBURETOR**

carburetor and remove the pump piston and plunger assembly from the air horn.

**b. Disassemble Carburetor Pump Piston and Plunger Assembly.**

**DRIFT**, small

**HAMMER**

Drive out the pin that locks the pump piston to the plunger rod, using a small drift and a hammer. Separate the rod and plunger from the piston and remove the spring retainer and spring from the rod.

**c. Remove and Disassemble Choke Valve.**

**FILE**, mill, fine

**PUNCH**, prick

**HAMMER**

**SCREWDRIVER**

**PLIERS**

Remove the two screws that hold the choke valve to the shaft, using a small screwdriver, and remove the valve from the air horn. Remove the pull-back spring from the pin and from the choke lever with pliers, and remove the choke lever and shaft from the air horn. Mark the choke lever and the shaft with a prick punch so that they can be properly aligned when they are reassembled. File the sides of the choke shaft where the shaft is peened over the choke lever, using a small fine mill file, and remove the lever from the shaft.

**d. Remove Float (fig. 6).**

Lift out the float lever pin retainer and remove the float and pin from the carburetor body. Remove the float lever pin from the float lever and remove the body gasket from the carburetor body.

**e. Remove Carburetor Needle and Seat (fig. 6).**

**PLIERS**, side cutting

**WRENCH**,  $\frac{1}{16}$ -in.

**SCREWDRIVER**, small

(1) ON M3A4 POWER UNITS AND ON M4A4 POWER UNITS UP TO, AND INCLUDING, POWER UNIT SERIAL NUMBER M4A4-2304.

Turn the seat counterclockwise with a  $\frac{1}{16}$ -inch wrench and remove the seat, seat gasket, and needle from the carburetor body.

(2) ON POWER UNITS M4A4-2305, AND ABOVE.

Remove the lock wire from the needle seat passage plug with side cutting pliers. Turn the needle seat passage plug counterclockwise with a small screwdriver and remove the plug and plug gasket. Turn the needle seat counterclockwise with the screwdriver and remove the seat, seat gasket, and needle from the carburetor body.

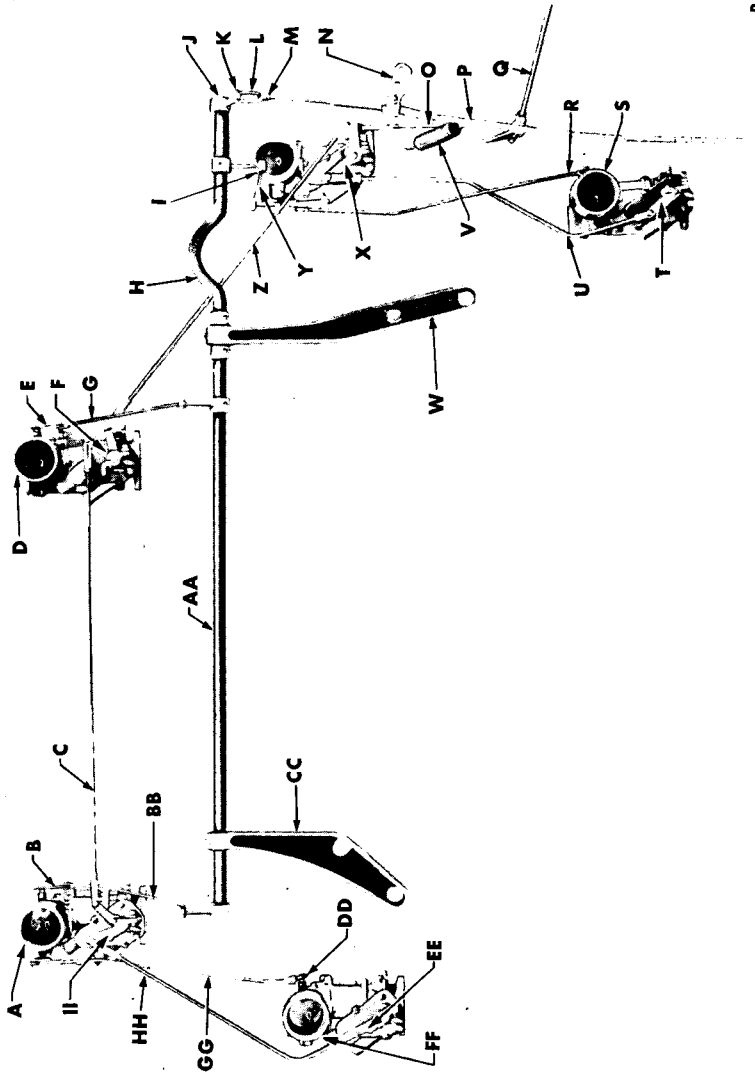
**f. Remove Fuel Filter Element (fig. 10).**

**PLIERS**, side cutting

**WRENCH**, open-end,  $1\frac{3}{16}$ -in.

Remove the lock wire from the fuel filter plug with side cutting pliers. Turn the plug counterclockwise with a  $1\frac{3}{16}$ -inch open-end wrench; re-

ORDNANCE MAINTENANCE—POWER UNIT ACCESSORIES  
FOR MEDIUM TANKS M3A4 AND M4A4



RA PD 25590

Figure 11—Carburetors and Controls

CARBURETOR

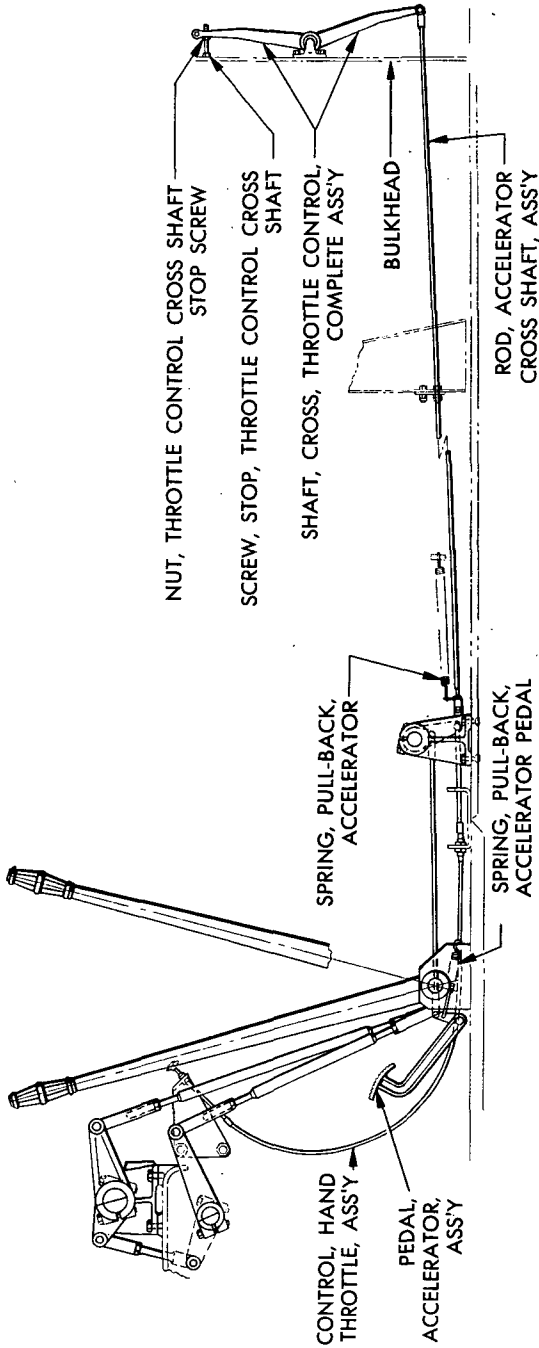
- A—CARBURETOR, ASSEMBLY (NO. 5 ENGINE)
- B—LEVER, CARBURETOR CHOKE, W/SHAFT, ASSEMBLY
- C—ROD, THROTTLE CONTROL (FROM NO. 1 TO NO. 5 CARBURETOR)
- D—CARBURETOR, ASSEMBLY (NO. 1 ENGINE)
- E—LEVER, CARBURETOR CHOKE, W/SHAFT, ASSEMBLY
- F—LEVER, CARBURETOR, ASSEMBLY
- G—ROD, CHOKE, ASSEMBLY (FOR NO. 1 CARBURETOR)
- H—SHAFT, CROSS, CHOKE CONTROL, ASSEMBLY
- I—CARBURETOR, ASSEMBLY (NO. 2 ENGINE)
- J—LEVER, CABLE, CHOKE CONTROL CROSS SHAFT
- K—PIN, CLEVIS, CHOKE CONTROL CROSS SHAFT CABLE
- L—YOKE, ADJUSTABLE, CHOKE ROD
- M—NUT, CHOKE ROD YOKE
- N—BRACKET, CLAMP, CHOKE CONTROL CROSS SHAFT CABLE
- O—ROD, THROTTLE CONTROL BELL CRANK TO NO. 2 CARBURETOR
- P—CABLE, CHOKE CONTROL, ASSEMBLY
- Q—ROD, THROTTLE CONTROL CROSS SHAFT TO BELL CRANK
- R—ROD, CHOKE, ASSEMBLY (FROM NO. 2 TO NO. 3 CARBURETOR)
- S—CARBURETOR, ASSEMBLY (NO. 3 ENGINE)
- T—LEVER, CARBURETOR THROTTLE, ASSEMBLY
- U—ROD, THROTTLE, ASSEMBLY (FROM NO. 2 TO NO. 3 CARBURETOR)
- V—SPRING, PULL-BACK, THROTTLE CONTROL
- W—BRACKET, CROSS SHAFT, CHOKE CONTROL, LEFT
- X—LEVER, CARBURETOR THROTTLE, ASSEMBLY
- Y—ROD, CHOKE, ASSEMBLY (FOR NO. 2 CARBURETOR)
- Z—ROD, THROTTLE CONTROL, ASSEMBLY (FROM NO. 1 TO NO. 2 CARBURETOR)
- AA—SHAFT, CROSS, CHOKE CONTROL
- BB—ROD, CHOKE, ASSEMBLY (FOR NO. 5 CARBURETOR)
- CC—BRACKET, CROSS SHAFT, CHOKE CONTROL, RIGHT
- DD—LEVER, CARBURETOR CHOKE, W/SHAFT, ASSEMBLY
- EE—LEVER, CARBURETOR THROTTLE, ASSEMBLY
- FF—CARBURETOR, ASSEMBLY (NO. 4 ENGINE)
- GG—ROD, CHOKE, ASSEMBLY (FROM NO. 5 TO NO. 4 CARBURETOR)
- HH—ROD, THROTTLE CONTROL, ASSEMBLY (FROM NO. 4 TO NO. 5 CARBURETOR)
- II—LEVER, CARBURETOR THROTTLE, ASSEMBLY

RA PD 25590B

Legend for Figure 11—Carburetors



ORDNANCE MAINTENANCE—POWER UNIT ACCESSORIES  
FOR MEDIUM TANKS M3A4 AND M4A4



RA PD 25259

Figure 12—Accelerator and Hand Throttle Controls

**CARBURETOR**

move the plug and plug gasket and unscrew the filter element from the carburetor body.

**g. Remove Main Metering Jet (fig. 6).**

**WRENCH**, socket,  $\frac{5}{16}$ -in.

Turn the main metering jet counterclockwise with  $\frac{5}{16}$ -inch socket wrench (*note the number of the jet as it must be replaced with a jet bearing the same number*) and remove the jet from the carburetor body.

**h. Remove Step-up Piston, Spring, and Jet (fig. 7).**

**SCREWDRIVER**

Remove the step-up piston, plate and rod assembly (do not disassemble). Remove the step-up piston spring. **CAUTION:** Do not distort the spring by stretching or compressing. Turn the step-up jet counterclockwise with a screwdriver and remove the jet and the gasket.

**i. Remove Idle Orifice Tube (fig. 6).**

**SCREWDRIVER**

Turn the idle orifice tube counterclockwise with a screwdriver and remove the tube from the carburetor body.

**j. Remove Discharge and Intake Check Balls (fig. 4).**

**PLIERS**, long, thin nosed

**SCREWDRIVER**

Turn the pump discharge passage plug counterclockwise with a screwdriver and remove the plug, the ball spring, and the check ball from the carburetor body. Remove the pump intake check ball retainer ring from the carburetor body with long, thin nosed pliers; tip the carburetor up and the intake check ball will fall out.

**k. Remove Carburetor Pump Jet (fig. 5).**

**CHISEL**, forked, small

**SCREWDRIVER**

Pry out the pump jet rivet plug with a small forked chisel and remove the plug. Remove the pump jet with a screwdriver.

**l. Remove Carburetor Body (fig. 4).**

**PLIERS**, side cutting

**SCREWDRIVER**

Remove the lock wire from the two carburetor body to flange screws with side cutting pliers. Turn the screws counterclockwise with a screwdriver and remove the carburetor body, insulator and flange gaskets.

**m. Remove Idle Adjustment Screw and the Idle Port Plug (fig. 5).**

**CHISEL**, forked, small

**SCREWDRIVER**

Turn the idle adjustment screw counterclockwise and remove the screw and spring from the carburetor flange. Pry out the idle port plug with a small forked chisel.

**ORDNANCE MAINTENANCE—POWER UNIT ACCESSORIES  
FOR MEDIUM TANKS M3A4 AND M4A4****19. INSPECTION AND CLEANING OF PARTS.**

a. Clean all parts with SOLVENT, dry-cleaning, and blow out with compressed air. Remove all gum deposits on the needle and seat and on the jets and orifices by soaking in solution and rubbing with a stiff bristled brush; then lay the parts on clean paper to dry. **CAUTION:** Never use a wire or drill to clean out a carburetor jet.

**20. ASSEMBLY.****DRIFT**, small**HAMMER**, ball peen, 1/2-lb**PLIERS**, long, thin nosed**PLIERS**, side cutting**SCREWDRIVER****WRENCH**, 9/16-in.**WRENCH**, open-end, 1 3/16-in.**WRENCH**, open-end, 1-in.**WRENCH**, socket, main metering jet

a. **Install Idle Port Plug and the Idle Adjustment Screw (fig. 5).**

**HAMMER****SCREWDRIVER**

Drive the idle port plug into place with a hammer. Slide the carburetor idle adjustment screw spring over the adjustment screw and install the adjustment screw and spring assembly in the carburetor flange by seating the screw lightly and then backing it off 1 1/4 turns. **NOTE:** The final adjustment of the idle adjustment screw must be made with the power unit running.

b. **Assemble Carburetor Body to Carburetor Flange (fig. 5).**

**PLIERS**, side cutting**SCREWDRIVER**

Place new carburetor flange gasket in position on the flange, place the carburetor insulator on top of the flange gasket, and lay a new carburetor body flange gasket on top of the insulator. Make sure the holes in the two gaskets and in the insulator are properly alined with the holes in the flange; place the carburetor body in position and attach the body with the two slotted head screws. Tighten the screws securely with a screwdriver and lock the screws by inserting a lock wire through the holes in the screwheads and twist the ends of the lock wire together with side cutting pliers.

c. **Install Carburetor Pump Jet and Plug (fig. 5).**

**HAMMER**, ball peen, 1/2-lb**SCREWDRIVER**

Screw the carburetor pump jet into place by turning the jet clockwise with a screwdriver. Drive a new carburetor pump jet plug into place with a ball peen hammer.

d. **Install Intake and Discharge Check Balls (fig. 4).**

**PLIERS**, long, thin nosed**SCREWDRIVER**

Drop the intake check ball into place and insert the intake check ball retainer ring in the carburetor, using a pair of long, thin nosed pliers.

## CARBURETOR

Drop the pump discharge check ball into place and insert the check ball spring in the carburetor body; then install the pump discharge passage plug turning it clockwise with a screwdriver.

**e. Install Idle Orifice Tube and Plug Assembly (fig. 6).**

**SCREWDRIVER**

Install the idle orifice tube and plug assembly. Tighten the tube and plug securely in the carburetor body by turning it clockwise with a screwdriver.

**f. Install Step-up Jet, Spring, and Piston (fig. 7).**

**SCREWDRIVER**

Using a new gasket, install the step-up jet and gasket in the carburetor body, turning the jet clockwise with a screwdriver. Install the step-up piston spring and install the step-up piston, plate and rod assembly, pressing the piston down as far as it will go, to allow the rod to seat in the step-up jet. **NOTE:** Clearance between the head of the rod and the plate will indicate that the rod is seating properly.

**g. Install Main Metering Jet (fig. 6).**

**WRENCH**, socket,  $\frac{7}{16}$ -in.

Make sure that the main metering jet is replaced with a jet bearing the same number as the jet removed from the carburetor and install the jet in the carburetor body by turning the jet clockwise with wrench.

**h. Install Carburetor Needle and Seat (fig. 6).**

**SCREWDRIVER**

**WRENCH**,  $\frac{9}{16}$ -in.

(1) ON M3A4 POWER UNITS AND ON M4A4 POWER UNITS UP TO, AND INCLUDING, POWER UNIT SERIAL NUMBER M4A4-2304 (fig. 2).

Slide a new seat gasket over the end of the seat. Insert the needle in the seat and screw the seat into the carburetor body, tightening it securely with a  $\frac{9}{16}$ -inch wrench.

(2) ON POWER UNITS M4A4-2305 AND ABOVE (fig. 3).

Slide a new seat gasket over the end of the seat. Insert the needle in the seat and screw the seat into the carburetor body, tightening it securely by turning clockwise with a screwdriver. Slide a new plug gasket over the end of the needle seat passage plug and screw the plug into the carburetor body, tightening it securely by turning clockwise with a screwdriver.

**i. Install Carburetor Filter Element on Power Units M4A4-2305 and Above.**

**PLIERS**, side cutting

**WRENCH**, open-end, 1-in.

Screw the filter element (fig. 6) into the carburetor body and tighten the element with the fingers. Slide a new gasket over the end of the filter

**ORDNANCE MAINTENANCE—POWER UNIT ACCESSORIES  
FOR MEDIUM TANKS M3A4 AND M4A4**

plug and screw the plug into the carburetor body. Tighten the plug securely by turning it clockwise with a 1-inch open-end wrench. Insert a lock wire through the holes in the needle seat passage plug and through the holes in the filter plug; twist the ends of the wire together with side cutting pliers.

**j. Install Float (fig. 6).**

**GAGE**, float level, T 109-50

Install the float lever pin in the float lever and place the float and lever assembly in position in the carburetor body, making sure that the float lever pin rests on the bottom of the groove in the body, and adjust the float level as follows: Place the float level gage across the top of the carburetor body with the prongs of the gage pointing down toward the float. If the float level is correct the prongs of the gage should just touch the top of the float. If the float level has to be raised or lowered, bend the float lever at the outer end of the lever until the prongs of the gage just touch each half of the float. **NOTE:** When the float level is correct, the top of each side of the float will be  $\frac{5}{16}$  inch from the top of the carburetor body (with the carburetor body gasket removed).

**k. Install Choke Valve.**

**HAMMER**, ball peen  
**PLIERS**

**SCREWDRIVER**

Install the choke lever on the shaft, alining the prick punch marks on lever and shaft. Peen over the end of the shaft with a ball peen hammer to secure the lever to the shaft. Slide the carburetor choke pull-back spring over the end of the shaft and insert the shaft through the hole in the carburetor air horn. With side cutting pliers, insert one end of the pull-back spring through the hole in the shaft and hook the other end of the spring over the pin on the air horn. Install the choke valve on the shaft, using the two valve attaching screws and lock washers. Tighten the screws securely by turning them clockwise with a screwdriver, then stake over the ends of the screws so that they will not back off. Work the choke lever back and forth and make sure that the valve closes and opens properly, that it does not bind in the carburetor air horn, and that the choke valve will return to the open position under the tension of the pull-back spring.

**l. Assemble Carburetor Pump Piston and Plunger.**

**DRIFT**, small  
**HAMMER**

**PUNCH**

Slide the pump piston rod spring over the end of the rod (with the large end of the spring away from the plunger). Slide the spring retainer over the end of the rod. Insert the end of the rod into the slot in the

## CARBURETOR

pump piston, alining the pinhole in the rod with the pinhole in the piston, and drive the pin into place with a hammer and a drift. Stake both ends of the pin, using a hammer and a punch.

### m. Install Carburetor Air Horn.

PLIERS, side cutting

SCREWDRIVER

Place a new carburetor body gasket in position on top of the carburetor body, making sure that the gasket lays flat and is free from wrinkles (fig. 6). Insert the carburetor pump piston into the air horn. Place the air horn and pump piston and plunger assembly in position on the carburetor body, being careful to line up the plunger properly in the cylinder so that the plunger will not be damaged (fig. 7). (On M3A4 power units and on M4A4 power units up to, and including, serial number M4A4-2304, place the needle seat lock in position (fig. 2)). Screw the five air horn cap screws into place, but do not tighten the cap screws. Slide a new gasket over the end of the main vent tube and insert the tube into the air horn. Tighten the main vent tube by turning it clockwise with a screwdriver. Tighten the four air horn to carburetor body cap screws and the body to air horn cap screw securely by turning the cap screws clockwise with a screwdriver. Insert a lock wire through the holes in the main vent tube and through the holes in two of the air horn to body cap screws, and insert another lock wire through the holes in the other two air horn to body cap screws and through the hole in the body to air horn cap screw. Twist the ends of each lock wire together with side cutting pliers.

## 21. INSTALLATION.

a. Refer to TM 9-754, January 21, 1943 (par. 71 c), for installation procedure.

## 22. GOVERNOR.

a. **Description and Function.** Each individual carburetor is equipped with a governor, mounted integrally with the carburetor flange (figs. 2 and 3). The governor is used to regulate the speed of the engine. The governor works on the principle of air velocity against an eccentric throttle valve. The cam on the throttle shaft revolves in a clockwise direction and stretches the spring as the throttle closes. The plunger, located in the opposite side of the governor housing, acts as a dash pot. The air trapped above the plunger serves as a stabilizer to prevent throttle flutter. The balancing effect between the air velocity (against the "off center" valve) and the adjustable spring (working against the cam action) allows the governor to become effective at the predetermined speed at which the engines are designed to operate. As very special equipment is required for

**ORDNANCE MAINTENANCE—POWER UNIT ACCESSORIES  
FOR MEDIUM TANKS M3A4 AND M4A4**

adjusting the governor during assembly, no information as to the disassembling or assembling of the governor is contained in this manual.

**b. Adjust Governor for Maximum Engine Speed (with Power Unit in Vehicle).**

- |   |  |
|---|--|
| <b>METER</b> , manifold vacuum checking, MTM A4-30 (5)    | <b>TOOL</b> , sealing                                |
| <b>PLIERS</b> , side cutting                              | <b>WRENCH</b> , open-end, $\frac{9}{32}$ -in.        |
| <b>SCREWDRIVER</b> , special, governor adjusting (Carter) | <b>WRENCH</b> , open-end, $\frac{7}{16}$ -in.        |
|   | <b>WRENCH</b> , special, governor adjusting (Carter) |

(1) Open the power unit compartment cover (Nos. 1, 2, 4, and 5 carburetors only (TM 9-754, January 21, 1943, par. 55 c (1))).

(2) Open the power unit compartment doors (No. 3 carburetor only (TM 9-754, January 21, 1943, par. 52 b (6))).

**(3) CHECK MANIFOLD VACUUM READINGS.**

- |   |   |
|---|---|
| <b>METER</b> , manifold vacuum checking MTM A4-30 (5) | <b>WRENCH</b> , open-end, $\frac{7}{16}$ -in. |
|---|---|

Attach, in a convenient location inside the fighting compartment, a board or panel on which are mounted five vacuum meters, graduated to read 0—30 inches of vacuum. Remove the intake manifold pipe plug from the top of each intake manifold (fig. 9) with a  $\frac{7}{16}$ -inch open-end wrench. Connect one end of a piece of tubing to this opening and connect the other end of the tubing to one of the vacuum meters. Repeat the above operation on the other four meters and manifolds. With the transmission in neutral, open the throttle to the full open position and observe the reading on each of the vacuum meters. The tachometer should show an engine speed of 3,000—3,100 revolutions per minute, and the manifold vacuum reading should be not lower than 15 inches and not higher than 20 inches on each meter. If the vacuum at any of the manifolds reads less than 15 inches or more than 20 inches at 3,000—3,100 revolutions per minute, adjust the governor on the corresponding carburetor until the correct vacuum reading is obtained.

**(4) ADJUST GOVERNOR.**

- |   |  |
|---|--|
| <b>PLIERS</b> , side cutting                              | <b>TOOL</b> , sealing                                |
| <b>SCREWDRIVER</b> , special, governor adjusting (Carter) | <b>WRENCH</b> , special, governor adjusting (Carter) |

To lower or raise the vacuum in the manifold, stop the engine and remove the lock wire and seal from the cap on the adjustment well of the corresponding carburetor with side cutting pliers, and pull the cap off with the fingers. Loosen the lock nut at the bottom of the adjustment well by turning the lock nut counterclockwise with the special hollow wrench while holding the adjusting screw stationary with the special screwdriver inserted through the hollow socket wrench. **CAUTION:** Do not remove

## CARBURETOR

the lock nut from the adjusting screw. Then turn the adjusting screw with the screwdriver one-eighth turn counterclockwise to lower the vacuum, or clockwise to raise the vacuum. Tighten the lock nut by turning it clockwise with the hollow socket wrench while holding the adjusting screw stationary with the screwdriver inserted through the socket wrench. Start the power unit, and with the throttle full open, observe the readings on the manifold vacuum checking meters. If any of the meters still show a vacuum reading below 15 inches, or above 20 inches, repeat the adjusting operation on the carburetor governor corresponding to the manifold to which that particular meter is connected until a correct vacuum reading is obtained. Install the cap on the adjustment well and insert a lock wire through the holes in the adjustment well and the cap, and through the hole in the governor cover screw located nearest the adjustment well. Twist the ends of the wire together with side cutting pliers and seal the ends of the lock wire with a seal and a sealing tool.

### (5) CHECK GOVERNOR ADJUSTMENT.

(a) Due to the fact that the power unit may fail to reach the desired top speed for reasons other than faulty governors, such as obstructions in the fuel system, partial failure of the ignition system or incorrect operation of tachometer and/or speedometer, be sure these units are functioning properly before attempting to check governor adjustment. To check tachometer reading, multiply the miles per hour registered on speedometer by 116. The tachometer can be checked at 3,100 revolutions per minute (the no-load speed) by the use of an auxiliary tachometer or another standard tachometer, if available.

(b) Operate the vehicle on a hard, level surface, in high gear, with a full open throttle and observe the speedometer and the vacuum meters. At full throttle, the vehicle speed should be approximately 25 miles per hour. If the speed falls as much as 1 mile per hour below this figure, one or more of the governors may be at fault. If governor is at fault, the corresponding vacuum meter will show a manifold vacuum several inches in excess of the vacuum readings of the other engines. The high vacuum readings should then be lowered by adjusting the governor until it is about the same as the other readings, as outlined in step (4), above. After the governor has been reset to give the same vacuum as the other at the high gear maximum road speed condition, it should be checked as outlined in (3), above, for full throttle no-load performance to make certain that the 15 to 20 inches of vacuum and 3,000—3,100 revolutions per minute requirements are still met. In the event these requirements are not met, replace governor or governor and carburetor assembly.

(c) When this governor adjustment has been made successfully, and at top speed in high gear the five manifold vacuum readings are all within an inch or two of each other; if the top speed of the vehicle is not



**ORDNANCE MAINTENANCE—POWER UNIT ACCESSORIES  
FOR MEDIUM TANKS M3A4 AND M4A4**

sufficiently high, it is possible that all governors are at fault (though this is rather unlikely).

(d) To determine whether the governors as a group are at fault, operate the vehicle at top speed in high gear and while still keeping the accelerator wide open, apply both brakes evenly to hold a straight course, and sufficiently hard to reduce the tachometer speed to 2,750 revolutions per minute. The five vacuum meters should all show readings of 4 inches or less. Any higher readings indicate that the corresponding governors should be replaced.

(e) With the power unit operating properly, disconnect the tubing and install the plugs in the top of each manifold with a  $\frac{7}{16}$ -inch open-end wrench; then remove the manifold checking meters from the fighting compartment. **CAUTION:** Do not make any adjustments on the governor other than those described in these paragraphs.

**23. CARBURETOR AIR CLEANERS.**

**a. Description.**

(1) Two carburetor air cleaners, located on fighting compartment side of the bulkhead, filter all air entering the carburetors, thus protecting the power unit from abnormal wear due to dust and dirt being drawn into the cylinders. Flexible tubes run from the air cleaners to the metal tubes that are attached to the five carburetors. The two air cleaners are interconnected in such a manner that should one of the cleaners become clogged, the other cleaner will supply air to the five carburetors.

**b. Removal.**

PAN, for SOLVENT, dry-cleaning (capacity, 10 gallons)	WRENCH, $\frac{1}{2}$ -in.
	WRENCH, $\frac{9}{16}$ -in.
PLIERS	

**(1) DISCONNECT FLEXIBLE TUBE FROM AIR CLEANER.**

PLIERS	WRENCH, $\frac{9}{16}$ -in.
--------	-----------------------------

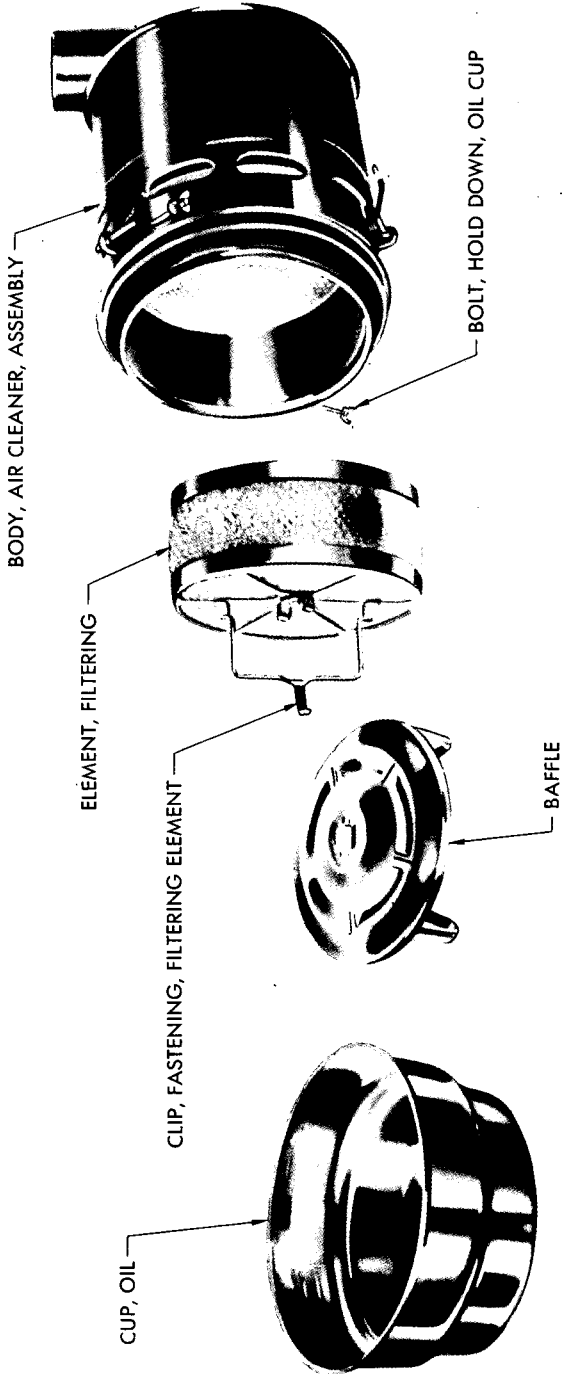
Remove the four power unit air inlet grille cap screws with a  $\frac{9}{16}$ -inch wrench and lift the grille from the side plates. Reach through the grille opening with pliers and loosen the thumbscrew on the hose clamp that secures the flexible tube to the air cleaner body. Pull the flexible tube away from the air cleaner.

**(2) REMOVE AIR CLEANER FROM BULKHEAD (fig. 63).**

WRENCH,  $\frac{1}{2}$ -in.

Remove the weight from the air cleaner mounting bracket and remove the four air cleaner to mounting bracket cap screws with a  $\frac{1}{2}$ -inch wrench. Lift the air cleaner assembly away from the bracket and remove it from the vehicle.

CARBURETOR



RA PD 25581

Figure 13—Parts of Carburetor Air Cleaner

**ORDNANCE MAINTENANCE—POWER UNIT ACCESSORIES  
FOR MEDIUM TANKS M3A4 AND M4A4****c. Clean Air Cleaner Assembly.**

PAN, for SOLVENT, dry-cleaning (capacity, 10 gallons)

Hold the cup and baffle in place with one hand and loosen the three wing nuts on the clamp bolts. Remove filtering element. Separate the cup from the cleaner body and remove for inspection of oil level. Remove the baffle from the cup by pulling up on the baffle to release the retaining clamps from the cup. Wash all parts thoroughly in SOLVENT, dry-cleaning, to remove any sediment that may have accumulated; then stand the cleaner body in a vertical position and allow it to drain thoroughly.

**d. Installation.**

WRENCH, 1/2-in.

(1) ASSEMBLE AIR CLEANER BODY TO BULKHEAD (fig. 63).

WRENCH, 1/2-in.

Place the air cleaner body in position in the bracket on the bulkhead. Place the bracket clamp in position and secure with four cap screws and lock washers. Tighten the cap screws securely with a 1/2-inch wrench.

(2) ASSEMBLE FILTERING ELEMENT, CUP, AND BAFFLE TO AIR CLEANER.

*(a) Install Filtering Element.*

Place the element in position in the opening in the cleaner body, with filter fastening clip down, and push into position inside body. Secure in place by snapping filter fastening clip onto side of cleaner body (fig. 13).

*(b) Reassemble Cup and Baffle to Cleaner Body.*

Place the baffle in position inside the cup and push down in place until clamps on bottom of baffle are in position to hold baffle. Fill cup with OIL, engine (same grade as being used in power unit), to "NORMAL OIL LEVEL" (indicated inside cup (fig. 13)). Remove old gasket from bottom of cleaner body. Place new gasket on body, position cup and baffle on bottom of body and hold in place with one hand. Secure by aligning clamp bolts so as to contact cup and tightening wing nuts. NOTE: For temperatures above 32 F, use OIL, engine, SAE 30. For temperatures below 32 F and above -10 F, use OIL, engine, SAE 10. For extremely low temperatures, use OIL, "UNIVIS" No. 40, or equivalent.

**CHAPTER 2**  
**FUEL SYSTEM—(Cont'd)**

**Section IV**  
**FUEL PUMP**

	Paragraph
Description .....	24
Removal .....	25
Disassembly .....	26
Inspection of parts .....	27
Assembly .....	28
Installation .....	29
Fuel pump drive .....	30

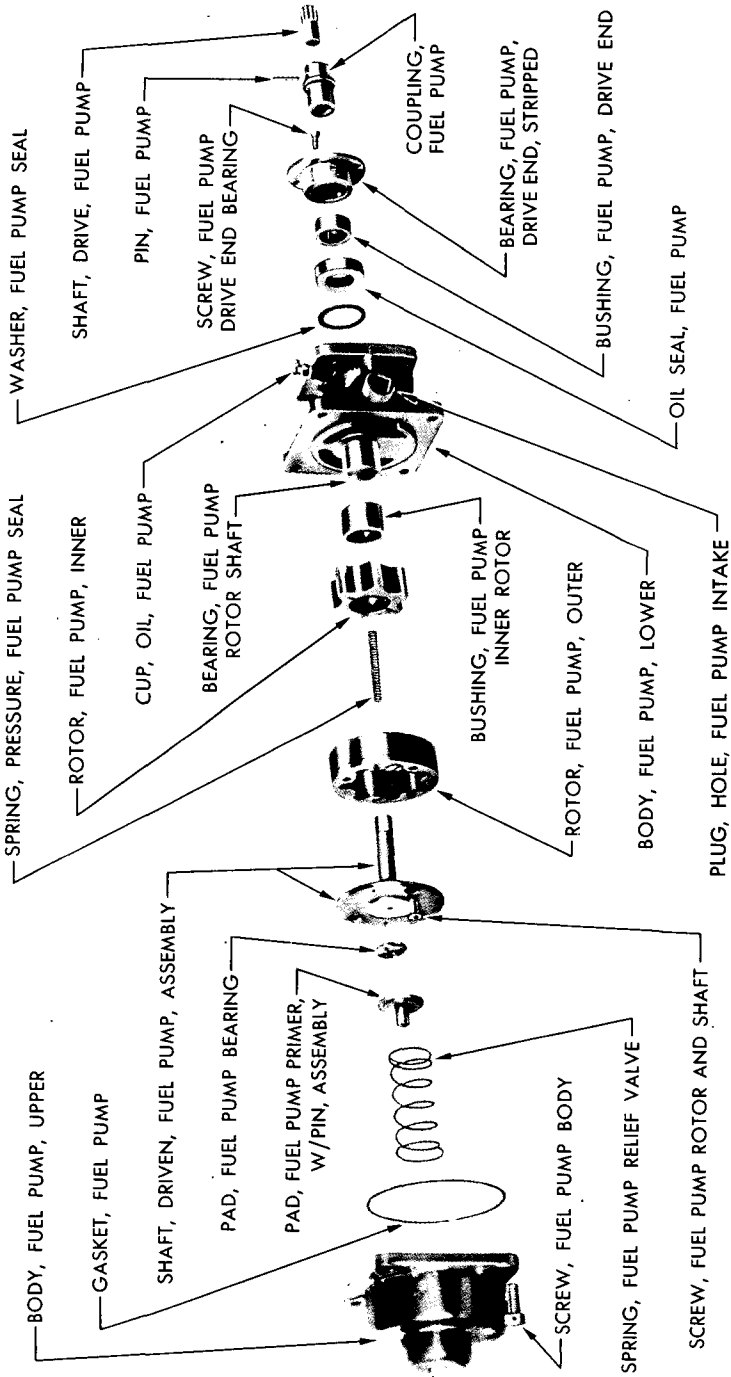
**24. DESCRIPTION.**

a. The fuel pump (fig. 14) which is of the Gerotor or internal gear type draws the fuel from the fuel tanks and pumps it to the carburetors as required. The fuel pump on the M3A4 power unit and on the M4A4 power unit (up to, and including, power unit serial number M4A4-2304) is mounted to an adapter located just above the power unit rear support at the distributor end of the power unit. The pump is driven through a sleeve connected to the accessory shaft (fig. 15) and rotates clockwise. The fuel pump on the M4A4 power unit (power units M4A4-2305, and above) is mounted to an adapter located at the distributor end of No. 4 engine. The pump is driven through a gear mounted on the end of the camshaft of No. 4 engine (fig. 16) and rotates counterclockwise. **CAUTION:** These fuel pumps look identical but are not interchangeable. Always use pump of clockwise rotation on power units equipped with multiple water pumps. Always use pump of counterclockwise rotation on power units equipped with single water pump. Rotation is indicated by an arrow on upper pump body (figs. 17 and 18). The fuel pump consists of a drive shaft, body, inner driving rotor, outer driven rotor, driven shaft, relief valve spring and retainer, and an upper and a lower body. When the fuel pump pressure exceeds 6 pounds per square inch, the outer rotor is forced away from the lower body, forcing the driven shaft against the relief valve spring and allowing the fuel to be bypassed to the suction side of the fuel pump.

**25. REMOVAL.**

a. Refer to TM 9-754, January 21, 1943 (par. 76 d), for removal procedure.

**ORDNANCE MAINTENANCE—POWER UNIT ACCESSORIES  
FOR MEDIUM TANKS M3A4 AND M4A4**



RA PD 25327

**Figure 14—Parts of Fuel Pump**

## FUEL PUMP

### 26. DISASSEMBLY.

DRIFT	SCREWDRIVER, cross recess
HAMMER	head
PLIERS, side cutting	WRENCH, 1/2-in.
PRESS	

#### a. Remove Fuel Pump Drive Shaft (fig. 30).

SCREWDRIVER, cross recess head

Remove the four fuel pump drive end bearing screws with a cross recess head screwdriver and remove the bearing from the fuel pump lower body (fig. 32). Pull the drive shaft, coupling, and oil seal out of the lower body and remove the oil seal washer.

#### b. Remove Fuel Pump Rotors.

PLIERS, side cutting                      WRENCH, 1/2-in.

Remove the lock wires with side cutting pliers and remove the four fuel pump cap screws with a 1/2-inch wrench. Separate the fuel pump upper body from the lower body and remove the fuel pump gasket (fig. 27). Remove the outer rotor, driven shaft and seal spring from the lower body (fig. 26), and remove the inner rotor (fig. 25).

#### c. Remove Fuel Pump Driven Shaft from Outer Rotor.

SCREWDRIVER, cross recess head

Remove the fuel pump seal pressure spring from the fuel pump driven shaft with the fingers (fig. 24); then remove the three fuel pump rotor and shaft screws with a cross recess head screwdriver and remove the driven shaft from the rotor (fig. 23).

#### d. Remove Fuel Pump Relief Valve Spring.

Remove the fuel pump bearing pad from the primer pad (fig. 22). Remove the fuel pump primer pad and pin assembly from the fuel pump relief valve spring (fig. 21) and remove the spring from the upper body (fig. 20).

#### e. Remove the Fuel Pump Rotor Shaft Bearing.

ARBOR    PRESS

Place the fuel pump lower body in a press, with the large end down, and press the rotor shaft bearing out of the body with a suitable arbor; then place the rotor shaft bearing in a press and press the inner rotor bushing off the bearing.

#### f. Remove Bushing from Fuel Pump Drive End Bearing.

ARBOR    PRESS

Place the fuel pump drive and bearing in a press and press out the bushing with a suitable arbor.

ORDNANCE MAINTENANCE—POWER UNIT ACCESSORIES  
FOR MEDIUM TANKS M3A4 AND M4A4

RA PD 25426

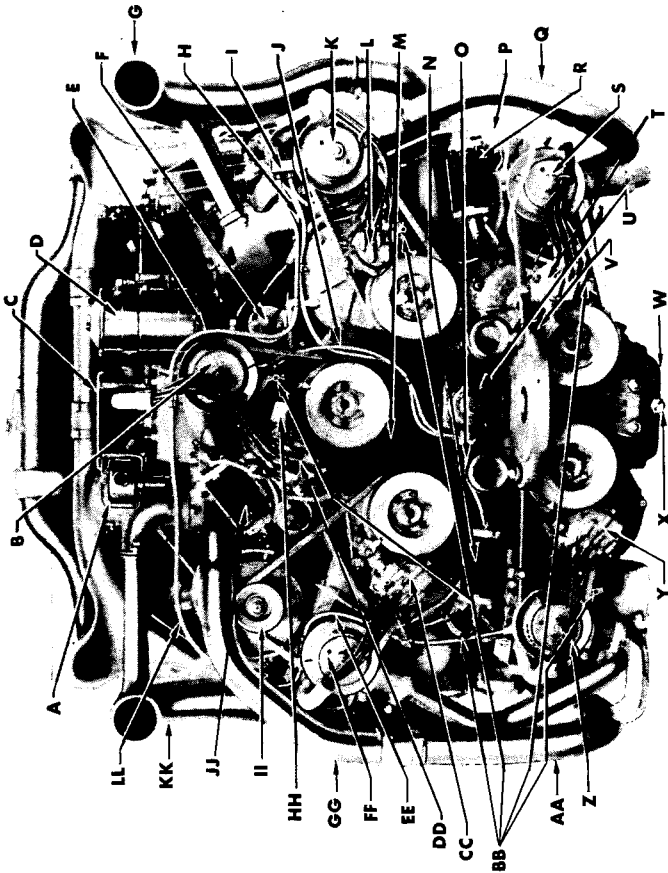


Figure 15—M4A4 Power Unit—Distributor End View (Multiple Water Pump Type)

FUEL PUMP

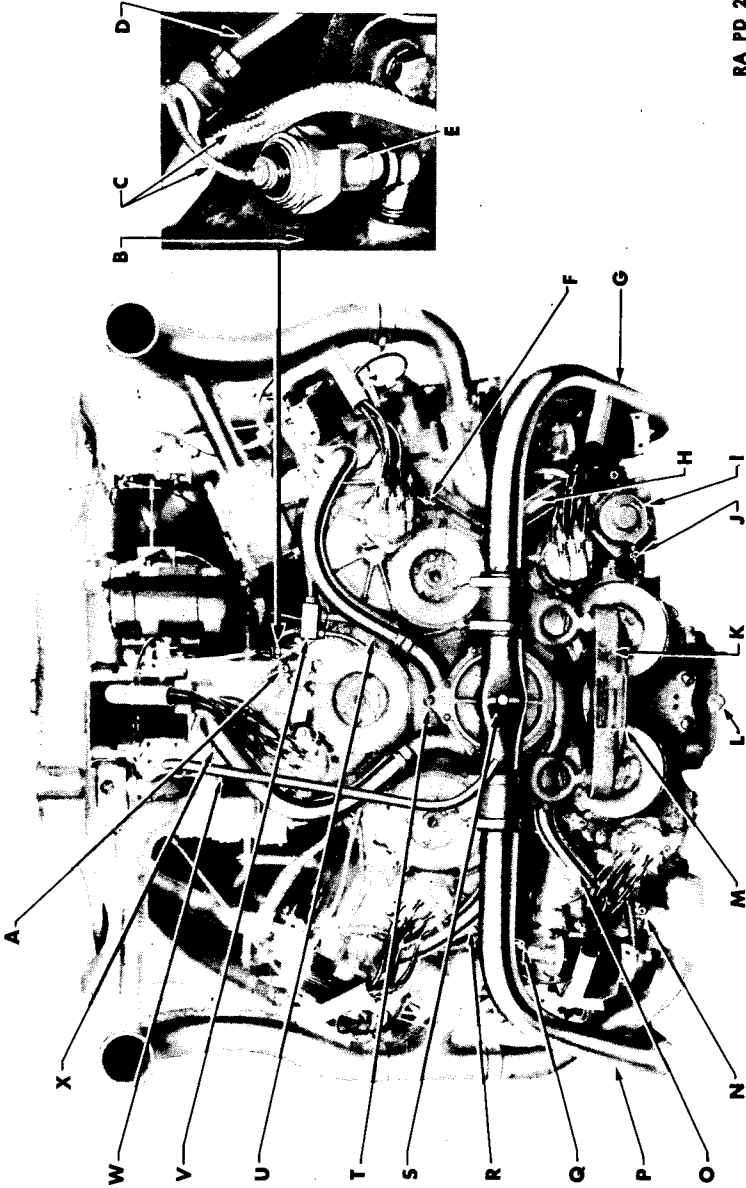
- A—CLEANER, AIR, CRANKCASE VENTILATOR, ASSEMBLY
- B—PUMP, WATER, ASSEMBLY (NO. 1 ENGINE)
- C—PLATE, ENGINE LIFTER AND STEP, ASSEMBLY
- D—FILTER, OIL, W/CLAMP, ASSEMBLY
- E—TUBE, WATER PUMP AIR RELIEF (NO. 1 TO NO. 5 ENGINE)
- F—COIL, IGNITION, ASSEMBLY (NO. 5 ENGINE)
- G—PIPE, EXHAUST (NOS. 4 AND 5 ENGINES)
- H—TUBE, FUEL PUMP TO BRANCH CONNECTION, ASSEMBLY (FOR NOS. 4 AND 5 CARBURETORS)
- I—CONNECTION, WATER PUMP AIR RELIEF
- J—TUBE, FUEL PUMP TO NO. 1 CARBURETOR, ASSEMBLY
- K—PUMP, WATER, ASSEMBLY (NO. 5 ENGINE)
- L—DISTRIBUTOR, IGNITION, ASSEMBLY (NO. 5 ENGINE)
- M—PLATE, SERIAL NUMBER, ENGINE
- N—COIL, IGNITION, ASSEMBLY (NO. 3 ENGINE)
- O—TUBE, FUEL PUMP TO BRANCH CONNECTION, ASSEMBLY (FOR NOS. 2 AND 3 CARBURETORS)
- P—TUBE, WATER PUMP AIR RELIEF (NO. 4 TO NO. 5 ENGINE)
- Q—TUBE, RADIATOR OUTLET, ASSEMBLY (NOS. 4 AND 5 ENGINES)
- R—COIL, IGNITION, ASSEMBLY (NO. 4 ENGINE)
- S—PUMP, WATER, ASSEMBLY (NO. 4 ENGINE)
- T—DISTRIBUTOR, IGNITION, ASSEMBLY (NO. 4 ENGINE)
- U—PUMP, FUEL, ASSEMBLY
- V—SUPPORT, ENGINE, REAR
- W—PAN, OIL, ASSEMBLY
- X—PLUG, DRAIN, OIL PAN
- Y—DISTRIBUTOR, IGNITION, ASSEMBLY (NO. 3 ENGINE)
- Z—PUMP, WATER, ASSEMBLY (NO. 3 ENGINE)
- AA—TUBE, RADIATOR OUTLET, ASSEMBLY (NOS. 2 AND 3 ENGINES)
- BB—COCK, DRAIN, CYLINDER WATER JACKET, ASSEMBLY
- CC—DISTRIBUTOR, IGNITION, ASSEMBLY (NO. 2 ENGINE)
- DD—DISTRIBUTOR, IGNITION, ASSEMBLY (NO. 1 ENGINE)
- EE—TUBE, WATER PUMP AIR RELIEF (NO. 2 TO NO. 3 ENGINE)
- FF—PUMP, WATER, ASSEMBLY (NO. 2 ENGINE)
- GG—CONNECTION, RADIATOR OUTLET TUBE, ASSEMBLY (NO. 1 ENGINE)
- HH—GEAR, REDUCTION, TACHOMETER DRIVE, ASSEMBLY
- II—GENERATOR, ASSEMBLY
- JJ—COIL, IGNITION, ASSEMBLY (NO. 1 ENGINE)
- KK—PIPE, EXHAUST (NOS. 1, 2 AND 3 ENGINES)
- LL—TUBE, WATER PUMP AIR RELIEF (NO. 1 TO NO. 2 ENGINE)

RA PD 254268

Legend for Figure 15—M4A4 Power Unit—Distributor End View (Multiple Water Pump Type)



ORDNANCE MAINTENANCE—POWER UNIT ACCESSORIES  
FOR MEDIUM TANKS M3A4 AND M4A4



RA PD 25542

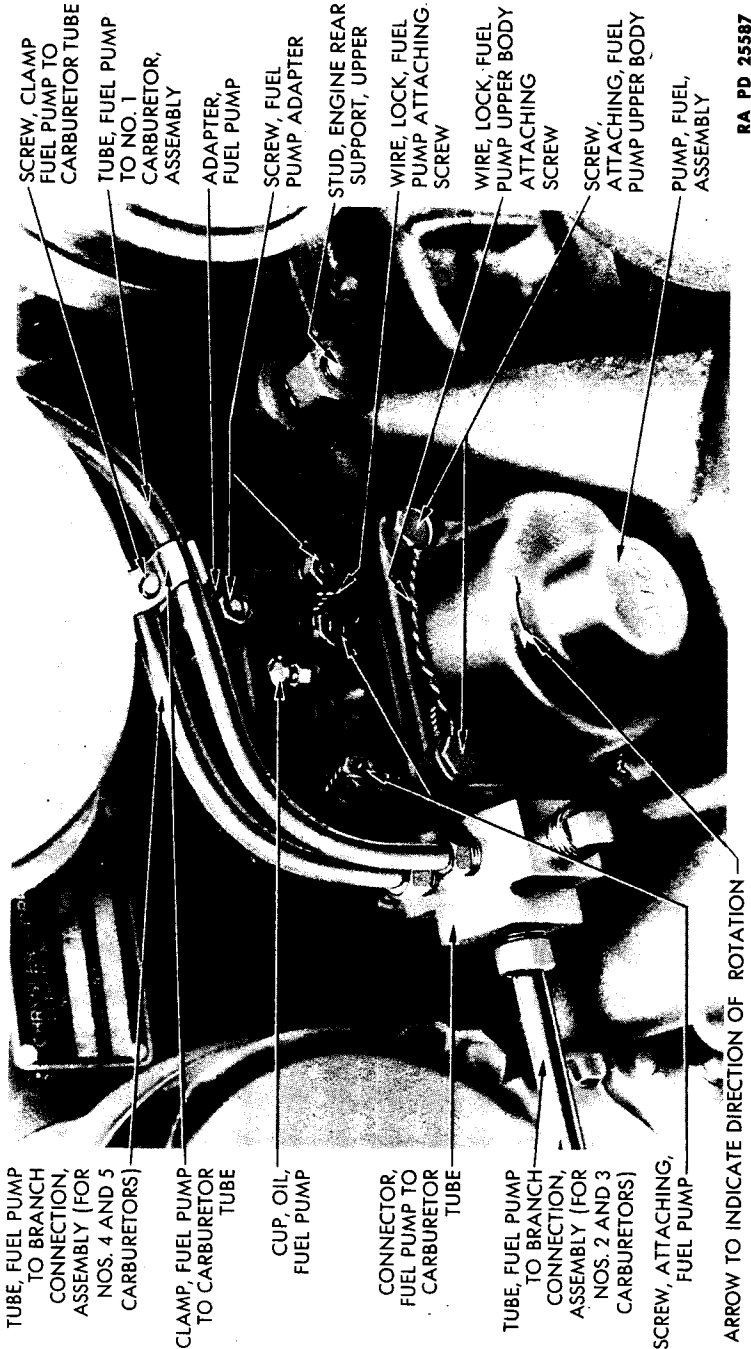
Figure 16—M4A4 Power Unit—Distributor End View (Single Water Pump Type)

FUEL PUMP

- A**—COCK, DRAIN, ENGINE CYLINDER WATER JACKET ASSEMBLY (ENGINE NO. 1)
- B**—BLOCK, ENGINE CYLINDER (ENGINE NO. 1)
- C**—HARNESS, ENGINE WIRING, ASSEMBLY
- D**—TUBE, OUTLET, OIL FILTER ASSEMBLY
- E**—UNIT, SENDING, ENGINE OIL PRESSURE WARNING INDICATOR
- F**—COCK, DRAIN, ENGINE CYLINDER WATER JACKET, ASSEMBLY (ENGINE NO. 5)
- G**—TUBE, OUTLET, RADIATOR, RIGHT ASSEMBLY
- H**—TUBE, OUTLET, WATER PUMP, ASSEMBLY (ENGINE NO. 4)
- I**—PUMP, FUEL, ASSEMBLY
- J**—COCK, DRAIN, ENGINE CYLINDER WATER JACKET, ASSEMBLY (ENGINE NO. 4)
- K**—SUPPORT, ENGINE, REAR
- L**—PLUG, DRAIN, OIL PAN
- M**—PLATE, NAME, ENGINE SERIAL NUMBER
- N**—COCK, DRAIN, ENGINE CYLINDER WATER JACKET, ASSEMBLY (ENGINE NO. 3)
- O**—TUBE, OUTLET, WATER PUMP ASSEMBLY (ENGINE NO. 3)
- P**—TUBE, OUTLET, RADIATOR, LEFT, ASSEMBLY
- Q**—COCK, DRAIN, ENGINE CYLINDER WATER JACKET, ASSEMBLY (ENGINE NO. 2)
- R**—TUBE, OUTLET, WATER PUMP, ASSEMBLY (ENGINE NO. 2)
- S**—PUMP, WATER ASSEMBLY
- T**—FITTING, GREASE, WATER PUMP BODY
- U**—TUBE, OUTLET, WATER PUMP, ASSEMBLY (ENGINE NO. 5)
- V**—CONNECTION, MAIN BRANCH, FUEL PUMP TO CARBURETOR TUBE ASSEMBLY
- W**—TUBE, OVERFLOW, RADIATOR, ASSEMBLY
- X**—TUBE, OUTLET, WATER PUMP, ASSEMBLY (ENGINE NO. 1)
- RA PD 25542B**

**Legend for Figure 16—M4A4 Power Unit—Distributor End View (Single Water Pump Type)**

**ORDNANCE MAINTENANCE - POWER UNIT ACCESSORIES  
FOR MEDIUM TANKS M3A4 AND M4A4**



TUBE, FUEL PUMP TO BRANCH CONNECTION, ASSEMBLY (FOR NOS. 4 AND 5 CARBURETORS)

CLAMP, FUEL PUMP TO CARBURETOR TUBE

CUP, OIL, FUEL PUMP

CONNECTOR, FUEL PUMP TO CARBURETOR TUBE

TUBE, FUEL PUMP TO BRANCH CONNECTION, ASSEMBLY (FOR NOS. 2 AND 3 CARBURETORS)

SCREW, ATTACHING, FUEL PUMP

ARROW TO INDICATE DIRECTION OF ROTATION

SCREW, CLAMP FUEL PUMP TO CARBURETOR TUBE

TUBE, FUEL PUMP TO NO. 1 CARBURETOR, ASSEMBLY

ADAPTER, FUEL PUMP

SCREW, FUEL PUMP ADAPTER

STUD, ENGINE REAR SUPPORT, UPPER

WIRE, LOCK, FUEL PUMP ATTACHING, SCREW

WIRE, LOCK, FUEL PUMP UPPER BODY ATTACHING, SCREW

SCREW, ATTACHING, FUEL PUMP UPPER BODY

PUMP, FUEL, ASSEMBLY

RA PD 25587

**Figure 17 - Fuel Pump Used on Multiple Water Pump Type Power Unit**

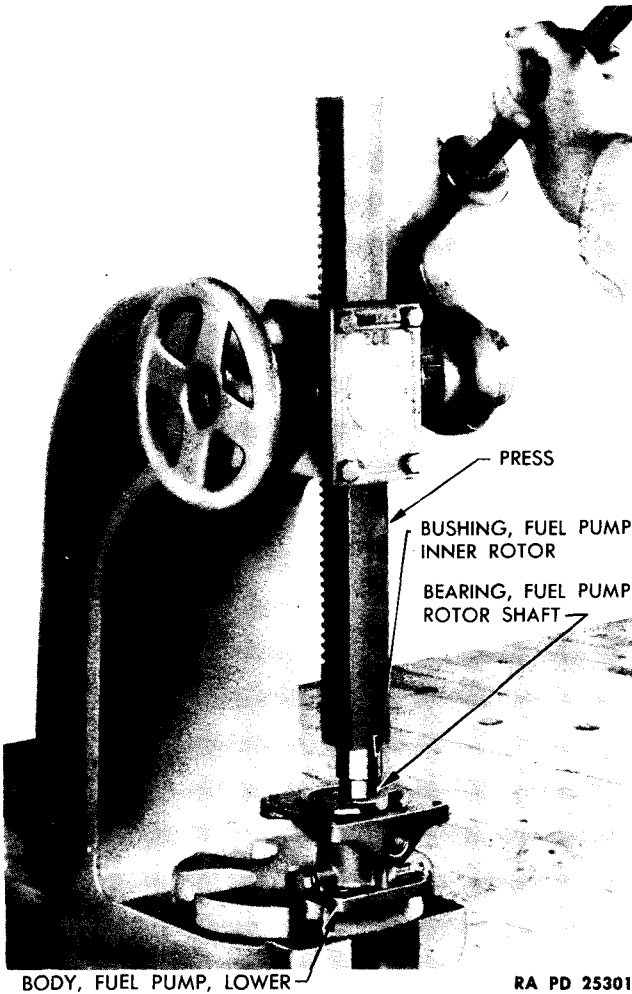
FUEL PUMP



RA PD 24527

Figure 18—Fuel Pump Used on Single Water Pump Type Power Unit

**ORDNANCE MAINTENANCE—POWER UNIT ACCESSORIES  
FOR MEDIUM TANKS M3A4 AND M4A4**



**Figure 19—Fuel Pump Inner Rotor Bushing Installation**

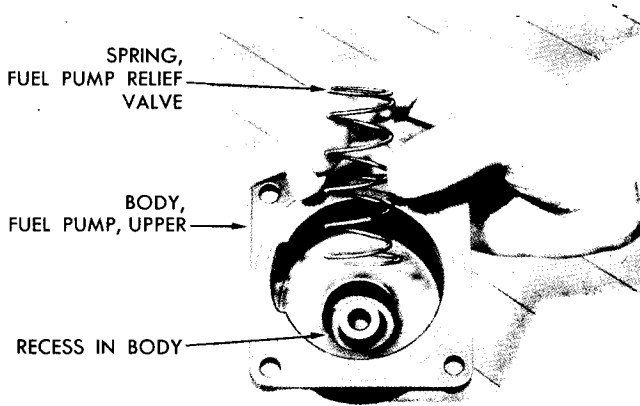
- g. Remove Fuel Pump Coupling from Fuel Pump Drive Shaft.**  
**DRIFT** **HAMMER**

Drive out the fuel pump coupling pin with a drift and a hammer and remove the coupling from the fuel pump drive shaft.

**27. INSPECTION OF PARTS.**

- a. Clean all parts thoroughly, removing all foreign matter, and be sure all passages are free from obstructions. Inspect all parts for damage or

**FUEL PUMP**



RA PD 25311

**Figure 20—Relief Valve Spring Installation**

wear and replace parts where necessary. Always replace the gasket, oil seal washer, and oil seal.

**28. ASSEMBLY.**

**HAMMER**

**PLIERS**, side cutting

**PRESS**

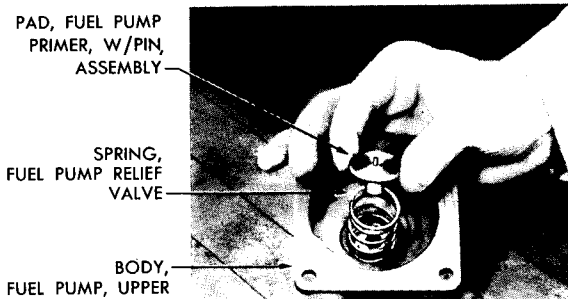
**SCREWDRIVER**, cross recess head

**WRENCH**, open-end,  $\frac{5}{16}$ -in.

**WRENCH**, torque

a. Install Fuel Pump Coupling on Fuel Pump Drive Shaft (fig. 14).

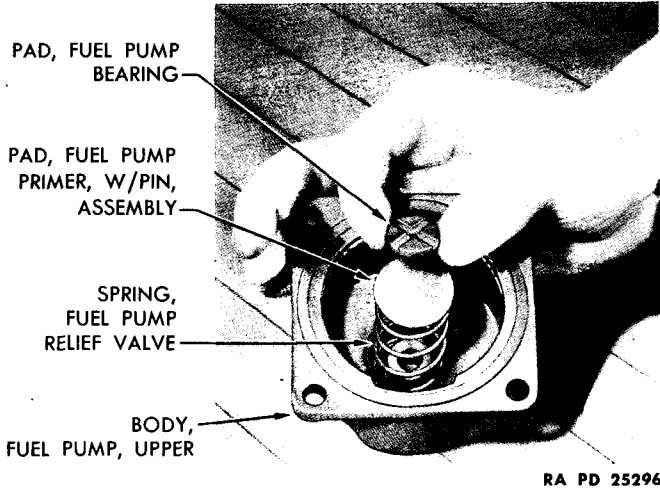
Slide the coupling into position on the drive shaft, aligning the pinhole



RA PD 25313

**Figure 21—Primer Pad and Pin Assembly Installation**

**ORDNANCE MAINTENANCE—POWER UNIT ACCESSORIES  
FOR MEDIUM TANKS M3A4 AND M4A4**



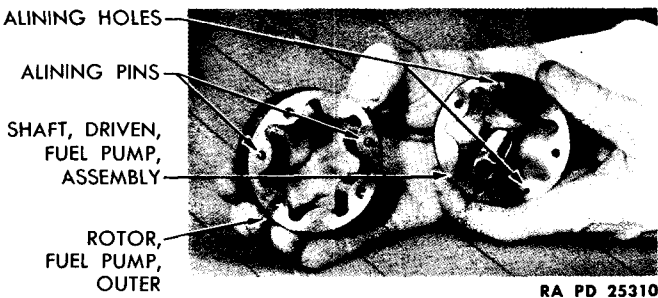
**Figure 22—Bearing Pad Installation**

in the coupling with the pinhole in the shaft. Lock the coupling to the drive shaft by driving the lockpin with a drift and a hammer.

**b. Install Fuel Pump Rotor Shaft Bearing.**

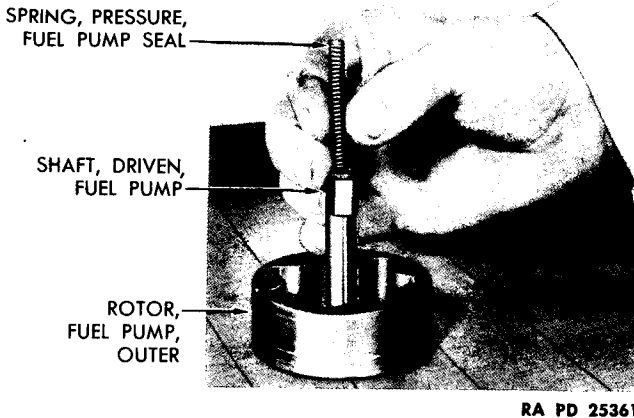
- |        |        |
|--------|--------|
| DRIFT  | REAMER |
| HAMMER | WISE   |
| PRESS  |        |

Place the fuel pump lower body on the press with the large end up, and press the bearing into the lower body, making sure that the pinhole in the bearing is alined with the pinhole in the body. Lock the bearing in place by driving in the dowel pin with a hammer and a drift until the



**Figure 23—Driven Shaft to Outer Rotor Assembly**

### FUEL PUMP



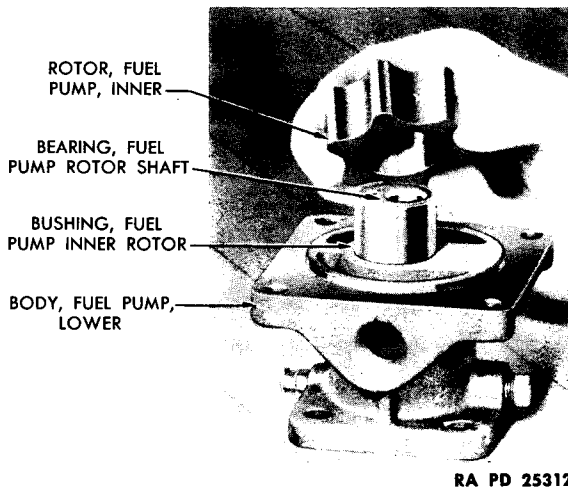
**Figure 24—Pressure Seal Spring Installation**

dowel pin is firmly seated in the body. Place the fuel pump lower body in a vise and ream out the bearing to 0.500 inch—0.501 inch.

**c. Install Fuel Pump Inner Rotor Bushing (fig. 19).**

**PRESS**

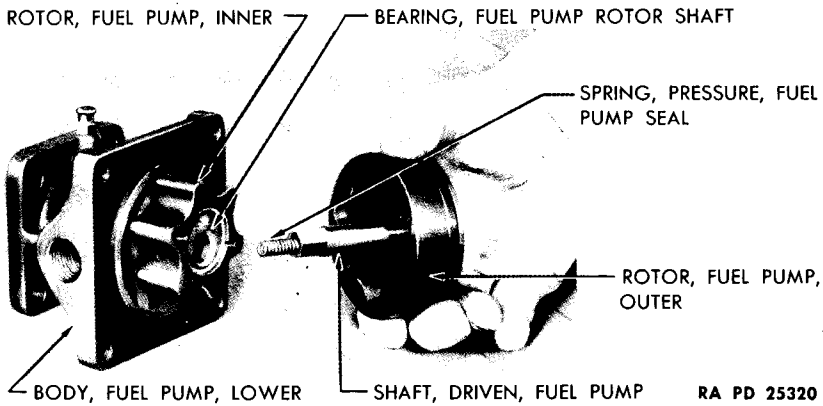
Place the fuel pump lower body on the press with the small end down and press the inner rotor bushing onto the rotor shaft bearing.



**Figure 25—Inner Rotor to Lower Body Assembly**



**ORDNANCE MAINTENANCE—POWER UNIT ACCESSORIES  
FOR MEDIUM TANKS M3A4 AND M4A4**



**Figure 26—Outer Rotor to Inner Rotor Assembly**

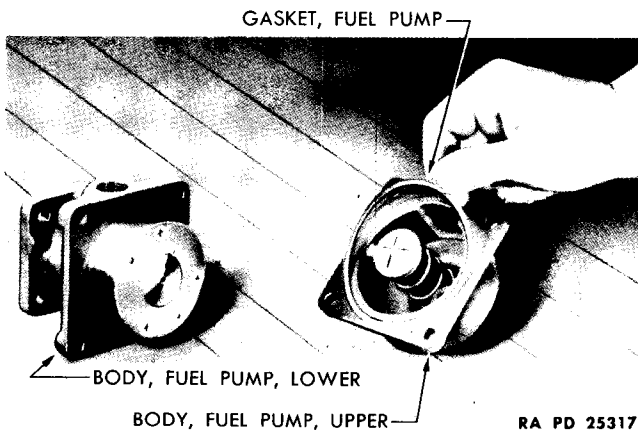
**d. Assemble Fuel Pump Bearing Pad in Upper Body.**

Place the fuel pump relief valve spring in position in the upper body (fig. 20). Place the primer pad and pin assembly on the spring with the small button end up (fig. 21); then place the bearing pad on the primer pad (fig. 22).

**e. Assemble Fuel Pump Driven Shaft to Outer Rotor.**

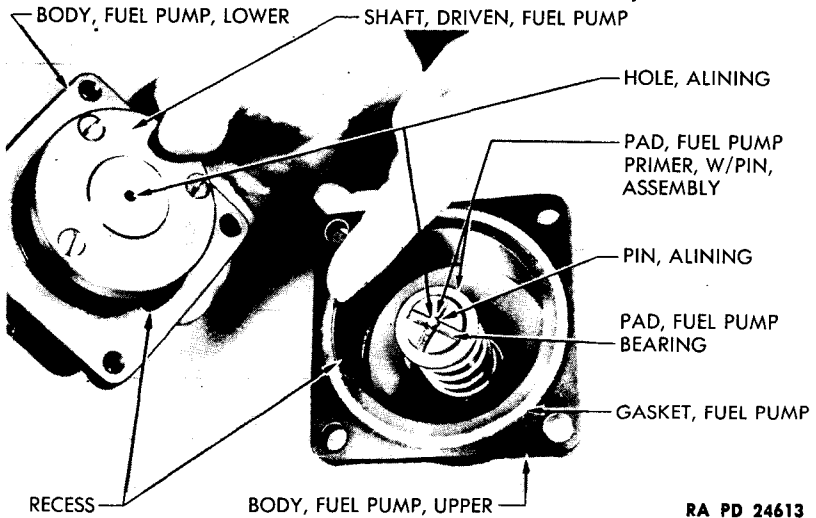
SCREWDRIVER, cross recess head

Place the driven shaft against the rotor, making sure that the alining holes in the flange of the shaft are alined with the alining holes in the



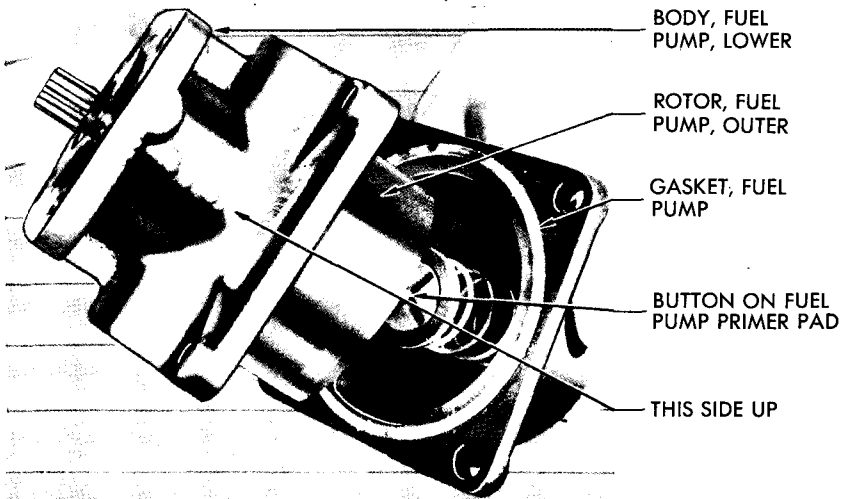
**Figure 27—Gasket into Recess in Upper Body Installation**

**FUEL PUMP**



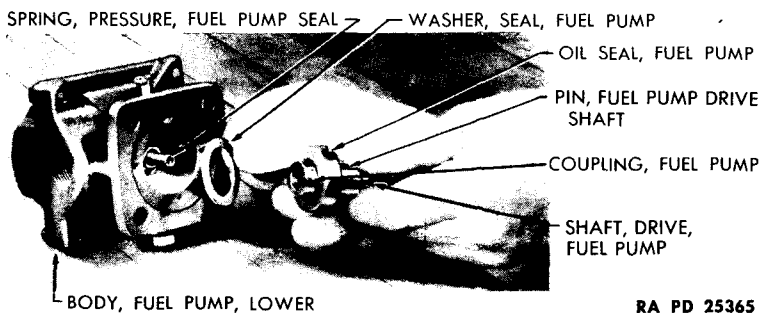
**Figure 28—Lower Body to Upper Body Assembly**

outer rotor (fig. 23); and fasten the shaft to the rotor, tightening the attaching screws securely with a cross recess head screwdriver. Slide the fuel pump seal pressure spring into the hole in the driven shaft (fig. 24).



**Figure 29—Lower Body to Upper Body Assembly**

## ORDNANCE MAINTENANCE—POWER UNIT ACCESSORIES FOR MEDIUM TANKS M3A4 AND M4A4



RA PD 25365

**Figure 30—Drive Shaft and Coupling in Lower Body Installation**

### f. Assemble Fuel Pump Upper Body to Lower Body.

PLIERS, side cutting

WRENCH, torque

Slide the fuel pump inner rotor onto the fuel pump rotor shaft bearing (fig. 25). Insert the end of the fuel pump drive shaft into the hole in the rotor shaft bearing (making sure that the seal pressure spring does not fall out of the shaft) and slide the outer rotor on to the inner rotor (fig. 26). Place a new fuel pump gasket in position in the recess in the upper body (fig. 27). Hold the fuel pump lower body and rotors together; place the lower body in position on the upper body, making certain that the button that holds the bearing pad in place is centered in the alining hole in the driven shaft *and that the recess in upper body alines with recess in lower body* (figs. 28 and 29). Fasten the upper body to the lower body with the four fuel pump cap screws and tighten the cap screws with a torque wrench to 15 — 20 foot-pounds. Insert a lock wire through the holes of each pair of cap screws and twist the ends of each wire together with pliers.

### g. Install Fuel Pump Drive Shaft and Coupling (fig. 30).

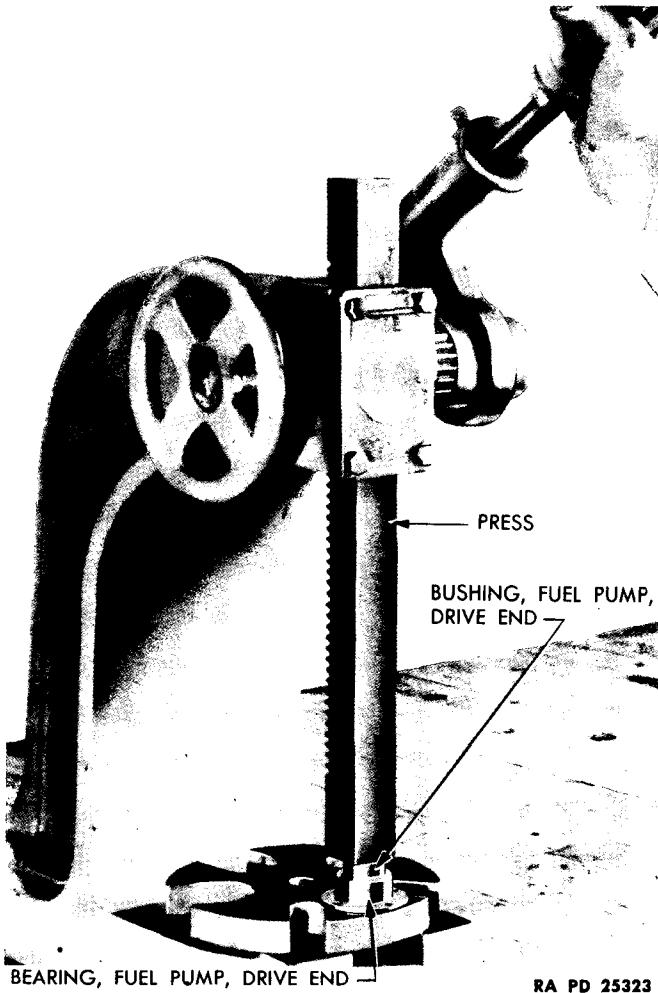
Slide the fuel pump oil seal over the end of the fuel pump coupling and slide the pump seal washer over the end of the coupling and against the oil seal. Insert the coupling end of the drive shaft and coupling assembly into the pump lower body, making sure that the seal pressure spring enters the hole in the end of the coupling; then slide the coupling over the end of the fuel pump driven shaft.

### h. Install Fuel Pump Drive End Bearing (fig. 32).

SCREWDRIVER, cross recess  
headWRENCH, open-end,  $\frac{5}{16}$ -in.

Place new bushing in drive end bearing and press into position with

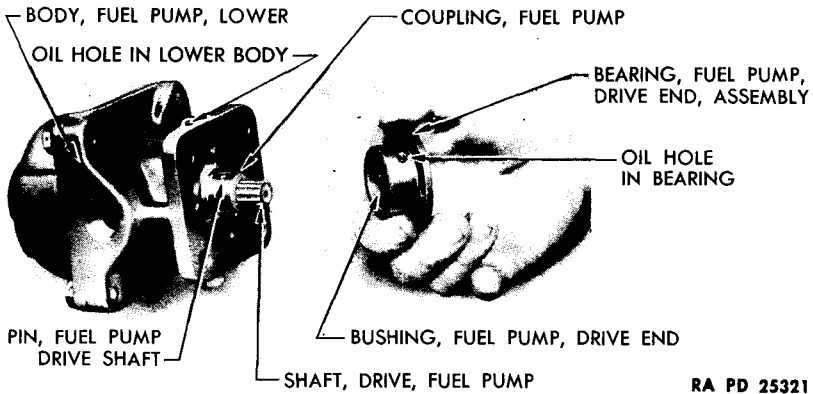
FUEL PUMP



**Figure 31—Bushing in Drive End Bearing Installation**

press (fig. 31). Slide the drive end bearing over the fuel pump coupling, aligning the oilhole in the bearing with the oilhole in the pump lower body, and fasten the bearing to the body with the four drive end bearing screws. Tighten the screws securely with a cross recess head screwdriver. Screw the oil cup into the threaded hole in the lower body and tighten the cup securely with a  $\frac{5}{16}$ -inch open-end wrench (fig. 33). **NOTE:** Check the free movement of the fuel pump drive shaft and rotors by turning the drive shaft by hand.

**ORDNANCE MAINTENANCE—POWER UNIT ACCESSORIES  
FOR MEDIUM TANKS M3A4 AND M4A4**



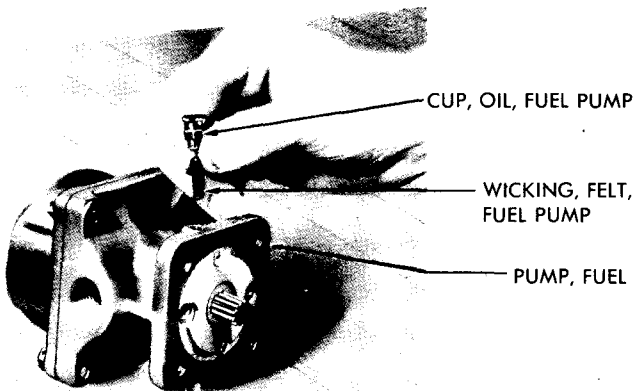
**Figure 32—Drive End Bearing Installation**

**29. INSTALLATION.**

a. Refer to TM 9-754, January 21, 1943 (par. 76 e), for installation procedure.

**30. FUEL PUMP DRIVE.**

a. **General.** On M3A4 power units and M4A4 power units up to, and including, power unit serial number M4A4-2304, the fuel pump drive assembly is located on the distributor end of the crankcase and driven by the accessory drive shaft (fig. 35). On power units, M4A4-2304, and above, the fuel pump drive is mounted on the distributor end of No. 4 engine and is gear driven off the camshaft.



**Figure 33—Felt Wicking and Oil Cup Installation**

## FUEL PUMP

b. Power Units M3A4 and M4A4 Up To, and Including, Power Unit Serial Number M4A4-2304 (fig. 34).

(1) REMOVAL (fig. 35).

PLIERS, side cutting

WRENCH, socket, 1/2-in.

Remove the lock wires from the eight fuel pump adapter attaching screws with side cutting pliers, remove the screws with a 1/2-inch socket wrench, and pull the fuel pump drive assembly out of the crankcase.

NOTE: On M3A4 power units, the attaching screws are not secured with lock wires.

(2) DISASSEMBLE FUEL PUMP DRIVE ASSEMBLY.

DRIFT, small

PULLER, oil seal

FILE, mill, small

SCREWDRIVER

HAMMER

WRENCH, spanner,

PRESS

MTM-A4-26

PULLER, bearing

(a) Remove Fuel Pump Drive Shaft Key (fig. 43).

DRIFT, small

HAMMER

FILE, mill, small

File the sides of the fuel pump drive shaft key pins where the pins are peened over the key, using a small fine mill file. Drive out the pins with a small drift and a hammer and lift the key out of the keyway in the shaft.

(b) Remove Fuel Pump Drive Shaft Bearing Nut and Lock Washer (fig. 42).

WRENCH, spanner, MTM A4-26

Bend tabs of lock washer to clear nut; remove the fuel pump drive shaft bearing nut by turning the nut counterclockwise with spanner wrench MTM A4-26. Remove the lock washer.

(c) Remove Fuel Pump Drive Shaft from Bearing (in Adapter).

PRESS

Place the adapter, bearing and drive shaft assembly in position on the press, with the bearing side of the adapter up, and press the shaft out of the bearing.

(d) Remove Fuel Pump Drive Shaft Bearing.

PULLER, bearing

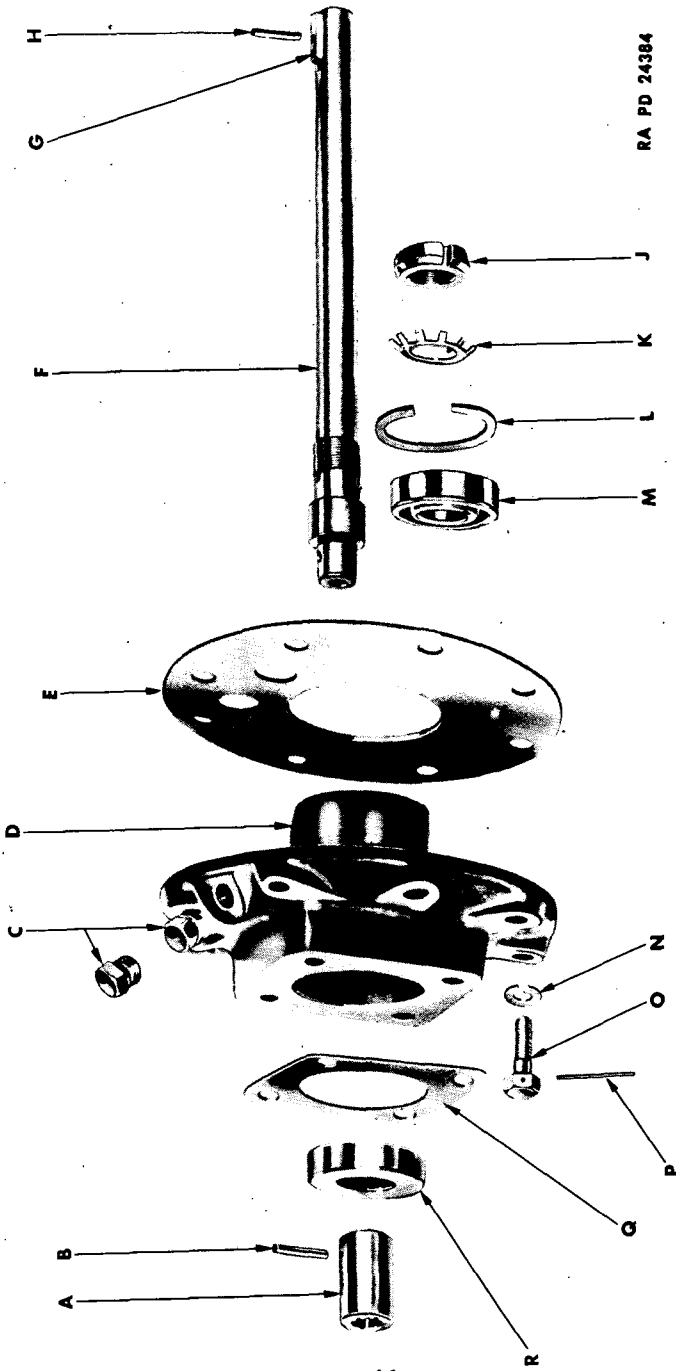
SCREWDRIVER

Place the fuel pump adapter on a bench with the bearing side of the adapter up and remove the fuel pump drive shaft bearing snap ring by prying it out with a screwdriver. Place the bearing puller in position with the hooks of the puller under the outer race of the bearing and pull the bearing out of the fuel pump adapter.

(e) Remove Fuel Pump Drive Shaft Bearing Oil Seal.

PULLER, oil seal

ORDNANCE MAINTENANCE—POWER UNIT ACCESSORIES  
FOR MEDIUM TANKS M3A4 AND M4A4



RA PD 24384

Figure 34—Parts of Fuel Pump Drive Assembly—Power Units M3A4  
and M4A4 up to, and Including, Power Unit Serial  
Number M4A4-2304

FUEL PUMP

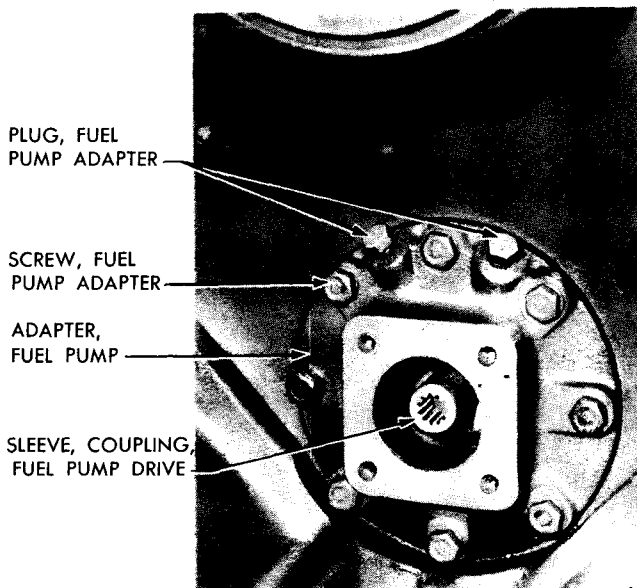
- A—SLEEVE, COUPLING, FUEL PUMP DRIVE
- B—PIN, DRIVE COUPLING SLEEVE
- C—PLUG, FUEL PUMP ADAPTER
- D—ADAPTER, FUEL PUMP
- E—GASKET, FUEL PUMP ADAPTER
- F—SHAFT, FUEL PUMP DRIVE, ASSEMBLY
- G—KEY, FUEL PUMP DRIVE SHAFT
- H—PIN, FUEL PUMP DRIVE SHAFT KEY
- J—NUT, FUEL PUMP DRIVE SHAFT BEARING
- K—WASHER, LOCK, FUEL PUMP DRIVE SHAFT BEARING NUT
- L—RING, SNAP, FUEL PUMP DRIVE SHAFT BEARING
- M—BEARING, FUEL PUMP DRIVE SHAFT
- N—WASHER, LOCK, FUEL PUMP ADAPTER SCREW
- O—SCREW, FUEL PUMP ADAPTER
- P—WIRE, LOCK, FUEL PUMP ADAPTER SCREW
- Q—GASKET, MOUNTING, FUEL PUMP
- R—SEAL, OIL, FUEL PUMP DRIVE SHAFT BEARING, ASSEMBLY

RA PD 24384B

**Legend for Figure 34—Parts of Fuel Pump Drive Assembly—Power  
Units M3A4 and M4A4 up to, and Including, Power Unit Serial  
Number M4A4-2304**



**ORDNANCE MAINTENANCE—POWER UNIT ACCESSORIES  
FOR MEDIUM TANKS M3A4 AND M4A4**



RA PD 25316

**Figure 35—Fuel Pump Drive Assembly—M3A4 Power Units and M4A4 Power Units up to, and Including, Serial Number M4A4-2304**

Place the fuel pump adapter on a bench with the oil seal side of the adapter up and remove the oil seal with a puller.

(f) *Remove Fuel Pump Adapter Plugs* (fig. 34).

WRENCH,  $\frac{7}{16}$ -in.

Remove the fuel pump adapter plugs by turning the plugs counter-clockwise with a  $\frac{7}{16}$ -inch wrench.

(g) *Remove Fuel Pump Drive Coupling Sleeve.*

DRIFT, small

HAMMER

FILE, mill, fine

PRESS

Grind the sides of the pin where it is peened over the sleeve, drive the pin out with a small drift and a hammer and, using a press, remove the fuel pump drive coupling sleeve from the drive shaft.

**(3) INSPECTION OF PARTS.**

Inspect the shaft assembly for wearing or looseness of the drive coupling. Replace if necessary. Check the bearing for roughness. Replace if necessary. Always replace the bearing oil seal.

**(4) ASSEMBLE FUEL PUMP DRIVE ASSEMBLY.**

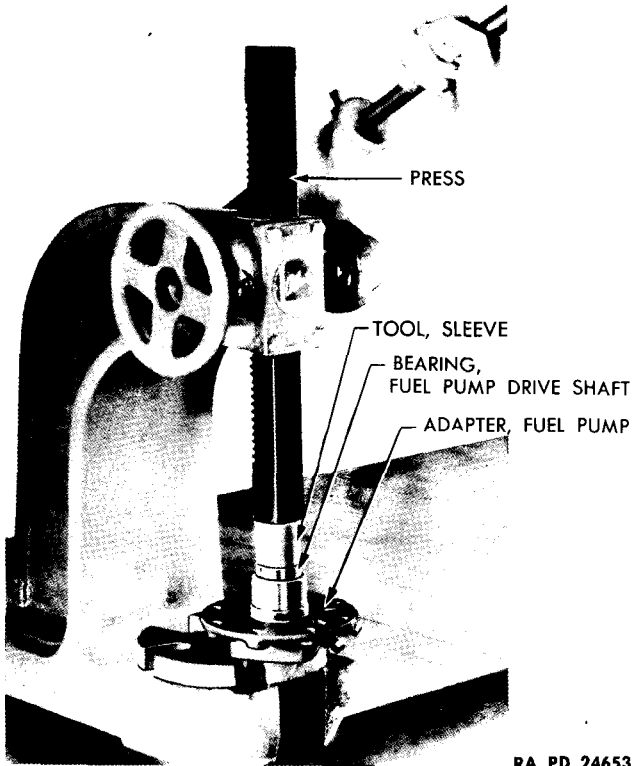
DRIFT, small

DRILL,  $\frac{5}{32}$ -in.

DRILL,  $\frac{3}{32}$ -in.

HAMMER

FUEL PUMP



RA PD 24653

**Figure 36—Pressing Drive Shaft Bearing in Adapter**

PRESS

PUNCH

TOOL, countersinking,  
1/8-in. x 90-degree

TOOL, countersinking, 1/4-in. x  
90-degree

TOOL, sleeve, 1 1/16-in. I.D.,  
7/8-in. O.D., 1/2-in. long

(a) Install Fuel Pump Drive Shaft Bearing (fig. 36).

PRESS

TOOL, sleeve, 1 5/16-in. I.D.,  
1 9/16-in. O.D., 1/2-in. long

TOOL, sleeve, 1 5/16-in. I.D.,  
1 9/16-in. O.D., 1/2-in. long

WISE

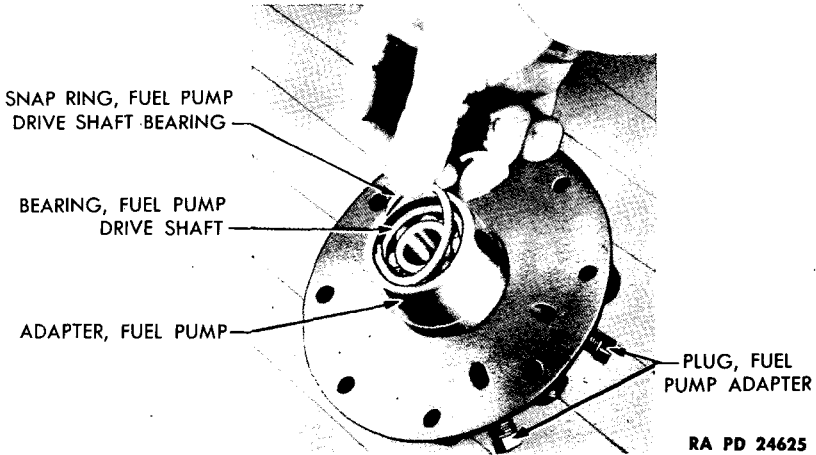
WRENCH, 7/16-in.

WRENCH, spanner, MTM  
A4-26

WRENCH, 7/16-in.

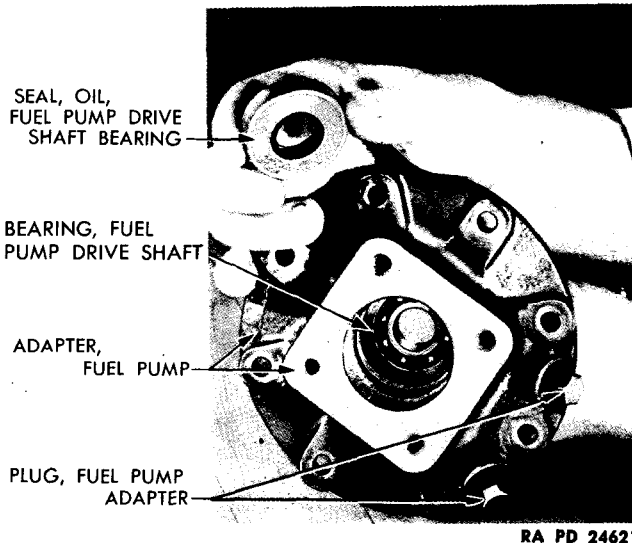
Screw the two fuel pump adapter plugs into openings in adapter (7/16-in. wrench). Place the fuel pump adapter on the press with the bearing side up. Place the bearing in position on the adapter. Place the sleeve tool in position on the outer race of the bearing and press the

**ORDNANCE MAINTENANCE—POWER UNIT ACCESSORIES  
FOR MEDIUM TANKS M3A4 AND M4A4**



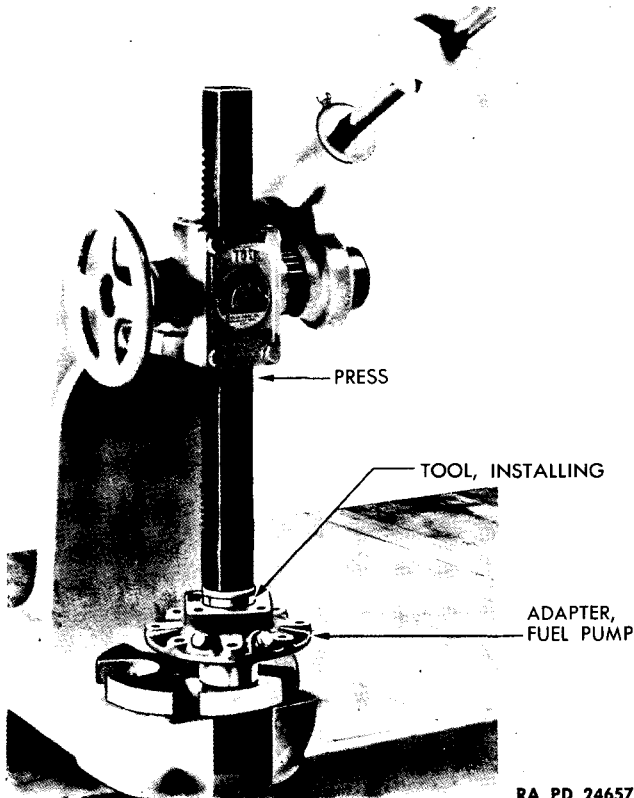
**Figure 37—Drive Shaft Bearing Snap Ring Installation**

bearing into the adapter. Select the bearing snap ring of the correct thickness (by fitting into the ring groove in the adapter a snap ring of the greatest thickness that can be inserted in the groove and against the outer race of the bearing: there are four sizes of snap rings of the following thicknesses: 0.055 in.—0.057 in.; 0.058 in.—0.060 in.; 0.061 in.—0.063 in.; 0.064 in.—0.066 in.) and press the snap ring into place in the groove with a screwdriver (fig. 37).



**Figure 38—Drive Shaft Bearing Oil Seal Installation**

FUEL PUMP



RA PD 24657

**Figure 39—Pressing Drive Shaft Bearing Oil Seal in Adapter**

(b) *Install Fuel Pump Drive Shaft Bearing Oil Seal (figs. 38 and 39).*

**PRESS**

Place the fuel pump adapter on the press with the oil seal side up. Place the oil seal in position on the adapter and press the seal in place.

(c) *Install Fuel Pump Drive Coupling Sleeve (fig. 40).*

**DRIFT, small**

**DRILL,  $\frac{5}{32}$ -in.**

**HAMMER**

**PRESS**

**PUNCH**

**TOOL, countersinking,  $\frac{1}{4}$ -in.**

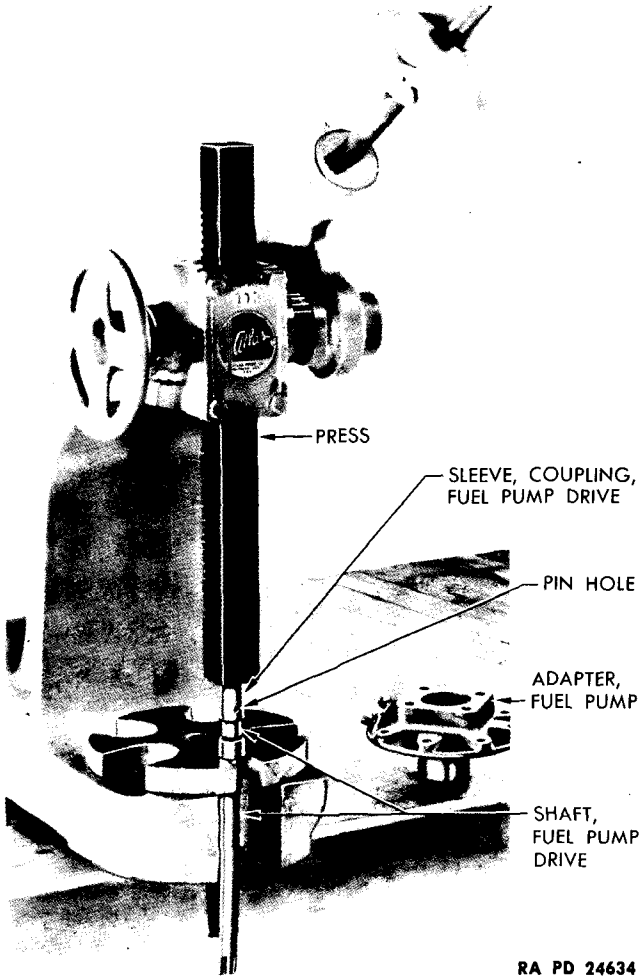
**x 90-degree**

**WISE**

**WHEEL, grinding**

Place the fuel pump drive shaft in position on the press. Place the sleeve in position with the splined end up and press the sleeve into place, seating the end of the sleeve firmly against the shoulder of the drive shaft. Place the shaft and sleeve assembly in a vise; and, using the countersunk hole in sleeve as a guide, drill a  $\frac{5}{32}$ -inch hole through the shaft and

ORDNANCE MAINTENANCE—POWER UNIT ACCESSORIES  
FOR MEDIUM TANKS M3A4 AND M4A4



RA PD 24634

**Figure 40—Pressing Coupling Sleeve on Drive Shaft**

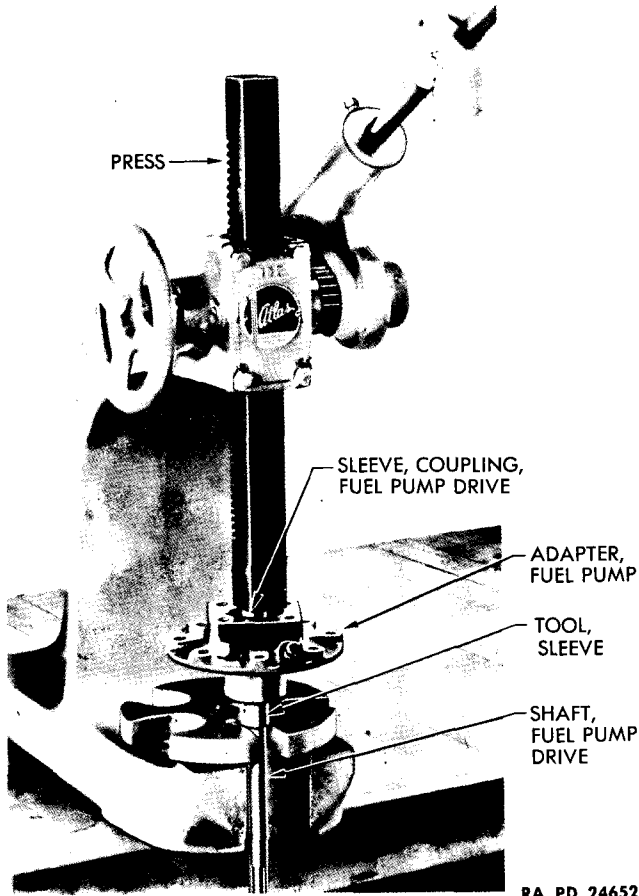
through the opposite side of the sleeve. Countersink the new hole in the sleeve with a  $\frac{1}{4}$ -inch x 90-degree countersinking tool. Drive the sleeve pin through the hole in the shaft with a small drift and a hammer; stake over the ends of the pin and grind the ends of the pin off flush with the sleeve.

(d) *Install Drive Shaft in Drive Shaft Bearing (in the Adapter)* (fig. 41).

PRESS

TOOL, sleeve,  $\frac{1}{16}$ -in. I.D.,  
 $\frac{7}{8}$ -in. O.D.,  $\frac{1}{2}$ -in. long

FUEL PUMP



RA PD 24652

**Figure 41—Pressing Shaft into Bearings (in Adapter)**

Place the adapter on the press with the bearing side down and with the inner race of the bearing resting on a sleeve tool,  $1\frac{1}{8}$ -inch inside diameter,  $\frac{7}{8}$ -inch outside diameter,  $\frac{1}{2}$ -inch long. Slide the end of the shaft down through the oil seal, bearing, and sleeve tool, and press down the sleeve on the end of the shaft until the shoulder of the shaft is seated firmly against the bearing.

(e) *Install Drive Shaft Bearing Nut* (fig. 42).

DRIFT

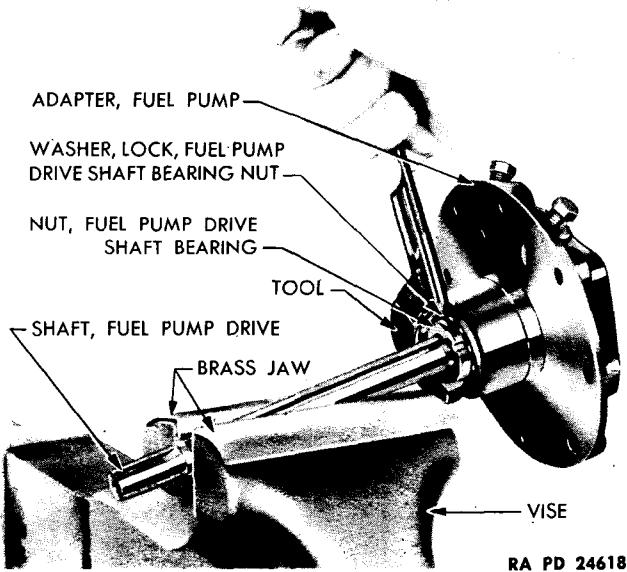
WRENCH, spanner, MTM

HAMMER, 2-lb

A4-26

Slide the lock washer on to the shaft. Slide the nut on to the shaft until

**ORDNANCE MAINTENANCE—POWER UNIT ACCESSORIES  
FOR MEDIUM TANKS M3A4 AND M4A4**



**Figure 42—Tightening Drive Shaft Bearing Nut**

it reaches the threads; then screw the nut on to the shaft by turning it clockwise and tighten the nut securely with a spanner wrench MTM A4-26. Bend tabs of lock washer with hammer and drift to secure nut.

(1) *Install Fuel Pump Drive Shaft Key* (fig. 43).

DRILL,  $\frac{3}{32}$ -in.  
DRIFT, small  
HAMMER

PUNCH  
TOOL, countersinking,  $\frac{1}{8}$ -in.  
x 90-degree

Place the shaft in a vise. Place the key in position in the keyway of the shaft. Using the holes in the key as guides, drill two  $\frac{3}{32}$ -inch holes through the shaft. Countersink the holes in the side of the shaft opposite the keyway with a  $\frac{1}{8}$ -inch x 90-degree countersinking tool. Drive the pins through the holes in the key and the shaft with a small drift and a hammer; stake over the ends of the pins and grind the ends of the pins flush with the key and with the side of the shaft.

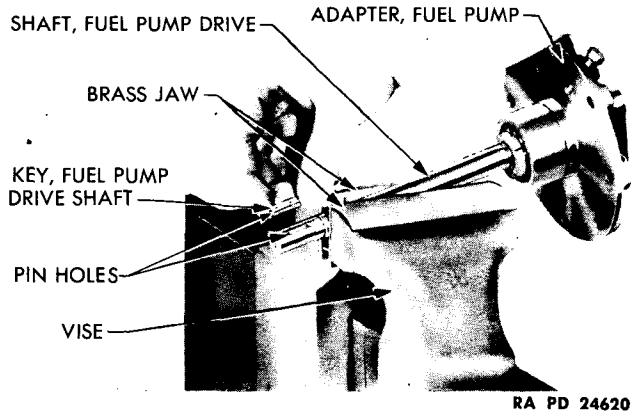
(5) **INSTALLATION** (fig. 35).

PLIERS, side cutting  
WRENCH, socket,  $\frac{1}{2}$ -in.

WRENCH, torque

Sight through the opening in the end of the crankcase and determine the position of the keyway in the accessory drive shaft sleeve. Place a

**FUEL PUMP**



**Figure 43—Key in Drive Shaft Installation**

new fuel pump adapter gasket in position against the end of the crankcase. Insert the end of the fuel pump drive shaft through opening in the crankcase, aligning the key in the shaft with the keyway in the accessory drive shaft sleeve. Slide the fuel pump drive shaft in until the key enters the keyway in the accessory drive shaft sleeve; then turn the fuel pump drive assembly until the eight attaching screw holes in the adapter are aligned with the eight holes in the crankcase as shown in figure 35. Attach the adapter to the crankcase with eight cap screws and lock washers. Tighten cap screws to 15—20 foot-pounds with  $\frac{1}{2}$ -inch socket wrench and torque wrench. Insert a lock wire through the holes in each pair of adapter attaching screws and twist the ends of each wire together with side cutting pliers.

**c. Power Unit Serial Number M4A4-2305, and Above (fig. 44).**

**(1) REMOVAL.**

**PLIERS**, side cutting

**WRENCH**, socket,  $\frac{1}{2}$ -in.

Remove the lock wires from the seven fuel pump adapter screws with side cutting pliers and remove the screws by turning them counterclockwise with a  $\frac{1}{2}$ -inch socket wrench. Pull the adapter assembly out of the crankcase.

**(2) DISASSEMBLE FUEL PUMP ADAPTER ASSEMBLY.**

**DRIFT**, small

**PULLER**, fuel pump drive gear

**HAMMER**

**SCREWDRIVER**

**PLIERS**, long nosed

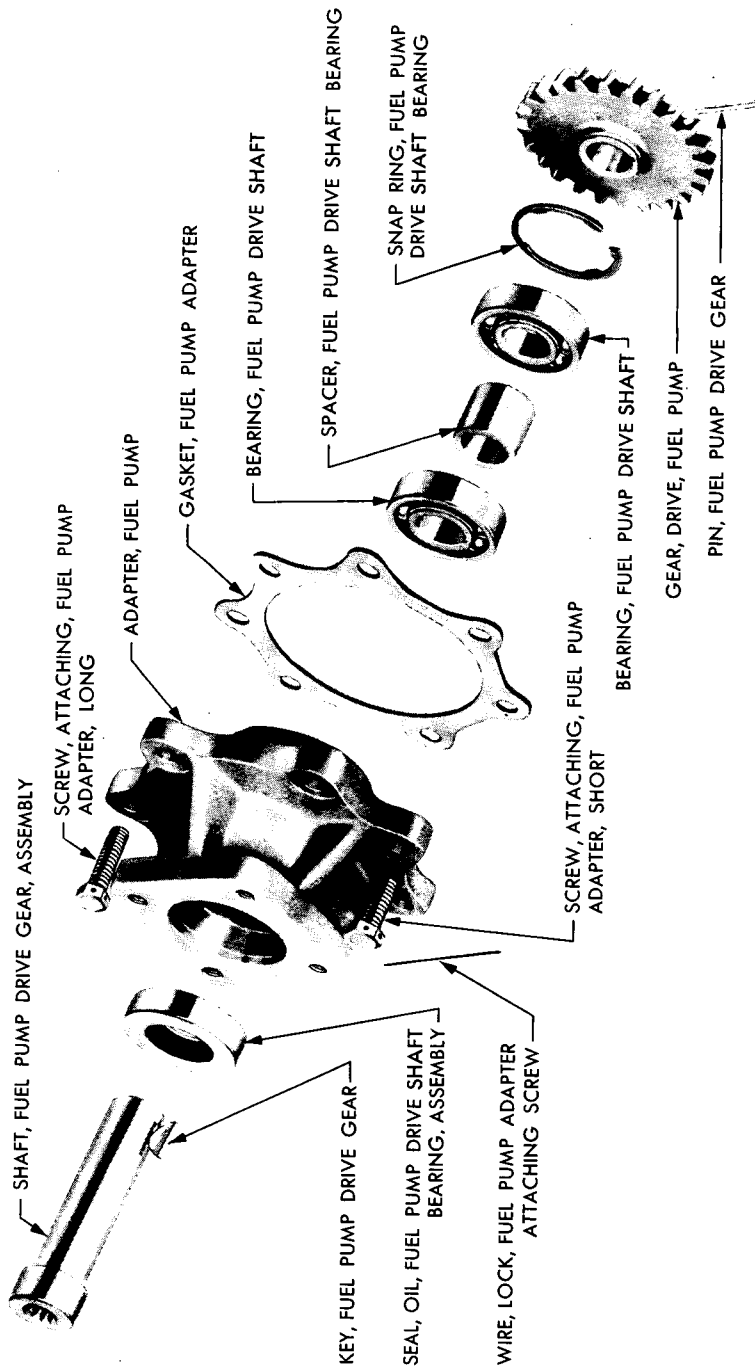
**TOOL**, countersinking,  $\frac{3}{16}$ -in. x

**PRESS**

90-degree



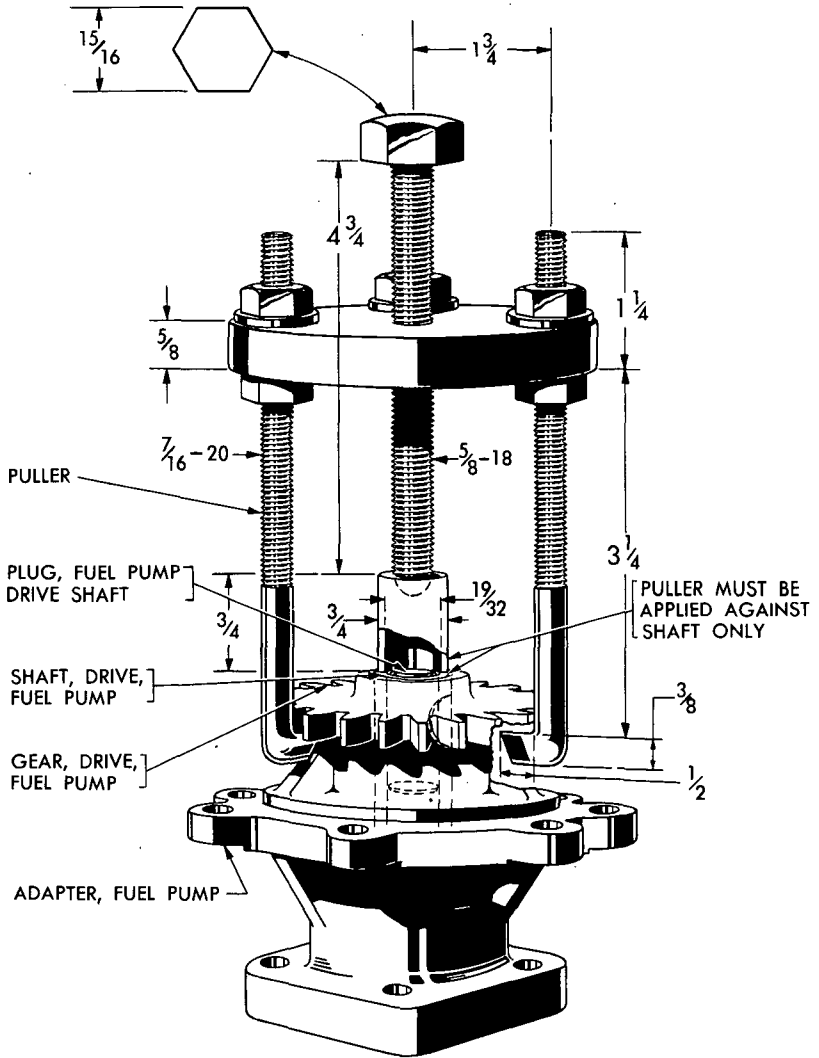
ORDNANCE MAINTENANCE—POWER UNIT ACCESSORIES  
FOR MEDIUM TANKS M3A4 AND M4A4



RA PD 25373

Figure 44—Parts of Fuel Pump Adapter—Power Unit Serial Number M4A4-2305, and Above

FUEL PUMP



RA PD 25268

Figure 45—Drive Gear from Shaft Removal

(a) Remove Fuel Pump Drive Gear (fig. 45).

DRIFT, small

TOOL, countersinking, 3/16-in. x

HAMMER

90-degree

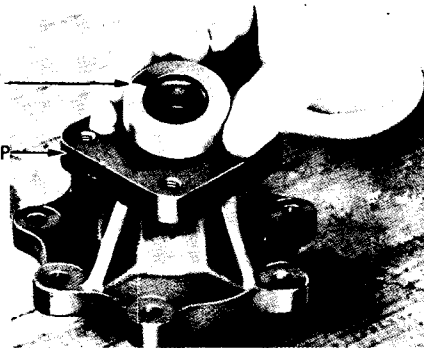
PULLER, fuel pump drive gear

Remove the staked over part of the small end of the fuel pump drive gear pin with a 3/16-inch x 90-degree countersinking tool and drive the

**ORDNANCE MAINTENANCE—POWER UNIT ACCESSORIES  
FOR MEDIUM TANKS M3A4 AND M4A4**

SEAL, OIL, FUEL  
PUMP DRIVE SHAFT  
BEARING, ASSEMBLY

ADAPTER, FUEL PUMP



RA PD 24564

**Figure 46—Drive Gear Bearing Oil Seal Installation**

pin out of the gear and shaft with a small drift and a hammer. Place the fuel pump drive gear puller in position and pull the drive gear off the shaft. **CAUTION:** Make certain that the shaft of the puller pressing against the drive shaft of the fuel pump adapter is properly centered, with the outer edge of the puller shaft applied against the outer edge of the drive shaft. Remove the drive gear key from the drive shaft.

(b) *Remove Fuel Pump Drive Shaft* (fig. 47).

**PRESS**

**TOOL**, removing, fuel pump  
drive shaft

**SCREWDRIVER**

Place the fuel pump adapter on a press with the splined end of the drive shaft down. Place the removing tool in position against the drive gear end of the drive shaft and press the shaft out of the adapter.

(c) *Remove Fuel Pump Drive Shaft Bearing Oil Seal* (fig. 46).

**PULLER**, oil seal

Place the adapter on a bench with the oil seal end of the adapter up and pull the oil seal out of the adapter with an oil seal puller.

(d) *Remove Fuel Pump Drive Shaft Bearings* (figs. 48, 49, 50).

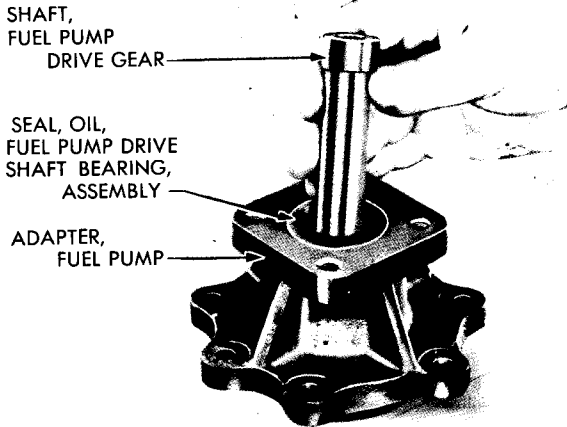
**PLIERS**, long nosed

Using a pair of long nosed pliers, compress snap ring sufficiently to allow it to be lifted out of adapter and remove the two bearings and the bearing spacer with the fingers.

(3) **INSPECTION OF PARTS.**

Check the bearings and spacer for wear or damage. Replace if necessary. Check the drive shaft and the drive gear for damage. Replace if necessary. Always replace the drive shaft bearing oil seal.

## FUEL PUMP



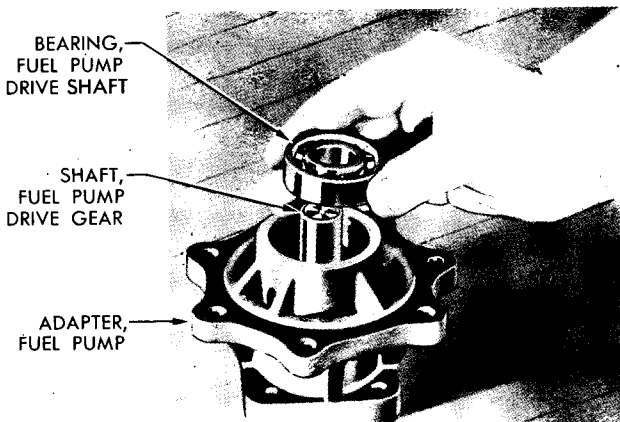
RA PD 24565

**Figure 47—Fuel Pump Drive Shaft Installation**

### (4) ASSEMBLE FUEL PUMP ADAPTER ASSEMBLY.

DRIFT  
HAMMER  
PRESS  
PUNCH  
REAMER, taper

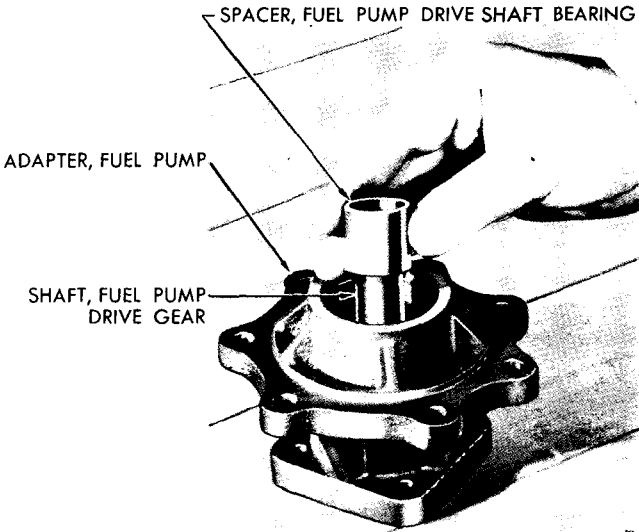
SCREWDRIVER  
TOOL, countersinking,  $\frac{3}{16}$ -in. x  
90-degree  
TOOL, installing, oil seal



RA PD 25377

**Figure 48—Drive Shaft Bearing Installation**

**ORDNANCE MAINTENANCE—POWER UNIT ACCESSORIES  
FOR MEDIUM TANKS M3A4 AND M4A4**



RA PD 25392

**Figure 49—Drive Shaft Bearing Spacer Installation**

(a) *Install Fuel Pump Drive Shaft Bearing Oil Seal (fig. 46).*

**PRESS**

**TOOL**, installing, oil seal

Place the fuel pump adapter on the press with the oil seal end of the adapter up. Place the oil seal in position on the adapter and, using installing tool, press the seal into place in adapter.

(b) *Install Fuel Pump Drive Shaft (fig. 47).*

**PRESS**

Place the fuel pump adapter in position on the press with the oil seal side of the adapter up. Insert the gear end of the shaft through the hole in the oil seal and press the shoulder of the shaft into the oil seal until the end of the shaft is flush with the outer surface of the oil seal.

(c) *Install Fuel Pump Drive Shaft Bearings (fig. 48).*

**PRESS**

**TOOL**, sleeve,  $\frac{5}{16}$ -in. I.D.,

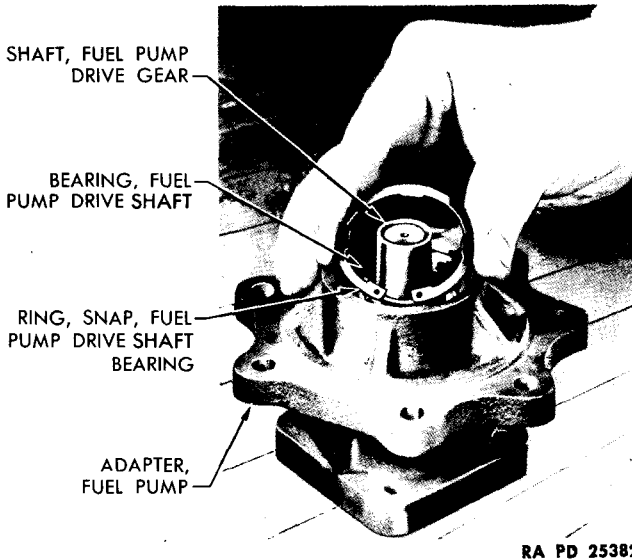
**ROUND STEEL BLOCK,**

$1\frac{1}{16}$ -in. O.D., 3-in. long

$\frac{7}{8}$ -in diam x  $\frac{1}{2}$ -in. thick

Place the adapter and shaft assembly on the press with the splined end of the shaft down. Place a  $\frac{7}{8}$ -inch diameter x  $\frac{1}{2}$ -inch thick, round, flat, steel block under the splined end of the shaft. Place the drive shaft outer bearing in position on the gear end of the shaft, and, using a sleeve tool,  $\frac{5}{16}$ -inch inside diameter x  $1\frac{1}{16}$ -inch outside diameter x 3-inch long, against the inner race of the bearing, press the bearing onto the shaft

FUEL PUMP



**Figure 50—Drive Shaft Bearing Snap Ring Installation**

until it seats firmly against the shoulder of the adapter. Slide the bearing spacer over the end of the drive shaft (fig. 49); then install the drive shaft inner bearing, repeating the operations for installing the outer bearing and pressing the inner bearing onto the shaft until the inner race is seated firmly against the spacer. Select a bearing snap ring of the correct thickness (by fitting into the ring groove in the adapter a snap ring of the greatest thickness that can be inserted in the groove and against the outer race of the inner bearing: there are three sizes of snap rings of the following thicknesses: 0.0625 inch, 0.068 inch and 0.075 inch) and press the snap ring into place in the groove with a screwdriver (fig. 50).

(d) *Install Fuel Pump Drive Gear* (fig. 52).

DRIFT, small

HAMMER

PRESS

PUNCH

REAMER, taper

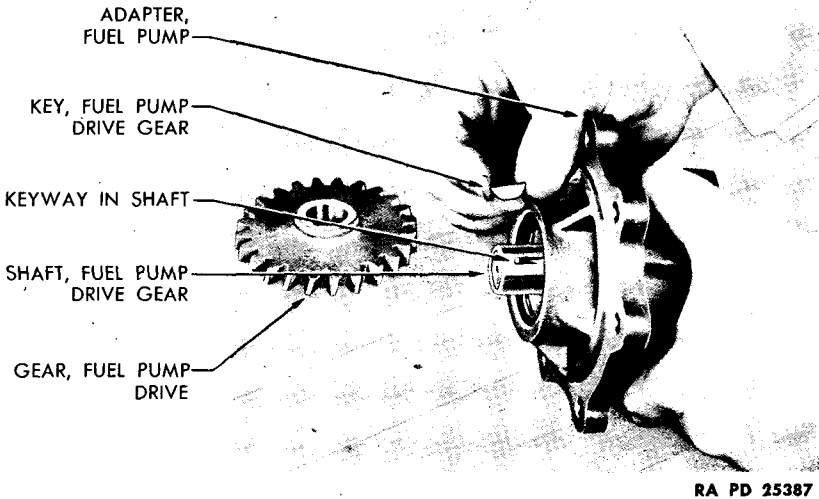
ROUND STEEL BLOCK,

$\frac{7}{8}$ -in. diam x  $\frac{1}{2}$ -in. long

TOOL, countersinking,  $\frac{3}{16}$ -in.  
x 90-degree

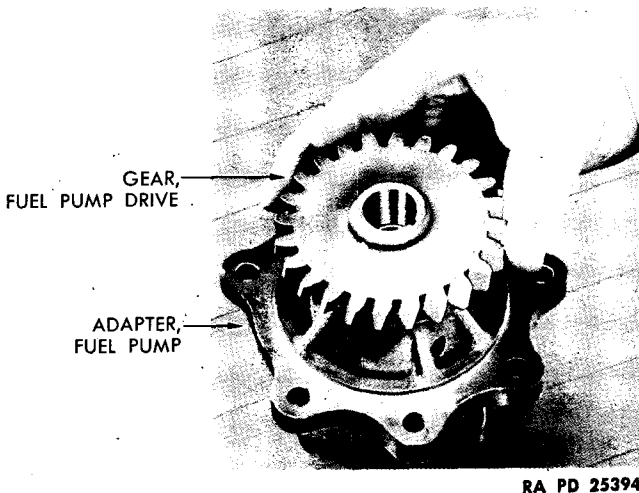
Place the adapter on the press with the splined end of the drive shaft down. Place a  $\frac{7}{8}$ -inch diameter x  $\frac{1}{2}$ -inch thick, round, flat, steel block under the splined end of the shaft. Insert the drive gear key into the slot in the shaft (fig. 51); then place the drive gear in position on the end of the shaft aligning the keyway in the gear with the key on the shaft (fig. 52) and press the gear onto the shaft until the outer shoulder of the

**ORDNANCE MAINTENANCE—POWER UNIT ACCESSORIES  
FOR MEDIUM TANKS M3A4 AND M4A4**



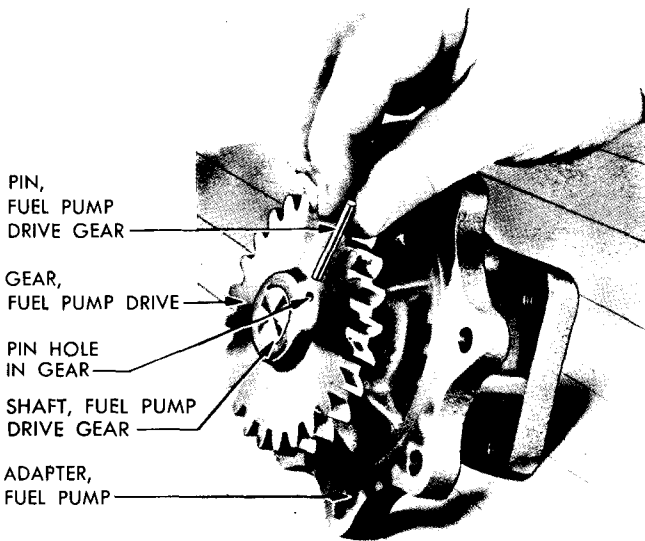
**Figure 51—Drive Gear Key Installation**

gear seats firmly against the inner race of the inner bearing. Using the  $\frac{1}{8}$ -inch hole in the gear hub as a guide, ream a tapered hole through the shaft and the gear (when reaming operation is completed, the large end of the hole should be 0.155 in.—0.157 in.). Countersink the small end of the hole with a  $\frac{3}{16}$ -inch x 90-degree countersinking tool. Drive the fuel



**Figure 52—Drive Gear Installation**

**FUEL PUMP**



RA PD 25375

**Figure 53—Drive Gear Pin Installation**

pump drive gear pin through the hole in the gear and the shaft with a small drift and a hammer (fig. 53) and stake over the small end of the pin.

**(5) INSTALLATION.**

**PLIERS**, side cutting

**WRENCH**, torque

**WRENCH**, socket, 1/2-in.

Place a new fuel pump adapter gasket in position on the gear case cover and insert the gear end of the fuel pump adapter assembly through the opening in the gear case while turning the assembly to allow the teeth in the fuel pump drive gear to mesh with the teeth in the camshaft gear. Aline the seven adapter mounting screw holes with the holes in the end of the crankcase and attach the adapter assembly to the gear case cover with one long and six short cap screws. Tighten the screws to 15—20 foot-pounds with a 1/2-inch socket wrench and torque wrench. Insert a lock wire through the holes in two pairs of cap screws and another lock wire through the holes in the other three cap screws and twist the ends of each lock wire together with side cutting pliers.



**ORDNANCE MAINTENANCE—POWER UNIT ACCESSORIES  
FOR MEDIUM TANKS M3A4 AND M4A4**

**CHAPTER 2**

**FUEL SYSTEM (Cont'd)**

**Section V**

**FUEL FILTER, AUTOMATIC FUEL SHUT-OFF VALVE, AND FUEL TANKS**

	Paragraph
Fuel filter .....	31
Automatic fuel shut-off valve .....	32
Fuel tanks .....	33

**31. FUEL FILTER.**

a. **Description** (fig. 55). The fuel filter located at the right, rear, lower corner of the power unit compartment (fig. 54) removes dirt, water, and other foreign substances from the fuel as it flows from the fuel tanks to the fuel pump. The fuel cleaning units contained in the fuel filter consists of a filter element made up of a number of 0.002-inch thick brass disks that trap dirt and water which, after being trapped by the element, settle in the bowl at the bottom of the filter, from which they are easily removed.

**b. Removal.**

(1) Refer to TM 9-754, January 21, 1943 (par. 80 a), for removal procedure.

**c. Disassembly** (fig. 56).

- |  |                           |
|--|---------------------------|
| REMOVER, stud                          | WRENCH, socket-head set   |
| WRENCH, open-end, $\frac{9}{16}$ -in.  | screw, $\frac{1}{4}$ -in. |
| WRENCH, open-end, $\frac{11}{16}$ -in. |                           |

**(1) REMOVE FILTER MAGNET AND SPRING.**

- |  |                           |
|--|---------------------------|
| WRENCH, open-end, $\frac{11}{16}$ -in. | WRENCH, socket-head set   |
|  | screw, $\frac{1}{4}$ -in. |

Remove the filter bowl nut by turning it counterclockwise with an  $\frac{11}{16}$ -inch open-end wrench. Remove the filter bowl and lift the spring and magnet out of the bowl. Remove the bowl plug by turning the plug counterclockwise with a  $\frac{1}{4}$ -inch socket-head set screw wrench.

**(2) REMOVE FILTER ELEMENT.**

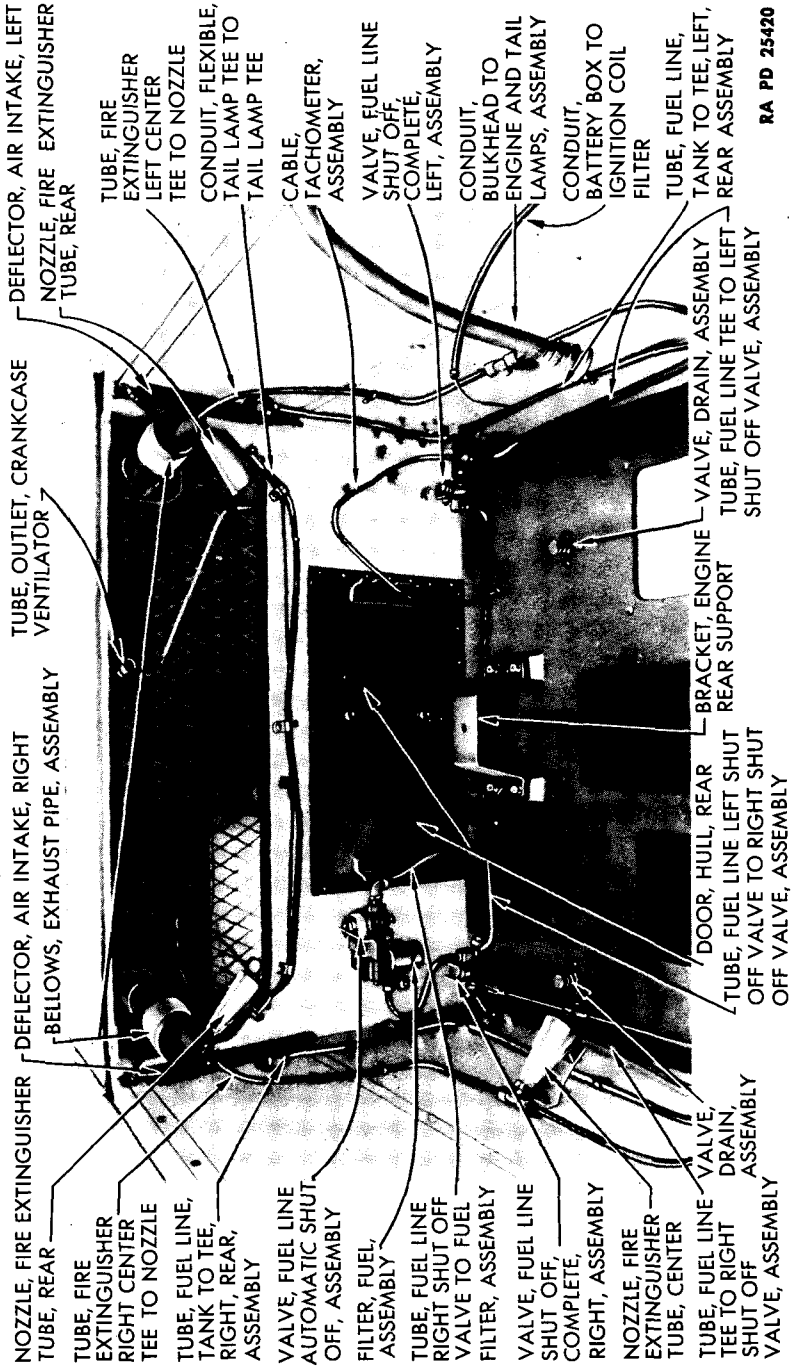
Remove the filter element nut by turning it counterclockwise with the fingers. Remove the filter element from the filter stud and remove the filter head gasket from the head.

**(3) DISASSEMBLE FUEL FILTER HEAD.**

- |               |                                       |
|---------------|---------------------------------------|
| REMOVER, stud | WRENCH, open-end, $\frac{9}{16}$ -in. |
|---------------|---------------------------------------|

Remove the two fuel filter head plugs by turning them counterclock-

FUEL FILTER, AUTOMATIC FUEL SHUT-OFF VALVE, AND FUEL TANKS

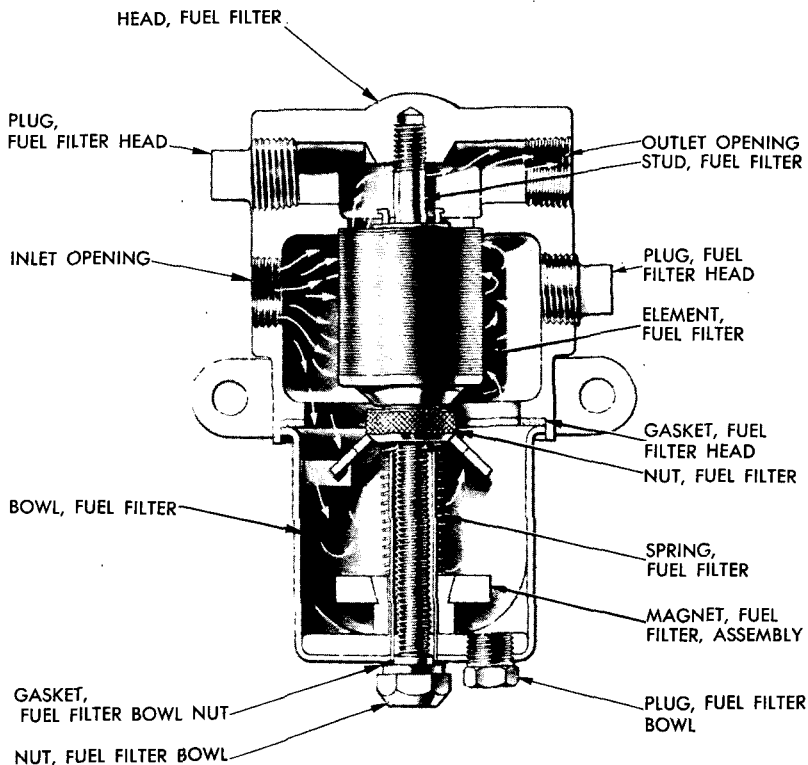


NOZZLE, FIRE EXTINGUISHER TUBE, REAR  
TUBE, FIRE EXTINGUISHER LEFT CENTER TEE TO NOZZLE  
TUBE, FUEL LINE, TANK TO TEE, RIGHT, REAR, ASSEMBLY  
VALVE, FUEL LINE AUTOMATIC SHUT-OFF, ASSEMBLY  
FILTER, FUEL, ASSEMBLY  
TUBE, FUEL LINE RIGHT SHUT OFF VALVE TO FUEL FILTER, ASSEMBLY  
VALVE, FUEL LINE SHUT OFF COMPLETE, RIGHT, ASSEMBLY  
NOZZLE, FIRE EXTINGUISHER TUBE, CENTER  
TUBE, FUEL LINE TEE TO RIGHT SHUT OFF VALVE, ASSEMBLY  
DEFLECTOR, AIR INTAKE, RIGHT BELLOWS, EXHAUST PIPE, ASSEMBLY  
TUBE, OUTLET, CRANKCASE VENTILATOR  
DEFLECTOR, AIR INTAKE, LEFT NOZZLE, FIRE EXTINGUISHER TUBE, REAR  
TUBE, FIRE EXTINGUISHER LEFT CENTER TEE TO NOZZLE  
CONDUIT, FLEXIBLE, TAIL LAMP TEE TO TAIL LAMP TEE  
CABLE, TACHOMETER, ASSEMBLY  
VALVE, FUEL LINE SHUT OFF COMPLETE, LEFT, ASSEMBLY  
CONDUIT, BULKHEAD TO ENGINE AND TAIL LAMPS, ASSEMBLY  
CONDUIT, BATTERY BOX TO IGNITION COIL FILTER  
TUBE, FUEL LINE, TANK TO TEE, LEFT, REAR ASSEMBLY  
VALVE, DRAIN, ASSEMBLY TUBE, FUEL LINE TEE TO LEFT SHUT OFF VALVE, ASSEMBLY  
DOOR, HULL, REAR  
BRACKET, ENGINE REAR SUPPORT  
TUBE, FUEL LINE LEFT SHUT OFF VALVE TO RIGHT SHUT OFF VALVE, ASSEMBLY

RA PD 25420

Figure 54—Power Unit Compartment Rear End—Power Unit M4A4

**ORDNANCE MAINTENANCE—POWER UNIT ACCESSORIES  
FOR MEDIUM TANKS M3A4 AND M4A4**



RA PD 25269

**Figure 55—Zenith Fuel Filter—Cross Sectional View**

wise with a  $\frac{9}{16}$ -inch open-end wrench and remove the fuel filter stud with a stud remover.

**d. Inspection and Cleaning of Parts.**

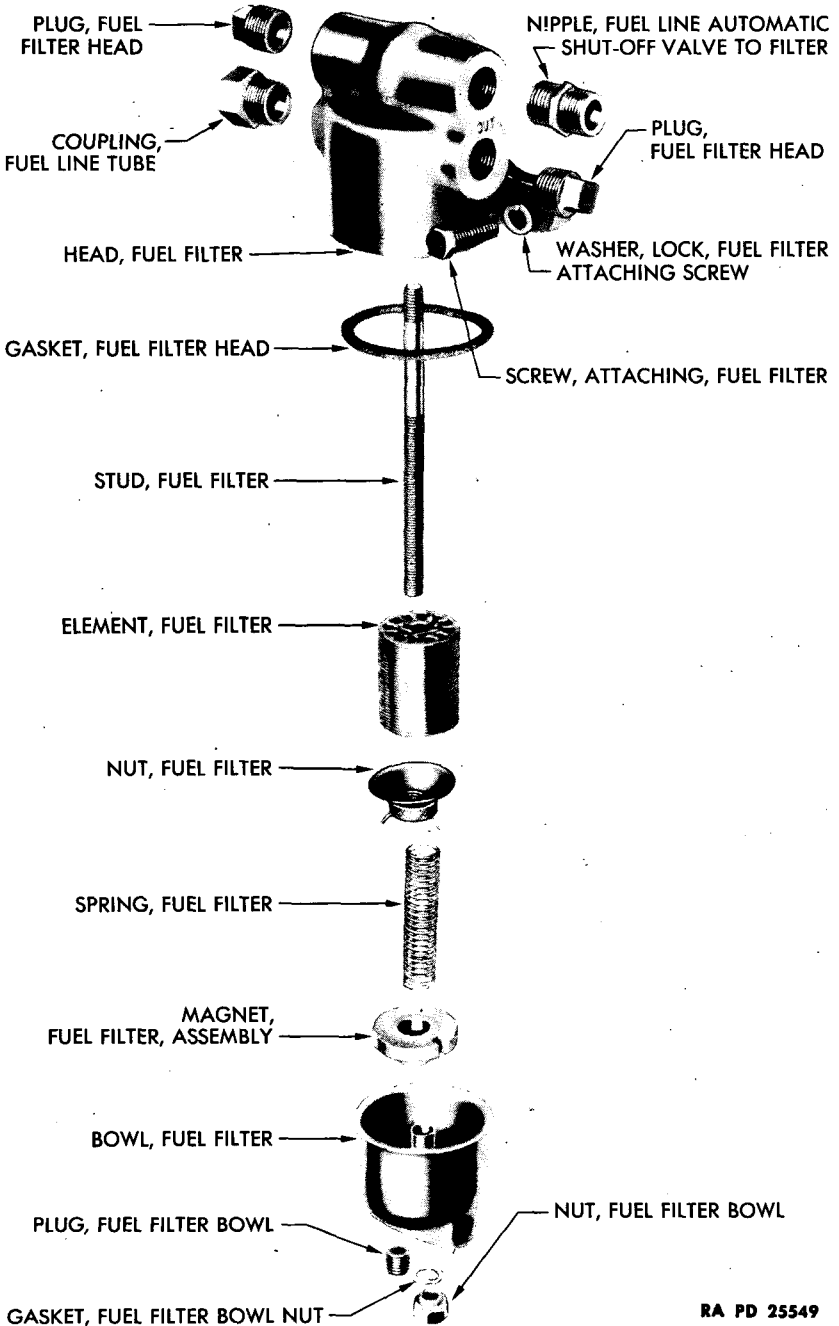
(1) Inspect the filter element for evidence of damage. Replace any damaged parts of filter. Always replace the filter bowl gasket and the filter bowl nut gasket.

**(2) CLEAN FUEL FILTER.**

(a) Hold the element disks firmly together and rinse thoroughly with SOLVENT, dry-cleaning, to remove any dirt which may have hardened on the surfaces of the disks. Hold the filter element nut over one end of the element and apply compressed air to the other end of the element to remove all dirt from the inside.

(b) Apply compressed air to the magnet to remove any filings that may have accumulated.

**FUEL FILTER, AUTOMATIC FUEL SHUT-OFF VALVE, AND FUEL TANKS**



RA PD 25549

**Figure 56—Parts of Zenith Fuel Filter**

**ORDNANCE MAINTENANCE—POWER UNIT ACCESSORIES  
FOR MEDIUM TANKS M3A4 AND M4A4**

(c) Wash the spring with SOLVENT, dry-cleaning, and apply compressed air to the spring and to the filter bowl.

**e. Assembly (fig. 56).**

TOOL, stud installing

WRENCH, socket-head set screw, 1/4-in.

WRENCH, open-end, 9/16-in.

WRENCH, open-end, 1 1/16-in.

**(1) ASSEMBLE FUEL FILTER HEAD.**

TOOL, stud installing

WRENCH, open-end, 9/16-in.

Screw the two fuel filter head plugs into the filter head and tighten the plugs securely by turning them clockwise with a 9/16-inch open-end wrench. Screw the short threaded end of the fuel filter stud into the head and tighten the stud securely by turning clockwise with a stud installing tool.

**(2) INSTALL FILTER ELEMENT.**

Slide the filter element over the end of the fuel filter stud, screw the filter element nut onto the stud, and tighten the nut securely with the fingers. CAUTION: Do not use tools to tighten the element nut and never twist the element.

**(3) INSTALL FUEL FILTER BOWL.**

WRENCH, open-end, 1 1/16-in.

WRENCH, socket-head set screw, 1/4-in.

Screw the fuel filter bowl plug into place in the bowl and tighten the plug securely by turning it clockwise with a 1/4-inch socket-head set screw wrench. Slide the magnet into place over the standpipe in the filter bowl. Slide the spring into place over the standpipe. Place a new filter head gasket in position on the filter head; then raise the filter bowl into position against the head, sliding the filter element stud through the spring and through the filter bowl standpipe. Hold the filter head and bowl together and slide a new bowl nut gasket over the end of the element stud. Screw the filter bowl nut onto the element stud and tighten the nut securely by turning it clockwise with a 1 1/16-inch open-end wrench.

**f. Installation.**

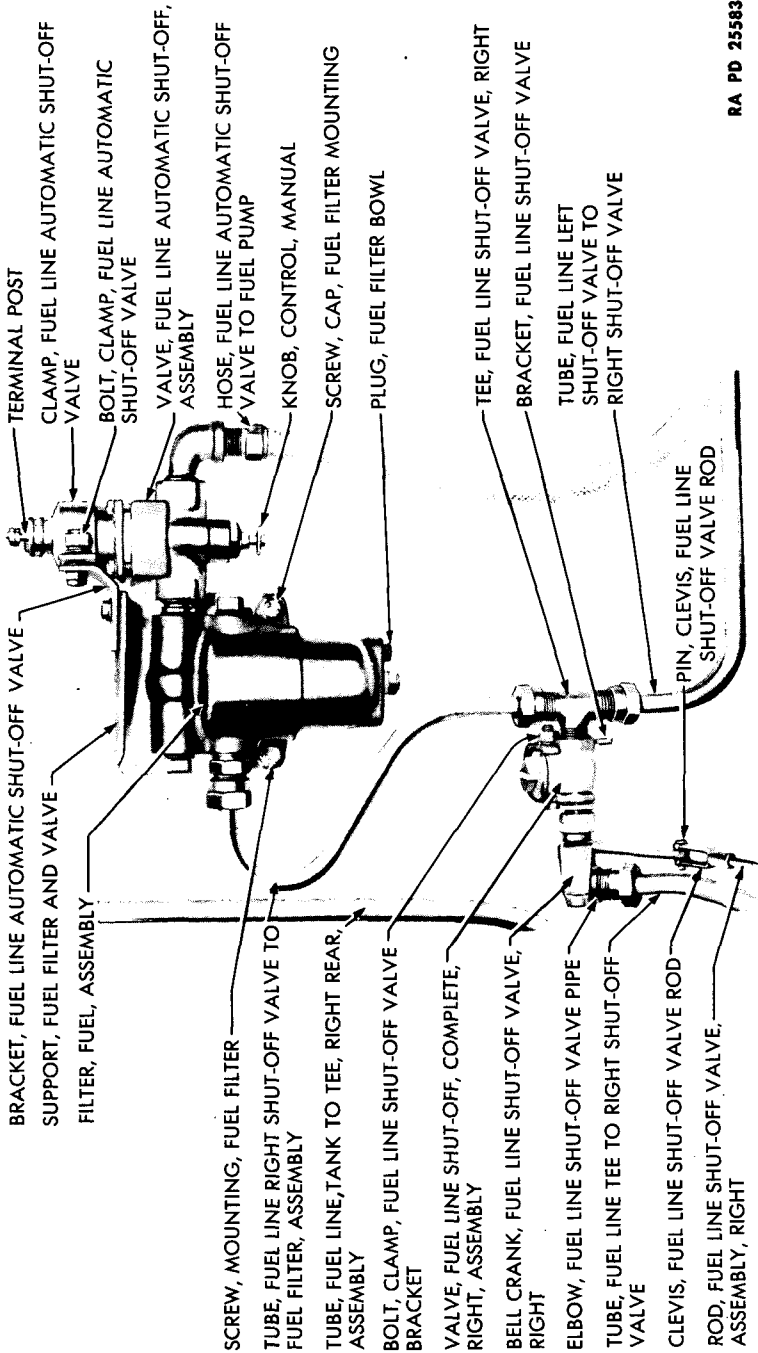
(1) Refer to TM 9-754, January 21, 1943 (par. 80 b), for installation procedure.

**32. AUTOMATIC FUEL SHUT-OFF VALVE.**

**a. Description (figs. 54 and 57).**

(1) The automatic fuel shut-off valve, mounted on the fuel filter support (fig. 57) and connected to the fuel filter, is used to supplement the manual fuel control shut-off valves. When the ignition switch is turned off, the automatic fuel shut-off valve immediately closes and prevents

FUEL FILTER, AUTOMATIC FUEL SHUT-OFF VALVE, AND FUEL TANKS



RA PD 25583

Figure 57 - Fuel Filter, Manual Controlled Shut-off Valve, and Solenoid Shut-off Valve

**ORDNANCE MAINTENANCE—POWER UNIT ACCESSORIES  
FOR MEDIUM TANKS M3A4 AND M4A4**

fuel from flowing to the fuel pump until the operator has turned off the manual control shut-off valves. NOTE: The automatic fuel shut-off valve does not obviate the necessity of closing the manual control shut-off valves. These should always be closed as soon as possible after the ignition switch has been turned off or after the power unit has ceased to operate.

**h. Removal.**

(1) Refer to TM 9-754, January 21, 1943 (par. 78 e (1)), for removal procedure.

**c. Disassembly (figs. 58 and 59).**

PLIERS, long nosed	WISE
PLIERS, side cutting	WRENCH, open-end, $\frac{5}{16}$ -in.
SCREWDRIVER, large	WRENCH, open-end, 1-in.
SCREWDRIVER, small	WRENCH, socket, special,
TOOL, packing retainer bush- ing removing and installing (special, General Controls)	$\frac{7}{8}$ -in.

(1) REMOVE VALVE SEAT.

PLIERS, side cutting	WISE
SCREWDRIVER, large	WRENCH, socket, special,
SCREWDRIVER, small	$\frac{7}{8}$ -in.
TOOL, packing retainer bush- ing removing and installing (special, General Controls)	

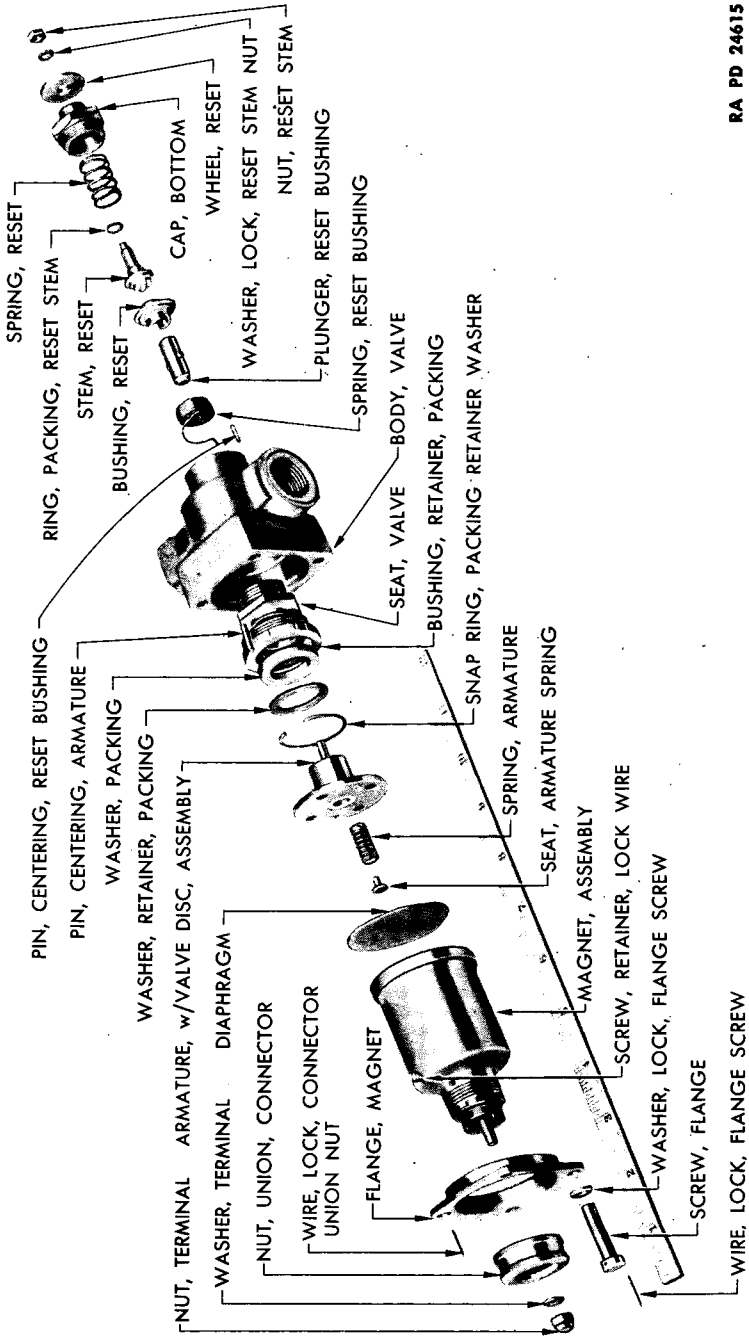
Remove the lock wires from the magnet flange screws with side cutting pliers and remove the screws and lock washers (screwdriver). Lift the magnet assembly off the valve body and remove the diaphragm. Lift the armature spring and spring seat out of the armature and remove the armature and valve disk assembly from the valve body with the fingers. Remove the armature centering pin from the valve body, turning the pin counterclockwise with a small screwdriver. Pry out the packing retainer washer snap ring with a small screwdriver and remove the packing retainer washer and the packing washer with the fingers. Place the valve body assembly in position in a vise and remove the packing retainer bushing by turning it counterclockwise with a bushing removing tool. Remove the valve seat by turning it counterclockwise with a special  $\frac{7}{8}$ -inch socket wrench.

(2) REMOVE MANUAL RESET MECHANISM.

PLIERS, long nosed	WRENCH, open-end, 1-in.
WRENCH, open-end, $\frac{5}{16}$ -in.	

Remove the reset stem nut and lock washer, turning the nut counter-

FUEL FILTER, AUTOMATIC FUEL SHUT-OFF VALVE, AND FUEL TANKS

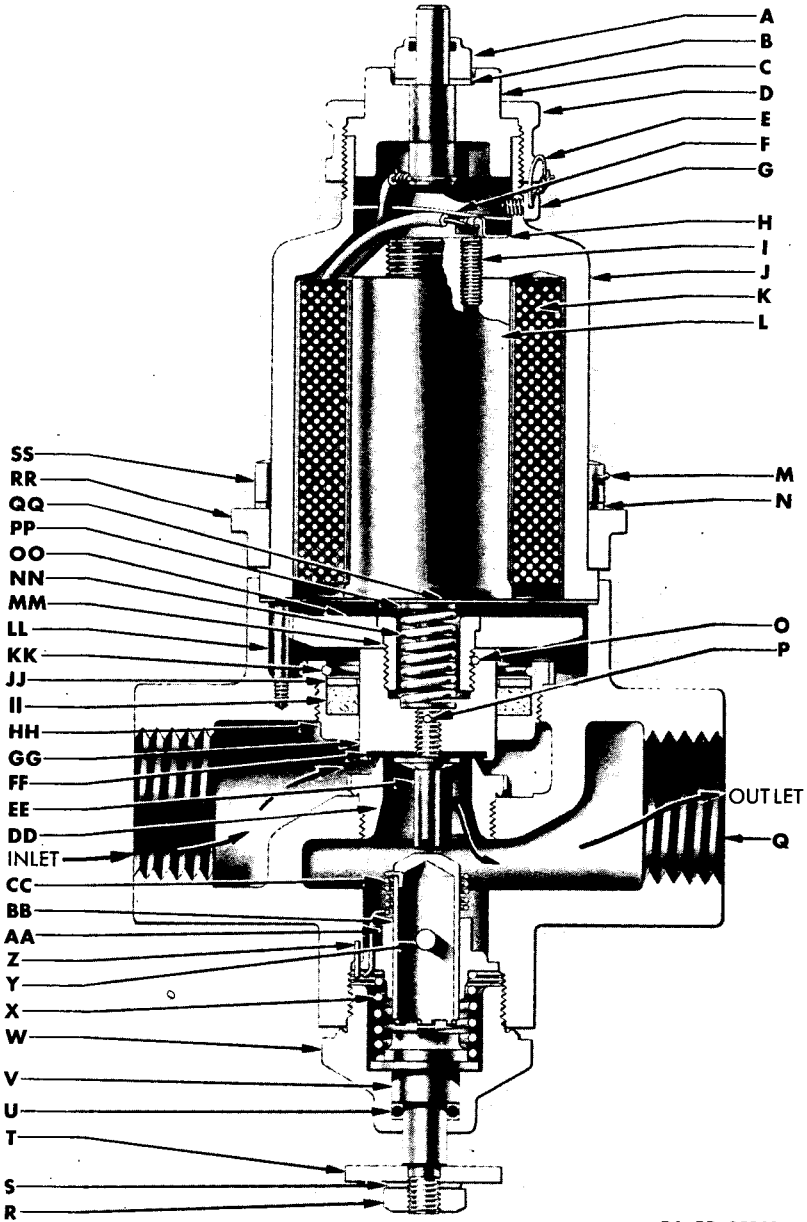


RA PD 24615

Figure 58—Parts of Automatic Fuel Shut-off Valve



ORDNANCE MAINTENANCE—POWER UNIT ACCESSORIES  
FOR MEDIUM TANKS M3A4 AND M4A4



RA PD 25261

Figure 59—Automatic Fuel Shut-off Valve—Cross Sectional View

**FUEL FILTER, AUTOMATIC FUEL SHUT-OFF VALVE, AND FUEL TANKS**

- |   |   |
|---|---|
| <b>A</b> —NUT, TERMINAL                   | <b>X</b> —SPRING, RESET                       |
| <b>B</b> —WASHER, TERMINAL                | <b>Y</b> —PIN, RESET BUSHING PLUNGER          |
| <b>C</b> —INSULATOR, TERMINAL CONNECTOR   | <b>Z</b> —PIN, CENTERING, RESET BUSHING       |
| <b>D</b> —NUT, UNION, CONNECTOR           | <b>AA</b> —BUSHING, RESET                     |
| <b>E</b> —WIRE, LOCK, CONNECTOR UNION NUT | <b>BB</b> —PLUNGER, RESET BUSHING             |
| <b>F</b> —WASHER, INSULATION              | <b>CC</b> —SPRING, RESET BUSHING              |
| <b>G</b> —SCREW, RETAINER, LOCK WIRE      | <b>DD</b> —SEAT, VALVE                        |
| <b>H</b> —TERMINAL, GROUND                | <b>EE</b> —SCREW, VALVE DISC                  |
| <b>I</b> —SCREW, GROUND TERMINAL          | <b>FF</b> —DISC, VALVE                        |
| <b>J</b> —HOUSING, MAGNET                 | <b>GG</b> —HOUSING, VALVE                     |
| <b>K</b> —MAGNET                          | <b>HH</b> —BUSHING, RETAINER, PACKING         |
| <b>L</b> —CORE, MAGNET                    | <b>II</b> —WASHER, PACKING                    |
| <b>M</b> —WIRE, LOCK, FLANGE SCREW        | <b>JJ</b> —WASHER, RETAINER, PACKING          |
| <b>N</b> —WASHER, LOCK, FLANGE SCREW      | <b>KK</b> —SNAP RING, PACKING RETAINER WASHER |
| <b>O</b> —PIN, ARMATURE SPRING RETAINER   | <b>LL</b> —PIN, CENTERING, ARMATURE           |
| <b>P</b> —PIN, VALVE DISC SCREW           | <b>MM</b> —RETAINER, ARMATURE SPRING          |
| <b>Q</b> —BODY, VALVE                     | <b>NN</b> —SPRING, ARMATURE                   |
| <b>R</b> —NUT, RESET STEM                 | <b>OO</b> —ARMATURE                           |
| <b>S</b> —WASHER, LOCK, RESET STEM NUT    | <b>PP</b> —SEAT, ARMATURE SPRING              |
| <b>T</b> —WHEEL, RESET                    | <b>QQ</b> —DIAPHRAGM                          |
| <b>U</b> —RING, PACKING, RESET STEM       | <b>RR</b> —FLANGE, MAGNET                     |
| <b>V</b> —STEM, RESET                     | <b>SS</b> —SCREW, FLANGE                      |
| <b>W</b> —CAP, BOTTOM                     |   |

RA PD 25261B

**Legend for Figure 59—Automatic Fuel Shut-off Valve—Cross Sectional View**

**ORDNANCE MAINTENANCE—POWER UNIT ACCESSORIES  
FOR MEDIUM TANKS M3A4 AND M4A4**

clockwise with a  $\frac{5}{16}$ -inch open-end wrench. Remove the reset wheel with the fingers. Remove the bottom cap, turning it counterclockwise with a 1-inch open-end wrench, and remove the reset spring, stem, packing ring, and the reset bushing assembly with the fingers. **CAUTION:** Do not disassemble the reset bushing assembly. The reset bushing assembly is serviced as an assembly to prevent damage to the reset bushing spring. Remove the reset bushing centering pin from the valve body with long nosed pliers.

**(3) REMOVE MAGNET FLANGE.**

Slide the magnet flange off the magnet. **CAUTION:** Do not remove the terminal connector insulator from the magnet housing. The magnet, housing, and terminal connector are serviced as one assembly to prevent damage to the connector.

**d. Inspection and Cleaning of Parts.**

Inspect all parts for excessive wear or damage. Replace any necessary parts. Always replace the packing washer and the reset stem packing ring. Wash the diaphragm, armature and valve disk assembly, packing retainer bushing, valve seat, valve body, and springs with SOLVENT, dry-cleaning, and blow off with compressed air.

**e. Assembly (figs. 58 and 59).**

DRIFT, small	WISE
HAMMER	WRENCH, open-end, $\frac{5}{16}$ -in.
PLIERS, side cutting	WRENCH, open-end, 1-in.
SCREWDRIVER, large	WRENCH, socket, special,
SCREWDRIVER, small	$\frac{7}{8}$ -in.
TOOL, packing retainer bushing removing and installing (special, General Controls)	

**(1) INSTALL ARMATURE W/VALVE DISK ASSEMBLY.**

SCREWDRIVER, small	WISE
TOOL, packing retainer bushing removing and installing (special, General Controls)	WRENCH, socket, special,
	$\frac{7}{8}$ -in.

Screw the valve seat into the valve body and tighten securely by turning the seat clockwise with a special  $\frac{7}{8}$ -inch socket wrench. Screw the packing retainer bushing into the valve body and tighten securely with a special installing tool. Screw the armature centering pin into the valve body and tighten securely with a small screwdriver. Place a new packing washer in position in the packing retainer bushing and place the packing retainer washer in position on the packing washer. Place the packing washer snap ring in position in the valve body and press it into

## FUEL FILTER, AUTOMATIC FUEL SHUT-OFF VALVE, AND FUEL TANKS

place with a small screwdriver. Aline the slot in the armature with the armature centering pin and drop the armature and valve disk assembly into place in the valve body.

### (2) INSTALL THE MAGNET ASSEMBLY.

PLIERS, side cutting                      SCREWDRIVER, large

Slide the armature spring into place in the armature and slide the armature spring seat into place in the spring. Place the diaphragm in position on top of the armature spring seat, centering the diaphragm so that it will enter the valve body when the magnet is installed. Slide the magnet flange over the small end of the magnet housing with the flanged side of the flange toward the terminal end of the magnet. Place the magnet and flange assembly in position on the valve body, alining the holes in the flange with the tapped holes in the valve body and attach the magnet to the valve body with the flange screws and lock washers. Tighten the flange screws securely with a large screwdriver. Insert a lock wire through the holes in each pair of flange screws and twist the ends of each lock wire together with side cutting pliers.

### (3) INSTALL MANUAL RESET MECHANISM.

DRIFT, small                                  WRENCH, open-end,  $\frac{5}{16}$ -in.  
HAMMER    WRENCH, open-end, 1-in.

Drive the reset bushing centering pin into place in the valve body with a small drift and hammer. Aline the slot in the side of the reset bushing with the centering pin and insert the reset bushing assembly into the valve body with the spring end of the bushing assembly toward the valve. Place the reset stem in position on the reset bushing with the threaded end of the stem out. Place a new reset stem packing ring in position on the stem. Slide the reset spring over the threaded end of the reset stem. Slide the bottom cap over the threaded end of the reset stem with the threaded end of the bottom cap toward the valve body. Be sure that the end of the reset spring enters the opening in the bottom cap and screw the cap into the valve body. Tighten the cap securely with a 1-inch open-end wrench. Place the reset wheel in position on the reset stem and secure the wheel in place with the reset stem lock washer and nut. Tighten the nut securely with a  $\frac{5}{16}$ -inch open-end wrench.

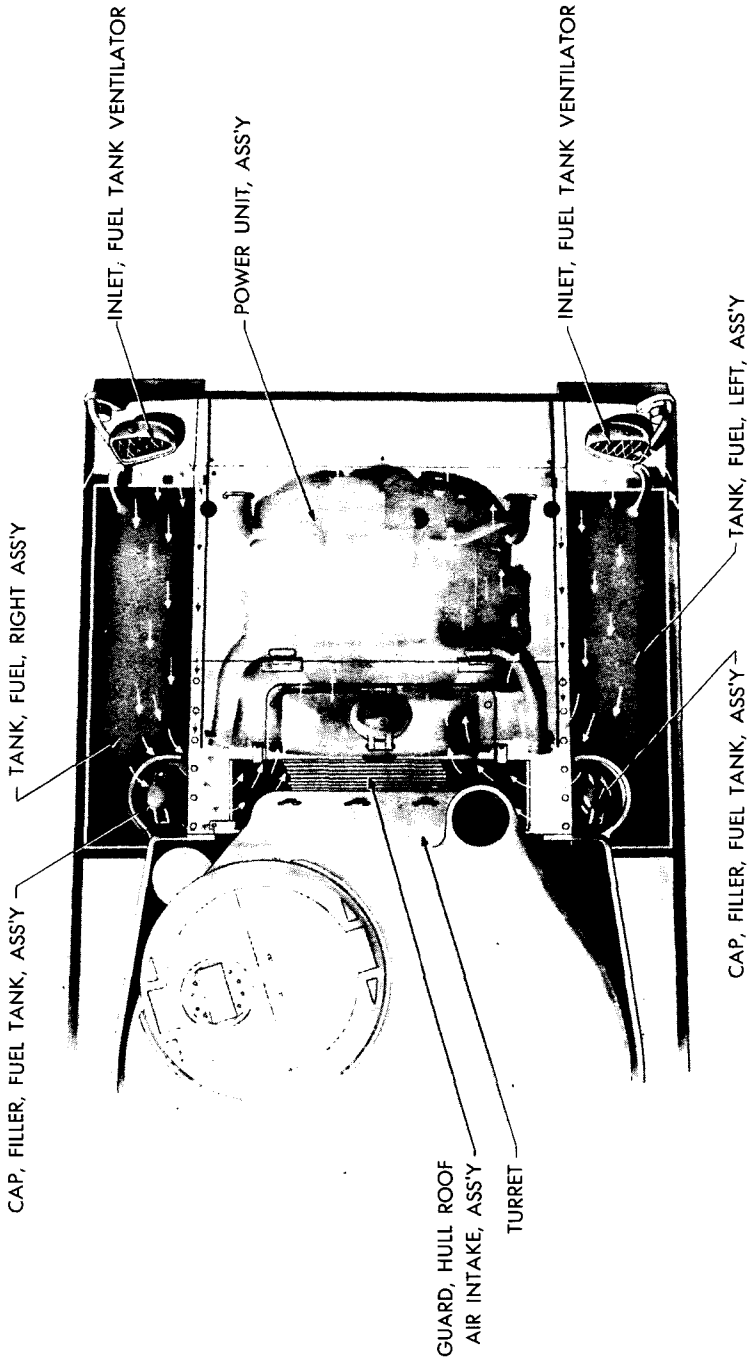
#### f. Installation.

(1) Refer to TM 9-754, January 21, 1943 (par. 78 e (2)), for installation procedure.

## 33. FUEL TANKS.

a. **Description** (fig. 60). Two types of fuel tanks have been used in the M4A4 Tank. In the vehicles built up to, and including, vehicle serial number 17793, two tanks, each having a capacity of approximately 80

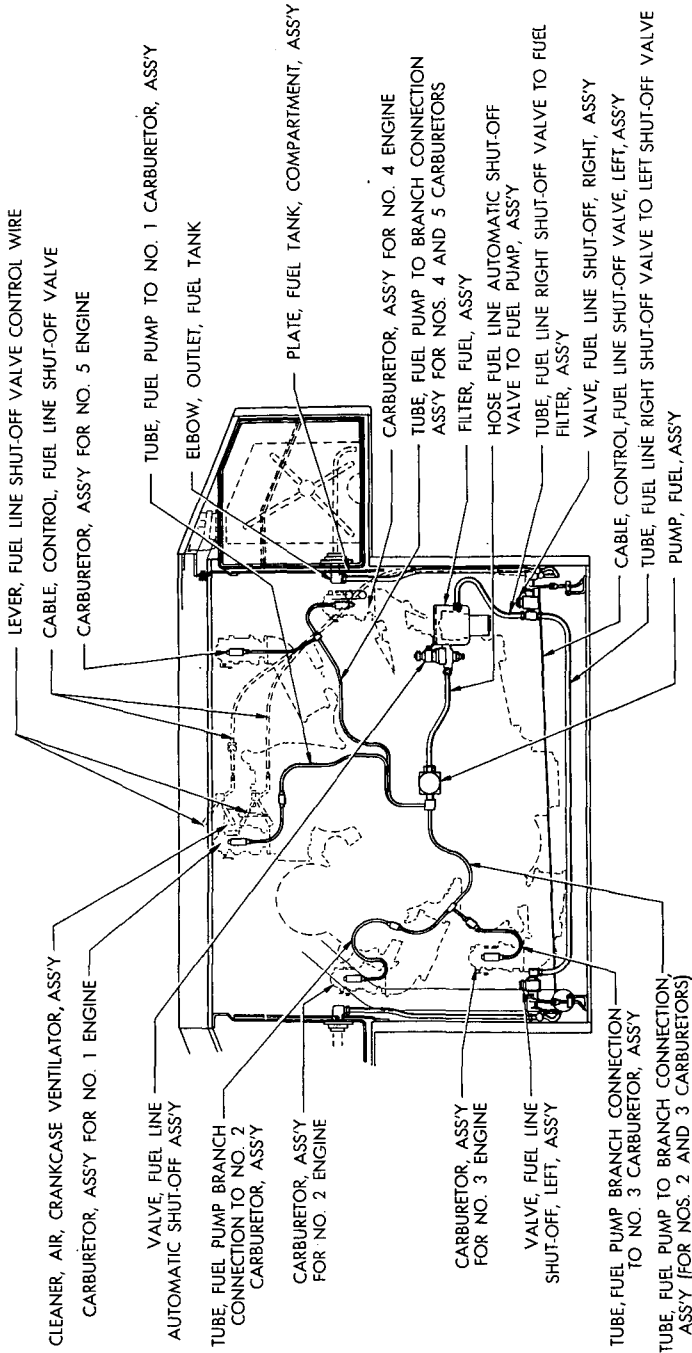
ORDNANCE MAINTENANCE—POWER UNIT ACCESSORIES  
FOR MEDIUM TANKS M3A4 AND M4A4



RA PD 25267

Figure 60—Fuel Tank Ventilation

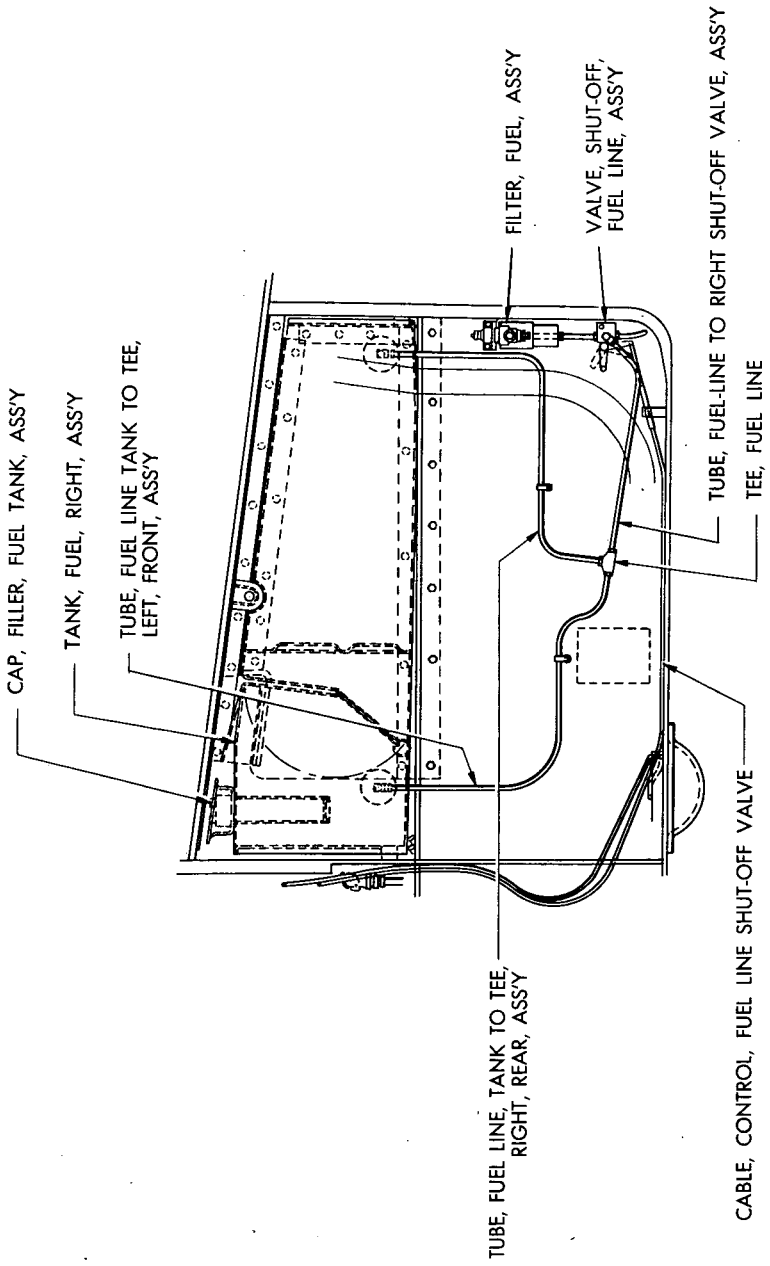
FUEL FILTER, AUTOMATIC FUEL SHUT-OFF VALVE, AND FUEL TANKS



RA PD 25272

Figure 61—Fuel System—End View

ORDNANCE MAINTENANCE—POWER UNIT ACCESSORIES  
FOR MEDIUM TANKS M3A4 AND M4A4



RA PD 25273

Figure 62—Fuel System—Side View

**FUEL FILTER, AUTOMATIC FUEL SHUT-OFF VALVE, AND FUEL TANKS**

gallons, supply the fuel for the fuel system. The tanks are cooled by air drawn through openings in the top of each grouser compartment. The air flows into the fuel tank compartment through holes in the hull rear plate. The air passes over and around the tanks and then into the fan compartment. Each tank has fuel outlets at both ends allowing the fuel to be drawn to the fuel pump when traveling over rough terrain or climbing over a vertical obstacle (figs. 61 and 62). In vehicle serial number 17794, and above, the size of the fuel tank was decreased to allow the passage of more cooling air through the sponson compartment. The same method of cooling is used. The capacity of each fuel tank was reduced to approximately 70 gallons. These smaller tanks have only one fuel outlet, which is at the rear end. The ability to draw fuel with the tank tilted is accomplished by baffling inside the fuel tank. The tanks are insulated against heat by metal foil shielding that completely encircles each tank. **CAUTION:** The metal foil shielding must not be removed from the fuel tanks.

**b. Removal.**

(1) Refer to TM 9-754, January 21, 1943 (par. 77 c), for removal procedure.

**c. Installation.**

(1) Refer to TM 9-754, January 21, 1943 (par. 77 d), for installation procedure.



**ORDNANCE MAINTENANCE—POWER UNIT ACCESSORIES  
FOR MEDIUM TANKS M3A4 AND M4A4**

**CHAPTER 3**

**POWER UNIT LUBRICATING SYSTEM**

**Section I**

**DESCRIPTION OF SYSTEM**

	Paragraph
Description .....	34
Tabulated data and specifications .....	35
Second echelon operations .....	36
Echelon break-down of maintenance .....	37

**34. DESCRIPTION.**

a. An oil supply tank, mounted in the fighting compartment of the vehicle (fig. 63) supplies oil for the power unit. On the Model M3A4 the supply tank has an extension through the bulkhead into the power unit compartment (fig. 64) and this section incorporates the hopper which separates the air from the oil. On the Model M4A4 the supply tank is entirely inside the fighting compartment with the hopper placed in one end of the supply tank (figs. 65 and 66). A cooler, mounted in the bulkhead of the vehicle (fig. 63), provides a means of cooling the oil before it enters the oil supply tank. A pressure oil pump, mounted on the bottom of the crankcase (fig. 70) and driven by the accessory shaft, supplies oil to the moving parts of the power unit. A scavenger pump (fig. 70), mounted on the bottom of the crankcase and driven by the accessory shaft, collects the oil as it accumulates in the bottom of the crankcase and returns it to the oil supply tank. The bottom of the crankcase is covered by an oil pan (fig. 71) which is equipped with a screen to strain the oil. Cored passages in the oil pan and crankcase control the flow of oil to and from the oil pumps (fig. 71).

b. The pressure oil pump draws oil from the oil supply tank, through a tube, (figs. 66, 67, 68 and 69) and discharges it through internal passages in the distributor end of the crankcase to each of the five individual engine cylinder blocks. Bypass valves (fig. 70), built into pressure pump, regulate pressure in oiling system. The oil enters an oil gallery, located on the right-hand side of the cylinder block and extending the full length of the cylinder block. From this gallery it is forced through drilled passages to the camshaft bearings, crankshaft main bearings and through a drilled passage from the No. 1 camshaft bearing and through a tube, to the timing gears. Drilled passages in the crankshaft,

DESCRIPTION OF SYSTEM

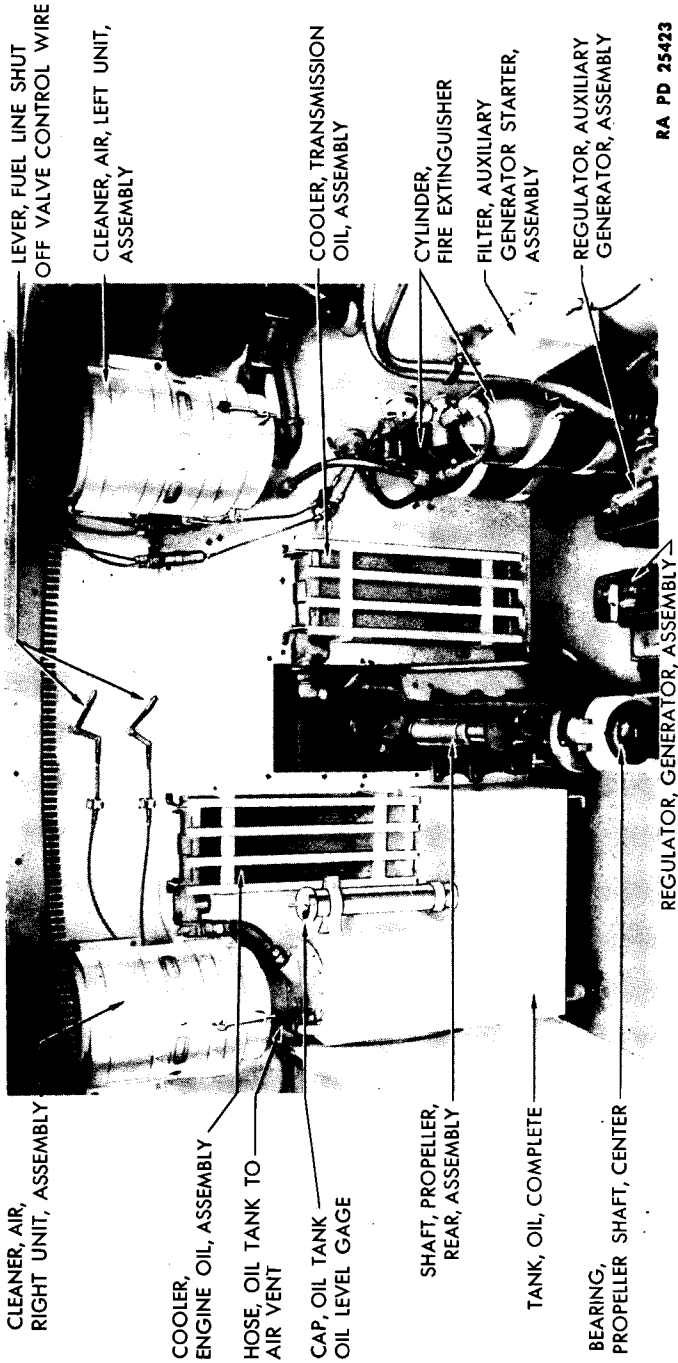
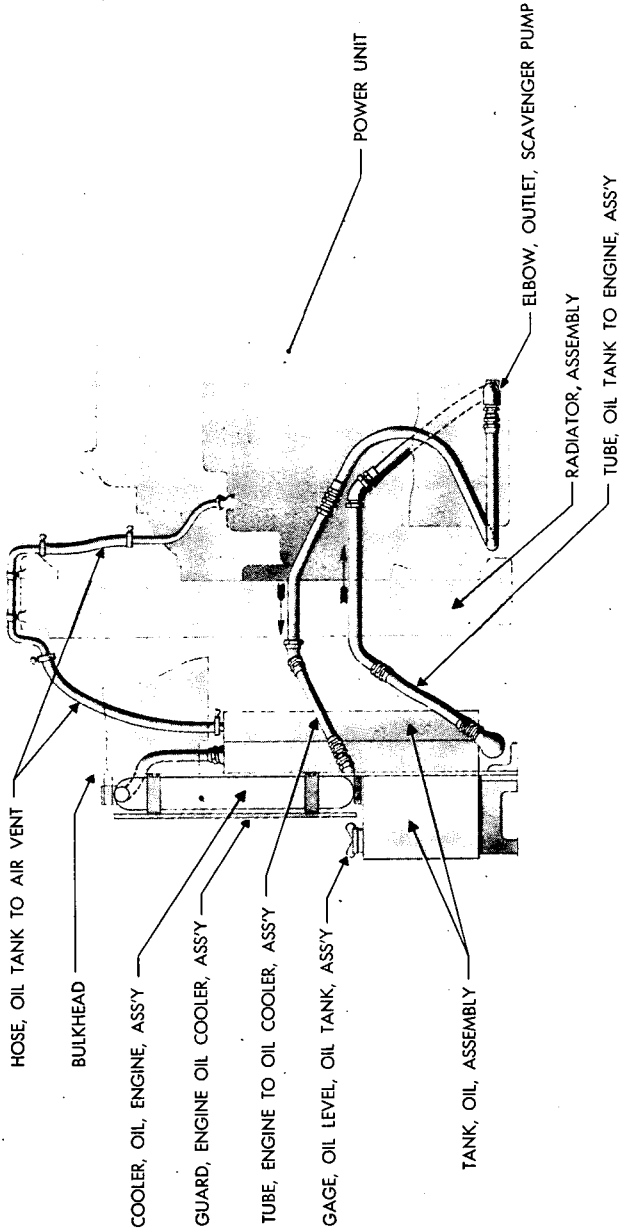


Figure 63—M4A4 Bulkhead—Showing Location of Oil Supply Tank, Oil Cooler, and Carburetor Air Cleaners

RA PD 25423

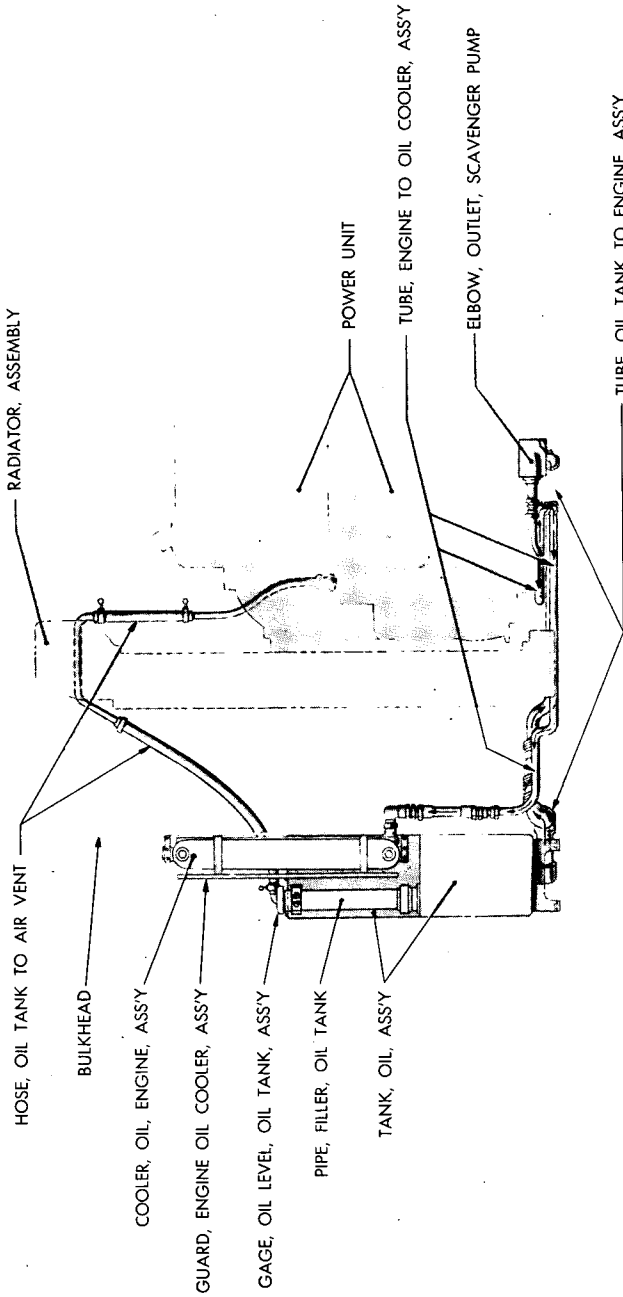
**ORDNANCE MAINTENANCE—POWER UNIT ACCESSORIES  
FOR MEDIUM TANKS M3A4 AND M4A4**



RA PD 25260

**Figure 64—M3A4 Power Unit Lubrication System—Elevation View**

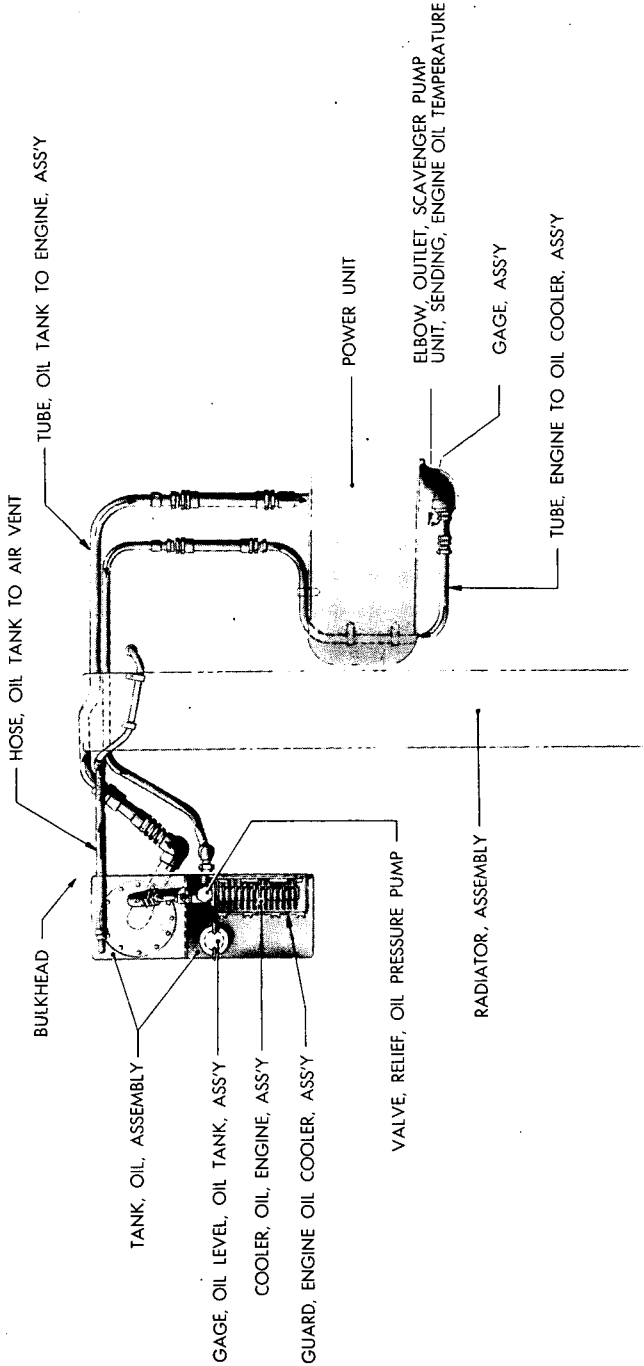
DESCRIPTION OF SYSTEM



RA PD 25257

Figure 65—M4A4 Power Unit Lubrication System—Elevation View

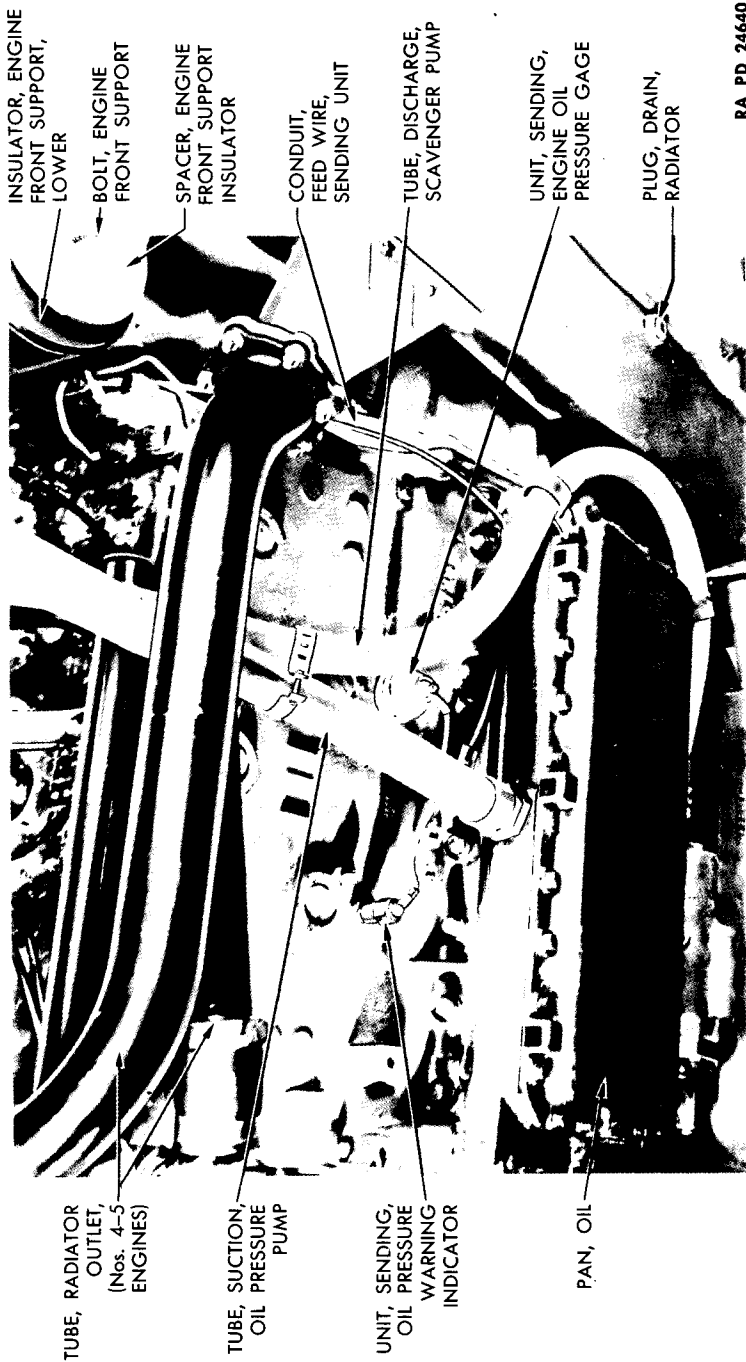
ORDNANCE MAINTENANCE—POWER UNIT ACCESSORIES  
FOR MEDIUM TANKS M3A4 AND M4A4



RA PD 25258

Figure 66—M4A4 Power Unit Lubrication System—Plan View

DESCRIPTION OF SYSTEM



RA PD 24640

Figure 67 — M3A4 Power Unit Oil Tubes—Bottom and Right Side

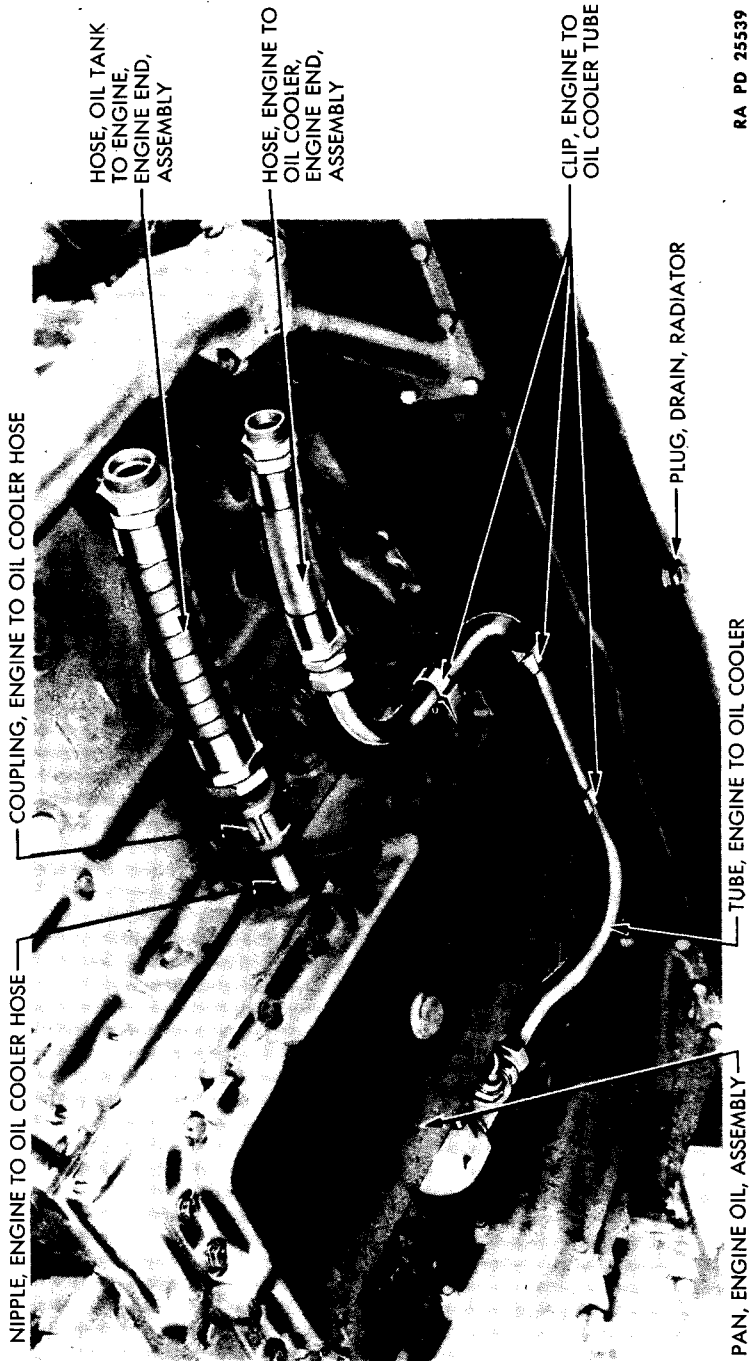
ORDNANCE MAINTENANCE—POWER UNIT ACCESSORIES  
FOR MEDIUM TANKS M3A4 AND M4A4



RA PD 25540

Figure 68—M4A4 Power Unit Oil Tubes—Bottom and Left Side

DESCRIPTION OF SYSTEM

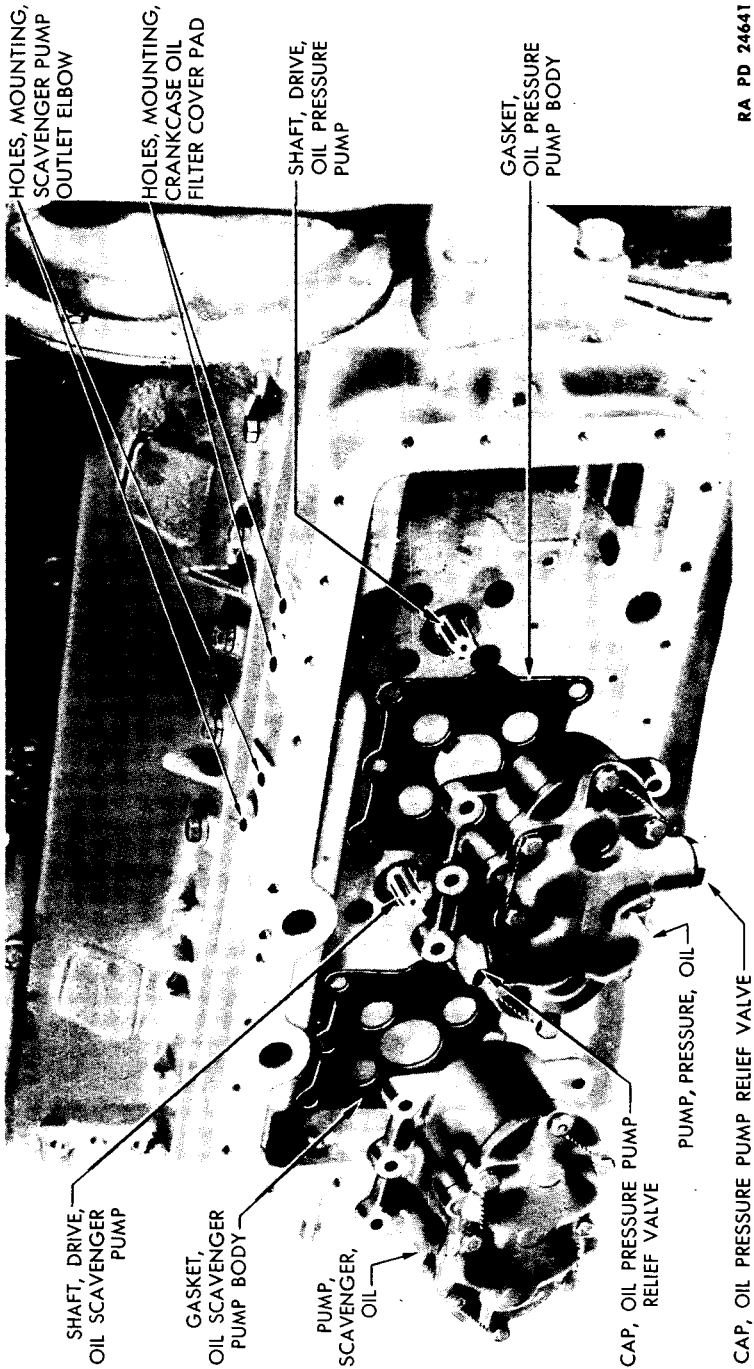


RA PD 25539

Figure 69 — M4A4 Power Unit Oil Tubes — Bottom and Right Side



ORDNANCE MAINTENANCE—POWER UNIT ACCESSORIES  
FOR MEDIUM TANKS M3A4 AND M4A4



RA PD 24641

Figure 70—Oil Pumps

DESCRIPTION OF SYSTEM

RA PD 24643

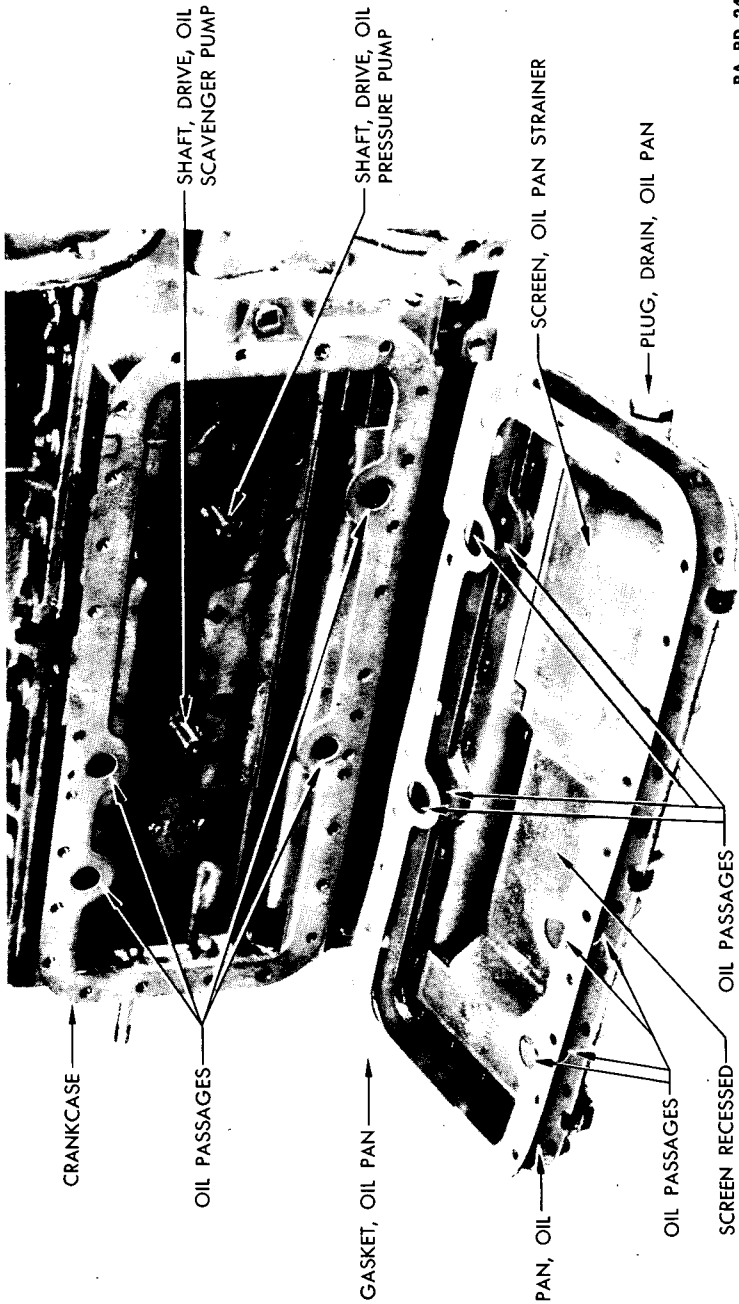


Figure 71—Oil Passages

**ORDNANCE MAINTENANCE—POWER UNIT ACCESSORIES**  
**FOR MEDIUM TANKS M3A4 AND M4A4**

from main bearings to the connecting rod journals, provide oil for the connecting rod lower bearings. A metered hole in the lower end of the connecting rod permits forcing a spray of oil into the cylinder, lubricating the cylinder walls and piston pins. A plug in the radiator end of the oil gallery in engines Nos. 1, 2, and 5 permits forcing the oil into the drive gear housing to lubricate the gears. This oil drains through an opening at the bottom of the case, to the oil pan.

c. The scavenger oil pump draws oil through the screen in the oil pan and directs it through the oil cooler and full flow oil filter to the oil supply tank. Air is drawn through the pump along with the oil and the resulting foam is separated in the hopper (fig. 98). A vent tube (fig. 65) connects the top of the hopper tank with the crankcase of No. 5 engine so that the suction created by the scavenger pump draws air separated from the oil back into the power unit, resulting in recirculation of air.

**35. TABULATED DATA AND SPECIFICATIONS.**

**a. General.**

Type of lubrication	Full pressure, dry sump
Oil inlet connection	Pressure pump suction
Oil outlet connection	Scavenger pump discharge
Main bearings	Pressure lubricated
Camshaft bearings	Pressure lubricated
Connecting rod bearings	Pressure lubricated
Timing gears	Jet
Piston pins	Splash
Valves, tappets	Splash
Oil capacity (including oil supply tank)	9 gallons
Oil capacity (when drained and refilled)	8 gallons
Oil, quality	Summer, SAE 30 Winter, SAE 10 W
Oil reservoir gage type	Blade on filler cap
Type of oil drain	Threaded plug

**b. Oil Pressure Pump.**

Type	3-gear
Speed	Same as propeller shaft
Pressure, production fit on bearing	Min. 25 lb per sq in. at idling speed 30 lb above 1,500 rpm crank- shaft speed Max. 65 lb per sq in.
Capacity at 1,500 rpm	200 lb per minute at 40 lb per sq in. Discharge pressure with SAE 30 oil at 160 F inlet oil temperature

**DESCRIPTION OF SYSTEM**

**c. Oil Scavenger Pump.**

Type ..... 3-gear  
Speed ..... Same as propeller shaft

**36. SECOND ECHELON OPERATIONS.**

a. In view of the fact that many second echelon operations are often performed by ordnance maintenance personnel, the information is not repeated in this manual. Therefore, ordnance maintenance personnel should refer to TM 9-754, January 21, 1943, for this information.

**37. ECHELON BREAK-DOWN OF MAINTENANCE.**

a. Refer to paragraph 4.

**ORDNANCE MAINTENANCE—POWER UNIT ACCESSORIES  
FOR MEDIUM TANKS M3A4 AND M4A4**

**CHAPTER 3**

**POWER UNIT LUBRICATING SYSTEM (Cont'd)**

**Section II**

**TROUBLE SHOOTING**

Trouble shooting .....	Paragraph 38
------------------------	-----------------

**38. TROUBLE SHOOTING.**

**a. Oil Gage Does Not Register.**

Possible Cause	Possible Remedy
Lack of oil in system.	Check and replenish.
Oil pressure gage, sending unit or wiring inoperative.	Check pressure with reliable gage in oil gallery of No. 1 engine; should be 25—60 lb per sq in. at idling speed; repair or replace necessary parts.
Oil too heavy.	Drain and refill with proper quality.
Oil lines restricted.	Check for kinks in oil lines; check for foreign matter in lines; clean, repair or replace.

**b. Excessive Use of Oil.**

Leaks in oil hose, tubing or connections.	Tighten all connections; replace all broken lines.
Damaged gaskets throughout power unit.	Check and replace where necessary.

**c. Low Oil Pressure Warning Indicator Light Starts to Operate.**

**NOTE:** Look at pressure gage at once; gage should not read over 13 pounds if warning light is on and operating correctly.

Low oil supply.	Check and replenish.
Warning light sending unit not functioning properly.	Repair or replace (Refer to TM 9-754, Jan. 21, 1943, par. 173 d, e, f, and g).

**d. Oil Temperature Gage Reads Too High.**

Low oil supply.	Check and replenish.
Power unit running hot due to causes outside of oil system.	Check cooling system (Refer to TM 9-754, Jan. 21, 1943, par. 51 a (5) ).

## TROUBLE SHOOTING

Possible Cause	Possible Remedy
Oil cooler not functioning.	Check for dirt on outside of cooler or obstructions in front of cooler. Flush out inside of cooler with SOLVENT, dry-cleaning, if necessary (Refer to TM 9-754, Jan. 21, 1943, par. 58).
Oil temperature gage or sending unit not functioning properly.	Repair or replace (Refer to TM 9-754, Jan. 21, 1943, par. 172 h, d, and f).
<b>e. Oil Temperature Gage Does Not Register.</b>	
Oil temperature gage, sending unit or wiring inoperative.	Repair or replace necessary parts (Refer to TM 9-754, Jan. 21, 1943, par. 172 h, d, and f).

**ORDNANCE MAINTENANCE—POWER UNIT ACCESSORIES  
FOR MEDIUM TANKS M3A4 AND M4A4**

**CHAPTER 3**

**POWER UNIT LUBRICATING SYSTEM (Cont'd)**

**Section III**

**LUBRICATING OIL PUMPS**

	Paragraph
Pressure oil pump .....	39
Scavenger oil pump .....	40

**39. PRESSURE OIL PUMP.**

a. **Description.** The oil pressure pump is a 3-gear pump (fig. 72), driven by a drive shaft which is, in turn, driven by the accessory shaft. The pressure pump is mounted in the distributor end of the crankcase with six cap screws (fig. 70). It draws oil from the oil supply tank and forces the oil under pressure through drilled passages to the moving parts of the power unit. Pressure relief valves are built into the pump to control the pressure in the system (fig. 72).

**b. Removal.**

(1) Refer to TM 9-754, January 21, 1943 (par. 56 d) for removal procedure.

**c. Disassembly.**

- |                      |                 |
|----------------------|-----------------|
| HAMMER, brass        | WRENCH, 1/2-in. |
| PLIERS, side cutting | WRENCH, 1-in.   |
| PRESS, bench         |                 |

(1) REMOVE COVER AND GEARS (fig. 70).

- |                      |                 |
|----------------------|-----------------|
| HAMMER, brass        | WRENCH, 1/2-in. |
| PLIERS, side cutting |                 |

Remove locking wires (side cutting pliers) and remove the eight cap screws (1/2-in. wrench). Remove cover. NOTE: Due to the cover being doweled to the pump body, it will be necessary to tap the cover (lightly) with a brass hammer while lifting cover. Lift the three gears out of pump body.

(2) REMOVE OIL PRESSURE PUMP IDLER GEAR SHAFTS (fig. 73).

- PRESS, bench

Place pump cover on press and, with suitable arbor, press shaft out of cover.

(3) REMOVE BUSHINGS FROM OIL PRESSURE PUMP IDLER GEARS (fig. 74).

- PRESS, bench

## LUBRICATING OIL PUMPS

Place oil pressure pump idler gear on press and, with suitable arbor, press bushing out of idler gear.

(4) REMOVE OIL PRESSURE PUMP INTERMEDIATE GEAR BUSHINGS, UPPER AND LOWER.

PRESS, bench

PULLER

Place oil pressure pump body on press and, with suitable arbor, press bushing out of body. Using a puller, remove lower bushing from pump cover.

(5) REMOVE OIL PRESSURE PUMP RELIEF VALVES.

WRENCH, 1-in.

Remove oil pressure pump relief valve cap and gasket. Pull out relief valve spring. Tip pump cover to remove relief valve ball or plunger. Pump may be equipped with either ball or plunger, depending on type of pump.

### d. Inspection of Parts.

GAGE, spring, Federal Stock  
No. 17-T-1600

PAN, for washing parts

(1) Wash all parts thoroughly in SOLVENT, dry-cleaning.

(2) Inspect oil pressure pump gears for tooth wear, breaks, or excessive wear.

(3) Inspect oil pressure pump gear shafts for wear at points of contact with bushings.

(4) Inspect body and cover for any cracks. Inspect cover mounting screw threads for damage and inspect openings for screws, to be sure they are not obstructed.

(5) Inspect cover and body faces for dents or warpage which would affect sealing.

(6) Inspect oil pressure pump relief valve spring.

GAGE, spring, Federal Stock  
No. 17-T-1600

Place spring in gage and check as follows:

(a) Free height,  $2\frac{5}{16}$  inches.

(b) Under load, 15—17 pounds at  $1\frac{5}{8}$  inch.

### e. Assembly.

DRILL,  $\frac{1}{8}$ -in.

PLIERS, side cutting

PRESS, bench

REAMER

WISE

WRENCH,  $\frac{1}{2}$ -in.

WRENCH, 1-in.



ORDNANCE MAINTENANCE—POWER UNIT ACCESSORIES  
FOR MEDIUM TANKS M3A4 AND M4A4

RA PD 24520

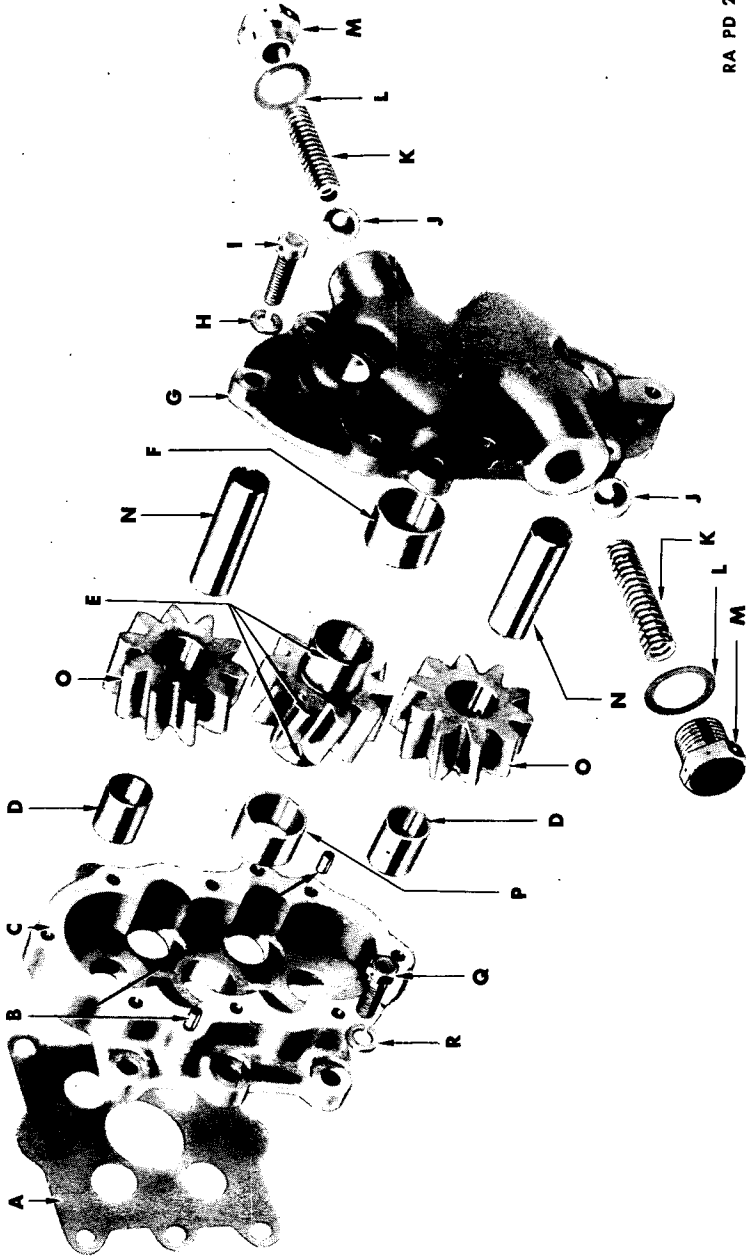


Figure 72—Parts of Pressure Oil Pump

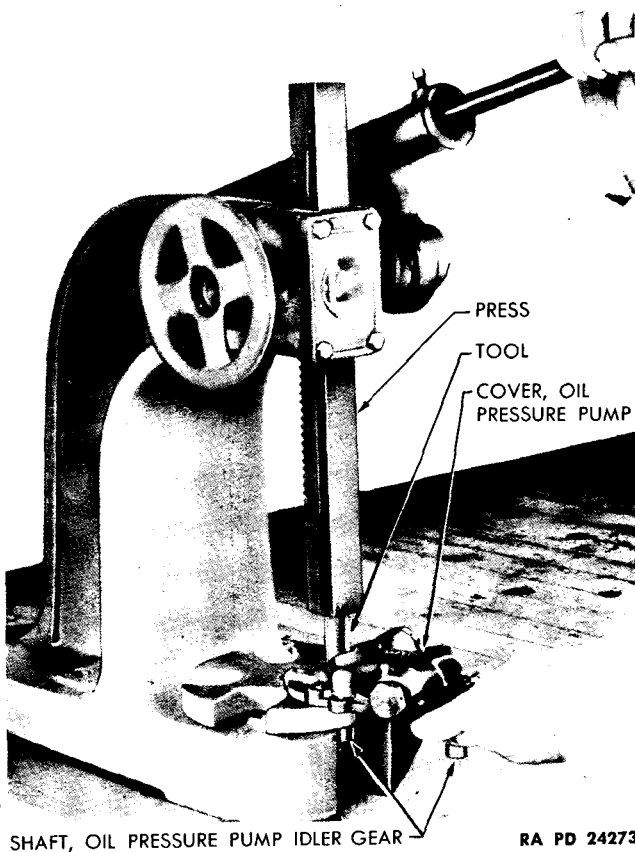
LUBRICATING OIL PUMPS

- A—GASKET, OIL PRESSURE PUMP BODY
- B—DOWEL, OIL PRESSURE PUMP COVER
- C—BODY, OIL PRESSURE PUMP
- D—BUSHING, OIL PRESSURE PUMP IDLER GEAR
- E—GEAR, INTERMEDIATE, OIL PRESSURE PUMP
- F—BUSHING, LOWER, OIL PRESSURE PUMP INTERMEDIATE GEAR
- G—COVER, OIL PRESSURE PUMP
- H—WASHER, LOCK, OIL PRESSURE PUMP COVER SCREW
- I—SCREW, OIL PRESSURE PUMP COVER
- J—BALL, OIL PRESSURE PUMP RELIEF VALVE
- K—SPRING, OIL PRESSURE PUMP RELIEF VALVE
- L—GASKET, CAP, OIL PRESSURE PUMP RELIEF VALVE
- M—CAP, OIL PRESSURE PUMP RELIEF VALVE
- N—SHAFT, OIL PRESSURE PUMP IDLER GEAR
- O—GEAR, IDLER, OIL PRESSURE PUMP
- P—BUSHING, UPPER, OIL PRESSURE PUMP INTERMEDIATE GEAR
- Q—SCREW, ATTACHING, OIL PRESSURE PUMP BODY
- R—WASHER, LOCK, OIL PRESSURE PUMP ATTACHING SCREW

RA PD 245208

*Legend for Figure 72—Parts of Pressure Oil Pump*

**ORDNANCE MAINTENANCE—POWER UNIT ACCESSORIES  
FOR MEDIUM TANKS M3A4 AND M4A4**



RA PD 24273

**Figure 73—Pressing Shaft out of Oil Pressure Pump Cover**

- (1) INSTALL OIL PRESSURE PUMP IDLER GEAR SHAFTS (fig. 75).

PRESS, bench

Place pump cover on suitable arbor and, with shaft in position, press into place.

- (2) INSTALL OIL PRESSURE PUMP INTERMEDIATE GEAR BUSHING, UPPER AND LOWER (fig. 76).

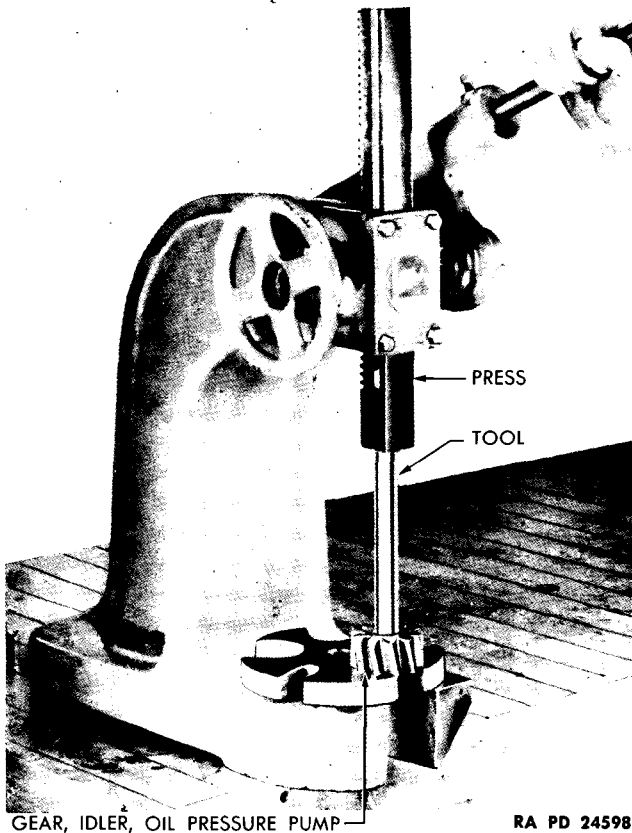
PRESS, bench

WISE

REAMER

Place pump cover or body on press and, with new bushing in position, press into place. Place body or cover in vise and ream bushings to 1.0625—1.0635 inch inside diameter.

## LUBRICATING OIL PUMPS



**Figure 74—Pressing Bushing out of Oil Pressure Pump Idler Gear**

(3) **INSTALL OIL PRESSURE PUMP IDLER GEAR BUSHINGS** (fig. 77).

DRILL,  $\frac{1}{8}$ -in.

REAMER

PRESS, bench

WISE

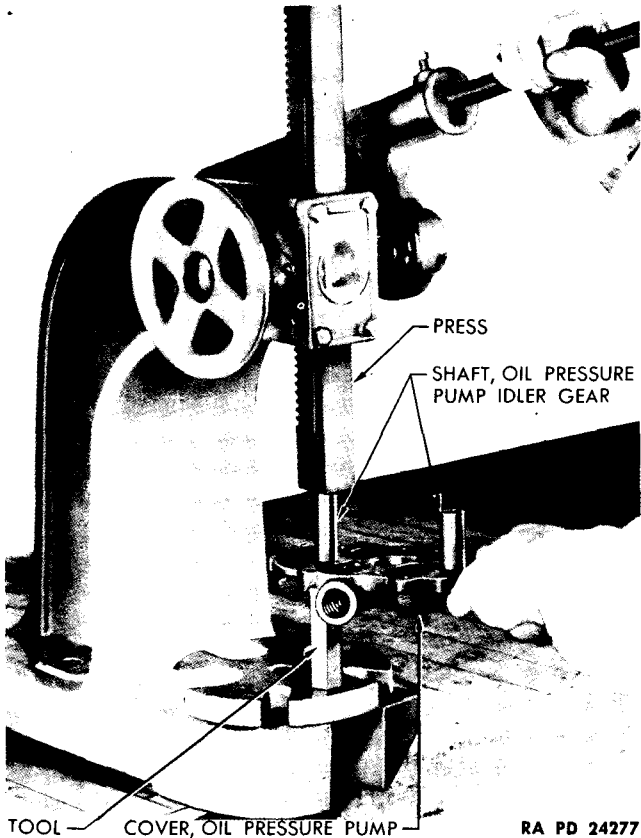
Place idler gear on press and, with new bushing in position, press into place. Using oilhole in idler gear as a guide, drill hole in bushing, as indicated in figure 77. Place reamer in vise and hold gear in hand. Ream bushing to 0.740—0.741 inch inside diameter.

(4) **INSTALL OIL PRESSURE PUMP RELIEF VALVES** (fig. 78).

WRENCH, 1-in.

Tip pump cover and insert pump relief valve ball or plunger. Place relief valve spring in position. Install new cap gasket on cap and tighten relief valve cap in place.

**ORDNANCE MAINTENANCE—POWER UNIT ACCESSORIES  
FOR MEDIUM TANKS M3A4 AND M4A4**



**Figure 75—Pressing Idler Gear Shaft in Cover**

(5) **INSTALL OIL PRESSURE PUMP GEARS** (fig. 79).

Place intermediate gear in pump cover and then slide idler gears in place on the idler gear shafts. Check to make sure gears revolve freely.

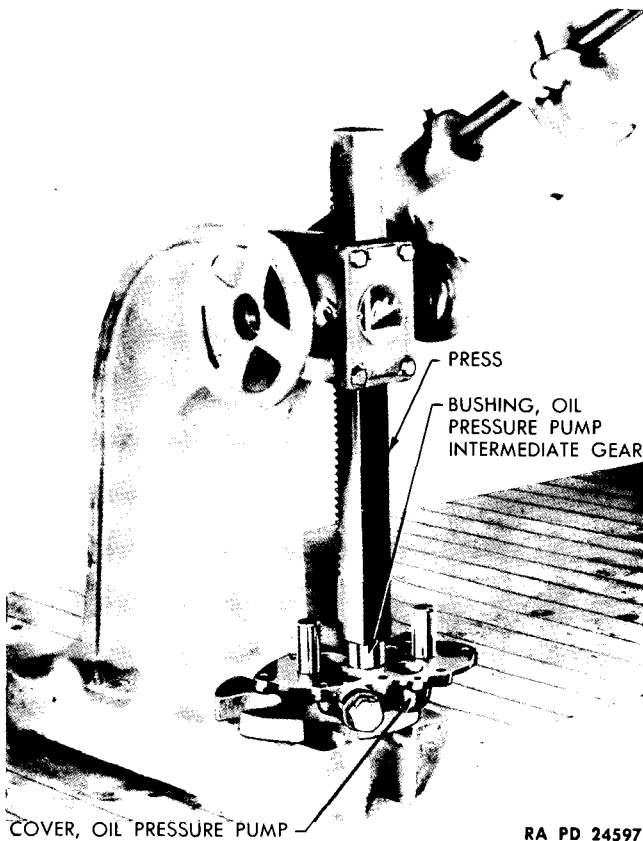
(6) **INSTALL OIL PRESSURE PUMP BODY TO COVER AND GEARS** (fig. 80).

**PLIERS**, side cutting

**WRENCH**, 1/2-in.

Holding pump cover in one hand, place pump body over cover and gears and slip into place. Install the eight cap screws and lock washers and tighten with 1/2-inch wrench. Check to be sure gears revolve freely. Secure cover screws with locking wire. Run wire through relief valve cap and four cover cap screws in such a manner that wire exerts a clockwise motion to cap screws which will keep them from becoming loose.

## LUBRICATING OIL PUMPS



**Figure 76—Pressing Intermediate Gear Bushing into Pump Cover**

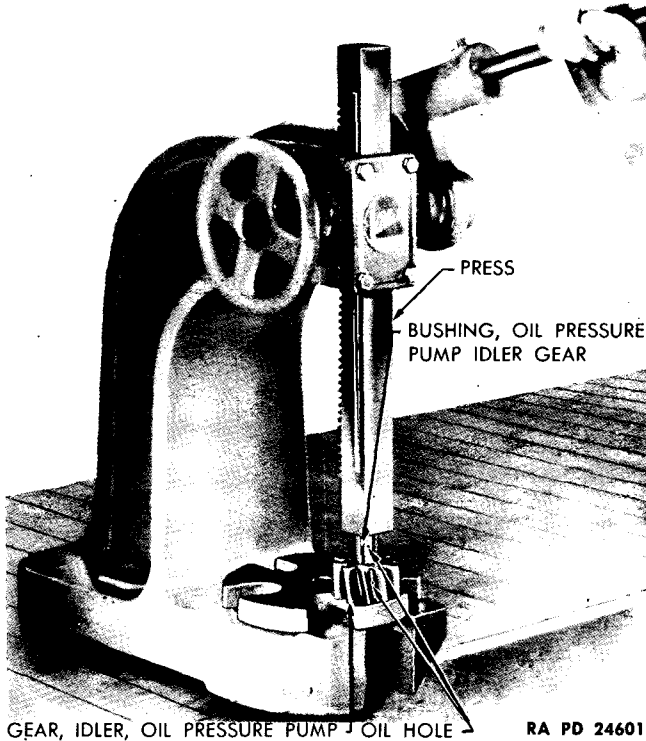
### f. Installation.

(1) Refer to TM 9-754, January 21, 1943 (par. 56 e), for installation procedure.

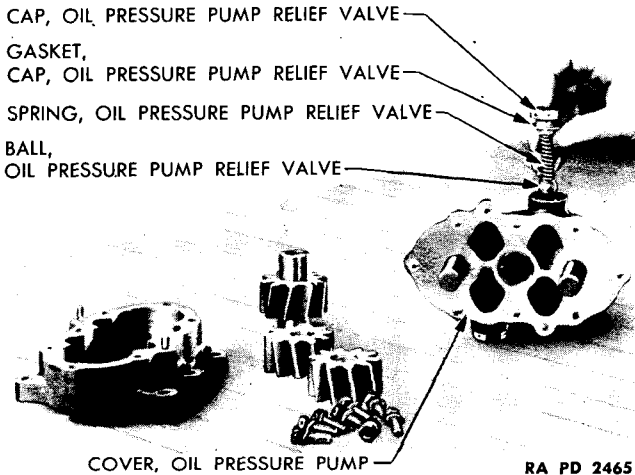
## 40. SCAVENGER OIL PUMP.

a. **Description.** The oil scavenger pump is a 3-gear pump (fig. 81), driven by a drive shaft which is, in turn, driven by the accessory shaft. The scavenger pump is mounted in the radiator end of the crankcase with six cap screws (fig. 70). It draws oil from the crankcase as it accumulates and forces it to the oil cooler and then into the supply tank. Oil passages from the crankcase to the scavenger pump are so located that, regardless of the location of the oil in the crankcase due to the posi-

**ORDNANCE MAINTENANCE—POWER UNIT ACCESSORIES  
FOR MEDIUM TANKS M3A4 AND M4A4**

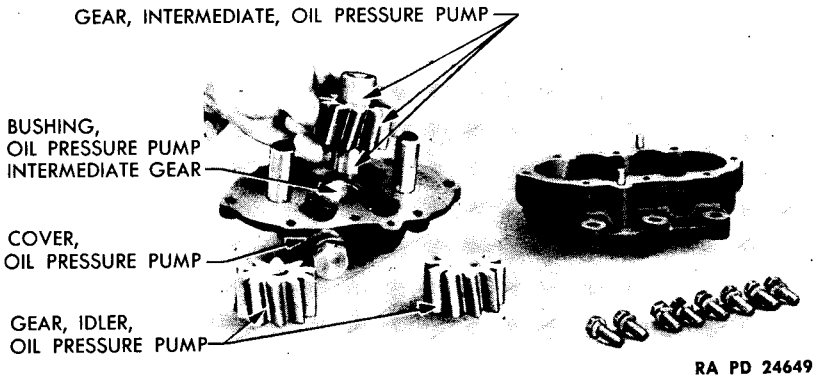


**Figure 77—Pressing Bushing into Idler Gear**



**Figure 78—Relief Valve in Pump Cover Installation**

**LUBRICATING OIL PUMPS**



**Figure 79—Intermediate Gear Installation**

tion of the vehicle, the pump will be able, at all times, to maintain its scavenging effect.

**b. Removal.**

(1) Refer to TM 9-754, January 21, 1943 (par. 56 d), for removal procedure.

**c. Disassembly.**

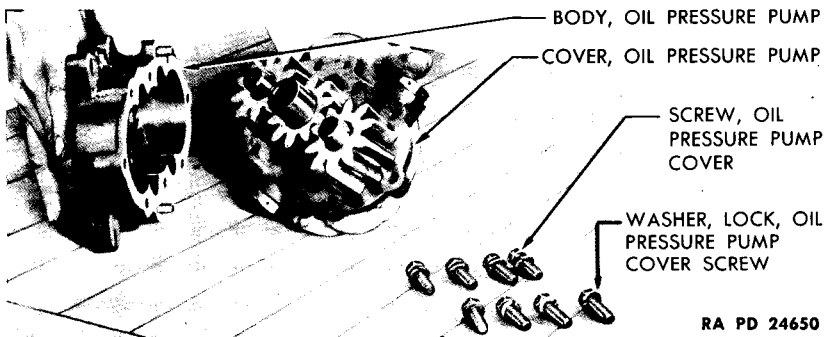
HAMMER, brass  
PLIERS, side cutting

PRESS, bench  
WRENCH, 1/2-in.

(1) REMOVE COVER AND GEARS (fig. 70).

HAMMER, brass  
PLIERS, side cutting

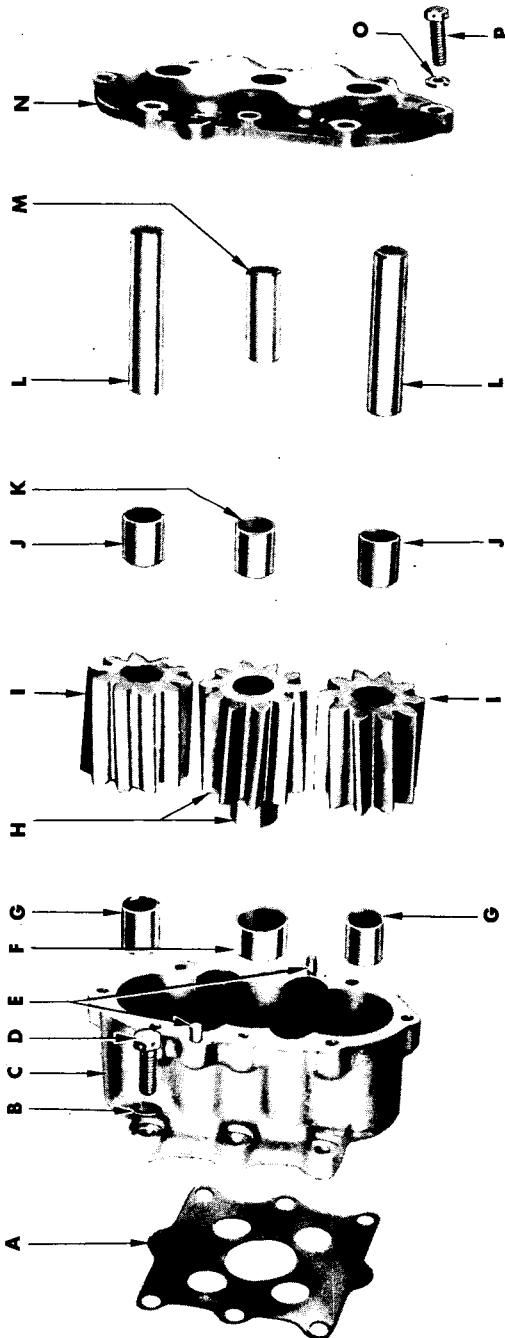
WRENCH, 1/2-in.



**Figure 80—Assembling Cover to Pump Body**



ORDNANCE MAINTENANCE—POWER UNIT ACCESSORIES  
FOR MEDIUM TANKS M3A4 AND M4A4



RA PD 24519

Figure 81—Parts of Scavenger Oil Pump

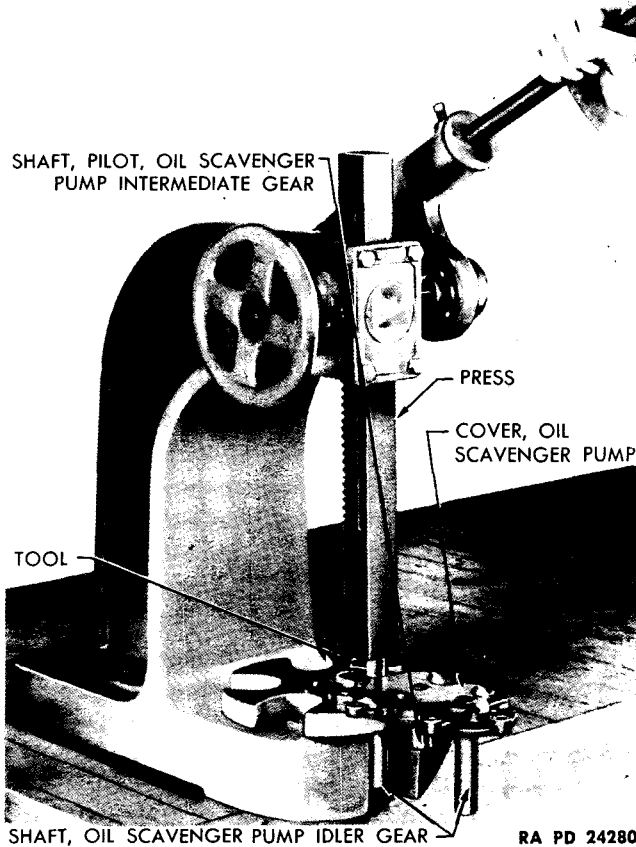
LUBRICATING OIL PUMPS

- A—GASKET, OIL SCAVENGER PUMP BODY
- B—WASHER, LOCK, OIL SCAVENGER PUMP ATTACHING SCREW
- C—BODY, OIL SCAVENGER PUMP
- D—SCREW, ATTACHING, OIL SCAVENGER PUMP BODY
- E—DOWEL, OIL SCAVENGER PUMP COVER
- F—BUSHING, UPPER, OIL SCAVENGER PUMP INTERMEDIATE GEAR
- G—BUSHING, UPPER, OIL SCAVENGER PUMP IDLER GEAR
- H—GEAR, INTERMEDIATE, OIL SCAVENGER PUMP
- I—GEAR, IDLER, OIL SCAVENGER PUMP
- J—BUSHING, LOWER, OIL SCAVENGER PUMP IDLER GEAR
- K—BUSHING, LOWER, OIL SCAVENGER PUMP INTERMEDIATE GEAR
- L—SHAFT, OIL SCAVENGER PUMP IDLER GEAR
- M—SHAFT, OIL SCAVENGER PUMP INTERMEDIATE GEAR PILOT
- N—COVER, OIL SCAVENGER PUMP
- O—WASHER, LOCK, OIL SCAVENGER PUMP COVER SCREW
- P—SCREW, OIL SCAVENGER PUMP COVER

RA PD 24519B

*Legend for Figure 81—Parts of Scavenger Oil Pump*

**ORDNANCE MAINTENANCE—POWER UNIT ACCESSORIES  
FOR MEDIUM TANKS M3A4 AND M4A4**



**Figure 82—Pressing Idler Gear Shaft out of Cover**

Remove locking wires (side cutting pliers) and remove the eight cap screws ( $\frac{1}{2}$ -in. wrench). Remove cover. NOTE: Due to the cover being doweled to the pump body, it will be necessary to tap the cover (lightly) with a brass hammer while lifting cover. Lift the three gears out of the pump body.

(2) REMOVE OIL SCAVENGER PUMP GEAR SHAFTS (fig. 82).

PRESS, bench

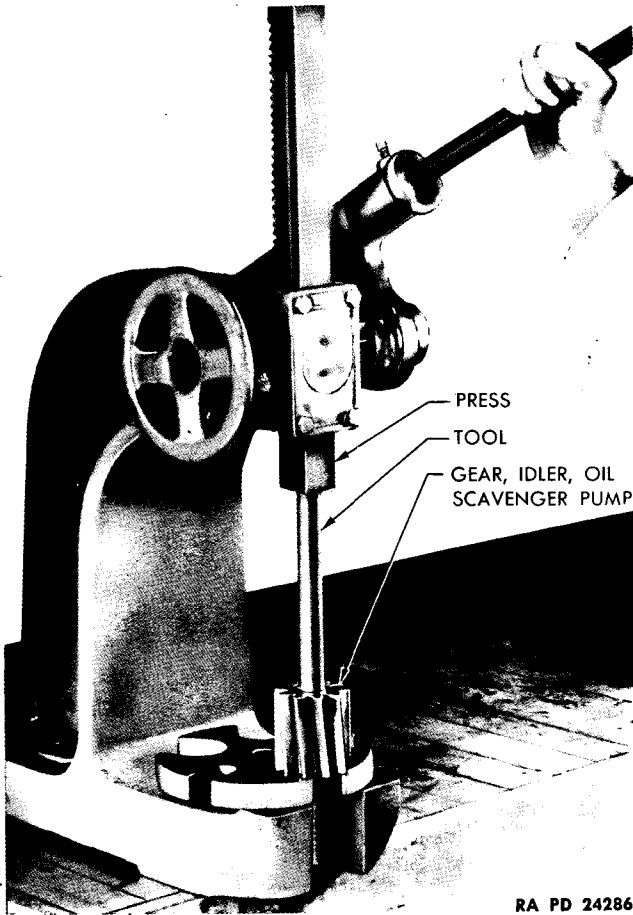
Place pump cover on press and, with suitable arbor, press shafts out of cover.

(3) REMOVE BUSHINGS FROM OIL SCAVENGER PUMP GEARS (fig. 83).

PRESS, bench

PULLER

LUBRICATING OIL PUMPS



RA PD 24286

**Figure 83—Pressing Bushings out of Idler Gear**

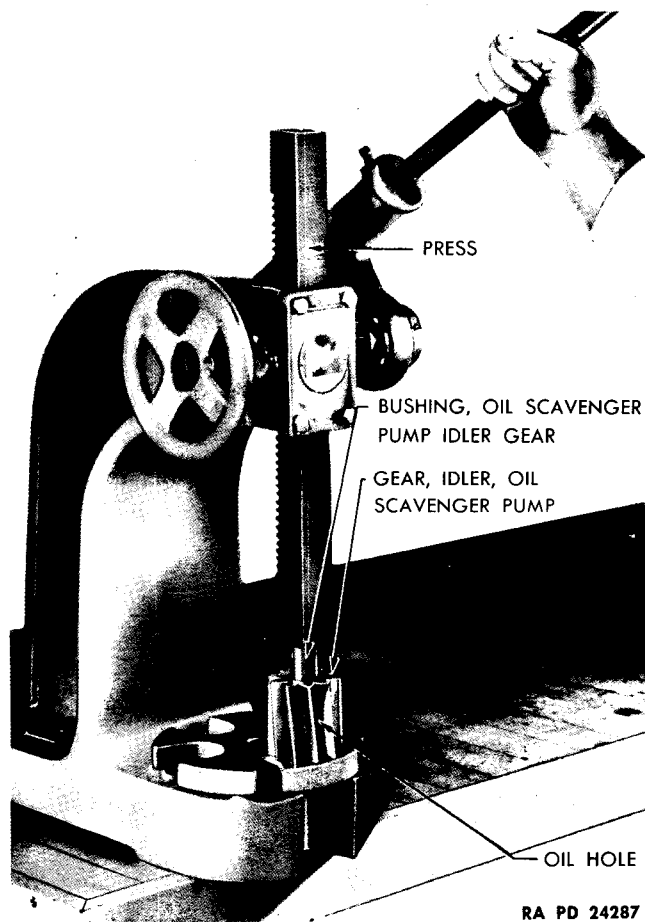
Place oil scavenger pump idler gear on press and, with suitable arbor, press bushings out of idler gear. Using a puller, remove lower bushing from intermediate gear.

(4) REMOVE OIL SCAVENGER PUMP INTERMEDIATE GEAR UPPER BUSHING FROM PUMP BODY.

PRESS, bench

Place pump body on press and, with suitable arbor, press bushing out of body.

ORDNANCE MAINTENANCE—POWER UNIT ACCESSORIES  
FOR MEDIUM TANKS M3A4 AND M4A4



RA PD 24287

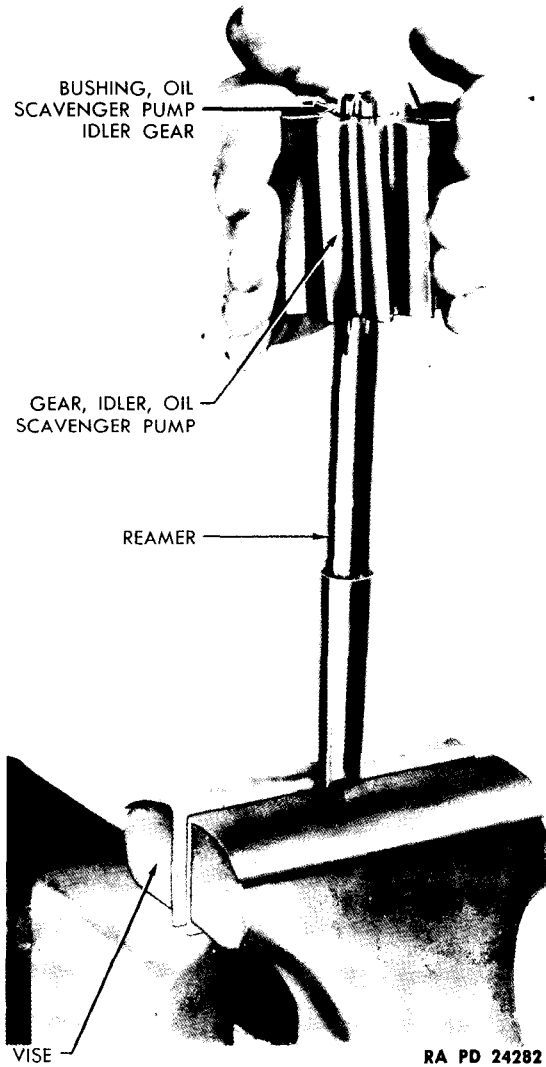
**Figure 84—Pressing Bushing in Oil Scavenger Pump Gear**

**d. Inspection of Parts.**

PAN, for washing parts

- (1) Wash all parts thoroughly in SOLVENT, dry-cleaning.
- (2) Inspect oil scavenger pump gears for tooth wear or breaks.
- (3) Inspect oil scavenger pump gear shafts for wear at points of contact with bushings.
- (4) Inspect body and cover for any cracks. Inspect cover mounting screw threads for damage and inspect openings for screws, to be sure they are not obstructed.

LUBRICATING OIL PUMPS



**Figure 85—Reaming Bushing in Idler Gear**

(5) Inspect cover and body faces for dents or warpage which would affect sealing.

**e. Assembly.**

DRILL, 1/8-in.

PLIERS, side cutting

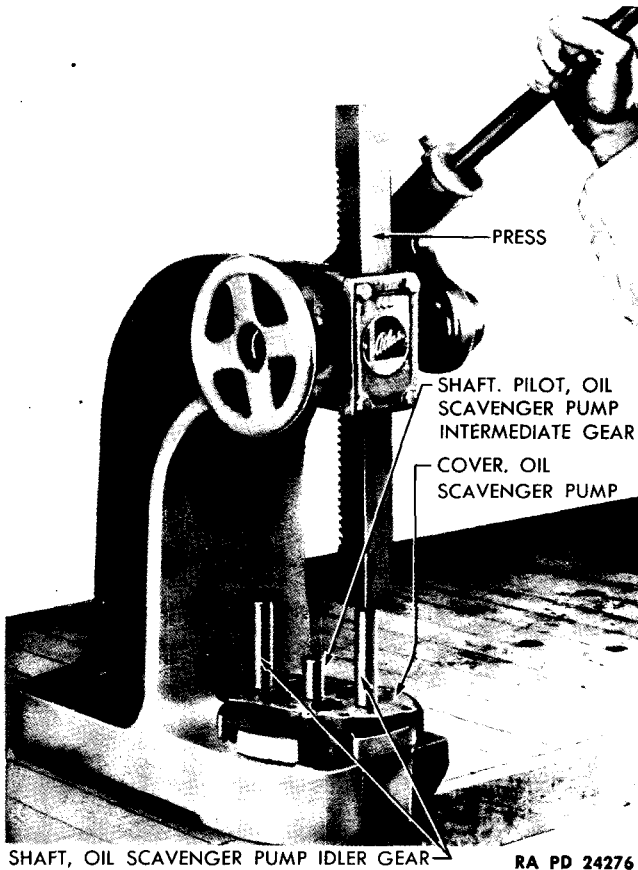
PRESS, bench

REAMER

WISE

WRENCH, 1/2-in.

**ORDNANCE MAINTENANCE—POWER UNIT ACCESSORIES  
FOR MEDIUM TANKS M3A4 AND M4A4**

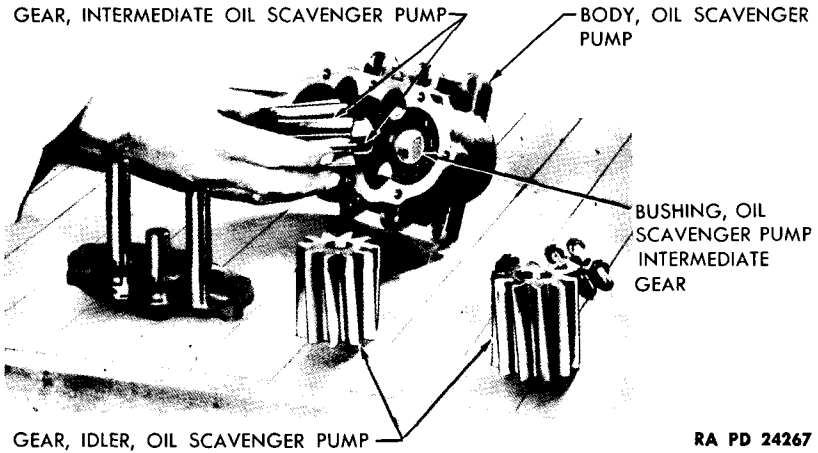


**Figure 86—Pressing Shafts in Oil Scavenger Pump Cover**

- (1) INSTALL OIL SCAVENGER PUMP GEAR BUSHINGS (fig. 84).  
 DRILL,  $\frac{1}{8}$ -in. REAMER  
 PRESS, bench VISE

Place idler gear on press and, with new bushing in position, press into gear until bushing is flush with inner edge of chamfer on gear. Turn idler gear over and press in second bushing in same manner. Drill through the two oilholes in gear with  $\frac{1}{8}$ -inch drill and through bushings to be sure oil passage is clear. Place intermediate gear on press and, with new lower bushing in position, press into gear until bushing is flush with inner edge of chamfer on gear. Drill through the two oilholes in gear and through bushing to provide oilholes in bushing. Place reamer in vise

### LUBRICATING OIL PUMPS



RA PD 24267

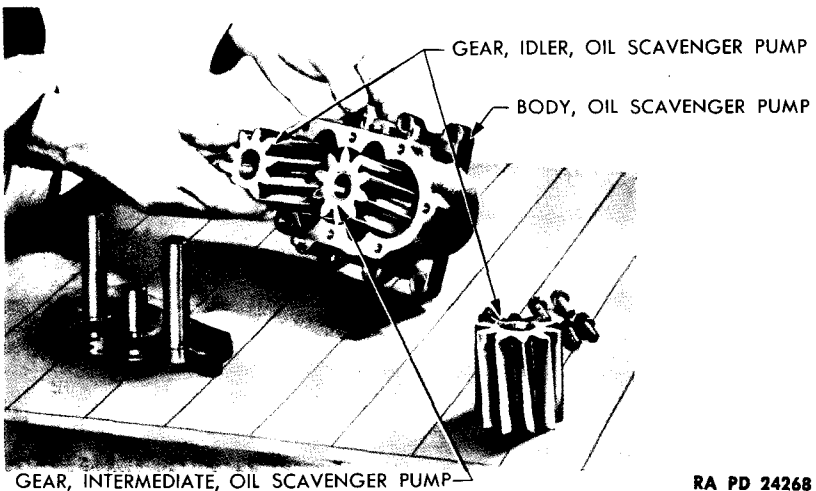
**Figure 87—Intermediate Gear Installation**

(fig. 85) and ream the idler gear bushings and intermediate gear bushing to 0.740—0.741 inch inside diameter.

(2) INSTALL OIL SCAVENGER PUMP INTERMEDIATE GEAR UPPER BUSHING.

PRESS, bench  
REAMER

VICE

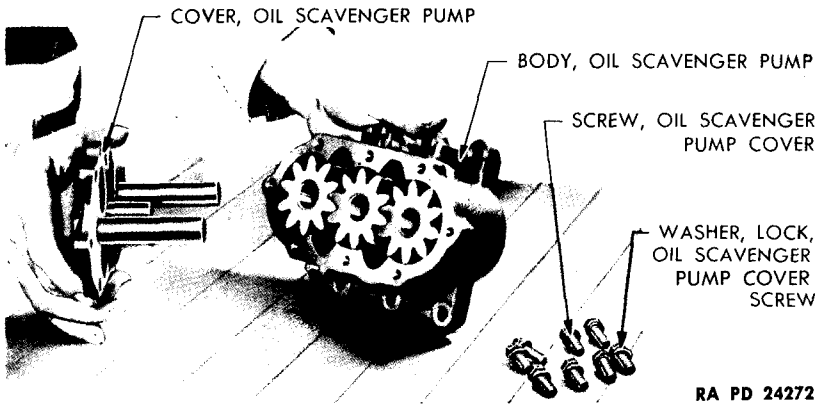


RA PD 24268

**Figure 88—Idler Gear Installation**



**ORDNANCE MAINTENANCE—POWER UNIT ACCESSORIES  
FOR MEDIUM TANKS M3A4 AND M4A4**



**Figure 89—Cover to Pump Body Assembly**

Place scavenger pump body on press and, with new bushing in position, press into place. Place body in vise and ream bushing to 1.0625—1.0635 inch inside diameter.

**(3) INSTALL OIL SCAVENGER PUMP GEAR SHAFTS (fig. 86).**

**PRESS**, bench

Place pump cover on press and press each shaft into place.

**(4) INSTALL OIL SCAVENGER PUMP GEARS.**

Place intermediate gear in pump body (fig. 87) and check to be sure gear revolves freely. Slip idler gears into place (fig. 88).

**(5) INSTALL OIL SCAVENGER PUMP COVER AND GEAR SHAFTS.**

**PLIERS**, side cutting

**WRENCH**, ½-in.

Line up gear shafts and gears, and slip cover and shafts into place (fig. 89). Install the eight cap screws and lock washers and tighten with ½-inch wrench. Check to be sure gears revolve freely. Secure cover screws with locking wire. Run wire through four cover cap screws in such manner that wire exerts a clockwise motion to cap screws which will keep them from becoming loose.

**f. Installation.**

(1) Refer to TM 9-754, January 21, 1943 (par. 56 e), for installation procedure.

**CHAPTER 3**  
**POWER UNIT LUBRICATING SYSTEM (Cont'd)**

**Section IV**  
**LUBRICATING OIL FILTERS**

	Paragraph
Lubricating oil filters .....	41

**41. LUBRICATING OIL FILTERS.**

**a. Absorption Type.**

(1) **DESCRIPTION.** Two absorption type oil filters (fig. 90) are mounted on a common bracket (fig. 92) located on No. 1 engine. A pressure relief valve (fig. 92) is incorporated in the bracket. Oil from the oil gallery of No. 1 engine enters the relief valve and then goes to each filter. The oil passes down through the cartridges (fig. 94) in the filters and returns to a common union along with the oil which leaks past the relief valve. The oil then passes to the drive gear housing.

(2) **REMOVAL.**

(a) Refer to TM 9-754, January 21, 1943 (par. 55 c) for removal procedure.

(3) **DISASSEMBLY AND ASSEMBLY.**

Removal of cartridge from filter is described in TM 9-754, January 21, 1943 (par. 55 e), and since nothing else will need to be disassembled, the procedure for removal of the cartridge will not be duplicated (fig. 93).

(4) **INSTALLATION.**

(a) Refer to TM 9-754, January 21, 1943, (par. 55 d) for installation procedure.

**b. Full Flow Oil Strainer.**

(1) **DESCRIPTION.**

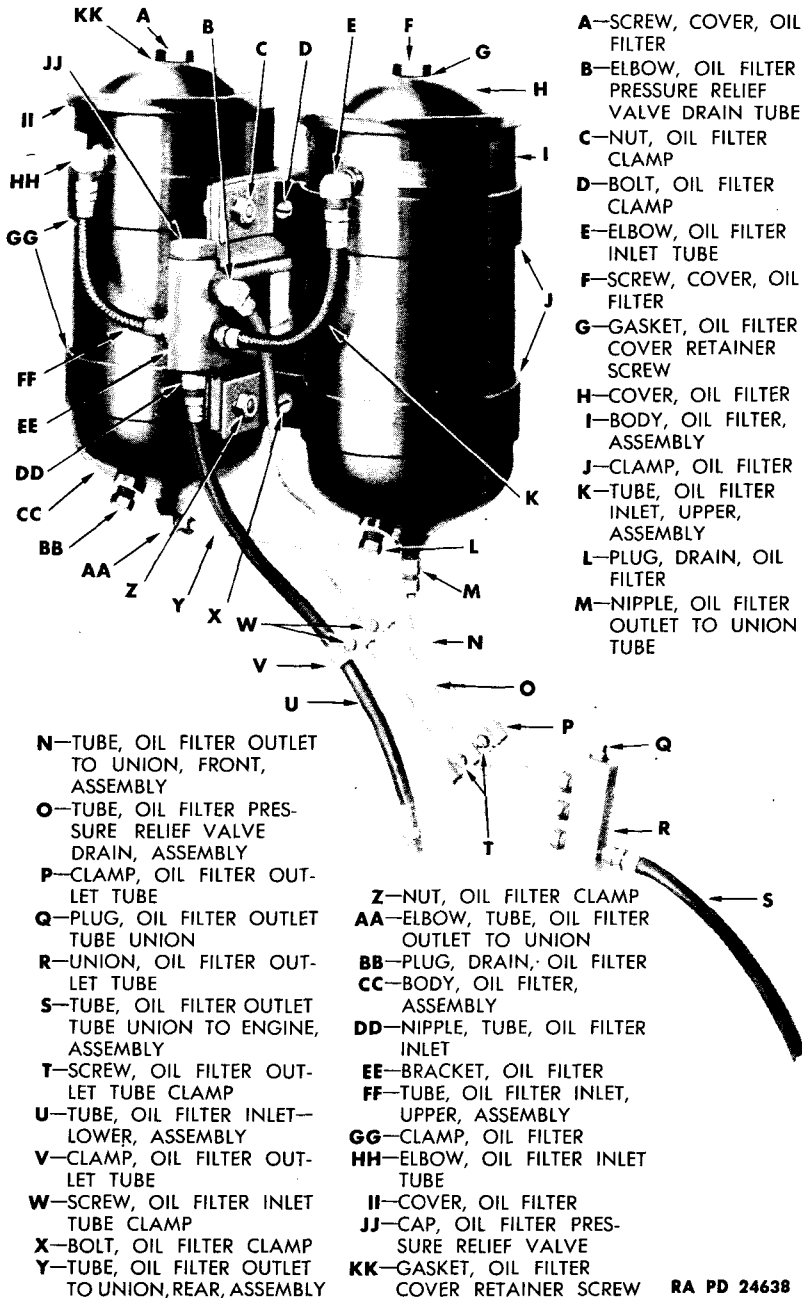
The full flow oil strainer is mounted on the bulkhead in the fighting compartment (fig. 96). It is connected between the scavenger oil pump and the oil cooler. The strainer consists of an element made up of a spirally wound notched wire, through which the oil is forced. A relief valve is placed in the bottom of the element to bypass the oil when the pressure becomes too great. A handle, mounted on top of the strainer, is connected to the element. When the handle is revolved the element revolves and its outer surface is cleaned by a knife edge attached inside the strainer.

(2) **REMOVAL.**

**WRENCH**, open-end,  $\frac{9}{16}$ -in.

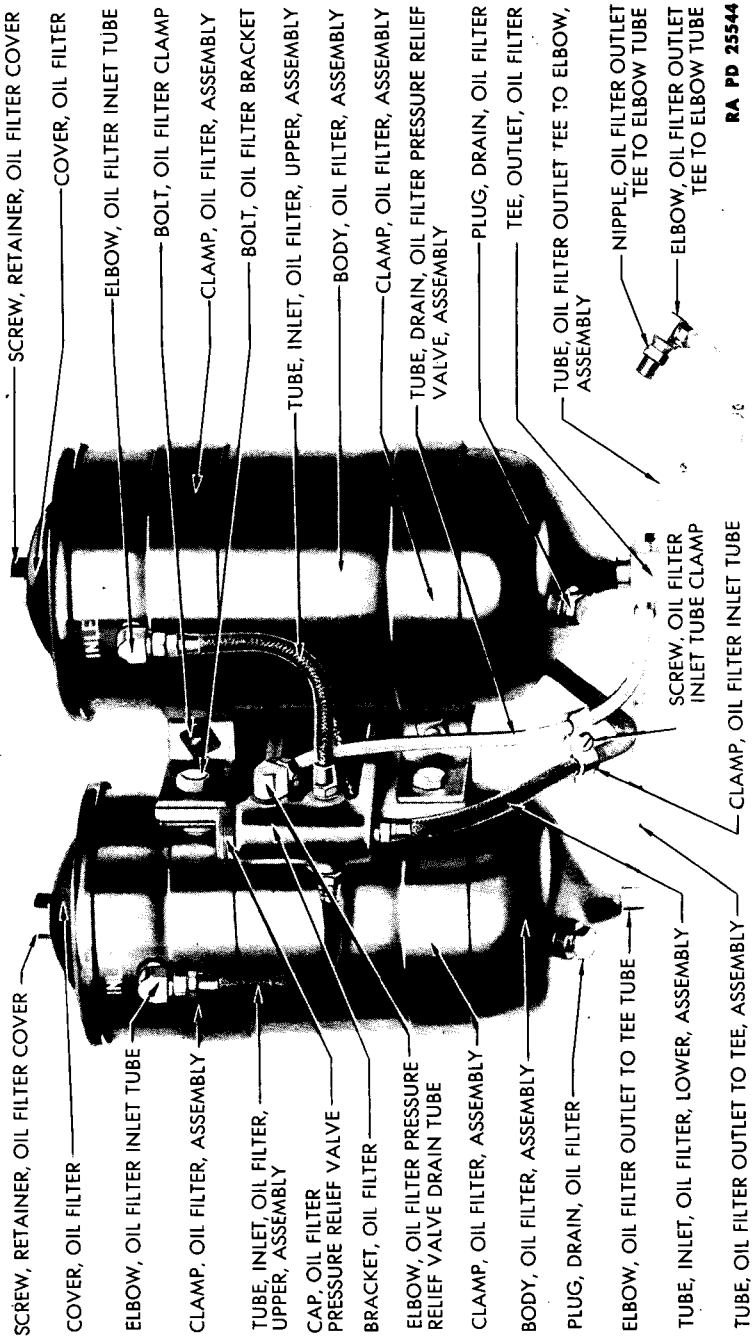
**WRENCH**, open-end,  $1\frac{3}{8}$ -in.

**ORDNANCE MAINTENANCE—POWER UNIT ACCESSORIES  
FOR MEDIUM TANKS M3A4 AND M4A4**



**Figure 90—M3A4 Absorption Type Oil Filters and Related Parts**

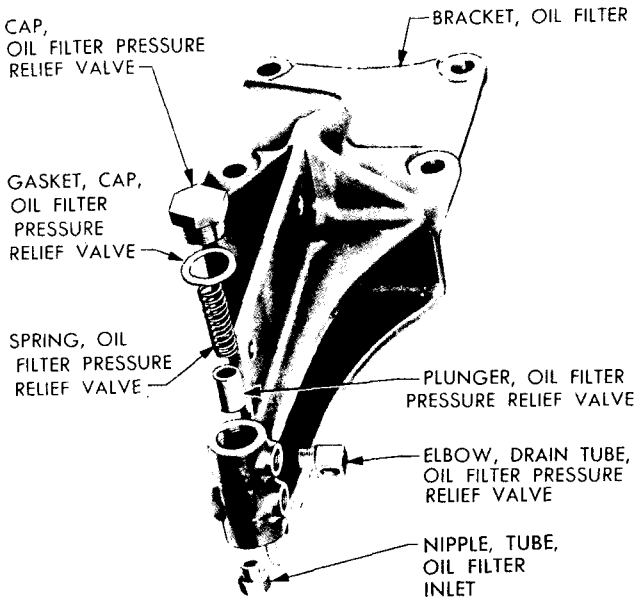
LUBRICATING OIL FILTERS



RA PD 23544

Figure 91—M4A4 Absorption Type Oil Filters and Related Parts

**ORDNANCE MAINTENANCE—POWER UNIT ACCESSORIES  
FOR MEDIUM TANKS M3A4 AND M4A4**



RA PD 24608

**Figure 92—Absorption Type Oil Filter Mounting Bracket and Related Parts**

(a) *Remove Strainer from Tank* (fig. 95).

Disconnect strainer inlet and outlet tubes by unscrewing nuts (1 3/8-in. open-end wrench) on the inlet and outlet elbows. Remove eight cap screws (9/16-in. open-end wrench) which secure strainer to bulkhead. Remove strainer from tank.

**(3) DISASSEMBLY.**

- PLIERS, side cutting
- SCREWDRIVER
- TOOL, stud removing
- WRENCH, open-end, 7/16-in.
- WRENCH, open-end, 9/16-in.

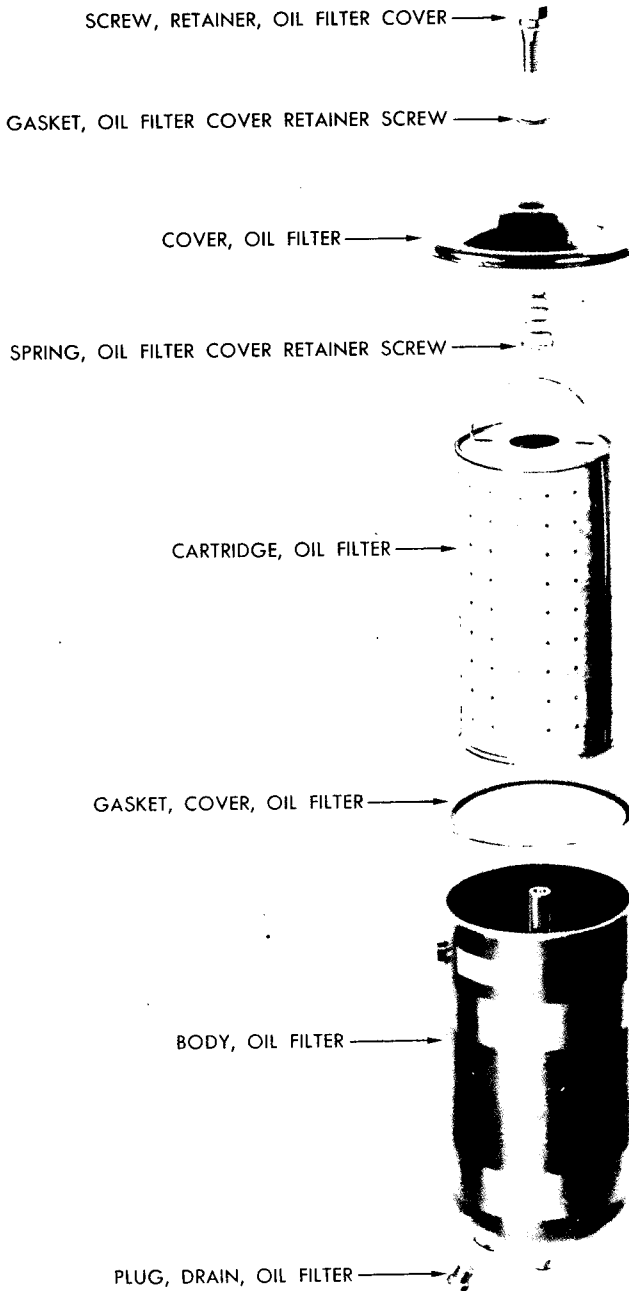
- WRENCH, open-end, 3/4-in.
- WRENCH, open-end, 1 1/8-in.
- WRENCH, open-end, 1 3/8-in.
- WRENCH, open-end, 1 1/2-in.

(a) *Remove Filter Head and Element Assembly* (figs. 96 and 97).

- PLIERS, side cutting
- WRENCH, open-end, 3/4-in.

Remove the cotter pins from the four filter head retaining bolt nuts with side cutting pliers and remove the nuts by turning them counter-clockwise with a 3/4-inch open-end wrench. Remove the head and element assembly from the filter case. Remove the filter case gasket. Slide the retaining ring off the case.

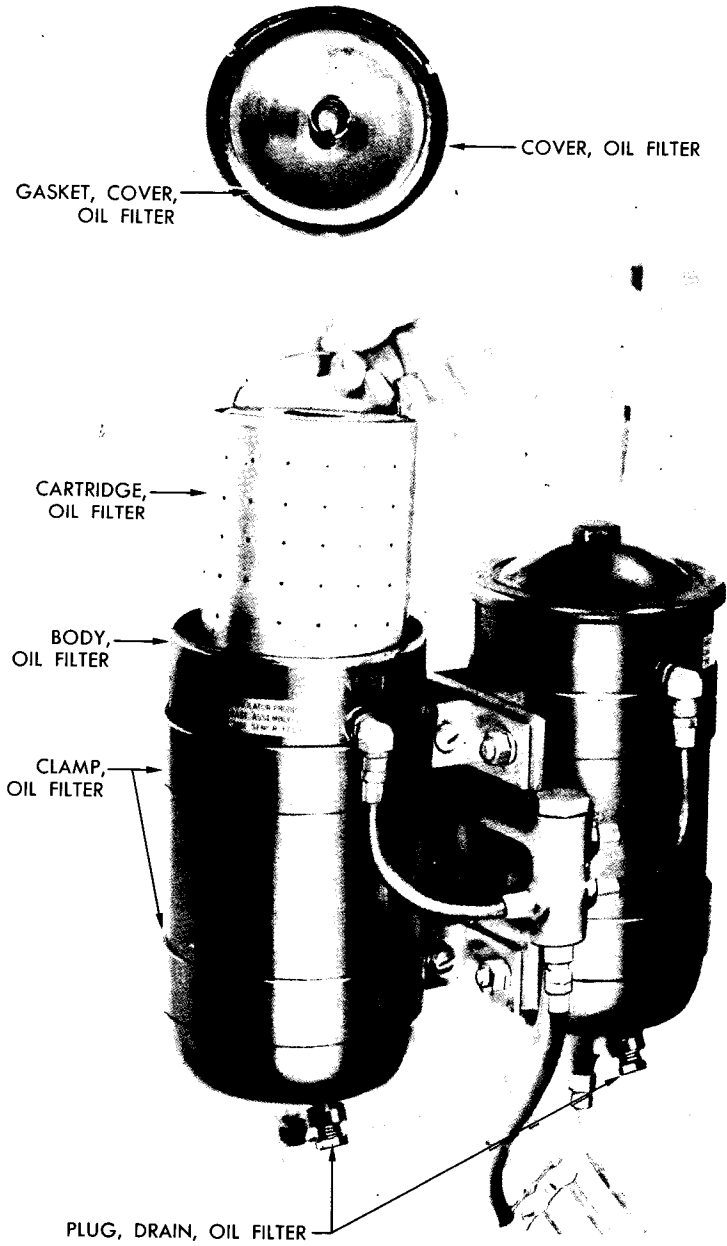
**LUBRICATING OIL FILTERS**



RA PD 24636

**Figure 93—Parts of Absorption Type Oil Filter**

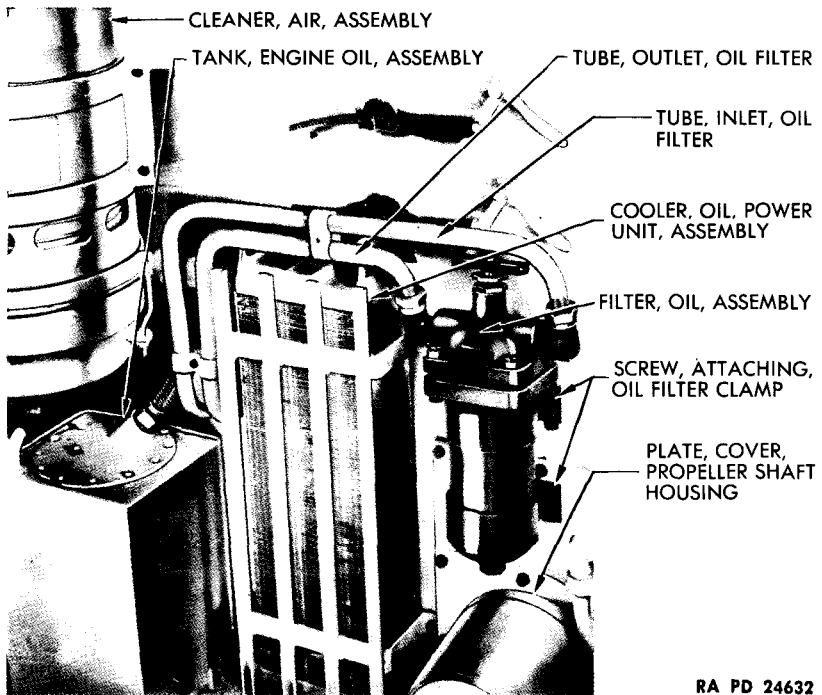
**ORDNANCE MAINTENANCE—POWER UNIT ACCESSORIES  
FOR MEDIUM TANKS M3A4 AND M4A4**



RA PD 24639

**Figure 94—Oil Filter Cartridge Removal**

## LUBRICATING OIL FILTERS



RA PD 24632

**Figure 95—Full Flow Strainer Oil Filter in Position on Bulkhead**

(b) *Remove Stuffing Box Packing* (figs. 96 and 97).

WRENCH, open-end,  $\frac{9}{16}$ -in.                      WRENCH, open-end,  $1\frac{1}{2}$ -in.

Remove the element driver handle nut by turning it counterclockwise with a  $\frac{9}{16}$ -inch open-end wrench and lift off the handle. Loosen the packing nut lock nut by turning it counterclockwise with a  $1\frac{1}{2}$ -inch open-end wrench and remove the packing nut by turning it counterclockwise with a  $1\frac{1}{2}$ -inch open-end wrench. Unscrew the lock nut from the packing nut with the fingers. Remove the packing gland and the packing with the fingers.

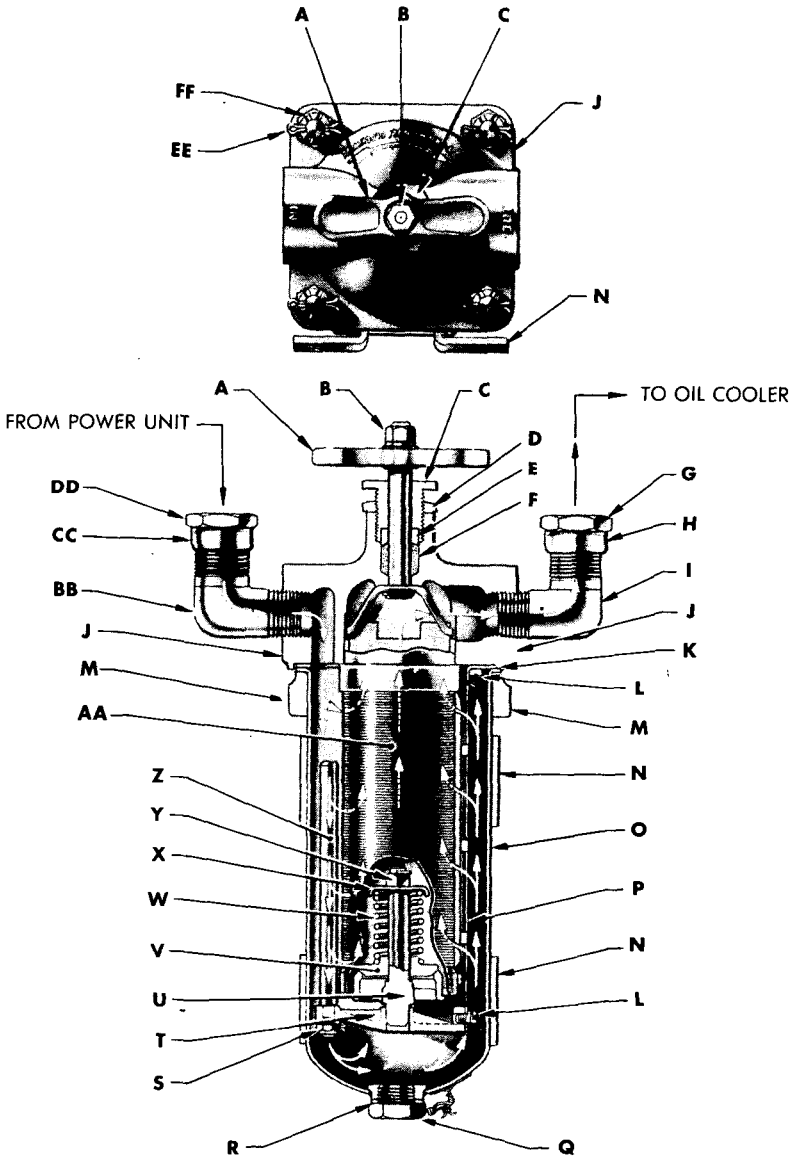
(c) *Remove Filter Element from Head* (figs. 96 and 97).

PLIERS, side cutting                              WRENCH, open-end,  $\frac{7}{16}$ -in.  
SCREWDRIVER

Remove the lock wires from the oil filter knife attaching screws with side cutting pliers. Using a screwdriver, remove the screws, lock washers, and the knife. Remove the cotter pins from the three oil filter relief valve seat spider support studs with side cutting pliers and remove the nuts by turning them counterclockwise with a  $\frac{7}{16}$ -inch open-end wrench.



**ORDNANCE MAINTENANCE—POWER UNIT ACCESSORIES  
FOR MEDIUM TANKS M3A4 AND M4A4**



RA PD 25877

**Figure 96—Full Flow Strainer Type Oil Filter—Cross Sectional View**

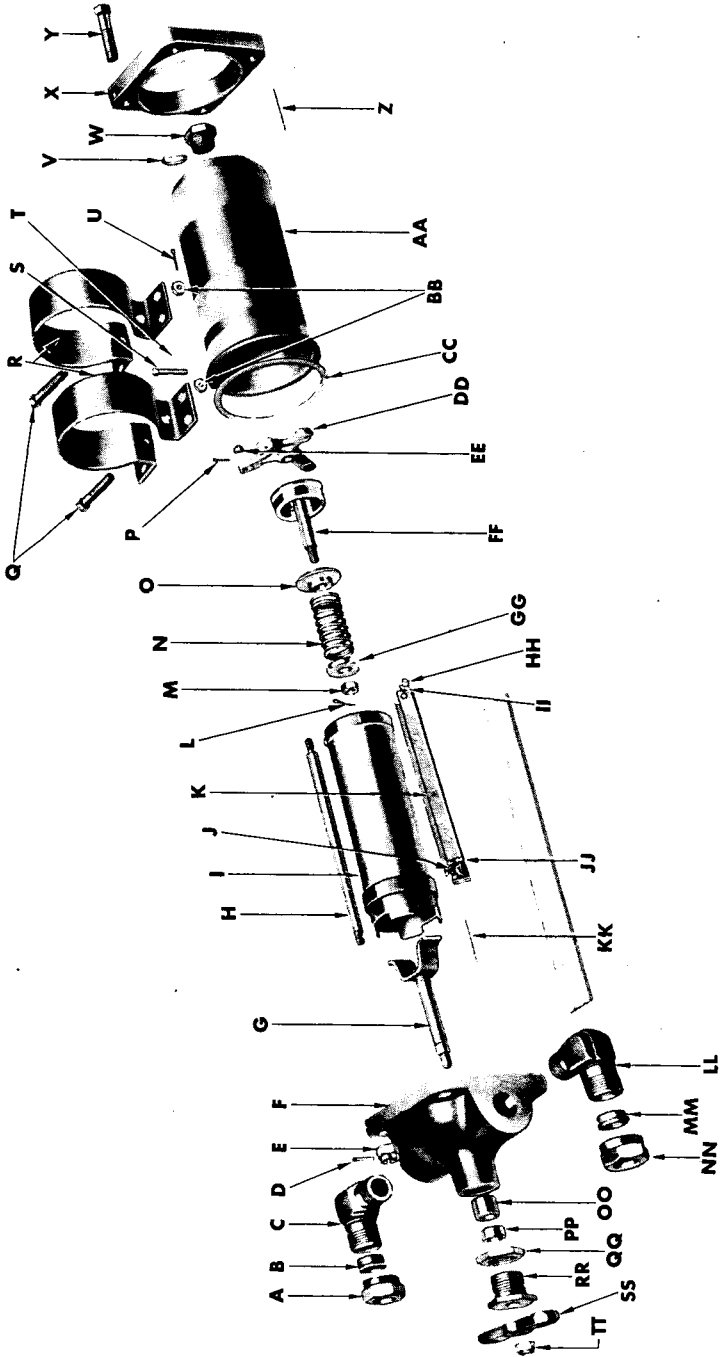
**LUBRICATING OIL FILTERS**

- A**—HANDLE, OIL FILTER ELEMENT DRIVER
- B**—NUT, OIL FILTER ELEMENT DRIVER HANDLE
- C**—NUT, PACKING, OIL FILTER ELEMENT DRIVER
- D**—NUT, LOCK, OIL FILTER ELEMENT DRIVER PACKING NUT
- E**—GLAND, PACKING, OIL FILTER ELEMENT DRIVER
- F**—PACKING, OIL FILTER ELEMENT DRIVER STUFFING BOX
- G**—NUT, FITTING, OIL FILTER, OUTLET
- H**—RING, FITTING, OIL FILTER, OUTLET
- I**—ELBOW, FITTING, OIL FILTER, OUTLET
- J**—HEAD, OIL FILTER
- K**—GASKET, OIL FILTER CASE
- L**—SCREW, ATTACHING, OIL FILTER KNIFE
- M**—RING, RETAINING, OIL FILTER HEAD
- N**—CLAMP, OIL FILTER
- O**—CASE, OIL FILTER
- P**—KNIFE, OIL FILTER, ASSEMBLY
- Q**—PLUG, DRAIN, OIL FILTER
- R**—GASKET, OIL FILTER DRAIN PLUG
- S**—NUT, OIL FILTER RELIEF VALVE SEAT SPIDER SUPPORT STUD
- T**—SPIDER, OIL FILTER RELIEF VALVE SEAT
- U**—SEAT, OIL FILTER RELIEF VALVE, ASSEMBLY
- V**—PISTON, OIL FILTER RELIEF VALVE
- W**—SPRING, OIL FILTER RELIEF VALVE
- X**—WASHER, RETAINING, OIL FILTER RELIEF VALVE SPRING
- Y**—NUT, OIL FILTER RELIEF VALVE SEAT
- Z**—STUD, SUPPORT, OIL FILTER RELIEF VALVE SEAT SPIDER
- AA**—ELEMENT, OIL FILTER, ASSEMBLY
- BB**—ELBOW, FITTING, OIL FILTER, INLET
- CC**—RING, FITTING, OIL FILTER, INLET
- DD**—NUT, FITTING, OIL FILTER, INLET
- EE**—PIN, COTTER, OIL FILTER HEAD RETAINING BOLT NUT
- FF**—NUT, OIL FILTER HEAD RETAINING BOLT

RA PD 25877B

**Legend for Figure 96—Full Flow Strainer Type Oil Filter—Cross Sectional View**

ORDNANCE MAINTENANCE—POWER UNIT ACCESSORIES  
FOR MEDIUM TANKS M3A4 AND M4A4



RA PD 24644

Figure 97—Parts of Full Flow Strainer Type Oil Filter

LUBRICATING OIL FILTERS

- |  |  |
|--|--|
| A—NUT, FITTING, OIL FILTER   | X—RING, RETAINING, OIL FILTER HEAD                       |
| B—RING, FITTING, OIL FILTER  | Y—BOLT, RETAINING, OIL FILTER HEAD                       |
| C—ELBOW, FITTING, OIL FILTER   | Z—WIRE, LOCK, OIL FILTER DRAIN PLUG                      |
| D—PIN, COTTER, OIL FILTER HEAD RETAINING BOLT NUT                      | AA—CASE, OIL FILTER                                      |
| E—NUT, OIL FILTER HEAD RETAINING BOLT                                  | BB—NUT, OIL FILTER CLAMP BOLT                            |
| F—HEAD, OIL FILTER   | CC—GASKET, OIL FILTER CASE                               |
| G—DRIVER, OIL FILTER ELEMENT, ASSEMBLY                                 | DD—SPIDER, OIL FILTER RELIEF VALVE SEAT                  |
| H—STUD, SUPPORT, OIL FILTER RELIEF VALVE SEAT SPIDER                   | EE—NUT, OIL FILTER RELIEF VALVE SEAT SPIDER SUPPORT STUD |
| I—ELEMENT, OIL FILTER, ASSEMBLY  | FF—SEAT, OIL FILTER RELIEF VALVE, ASSEMBLY               |
| J—WASHER, LOCK, OIL FILTER KNIFE ATTACHING SCREW                       | GG—WASHER, RETAINING, OIL FILTER RELIEF VALVE SPRING     |
| K—KNIFE, OIL FILTER, ASSEMBLY  | HH—SCREW, ATTACHING, OIL FILTER KNIFE                    |
| L—PIN, COTTER, OIL FILTER RELIEF VALVE SEAT NUT                        | II—WASHER, LOCK, OIL FILTER KNIFE ATTACHING SCREW        |
| M—NUT, OIL FILTER RELIEF VALVE SEAT                                    | JJ—SCREW, ATTACHING, OIL FILTER KNIFE                    |
| N—SPRING, OIL FILTER RELIEF VALVE                                      | KK—WIRE, LOCK, OIL FILTER KNIFE ATTACHING SCREW          |
| O—PISTON, OIL FILTER RELIEF VALVE                                      | LL—ELBOW, FITTING, OIL FILTER                            |
| P—PIN, COTTER, OIL FILTER RELIEF VALVE SEAT SPIDER<br>SUPPORT STUD NUT | MM—RING, FITTING, OIL FILTER                             |
| Q—BOLT, CLAMP, OIL FILTER  | NN—NUT, FITTING, OIL FILTER                              |
| R—CLAMP, OIL FILTER  | OO—PACKING, OIL FILTER ELEMENT DRIVER STUFFING BOX       |
| S—SCREW, ATTACHING, OIL FILTER CLAMP                                   | PP—GLAND, PACKING, OIL FILTER ELEMENT DRIVER             |
| T—WIRE, LOCK, OIL FILTER CLAMP ATTACHING SCREW                         | QQ—NUT, LOCK, OIL FILTER ELEMENT DRIVER PACKING NUT      |
| U—PIN, COTTER, OIL FILTER CLAMP BOLT NUT                               | RR—NUT, PACKING, OIL FILTER ELEMENT DRIVER               |
| V—GASKET, OIL FILTER DRAIN PLUG  | SS—HANDLE, OIL FILTER ELEMENT DRIVER                     |
| W—PLUG, DRAIN, OIL FILTER  | TT—NUT, OIL FILTER ELEMENT DRIVER HANDLE                 |

RA PD 24644B

Legend for Figure 97 —Parts of Full Flow Strainer Type Oil Filter



## LUBRICATING OIL FILTERS

the piston toward the threaded end of the shaft. Slide the relief valve spring and the spring retaining washer over the shaft. Screw the nut onto the shaft just far enough to clear the cotter pin hole in the shaft with a  $\frac{9}{16}$ -inch open-end wrench. Secure the nut with a cotter pin, bending over the ends of the cotter pin with pliers.

(b) *Assemble Oil Filter Element, Driver, and Relief Valve to Oil Filter Head* (figs. 96 and 97).

PLIERS, side cutting

VICE

TOOL, stud installing

WRENCH, open-end,  $\frac{7}{16}$ -in.

Place the filter head in a vise with the flange of the head up. Install the three relief valve seat spider support studs in the head with a stud installing tool. Slide the element driver shaft through the hole in the filter head. Aline the openings in the top of the element with the prongs of the driver and push the element into position in the filter head. Slide the relief valve assembly into the filter element until the shoulder of the valve seat rests against the end of the element. Aline the knife attaching arm of the spider with the knife attaching screw holes in the head and the support stud holes of the spider with the support studs and slide the spider over the studs with the hub side of the spider toward the element. Install the three support stud nuts, and tighten with a  $\frac{7}{16}$ -inch open-end wrench. Secure the nuts with cotter pins, bending over the ends of the cotter pins with side cutting pliers. Remove the filter head and element assembly from the vise.

(c) *Install Stuffing Box Packing* (figs. 96 and 97).

WRENCH, open-end,  $\frac{9}{16}$ -in.

WRENCH, open-end,  $1\frac{1}{2}$ -in.

Slide the new packing over the end of the driver shaft and into the opening in the top of the oil filter head. Slide the packing gland over the end of the driver shaft with the flat side of the gland away from the head and insert the gland into the opening on top of the head. Screw the packing nut lock on the packing nut as far as it will go with a  $1\frac{1}{2}$ -inch open-end wrench. Screw packing nut into top of filter head by turning it clockwise with a  $1\frac{1}{2}$ -inch open-end wrench and tighten lock nut against the filter head. Place driver handle in position on driver shaft and secure handle in place with nut. Tighten nut securely with a  $\frac{9}{16}$ -inch open-end wrench.

(d) *Assemble Fittings to Oil Filter Head* (figs. 96 and 97).

WRENCH, open-end,  $1\frac{3}{8}$ -in.

Place the ring fitting in position in the large opening of the elbow with the rolled end of the ring out and screw the nut into position over the ring, tightening nut with a  $1\frac{3}{8}$ -inch open-end wrench. Screw fitting elbow into opening in side of filter head and tighten securely with a  $1\frac{3}{8}$ -inch open-end wrench. NOTE: When fitting is installed, the elbow

**ORDNANCE MAINTENANCE—POWER UNIT ACCESSORIES  
FOR MEDIUM TANKS M3A4 AND M4A4**

of the fitting should point toward the top of the filter (19½ deg from vertical).

(e) *Install Oil Filter Knife Assembly* (figs. 96 and 97).

**PLIERS**, side cutting

**SCREWDRIVER**

Align the two screw holes in the upper end of the knife bracket with the two holes in the bottom of the oil filter head and the screw hole at the lower end of the knife bracket with the hole in the knife attaching arm of the filter element spider. Secure the knife to the head and the spider with lock washers and screws. Tighten screws securely. Insert lock wires through the holes in the screws and twist the ends of the lock wires together with side cutting pliers.

(f) *Assemble Oil Filter Case to Oil Filter Head* (figs. 96 and 97).

**PLIERS**, side cutting

**WRENCH**, open-end, ¾-in. (2)

Slide oil filter head retaining ring over end of filter case with the flat side of the ring toward the bottom of the filter. Place a new filter case gasket in position on the open end of filter case. Slide filter case, gasket and retaining ring, as an assembly, over element and into position against filter head. Insert the filter head retaining bolts up through the holes in the retaining ring and through the holes in the filter head. Screw the nuts on the bolts and tighten the nuts securely by holding the bolt heads with a ¾-inch open-end wrench and turning the nuts with a ¾-inch open-end wrench. Secure the nuts with cotter pins and bend the ends of the cotter pins over, with side cutting pliers.

(g) *Assemble Oil Filter Drain Plug and Clamps to Oil Filter Case* (figs. 96 and 97).

**PLIERS**, side cutting

**WRENCH**, open-end, 9/16-in.

**SCREWDRIVER**

**WRENCH**, open-end, 1½-in.

Slide a new drain plug gasket over the threaded end of the drain plug. Screw the drain plug into the case and tighten it securely with a 1½-inch open-end wrench. Insert a lock wire through the hole in head of the drain plug and under the clip at lower end of case. Twist ends of lock wire together with side cutting pliers. Slide the clamps over the end of the oil filter case, with the closed side of each clamp against the side of the filter on which the indicating arrow is located. Insert clamp bolts through holes in clamps. Screw clamp bolt nuts onto bolts and tighten nuts securely by holding the nuts with a 9/16-inch open-end wrench and turning the bolts with a screwdriver. Secure the nuts with cotter pins, bending back the ends of the cotter pins with side cutting pliers.

**CHAPTER 3**  
**POWER UNIT LUBRICATING SYSTEM (Cont'd)**

**Section V**

**LUBRICATING OIL LINES, OIL COOLER, AND OIL SUPPLY TANK**

	Paragraph
Lubricating oil lines .....	42
Lubricating oil cooler .....	43
Lubricating oil supply tank .....	44

**42. LUBRICATING OIL LINES.**

a. **General.** Flexible hose and metal tubing are used to conduct the oil from the power unit to oil supply tanks (figs. 64, 65, 66, 67, 68, and 69).

b. **Removal and Installation.**

(1) When installing be sure all retaining clips are attached securely, and that there are no kinks which will restrict the flow of oil.

**43. LUBRICATING OIL COOLER.**

a. **General.** The oil cooler (figs. 63, 64, 65, 66, and 95) is a fin and tube type cooler mounted in the bulkhead to the right of the propeller shaft. Oil is forced by the scavenger pump from the power unit through the cooler and then into the oil supply tank. Air is drawn by the power unit fan through the cooler, thus cooling the oil before it is delivered to the oil supply tank.

b. **Removal.**

(1) Refer to TM 9-754, January 21, 1943 (par. 58 c) for removal procedure.

c. **Installation.**

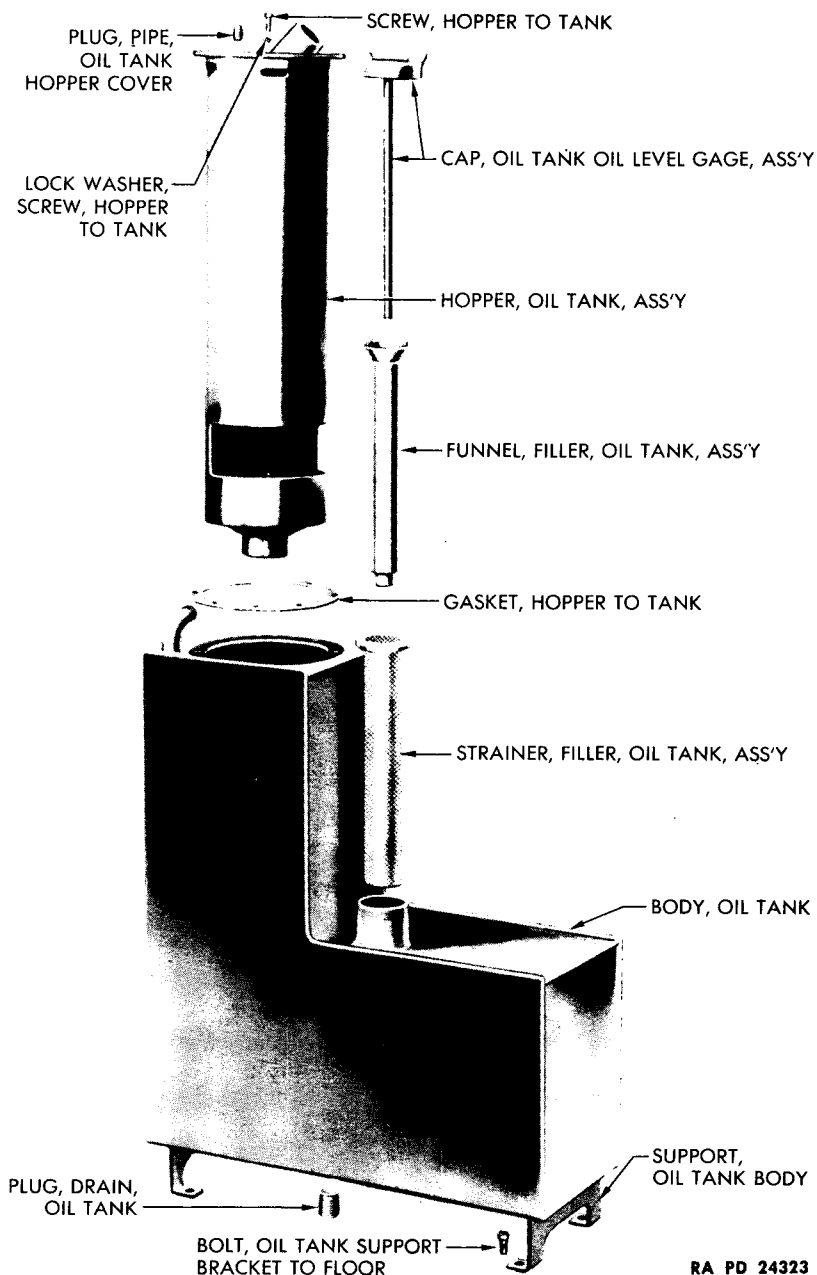
(1) Refer to TM 9-754, January 21, 1943 (par. 58 d) for installation procedure.

**44. LUBRICATING OIL SUPPLY TANK.**

a. **General.** The oil supply tank (figs. 63, 64, 65, 66, and 95) is mounted against the bulkhead in the fighting compartment to the right of the propeller shaft. A hopper, which separates air from the oil, is built integral with the supply tank and is connected internally. An oil level gage (blade type) composes the cap of the oil filler tube. An air vent hose connects the hopper tank with the crankcase of No. 5 engine (figs. 64 and 65).



**ORDNANCE MAINTENANCE—POWER UNIT ACCESSORIES  
FOR MEDIUM TANKS M3A4 AND M4A4**



RA PD 24323

**Figure 98—Parts of Oil Supply Tank**

**LUBRICATING OIL LINES, OIL COOLER, AND OIL SUPPLY TANK**

**h. Removal.**

- |  |  |
|--|--|
| <b>PLIERS</b>  | <b>WRENCH, open-end, 1<math>\frac{5}{16}</math>-in.</b>  |
| <b>PLIERS, side cutting</b>                                | <b>WRENCH, open-end, 1<math>\frac{1}{2}</math>-in.</b>   |
| <b>SCREWDRIVER</b>   | <b>WRENCH, open-end, 1<math>\frac{3}{4}</math>-in.</b>   |
| <b>WRENCH, open-end, <math>\frac{9}{16}</math>-in. (2)</b> | <b>WRENCH, open-end, 1<math>\frac{15}{16}</math>-in.</b> |
| <b>WRENCH, open-end, 1<math>\frac{5}{16}</math>-in.</b>    | <b>WRENCH, socket, <math>\frac{7}{16}</math>-in.</b>     |
| <b>WRENCH, open-end, 1<math>\frac{3}{16}</math>-in.</b>    | <b>WRENCH, socket, <math>\frac{5}{8}</math>-in.</b>      |

**(1) REMOVE 75-MM AMMUNITION RACK, STOWAGE BOX, AND AIR CLEANER.**

- |  |   |
|--|---|
| <b>SCREWDRIVER</b>                                   | <b>WRENCH, socket, <math>\frac{5}{8}</math>-in.</b> |
| <b>WRENCH, socket, <math>\frac{7}{16}</math>-in.</b> |   |

Unlatch escape door and open. Revolve turret until 75-mm ammunition rack in back of assistant driver's seat is accessible through door in turret basket floor. Remove four flat-head screws securing rack to floor (one man with screwdriver underneath vehicle, second man inside with  $\frac{5}{8}$ -in. socket wrench to hold nuts). Push rack forward into space cleared by opening escape door. Revolve turret until stowage box located at rear of ammunition rack is accessible. Remove six flat-head screws securing stowage box to floor (one man with screwdriver underneath vehicle, second man inside with  $\frac{7}{16}$ -in. socket wrench to hold nuts). Push stowage box forward as far as possible. Revolve turret until oil supply tank is accessible through opening in side of turret basket. Loosen three thumb screws and remove air cleaner to give additional room.

**(2) DISCONNECT OIL TANK HOPPER AIR VENT HOSE (fig. 63).**

- |               |                             |
|---------------|-----------------------------|
| <b>PLIERS</b> | <b>PLIERS, side cutting</b> |
|---------------|-----------------------------|

Remove locking wire (side cutting pliers). Loosen air vent hose clamp thumb screw (pliers). Disconnect hose.

**(3) DRAIN POWER UNIT LUBRICATION SYSTEM.**

(a) To drain the power unit lubrication system, follow procedure outlined in TM 9-754, January 21, 1943 (par. 54 d).

**(4) DISCONNECT OIL TANK OUTLET HOSE (fig. 65).**

- |  |  |
|--|--|
| <b>WRENCH, open-end, 1<math>\frac{1}{2}</math>-in.</b> | <b>WRENCH, open-end, 1<math>\frac{3}{4}</math>-in.</b> |
|--|--|

Disconnect between hose and coupling.

**(5) DISCONNECT OIL TANK TO OIL COOLER HOSE (fig. 65).**

- |   |   |
|---|---|
| <b>WRENCH, open-end, 1<math>\frac{5}{16}</math>-in.</b> | <b>WRENCH, open-end, 1<math>\frac{5}{16}</math>-in.</b> |
| <b>WRENCH, open-end, 1<math>\frac{3}{16}</math>-in.</b> |   |

Disconnect hose at oil cooler end using 1 $\frac{5}{16}$ -inch and 1 $\frac{3}{16}$ -inch open-end wrenches, then remove hose at oil tank hopper inlet with 1 $\frac{5}{16}$ -inch open-end wrench.

**(6) REMOVE OIL SUPPLY TANK FROM VEHICLE.**

- |  |
|--|
| <b>WRENCH, open-end, <math>\frac{9}{16}</math>-in. (2)</b> |
|--|

Take out four oil tank support bracket to floor bolts (fig. 98) (one man

**ORDNANCE MAINTENANCE—POWER UNIT ACCESSORIES  
FOR MEDIUM TANKS M3A4 AND M4A4**

underneath vehicle to remove nuts, second man inside vehicle to keep bolts from turning). Lift oil tank into turret and then through turret hatch.

**c. Disassembly.**

**WRENCH**,  $\frac{7}{16}$ -in.

(1) Unscrew and remove oil level gage (turn counterclockwise); using handle, lift funnel out of filler tube. Lift screen out of filler tube (fig. 98).

(2) Remove 12 cap screws and withdraw hopper from tank (fig. 98).

**d. Inspection of Parts.**

**PAN**, for washing parts.

(1) Be sure drain plug has been removed from oil tank.

(2) Wash all parts thoroughly with **SOLVENT**, dry-cleaning. Flush out oil tank. **CAUTION**: Be sure all **SOLVENT**, dry-cleaning, is removed from parts and out of tank before assembly.

(3) Check for breaks in welds or other possible points of leakage.

(4) Check filler screen for breaks.

**e. Assembly.**

**WRENCH**,  $\frac{7}{16}$ -in.

**WRENCH**, socket head set screw,  $\frac{9}{16}$ -in.

(1) Using *new* gasket, install hopper and secure with 12 cap screws and lock washers ( $\frac{7}{16}$ -inch wrench).

(2) Insert screen in tube, insert funnel in tube, install oil level gage, and tighten securely with fingers.

(3) Install drain plug ( $\frac{9}{16}$ -in. socket head set screw wrench).

**f. Installation.**

**PLIERS**

**WRENCH**, open-end,  $1\frac{5}{16}$ -in.

**PLIERS**, side cutting

**WRENCH**, open-end,  $1\frac{1}{2}$ -in.

**SCREWDRIVER**

**WRENCH**, open-end,  $1\frac{3}{4}$ -in.

**WRENCH**, open-end,  $\frac{9}{16}$ -in. (2)

**WRENCH**, open-end,  $1\frac{1}{2}$ -in.

**WRENCH**, open-end,  $1\frac{5}{16}$ -in.

**WRENCH**, socket,  $\frac{7}{16}$ -in.

**WRENCH**, open-end,  $1\frac{3}{16}$ -in.

**WRENCH**, socket,  $\frac{5}{8}$ -in.

(1) **INSTALL OIL TANK IN VEHICLE.**

**WRENCH**, open-end,  $\frac{9}{16}$ -in. (2)

Lower oil supply tank through turret hatch and then through opening in turret basket into proper position. Secure with four bolts through support brackets (one man necessary underneath vehicle).

(2) **INSTALL OIL TANK TO OIL COOLER HOSE** (fig. 65).

**WRENCH**, open-end,  $1\frac{5}{16}$ -in.

**WRENCH**, open-end,  $1\frac{5}{16}$ -in.

**WRENCH**, open-end,  $1\frac{3}{16}$ -in.

## LUBRICATING OIL LINES, OIL COOLER, AND OIL SUPPLY TANK

Connect hose at oil tank hopper inlet with  $1\frac{5}{16}$ -inch open-end wrench. Connect hose to oil cooler, using  $1\frac{5}{16}$ -inch and  $1\frac{3}{16}$ -inch open-end wrenches.

(3) **INSTALL OIL TANK TO ENGINE HOSE (fig. 65).**

**WRENCH**, open-end,  $1\frac{1}{2}$ -in.      **WRENCH**, open-end,  $1\frac{3}{4}$ -in.

Connect outlet hose to coupling with connector.

(4) **INSTALL AIR VENT HOSE (fig. 65).**

**PLIERS**      **PLIERS**, side cutting

Install hose and tighten hose clamp thumbscrew with pliers. Lock thumbscrew with locking wire (side cutting pliers).

(5) **INSTALL 75-MM AMMUNITION RACK, STOWAGE BOX, AND AIR CLEANER.**

**SCREWDRIVER**      **WRENCH**, socket,  $\frac{5}{8}$ -in.

**WRENCH**, socket,  $\frac{7}{16}$ -in.

Install air cleaner and tighten the three thumbscrews. Revolve turret until opening in floor is in proper position. Slide stowage box into place. Secure with six flat-head screws (one man underneath vehicle with screwdriver, second man inside with  $\frac{7}{16}$ -in. socket wrench to hold nuts). Revolve turret until ammunition rack mounting location is accessible. Slide ammunition rack into place. Secure with four flat-head screws (one man underneath vehicle with screwdriver and second man inside with  $\frac{5}{8}$ -in. socket wrench to hold nuts). Close escape door and latch.

(6) **FILL POWER UNIT LUBRICATION SYSTEM.**

(a) Refer to TM 9-754, January 21, 1943 (par. 54 e), for procedure.

ORDNANCE MAINTENANCE—POWER UNIT ACCESSORIES  
FOR MEDIUM TANKS M3A4 AND M4A4

CHAPTER 3  
POWER UNIT LUBRICATING SYSTEM (Cont'd)

Section VI

LIMITS AND TOLERANCES

	Paragraph
Limits and tolerances . . . . .	45
Standard for tightening bolts . . . . .	46

45. LIMITS AND TOLERANCES.

a. Oil Pressure Pump.

	Minimum	Maximum
Pressure . . . . .	25 lb per sq in. at idle 30 lb per sq in. above 1,500 rpm	65 lb per sq in.
Capacity at 1,500 rpm pump speed . . . . .	200 lb per minute at 40 lb per sq in. Discharge pressure with SAE 30 oil at 160 degrees F inlet oil temperature	
Idler gear shaft . . . . .	0.7385 in.	0.7390 in.
Idler gear bushing, reamed . . . . .	0.740 in.	0.741 in.
Clearance, idler gear shaft to bushing . . . . .	0.0010 in.	0.0025 in.
Intermediate gear shaft end . . . . .	1.060 in.	1.061 in.
Intermediate gear bushings . . . . .	1.0625 in.	1.0635 in.
Clearance, intermediate gear shaft end to bushings . . . . .	0.0015 in.	0.0035 in.
Relief valve spring		
Free height . . . . .		2 <sup>15</sup> / <sub>16</sub> in.
Under 16-pound load . . . . .		1 <sup>5</sup> / <sub>8</sub> in.
Gear backlash . . . . .	0.007 in.	0.012 in.
Clearance between pump body and gears		
Radial . . . . .	0.004 in.	0.005 in.
End . . . . .	0.0075 in.	0.011 in.

b. Oil Scavenger Pump.

Idler gear shaft . . . . .	0.7385 in.	0.7390 in.
Idler gear bushings . . . . .	0.740 in.	0.741 in.
Clearance, idler gear shaft to bushing . . . . .	0.0010 in.	0.0025 in.
Intermediate gear pilot shaft . . . . .	0.7385 in.	0.7390 in.

**LIMITS AND TOLERANCES**

	Minimum	Maximum
Intermediate gear lower bushing . . . . .	0.740 in.	0.741 in.
Clearance between pilot shaft and lower bushing . . . . .	0.0010 in.	0.0025 in.
Intermediate gear shaft upper end . . . . .	1.060 in.	1.061 in.
Intermediate gear upper bushing . . . . .	1.0625 in.	1.0635 in.
Clearance, intermediate gear shaft upper end and upper bushing . . . . .	0.0015 in.	0.0035 in.
Gear backlash . . . . .	0.007 in.	0.012 in.

**46. STANDARD FOR TIGHTENING BOLTS.**

**a. Torque Tightness.**

Oil scavenger pump attaching screws . . . . .	30 ft-lb	35 ft-lb
Oil pressure pump attaching screws . . . . .	30 ft-lb	35 ft-lb

ORDNANCE MAINTENANCE—POWER UNIT ACCESSORIES  
FOR MEDIUM TANKS M3A4 AND M4A4

CHAPTER 4  
COOLING SYSTEM

Section I  
DESCRIPTION OF SYSTEM

	Paragraph
General .....	47
Description .....	48
Tabulated data and specifications .....	49
Echelon break-down of maintenance .....	50

**47. GENERAL.**

a. The power unit is equipped with a pressure type liquid cooling system, the function of which is to remove excess heat from the engine cylinder walls and valves and to reject the heat to the outside air. The principal parts of the system are radiator, water pump, thermostats, pressure vent valve, water distributor tube, and fan.

**48. DESCRIPTION.**

a. The water flows through the system parts in the following order: Radiator lower tank, water pump suction tubes, water pump, water distributor tube, engine cylinder block and head, engine water outlets, radiator inlets, radiator upper tank, radiator core, and radiator lower tank.

b. The engine is cooled by the water flowing through it. The water then passes through the radiator where the water is cooled by the air which the fan forces through the radiator core. Five thermostats are used to control the power unit water temperature. The pressure vent valve maintains a vapor pressure on the system which raises the boiling point of the water, prevents water loss through the overflow, and eliminates the possibility of a vacuum forming in the cooling system.

**49. TABULATED DATA AND SPECIFICATIONS.**

**a. Water Pump (Multiple Type Only).**

Belt length (pitch circumference)

No. 1 ..... 40 in.

No. 2 ..... 52  $\frac{3}{4}$  in.

Nos. 3, 4, and 5 ..... 45  $\frac{5}{16}$  in.

Belt width, maximum .....  $\frac{3}{4}$  in.

Capacity, at 1,511 rpm of engine ..... 246 pounds, minimum

Drive ..... V-belt

**DESCRIPTION OF SYSTEM**

Speed (ratio to crankshaft) . . . . . 1.36 to 1, normal belt adjustment  
Type . . . . . Centrifugal

**b. Water Pump (Single Type Only).**

Capacity, at 1,511 rpm of engine . . . . . 1,130 pounds, minimum  
Drive . . . . . Accessory shaft  
Type . . . . . Centrifugal  
Speed (ratio to crankshaft) . . . . . 0.840 to 1

**c. Thermostats.**

Valve opens . . . . . 160 F  
Refer to paragraph 59.

**d. Capacity of Cooling System.**

32 gallons

**e. Pressure Vent Valve.**

Relieves vapor pressure at . . . . . 10 lb per sq in.  
Relieves vacuum at . . . . . Minus ¼ lb per sq in.  
Maintains maximum water temperature (at 10-lb per sq inch  
vapor pressure) . . . . . 240 F

**50. ECHELON BREAK-DOWN OF MAINTENANCE.**

a. Refer to paragraph 4.



**ORDNANCE MAINTENANCE—POWER UNIT ACCESSORIES  
FOR MEDIUM TANKS M3A4 AND M4A4**

**CHAPTER 4**

**COOLING SYSTEM (Cont'd)**

**Section II**

**TROUBLE SHOOTING**

	<b>Paragraph</b>
General .....	51
Trouble shooting .....	52

**51. GENERAL.**

a. The various cooling system troubles which may be encountered are herein discussed as to possible cause with the accompanying possible remedy. Perform the tests as listed for eliminating the troubles encountered.

**52. TROUBLE SHOOTING.**

**a. Water Temperature Light Comes On.**

<b>Possible Cause</b>	<b>Possible Remedy</b>
High coolant temperature.	Follow procedure as outlined in paragraph 52 b.
Low coolant level.	Correct level. Test coolant level. If below correct level, refill and recheck for leaks.
Faulty sending unit.	Replace unit. Follow procedure as outlined in TM 9-754, January 21, 1943, paragraph 175 d.

**b. Water Temperature Gage Reads High.**

Faulty sending units.	Replace units (TM 9-754, January 21, 1943, par. 174 g and i; par. 175 d).
Faulty water temperature gage.	Replace unit. Remove faulty temperature gage and install with new gage as outlined in TM 9-754, January 21, 1943, paragraph 174 c.
Low coolant level.	Correct level. Follow procedure as listed under paragraph 52 a.
Air inlet grille obstructed.	Remove obstruction.
Exterior of radiator dirty.	Clean.
Water pump belt broken or slipping (multiple water pump type).	Replace belt (TM 9-754, January 21, 1943, par. 86).

## TROUBLE SHOOTING

Possible Cause	Possible Remedy
Inoperative water pump.	Repair or replace.
Thermostats inoperative.	
Damaged from overheating.	Replace.
Damaged from freezing.	Replace.
Opening and closing improperly.	Replace.
Collapsed or obstructed water hose.	Replace hose (TM 9-754, January 21, 1943, par. 87).
Water loss caused by loose cylinder head.	Tighten cylinder head stud nuts or replace gasket.
Water distributor tube in cylinder block rusted or corroded.	Replace tube.
<b>c. Water Temperature Gage Reads Low.</b>	
Faulty water temperature gage.	Replace gage (TM 9-754, January 21, 1943, par. 174 c).
Faulty sending unit.	Replace unit (TM 9-754, January 21, 1943, par. 174 g and i).
<b>d. Steam Coming from Radiator Overflow, Water Temperature At (but Not Over) 212 F.</b>	
Faulty pressure vent valve.	Replace valve (TM 9-754, January 21, 1943, par. 91).

ORDNANCE MAINTENANCE—POWER UNIT ACCESSORIES  
FOR MEDIUM TANKS M3A4 AND M4A4

CHAPTER 4  
COOLING SYSTEM (Cont'd)

Section III  
WATER PUMPS

	Paragraph
General .....	53
Multiple water pump type .....	54
Single water pump type .....	55

**53. GENERAL.**

a. The power unit is equipped with five individual water pumps (up to and including power unit serial number 2304) and described as the multiple water pump type. After power unit serial number 2304, the power unit is equipped with one water pump and referred to as the single water pump type.

**54. MULTIPLE WATER PUMP TYPE.**

a. **Description.**

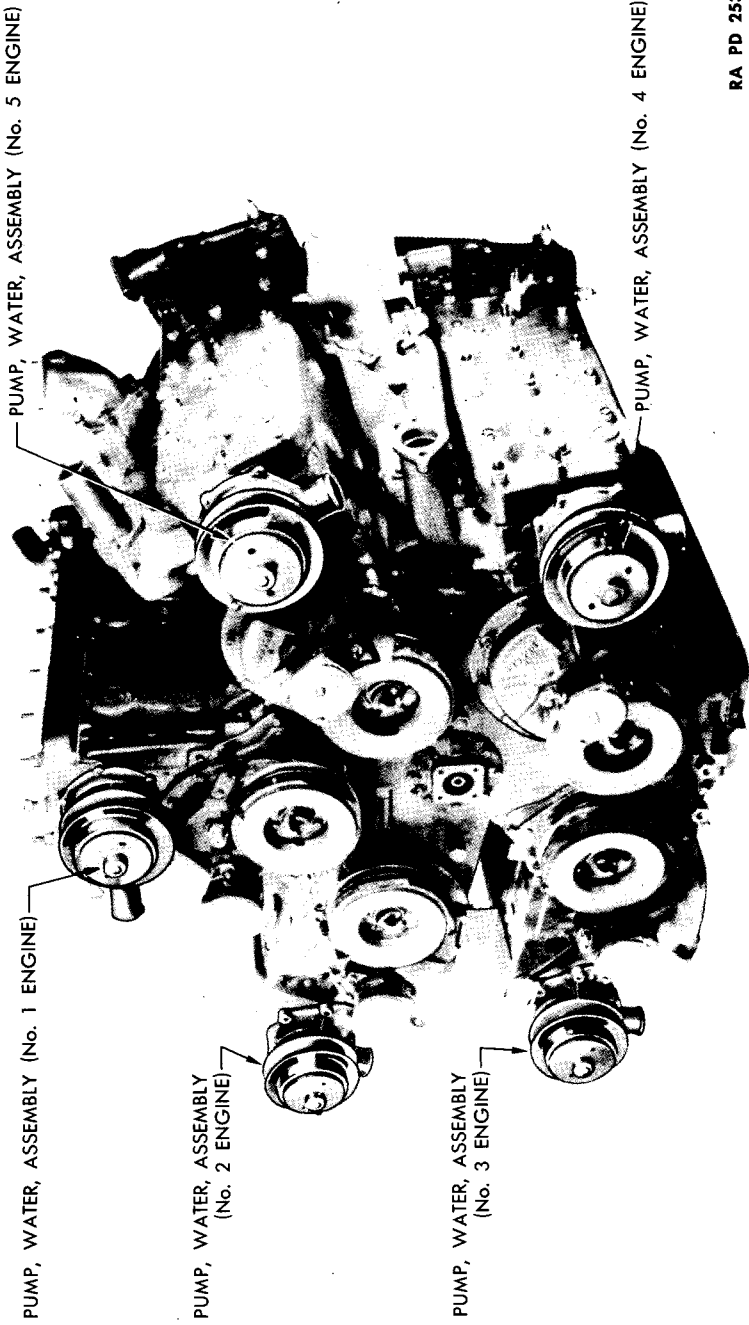
(1) Each individual engine is equipped with a water pump, being bolted to the engine cylinder block at the distributor end of engine (fig. 99). Water enters the pump through a tube connected to the outer edge of the pump body, being discharged direct to the cylinder block.

(2) The water pumps are mechanically the same and of the centrifugal type, however, they are not interchangeable as complete assemblies. Three different types of pumps are used on the power unit. The Nos. 2 and 3 engines use only one body and the Nos. 4 and 5 engines a second type body (fig. 100). The difference in these pump bodies is the location of the inlet and the method of mounting on cylinder block. The water pump body of No. 1 engine differs in construction from either of the other two types. The water pumps of Nos. 2, 3, 4, and 5 engines are attached to the cylinder block as a complete assembly, while No. 1 engine water pump body plate is attached to the cylinder block and the body is then attached to the pump body plate (fig. 101).

(3) The pumps are driven by V-type belts off the impulse neutralizers. The water pump drive belts on engines Nos. 3, 4, and 5 are of the same length and interchangeable. The No. 2 water pump belt is longer and drives the generator as well as the water pump. The No. 1 water pump belt is the shorter.

(4) A broken belt or one slipping will be sufficient cause for the

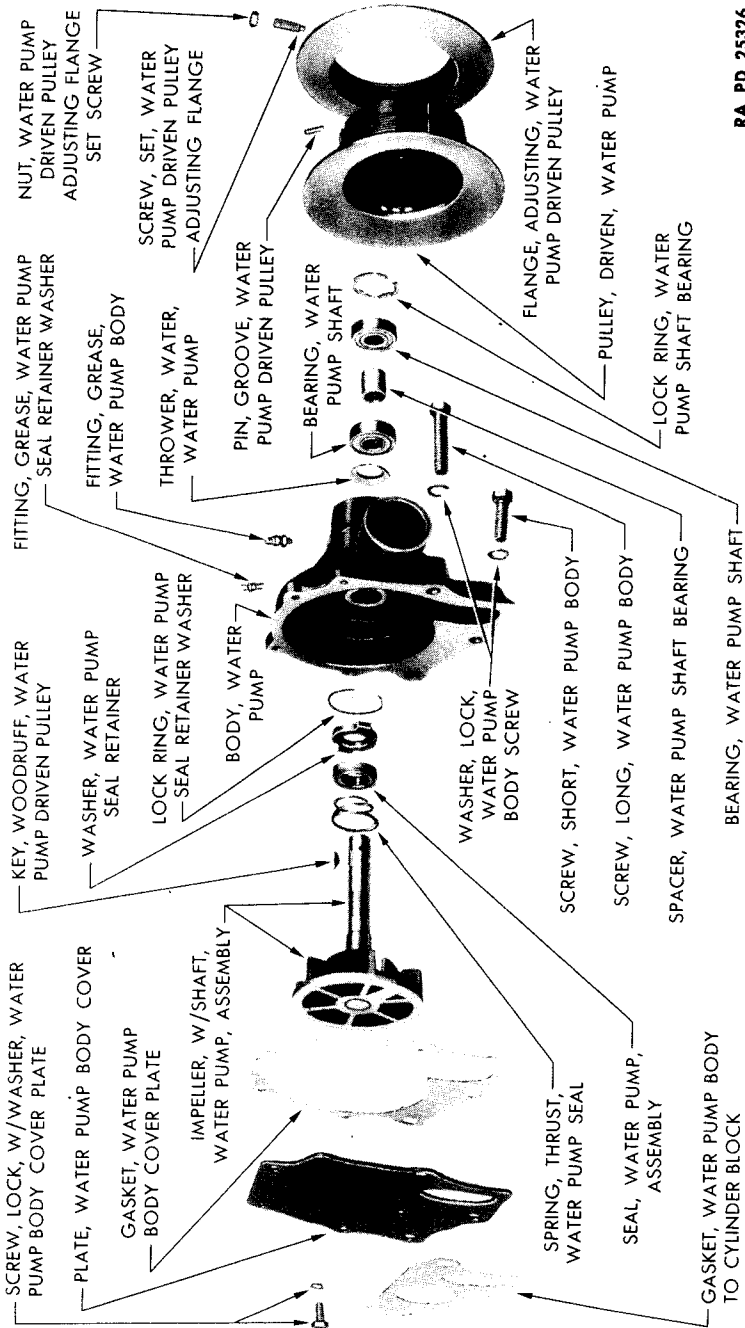
WATER PUMPS



RA PD 25324

Figure 99—Location of Multiple Type Water Pumps

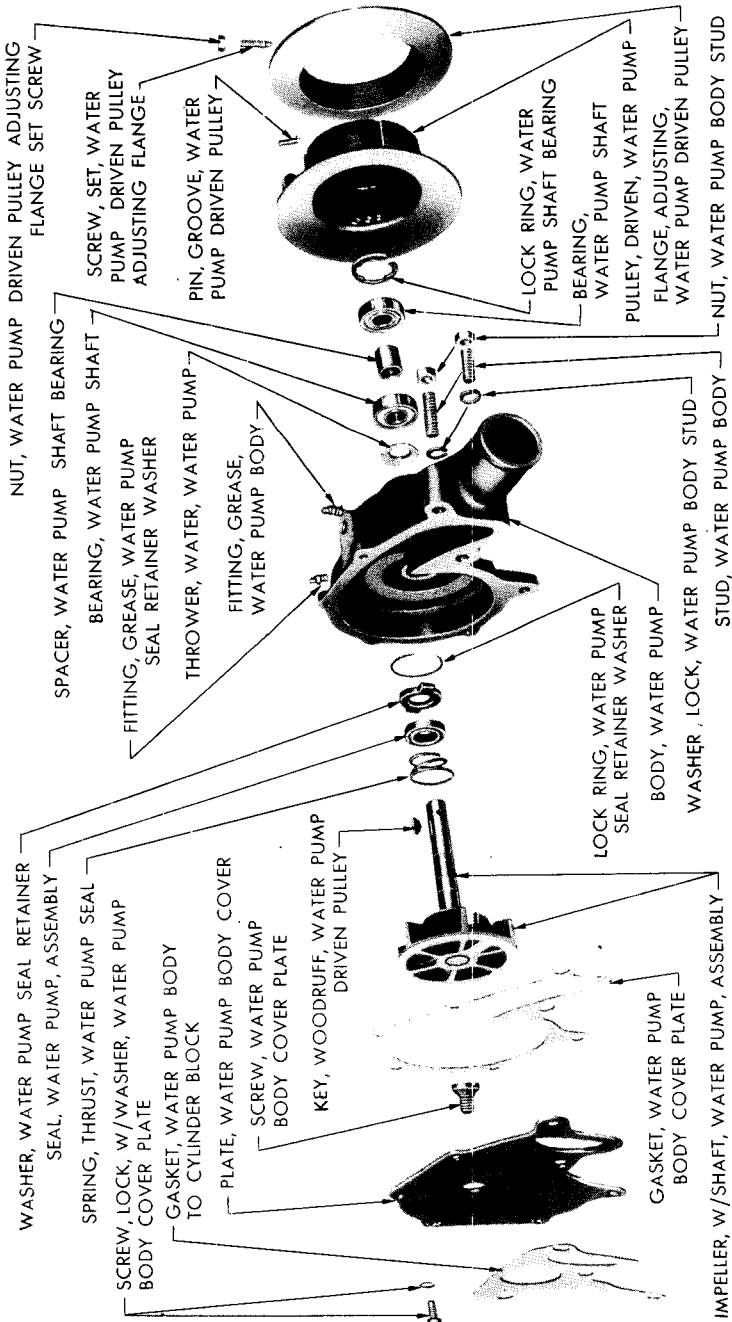
**ORDNANCE MAINTENANCE—POWER UNIT ACCESSORIES  
FOR MEDIUM TANKS M3A4 AND M4A4**



RA PD 25926

**Figure 100—Parts of Water Pump for Nos. 2, 3, 4, and 5 Engines**

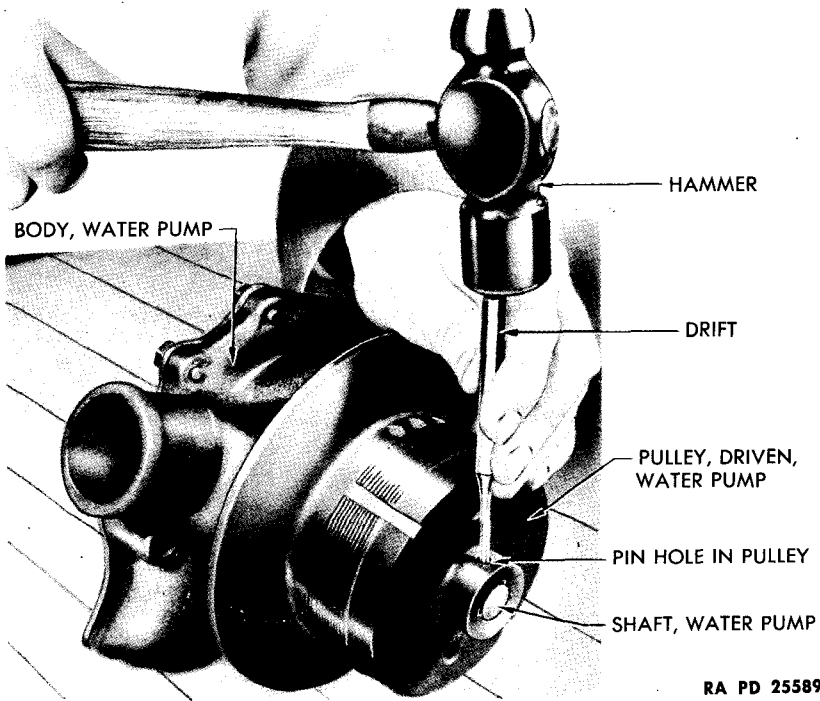
WATER PUMPS



RA PD 25328

Figure 101—Parts of Water Pump for No. 1 Engine

**ORDNANCE MAINTENANCE—POWER UNIT ACCESSORIES  
FOR MEDIUM TANKS M3A4 AND M4A4**



**Figure 102—Driven Pulley Pin Removal**

overheating of any one particular engine. All belts should be replaced, after 100 hours or 1,000 miles of operation, to safeguard against any such occurrence.

**b. Removal.**

(1) Refer to TM 9-754, January 21, 1943 (par. 84 d), for removal procedure.

**c. Disassembly.**

DRIFT, brass

DRIFT, steel

HAMMER, steel

PLIERS, thin nosed

PRESS

PULLER, driven pulley

WRENCH, 3/8-in.

(1) REMOVE DRIVEN PULLEY.

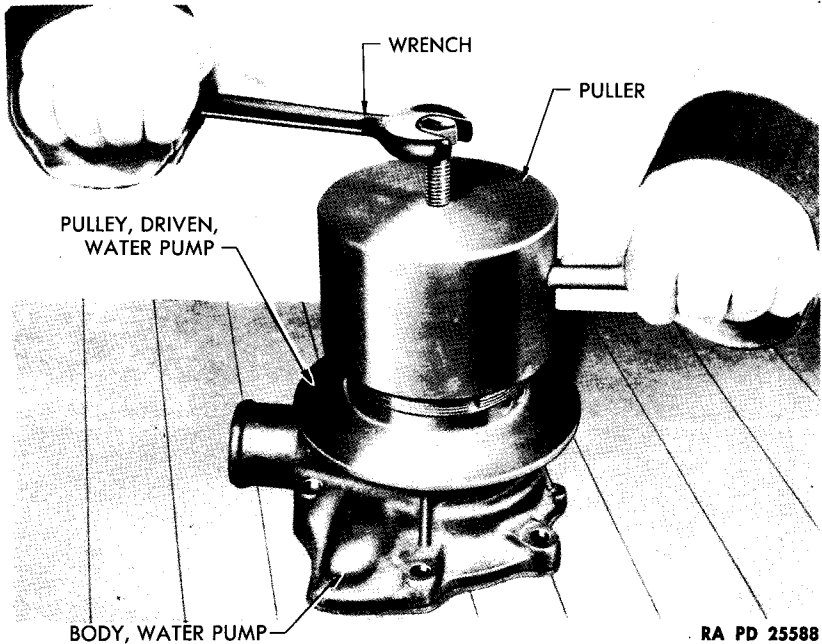
DRIFT, steel

PULLER, driven pulley

HAMMER, steel

Using hammer and drift, remove pin from driven pulley (fig. 102). With a driven pulley puller, remove the driven pulley from pump shaft (fig. 103).

## WATER PUMPS



**Figure 103—Driven Pulley from Pump Body Removal**

**(2) REMOVE BEARING RETAINER.**

**PLIERS**, thin nosed

Remove the bearing retainer from the pump body, using long thin nosed pliers to compress the lock ring.

**(3) REMOVE WATER PUMP BODY COVER PLATE.**

**WRENCH**,  $\frac{3}{8}$ -in.

Remove four cap screws holding the water pump cover plate to the pump body.

**(4) REMOVE IMPELLER AND SHAFT.**

**PRESS**

Place water pump body in press and press impeller and shaft out of body.

**(5) REMOVE SHAFT BEARINGS, SPACER, AND WATER THROWER.**

**PRESS**

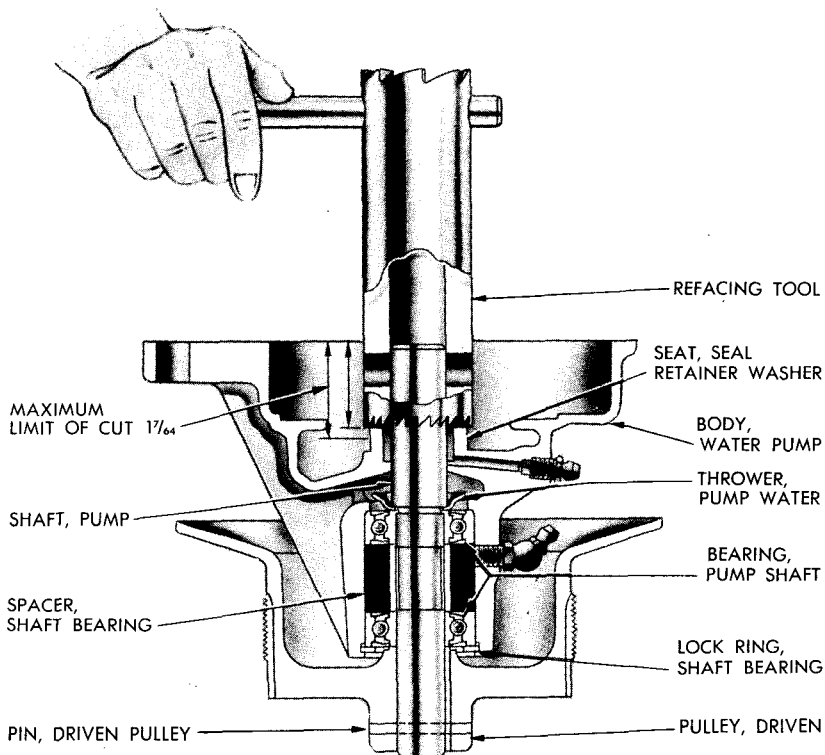
Place pump body on press and, using a suitable arbor, press the two shaft bearings, spacer, and water thrower out of body.

**(6) REMOVE SEAL AND SPRING.**

Press down on the two ears of the seal retainer washer, releasing pressure on lock ring, and remove lock ring and washer (fig. 109). Remove seal and spring from impeller shaft.



**ORDNANCE MAINTENANCE—POWER UNIT ACCESSORIES  
FOR MEDIUM TANKS M3A4 AND M4A4**



RA PD 25250

**Figure 104—Refacing Water Pump Sealing Seat (Multiple Water Pump Type)**

(7) REMOVE IMPELLER FROM SHAFT.

DRIFT

PRESS

HAMMER

If the impeller has to be removed from the shaft, drive out the impeller-to-shaft lock pin (drift and hammer), and press the shaft out of impeller, using press. **CAUTION:** Whenever the impeller is removed from the shaft a new impeller should be used.

**d. Inspection and Repair.**

AIR, compressed

GAGE, feeler

GAGE, plug, 0.5906-in. diameter

GAGE, plug, 1.3776—1.3784-in. diameter

HOSE, air

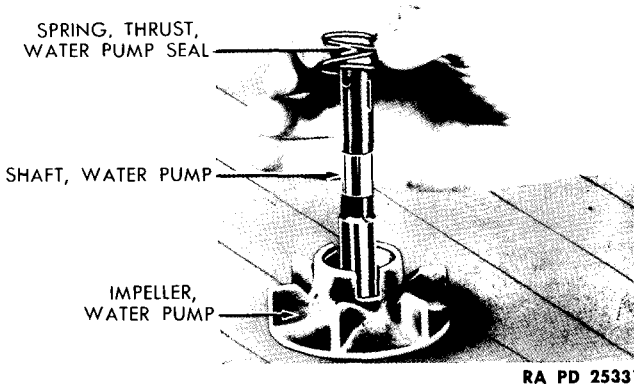
MICROMETER, outside, 1/2-in.

MICROMETER, outside, 1-in.

PLATE, surface

TOOL, refacing

**WATER PUMPS**



**Figure 105—Seal Thrust Spring Installation**

**(1) CLEAN PARTS.**

**WRENCH**, open-end, 3/8-in.

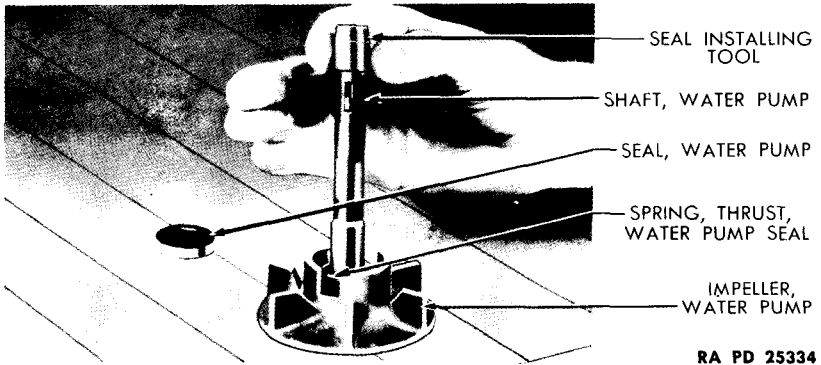
Remove the two lubricating fittings from body. Wash all parts thoroughly in **SOLVENT**, dry-cleaning, to remove all foreign matter and permit of a careful inspection of parts.

**(2) IMPELLER AND SHAFT.**

**GAGE**, feeler

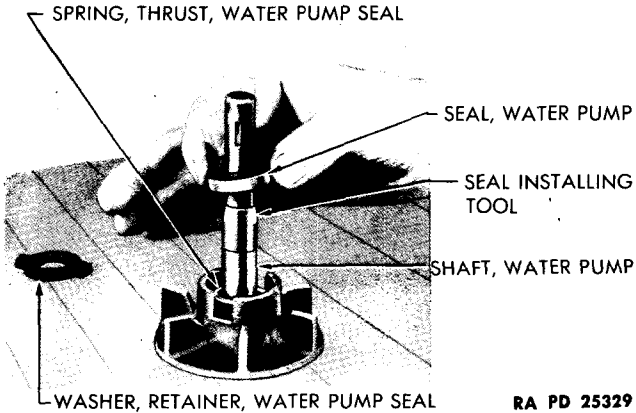
**PLATE**, surface

**MICROMETER**, outside, 1-in.



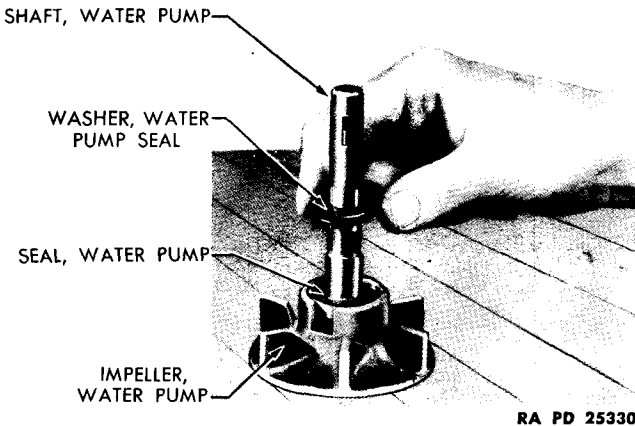
**Figure 106—Seal Installing Tool on Shaft, Preparatory to Installing Seal**

**ORDNANCE MAINTENANCE—POWER UNIT ACCESSORIES  
FOR MEDIUM TANKS M3A4 AND M4A4**



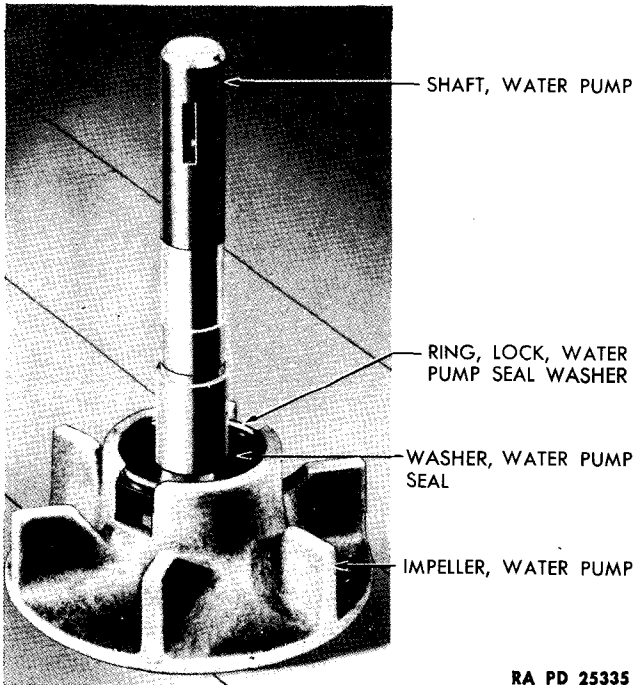
**Figure 107—Installing Seal (with Installing Tool in Position on Shaft to Protect Seal)**

Place impeller on a surface plate, or other flat surface, and check with a 0.005-inch feeler gage in three or more places to be sure that impeller is not warped. If possible to insert the 0.005-inch feeler gage between impeller and surface plate, replace impeller. **NOTE:** A warped impeller will cause interference when installed in pump body. Inspect bearing surfaces on shaft, to be sure they are free from nicks. Using 1-inch outside micrometer, measure bearing surfaces on shaft. These dimensions should be 0.5906—0.5910-inch to insure a good bearing fit.



**Figure 108—Seal Retainer Washer Installation**

**WATER PUMPS**



RA PD 25335

**Figure 109—Seal, Seal Retainer Washer, and Seal Retainer Lock Ring in Position**

**(3) BEARINGS.**

AIR, compressed

MICROMETER, outside,

GAGE, plug, 0.5906-in. diameter

1/2-in.

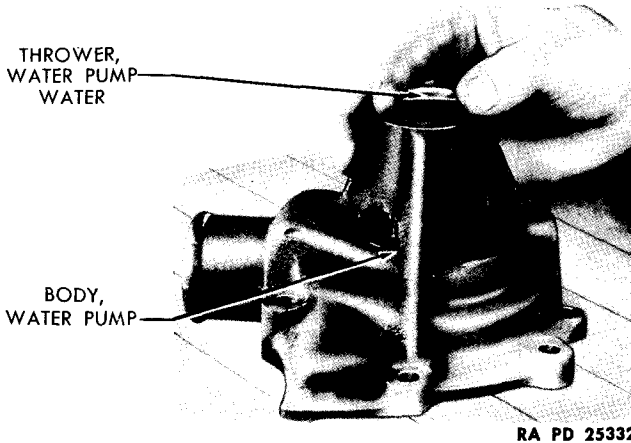
Apply compressed air to bearings, removing all foreign matter. Inspect bearings for roughness or flat spots in balls or races. Using a plug gage, check inside diameter of both bearings. This dimension should be 0.5906 inch. Using 1/2-inch outside micrometer, measure outside diameter of both bearings. This dimension should be 1.3780 inch.

**(4) WATER PUMP BODY.**

GAGE, plug, 1.3776—1.3784-in. diameter

Inspect body carefully for cracks and any indication of leakage. Inspect threaded openings, to be sure threads are not damaged and openings are clear. Inspect all machined surfaces, to be sure they are free from nicks which would prevent a tight gasket seal. Inspect body sealing seat. It must be smooth, flat and free from scratches, to insure a perfect seal. If sealing plate requires refacing, install shaft and bearings in body to serve as a guide for the refacing tool. **CAUTION:** Do not cut the seat

**ORDNANCE MAINTENANCE—POWER UNIT ACCESSORIES  
FOR MEDIUM TANKS M3A4 AND M4A4**



**Figure 110—Water Thrower in Body Installation**

in pump body lower than  $1\frac{7}{16}$  inch below the machined face of the rear of water pump body (fig. 104). It is necessary to maintain this dimension in order to maintain a tension on the sealing washer on the impeller shaft.

**e. Assembly.**

DRIFT

DRILL,  $\frac{1}{8}$ -in.

DRILL, No. 22

DRIVER, bearing

GAGE, feeler

HAMMER, steel

PLIERS, thin nosed

PRESS

PUNCH, center

TOOL, seal installing

WRENCH,  $\frac{3}{8}$ -in.

WRENCH, open-end,  $\frac{3}{8}$ -in.

**(1) INSTALL IMPELLER ON SHAFT.**

DRILL,  $\frac{1}{8}$ -in.

HAMMER, steel

PRESS

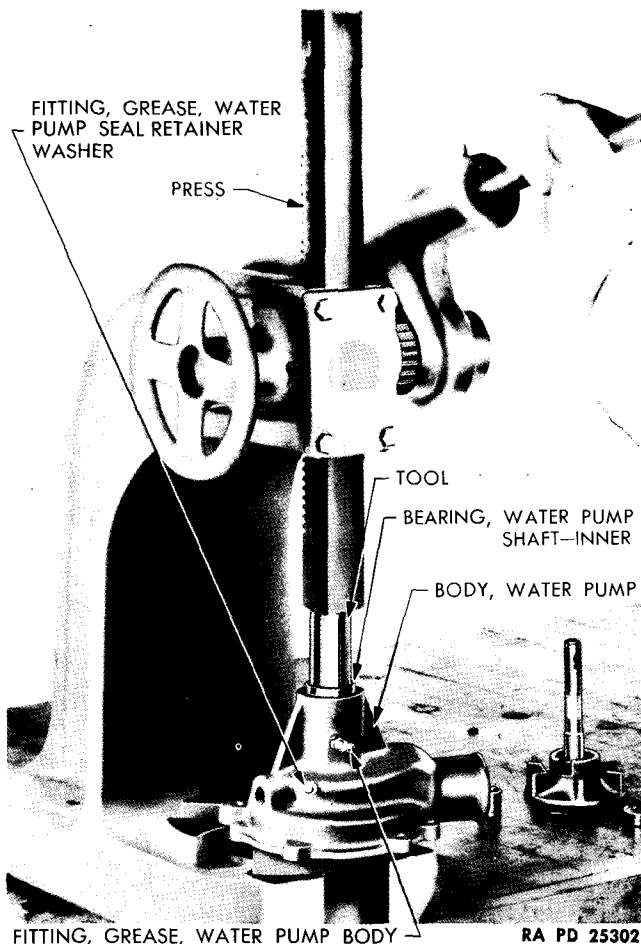
PUNCH, center

If the impeller has been removed from the shaft, a new impeller should be used. Press the impeller on the shaft (end with no keyway) until the back of the impeller and shaft are flush. Locate impeller on shaft (if old shaft is used) so that pin will go through shaft at right angles to old pin. Drill  $\frac{1}{8}$ -inch hole and insert pin through hole and stake locking pin in shaft and impeller (center punch and hammer). Lubricate the impeller end with pump grease.

**(2) INSTALL SEAL ASSEMBLY.**

TOOL, seal installing

## WATER PUMPS



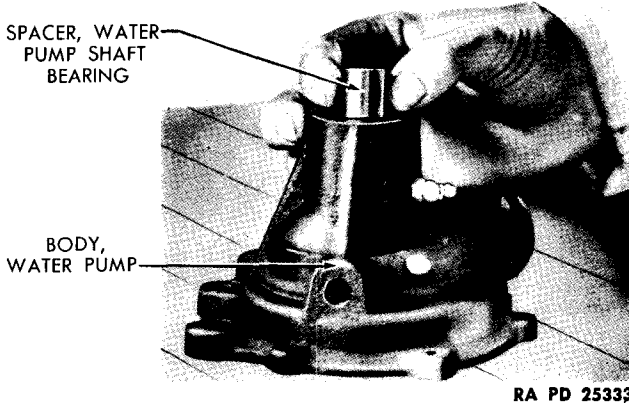
**Figure 111—Pressing Shaft Inner Bearing in Body**

Position spring on shaft (fig. 105). Using seal installing tool (fig. 106) to prevent damaging seal, place seal on shaft (fig. 107). **CAUTION:** The hole in the seal is tapered; the small diameter of this taper goes on shaft first. Remove seal installing tool from shaft.

**(3) INSTALL SEAL RETAINER WASHER AND RETAINER LOCK RING.**

Place retainer on shaft (fig. 108) and press down into position in the impeller against the seal and thrust spring. Work the retainer washer down several times to make sure that seal does not bind on the shaft. Lubricant in the impeller should work up and around shaft to keep seal

**ORDNANCE MAINTENANCE—POWER UNIT ACCESSORIES  
FOR MEDIUM TANKS M3A4 AND M4A4**



**Figure 112—Bearing Spacer Installation**

from binding. Press retainer down by using fingers on ears of washer.  
**NOTE:** Do not use screwdriver or tool to depress washer as damage to the sealing surface would result. With washer depressed, have one man install the lock ring (fig. 109).

**(4) INSTALL WATER THROWER AND INNER BEARING.**

**DRIVER**, bearing

**WRENCH**, open-end,  $\frac{3}{8}$ -in.

**PRESS**

Position water thrower in body, as shown in figure 110. Screw one straight and one angle lubricant fitting into water pump body, as shown in figure 111. Install bearing in body and press into position with driver (fig. 111).

**(5) INSTALL OUTER BEARING.**

**DRIVER**, bearing

**PRESS**

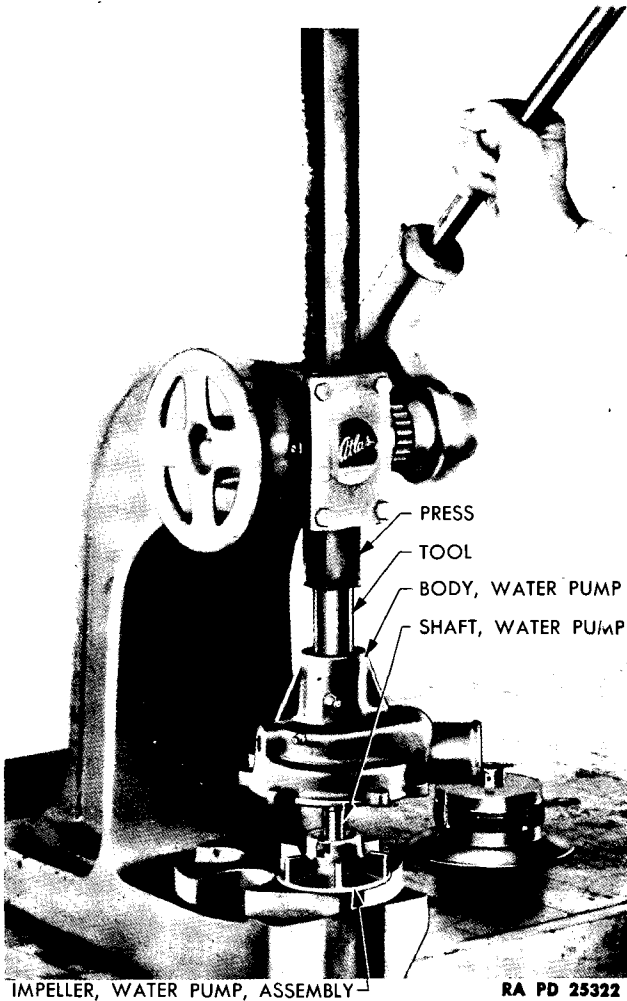
Position spacer in body (fig. 112). Position impeller and shaft in body and place in press ready to assemble spacer and bearing on shaft. Install bearing in body and press into position using driver until groove for lock ring shows above bearing. Lubricate surface of seal retainer washer immediately prior to assembly in pump body. Press impeller and shaft into body (fig. 113). Check to see that shaft is free to turn when in place.

**(6) INSTALLING BEARING RETAINER.**

**GAGE**, feeler

**PLIERS**, thin nosed

WATER PUMPS



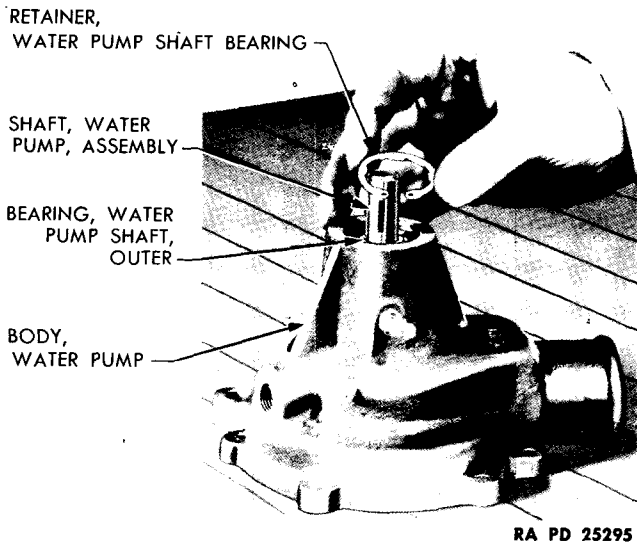
**Figure 113—Pressing Body (with Bearings and Spacer Installed) on Shaft and Impeller**

Install bearing retainer, using pliers to compress the lock ring. With ring in position, there should be 0.004—0.008-inch end play in the bearing assembly. There are three sizes of retainers which are as follows:

Thin	.....	0.0625 in.
Medium	.....	0.068 in.
Thick	.....	0.075 in.



**ORDNANCE MAINTENANCE—POWER UNIT ACCESSORIES  
FOR MEDIUM TANKS M3A4 AND M4A4**



**Figure 114—Bearing Retainer Installation**

**(7) INSTALL DRIVEN PULLEY.**

**DRIFT**

**PRESS**

**DRILL, No. 22**

**PUNCH, center**

**HAMMER, steel**

Place new key in keyway in shaft, use new pulley as this pulley is a press fit and an old pulley would be loose on shaft, place in press (fig. 115) and press into position until it rests solidly against bearing. Using a No. 22 drill, and with the hole in one side of pulley as a guide, drill hole through shaft and other side of pulley. Install new pin (hammer and drift) and upset ends of pin with center punch.

**(8) INSTALL WATER PUMP BODY PLATE AND GASKET (on Water Pumps 2, 3, 4, and 5 only).**

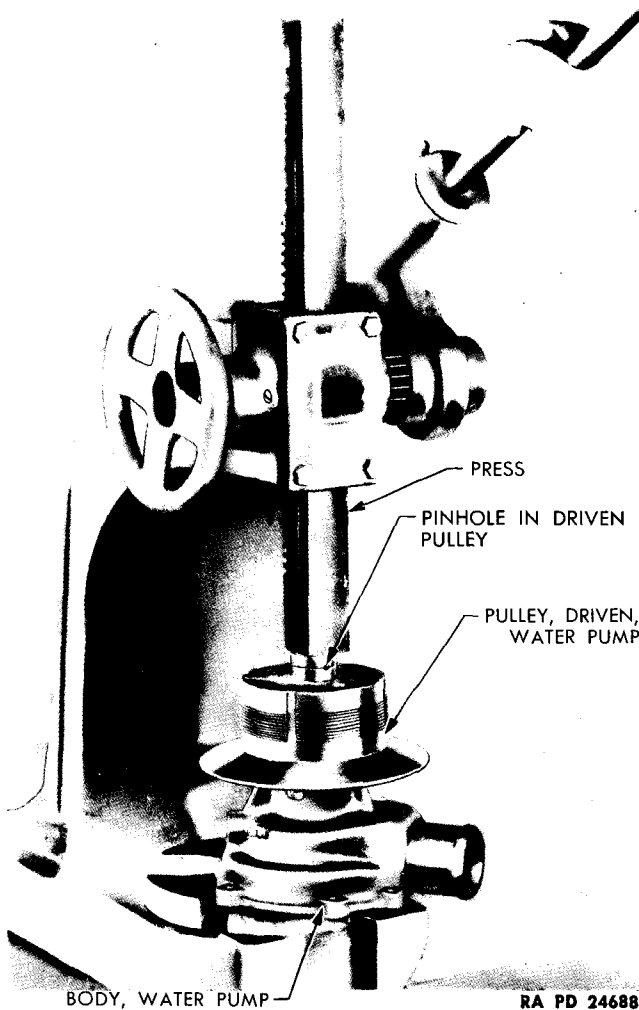
**WRENCH, 3/8-in.**

Install new gasket and attach plate to water pump body with four cap screws, tightening cap screws securely. Lubricate water pump with GREASE, general purpose. If pump is to be stored, plug water inlet and outlet openings to exclude all foreign matter, which might damage pump when placed in operation.

**f. Installation.**

(1) Refer to TM 9-754, January 21, 1943 (par. 84 e) for installation procedure.

**WATER PUMPS**



**Figure 115—Pressing Driven Pulley on Shaft**

**55. SINGLE WATER PUMP TYPE.**

a. **Description** (figs. 116, 117, 118, 119, and 120).

(1) A single water pump, mounted on the distributor end of the crankcase and driven by the accessory drive shaft, furnishes water to each of the five individual engines. It is of the centrifugal type. Water enters the pump through two tubes, one from the right side and the

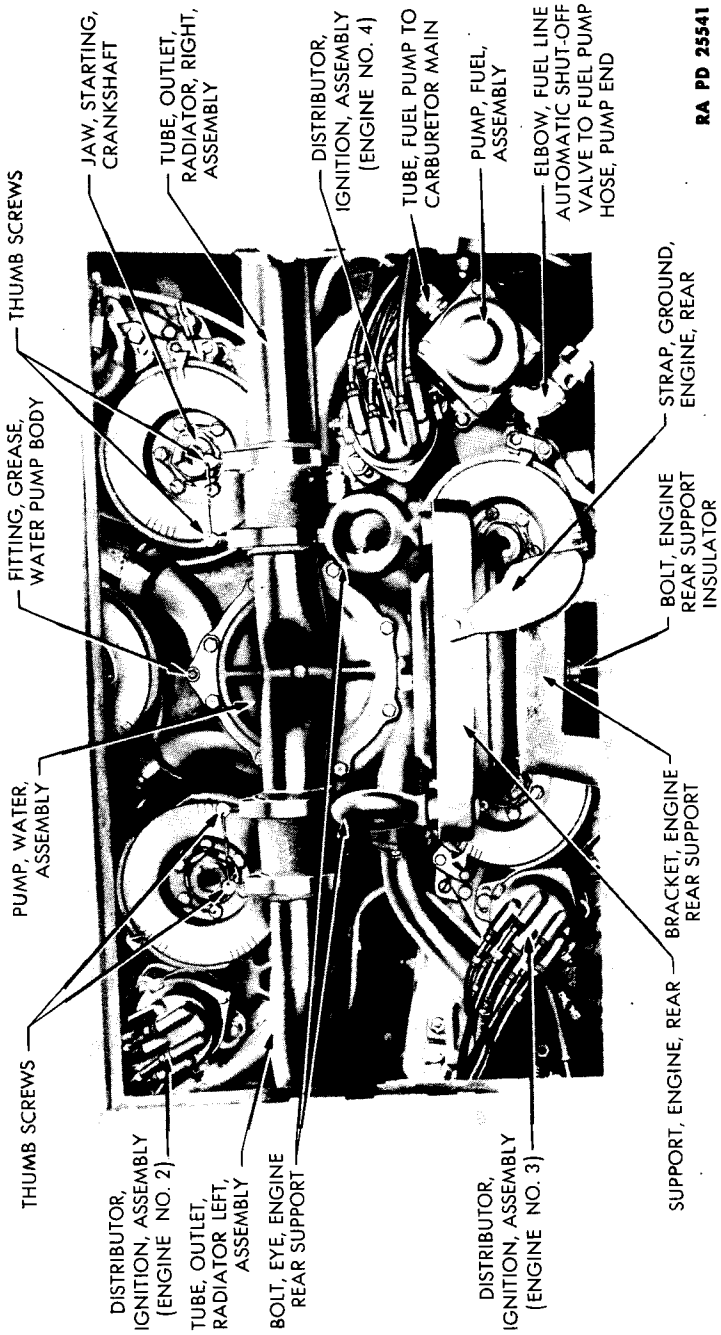
ORDNANCE MAINTENANCE—POWER UNIT ACCESSORIES  
FOR MEDIUM TANKS M3A4 AND M4A4



RA PD 25546

Figure 116—Inlet and Outlet Tubes of Single Water Pump

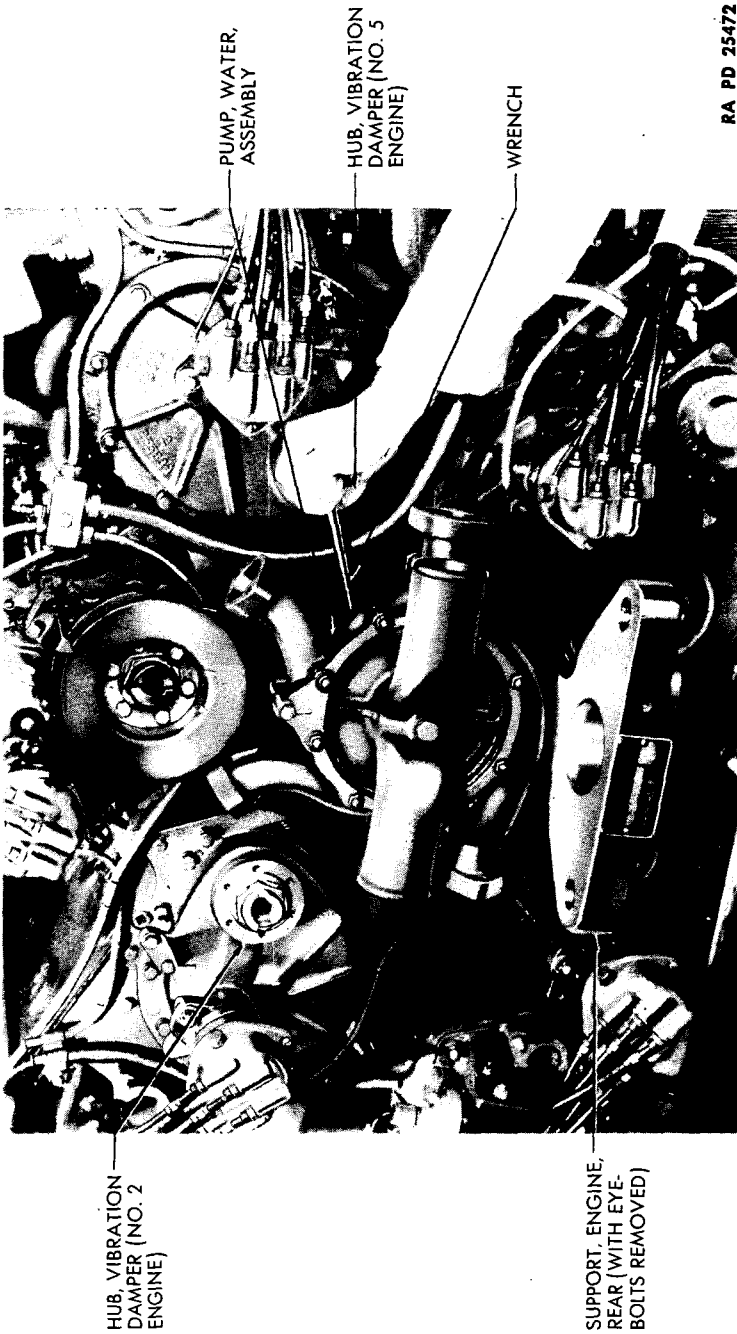
WATER PUMPS



RA PD 25541

Figure 117—Single Type Water Pump

ORDNANCE MAINTENANCE—POWER UNIT ACCESSORIES  
FOR MEDIUM TANKS M3A4 AND M4A4

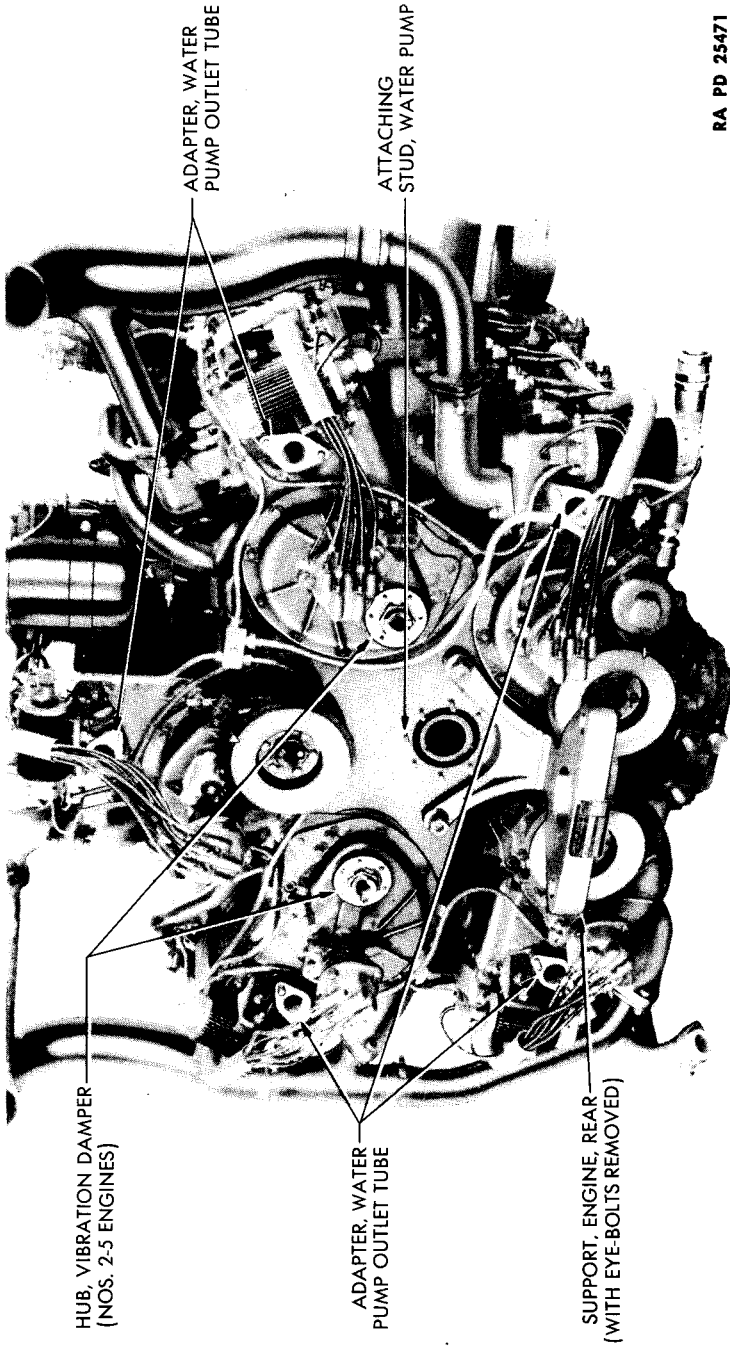


RA PD 25472

Figure 118—Impulse Neutralizers Removed from Engines Nos. 2 and 5, Preparatory to Removal of Single Water Pump

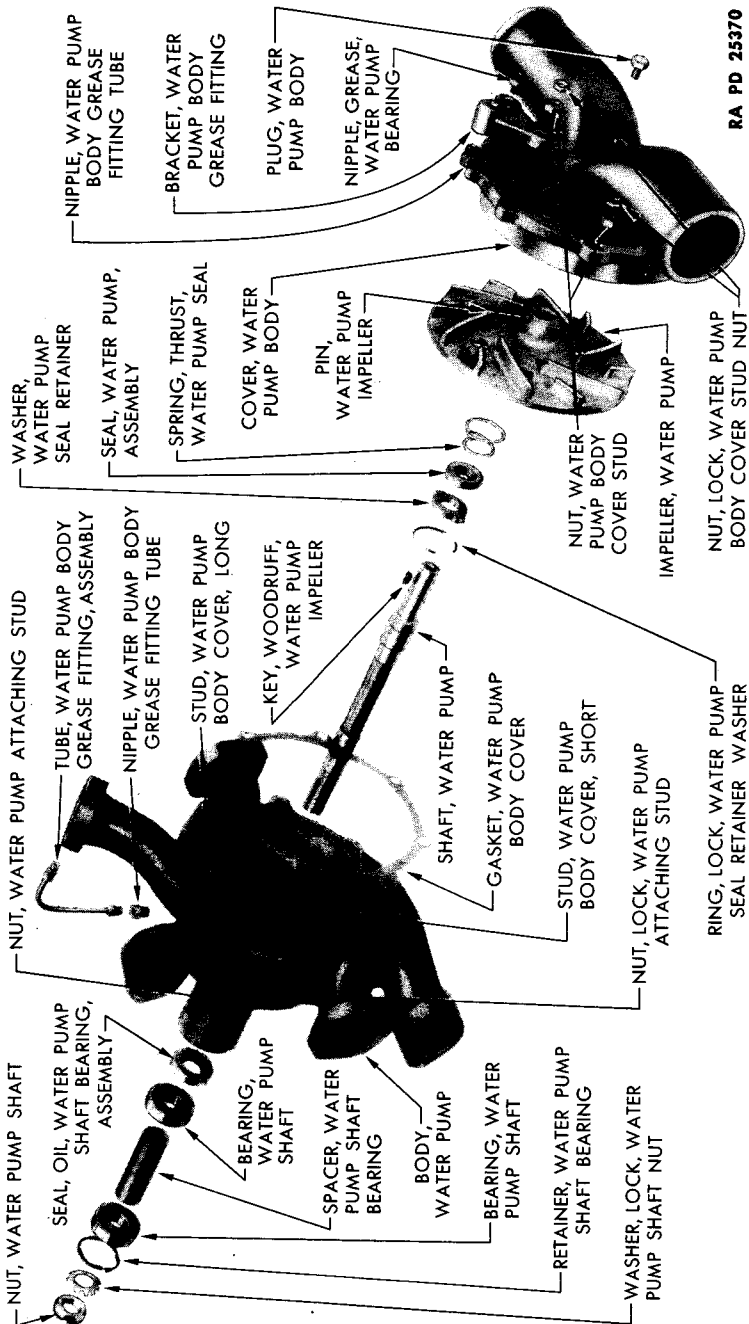
**WATER PUMPS**

RA PD 25471



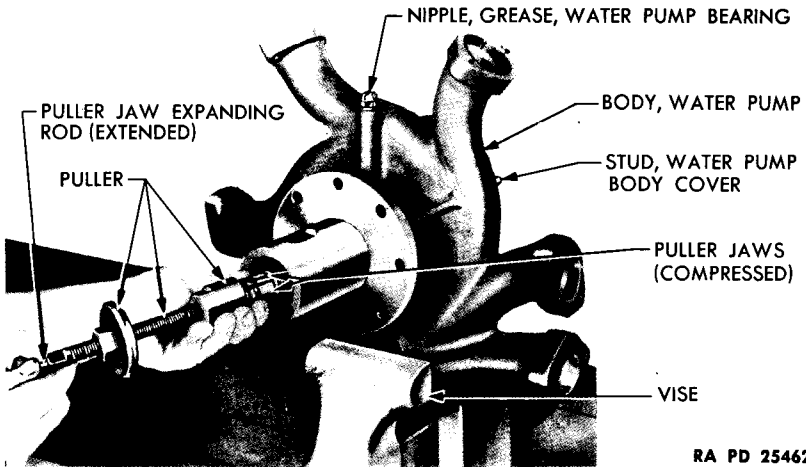
**Figure 119—Distributor End of Power Unit with Single Water Pump Removed**

**ORDNANCE MAINTENANCE—POWER UNIT ACCESSORIES  
FOR MEDIUM TANKS M3A4 AND M4A4**



**Figure 120—Parts of Single Type Water Pump**

## WATER PUMPS



RA PD 25462

**Figure 121—Locating Puller Preparatory to Insertion in Oil Seal**

other from the left side, being discharged from the pump directly to the cylinder blocks of the five individual engines through individual tubes.

**b. Removal.**

(1) Refer to TM 9-754, January 21, 1943 (par. 85 c) for removal procedure.

**c. Disassembly.**

DRIFT, brass

HAMMER, soft head

HAMMER, steel

PLIERS, thin nosed

PRESS

PULLER, oil seal, No.

C-625-75

PUNCH, pin,  $\frac{1}{8}$ -in.

(1) REMOVE COVER.

WRENCH, open-end,  $\frac{3}{8}$ -in.

WRENCH, open-end,  $\frac{1}{2}$ -in.

SCREWDRIVER

WRENCH, open-end,  $\frac{1}{4}$ -in.

WRENCH, open-end,  $\frac{3}{8}$ -in.

WRENCH, open-end,  $\frac{1}{2}$ -in.

WRENCH, open-end,  $\frac{7}{8}$ -in.

WRENCH, socket,  $\frac{1}{2}$ -in.

WRENCH, spanner,

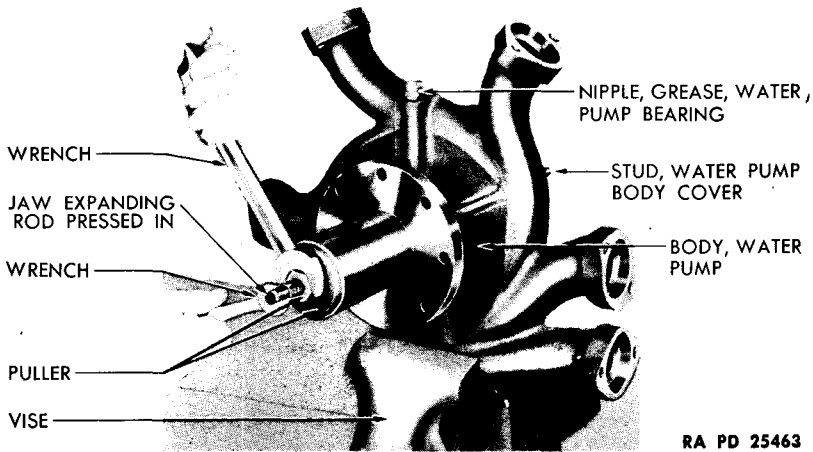
MTM-A4-53

WRENCH, socket,  $\frac{1}{2}$ -in.

Remove the eight lock nuts from studs holding pump cover to pump body ( $\frac{1}{2}$ -in. open-end wrench). Remove the eight stud nuts ( $\frac{1}{2}$ -in. socket wrench) and remove the cover from the eight mounting studs in the water pump body. When removing cover, remove grease fitting bracket, mounted to cover (on vehicles so equipped) and with  $\frac{3}{8}$ -inch open-end wrench, disconnect the grease fitting assembly (fig. 122).



**ORDNANCE MAINTENANCE—POWER UNIT ACCESSORIES  
FOR MEDIUM TANKS M3A4 AND M4A4**



**Figure 122—Pulling Oil Seal**

Remove grease fitting from water pump body (on pumps so equipped) ( $\frac{3}{8}$ -in. open-end wrench).

**(2) REMOVE WATER PUMP SHAFT NUT AND LOCK WASHER.**

**HAMMER**, steel  
**PUNCH**, pin,  $\frac{1}{8}$ -in.  
**SCREWDRIVER**

**WRENCH**, spanner,  
**MTM-A4-53**

Using a  $\frac{1}{8}$ -inch pin punch, bend the ears of the lock washer down. Remove nut with spanner wrench, MTM-A4-53 and remove lock washer from shaft (fig. 141). To hold shaft from turning, insert a screwdriver in the slot at the impeller end of the shaft.

**(3) REMOVE BEARING RETAINER.**

**PLIERS**, thin nosed

Insert the ends of thin nosed pliers into the holes in the ends of the bearing retainer. Compress the pliers which will reduce the outside diameter of the retainer so that it can be removed from the body (fig. 143).

**(4) REMOVE IMPELLER AND SHAFT.**

**DRIFT**, brass

**HAMMER**, soft head

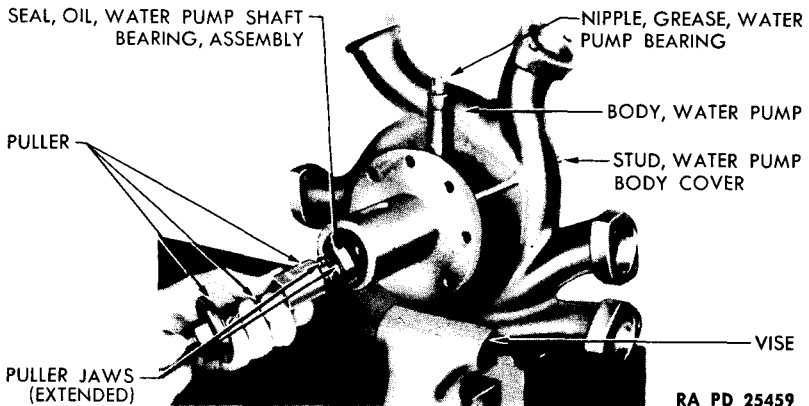
With a soft head hammer and brass drift, drive out the impeller and shaft assembly from the pump body.

**(5) REMOVE BEARINGS AND SPACER FROM BODY.**

**DRIFT**, brass

If bearings stick in pump body, drive out with a soft metal drift or a block of hard wood.

**WATER PUMPS**



**Figure 123—Oil Seal Removed from Body**

**(6) REMOVE OIL SEAL ASSEMBLY.**

**PULLER**, oil seal, No. C625-75      **WRENCH**, open-end,  $\frac{7}{8}$ -in.  
**WRENCH**, open-end,  $\frac{1}{4}$ -in.

Using oil seal puller No. C625-75, compress the jaws of the puller and insert puller into the oil seal (fig. 121). When the jaws of the puller are through the oil seal, press down on the jaw expanding rod which extends out of the shaft (fig. 121). This will expand the jaws in the seal and not damage the seal. Using a  $\frac{7}{8}$ -inch open-end wrench on the puller nut (fig. 122) and holding the shaft with a  $\frac{1}{4}$ -inch open-end wrench, remove the oil seal (fig. 123). Depress the jaws of the seal puller and remove the seal from the puller.

**(7) REMOVE LOCK RING FROM IMPELLER.**

With the impeller and shaft on a bench, shaft up, press down on the two ears of the retainer washer with your fingers, and remove the retainer washer lock ring from the impeller. **CAUTION:** Do not use screwdriver or punch to press the seal retainer washer out (fig. 133).

**(8) REMOVE SHAFT FROM IMPELLER.**

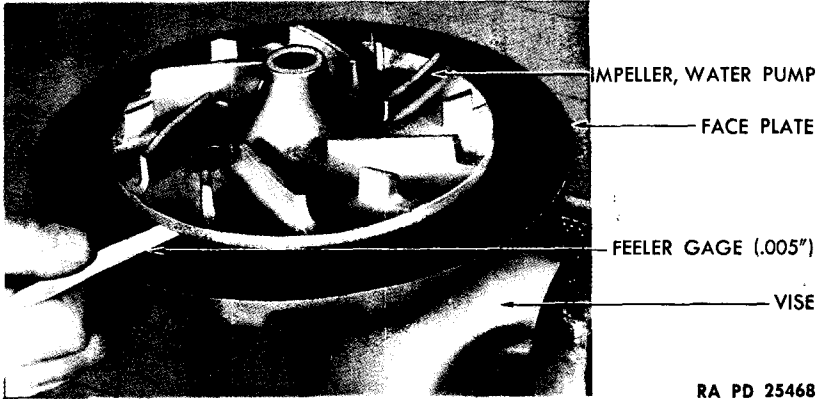
**HAMMER**, steel      **PUNCH**, pin,  $\frac{1}{8}$ -in.  
**PRESS**

With pin punch and hammer, drive out the impeller to shaft pin (fig. 132). Using an arbor press, press the shaft from the impeller, being careful not to damage the seal retainer washer.

**(9) REMOVE SEAL AND RETAINER WASHER.**

Remove key from water pump shaft. Remove water pump seal thrust spring from shaft. Remove seal assembly and retainer washer from impeller.

**ORDNANCE MAINTENANCE—POWER UNIT ACCESSORIES  
FOR MEDIUM TANKS M3A4 AND M4A4**



RA PD 25468

**Figure 124—Checking Impeller for Warpage**

**d. Inspection and Repair.**

GAGE, feeler

GAGE, plug, 0.789—  
0.794-in. diameter

GAGE, plug, 1.623—  
1.625-in. diameter

GAGE, plug, 1.8503—  
1.8513-in. diameter

HOSE, air

MICROMETER, outside  
3/4-in.

MICROMETER, outside, 1-in.

PLATE, surface

**(1) CLEAN PARTS.**

Wash all parts thoroughly in SOLVENT, dry-cleaning, to remove all foreign matter, thus permitting a close inspection of all parts.

**(2) IMPELLER AND SHAFT.**

GAGE, feeler

PLATE, surface

MICROMETER, outside, 1-in.

Before installing the impeller, place it on a surface plate, or some flat surface, and check with 0.005-inch feeler gage to be sure that the impeller is not warped. If possible to insert the 0.005-inch feeler gage between impeller and surface plate, replace impeller. **NOTE:** A warped impeller would rub the pump housing when installed. Using a 1-inch outside micrometer, inspect bearing surfaces on shaft. This dimension should be 0.7872—0.7876 inch.

**(3) BEARINGS.**

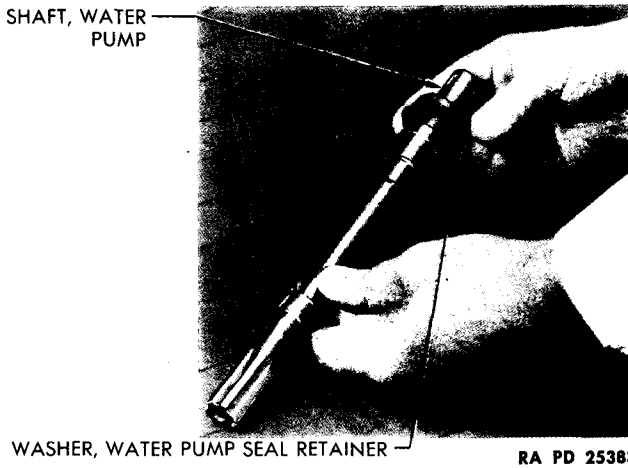
GAGE, plug, 0.789—  
0.794-in. diameter

MICROMETER, outside,  
3/4-in.

HOSE, air

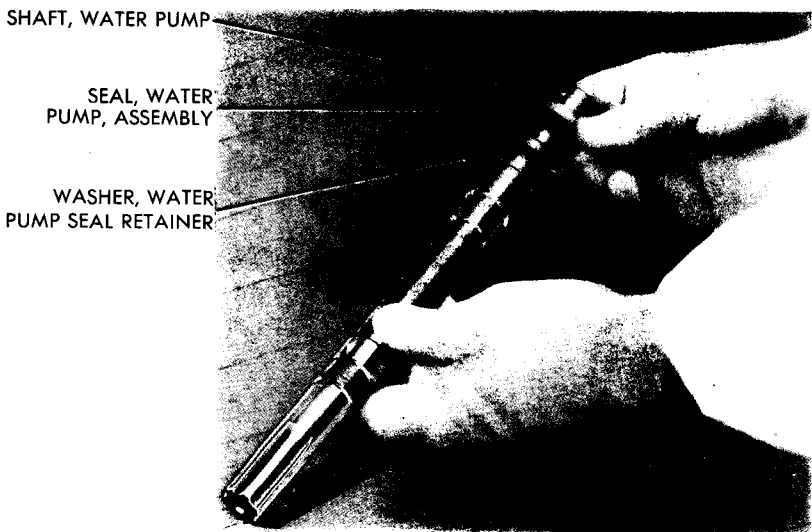
Apply compressed air to bearings, removing all foreign matter from

**WATER PUMPS**



**Figure 125—Retainer Washer on Shaft Installation**

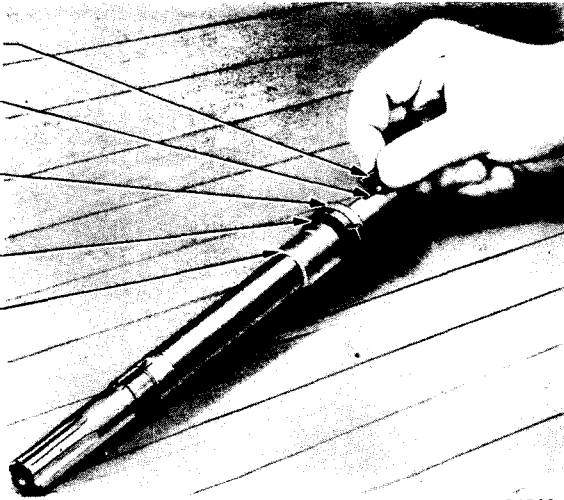
bearings. Inspect bearings for roughness and wear in bearing races and balls. Using  $\frac{3}{4}$ -inch outside micrometer, measure length of bearing spacer. This dimension should be 3.497—3.502 inches. Using a plug gage, measure the inside diameter of spacer, which should be 0.789—0.794 inch.



**Figure 126—Seal Assembly Installation**

**ORDNANCE MAINTENANCE—POWER UNIT ACCESSORIES  
FOR MEDIUM TANKS M3A4 AND M4A4**

- KEY,  
WATER PUMP IMPELLER
- KEYWAY IN SHAFT
- SEAL, WATER PUMP,  
ASSEMBLY
- WASHER, WATER  
PUMP SEAL RETAINER
- SHAFT, WATER PUMP



RA PD 24566

**Figure 127—Key on Shaft Installation**

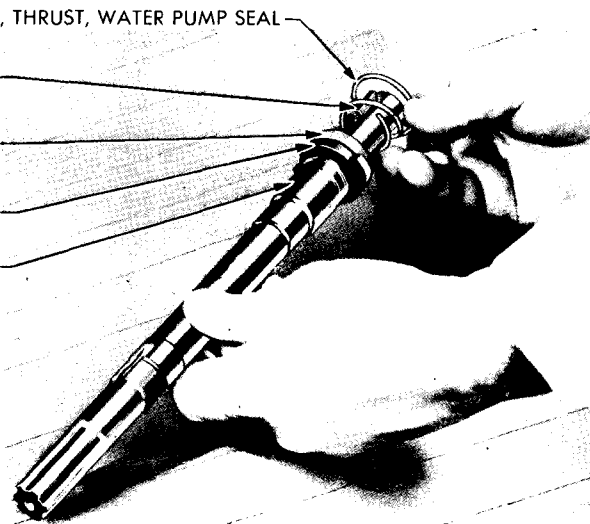
**(4) WATER PUMP BODY.**

GAGE, plug, 1.623—  
1.625-in. diameter

GAGE, plug, 1.8503—  
1.8513-in. diameter

Inspect water pump body carefully for any cracks or evidence of leaking. Inspect all threaded openings for damage to threads. Using plug

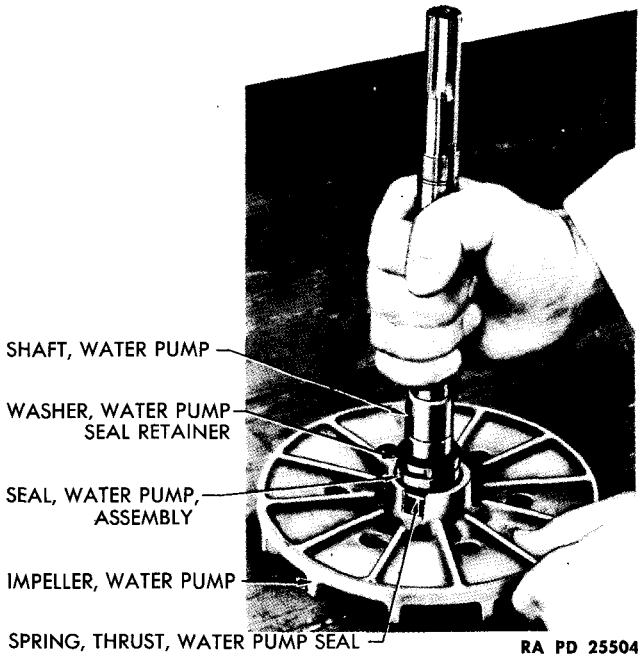
- SPRING, THRUST, WATER PUMP SEAL
- KEY, WATER PUMP  
IMPELLER
- SEAL, WATER PUMP,  
ASSEMBLY
- WASHER, WATER  
PUMP SEAL RETAINER
- SHAFT, WATER PUMP



RA PD 25376

**Figure 128—Pump Seal Spring on Shaft Installation**

## WATER PUMPS



RA PD 25504

**Figure 129—Shaft Inserted in Hub of Impeller**

gage, check openings in body to receive bearings. Both of these dimensions should be 1.8503—1.8513 inches. Using plug gage, check opening in body to receive oil seal. This dimension should be 1.623—1.625 inches. Inspect the pump body sealing seat for scores or scratches. This seat must be smooth, to insure a tight seal. If seat is rough or scratched, it should be refaced. **CAUTION:** When refacing this seat, do not cut the seat in body lower than  $1\frac{27}{32}$  inches below the machined face of the rear of the pump body, as it is necessary to maintain this dimension in order to maintain a tension on the sealing washer on the impeller shaft.

**e. Assembly.**

DRILL,  $\frac{5}{32}$ -in.

DRIVER, oil seal, tool

No. MTM-A4-36

GAGE, impeller setting, tool

No. MTM-A4-54

HAMMER, steel

PLIERS, thin nosed

PRESS

PUNCH, center

PUNCH, pin,  $\frac{1}{8}$ -in.

SCREWDRIVER

WISE, bench

WRENCH, open-end,  $\frac{3}{8}$ -in.

WRENCH, open-end,  $\frac{1}{2}$ -in.

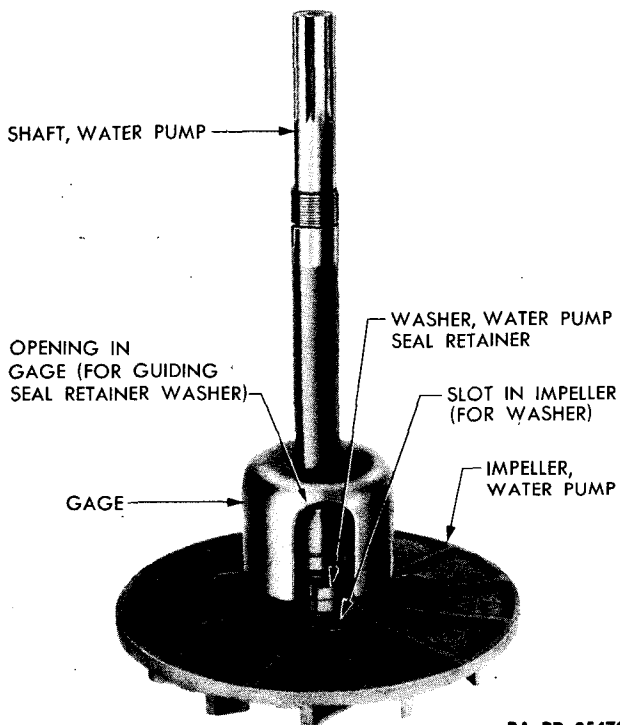
WRENCH, socket,  $\frac{1}{2}$ -in.

WRENCH, spanner,

No. MTM-A4-53

WRENCH, torque

**ORDNANCE MAINTENANCE—POWER UNIT ACCESSORIES  
FOR MEDIUM TANKS M3A4 AND M4A4**



RA PD 25470

**Figure 130—Assembling Gage in Position on Shaft**

**(1) INSTALL WASHER, SEAL, KEY AND SPRING ON SHAFT.**

Place retainer washer on shaft (keyway end) and slide until against shoulder on shaft (fig. 125). Position new seal assembly (fig. 126). **CAUTION:** The hole in the seal is tapered; the large diameter of this taper goes onto shaft first. Place key in keyway (fig. 127) and slide spring into position on shaft (fig. 128).

**(2) INSTALL SHAFT IN IMPELLER.**

**DRILL**,  $\frac{5}{32}$ -in.

**GAGE**, impeller setting, tool

No. MTM-A4-54

**HAMMER**, steel

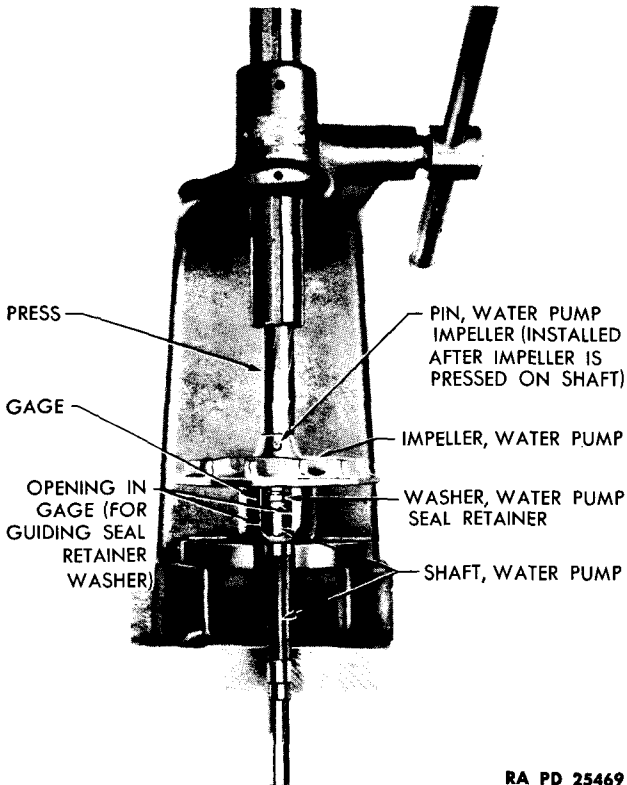
**PRESS**

**PUNCH**, center

Insert end of shaft in hub of impeller (fig. 129). Place gage MTM-A4-54 over shaft (fig. 130) and place assembly on press (fig. 131).

Pack water pump grease in hub of impeller and press impeller on shaft until it contacts gage. **CAUTION:** Watch the seal retainer washer through opening in gage, while pressing impeller on shaft, to be sure it

## WATER PUMPS



RA PD 25469

**Figure 131—Pressing Impeller on Shaft, Using Gage for Proper Location**

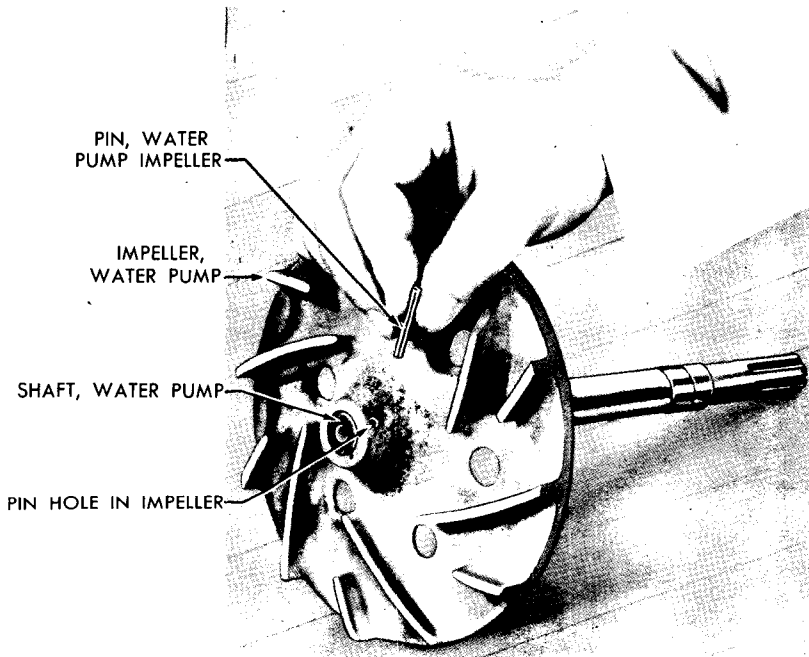
is free on shaft (fig. 131). When impeller is in proper position on shaft it must be located so that distance from shoulder on shaft (which gage contacts) to face of impeller is 1.700—1.705 inches, to avoid any interference between impeller and pump body. Using  $\frac{5}{32}$ -inch drill, and using the hole in one side of impeller hub as a guide, drill hole through shaft and opposite side of hub. Countersink holes  $\frac{3}{16}$  inch x 90 degrees, drive pin through hole and upset with center punch and hammer (fig. 132).

(3) **INSTALL RETAINER WASHER LOCK RING.**

(a) With the impeller and shaft on a bench, shaft up, press down on the two ears of the seal retaining washer with fingers and have helper install the lock ring in the impeller. **CAUTION:** Do not use a screwdriver or punch to depress the sealing washer as damage to the sealing surface would result (fig. 133).



**ORDNANCE MAINTENANCE—POWER UNIT ACCESSORIES  
FOR MEDIUM TANKS M3A4 AND M4A4**



RA PD 25391

**Figure 132—Impeller Pin Installation**

(b) Work the retainer washer down against the thrust spring a number of times to make sure that the seal does not bind on the shaft. Lubricant in the impeller should work up around shaft to keep the seal from binding.

**(4) INSTALL OIL SEAL ASSEMBLY INTO WATER PUMP BODY.**

**DRIVER**, oil seal, tool No.

**WISE**, bench

**MTM-A4-36**

**WRENCH**, open-end,  $\frac{3}{8}$ -in.

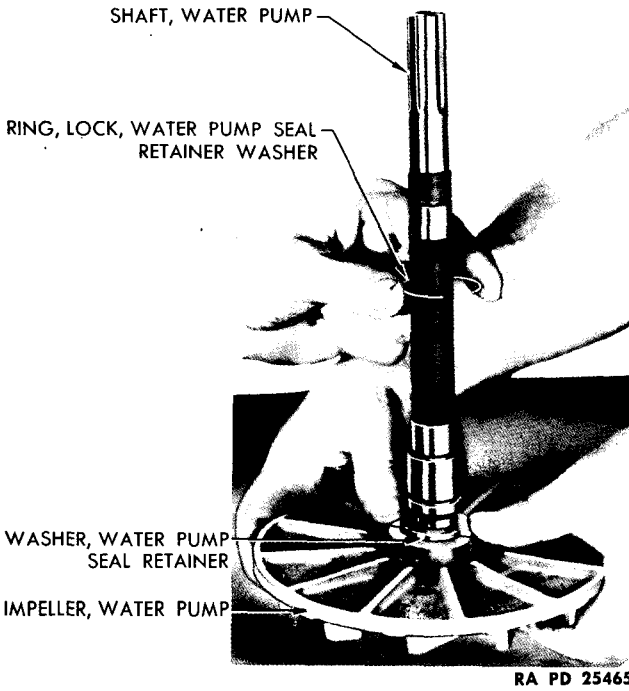
**HAMMER**, steel

Screw grease fitting into opening in top of pump body (fig. 135). Place water pump body in bench vise and install oil seal into body (fig. 134), using oil seal driver, tool No. MTM-A4-36 and hammer (figs. 135 and 136).

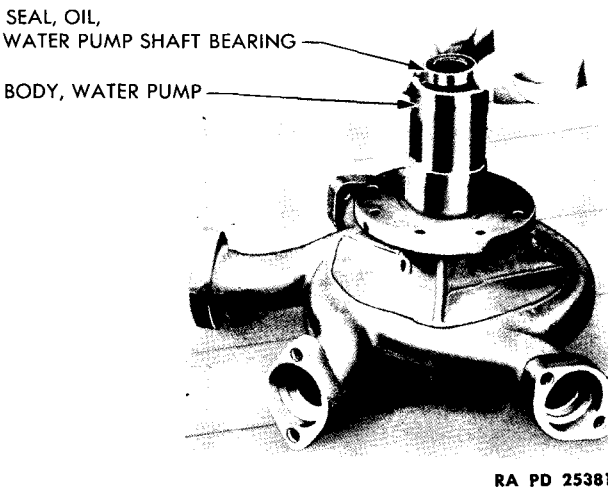
**(5) INSTALL IMPELLER AND SHAFT INTO BODY.**

Lubricate the impeller shaft with water pump grease where it goes through the oil seal and place the impeller and shaft into the pump body. Check to see that it is free to turn when in place (fig. 137).

**WATER PUMPS**

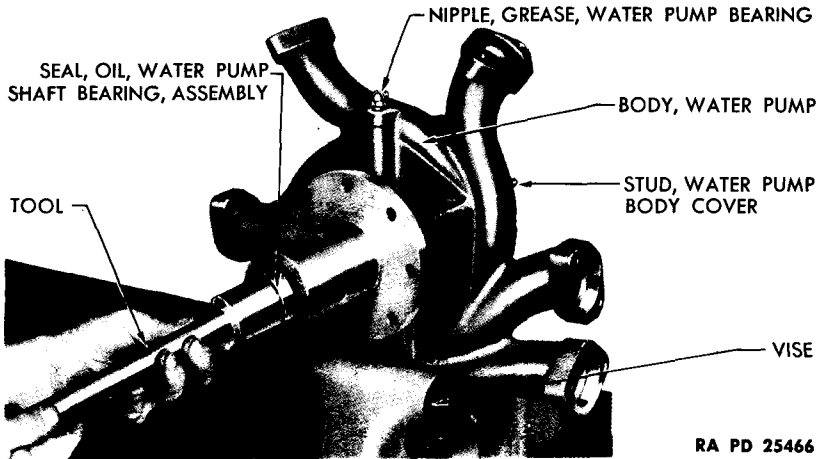


**Figure 133—Retainer Washer Lock Ring Installation**



**Figure 134—Placing Oil Seal in Position to Install**

**ORDNANCE MAINTENANCE—POWER UNIT ACCESSORIES  
FOR MEDIUM TANKS M3A4 AND M4A4**

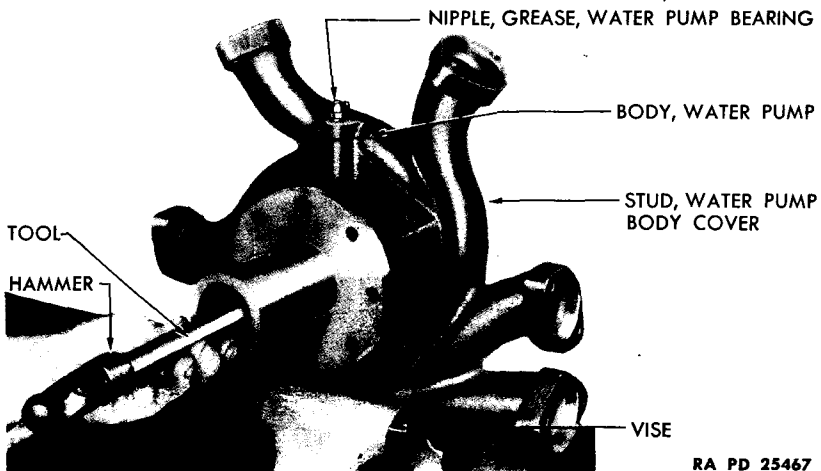


**Figure 135—Oil Seal in Pump Body Installation**

(6) INSTALL INNER BEARING INTO BODY.

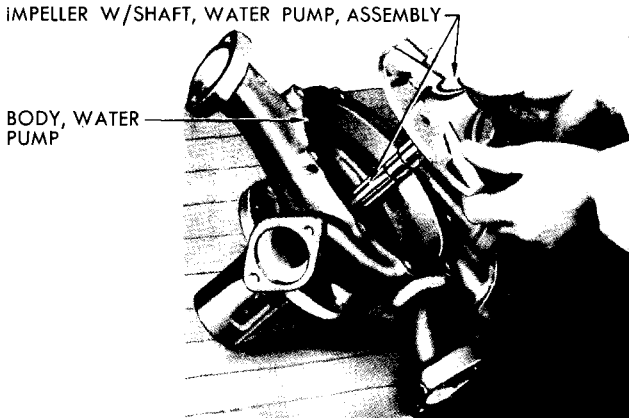
**PRESS**

Place the pump on arbor press with impeller down and resting on a block, so that pump body is free to turn. Place inner bearing on upper end of the pump shaft (fig. 138) and press down using the spacer as an arbor. **CAUTION:** While pressing bearing into the pump body, keep



**Figure 136—Oil Seal in Pump Body Installation**

**WATER PUMPS**



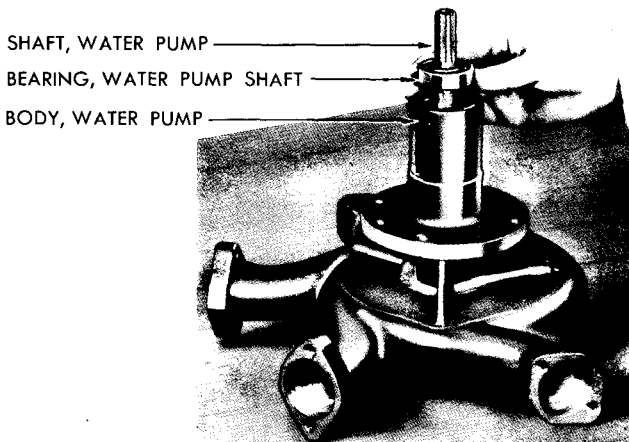
RA PD 25378

**Figure 137—Shaft and Impeller in Pump Body Installation**

turning the body of the pump which will turn the bearing and keep from damaging the bearing. Also see that the threads on the shaft are not damaged.

**(7) INSTALL SPACER AND OUTER BEARING IN BODY.  
PRESS**

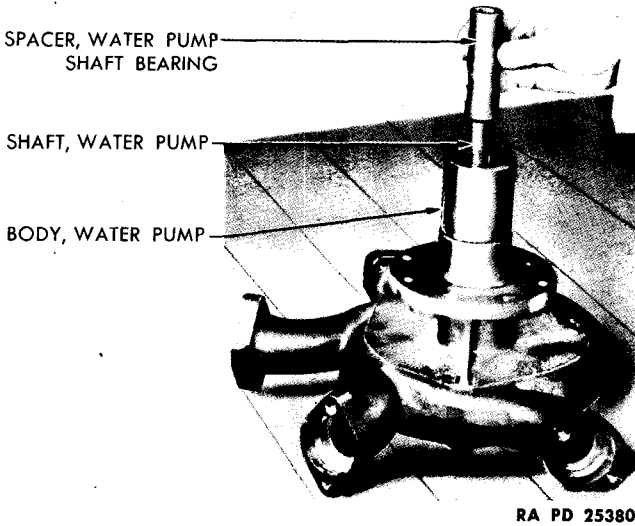
Install the spacer and outer bearing and press into the pump body so that the lock ring groove shows above the bearing (fig. 139).



RA PD 25379

**Figure 138—Inner Bearing in Pump Body Installation**

**ORDNANCE MAINTENANCE—POWER UNIT ACCESSORIES  
FOR MEDIUM TANKS M3A4 AND M4A4**



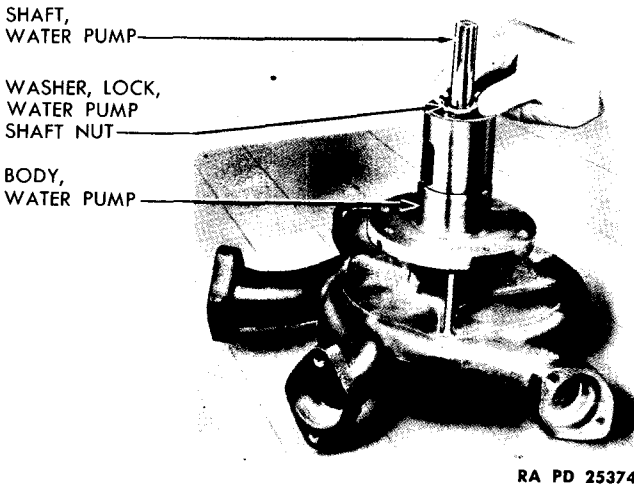
**Figure 139—Bearing Spacer in Body Installation**

(8) INSTALL NUT LOCK WASHER AND NUT.

HAMMER, steel  
PUNCH, pin, 1/8-in.

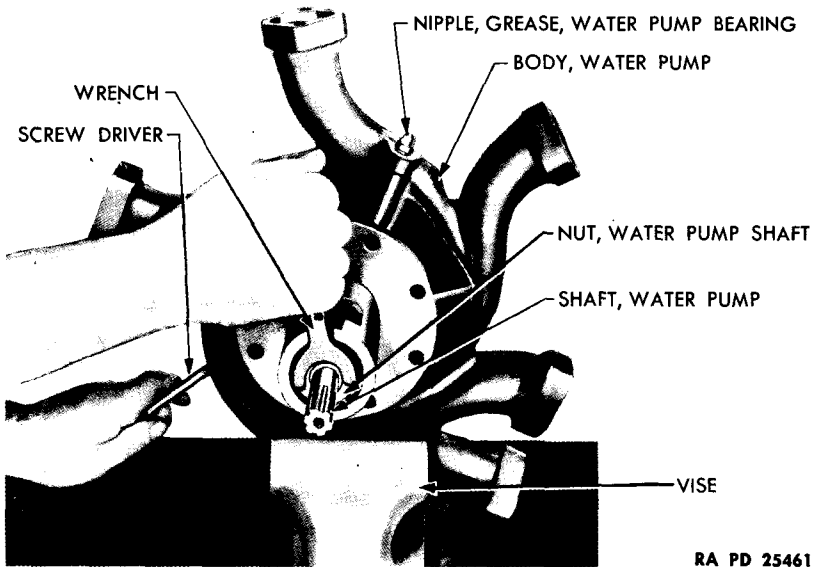
SCREWDRIVER  
WRENCH, spanner, No.  
MTM-A4-53

Install nut lock washer (fig. 140) and nut, and with spanner wrench No. MTM-A4-53, tighten nut (fig. 141). Turn up ears of nut lock



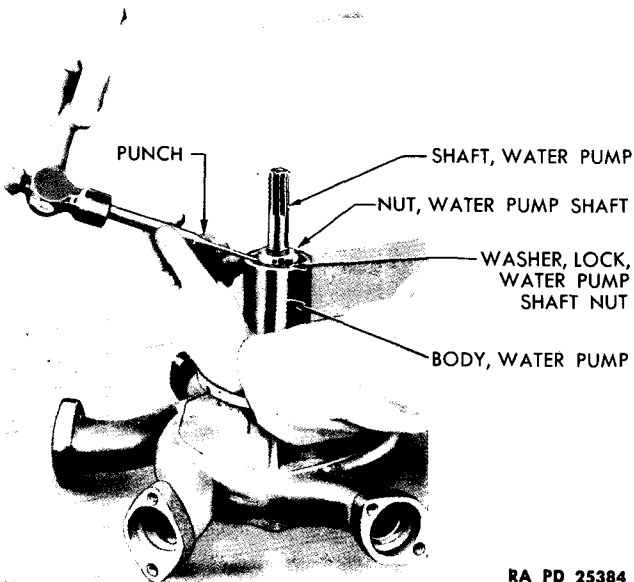
**Figure 140—Pump Shaft Nut Lock Installation**

WATER PUMPS



RA PD 25461

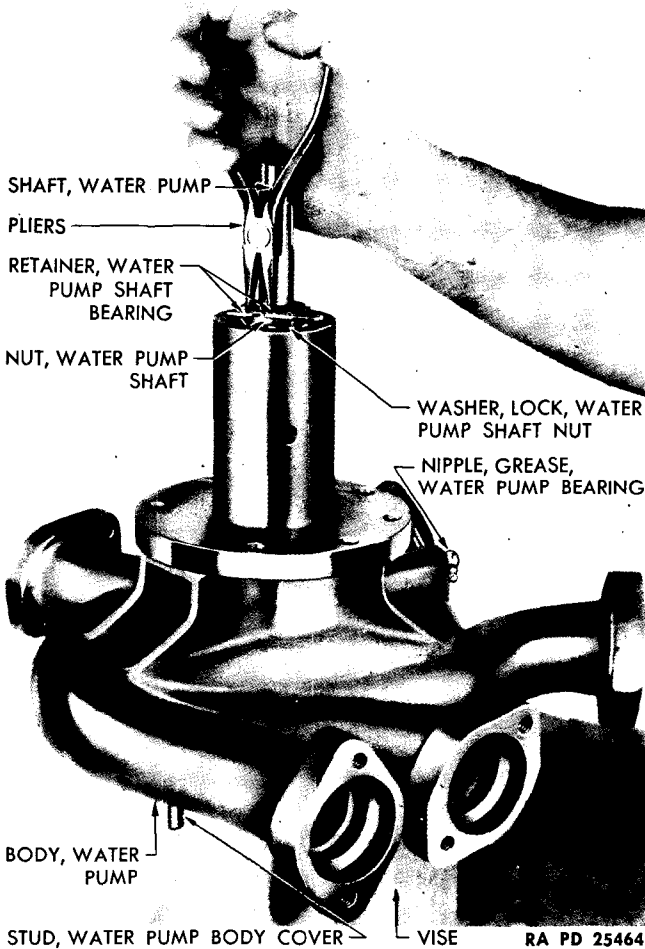
**Figure 141—Tightening Pump Shaft Nut**



RA PD 25384

**Figure 142—Bending Ears of Lock Washer to Secure Nut**

**ORDNANCE MAINTENANCE—POWER UNIT ACCESSORIES  
FOR MEDIUM TANKS M3A4 AND M4A4**



**Figure 143—Bearing Retainer Installation**

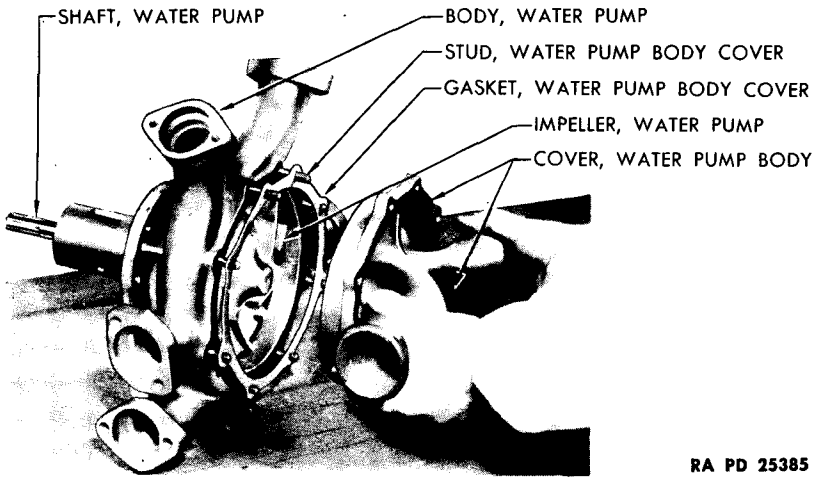
washer using  $\frac{1}{8}$ -inch pin punch and hammer (fig. 142). If necessary use screwdriver in impeller end of shaft to keep from turning.

**(9) INSTALL BEARING RETAINER.**

Install bearing retainer into body by compressing ring with thin nosed pliers (fig. 143). With retainer in position, there should be 0.004—0.008-inch end play in the bearing assembly. There are three sizes of retainers which are as follows:

Thin .....	0.0625 in.
Medium .....	0.068 in.
Thick .....	0.075 in.

**WATER PUMPS**



RA PD 25385

**Figure 144—Pump Cover Installation**

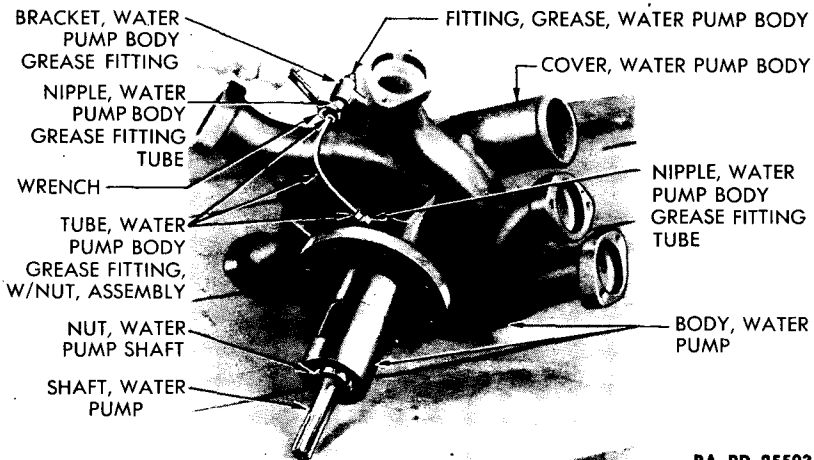
(10) CHECK THE IMPELLER FOR FREE ROTATION BEFORE INSTALLING THE PUMP COVER.

(11) INSTALL PUMP COVER (fig. 144).

WRENCH, open-end, 1/2-in.

WRENCH, torque

WRENCH, socket, 1/2-in.



RA PD 25503

**Figure 145—Installing Grease Fitting, Tube and Bracket  
(on Pumps So Equipped)**



**ORDNANCE MAINTENANCE—POWER UNIT ACCESSORIES  
FOR MEDIUM TANKS M3A4 AND M4A4**

Position *new* gasket over studs in water pump body and secure water pump cover to body with eight stud nuts ( $\frac{1}{2}$ -in. socket wrench) and lock nuts ( $\frac{1}{2}$ -in. open-end wrench). Tighten to 15—20 foot-pounds with torque wrench.

(12) **INSTALL LUBRICATING FITTING BRACKET AND FITTING ASSEMBLY.**

**WRENCH**, open-end,  $\frac{3}{8}$ -in.

**WRENCH**, socket,  $\frac{1}{2}$ -in.

Using the water pump body cover stud nuts, attach lubricating fitting bracket (on vehicles so equipped) ( $\frac{1}{2}$ -in. socket wrench). Install lubricating fitting assembly ( $\frac{3}{8}$ -in. open-end wrench) (fig. 145).

Lubricate pump with **GREASE**, general purpose. If pump is to be stored, plug water inlet and outlet openings to exclude all foreign matter, which might damage pump when placed in operation.

**f. Installation.**

(1) Refer to TM 9-754, January 21, 1943 (par. 85 d), for installation procedure.

CHAPTER 4  
COOLING SYSTEM (Cont'd)

Section IV

RADIATOR, PRESSURE VENT VALVE, THERMOSTATS, WATER  
MANIFOLDS, WATER DISTRIBUTOR TUBE, AND FAN

	Paragraph
General .....	56
Radiator .....	57
Pressure vent valve .....	58
Thermostats .....	59
Water manifolds .....	60
Hose .....	61
Water distributor tube .....	62
Fan .....	63

**56. GENERAL.**

a. The radiator, pressure vent valve, thermostats, water manifolds, water distributor tube, and fan are all related parts of the cooling system.

**57. RADIATOR.**

a. **General.** The radiator is made up of a cast iron upper tank, a fin and tube core, a cast iron lower tank, and cast iron side supports. An expansion joint is built into each side support to permit expansion and contraction of the radiator core. In the core is an opening for the starter motor and engine driven shaft. **CAUTION:** The radiator must be handled with extreme care at all times. The fins and tubes of the core are made of thin copper and brass, and they are easily damaged. Broken radiator tubes will result in radiator leaks, and bent-over fin edges will result in reduced cooling.

**b. Removal.**

(1) Refer to TM 9-754, January 21, 1943 (par. 90) for removal procedure.

**c. Disassembly.**

CHAIN	TANK, washing
DRIFT	WRENCH, 1/2-in.
HAMMER, steel	WRENCH, 9/16-in.
HOIST	WRENCH, 5/8-in.
PLIERS, side cutting	WRENCH, open-end, 1 3/16-in.

**NOTE:** Considerable lost time can be avoided by testing core for leaks before disassembly, provided, of course, there is no evidence of damage on exterior of core. Place radiator assembly in testing tank, make proper

ORDNANCE MAINTENANCE—POWER UNIT ACCESSORIES  
FOR MEDIUM TANKS M3A4 AND M4A4

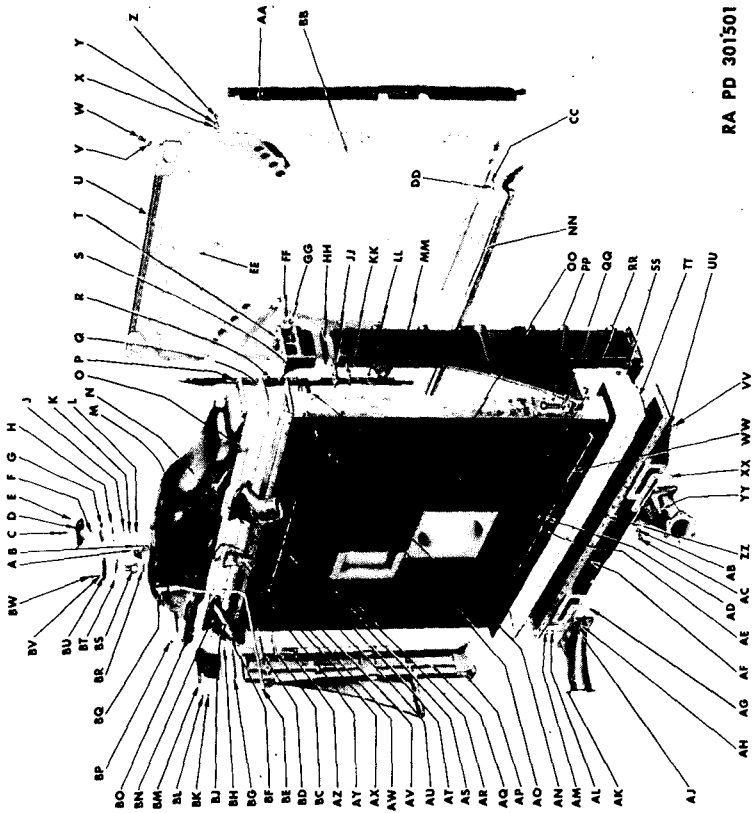


Figure 146—Parts of Radiator and Shroud Assembly

**RADIATOR, PRESSURE VENT VALVE, THERMOSTATS, WATER MANIFOLDS, WATER DISTRIBUTOR TUBE, AND FAN**

- A—BOLT, HOLD DOWN, RADIATOR FILLER CAP, W/NUT, ASSEMBLY
- B—PIN, COTTER, RADIATOR FILLER CAP CLEVIS
- C—BOLT, RETAINER, RADIATOR FILLER CAP
- D—CLAMP, RADIATOR FILLER CAP
- E—PIN, COTTER, RADIATOR FILLER CAP CLEVIS PIN
- F—GASKET, RADIATOR FILLER CAP RETAINER BOLT
- G—CAP, FILLER, RADIATOR
- H—GASKET, RADIATOR FILLER CAP
- J—WASHER, PLAIN, RADIATOR FILLER CAP RETAINER BOLT
- K—GASKET, RADIATOR FILLER CAP RETAINER BOLT
- L—NUT, RADIATOR FILLER CAP RETAINER BOLT
- M—PIN, CLEVIS, RADIATOR FILLER CAP
- N—TANK, RADIATOR, UPPER
- O—STUD, RADIATOR TANK
- P—BOLT, RADIATOR TANK
- Q—GASKET, RADIATOR UPPER TANK
- R—SEAL, RADIATOR, SIDE, LEFT, ASSEMBLY
- S—NUT, RADIATOR UPPER TO LOWER SIDE SUPPORT BOLT
- T—SUPPORT, RADIATOR, SIDE, UPPER, RIGHT
- U—SEAL, RADIATOR, TOP, ASSEMBLY
- V—WASHER, LOCK, RADIATOR SEAL SCREW
- W—SCREW, CAP, RADIATOR SEAL
- X—WASHER, PLAIN, RADIATOR SHROUD SCREW
- Y—WASHER, LOCK, RADIATOR SHROUD SCREW Z—SCREW, RADIATOR SHROUD
- AA—SEAL, RADIATOR, SIDE, RIGHT, ASSEMBLY
- BB—SHROUD, RADIATOR, LOWER, ASSEMBLY
- CC—SCREW, CAP, RADIATOR SEAL
- DD—WASHER, LOCK, RADIATOR SEAL SCREW
- EE—SHROUD, RADIATOR, UPPER, ASSEMBLY
- FF—WASHER, LOCK, RADIATOR TANK BOLT
- GG—NUT, RADIATOR TANK BOLT
- HH—PAD, FILLER, RADIATOR
- JJ—PAD, COMPRESSION, RADIATOR
- KK—PLATE, COMPRESSION, RADIATOR
- LL—BOLT, RADIATOR UPPER TO LOWER SUPPORT
- MM—SUPPORT, RADIATOR, SIDE, LOWER, RIGHT
- NN—SEAL, RADIATOR, BOTTOM, ASSEMBLY
- OO—CORE, RADIATOR, ASSEMBLY
- PP—SCREW, RADIATOR SIDE LOWER SUPPORT TO ENGINE SUPPORT
- QQ—WASHER, LOCK, RADIATOR SIDE LOWER SUPPORT TO ENGINE SUPPORT
- RR—STRIP, HEADER, RADIATOR
- SS—BOLT, RADIATOR TANK
- TT—GASKET, RADIATOR LOWER TANK
- UU—WASHER, LOCK, RADIATOR TANK BOLT
- VV—NUT, RADIATOR TANK BOLT
- WW—STRIP, HEADER, RADIATOR, LOWER, REAR
- XX—GASKET, RADIATOR OUTLET
- YY—OUTLET, RADIATOR, RIGHT
- ZZ—STUD, RADIATOR TANK
- AA—WASHER, LOCK, RADIATOR -OUTLET SCREW
- AB—SCREW, RADIATOR OUTLET
- AD—WASHER, LOCK, RADIATOR TANK STUD
- AE—NUT, RADIATOR TANK STUD
- AF—TANK, RADIATOR, LOWER
- AG—GASKET, RADIATOR OUTLET
- AH—WASHER, LOCK, RADIATOR OUTLET SCREW
- AI—SCREW, RADIATOR OUTLET
- AK—OUTLET, RADIATOR, LEFT
- AL—NUT, RADIATOR TANK BOLT
- AM—WASHER, LOCK, RADIATOR TANK BOLT
- AN—NUT, RADIATOR TANK STUD
- AO—WASHER, LOCK, RADIATOR TANK STUD
- AP—BOLT, RADIATOR TANK
- AQ—SUPPORT, RADIATOR, SIDE, LOWER, LEFT
- AR—INLET, RADIATOR, RIGHT
- AS—WASHER, LOCK, RADIATOR RIGHT AND LEFT INLET SCREW
- AT—SCREW, RADIATOR RIGHT AND LEFT INLET
- AU—GASKET, RADIATOR RIGHT AND LEFT INLET
- AV—GASKET, RADIATOR CENTER INLET
- AW—INLET, RADIATOR, CENTER
- AX—SCREW, RADIATOR CENTER INLET
- AY—WASHER, LOCK, RADIATOR CENTER INLET
- AZ—BOLT, RADIATOR UPPER TO LOWER SUPPORT
- BC—PLATE, COMPRESSION, RADIATOR
- BD—PAD, COMPRESSION, RADIATOR
- BE—TUBE, OVERFLOW, RADIATOR, ASSEMBLY
- BF—INLET, RADIATOR, LEFT
- BG—PAD, FILLER, RADIATOR
- BH—NUT, RADIATOR UPPER TO LOWER SIDE SUPPORT BOLT
- BJ—SCREW, RADIATOR RIGHT AND LEFT INLET
- BK—NUT, RADIATOR TANK BOLT
- BL—WASHER, LOCK, RADIATOR TANK BOLT
- BM—SUPPORT, RADIATOR, SIDE, UPPER, LEFT
- BN—WASHER, LOCK, RADIATOR RIGHT AND LEFT INLET SCREW
- BO—GASKET, RIGHT AND LEFT INLET
- BP—BOLT, RADIATOR TANK
- BQ—ELBOW, RADIATOR OVERFLOW TUBE
- BR—GASKET, RADIATOR OVERFLOW PRESSURE VENT VALVE
- BS—VALVE, RADIATOR OVERFLOW PRESSURE VENT, ASSEMBLY
- BT—GASKET, RADIATOR OVERFLOW PRESSURE VENT VALVE CAP
- BU—CAP, RADIATOR OVERFLOW PRESSURE VENT VALVE
- BV—WASHER, LOCK, RADIATOR OVERFLOW PRESSURE VENT VALVE CAP SCREW
- BW—SCREW, RADIATOR OVERFLOW PRESSURE VENT VALVE CAP

RA PD 301501B

**Legend for Figure 146—Parts of Radiator and Shroud Assembly**

**ORDNANCE MAINTENANCE—POWER UNIT ACCESSORIES  
FOR MEDIUM TANKS M3A4 AND M4A4**

connections to compressed air supply and apply air (10-15 lb per sq in.), and inspect for leaks.

**(1) REMOVE FILTER CAP AND GASKET ASSEMBLY.**

- |                             |                        |
|-----------------------------|------------------------|
| <b>DRIFT</b>                | <b>WRENCH, 1/2-in.</b> |
| <b>HAMMER, steel</b>        | <b>WRENCH, 5/8-in.</b> |
| <b>PLIERS, side cutting</b> |                        |

Loosen cap hold-down bolt nut, to permit raising cap assembly. Use pliers to remove cotter pin and, with drift and hammer, remove clevis pin. Hold cap gasket retaining bolt with 5/8-inch wrench and remove nut with 1/2-inch wrench.

**(2) REMOVE PRESSURE VENT VALVE.**

**WRENCH, 1/2-in.**

Remove four cap screws and lift valve out of opening in upper tank.

**(3) REMOVE OVERFLOW TUBE ELBOW.**

**WRENCH, open-end, 1 3/16-in.**

Unscrew elbow from upper tank.

**(4) REMOVE UPPER TANK ASSEMBLY.**

- |              |                         |
|--------------|-------------------------|
| <b>CHAIN</b> | <b>WRENCH, 9/16-in.</b> |
| <b>HOIST</b> |                         |

With radiator resting on floor, attach chain to the carburetor to air cleaner tube bracket mounting bolt holes and take up slack in chain with hoist, to steady radiator. Remove the bolts and nuts which secure upper tank to radiator core and the two side supports. Support core and lower tank, to prevent damage, and lift upper tank with hoist.

**(5) REMOVE SIDE SUPPORTS.**

**WRENCH, 9/16-in.**

Remove six bolts and nuts which secure each side support to lower tank and remove supports from tank.

**(6) REMOVE CORE FROM LOWER TANK.**

**WRENCH, 9/16-in.**

Remove bolts and nuts which secure core to lower tank and separate core from tank.

**d. Inspection and Repair.**

- |                      |                      |
|----------------------|----------------------|
| <b>TANK, testing</b> | <b>TANK, washing</b> |
|----------------------|----------------------|

**(1) CLEAN PARTS.**

**TANK, washing**

Wash all parts thoroughly in **SOLVENT**, dry-cleaning, to remove all foreign matter. Remove all traces of torn gaskets.

**(2) INSPECT PARTS.**

**TANK, testing**

Inspect both upper and lower tanks for cracks and evidence of leak-

## RADIATOR, PRESSURE VENT VALVE, THERMOSTATS, WATER MANIFOLDS, WATER DISTRIBUTOR TUBE, AND FAN

age. Inspect all threaded openings for condition of threads and for obstructions. Inspect both side supports for cracks or any indications of failure. Inspect core for any damaged tubes or fins. NOTE: If any fins are bent, be sure to straighten to eliminate any obstruction of air travel between fins and tubes.

### e. Assembly.

CHAIN	WRENCH, 1/2-in.
HAMMER, steel	WRENCH, 9/16-in.
HOIST	WRENCH, 5/8-in.
PLIERS, side cutting	WRENCH, open-end, 1 3/16-in.
TANK, testing	

#### (1) ASSEMBLE CORE TO LOWER TANK.

WRENCH, 9/16-in.

Paint mounting faces of core and lower tank with a suitable sealing compound. Position *new* gasket on lower tank and secure core to tank with bolts, studs, nuts and lock washers.

#### (2) INSTALL SIDE SUPPORTS.

WRENCH, 9/16-in.

Place side supports in position and secure each with six bolts, nuts and lock washers.

#### (3) INSTALL UPPER TANK.

CHAIN	WRENCH, 9/16-in.
HOIST	

Paint mounting faces of radiator core and upper tank with a suitable sealing compound. Position *new* gasket on core, lift tank with hoist and lower in place on core. Secure with bolts, studs, nuts and lock washers, both to core and to the two side supports.

#### (4) INSTALL OVERFLOW TUBE ELBOW.

WRENCH, open-end, 1 3/16-in.

Paint threads with a suitable sealing compound and screw elbow into opening in upper tank (fig. 146).

#### (5) INSTALL PRESSURE VENT VALVE.

WRENCH, 1/2-in.

Insert valve in opening (with spring end down) and, using a *new* gasket, install vent valve cap, securing with four cap screws and lock washers.

#### (6) INSTALL RADIATOR CAP (fig. 146).

HAMMER, steel	WRENCH, 1/2-in.
PLIERS, side cutting	WRENCH, 5/8-in.

Insert cap retainer bolt (from top) through hole in cap; place bolt gasket on bolt; place filler cap on bolt; place filler cap gasket on bolt;

**ORDNANCE MAINTENANCE—POWER UNIT ACCESSORIES  
FOR MEDIUM TANKS M3A4 AND M4A4**

place retainer bolt plain washer on bolt; place filler cap retainer bolt gasket on bolt and install nut. Hold bolt with ½-inch wrench and tighten nut with ⅝-inch wrench. Place assembly on upper tank, insert clevis pin through holes in bosses on tank and cap and secure clevis pin with cotter pin (hammer and side cutting pliers).

**(7) TEST FOR LEAKS.****HOIST****TANK, testing**

Lift assembly with hoist (fig. 147); place in testing tank; make necessary connections to air supply; apply compressed air (10—15 lb per sq in.), and inspect assembly for leaks.

**58. PRESSURE VENT VALVE.**

**a. General.** The pressure vent valve is located on the radiator upper tank about 6 inches to the left of the radiator filler cap (fig. 146). This valve assembly consists of a top plate, retainer hold-down spring and valve retainer. Inside the valve retainer is a vent valve and a pressure valve. Both valves are spring loaded. The vent valve is located in the center of the pressure valve. The springs are so arranged that the pressure valve can relieve pressure from the system, and the vent valve can admit air to the system.

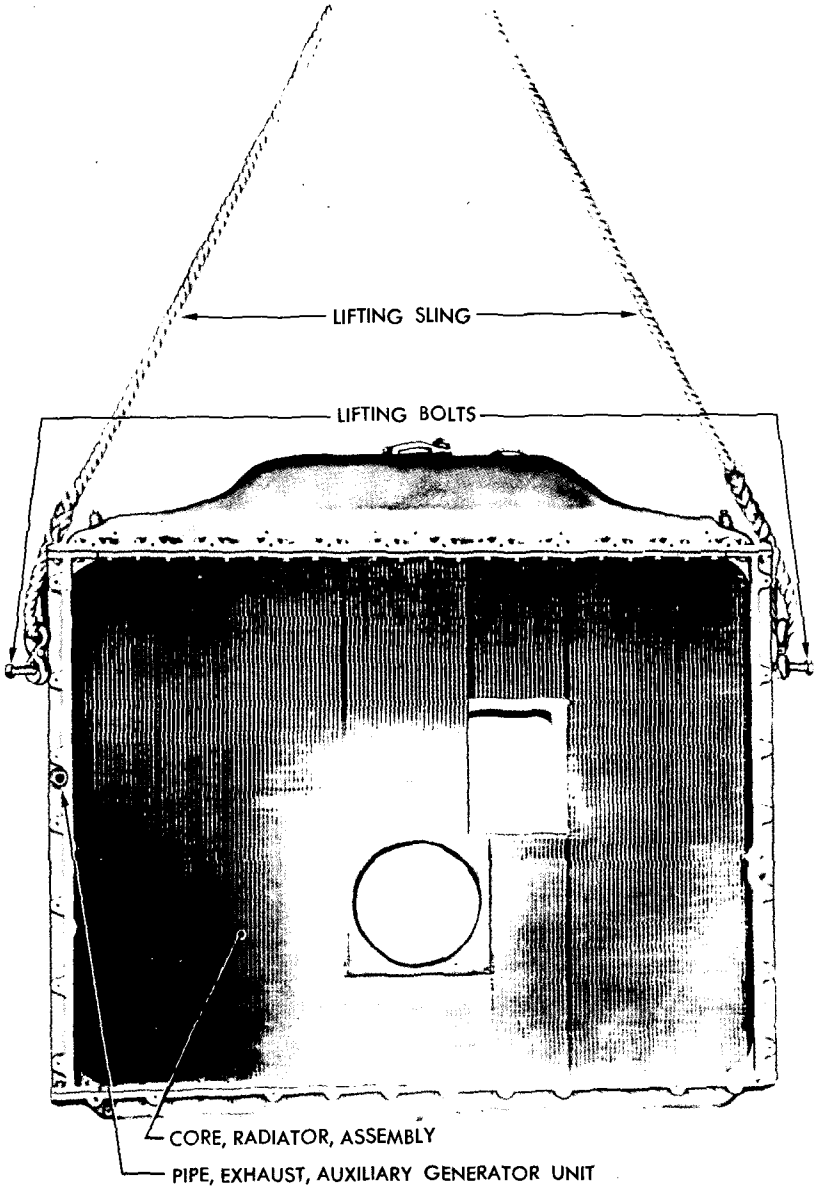
**b. Function.** The pressure valve maintains vapor pressure up to 10 pounds per square inch in the system. This pressure increases the boiling point of the water in the system to 240 F. The vent valve will admit air to the system if the pressure in the system is reduced to one-quarter pound per square inch below atmospheric pressure. The pressure vent valve prevents water loss by keeping the overflow tube closed during normal operation of the unit.

**c. Operation.** The pressure relief valve remains closed during normal operation of the power unit. If, during warm weather, the cooling water temperature exceeds 212 F, the vapor pressure in the system will be higher than the atmospheric pressure. At 240 F, the vapor pressure will be 10 pounds per square inch above atmospheric pressure. The pressure valve will relieve at 10 pounds per square inch above atmospheric pressure. The vent valve opens to admit air to the radiator upper tank when the power unit and water cool off after the power unit has ceased operating. The pressure relief valve discharges into the radiator overflow tube. If for any reason, the pressure relief valve has become worn or damaged, the proper pressure will not be maintained on the cooling system. This will reduce the boiling point of the coolant from 240 F to 212 F.

**d. Removal.**

(1) Refer to TM 9-754, January 21, 1943 (par. 91 d) for removal procedure.

**RADIATOR, PRESSURE VENT VALVE, THERMOSTATS, WATER  
MANIFOLDS, WATER DISTRIBUTOR TUBE, AND FAN**



RA PD 25424

**Figure 147—Radiator in Lifting Sling**



**ORDNANCE MAINTENANCE—POWER UNIT ACCESSORIES  
FOR MEDIUM TANKS M3A4 AND M4A4**

**e. Installation.**

(1) Refer to TM 9-754, January 21, 1943 (par. 91 e) for installation procedure.

**59. THERMOSTATS.**

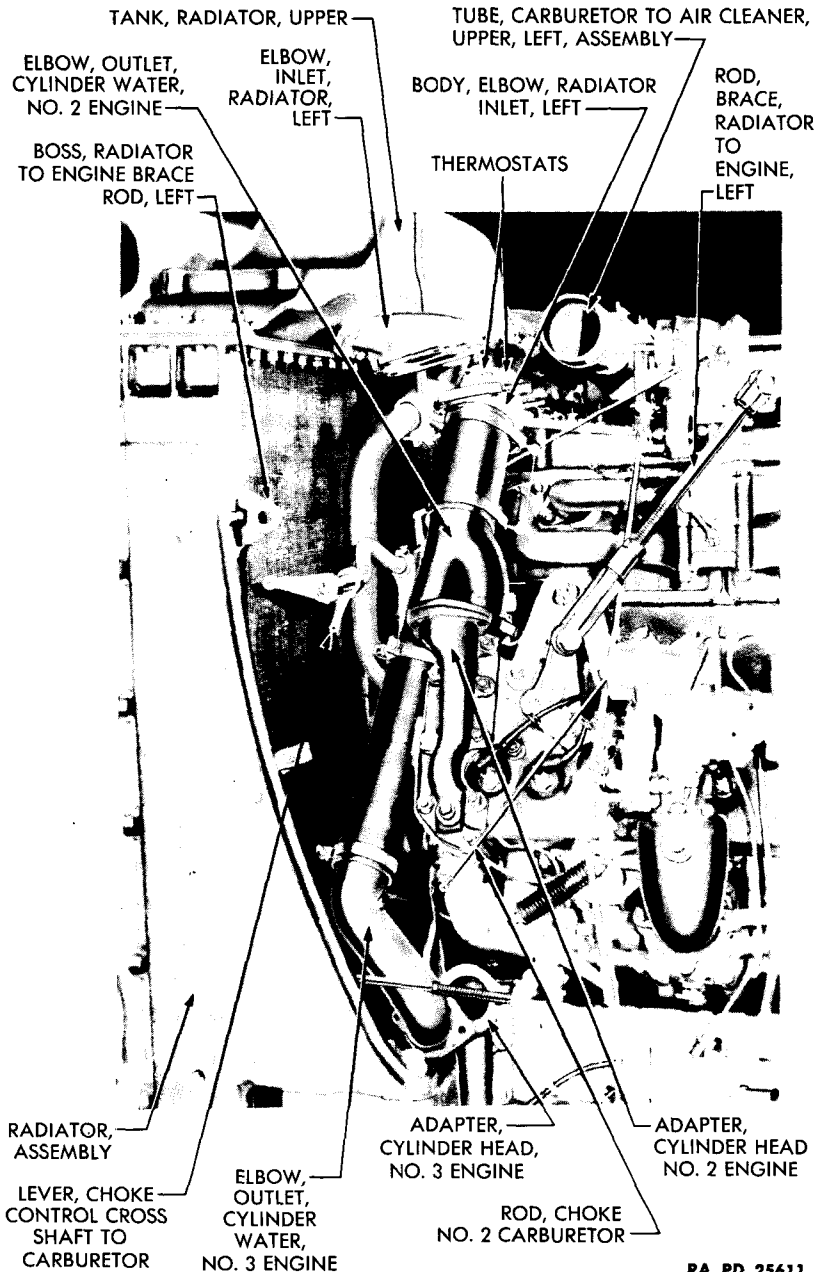
**a. General.** Five thermostats are used to control the water temperature in the cooling system. Two types of thermostats are in use, the choke type and the bypass type. (The two types of thermostats are not interchangeable.) Do not use both types of thermostats in any one engine. They maintain a constant power unit water temperature during operation and reduce the warm-up time of the power unit. They are set to maintain a power unit water temperature of 145 F when the cooling system is at atmospheric pressure or 160 F. When the pressure on the cooling system is 8 pounds per square inch, more water will flow through the radiator in warm weather than in cold weather. In extremely hot weather, the thermostats will permit free flow of water through the radiator, and completely close the bypass valve. The valve to the radiator will be wide open when the cooling water temperature reaches 180 F. Under these conditions, the operating temperature of the cooling water will be from 90 F to 110 F above the outside air temperature.

(1) The choke type thermostat, located, one in each individual engine, in the top of cylinder head of No. 1 engine and in the radiator inlet manifold for engines Nos. 2, 3, 4, and 5, was used in production from M4A4 power unit serial No. M4A4-1001 to, and including, power unit serial No. M4A4-3211.

(2) The bypass type thermostat (located in the top of cylinder head of No. 1 engine; in radiator inlet adapter, left, for engines Nos. 2 and 3; and in the radiator inlet adapter, right, for engines Nos. 4 and 5) entered production with power unit serial number M4A4-3212, and above, although this bypass type of thermostat was used in several power units prior to serial number M4A4-3211 (figs. 148 and 149).

**b. Operation.** During the warm-up period, the thermostat shuts off the flow of coolant through the radiator, and all the heat normally dissipated by it is used to warm up the coolant and the power unit. As the coolant is warmed up and reaches approximately 160 F, a valve in the thermostat opens, allowing coolant to flow to the radiator. The thermostat will regulate the flow of the coolant through the radiator so that the coolant temperature will be held at 160 F. In extremely hot weather, the thermostat will permit free flow of the coolant through the radiator. The thermostat valve will be fully open when the coolant reaches 180 F. Under these conditions, the operating temperature of the coolant will be from 90 F to 110 F above the outside air temperature.

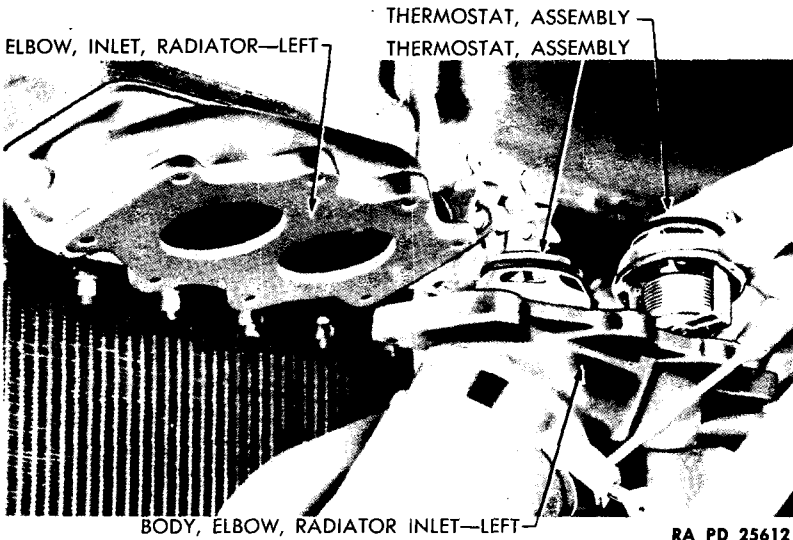
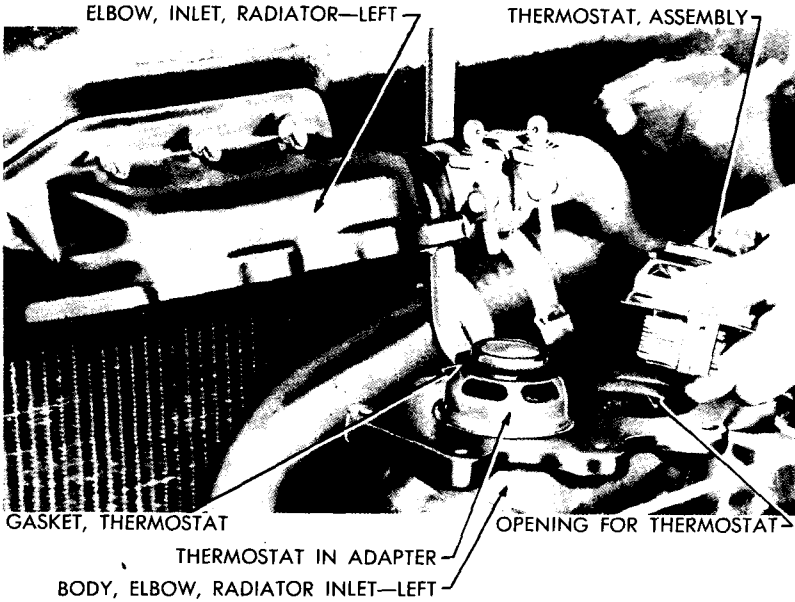
**RADIATOR, PRESSURE VENT VALVE, THERMOSTATS, WATER  
MANIFOLDS, WATER DISTRIBUTOR TUBE, AND FAN**



RA PD 25611

**Figure 148—Bypass Type Thermostats**

ORDNANCE MAINTENANCE—POWER UNIT ACCESSORIES  
FOR MEDIUM TANKS M3A4 AND M4A4



RA PD 25612

Figure 149—Bypass Type Thermostats Installation

**RADIATOR, PRESSURE VENT VALVE, THERMOSTATS, WATER  
MANIFOLDS, WATER DISTRIBUTOR TUBE, AND FAN**

(1) **CHOKE TYPE.** The choke type thermostat retains the coolant in the individual engine until the temperature of the coolant reaches 160 F at which time the thermostat opens, allowing the coolant to circulate through the radiator.

(2) **BYPASS TYPE.** During the warm-up period, the thermostat directs all of the coolant flow through a radiator bypass tube which connects the engine water outlet adapters with the water pump inlet. In this manner, the coolant is circulated through the cooling systems of each individual engine but not through the radiator, thus decreasing the warm-up time. As soon as the temperature of the coolant reaches 160 F the thermostat opens, permitting the coolant to circulate through the radiator.

**c. Removal and Installation (Choke Type).**

(1) Refer to TM 9-754, January 21, 1943 (par. 88 d and e) for removal and installation procedure.

**d. Removal and Installation (Bypass Type).**

(1) Refer to TM 9-754, January 21, 1943 (par. 88 f and g) for removal and installation procedure.

**60. WATER MANIFOLDS.**

**a. General.** The coolant circulated in the engines is conducted to and from the radiator by means of water manifolds or tube assemblies connected to the radiator and engine outlets and inlets by means of hose connections. The radiator outlet manifolds connect directly to the water pump or pumps (multiple water pumps). The radiator inlet adapters connect directly to the engine cylinder water outlets or elbows and are secured together by hose connections (figs. 150 and 151). With the use of the bypass type of thermostats, a bypass tube is connected between the radiator inlet elbows, both right and left, the radiator center inlet and the radiator outlet tube, left (figs. 151 and 152).

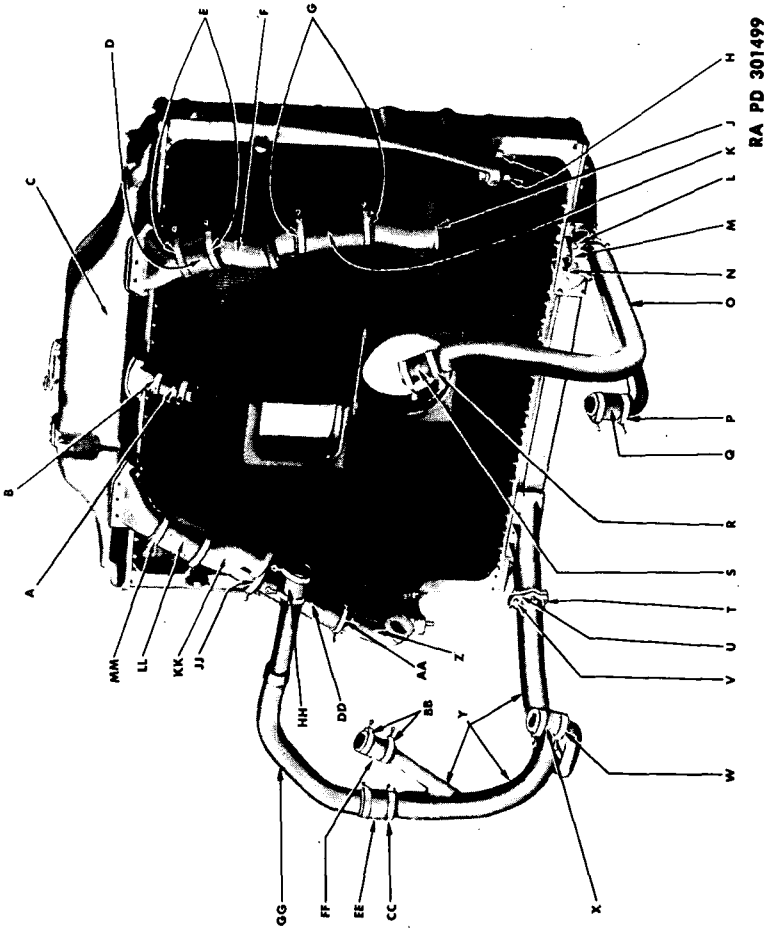
**61. HOSE.**

**a. General.** Cooling system water hose are made of oil and heat-resistant synthetic rubber. The synthetic rubber is reinforced by layers of cotton canvas moulded into the rubber. These pliable hose are used as water ducts so that vibration and slight movements will not induce stresses in the engines and radiator parts.

**b. Removal.**

(1) Remove locking wires from hose clamps. Loosen clamps and slide to one side. Work hose off tube by hand.

ORDNANCE MAINTENANCE—POWER UNIT ACCESSORIES  
FOR MEDIUM TANKS M3A4 AND M4A4



RA PD 301499

Figure 150—Water Tubes, Hose, and Manifolds (Multiple Water Pump Type)

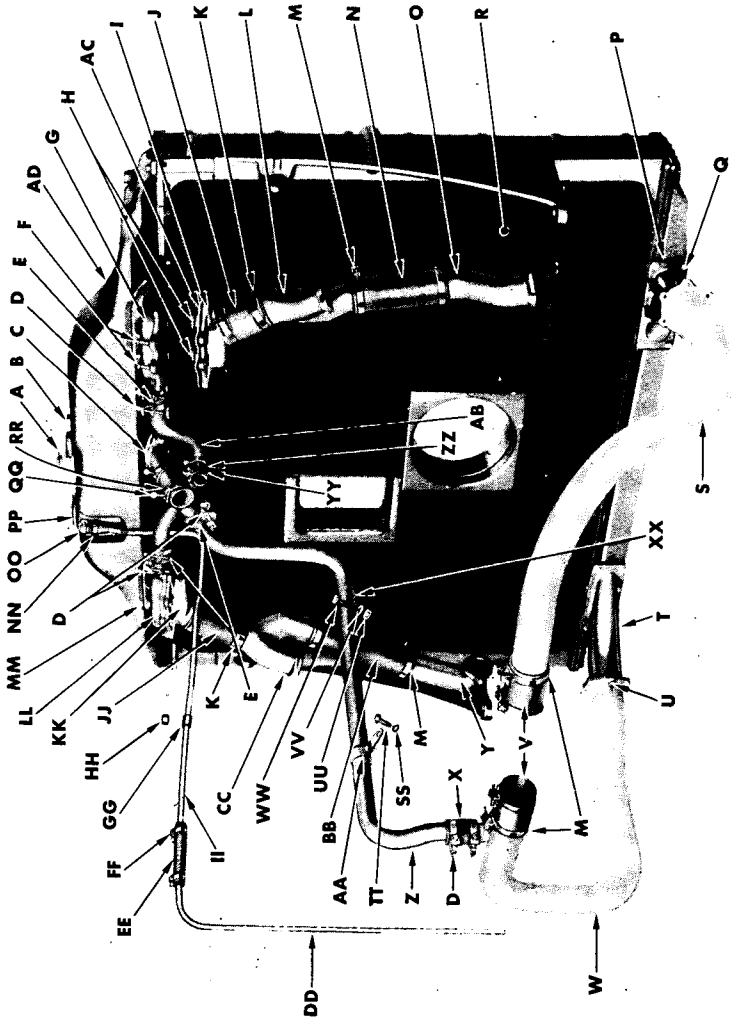
## RADIATOR, PRESSURE VENT VALVE, THERMOSTATS, WATER MANIFOLDS, WATER DISTRIBUTOR TUBE, AND FAN

- A—HOSE, INLET, RADIATOR (NO. 1 ENGINE)  
 B—CLAMP, RADIATOR INLET HOSE (NO. 1 ENGINE)  
 C—RADIATOR, ASSEMBLY  
 D—HOSE, INLET, RADIATOR (NOS. 4 AND 5 ENGINES)  
 E—CLAMP, RADIATOR INLET HOSE (NOS. 4 AND 5 ENGINES)  
 F—ELBOW, CYLINDER WATER OUTLET (NO. 5 ENGINE)  
 G—CLAMP, RADIATOR INLET HOSE (NOS. 3 AND 4 ENGINES)  
 H—SCREW, RADIATOR SIDE LOWER SUPPORT TO ENGINE SUPPORT  
 J—ELBOW, CYLINDER WATER OUTLET (NO. 4 ENGINE)  
 K—HOSE, INLET, RADIATOR (NO. 4 ENGINE)  
 L—BOLT, FLANGE, RADIATOR OUTLET TUBE  
 M—GASKET, FLANGE, RADIATOR OUTLET TUBE  
 N—NUT, RADIATOR OUTLET TUBE FLANGE BOLT  
 O—TUBE, RADIATOR OUTLET, ASSEMBLY (NOS. 4 AND 5 ENGINES)  
 P—CLAMP, RADIATOR OUTLET TUBE CONNECTION HOSE  
 Q—HOSE, RADIATOR OUTLET TUBE CONNECTION  
 R—CLAMP, RADIATOR OUTLET TUBE CONNECTION  
 S—HOSE, RADIATOR OUTLET TUBE CONNECTION  
 T—NUT, RADIATOR OUTLET TUBE FLANGE BOLT
- U—GASKET, FLANGE, RADIATOR OUTLET TUBE  
 V—BOLT, FLANGE, RADIATOR OUTLET TUBE  
 W—CLAMP, RADIATOR OUTLET TUBE CONNECTION HOSE  
 X—HOSE, RADIATOR OUTLET TUBE CONNECTION  
 Y—TUBE, RADIATOR OUTLET, ASSEMBLY (NOS. 2 AND 3 ENGINES)  
 Z—ELBOW, CYLINDER WATER OUTLET (NO. 3 ENGINE)  
 AA—CLAMP, RADIATOR INLET HOSE (NO. 3 ENGINE)  
 BB—CLAMP, RADIATOR OUTLET TUBE CONNECTION HOSE  
 CC—CLAMP, RADIATOR OUTLET TUBE CONNECTION HOSE  
 DD—HOSE, INLET, RADIATOR (NO. 3 ENGINE)  
 EE—HOSE, RADIATOR OUTLET TUBE CONNECTION  
 FF—HOSE, RADIATOR OUTLET TUBE CONNECTION  
 GG—CONNECTION, RADIATOR OUTLET TUBE, ASSEMBLY  
     (NO. 1 ENGINE)  
 HH—HOSE, RADIATOR OUTLET TUBE CONNECTION (NO. 1 ENGINE)  
 JJ—CLAMP, RADIATOR INLET HOSE (NO. 3 ENGINE)  
 KK—ELBOW, CYLINDER WATER OUTLET (NO. 2 ENGINE)  
 LL—HOSE, INLET, RADIATOR (NOS. 2 AND 3 ENGINES)  
 MM—CLAMP, RADIATOR INLET HOSE (NOS. 2 AND 3 ENGINES)

RA PD 301499B

**Legend for Figure 150—Water Tubes, Hose, and Manifolds  
(Multiple Water Pump Type)**

ORDNANCE MAINTENANCE—POWER UNIT ACCESSORIES  
FOR MEDIUM TANKS M3A4 AND M4A4



RA PD 301498

Figure 151—Water Tubes, Hose, and Manifolds (Single Water Pump Type, with Bypass Thermostats)

**RADIATOR, PRESSURE VENT VALVE, THERMOSTATS, WATER MANIFOLDS, WATER DISTRIBUTOR TUBE, AND FAN**

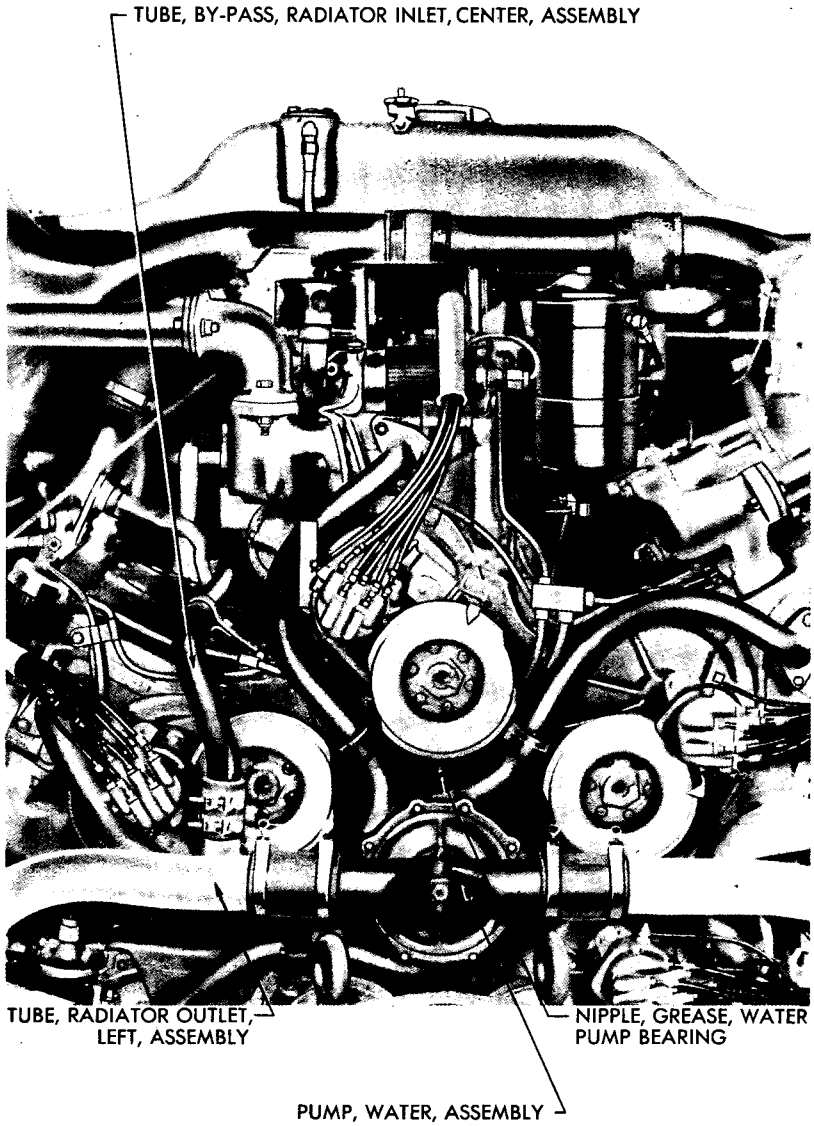
- A—NUT, HOLD-DOWN BOLT, RADIATOR FILLER CAP
- B—CAP, FILLER, RADIATOR
- C—INLET, RADIATOR—CENTER
- D—CLAMP, HOSE, RADIATOR BYPASS INLET TUBE
- E—HOSE, BYPASS TUBE, RADIATOR INLET—SHORT
- F—SCREW AND WASHER, ELBOW TO BODY, RADIATOR INLET—RIGHT
- G—BODY, ELBOW, RADIATOR INLET—RIGHT
- H—THERMOSTAT, ASSEMBLY
- I—ELBOW, INLET, RADIATOR—RIGHT
- J—HOSE, ELBOW, CYLINDER WATER OUTLET—NO. 5 ENGINE
- K—CLAMP, HOSE, CYLINDER WATER OUTLET ELBOW
- L—ELBOW, OUTLET, CYLINDER WATER—NO. 5 ENGINE
- M—CLAMP, HOSE, CYLINDER WATER OUTLET ELBOW
- N—HOSE, ELBOW, CYLINDER WATER OUTLET, NO. 4 ENGINE
- O—ELBOW, OUTLET, CYLINDER WATER—NO. 4 ENGINE
- P—OUTLET, RADIATOR—RIGHT
- Q—SCREW AND WASHER, OUTLET, RADIATOR
- R—CORE, RADIATOR, ASSEMBLY
- S—TUBE, OUTLET, RADIATOR, ASSEMBLY—RIGHT
- T—OUTLET, RADIATOR, LEFT
- U—SCREW, OUTLET TO TUBE, RADIATOR
- V—HOSE, TUBE, RADIATOR OUTLET
- W—TUBE, OUTLET, RADIATOR, ASSEMBLY—LEFT
- X—HOSE, BYPASS TUBE, RADIATOR INLET—LONG
- Y—ELBOW, OUTLET, CYLINDER WATER—NO. 3 ENGINE
- Z—TUBE, SIDE BYPASS, RADIATOR INLET, ASSEMBLY
- AA—CLIP, SIDE BYPASS, RADIATOR
- BB—HOSE, ELBOW, CYLINDER WATER OUTLET, NO. 3 ENGINE
- CC—ELBOW, OUTLET, CYLINDER WATER, NO. 2 ENGINE
- DD—TUBE, OVERFLOW, RADIATOR—OUTER
- EE—HOSE, OVERFLOW TUBE, RADIATOR
- FF—CLAMP, TUBE, RADIATOR OVERFLOW, ASSEMBLY
- GG—CLIP, TUBE, RADIATOR OVERFLOW
- HH—NUT, STUD, RADIATOR OVERFLOW TUBE CLIP
- II—TUBE, OVERFLOW, RADIATOR, ASSEMBLY
- JJ—HOSE, ELBOW, CYLINDER WATER OUTLET, NO. 2 ENGINE
- KK—ELBOW, INLET, RADIATOR—LEFT
- LL—BODY, ELBOW, RADIATOR INLET—LEFT
- MM—STUD AND NUT, ELBOW BODY, RADIATOR INLET
- NN—NUT, TUBE, RADIATOR OVERFLOW
- OO—ELBOW, TUBE, RADIATOR OVERFLOW
- PP—VALVE, VENT, RADIATOR OVERFLOW PRESSURE, ASSEMBLY
- QQ—CLAMP, HOSE, RADIATOR CENTER INLET
- RR—HOSE, INLET, RADIATOR—CENTER
- SS—WASHER, ATTACHING SCREW, RADIATOR INLET SIDE BYPASS TUBE CLIP
- TT—SCREW, ATTACHING, RADIATOR INLET SIDE BYPASS TUBE CLIP
- UU—NUT, BOLT, RADIATOR INLET SIDE BYPASS TUBE BRACKET
- VV—WASHER, BOLT, RADIATOR INLET SIDE BYPASS TUBE BRACKET
- WW—BOLT, BRACKET, RADIATOR INLET SIDE BYPASS TUBE
- XX—BRACKET, TUBE, RADIATOR INLET SIDE BYPASS
- YY—CLAMP, HOSE, RADIATOR INLET CENTER BYPASS CONNECTION
- ZZ—HOSE, CONNECTION, RADIATOR INLET CENTER BYPASS
- AB—TUBE, BYPASS, RADIATOR INLET, ASSEMBLY—CENTER
- AC—GASKET, ELBOW, RADIATOR INLET
- AD—RADIATOR, ASSEMBLY

RA PD 3014988

**Legend for Figure 151—Water Tubes, Hose, and Manifolds (Single Water Pump Type, with Bypass Thermostats)**



**ORDNANCE MAINTENANCE—POWER UNIT ACCESSORIES  
FOR MEDIUM TANKS M3A4 AND M4A4**



RA PD 25586

**Figure 152—Bypass Tube Entering Radiator Outlet Tube Assembly**

**RADIATOR, PRESSURE VENT VALVE, THERMOSTATS, WATER  
MANIFOLDS, WATER DISTRIBUTOR TUBE, AND FAN**

**c. Installation.**

- (1) Place hose clamps around ends of water tube behind bead.
- (2) Force hose over ends of pipe by turning the hose with hands. The hose must go over the bead on the water tube.
- (3) Install the hose clamps over the flat part of the hose behind the beads on the water tube.
- (4) Tighten thumbscrews, hose clamps, and secure with locking wire.

**62. WATER DISTRIBUTOR TUBE.**

**a. General.** The water distributor tube is located between the cylinders and the valve ports (in each individual engine) near the top of the cylinder block and directs a flow of water from the water pump against the exhaust valve ports which are the hottest spots in the engine. This tube is made of sheet metal and is approximately 2 feet long, flat on one side and oval shaped on the other. Slots are cut on the top edge of the tube.

**b. Removal.** Pull tube out of the cylinder block with a rod having a hook formed on one end.

**63. FAN.**

**a. General.**

(1) The cooling air fan is made of cast aluminum. It has 15 blades, is 39¼ inches in diameter at the blade tips, and 24½ inches in diameter at the blade roots. The inside of the fan hub is machined to hold the power unit clutch, and the outside back face is machined to hold the starter ring gear.

(2) The cooling air fan forces air through the radiator core and power unit compartment to keep the unit cool. The fan operates at drive shaft speed.

(3) Air is drawn past the engine and transmission oil coolers in the fighting compartment and through the ventilated grille in the power unit compartment cover. The fan being located in front of the radiator core and just behind the fighting compartment bulkhead, forces the air through the radiator core, the power unit compartment and out at the rear end of the vehicle.

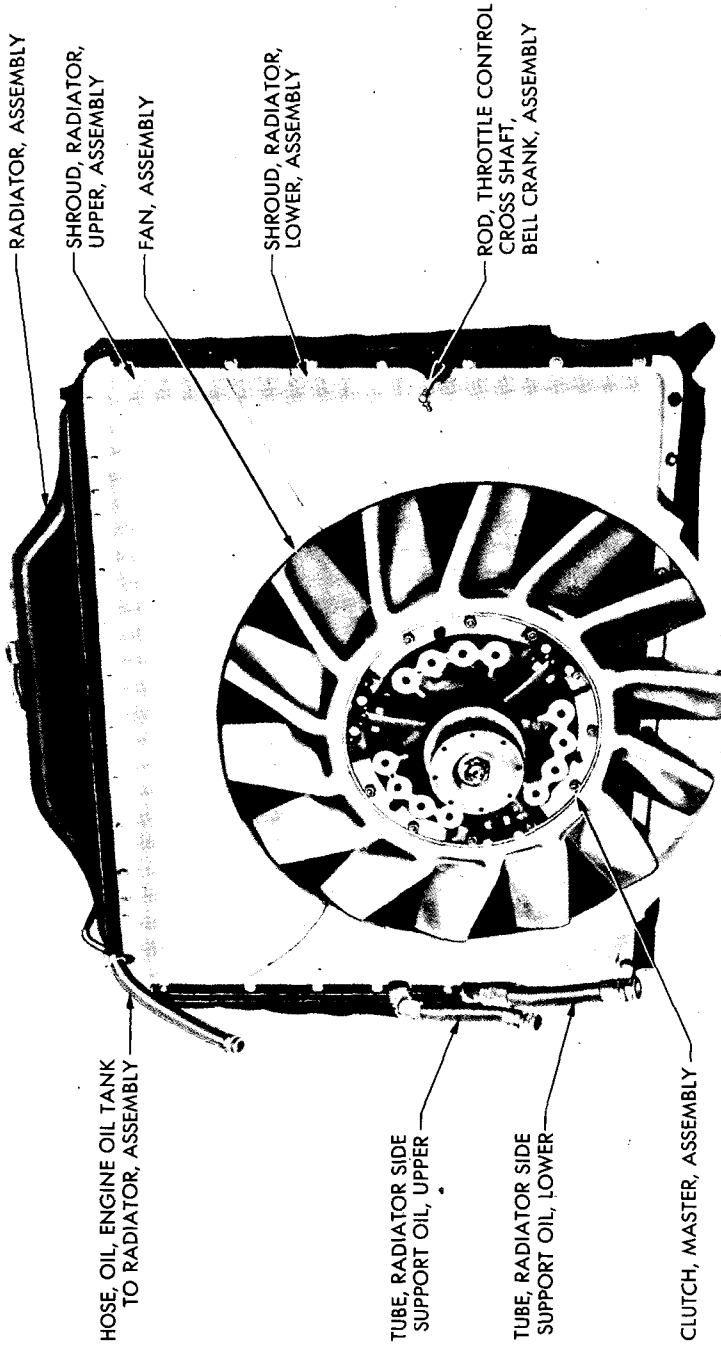
**b. Removal.**

(1) Refer to TM 9-754, January 21, 1943 (par. 93 b (9)) for removal procedure.

**c. Installation.**

(1) Refer to TM 9-754, January 21, 1943 (par. 94 a (2)) for installation procedure.

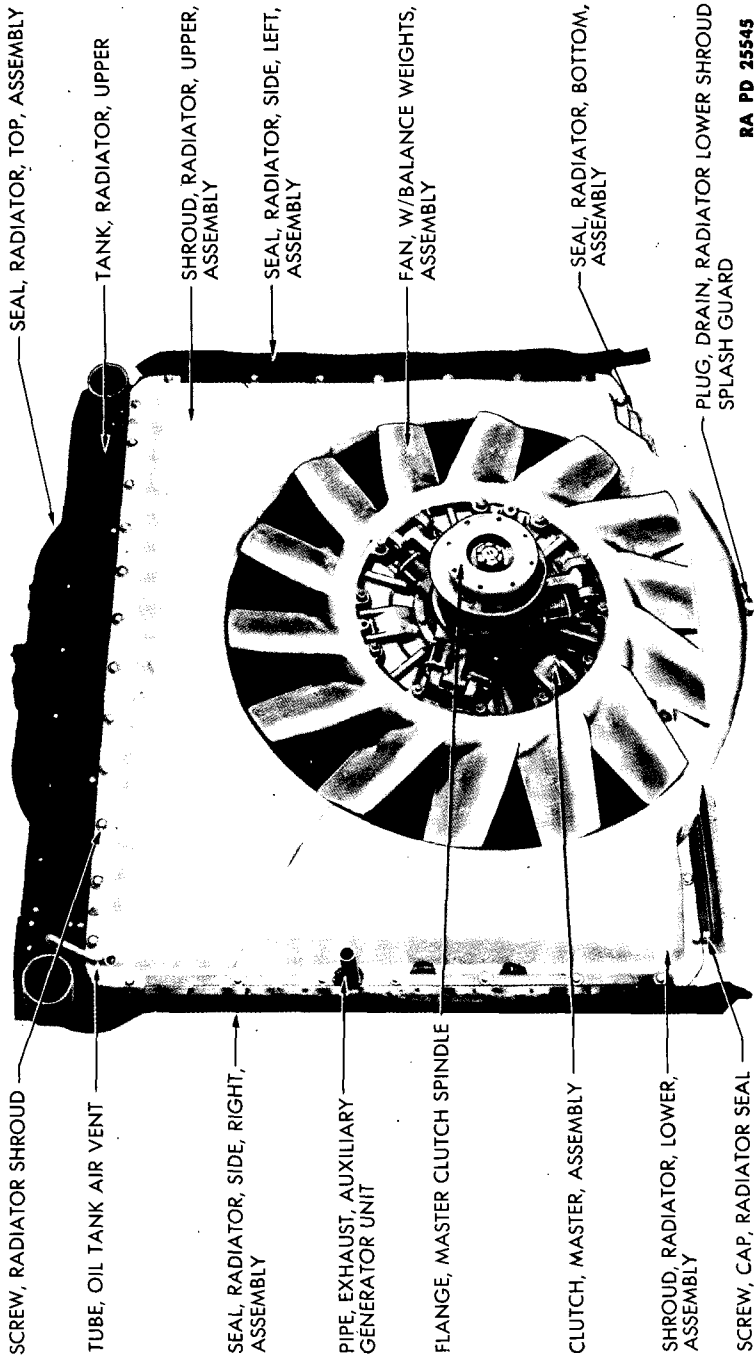
ORDNANCE MAINTENANCE—POWER UNIT ACCESSORIES  
FOR MEDIUM TANKS M3A4 AND M4A4



RA PD 25336

Figure 153—Power Unit M3A4 Radiator, Fan and Clutch—front view

**RADIATOR, PRESSURE VENT VALVE, THERMOSTATS, WATER MANIFOLDS, WATER DISTRIBUTOR TUBE, AND FAN**



RA PD 25545

**Figure 154—Power Unit M4A4 Front End View of Power Unit**

**ORDNANCE MAINTENANCE—POWER UNIT ACCESSORIES  
FOR MEDIUM TANKS M3A4 AND M4A4**

**CHAPTER 4**

**COOLING SYSTEM (Cont'd)**

**Section V**

**FITS AND TOLERANCES**

Fits and tolerances .....	64
Standard for tightening bolts .....	65

**64. FITS AND TOLERANCES.**

**a. Multiple Water Pump.**

	Minimum	Maximum	Replace Beyond
	Minus	Plus	
Press fit of bearings in housing .....	0.0004 in.	0.0004 in.	
		Minus	
Press fit of bearings on shaft .....	0.000 in.	0.0006 in.	
Distance from seal seat to face of rear of body .....			1 <sup>7</sup> / <sub>64</sub> in.
Bearing diameter of shaft .....	0.5906 in.	0.5910 in.	
Seal diameter of shaft .....	0.6680 in.	0.6686 in.	
Inside diameter of bearings .....	0.5906 in.		
Outside diameter of bearings .....	1.3780 in.		
Length of bearing spacer .....	0.778 in.	0.783 in.	
Diameter of bore in body for bearings	1.3776 in.	1.3784 in.	

**b. Single Water Pump.**

	Minus	Plus	
Press fit of bearings in housing .....	0.0001	0.0014	
	Minus	Minus	
Press fit of bearings on shaft .....	0.0002	0.0006	
Distance from seal seat to face of rear of body .....			1 <sup>27</sup> / <sub>32</sub> in.
Bearing diameter of shaft .....	0.7872 in.	0.7876 in.	
Seal diameter of shaft .....	0.6680 in.	0.6686 in.	
Inside diameter of bearings .....	0.7870 in.	0.7874 in.	
Outside diameter of bearings .....	1.8499 in.	1.8504 in.	
Length of bearing spacer .....	3.497 in.	3.502 in.	
Diameter of bore in body for bearings	1.8503 in.	1.8513 in.	
Diameter of bore in body for oil seal	1.623 in.	1.625 in.	
Distance from shoulder on shaft to face of impeller .....	1.700 in.	1.705 in.	

**FITS AND TOLERANCES**

**65. STANDARD FOR TIGHTENING BOLTS.**

**a. Torque Tightness.**

	<b>Minimum</b>	<b>Maximum</b>
Cylinder water outlet elbow screws . . . . .	30 ft-lb	35 ft-lb
Water pump outlet tube adapter stud nuts . . . . .	30 ft-lb	35 ft-lb
Water pump body cover studs . . . . .	15 ft-lb	20 ft-lb
Water pump attaching studs (mul- tiple pump) . . . . .	30 ft-lb	35 ft-lb
Water pump attaching studs (single pump, $\frac{5}{16}$ -in. studs) . . . . .	15 ft-lb	20 ft-lb
Water pump attaching studs (single pump, $\frac{3}{8}$ -in. studs) . . . . .	30 ft-lb	35 ft-lb

**ORDNANCE MAINTENANCE—POWER UNIT ACCESSORIES  
FOR MEDIUM TANKS M3A4 AND M4A4**

**CHAPTER 5**

**CLUTCH (MODEL M4A4)**

**Section I**

**DESCRIPTION OF CLUTCH**

	Paragraph
Description .....	66
Tabulated data and specifications .....	67
Second echelon operations .....	68
Echelon break-down of maintenance .....	69

**66. DESCRIPTION (figs. 155 and 156).**

a. The clutch is of the dry, multiple plate type, having two driven members. It is mounted inside a recessed flywheel and is located just forward of the radiator. The clutch assembly consists of the flywheel, spindle, spindle flange, two driven plates (one inner and one outer), a center or driving plate, a release sleeve and a flywheel ring assembly which includes the clutch release levers and linkage attached to the master pressure plate and the pressure springs attached to the spring carrier. The clutch facings are riveted to both sides of the clutch driven plates. At power unit serial number M4A4-1571, plate separate adjusting screws were added to the flywheel ring and spring-loaded separator pins were added to the flywheel to assist in separating the clutch center plate from the clutch driven plates.

b. A fully enclosed type of clutch is used from power unit serial number M4A4-1001 to, and including, serial number M4A4-4412. Power units M4A4-4413, and above, use a ventilated type of clutch, incorporating openings in the flywheel, flywheel ring and fan. The ventilated type is interchangeable with the full enclosed type, however, if full ventilating results are to be obtained, it is necessary to replace the fan with the ventilated type, when installing the ventilated type of clutch. Because it is interchangeable, only the ventilated type of clutch is illustrated in this manual.

c. Castor type clutch throwout bearings are used from power unit serial number M4A4-1001 to, and including, serial number M4A4-6983 (fig. 159). On power units M4A4-6984, and above, a coaxial type bearing is used. While the castor type throwout bearings are used with both the fully enclosed type and ventilated type clutches, they are not interchangeable with the coaxial type bearing, in view of the fact the clutch release fork mounting bracket, and clutch release sleeve body were changed to accommodate the coaxial bearing.

**DESCRIPTION OF CLUTCH**

d. Disengagement of the clutch is by means of a pedal, clutch pedal rod, clutch release cross shaft, clutch release rod, and clutch yoke (figs. 157 and 158). On the earlier model tanks, adjustment of the clutch release rod is by means of a clevis at front end of rod. On later model tanks, adjustment of the length of this rod is by means of a turnbuckle, located just forward of the turret (fig. 158). All adjustments to compensate for clutch facing wear are made by altering the length of the clutch release rod. **CAUTION:** Do not alter length of clutch pedal rod as this will result in incorrect location of clutch pedal. Refer to TM 9-754, January 21, 1943 (par. 95 c) for adjustment of clutch pedal.

e. A remote lubricating system, for lubricating clutch throwout bearings, is provided on the later model tanks, enabling the operator to lubricate the clutch throwout bearings from within the fighting compartment (fig. 159).

**67. TABULATED DATA AND SPECIFICATIONS.**

**a. Clutch Assembly.**

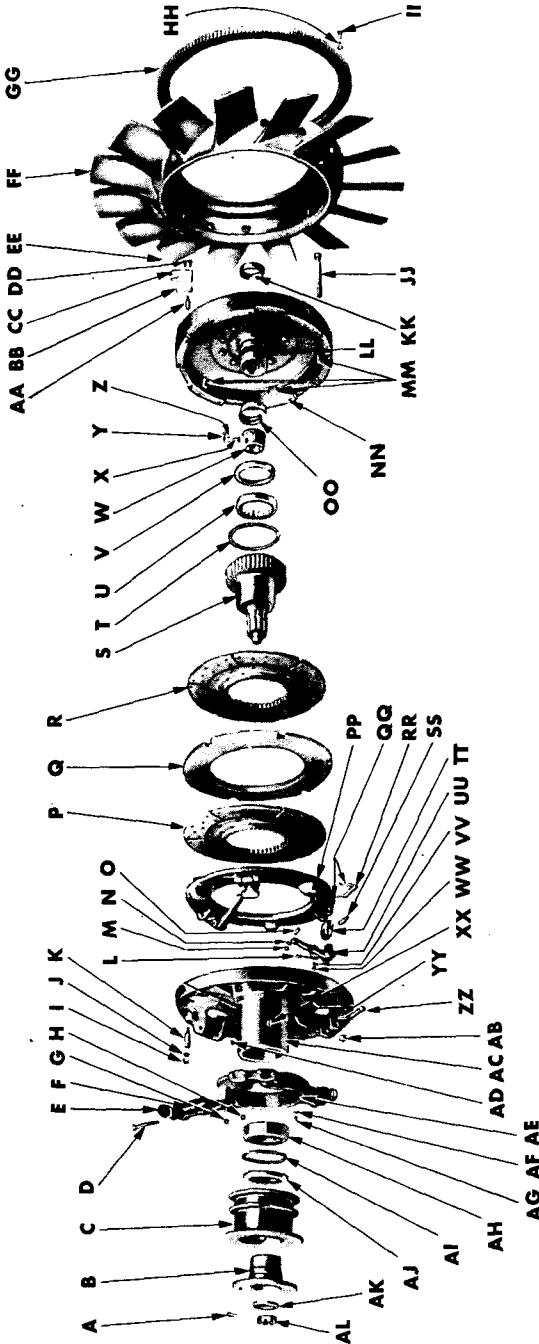
Make	Lip—Rollway and Rockford Drilling Machine Company
Type	Multiple plate, dry
Weight	Approximately 309 lb
O.D. of flywheel	19.495 in.
O.D. of facing	16 in.
I.D. of facing	11½ in.
Width of facing	2¼ in.
Thickness of facing	5/32 in.
Number of pressure springs	6
Free height of springs	Approximately 27/8 in.
Assembled height of spring (at 460—480-lb load)	2 3/16 in.
Total pressure of springs	2,820 lb
Release sleeve load for ½-in. travel	Static 730 lb
Pressure plate release with ½-in. sleeve travel	0.100 in.

**b. Clutch Controls.**

Pedal pull-back spring pressure (at 8 3/4 in. length)	36 lb—44 lb
Pedal over center spring pressure (at 9 1 1/2 in. length)	590 lb



ORDNANCE MAINTENANCE—POWER UNIT ACCESSORIES  
FOR MEDIUM TANKS M3A4 AND M4A4



RA PD 25435

Figure 155—M4A4 Clutch Assembly (Castor Type Throwout Bearing)  
—Exploded View

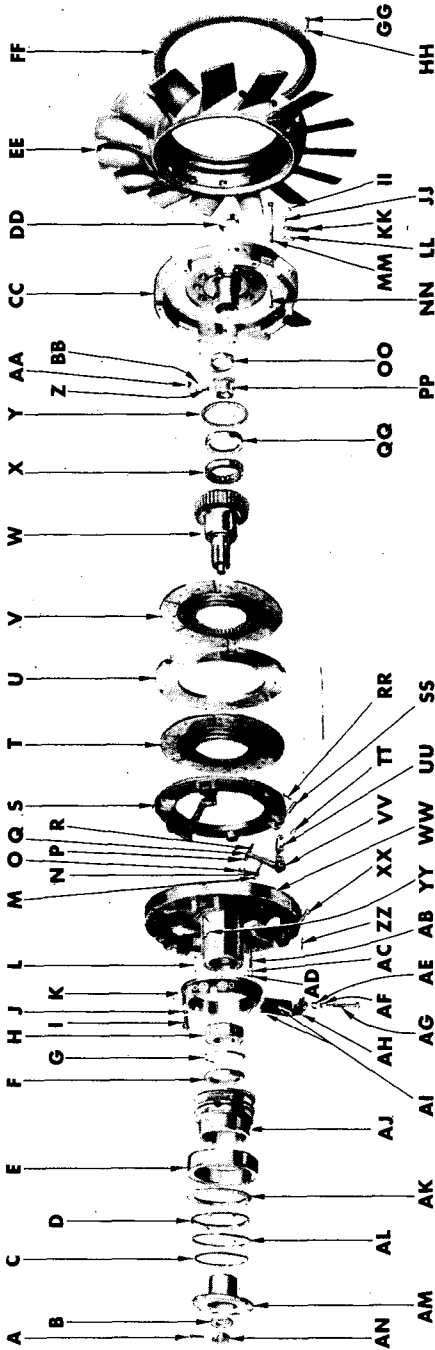
DESCRIPTION OF CLUTCH

- A—PIN, COTTER, MASTER CLUTCH SPINDLE FLANGE NUT
- B—FLANGE, MASTER CLUTCH SPINDLE
- C—SLEEVE, RELEASE, MASTER CLUTCH
- D—BOLT, MASTER CLUTCH PRESSURE SPRING RETAINER
- E—RETAINER, MASTER CLUTCH PRESSURE SPRING
- F—SPRING, PRESSURE, MASTER CLUTCH
- G—NUT, JAM, MASTER CLUTCH PRESSURE SPRING RETAINER BOLT
- H—WASHER, LOCK, MASTER CLUTCH PRESSURE SPRING RETAINER BOLT NUT
- I—NUT, JAM, MASTER CLUTCH PLATE SEPARATOR
- J—WASHER, LOCK, MASTER CLUTCH PLATE SEPARATOR JAM NUT
- K—STUD, SEPARATOR, MASTER CLUTCH PLATE
- L—SPRING, MASTER CLUTCH RELEASE LEVER
- M—NUT, LOCKING, MASTER CLUTCH RELEASE LEVER ADJUSTING SCREW
- N—WASHER, LOCK, MASTER CLUTCH RELEASE LEVER ADJUSTING SCREW
- O—SCREW, ADJUSTING, MASTER CLUTCH RELEASE LEVER
- P—DISC, DRIVEN, MASTER CLUTCH, ASSEMBLY
- Q—PLATE, DRIVING, MASTER CLUTCH
- R—DISC, DRIVEN, MASTER CLUTCH, ASSEMBLY
- S—SPINDLE, MASTER CLUTCH
- T—SLINGER, OIL, MASTER CLUTCH SPINDLE
- U—BEARING, MASTER CLUTCH SPINDLE, REAR
- V—RETAINER, OIL, MASTER CLUTCH SPINDLE, REAR
- W—NUT, MASTER CLUTCH HUB FRONT CONE
- X—PIN, CLEVIS, MASTER CLUTCH HUB FRONT CONE NUT
- Y—PIN, COTTER, MASTER CLUTCH HUB FRONT CONE NUT RETAINER PIN
- Z—WASHER, MASTER CLUTCH HUB FRONT CONE NUT RETAINER PIN
- AA—PIN, SEPARATOR, MASTER CLUTCH PLATE
- BB—SPRING, MASTER CLUTCH PLATE SEPARATOR PIN
- CC—COVER, DUST, MASTER CLUTCH FLYWHEEL
- DD—SCREW, CAP, MASTER CLUTCH PLATE SEPARATOR PIN SPRING
- EE—WIRE, LOCK, MASTER CLUTCH PLATE SEPARATOR SPRING CAP SCREW
- FF—FAN, ASSEMBLY
- GG—GEAR, RING, FAN
- HH—WASHER, LOCK, FAN RING GEAR SCREW
- II—SCREW, FAN RING GEAR
- JJ—BOLT, MASTER CLUTCH FLYWHEEL RING TO FLYWHEEL
- KK—CONE, MASTER CLUTCH HUB, REAR
- LL—HUB, MASTER CLUTCH FLYWHEEL
- MM—PIN, DRIVING, MASTER CLUTCH FLYWHEEL TO PLATE
- NN—FLYWHEEL, MASTER CLUTCH, ASSEMBLY
- OO—CONE, MASTER CLUTCH HUB, FRONT
- PP—PLATE, PRESSURE, MASTER CLUTCH
- QQ—PIN, COTTER, MASTER CLUTCH PRESSURE PLATE TO LINK PIN
- RR—PIN, MASTER CLUTCH PRESSURE PLATE TO LINK
- SS—PIN, MASTER CLUTCH RELEASE LEVER TO LINK
- TT—LINK, RETAINING, MASTER CLUTCH PRESSURE PLATE TO SPRING
- UU—LEVER, RELEASE, MASTER CLUTCH
- VV—WASHER, LOCK, MASTER CLUTCH RELEASE LEVER SPRING SCREW
- WW—SCREW, MASTER CLUTCH RELEASE LEVER SPRING
- XX—KEY, MASTER CLUTCH RELEASE SLEEVE
- YY—PIN, COTTER, MASTER CLUTCH RELEASE LEVER TO FLYWHEEL RING PIN
- ZZ—PIN, MASTER CLUTCH RELEASE LEVER TO FLYWHEEL RING.
- AB—NUT, MASTER CLUTCH FLYWHEEL RING TO FLYWHEEL BOLT
- AC—RING, MASTER CLUTCH FLYWHEEL
- AD—PLUG, PIPE, MASTER CLUTCH FLYWHEEL RING
- AE—CARRIER, MASTER CLUTCH PRESSURE SPRING
- AF—WASHER, LOCK, MASTER CLUTCH PRESSURE SPRING CARRIER SCREW
- AG—SCREW, MASTER CLUTCH PRESSURE SPRING CARRIER
- AH—BEARING, MASTER CLUTCH SPINDLE, FRONT
- AI—RING, LOCK, MASTER CLUTCH SPINDLE BEARING
- AJ—RETAINER, OIL, MASTER CLUTCH SPINDLE, FRONT
- AK—WASHER, MASTER CLUTCH SPINDLE FLANGE NUT
- AL—NUT, MASTER CLUTCH SPINDLE FLANGE

RA PD 25435B

Legend for Figure 155—M4A4 Clutch Assembly (Castor Type Throw-out Bearing)—Exploded View

ORDNANCE MAINTENANCE—POWER UNIT ACCESSORIES  
FOR MEDIUM TANKS M3A4 AND M4A4



RA PD 25613

Figure 156—Parts of M4A4 Clutch Assembly (Coaxial Type  
Throwout Bearing)

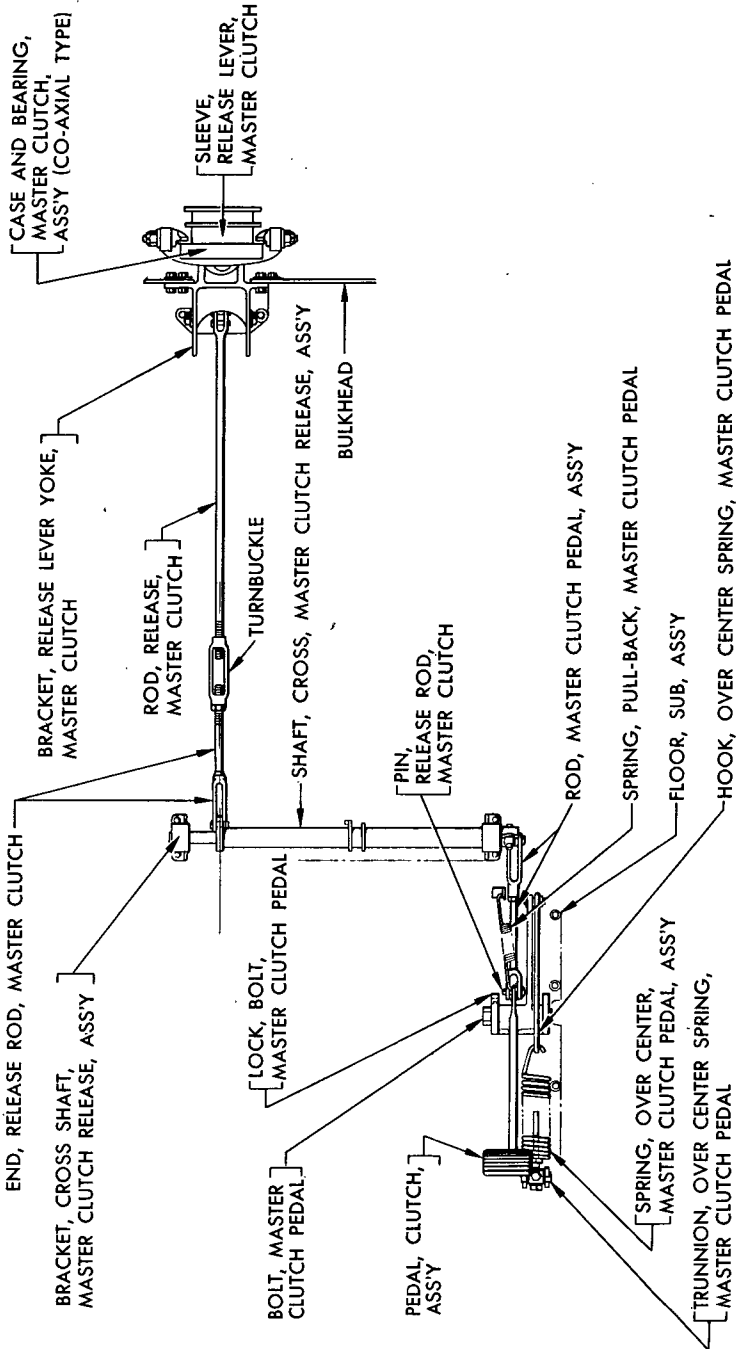
DESCRIPTION OF CLUTCH

- A—PIN, COTTER, MASTER CLUTCH SPINDLE FLANGE NUT
- B—WASHER, MASTER CLUTCH SPINDLE FLANGE NUT
- C—SNAP RING, BEARING, MASTER CLUTCH RELEASE SLEEVE
- D—RETAINER, MASTER CLUTCH RELEASE SLEEVE BEARING
- E—CASE, MASTER CLUTCH, W/BEARING, ASSEMBLY
- F—RETAINER, OIL, MASTER CLUTCH SPINDLE, FRONT
- G—LOCK RING, MASTER CLUTCH SPINDLE BEARING
- H—BEARING, MASTER CLUTCH SPINDLE, FRONT
- I—SCREW, MASTER CLUTCH PRESSURE SPRING CARRIER
- J—WASHER, LOCK, MASTER CLUTCH PRESSURE SPRING CARRIER SCREW
- K—CARRIER, MASTER CLUTCH PRESSURE SPRING
- L—WICK, OIL, MASTER CLUTCH RELEASE SLEEVE
- M—SCREW, MASTER CLUTCH RELEASE LEVER SPRING
- N—WASHER, LOCK, MASTER CLUTCH RELEASE LEVER SPRING SCREW
- O—SPRING, MASTER CLUTCH RELEASE LEVER
- P—NUT, LOCKING, MASTER CLUTCH RELEASE LEVER ADJUSTING SCREW
- Q—WASHER, LOCK, MASTER CLUTCH RELEASE LEVER ADJUSTING SCREW
- R—SCREW, ADJUSTING, MASTER CLUTCH RELEASE LEVER
- S—PLATE, PRESSURE, MASTER CLUTCH
- T—DISC, DRIVEN, MASTER CLUTCH, ASSEMBLY
- U—PLATE, DRIVING, MASTER CLUTCH
- V—DISC, DRIVEN, MASTER CLUTCH, ASSEMBLY
- W—SPINDLE, MASTER CLUTCH
- X—BEARING, MASTER CLUTCH SPINDLE, REAR
- Y—SLINGER, OIL, MASTER CLUTCH SPINDLE
- Z—PIN, MASTER CLUTCH HUB FRONT CONE NUT
- AA—PIN, COTTER, MASTER CLUTCH HUB FRONT CONE NUT RETAINER PIN
- BB—WASHER, MASTER CLUTCH HUB FRONT CONE NUT RETAINER PIN
- CC—FLYWHEEL, MASTER CLUTCH, ASSEMBLY
- DD—CONE, MASTER CLUTCH HUB, REAR
- EE—FAN, ASSEMBLY
- FF—GEAR, RING, FAN
- GG—SCREW, FAN RING GEAR
- HH—WASHER, LOCK, FAN RING GEAR SCREW
- II—WIRE, LOCK, MASTER CLUTCH PLATE SEPARATOR PIN SPRING CAP SCREW
- JJ—SCREW, CAP, MASTER CLUTCH PLATE SEPARATOR PIN SPRING
- KK—SPRING, MASTER CLUTCH PLATE SEPARATOR PIN
- LL—SPACER, SPRING, MASTER CLUTCH PLATE SEPARATOR PIN
- MM—BOLT, MASTER CLUTCH FLYWHEEL RING TO FLYWHEEL
- NN—PIN, SEPARATOR, MASTER CLUTCH PLATE
- OO—CONE, MASTER CLUTCH HUB, FRONT
- PP—NUT, MASTER CLUTCH HUB FRONT CONE
- QQ—RETAINER, OIL, MASTER CLUTCH SPINDLE REAR
- RR—PIN, COTTER, MASTER CLUTCH PRESSURE PLATE TO LINK PIN
- SS—PIN, MASTER CLUTCH PRESSURE PLATE TO LINK
- TT—PIN, MASTER CLUTCH RELEASE LEVER TO LINK
- UU—LINK, MASTER CLUTCH PRESSURE PLATE TO RELEASE LEVER
- VV—LEVER, RELEASE, MASTER CLUTCH
- WW—RING, MASTER CLUTCH FLYWHEEL
- XX—PIN, MASTER CLUTCH RELEASE LEVER TO FLYWHEEL RING
- YY—KEY, MASTER CLUTCH RELEASE SLEEVE
- ZZ—PIN, COTTER, MASTER CLUTCH RELEASE LEVER TO FLYWHEEL RING PIN
- AB—STUD, SEPARATOR, MASTER CLUTCH PLATE
- AC—WASHER, LOCK, MASTER CLUTCH PLATE SEPARATOR STUD JAW NUT
- AD—NUT, JAW, MASTER CLUTCH PLATE SEPARATOR STUD
- AE—NUT, JAW, MASTER CLUTCH PRESSURE SPRING RETAINER BOLT
- AF—WASHER, LOCK, MASTER CLUTCH PRESSURE SPRING RETAINER BOLT JAW NUT
- AG—BOLT, MASTER CLUTCH PRESSURE SPRING RETAINER
- AH—RETAINER, MASTER CLUTCH PRESSURE SPRING
- AI—SPRING, PRESSURE, MASTER CLUTCH
- AJ—BODY, MASTER CLUTCH RELEASE SLEEVE
- AK—SEAL, BEARING, MASTER CLUTCH RELEASE SLEEVE, INNER
- AL—LOCK RING, MASTER CLUTCH RELEASE SLEEVE BEARING
- AM—FLANGE, MASTER CLUTCH SPINDLE
- AN—NUT, MASTER CLUTCH SPINDLE FLANGE

RA PD 25613B

Legend for Figure 156—Parts of M4A4 Clutch Assembly (Coaxial Type Throwout Bearing)

**ORDNANCE MAINTENANCE—POWER UNIT ACCESSORIES  
FOR MEDIUM TANKS M3A4 AND M4A4**



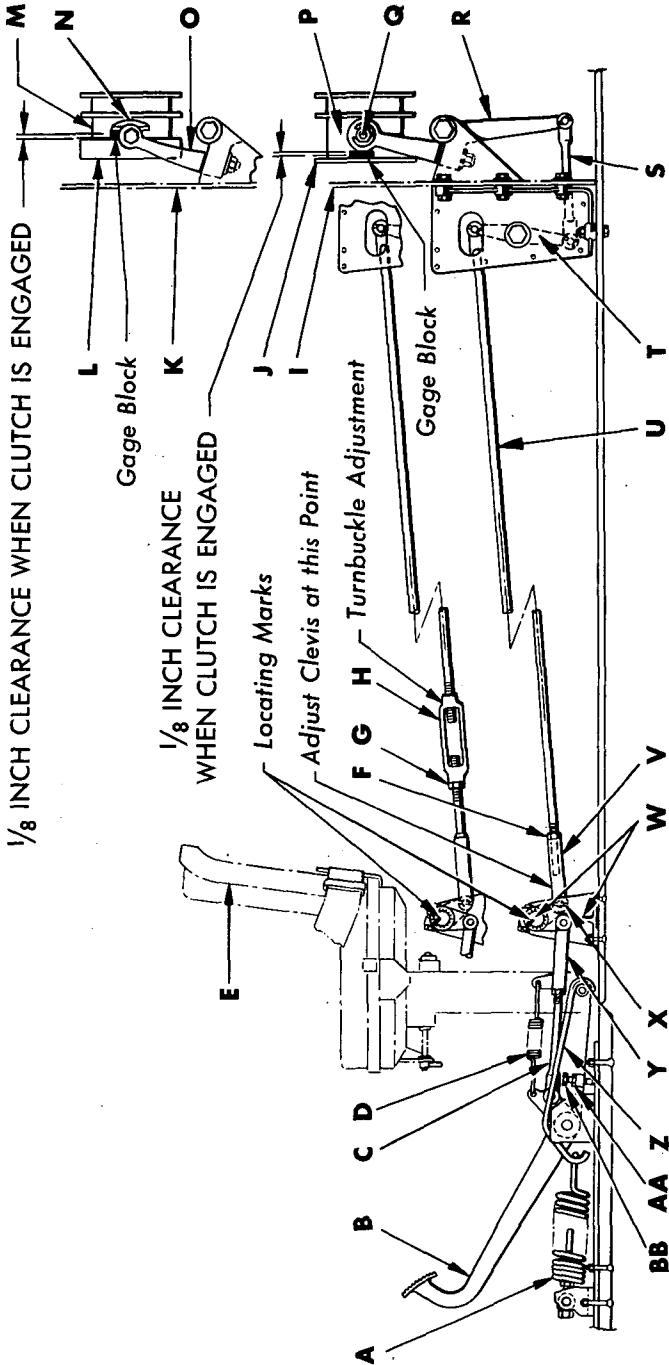
RA PD 25880

**Figure 157—M4A4 Clutch Controls**

## DESCRIPTION OF CLUTCH

- c. Release Lever Yoke Arm Bearing, Large.**  
 Type ..... Needle  
 Torrington Number ..... B-1616-X
- d. Release Lever Yoke Arm Bearing, Small.**  
 Type ..... Needle  
 Torrington Number ..... B-88-X
- e. Release Idler Lever Bearing, Large.**  
 Type ..... Needle  
 Torrington Number ..... B-1616-X
- f. Release Idler Lever Bearing, Small.**  
 Type ..... Needle  
 Torrington Number ..... B-88-X
- g. Pedal Over Center Spring Bracket Sleeve Bearing.**  
 Type ..... Needle  
 Torrington Number ..... M-881-X
- h. Pedal Bearing, Large.**  
 Type ..... Needle  
 Torrington Number ..... B-2016-X
- i. Pedal Bearing, Small.**  
 Type ..... Needle  
 Torrington Number ..... B-88-X
- j. Release Cross Shaft Bearing.**  
 Type ..... Needle  
 Torrington Number ..... B-88-X
- k. Release Cross Shaft Bracket Bearing.**  
 Type ..... Needle  
 Torrington Number ..... RB-2732
- l. Release Cross Shaft Left Lever Bearing.**  
 Type ..... Needle  
 Torrington Number ..... B-88-X
- m. Spindle Front Bearing.**  
 Type ..... Ball  
 New Departure Number ..... 5213
- n. Spindle Rear Bearing.**  
 Type ..... Roller  
 Hyatt Number ..... 1215-TS
- o. Thowout Bearing.**  
 Type ..... Ball  
 Marlin-Rockwell Number M.R.C., 305, MFF4 or equivalent N.D. bearing
- p. Release Sleeve Bearing.**  
 Type (up to, and including, power units M4A4-6983) ..... Castor type  
 Type (power units M4A4-6984, and above) ..... Coaxial type

ORDNANCE MAINTENANCE—POWER UNIT ACCESSORIES  
FOR MEDIUM TANKS M3A4 AND M4A4



RA PD 25879

Figure 158—M4A4 Clutch Controls

DESCRIPTION OF CLUTCH

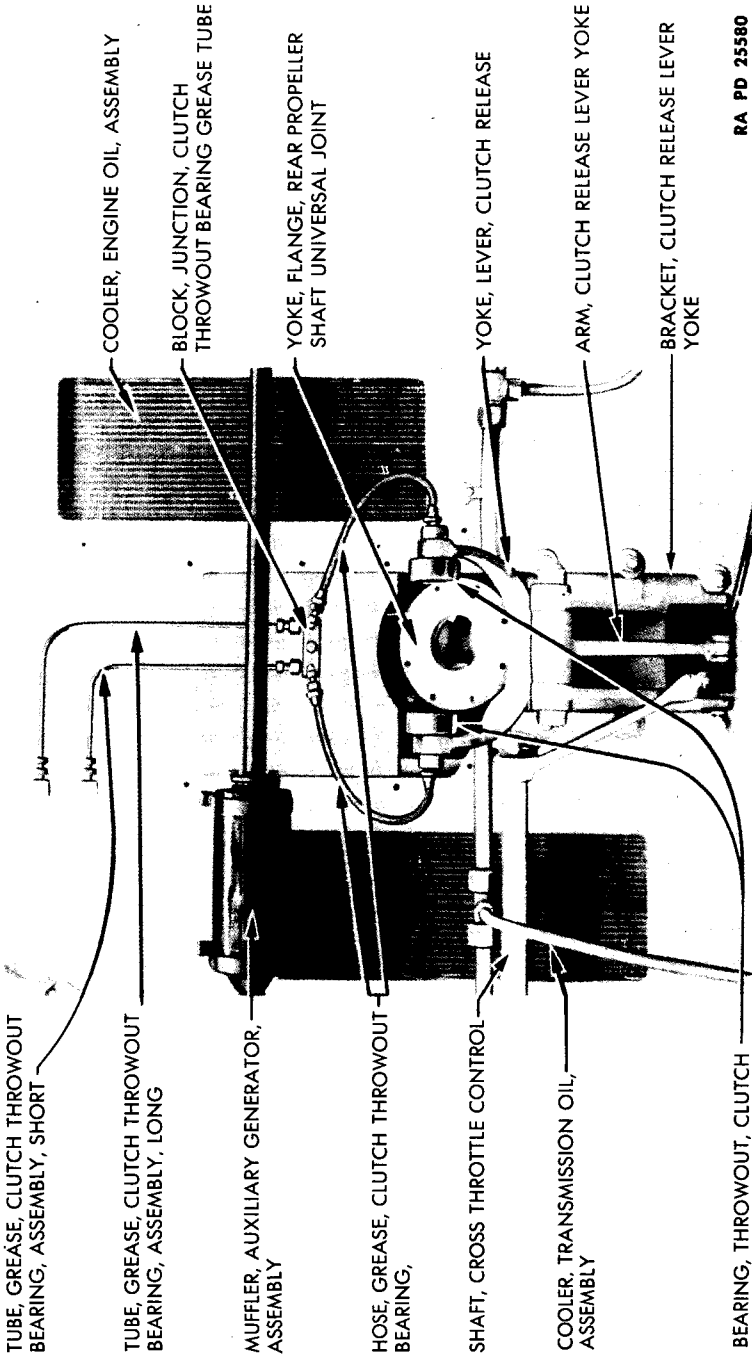
- |          |  |           |  |
|----------|--|-----------|--|
| <b>A</b> | <b>SPRING, CLUTCH PEDAL OVERCENTER, ASSEMBLY</b>             | <b>O</b>  | <b>YOKE, CLUTCH RELEASE LEVER</b>                      |
| <b>B</b> | <b>PEDAL, CLUTCH, ASSEMBLY</b>                               | <b>P</b>  | <b>SLEEVE, RELEASE, MASTER CLUTCH</b>                  |
| <b>C</b> | <b>ROD, CLUTCH PEDAL, ASSEMBLY</b>                           | <b>Q</b>  | <b>BEARING, BALL, CLUTCH THROWOUT</b>                  |
| <b>D</b> | <b>SPRING, CLUTCH PEDAL PULL BACK</b>                        | <b>R</b>  | <b>LEVER, CLUTCH RELEASE, ASSEMBLY</b>                 |
| <b>E</b> | <b>SEAT, DRIVER, ASSEMBLY</b>                                | <b>S</b>  | <b>LINK, CLUTCH RELEASE LEVER, ASSEMBLY</b>            |
| <b>F</b> | <b>NUT, CLUTCH RELEASE ROD</b>                               | <b>T</b>  | <b>LEVER, CLUTCH RELEASE IDLER, ASSEMBLY</b>           |
| <b>G</b> | <b>NUT, LOCK, CLUTCH RELEASE ROD TURNBUCKLE</b>              | <b>U</b>  | <b>ROD, CLUTCH RELEASE, ASSEMBLY</b>                   |
| <b>H</b> | <b>TURNBUCKLE, CLUTCH RELEASE ROD</b>                        | <b>V</b>  | <b>CLEVIS, CLUTCH RELEASE ROD</b>                      |
| <b>I</b> | <b>BULKHEAD</b>  | <b>W</b>  | <b>SHAFT, CLUTCH RELEASE CROSS, W/BACKET, ASSEMBLY</b> |
| <b>J</b> | <b>FLANGE, MASTER CLUTCH RELEASE SLEEVE</b>                  | <b>X</b>  | <b>PIN, CLEVIS, CLUTCH RELEASE ROD</b>                 |
| <b>K</b> | <b>BULKHEAD</b>  | <b>Y</b>  | <b>CLEVIS, CLUTCH PEDAL ROD</b>                        |
| <b>L</b> | <b>BEARING, MASTER CLUTCH RELEASE SLEEVE (CO-AXIAL TYPE)</b> | <b>Z</b>  | <b>HOOK, CLUTCH PEDAL OVERCENTER SPRING</b>            |
| <b>M</b> | <b>SLEEVE, RELEASE, MASTER CLUTCH</b>                        | <b>AA</b> | <b>NUT, JAM, CLUTCH PEDAL STOP SCREW</b>               |
| <b>N</b> | <b>SHOE, MASTER CLUTCH RELEASE SLEEVE BEARING</b>            | <b>BB</b> | <b>SCREW, STOP, CLUTCH PEDAL</b>                       |

RA PD 258798

Legend for Figure 158—M4A4 Clutch Controls



ORDNANCE MAINTENANCE - POWER UNIT ACCESSORIES  
FOR MEDIUM TANKS M3A4 AND M4A4



RA PD 25580

Figure 159 - Clutch Grease Tubes

**DESCRIPTION OF CLUTCH**

**68. SECOND ECHELON OPERATIONS.**

a. In view of the fact that many second echelon operations are often performed by ordnance maintenance personnel, the information is not repeated in this manual. Therefore, ordnance maintenance personnel should refer to TM 9-754, January 21, 1943, for this information.

**69. ECHELON BREAK-DOWN OF MAINTENANCE.**

a. Refer to paragraph 4.

ORDNANCE MAINTENANCE—POWER UNIT ACCESSORIES  
FOR MEDIUM TANKS M3A4 AND M4A4

CHAPTER 5

CLUTCH (MODEL M4A4)—(Cont'd)

Section II

TROUBLE SHOOTING

	Paragraph
Trouble shooting .....	70

70. TROUBLE SHOOTING.

a. Clutch Drags.

Possible Cause	Possible Remedy
Excessive backlash.	Adjust clutch pedal, TM 9-754, January 21, 1943 (par. 95 b and c).
Incorrect plate separator clearance.	Correct, TM 9-754, January 21, 1943 (par. 94 a (12)).
Warped driven plate.	Replace, TM 9-754, January 21, 1943 (pars. 93 b (4) and 94 a (8), (9) and (10)).
Metal transfer or bonding of clutch facings.	Replace damaged parts (pars. 72 c and 74 c and d) and TM 9-754, January 21, 1943 (pars. 93 b and 94 a).
Brinnelling of drive spline.	Replace clutch spindle, TM 9-754, January 21, 1943 (pars. 93 b (5) and 94 a (7)).
Excessive dirt in clutch assembly.	Disassemble clutch, clean and reassemble, TM 9-754, January 21, 1943 (pars. 93 and 94).

b. Clutch Slips.

Items included under subparagraph a, above.	See subparagraph a, above.
Improper adjustment of pedal or release levers or arms.	Check pedal and release lever or arm adjustment. Adjust where necessary (par. 74 g and h) and TM 9-754, January 21, 1943 (pars. 95 b and c).
Loss of spring load due to excessive heat.	Replace springs (pars. 72 d and e and 74 a and g).

**TROUBLE SHOOTING**

**Possible Cause**

**Possible Remedy**

Binding of clutch center plate and driven plates due to dirt or brinnelling.

Disassemble and clean clutch or replace damaged parts (par. 73 a) and TM 9-754, January 21, 1943 (pars. 93 and 94).

Clutch facing worn.

Replace driven plates, TM 9-754, January 21, 1943 (pars. 93 b (4) and 94 a (8), (9) and (10)).

**c. Complete Failure of Clutch to Engage or Release.**

Disconnected clutch linkage or binding or linkage or clutch parts.

Inspect linkage and clutch. Replace or connect linkage parts or replace necessary clutch parts, TM 9-754, January 21, 1943 (pars. 93, 94, and 95 b and c).

ORDNANCE MAINTENANCE—POWER UNIT ACCESSORIES  
FOR MEDIUM TANKS M3A4 AND M4A4

CHAPTER 5

CLUTCH (MODEL M4A4)—(Cont'd)

Section III

DISASSEMBLY

	Paragraph
Removal from vehicle . . . . .	71
Disassembly of clutch pressure plate and flywheel ring . . . . .	72

71. REMOVAL FROM VEHICLE.

a. Refer to TM 9-754, January 21, 1943 (par. 93) for removal procedure.

72. DISASSEMBLY OF CLUTCH PRESSURE PLATE AND FLY-WHEEL RING.

DRIFT, 6-in.	SCREWDRIVER
HAMMER, steel	WOOD BLOCK, 1- x 1- x 1¼-in. (2)
HANDLE, speed	WOOD BLOCK, 2- x 4- x 6-in. (3)
PLIERS, adjustable	WRENCH, open-end, 9/16-in.
PLIERS, side cutting	WRENCH, open-end, 1½/16-in.
PULLER, clutch release sleeve bearing	WRENCH, socket, ½-in.
PULLER, MTM A4-35	
PUNCH, prick	

a. Remove Clutch Release Lever Springs.

SCREWDRIVER

Cover bench with clean rags to keep surface of pressure plate free from dirt. Place pressure plate and flywheel ring assembly on bench (with pressure plate down) and remove screws which secure springs to levers with screwdriver (fig. 177).

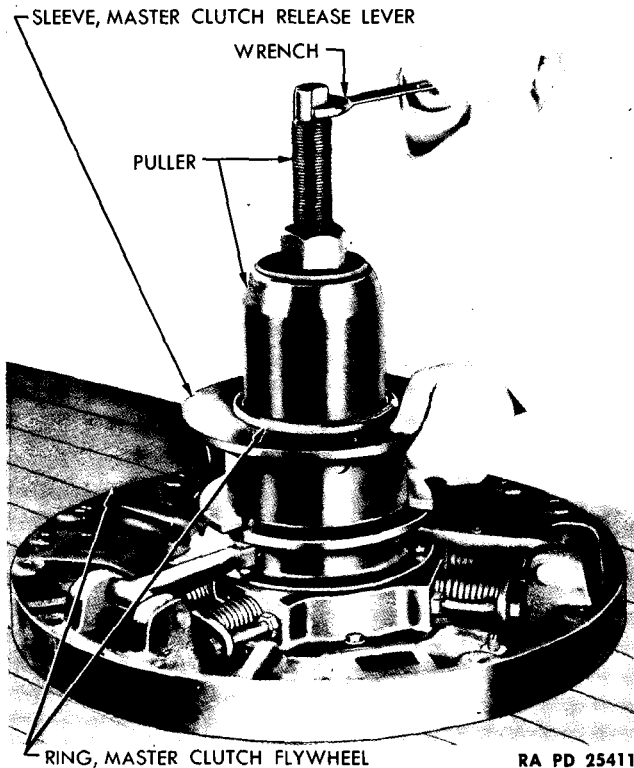
b. Remove Clutch Spindle Front Bearing (fig. 160).

PULLER, MTM A4-35

SCREWDRIVER

Remove clutch spindle front oil retainer with puller MTM A4-35. Remove clutch spindle front bearing lock ring by prying one end of lock ring out of the groove in the clutch flywheel ring with a screwdriver and pulling lock ring out of flywheel ring. Remove clutch spindle front bearing with puller MTM A4-35.

DISASSEMBLY



**Figure 160—Clutch Spindle Front Bearing Removal**

**c. Remove Clutch Release Levers.**

DRIFT, 6-in.

HAMMER

PUNCH, prick

SCREWDRIVER

WOOD BLOCK, 1- x 1- x  
1¼-in. (3)

WOOD BLOCK, 2- x 4- x  
5-in. (2)

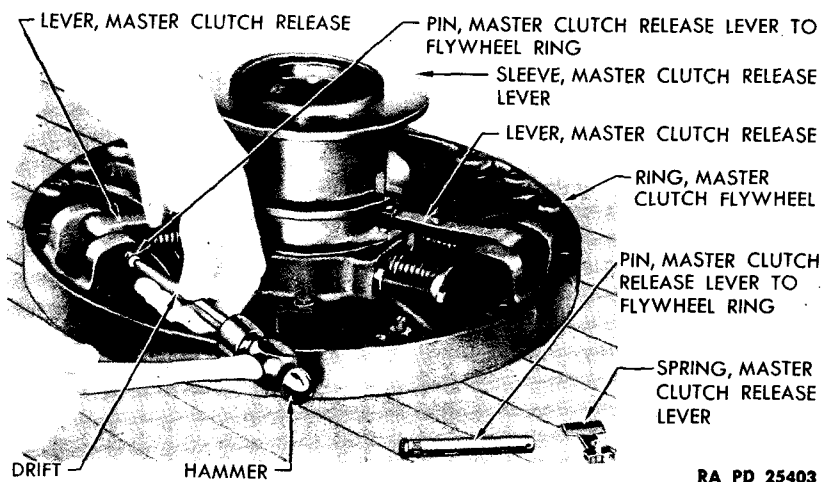
WRENCH, open-end, ⅝-in.

WRENCH, open-end, 1⅛-in.

(1) Select one of the clutch release levers and mark with one prick punch mark, also marking clutch pressure spring retainer and clutch spring carrier, at this same location, with one punch mark. Repeat operation to mark the other two release levers, for identification purposes.

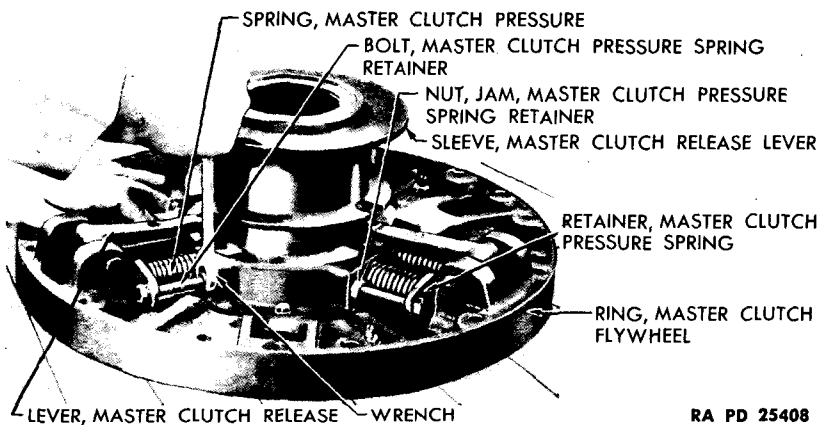
(2) Place three wood blocks, 1 inch x 1 inch x 1¼ inches in the space between flanges on release sleeve, in which the release levers fit, in such position that blocks will support sleeve. Hold each clutch pressure spring retainer bolt with a ⅝-inch open-end wrench and loosen each jam nut

**ORDNANCE MAINTENANCE—POWER UNIT ACCESSORIES  
FOR MEDIUM TANKS M3A4 AND M4A4**



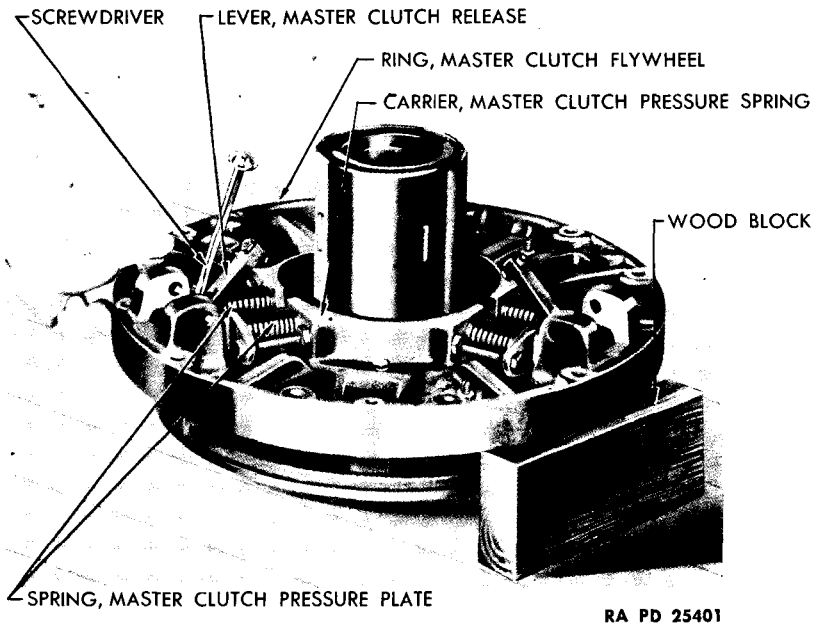
**Figure 161—Release Lever Pin Removal**

with an  $1\frac{1}{16}$ -inch open-end wrench (fig. 178). Back off each jam nut to the end of the bolt threads (fig. 162). Tighten each pair of pressure spring retainer bolts evenly, as much as possible, with a  $\frac{1}{16}$ -inch open-end wrench to compress the pressure springs (fig. 177). Remove the cotter pin from each release lever pin with side cutting pliers and drive



**Figure 162—Loosening Spring Retainer Bolt Jam Nut**

**DISASSEMBLY**



**Figure 163—Removing Pressure Plate from Flywheel Ring**

each pin out with a drift and a steel hammer (fig. 161). **NOTE:** These pins are serrated near head of pin and will be difficult to drive out until serrated sections are clear. Raise the clutch flywheel ring and place two wood blocks under the ring (fig. 163). Pry the clutch release lever to link pins away from the pressure spring retainer with a screwdriver (fig. 163), and work the clutch release levers down through the clutch flywheel ring, allowing the pressure plate to drop (fig. 164). Mark the clutch pressure plate with prick punch marks that correspond to the marks on each release lever. Drive out the clutch release lever to link pins with a 6-inch drift and a steel hammer and remove the release lever from the pressure plate (fig. 171).

**d. Remove the Clutch Pressure Spring Carrier from Flywheel Ring.**

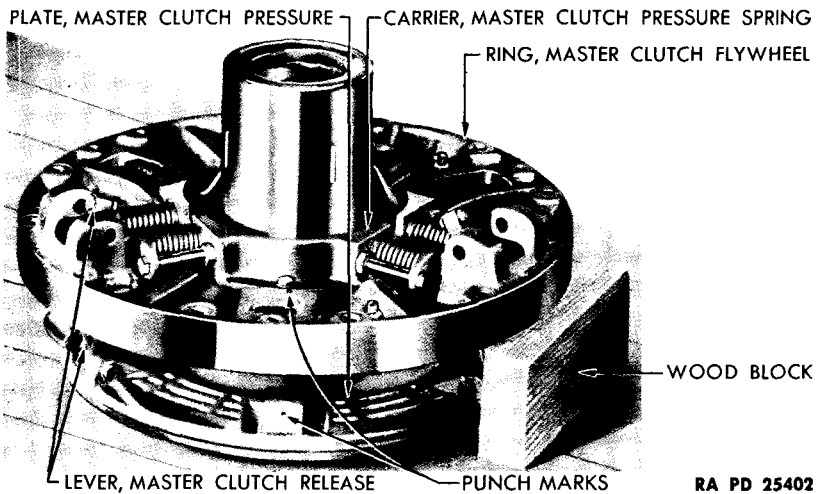
**HANDLE**, speed

**WRENCH**, socket, 1/2-in.

Remove the clutch release sleeve (fig. 176). Remove the three wood blocks which were placed between flanges of the clutch release sleeve for disassembly purposes. Remove the six clutch pressure spring carrier cap screws with a 1/2-inch socket wrench and a speed handle (fig. 169). Mark the master clutch spring retainers with prick punch, for identification when reassembling, and remove carrier (fig. 168).



**ORDNANCE MAINTENANCE—POWER UNIT ACCESSORIES  
FOR MEDIUM TANKS M3A4 AND M4A4**



**Figure 164—Pressure Plate Removed from Flywheel Ring**

e. Remove the Clutch Pressure Spring Retainers from the Carrier (fig. 167).

WRENCH, open-end,  $\frac{9}{16}$ -in.

Mark the clutch release spring carrier with prick punch, for identification. Loosen the clutch pressure spring retainer bolts evenly with a  $\frac{9}{16}$ -inch open-end wrench and remove the bolts, retainers, springs, jam nuts and lock washers.

f. Remove the Clutch Pressure-Plate-to-Release-Lever Link (fig. 170).

PLIERS, side cutting

Remove the cotter pins from the clutch pressure-plate-to-spring-retainer link pins with side cutting pliers and remove the pins and links.

g. Remove Clutch Throwout Bearing from Release Sleeve (Coaxial Type Bearing Only) (fig. 165).

PLIERS, adjustable

VICE

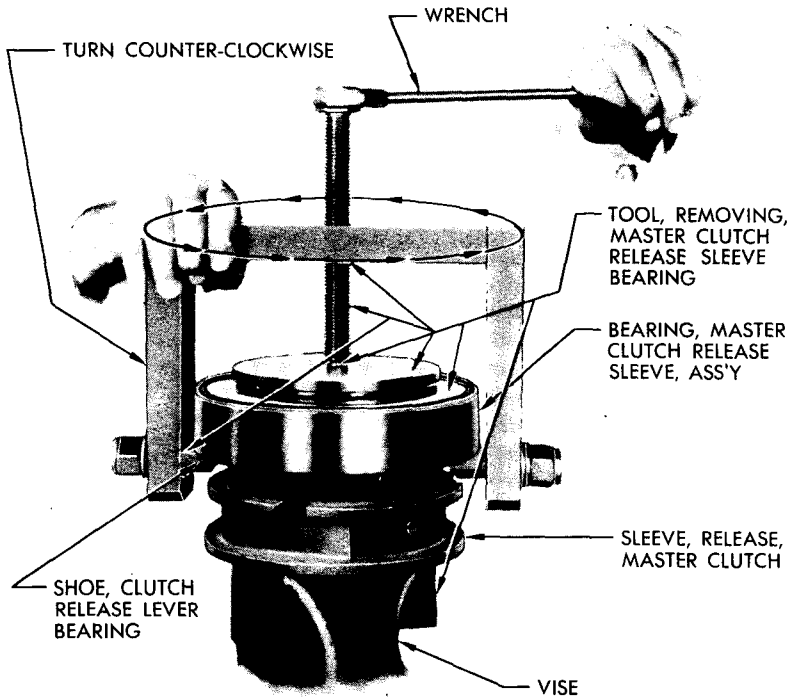
SCREWDRIVER

WRENCH, open-end,  $1\frac{1}{8}$ -in.

TOOL, removing, clutch throwout bearing

Bend up the eight tabs on the clutch release sleeve bearing retainer with pliers. Remove the release bearing snap ring lock from over the snap ring with the fingers. Pry up one end of the snap ring with a screwdriver and remove the snap ring from the clutch release sleeve. Remove

**DISASSEMBLY**



RA PD 25271

**Figure 165—Clutch Release Sleeve Bearing Removal**

the release sleeve bearing retainer and the inner seal with the fingers. Place the base of the removing tool (fig. 166) in a vise. Slide the clutch release sleeve and bearing assembly over the tubular part of the tool, aligning the two keyways in the sleeve with the two keys on the tool. Place the round plate on the sleeve and assemble the puller of the tool in position with the  $\frac{7}{16}$ -inch diameter ball bearing resting in the depression in the plate and the recess in the puller screw over the ball bearing. Make certain that the shoes of the puller are tightened securely to the puller frame. Hold the puller screw steady with an open-end wrench and turn the puller counterclockwise as shown in figure 165.

**h. Remove Clutch Spindle Oil Slinger.**

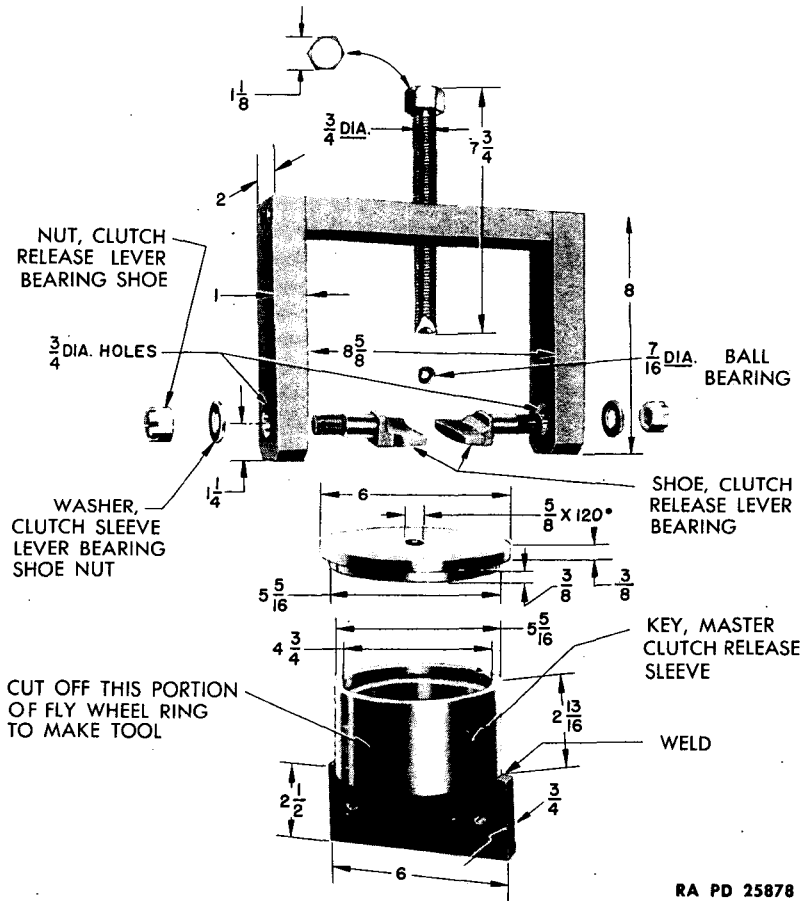
DRIFT

WISE

HAMMER

**NOTE:** Do not remove the clutch spindle oil slinger unless damaged. Place the spindle in a vise and drive the oil slinger off the large end of the spindle with a drift and hammer.

ORDNANCE MAINTENANCE—POWER UNIT ACCESSORIES  
FOR MEDIUM TANKS M3A4 AND M4A4



RA PD 25878

**Figure 166—Clutch Sleeve Bearing Removing Tool**

**i. Remove Clutch Spindle Rear Bearing and Oil Seal.**

**PULLER, bearing**

Place the bearing puller in position with the hooks of the puller behind the outer race of the bearing, and pull the rear bearing and the oil seal out of the spindle.

CHAPTER 5  
CLUTCH (MODEL M4A4)—(Cont'd)

Section IV  
INSPECTION OF PARTS

	Paragraph
Inspection of parts.....	73

**73. INSPECTION OF PARTS (M4A4).**

**FILE**, mill, fine **PAN**, for cleaning parts

**FIXTURE**, spring testing, Federal Stock No. 17-T-1600

**a. Clean Parts for Inspection.**

**PAN**, for cleaning parts

Wash all parts thoroughly, with **SOLVENT**, dry-cleaning, to remove all foreign matter.

**b. Inspect Flywheel Ring.**

Inspect surface of ring for cracks. Inspect all threaded openings for damage to threads. Inspect release sleeve surface for any nicks or irregularities which will restrict travel of sleeve. Inspect clutch release sleeve keys and keyways in sleeve for damage. Inspect release lever-to-flywheel ring pins for wear and inspect openings for pins in flywheel ring for any indication of scores. Inspect bearing bore and oil retainer bore in ring for scores or other damage. Inspect spindle front bearing for roughness in races and any irregularities on exterior of bearing.

**c. Inspect Pressure Spring Carrier.**

**FIXTURE**, spring testing, Federal Stock No. 17-T-1600

Inspect carefully for cracks. Inspect threaded openings, to be sure threads are not damaged. Using spring testing fixture, test pressure of springs by compressing to  $2\frac{3}{16}$  inches. Pressure at this height should be 460—480 pounds. Inspect the three clutch spring retainers for cracks or any indication of failure. Inspect spring retainer bolts and jam nuts for condition of threads, replacing with new any parts on which threads are damaged.

**d. Inspect Pressure Plate.**

Inspect carefully for cracks or any indication of failure. Inspect surface which contacts clutch facing for any nicks or irregularities which might not permit good contact with facing. Inspect release levers, links and pins for cracks, wear or any indication of failure and inspect pressure plate to link pins for wear.

**e. Inspect Driven Disks.**

**FILE**, mill, fine

Remove all foreign matter from surfaces of facing with fine emery

**ORDNANCE MAINTENANCE—POWER UNIT ACCESSORIES  
FOR MEDIUM TANKS M3A4 AND M4A4**

cloth or a fine mill file. Inspect facings for excessive wear. If facings are worn to a point where rivets are approximately even with surface of facing, replace disk. Inspect for loose rivets, where disk is riveted to hub. Inspect splined surfaces in hub of disk for scores.

**f. Inspect Driving Plate.**

Inspect plate carefully for any cracks. Inspect surfaces which contact facings for any rough spots or irregularities which will not permit a good contact between plate and facing. Inspect condition of slots in outer periphery of plate for scores and for clearance between slots and driving lugs. **NOTE:** The intermediate plate must drive through all six flywheel lugs to assure even load distribution. File driven side of slot in driving disk if necessary so that the driving side of all six flywheel lugs contact driven side of corresponding intermediate plate slots simultaneously. Driving plate must slide freely on flywheel lugs. Check for side clearance between flywheel lugs and intermediate plate slots. Slot clearance for the cored driving plate should be 0.008- to 0.010-inch minimum and for the solid driving plate, slot clearance should be 0.012 to 0.018 inch. File slots in driving plate if necessary to attain proper clearance.

**g. Inspect Spindle.**

**FILE**, mill, fine

With bearing and oil retainer removed, inspect both bores, to be sure they are free from scores. Inspect teeth on large diameter of spindle for any signs of brinnelling. If brinnelled to a point where movement of disks will be restricted, replace spindle. Inspect splines for nicks and, if nicked, remove with fine file. Inspect threads for damage. Inspect bearing for roughness or flat spots in races.

**h. Inspect Flywheel.**

Inspect carefully for cracks in both flywheel and hub. Inspect for loose rivets. Inspect splines inside hub, to be sure splines are free from nicks and are not scored. Inspect surface of flywheel which contacts clutch facing, to be sure this surface is free from any rough spots or irregularities which will not permit good contact with facing. Inspect chamfers, at each end of hub, for rough or flat spots, which would indicate that flywheel has been loose on shaft.

**i. Inspect Fan and Fan Ring Gear.**

Inspect fan blades carefully for cracks or any indication of interference. Inspect threads in openings for damage and for cracks around openings. Tighten balance weights inside fan hub, if loose. Inspect teeth on fan ring gear for any indication of interference or for improper meshing of starter gear. Inspect gear carefully for cracks.

CHAPTER 5  
CLUTCH (MODEL M4A4)—(Cont'd)

Section V  
ASSEMBLY

	Paragraph
Assembly of clutch pressure plate and flywheel ring . . . . .	74
Installation in vehicle . . . . .	75

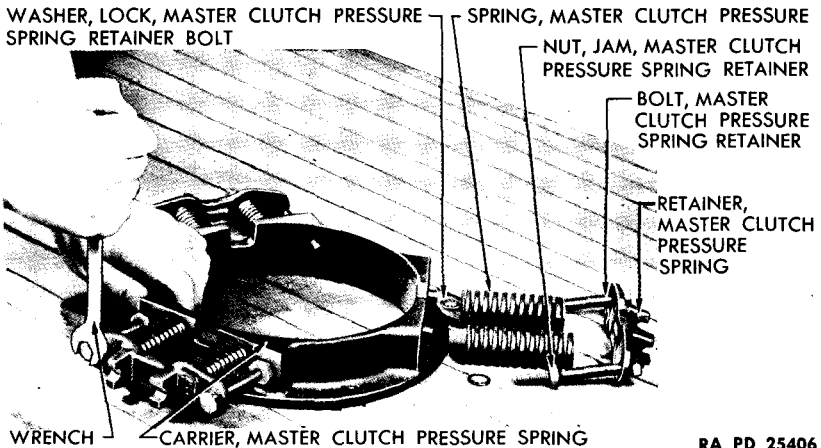
**74. ASSEMBLY OF CLUTCH PRESSURE PLATE AND FLYWHEEL RING.**

- |                      |                                  |
|----------------------|----------------------------------|
| DRIVER, bearing      | WOOD BLOCK, 1- x 1- x 1¼-in. (3) |
| DRIVER, oil retainer | WOOD BLOCK, 1- x 2- x 4-in. (2)  |
| HAMMER, steel        | WRENCH, open-end, 9/16-in.       |
| HANDLE, speed        | WRENCH, open-end, 1 1/16-in.     |
| PLIERS, side cutting | WRENCH, socket, 1/2-in.          |
| PRESS                |                                  |
| SCREWDRIVER          |                                  |

**a. Assemble the Clutch Pressure Spring Carrier Assembly.**

- |                            |                              |
|----------------------------|------------------------------|
| WRENCH, open-end, 9/16-in. | WRENCH, open-end, 1 1/16-in. |
|----------------------------|------------------------------|

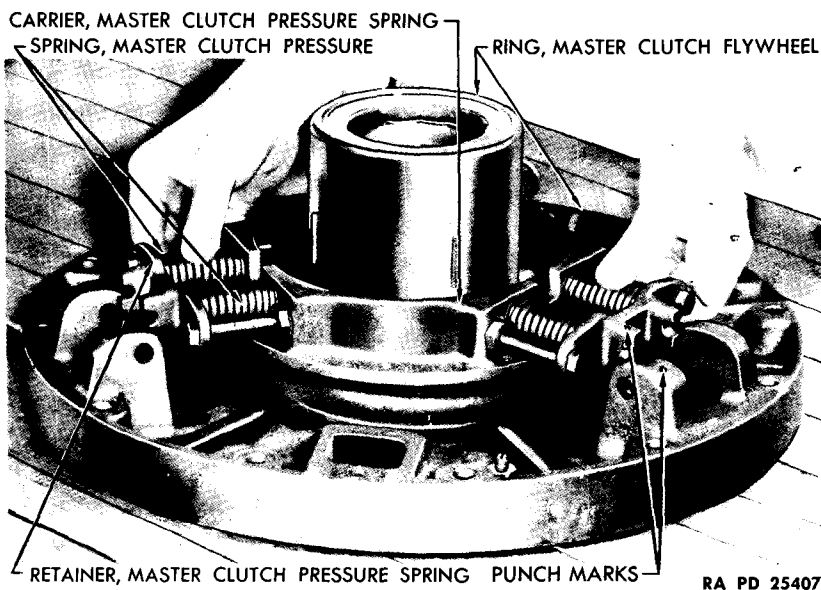
Insert two clutch pressure spring retainer bolts through the holes in one of the retainers, screw two jam nuts onto the bolts and slide two lock washers over the bolts. Place springs in position and screw the two bolts into one pair of holes in the clutch pressure spring carrier with the fingers (fig. 167). Hold each pressure-spring-retainer bolt with a 9/16-



RA PD 25406

**Figure 167—Pressure Spring Carrier Assembly**

**ORDNANCE MAINTENANCE—POWER UNIT ACCESSORIES  
FOR MEDIUM TANKS M3A4 AND M4A4**



**Figure 168—Pressure Spring Carrier Installation**

inch open-end wrench and screw the jam nuts back on the bolts with an  $1\frac{1}{16}$ -inch open-end wrench until the jam nuts reach the ends of the bolt threads (fig. 178). Tighten the pressure-spring-retainer bolts evenly as much as possible, with a  $\frac{9}{16}$ -inch wrench to compress the pressure springs (fig. 167). Repeat the above operations on the other two retainers.

**b. Install the Clutch Pressure Spring Carrier on the Clutch Flywheel Ring.**

**HANDLE**, speed

**WRENCH**, socket,  $\frac{1}{2}$ -in.

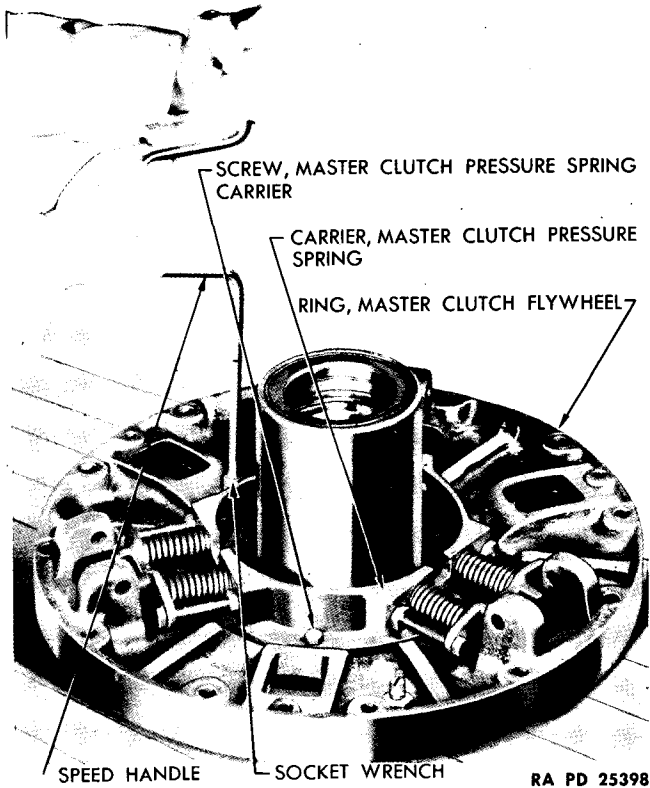
Place the clutch pressure spring carrier assembly in position on the clutch flywheel ring (fig. 168) and fasten the carrier to the ring with six cap screws and lock washers. Tighten the cap screws securely with a  $\frac{1}{2}$ -inch socket wrench (fig. 169).

**c. Install the Clutch Pressure Plate to Spring Retainer Links (fig. 170).**

**PLIERS**, side cutting

Place clean rags on the bench to protect the surface of the pressure plate from dirt. Align the hole in the solid end of the link with the two holes in the pressure plate, and insert the link pin through the hole. Insert

## ASSEMBLY



**Figure 169—Pressure Spring Carrier Screws Removal or Installation**

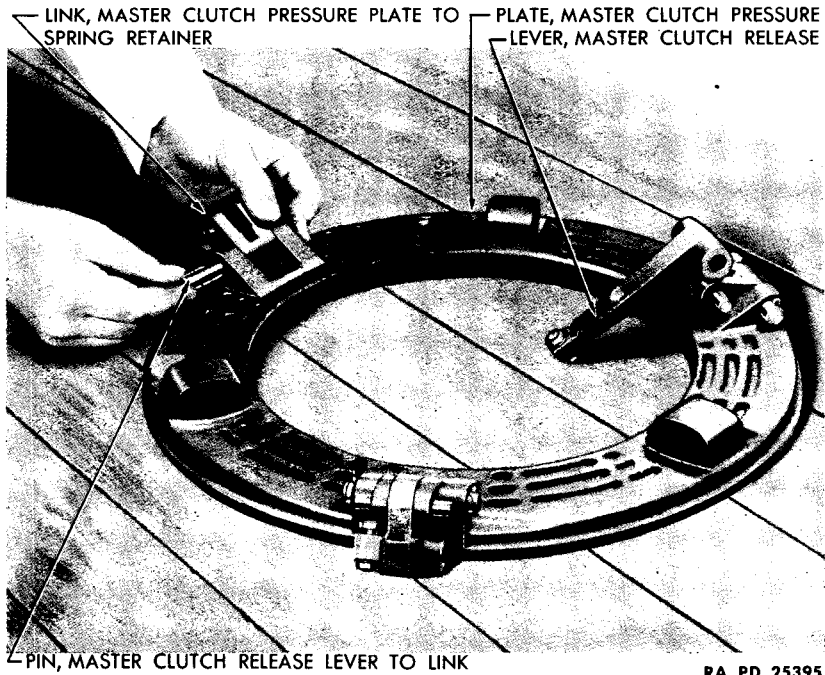
a cotter pin through the hole in each end of the link pin and turn down the ends of the cotter pin with side cutting pliers.

**d. Attach the Clutch Release Levers to the Spring Retainer Links (fig. 171).**

Select the release lever that has one prick punch mark and place it in position in the link at the location of the pressure plate that has one prick punch mark. Aline the hole in the release lever with the holes in the link, and insert the release lever to link pin through the holes. Repeat the above operation with the other two levers, selecting in each instance the lever with marks that match the marks on the pressure plate. Place the flywheel ring on the bench with the sleeve down. Hold the pressure plate in position, matching the prick punch marks on the clutch flywheel ring with those on the clutch release levers and pressure plate, and insert the ends of the clutch release levers through the holes in the flywheel



**ORDNANCE MAINTENANCE—POWER UNIT ACCESSORIES  
FOR MEDIUM TANKS M3A4 AND M4A4**



RA PD 25395

**Figure 170—Pressure Plate to Link Pins Removal or Installation**

ring (fig. 172). Drive three wooden tapered wedges between pressure plate and flywheel ring to aline holes in release levers and flywheel ring (fig. 173), and insert pins through levers and holes in flywheel ring (only far enough to hold pressure plate to flywheel ring to permit turning assembly on bench) (fig. 174).

**e. Install Clutch Release Sleeve Bearing (Coaxial Type) (fig. 175).**

**DRIFT**

**STEEL PLATE, 1/4- x 8-in. sq**

**HAMMER**

**TOOL, installing, master clutch**

**PRESS**

**release sleeve bearing**

Place the clutch release sleeve on a press with the bearing end up. Place the bearing in position on the sleeve and place the installing tool on top of the inner race of the bearing. Place the steel plate on the installing tool and press the bearing into place until it seats firmly against the flange of the sleeve. Install inner seal and bearing retainer on sleeve. Install snap ring in groove in sleeve and install snap ring lock. Bend the

ASSEMBLY

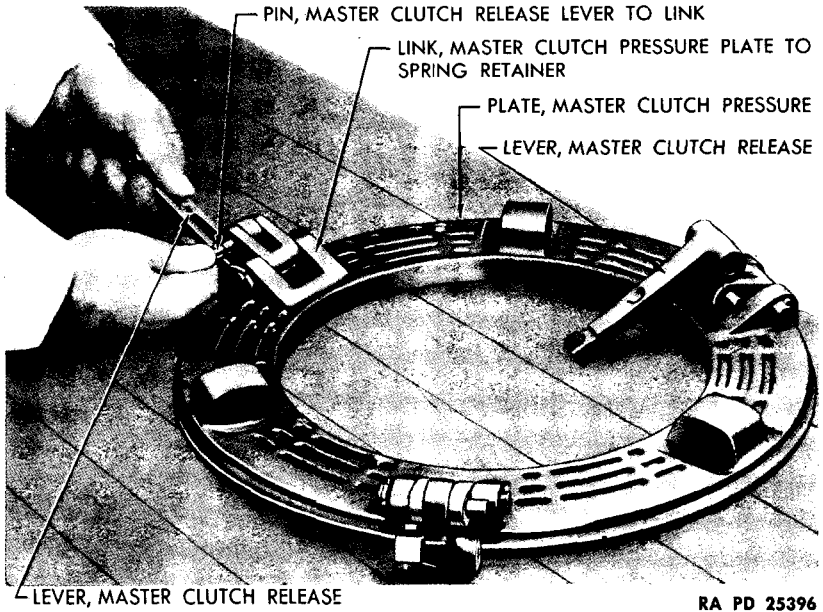


Figure 171—Release Lever to Link Pins Removal or Installation

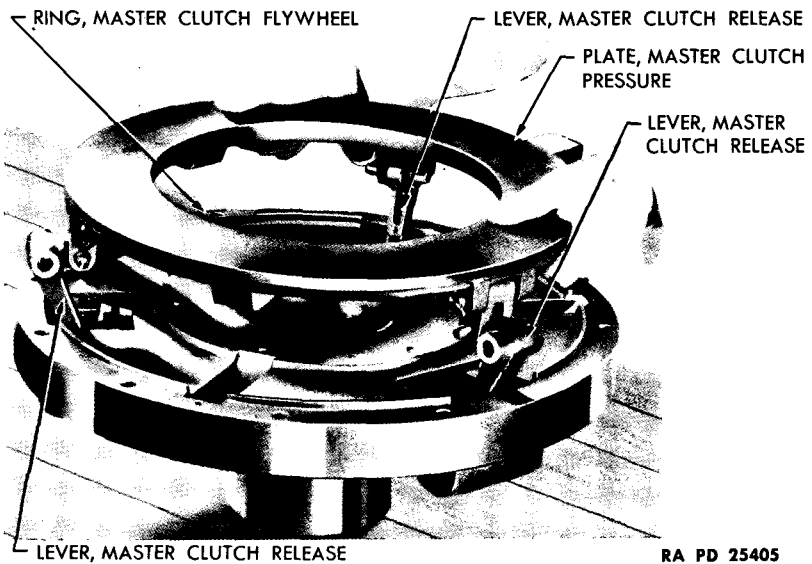
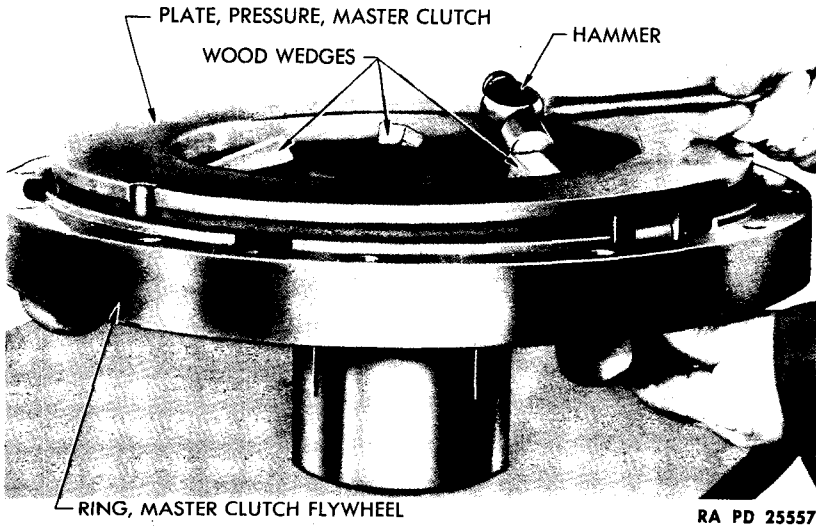


Figure 172—Pressure Plate on Flywheel Ring Installation

**ORDNANCE MAINTENANCE—POWER UNIT ACCESSORIES  
FOR MEDIUM TANKS M3A4 AND M4A4**



**Figure 173—Alining Release Lever Pinholes**

eight tabs of release bearing retainer to secure assembly (hammer and drift).

f. Install the Clutch Release Sleeve (fig. 176).

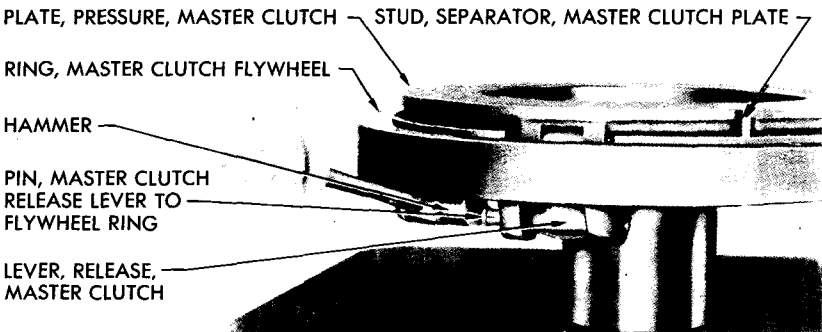
**HAMMER**

**WOOD BLOCK, 1- x 1- x**

**PLIERS, side cutting**

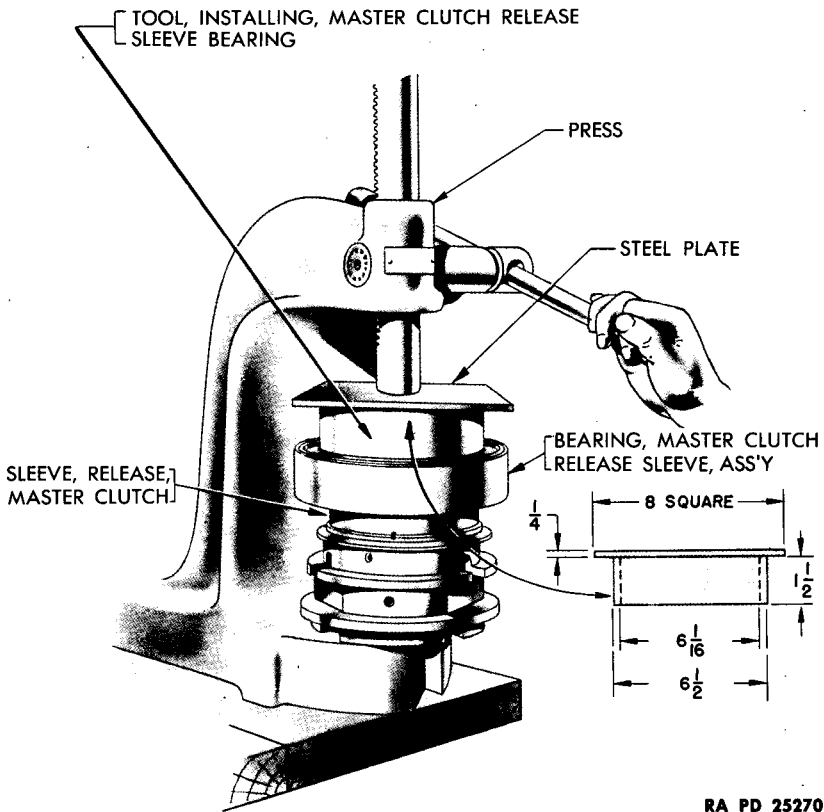
**1¼-in. (3)**

Turn the clutch flywheel ring and pressure plate assembly over on the bench so that the flywheel ring will be up. Align the two keyways in the sleeve with the two keys on the flywheel ring. Slide the sleeve over the



**Figure 174—Release Lever to Flywheel Ring Pins Installation**

ASSEMBLY



RA PD 25270

**Figure 175—Clutch Release Sleeve Bearing Installation**

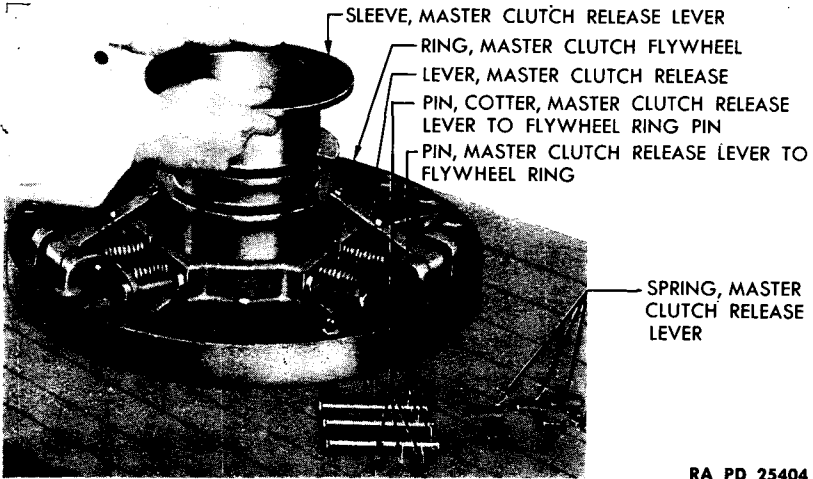
hub of the flywheel ring, remove the release lever pins and raise the release levers to allow the sleeve to pass levers (fig. 176). Place three blocks between two rear flanges of sleeve, where levers enter to prevent levers from slipping. Aline holes in flywheel ring and pressure plate and install the three release levers to flywheel ring pins. **CAUTION:** Always turn the pins so that the serrations on pin will seat in new location in openings. Drive pins into position with hammer and insert cotter pins through holes in pins to secure, before adjustment is made to the lever adjusting screw (fig. 179).

**g. Adjust the Clutch Pressure Spring Retainer Bolts.**

**WRENCH**, open-end,  $\frac{9}{16}$ -in.      **WRENCH**, open-end,  $1\frac{1}{16}$ -in.

Loosen the clutch pressure spring retainer bolts evenly with a  $\frac{9}{16}$ -inch

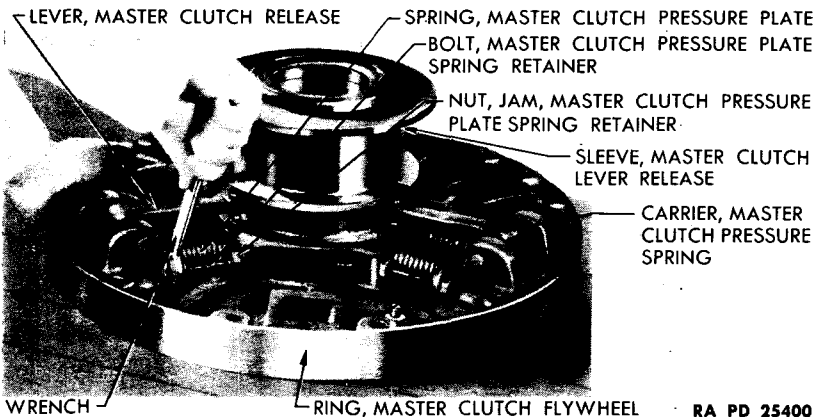
**ORDNANCE MAINTENANCE—POWER UNIT ACCESSORIES  
FOR MEDIUM TANKS M3A4 AND M4A4**



RA PD 25404

**Figure 176—Release Sleeve Installation**

open-end wrench until the pressure of the springs holds the retainers on the clutch release lever to link pins. Continue to loosen the bolts until the distance from the underside of the bolt head to the face of the pressure spring carrier is  $2\frac{3}{4}$  inches. This will allow the bolt to clear the spring retainer (fig. 177). Tighten the jam nuts securely with an  $1\frac{1}{16}$ -inch open-end wrench (fig. 178).



RA PD 25400

**Figure 177—Adjusting Spring Retainer Bolts**

ASSEMBLY

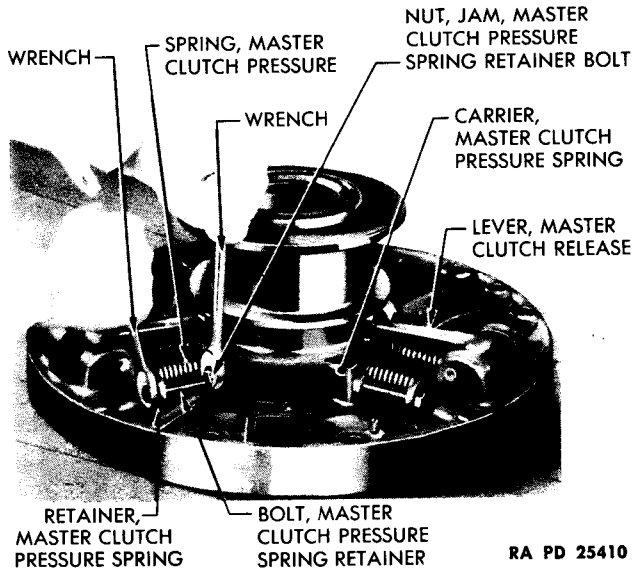


Figure 178—Locking Spring Retainer Bolts with Jam Nuts

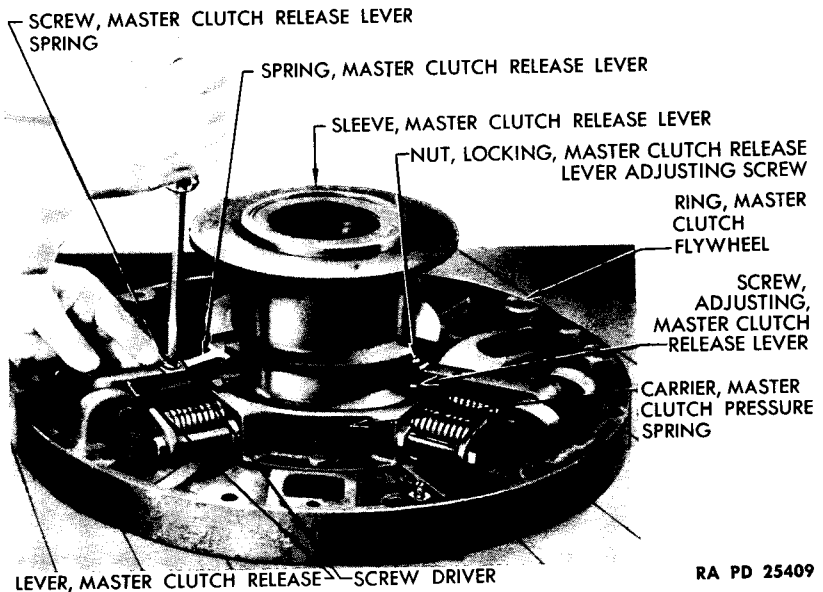
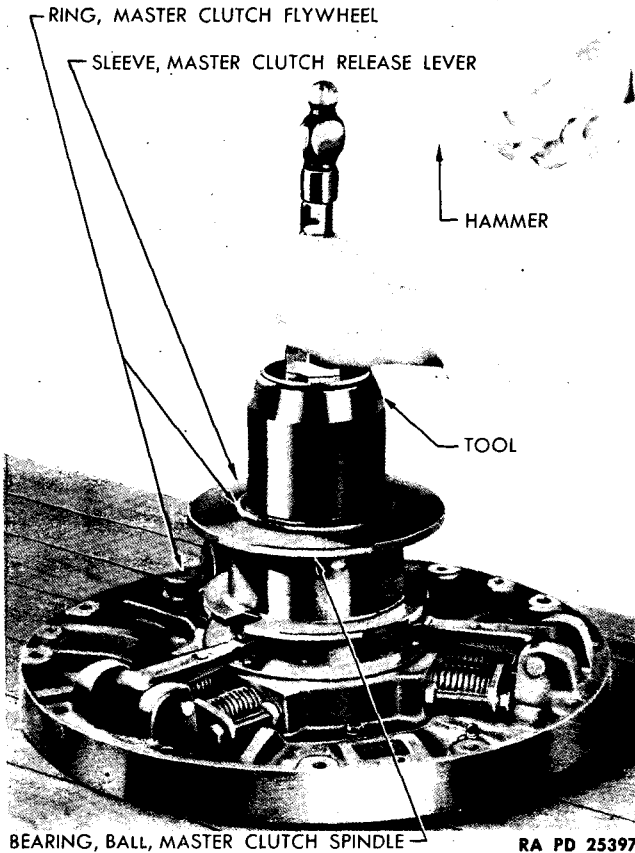


Figure 179—Release Lever Springs Installation

**ORDNANCE MAINTENANCE—POWER UNIT ACCESSORIES  
FOR MEDIUM TANKS M3A4 AND M4A4**



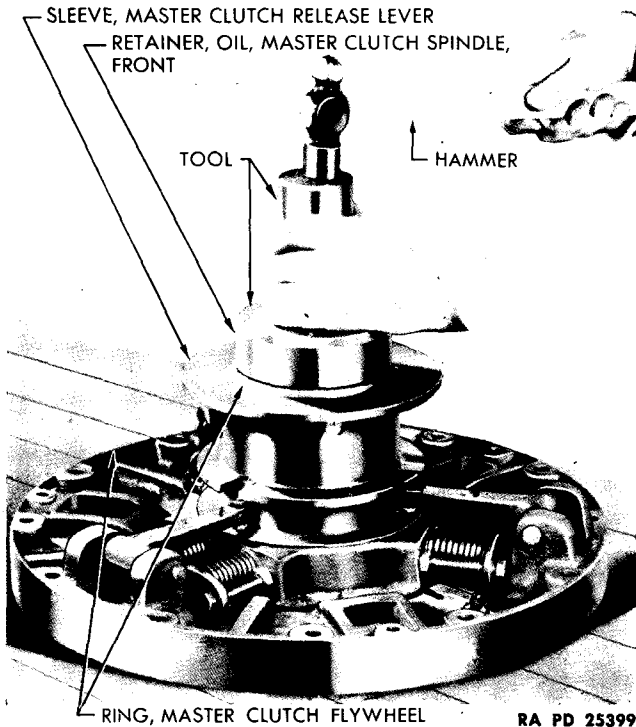
**Figure 180—Spindle Front Bearing Installation**

**h. Adjust Clutch Release Lever Height under the Flange of the Clutch Release Sleeve.**

**WRENCH**, open-end,  $\frac{7}{16}$ -in. (2)

**NOTE:** Adjustment is necessary only when a new release lever has been installed. Hold the head of the clutch release lever adjusting screw (fig. 179) with a  $\frac{7}{16}$ -inch open-end wrench and loosen the adjusting screw lock nut with a  $\frac{7}{16}$ -inch open-end wrench. Turn the adjusting screw until it is in the approximate position of the screws in the other two levers, or until screw just contacts the inner flange of the clutch release sleeve. Leave lock nut loose, to permit final adjustment after assembly of flywheel ring and pressure plate to flywheel. **NOTE:** After flywheel ring and pressure plate assembly is installed on flywheel, make final adjustment by turning adjusting screw until head of screw just con-

**ASSEMBLY**



**Figure 181—Spindle Front Bearing Oil Retainer Installation**

tacts the inner flange of the clutch release sleeve and secure by tightening lock nut.

**i. Install Clutch Release Lever Springs (fig. 179).**

**SCREWDRIVER**

Place the clutch release lever springs in position on the clutch release levers and fasten the springs in place with screws and lock washers. Tighten the screws securely with a screwdriver.

**j. Install Clutch Spindle Front Bearing in Clutch Flywheel Ring (fig. 180).**

**DRIVER, bearing**

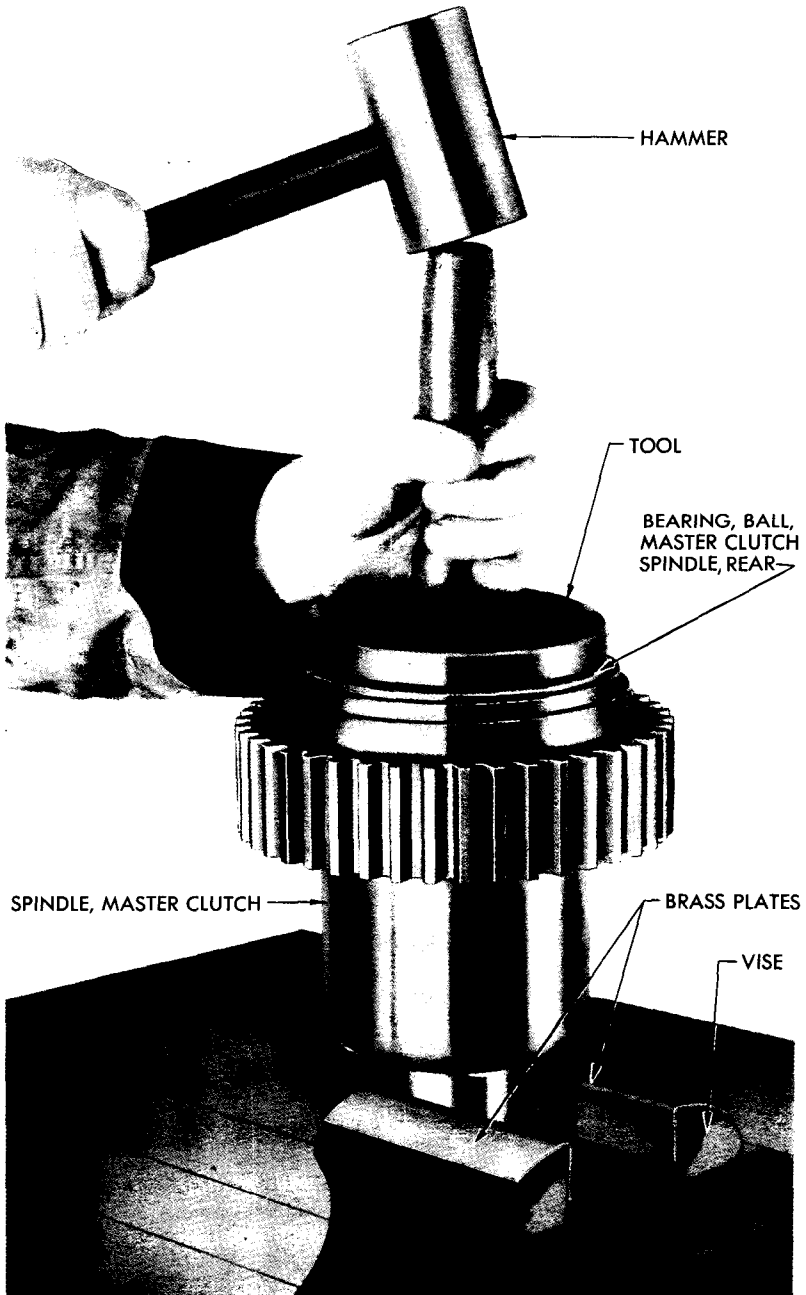
**HAMMER, steel**

Place the clutch flywheel ring on a bench with the hub up. Place the clutch spindle front bearing in position at the opening of the hub and drive the bearing into the sleeve with a driver and hammer.

(1) Insert the clutch spindle front bearing lock ring in the hub and force the lock ring in place in the groove with a screwdriver.



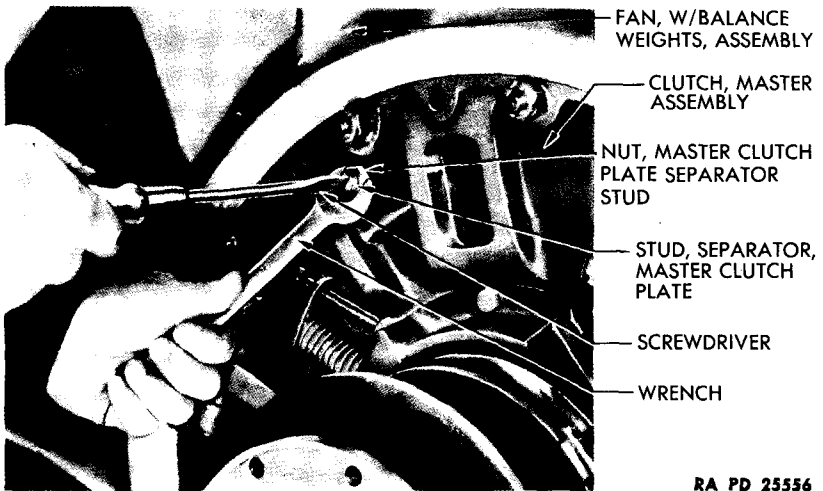
ORDNANCE MAINTENANCE—POWER UNIT ACCESSORIES  
FOR MEDIUM TANKS M3A4 AND M4A4



RA PD 25558

Figure 182—Spindle Rear Bearing Installation

ASSEMBLY



**Figure 183—Clutch Plate Separator Stud Adjustment**

(2) Pack the clutch spindle front bearing with **GREASE**, general purpose, and fill the cavity between the bearing and the oil retainer three-quarters full of grease.

(3) Place a film of **GREASE**, general purpose, No. 2, on the clutch spindle front oil retainer leather and place the oil retainer in position at the opening of the hub, with the leather lip of the retainer away from the bearing, and drive the retainer into place in the sleeve with a driver and a hammer (fig. 181).

**k. Install the Clutch Spindle Rear Bearing.**

**HAMMER** **TOOL**, installing

Place spindle in vise (equipped with brass jaws). Place the clutch spindle rear bearing in position at the opening in the spindle. Place the bearing installing tool in position with the edge of the tool applied against the outer race of the bearing and drive the bearing into place with a hammer.

**l. Install the Clutch Spindle Rear Bearing Oil Retainer (fig. 182).**

**HAMMER** **TOOL**, installing

Place the oil retainer in position at the opening in the spindle and drive the retainer into place with a hammer and an oil seal installing tool.

**m. Install the Clutch Spindle Oil Slinger.**

**PRESS**

**ORDNANCE MAINTENANCE—POWER UNIT ACCESSORIES  
FOR MEDIUM TANKS M3A4 AND M4A4**

**NOTE:** Installation is necessary if slinger has been removed. Place the spindle in position on the press with the large end up. Place the oil slinger in position on the large end of the spindle and press the oil slinger into position. Loosen the master clutch plate separator studs, shown in figure 183, approximately four turns, to permit installation of flywheel ring and pressure plate on flywheel, without interference. After flywheel ring is assembled to flywheel, adjust these studs by screwing studs until they contact driving plate. Unscrew studs one complete turn and lock in place by tightening lock nut with an  $1\frac{1}{4}$ -inch open-end wrench.

**75. INSTALLATION IN VEHICLE.**

a. Refer to TM 9-754, January 21, 1943 (par. 94), for installation procedure.

CHAPTER 5  
CLUTCH (MODEL M4A4)—(Cont'd)

Section VI  
FITS AND TOLERANCES

	Paragraph
General .....	76
Fits and tolerances .....	77

**76. GENERAL.**

a. The following fits and tolerances are production standards under which new clutches are manufactured. Due to varying conditions of service, no attempt is made to list wear limits allowed before replacement of clutch parts.

**77. FITS AND TOLERANCES.**

**a. Flywheel Hub.**

	Minimum	Maximum
Inside diameter of hub .....	2.631 in.	2.638 in.
Inside diameter of splines .....	2.412 in.	2.419 in.
Diameter of rear spindle bearing seat .....	3.5055 in.	3.5063 in.
Inside diameter of rear spindle bearing .....	3.506 in.	3.506 in.

**b. Pressure Plate.**

Diameter of link pinholes .....	4.995 in.	0.5005 in.
Diameter of pressure plate to link pin .....	0.4970 in.	0.4985 in.

**c. Driven Disk.**

Inside diameter of splines .....	6.750 in.	6.760 in.
Backlash on splines .....	0.004 in.	0.006 in.
Thickness of disk and facings .....	0.434 in.	0.450 in.

**d. Driving Plate.**

Width of slots .....	1.005 in.	1.008 in.
Width of driving pins .....	0.990 in.	0.992 in.
Thickness of plate .....	0.684 in.	0.687 in.

**e. Spindle.**

Outside diameter of front splines .....	2.497 in.	2.498 in.
Inside diameter of front splines .....	2.261 in.	2.271 in.
Inside diameter of front bearing .....	2.5591 in.	2.5591 in.
Diameter of front bearing seat .....	2.5580 in.	2.5586 in.
Outside diameter of rear bearing .....	5.1181 in.	5.1181 in.
Rear bearing seat diameter .....	5.1174 in.	5.1186 in.
Outside diameter of rear oil retainer .....	5.129 in.	5.133 in.
Diameter of rear oil retainer seat .....	5.1250 in.	5.133 in.
Inside diameter of oil slinger .....	5.494 in.	5.496 in.
Diameter of oil slinger seat .....	5.499 in.	5.502 in.

**ORDNANCE MAINTENANCE—POWER UNIT ACCESSORIES  
FOR MEDIUM TANKS M3A4 AND M4A4**

**f. Flywheel.**

	Minimum	Maximum
Diameter of driving pin . . . . .	0.7525 in.	0.7535 in.

**g. Flywheel Ring.**

Outside diameter of front spindle bearing . . .	4.7244 in.	4.7244 in.
Diameter of front spindle bearing seat . . . .	4.7234 in.	4.7244 in.
Outside diameter of front spindle oil seal . . .	4.754 in.	4.758 in.
Diameter of front spindle oil seal seat . . . .	4.749 in.	4.751 in.
Diameter of release lever to flywheel ring pinholes . . . . .	0.4995 in.	0.5005 in.
Diameter of release lever to flywheel ring pin . . . . .	0.4970 in.	0.4985 in.
Outside diameter of flywheel ring hub . . . . .	5.305 in.	5.307 in.
Inside diameter of release sleeve . . . . .	5.312 in.	5.314 in.

**h. Pressure Spring.**

Load at assembled height of $2\frac{3}{16}$ inches . . .	460 lb	480 lb
--	--------	--------

**i. Clutch Release Sleeve (Coaxial Bearing Type).**

Outside diameter of sleeve hub . . . . .	5.9998 in.	6.0008 in.
Inside diameter of release sleeve bearing (coaxial) . . . . .	5.9990 in.	6.0000 in.
Inside diameter of bearing inner seal . . . . .	5.9990 in.	6.0000 in.

CHAPTER 6  
CLUTCH (MODEL M3A4)

Section I

DESCRIPTION OF CLUTCH

	Paragraph
Description .....	78
Tabulated data and specifications .....	79
Second echelon operations .....	80
Echelon break-down of maintenance .....	81

78. DESCRIPTION (fig. 184).

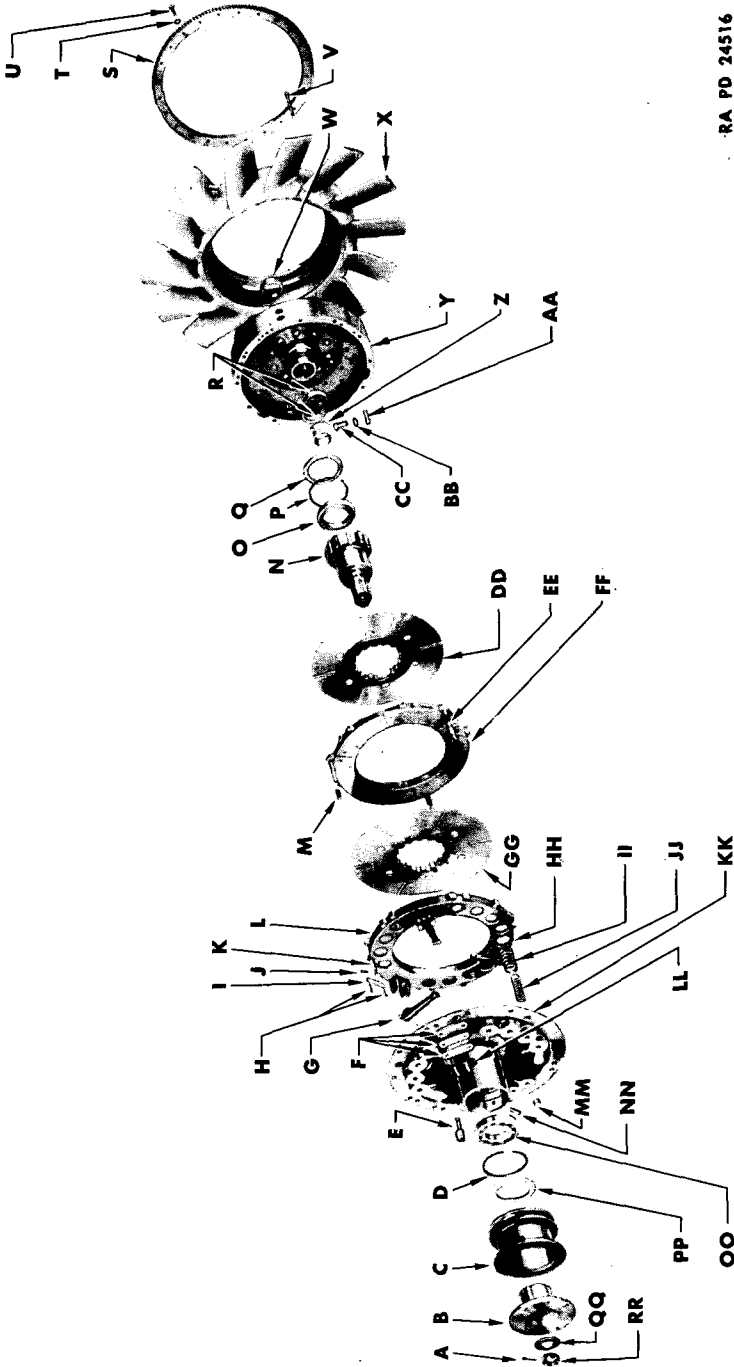
a. The clutch is of the dry, multiple plate type, having two driven members. It is mounted inside a recessed flywheel and is located just forward of the radiator. The clutch assembly consists of the flywheel, spindle, spindle flange, two driven plates (one inner and one outer), a center or driving plate, a release sleeve and the spring housing assembly that includes the clutch release levers, pressure springs and pressure plate. There are four clutch facings, one riveted to the inner face of the flywheel, one riveted to each face of the center plate and one riveted to the pressure plate. One driven plate is used between the flywheel and the center plate and the other is used between the center plate and the pressure plate. The two driven plates are alike, each consisting of a steel plate attached to a splined hub.

79. TABULATED DATA AND SPECIFICATIONS.

a. Clutch Assembly.

Make .....	Rockford Drilling Machine Company
Type .....	Multiple plate, dry
Weight .....	314 lb
O.D. of flywheel .....	19½ in.
O.D. of facing .....	16½ in.
I.D. of facing .....	11½ in.
Width of facing .....	2½ in.
Thickness of facing .....	⅛ in.
Friction surface per facing .....	110 sq in.
Pressure per sq in. of friction surface .....	29.5 lb
Number of springs .....	24
Pressure of long spring (at 2⅜ <sub>2</sub> -in. length) .....	100 lb
Pressure of short spring (at 1⅜ <sub>2</sub> -in. length) .....	170 lb
Total spring pressure .....	3,240 lb
Torque capacity .....	1,435 ft-lb
Lever ratio .....	6.46 to 1

ORDNANCE MAINTENANCE—POWER UNIT ACCESSORIES  
FOR MEDIUM TANKS M3A4 AND M4A4



RA PD 24516

Figure 184—Parts of M3A4 Clutch Assembly

DESCRIPTION OF CLUTCH

- A—PIN, COTTER, MASTER CLUTCH SPINDLE NUT  
 B—FLANGE, MASTER CLUTCH SPINDLE  
 C—SLEEVE, RELEASE, MASTER CLUTCH  
 D—LOCK RING, MASTER CLUTCH SPINDLE FRONT BEARING  
 E—SCREW, MASTER CLUTCH RELEASE ARM BRACKET  
 F—SHIM, MASTER CLUTCH RELEASE ARM BRACKET  
 G—ARM, RELEASE, MASTER CLUTCH  
 H—PIN, COTTER, MASTER CLUTCH RELEASE ARM ROLLER PIN  
 I—PIN, MASTER CLUTCH RELEASE ARM ROLLER  
 J—PIN, COTTER, MASTER CLUTCH PLATE SEPARATOR  
 ADJUSTING SLEEVE  
 K—SLEEVE, ADJUSTING, MASTER CLUTCH PLATE SEPARATOR  
 L—PLATE, PRESSURE, MASTER CLUTCH  
 M—SPRING, SEPARATOR, MASTER CLUTCH PLATE  
 N—SPINDLE, MASTER CLUTCH  
 O—BEARING, MASTER CLUTCH SPINDLE, REAR  
 P—LOCK RING, MASTER CLUTCH SPINDLE REAR BEARING  
 Q—RETAINER, OIL, MASTER CLUTCH SPINDLE, REAR  
 R—CONE, MASTER CLUTCH HUB, FRONT  
 S—GEAR, FAN RING  
 T—WASHER, LOCK, FAN RING GEAR SCREW  
 U—SCREW, FAN RING GEAR  
 V—BOLT, MASTER CLUTCH SPRING HOUSING TO FLYWHEEL  
 W—CONE, MASTER CLUTCH HUB, REAR  
 X—FAN, ASSEMBLY  
 Y—FLYWHEEL, MASTER CLUTCH  
 Z—NUT, MASTER CLUTCH HUB FRONT CONE  
 AA—PIN, COTTER, MASTER CLUTCH HUB FRONT CONE NUT  
 RETAINER PIN  
 BB—WASHER, PLAIN, MASTER CLUTCH HUB FRONT CONE NUT  
 RETAINER PIN  
 CC—PIN, RETAINER, MASTER CLUTCH HUB FRONT CONE NUT  
 DD—PLATE, DRIVEN, MASTER CLUTCH, ASSEMBLY  
 EE—SCREW, ADJUSTING, MASTER CLUTCH PLATE SEPARATOR  
 FF—PLATE, MASTER CLUTCH, CENTER, ASSEMBLY  
 GG—PLATE, DRIVEN, MASTER CLUTCH, ASSEMBLY  
 HH—WASHER, INSULATING, MASTER CLUTCH PRESSURE SPRING  
 II—SPRING, PRESSURE, MASTER CLUTCH (SHORT)  
 JJ—SPRING, PRESSURE, MASTER CLUTCH (LONG)  
 KK—HOUSING, MASTER CLUTCH SPRING  
 LL—BRACKET, MASTER CLUTCH RELEASE ARM  
 MM—NUT, MASTER CLUTCH SPRING HOUSING TO FLYWHEEL BOLT  
 NN—PLUG, MASTER CLUTCH SPRING HOUSING  
 OO—BEARING, MASTER CLUTCH SPINDLE, FRONT  
 PP—RETAINER, OIL, MASTER CLUTCH SPINDLE, FRONT  
 QQ—WASHER, MASTER CLUTCH SPINDLE NUT  
 RR—NUT, MASTER CLUTCH SPINDLE

RA PD 245168

Legend for Figure 184—Parts of M3A4 Clutch Assembly



**ORDNANCE MAINTENANCE—POWER UNIT ACCESSORIES  
FOR MEDIUM TANKS M3A4 AND M4A4**

Pressure of clutch release at end of lever . . . . . 500 lb  
Pressure plate release with  $\frac{7}{8}$ -inch sleeve travel . . . . . 0.135 in.  
Separator spring pressure (compressed to  $1\frac{1}{16}$  in.) . . . . . 15 lb-20 lb

**b. Release Arm Bearing.**

Type . . . . . Needle  
Torrington Number . . . . . B-812

**c. Clutch Controls.**

Pedal pull back spring pressure (at  $10\frac{5}{16}$ -in. length) . . . . . 92 lb  
Pedal over center spring pressure (at  $10\frac{5}{16}$ -in. length) . . . . . 590 lb

**d. Release Lever Bearing.**

Type . . . . . Needle  
Torrington Number . . . . . B-1616-5

**e. Over Center Spring and Trunnion Bearing.**

Type . . . . . Needle  
Torrington Number . . . . . B-88-X

**f. Release Cross Shaft Bearing, Center and Left.**

Type . . . . . Needle  
Torrington Number . . . . . B-2220-X

**g. Throwout Bearing.**

Type . . . . . Ball  
Marlin-Rockwell Number . . . . . M.R.C., 305, MFF4 or equivalent  
N.D. bearing

**h. Release Cross Shaft Lever Bearing, Left and Center.**

Type . . . . . Needle  
Torrington Number . . . . . B-88-X

**i. Clutch Release Idler Lever Bearing, Large.**

Type . . . . . Needle  
Torrington Number . . . . . B-1616-X

**j. Clutch Release Idler Lever Bearing, Small.**

Type . . . . . Needle  
Torrington Number . . . . . B-88-X

**80. SECOND ECHELON OPERATIONS.**

a. In view of the fact that many second echelon operations are often performed by ordnance maintenance personnel, the information is not repeated in this manual; therefore, ordnance maintenance personnel should refer to TM 9-730C for this information.

**81. ECHELON BREAK-DOWN OF MAINTENANCE.**

a. Refer to paragraph 4.

**CHAPTER 6**  
**CLUTCH (MODEL M3A4)—(Cont'd)**

**Section II**  
**TROUBLE SHOOTING**

Trouble shooting .....	Paragraph 82
------------------------	-----------------

**82. TROUBLE SHOOTING.**

**a. Clutch Drags.**

<b>Possible Cause</b>	<b>Possible Remedy</b>
Excessive backlash.	Adjust clutch pedal, TM 9-730C (par. 90 b).
Incorrect plate separator clearance.	Correct, TM 9-730C (par. 91 b (9)).
Warped driven plate.	Replace, TM 9-730C (par. 91 a and b).
Metal transfer or bonding of clutch facings.	Replace damaged parts, TM 9-730C (par. 91 a and b).
Brinnelling of drive spline.	Replace clutch spindle, TM 9-730C (par. 91 a and b).
Excessive dirt in clutch assembly.	Disassemble clutch, clean and reassemble, TM 9-730C (pars. 85 a and 91 a and b).

**b. Clutch Slips.**

Items included under subparagraph a, above.	See subparagraph a, above.
Improper adjustment of pedal or release levers or arms.	Check pedal and release lever or arm adjustment. Adjust where necessary (par. 88), and TM 9-730C (par. 90 b).
Loss of spring load due to excessive heat.	Replace springs (pars. 84 a and b and 86 c).
Binding of clutch center plate and driven plates due to dirt or brinnelling.	Disassemble and clean clutch or replace damaged parts (par. 85 a) and TM 9-730C (par. 91 a and b).

**c. Complete Failure of Clutch to Engage or Release.**

Disconnected clutch linkage or binding of linkage or clutch.	Inspect linkage and clutch. Replace or connect linkage parts or replace necessary clutch parts (par. 85 a) and TM 9-730C (par. 91 a and b).
--	---

ORDNANCE MAINTENANCE—POWER UNIT ACCESSORIES  
FOR MEDIUM TANKS M3A4 AND M4A4

CHAPTER 6

CLUTCH (MODEL M3A4)—(Cont'd)

Section III

DISASSEMBLY

	Paragraph
Removal from vehicle .....	83
Disassembly of clutch pressure plate and clutch spring housing ..	84

83. REMOVAL FROM VEHICLE.

- a. Refer to TM 9-730C (par. 91 a) for removal procedure.

84. DISASSEMBLY OF CLUTCH PRESSURE PLATE AND CLUTCH SPRING HOUSING.

CLAMP, C-, 6-in. (3)

SCREWDRIVER

PLIERS, side cutting

WRENCH, 3/4-in.

PULLER, bearing and oil  
retainer

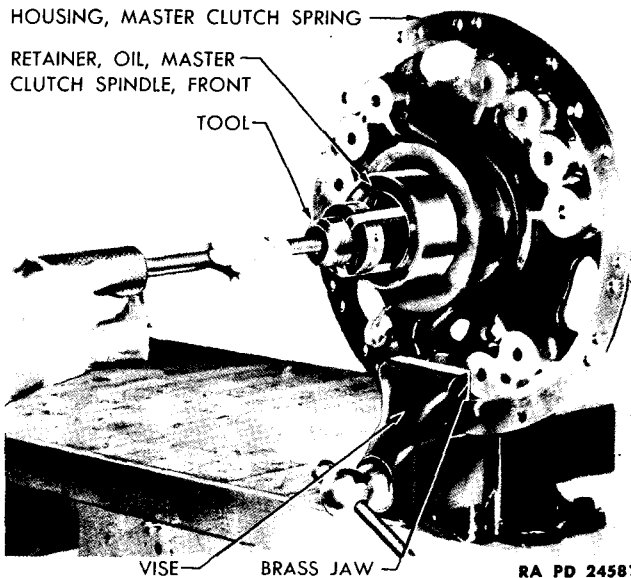
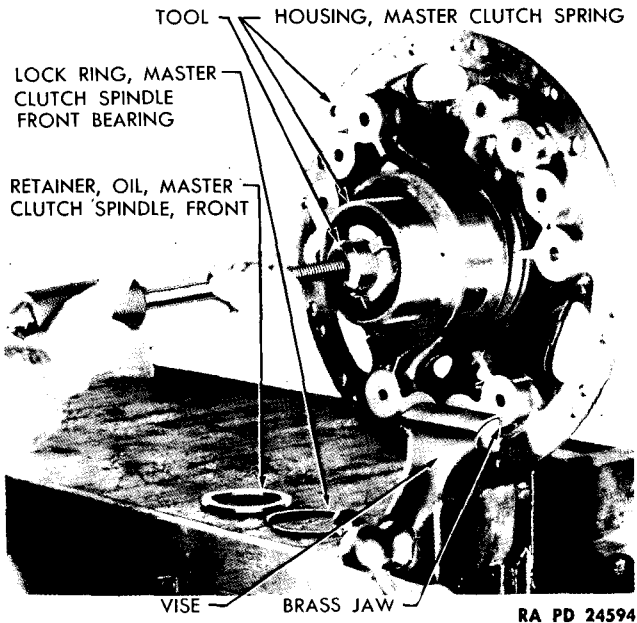


Figure 185—Spindle Front Bearing Oil Retainer Removal

**DISASSEMBLY**

**Figure 186—Spindle Front Bearing Removal**

**a. Remove Clutch Release Arms.**

CLAMP, C-, 6-in. (3)

PLIERS, side cutting

Place three 6-inch C-clamps on clutch spring housing, as shown in figure 192, and compress springs sufficiently to permit removal of pins with fingers. Remove cotter pins with side cutting pliers and remove pins. Release the C-clamps, evenly, until full spring tension is released.

**b. Remove Spring Housing from Pressure Plate.**

Lift housing off springs and pressure plate (fig. 190).

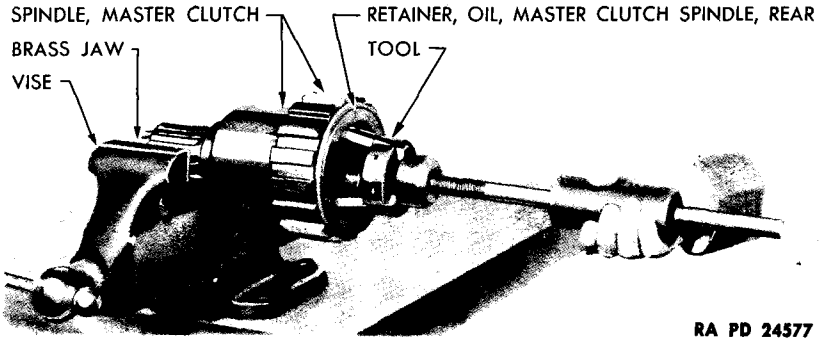
**c. Remove the Clutch Spindle Front Bearing.**

PULLER, MTM-A4-35

SCREWDRIVER

Remove the clutch spindle front oil retainer with puller MTM-A4-35 (fig. 185). Remove the clutch spindle front bearing lock ring by prying one end of the lock ring out of the groove in the clutch spring housing with a screwdriver and pulling the lock ring out of the spring housing. Remove the clutch spindle front bearing with puller MTM-A4-35 (fig. 186).

**ORDNANCE MAINTENANCE—POWER UNIT ACCESSORIES  
FOR MEDIUM TANKS M3A4 AND M4A4**



RA PD 24577

**Figure 187—Spindle Rear Bearing Oil Retainer Removal**

**d. Remove the Clutch Spindle Rear Bearing (fig. 187).**

PULLER, bearing

SCREWDRIVER

PULLER, oil retainer

WISE

Clamp the clutch spindle in a vise and remove the spindle rear bearing oil retainer with a puller. Pry out the spindle rear bearing lock ring with a screwdriver. Remove the spindle rear bearing with a puller.

**e. Remove Clutch Release Sleeve.**

Slide sleeve off spring housing.

CHAPTER 6  
CLUTCH (MODEL M3A4)—(Cont'd)

Section IV  
INSPECTION OF PARTS

	Paragraph
Inspection of parts .....	85

**85. INSPECTION OF PARTS.**

**FIXTURE**, spring testing, Federal Stock No. 17-T-1600      **PAN**, for cleaning parts

**a. Clean Parts for Inspection.**

**PAN**, for cleaning parts

Wash all parts thoroughly with **SOLVENT**, dry-cleaning, to remove all foreign matter and permit close inspection.

**b. Inspect Clutch Spring Housing.**

**FIXTURE**, spring testing, Federal Stock No. 17-T-1600

Inspect spring housing carefully for any cracks. Inspect bearing bore and oil retainer bore for nicks or any irregularities. Inspect bearing for roughness. If found to be rough, replace with new bearing. Using spring testing fixture, Federal Stock No. 17-T-1600, test all springs for proper pressure. The pressure of the long spring is 100 pounds when compressed to  $2\frac{3}{32}$  inches. The pressure of the short spring is 170 pounds, when compressed to  $1\frac{11}{32}$  inches. Inspect release arm brackets for distortion or excessive wear by inserting roller pins in end of release arm, in the opening in bracket and checking contour of openings in bracket. Inspect release sleeve for cracks. Inspect flanges on sleeve for excessive wear.

**c. Inspect Pressure Plate.**

(1) Inspect pressure plate carefully for cracks. Inspect facing for excessive wear. If facing has worn to a point where rivets are approximately even with surface of facing, replace pressure plate. Inspect slots in outer periphery of plate for excessive wear and scores.

(2) Inspect roller pins in release arms for free rotation. Inspect release arm roller pins for wear and fit in pressure plate. Inspect release arms at end, where they contact release sleeve, for excessive wear.

**d. Inspect Clutch Center Plate.**

**FIXTURE**, spring testing, Federal Stock No. 17-T-1600

Inspect facings for loose rivets and excessive wear. If facings are worn to a point where rivets are approximately even with surface of facings, replace plate. Inspect plate carefully for cracks. Inspect plate separator pins to be sure they are not loose where riveted to plate and that pins are

**ORDNANCE MAINTENANCE—POWER UNIT ACCESSORIES  
FOR MEDIUM TANKS M3A4 AND M4A4**

not sprung. Inspect threads on plate separator pins, to be sure threads are not damaged. Using spring testing fixture, inspect plate separator springs for proper tension. When compressed to  $1\frac{1}{16}$  inch, pressure should be 15—20 pounds. Inspect the six slots which fit over flywheel driving studs for scores. **NOTE:** The intermediate plate must drive through all six (6) flywheel lugs to assure even load distribution. File driven side of slot in driving disk if necessary so that the driving side of all six (6) flywheel lugs contact driven side of corresponding intermediate plate slots simultaneously. Driving plate must slide freely on flywheel lugs. Check for side clearance between flywheel lugs and intermediate plate slots. Slot clearance for the driving plate, should be .008 inch to 0.010 inch. File slots in driving plate if necessary to attain proper clearance.

**e. Inspect Clutch Driven Plates.**

Inspect driven plates for cracks and uneven surfaces where plates contact clutch facings. Inspect splines for nicks or burs and fit plates on splines of spindle to be sure of a free fit. Inspect for loose rivets which secure plate to hub.

**f. Inspect Clutch Spindle.**

Inspect spindle carefully for cracks. Inspect bearing bore and oil retainer bore for any uneven surfaces which will not permit a tight bearing or oil retainer fit. Inspect splines and threads for damage. Inspect splines for any indication of brinnelling. If brinnelled to the extent that movement of driven plates on splines is restricted, replace spindle.

**g. Inspect Flywheel.**

Inspect clutch facing for excessive wear. If facing is worn to a point where rivets are approximately even with surface of facing, replace flywheel. Inspect flywheel for cracks. Inspect chamfer at each end of hub for rough or flat spots. Inspect splines inside hub for nicks or scores.

**h. Inspect Fan and Fan Ring Gear.**

Inspect fan blades carefully for cracks or any indication of interference. Inspect threads in openings for damage and for cracks around openings. Tighten balance weights inside fan hub, if loose. Inspect teeth on fan ring gear for any indication of interference or for improper meshing of starter ring gear. Inspect gear carefully for cracks.

CHAPTER 6  
CLUTCH (MODEL M3A4)—(Cont'd)

Section V  
ASSEMBLY

	Paragraph
Assembly of clutch pressure plate and spring housing . . . . .	86
Installation in vehicle . . . . .	87
Clutch release lever adjustment . . . . .	88

**86. ASSEMBLY OF CLUTCH PRESSURE PLATE AND SPRING HOUSING.**

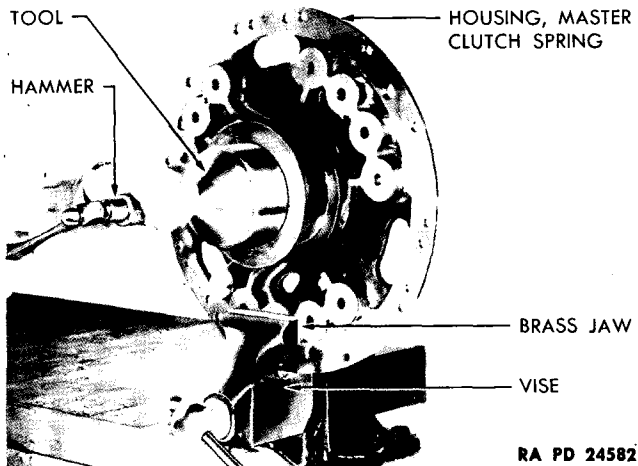
- |                      |                      |
|----------------------|----------------------|
| CLAMP, C-, 6-in. (3) | PLIERS, side cutting |
| DRIVER, bearing      | SCREWDRIVER          |
| DRIVER, oil retainer | WRENCH, 3/4-in.      |
| HAMMER, steel        |                      |

**a. Install Clutch Release Sleeve.**

Oil bearing surface on spring housing, align keyways in sleeve with keys on spring housing and slide sleeve on housing.

**b. Install Clutch Spindle Front Bearing in Clutch Spring Housing (fig. 188).**

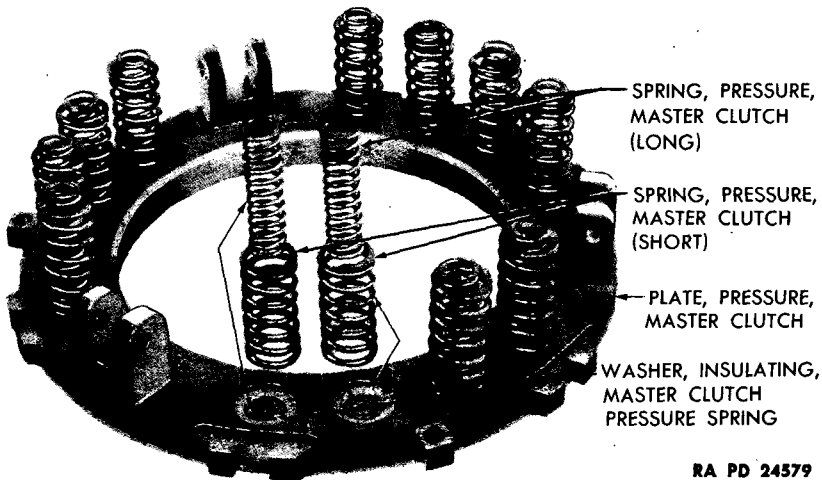
- |                 |             |
|-----------------|-------------|
| DRIVER, bearing | SCREWDRIVER |
| HAMMER, steel   |             |



**Figure 188—Spindle Front Bearing Installation**



**ORDNANCE MAINTENANCE—POWER UNIT ACCESSORIES  
FOR MEDIUM TANKS M3A4 AND M4A4**



RA PD 24579

**Figure 189—Location of Pressure Springs and Insulating Washers**

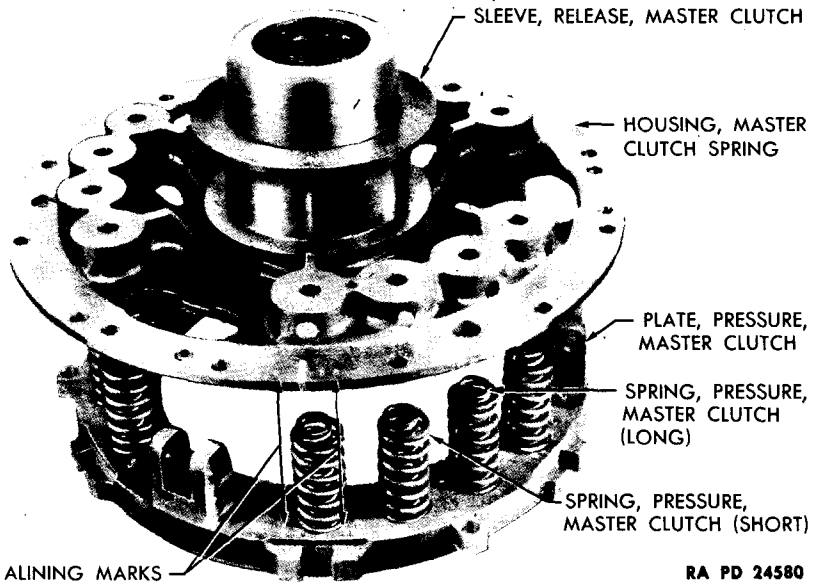
Place the clutch spring housing in a vise. Place the clutch spindle front bearing in position at the opening of the hub and drive the bearing into the hub with a driver and hammer. Insert the clutch spindle front bearing lock ring in the hub and force the lock ring into place in the groove with a screwdriver. Pack the clutch spindle front bearing with **GREASE**, general purpose, No. 2, and fill the cavity between the bearing and the oil retainer three-fourths full of grease. Place a film of **GREASE**, general purpose, No. 2, on a new clutch spindle front oil retainer leather and place the retainer in position at the opening of the hub, with the leather lip of the retainer toward the bearing. Drive the oil retainer into position in the hub with driver and hammer.

**c. Assemble the Clutch Pressure Plate (fig. 189).**

**CLAMP, C-, 6-in. (3)**

Place the 12 clutch pressure spring insulating washers in position in their recesses in the clutch pressure plate. Slide the long clutch pressure springs through the short clutch pressure springs and place the springs in position on the spring insulating washers with the ends of the long pressure springs in the recesses of the insulating washers. Place the clutch spring housing in position on top of the clutch pressure springs with the alining marks on the housing alined with the marks on the clutch pressure plate (fig. 190). Hold the clutch spring housing in position while another man places the three 6-inch C-clamps in position and tightens the clamps evenly, compressing the springs. Refer to figure 191 for proper C-clamp position.

## ASSEMBLY



**Figure 190—Spring Housing to Pressure Plate Assembly**

**d. Install Clutch Release Arm.**

PLIERS, side cutting

WRENCH,  $\frac{3}{4}$ -in.

Place three clutch release arm bracket shims in position on clutch spring housing, in line with the holes in spring housing for the release arm bracket screws (fig. 191). Place clutch release arm in position, with the inner end of each arm between middle flange and the inner flange of the release sleeve (fig. 192). Aline the holes in the clutch release arm with the holes in bosses on pressure plate, insert the release arm pins through holes in arm and bosses and insert cotter pins through holes in ends of pins. Bend cotter pins, with side cutting pliers, to secure. Repeat operation to install the other two release arms. Place the three clutch release arm brackets in position on shims (using screws to aline holes in brackets, shims, and spring housing) and with openings in brackets partly encircling pins in outer ends of release arms (fig. 191). Hold brackets in position and release C-clamps evenly, until all spring tension is released.

**e. Install Clutch Spindle Rear Bearing (fig. 193).**

HAMMER, steel

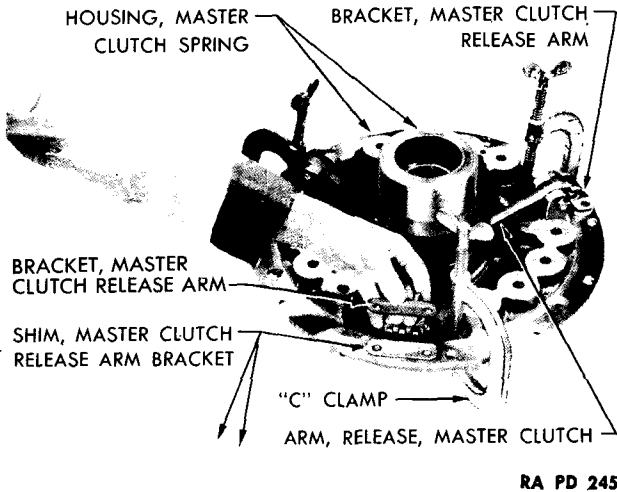
TOOL, installing, retainer

SCREWDRIVER

WOOD BLOCK

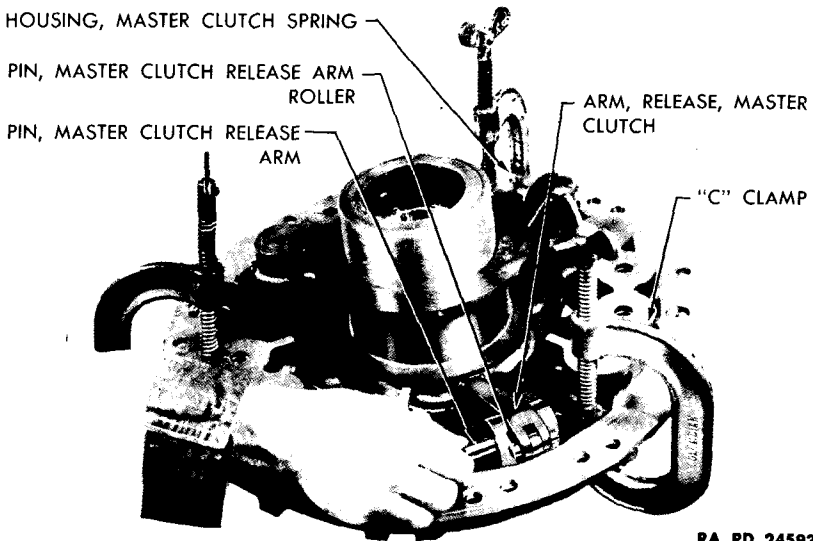
TOOL, installing, bearing

**ORDNANCE MAINTENANCE—POWER UNIT ACCESSORIES  
FOR MEDIUM TANKS M3A4 AND M4A4**



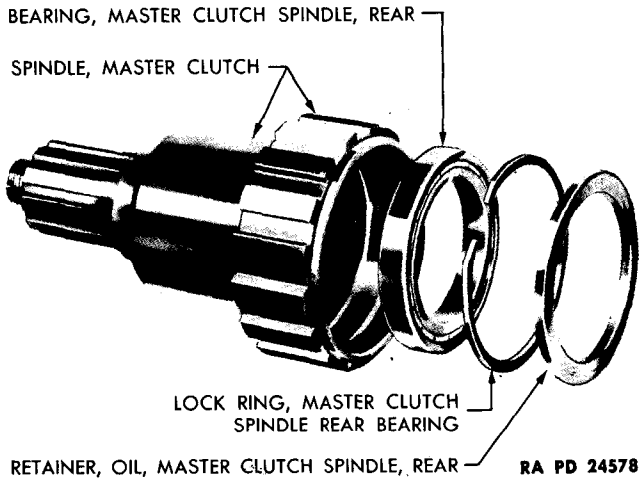
**Figure 191—Shims and Release Arm Bracket Installation**

Place threaded end of spindle in opening in wood block, to support spindle and protect threads during operation (fig. 194). Pack bearing with GREASE, general purpose, No. 2, and place bearing in position at opening in spindle. Place bearing installing tool in position with outer edge of tool applied against outer race of bearing and drive bearing into



**Figure 192—Release Arm Pin Installation**

**ASSEMBLY**



**Figure 193—Parts of Clutch Spindle Assembly**

position in spindle. Insert bearing lock ring in spindle and into position in groove. Place bearing oil retainer in position at opening in spindle and drive into position with installing tool and hammer. **NOTE:** Leave retainer flush with outer edge of spindle opening.

**87. INSTALLATION IN VEHICLE.**

- a. Refer to TM 9-730C (par. 91 b) for installation procedure.

**88. CLUTCH RELEASE LEVER ADJUSTMENT.**

a. **General.** Adjustment of the clutch release levers will be required only when clutch facings have worn sufficiently to change the position of the clutch release sleeve on clutch spring housing. The distance from flange of clutch release sleeve to end of spring housing hub should be 1½ inches.

b. **Adjust Clutch Release Lever.**

BAR, pry

WRENCH, ¾-in.

PLIERS, side cutting

(1) REMOVE ONE SHIM FROM UNDER EACH CLUTCH RELEASE ARM BRACKET (fig. 191).

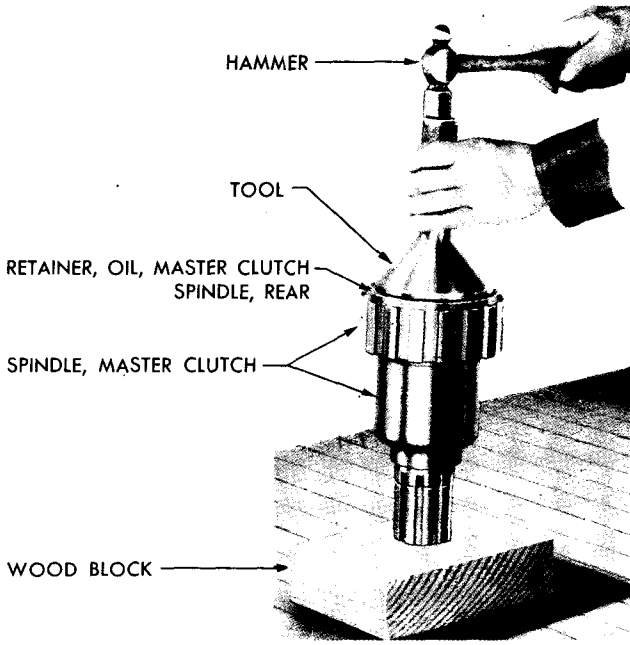
BAR, pry

WRENCH, ¾-in.

PLIERS, side cutting

Remove locking wire with side cutting pliers and remove the two clutch release arm bracket screws from one bracket with a ¾-inch

**ORDNANCE MAINTENANCE—POWER UNIT ACCESSORIES  
FOR MEDIUM TANKS M3A4 AND M4A4**



RA PD 24576

**Figure 194—Spindle Rear Bearing Oil Retainer Installation**

wrench. Raise the bracket with a pry bar and remove one bracket shim. Repeat the operation on the other two brackets. Install the clutch release arm bracket screws and tighten securely with a  $\frac{3}{4}$ -inch wrench.

(2) Check the distance between the clutch release sleeve flange and the end of the spring housing hub. This distance should be  $1\frac{1}{2}$  inches if the clutch release levers are properly adjusted. If necessary, remove additional release lever bracket shims until this distance is obtained.

c. Readjust clutch pedal after the release lever adjustment.

CHAPTER 6  
CLUTCH (M3A4)—(Cont'd)

Section VI  
FITS AND TOLERANCES

	Paragraph
General .....	89
Fits and tolerances .....	90

**89. GENERAL.**

a. The following fits and tolerances are production standards under which new clutches are manufactured. Due to varying conditions of service, no attempt is made to list wear limits allowed before replacement of clutch parts.

**90. FITS AND TOLERANCES.**

**a. Center Plate.**

	Minimum	Maximum
Diameter of separator screw holes .....	0.500 in.	0.501 in.
Diameter of separator screw .....	0.502 in.	0.503 in.
Width of driving stud slots .....	0.868 in.	0.872 in.
Width of driving studs .....	0.860 in.	0.864 in.

**b. Pressure Plate.**

Width of driving stud slots .....	0.868 in.	0.871 in.
Width of driving studs .....	0.860 in.	0.864 in.
Diameter of release arm pinholes .....	0.500 in.	0.501 in.
Diameter of release arm pin .....	0.5000 in.	0.5005 in.

**c. Separator Spring.**

Pressure at $1\frac{1}{16}$ -inch length .....	15 lb	20 lb
--	-------	-------

**d. Spindle.**

Width of front splines .....	0.384 in.	0.386 in.
I.D. of front splines .....	2.270 in.	2.271 in.
O.D. of front splines .....	2.463 in.	2.468 in.
Diameter of front bearing seat .....	2.5583 in.	2.5590 in.
I.D. front bearing .....	2.5585 in.	2.5591 in.
Width of rear splines .....	0.594 in.	0.596 in.
Diameter of rear bearing seat .....	4.999 in.	5.000 in.
O.D. of rear bearing .....	4.9982 in.	4.9990 in.
Diameter of rear oil retainer seat .....	5.125 in.	5.1265 in.
O.D. of rear oil retainer .....	5.129 in.	5.133 in.

**ORDNANCE MAINTENANCE—POWER UNIT ACCESSORIES  
FOR MEDIUM TANKS M3A4 AND M4A4**

**e. Flywheel Body.**

	Minimum	Maximum
Diameter of driving stud hole . . . . .	0.625 in.	0.626 in.
Diameter of driving stud . . . . .	0.6265 in.	0.627 in.

**f. Flywheel Hub.**

I.D. of hub . . . . .	2.631 in.	2.638 in.
I.D. of splines . . . . .	2.412 in.	2.419 in.
Diameter of rear spindle bearing seat . . . . .	3.491 in.	3.496 in.
I.D. of rear spindle bearing . . . . .	3.4992 in.	3.5000 in.

**g. Spring Housing.**

Diameter of front spindle bearing seat . . . . .	4.7232 in.	4.7242 in.
O.D. of front spindle bearing . . . . .	4.7236 in.	4.7244 in.
Diameter of front spindle oil seal seat . . . . .	4.7500 in.	4.7515 in.
O.D. of front spindle oil seal . . . . .	4.754 in.	4.758 in.
O.D. of spring housing hub . . . . .	5.243 in.	5.245 in.
I.D. of release sleeve . . . . .	5.250 in.	5.252 in.

**h. Driven Plate.**

I.D. of splines . . . . .	5.624 in.	5.626 in.
O.D. of splines . . . . .	6.130 in.	6.135 in.

**i. Release Arm Assembly.**

Diameter of bearing hole in arm . . . . .	0.6870 in.	0.6880 in.
O.D. of bearing . . . . .	0.6870 in.	0.6880 in.
Diameter of roller pinhole in arm . . . . .	0.375 in.	0.376 in.
O.D. of roller pin . . . . .	0.373 in.	0.374 in.
I.D. of roller . . . . .	0.375 in.	0.376 in.
Diameter of release arm pin . . . . .	0.5000 in.	0.5005 in.
I.D. of bearing . . . . .	0.5000 in.	0.5005 in.

**j. Clutch Facing.**

Thickness . . . . .	$\frac{3}{16}$ in.	$\frac{3}{16}$ in.
---------------------	--------------------	--------------------

**CHAPTER 7**  
**ELECTRICAL SYSTEM**

**Section I**

**DESCRIPTION OF SYSTEM**

	Paragraph
General .....	91
Description .....	92
Tabulated data and specifications .....	93
Second echelon operations .....	94
Echelon break-down of maintenance .....	95

**91. GENERAL.**

a. The electrical system, as covered in this manual, includes only those units which pertain directly to the power unit such as starter motor, generator, sending units, and gages. The ignition system for the power unit is thoroughly covered in TM 9-1750F, chapter 3 and will not be repeated in this manual.

b. As a means of simplification, all reference to removal and installation of various doors and covers, necessary when making "diagnosis and tests," has been omitted inasmuch as this information is contained in TM 9-754, January 21, 1943.

**92. DESCRIPTION.**

a. The electrical system is operated throughout at 24 volts except for the radio which, in some cases, is 12 volts. The electrical circuit is a one-wire or grounded type, in which the negative side of the battery, generator, and all current consuming devices are grounded to the frame of the vehicle, which acts as a return line. The system, as covered in this manual, consists of two 12-volt batteries, generator, starter motor, instruments, and gages.

**93. TABULATED DATA AND SPECIFICATIONS.**

**a. Starter Motor.**

Make .....	Autolite
Mounting .....	Special, 4-bolt
Drive ratio, over-all, armature to fan ring gear .....	38 to 1
Ratio, between armature and pinion .....	3.55 to 1
Ratio, between pinion and fan ring gear .....	10.7 to 1
Drive .....	Bendix type



**ORDNANCE MAINTENANCE—POWER UNIT ACCESSORIES  
 FOR MEDIUM TANKS M3A4 AND M4A4**

Rotation, viewed from distributor end of power unit . . . . .	Counterclockwise
Teeth, number	
Armature shaft . . . . .	9
Driven gear . . . . .	32
Pinion . . . . .	14
Fan ring gear . . . . .	150
Commutator end head bronze bearing, inside diameter . . . . .	0.626 to 0.627 in.
Armature shaft bronze bearing (in inter- mediate housing), inside diameter . . . . .	1.124 to 1.125 in.
Drive shaft bronze bearing (in inter- mediate housing), inside diameter . . . . .	1.251 to 1.252 in.

**b. Generator.**

Make . . . . .	Autolite
Rotation, viewed from drive end . . . . .	Counterclockwise
Drive, on multiple water pump type power units . . . . .	Single belt from water pump pulley
Drive, on single water pump type power units . . . . .	Double belt from propeller shaft
Diameter of pulley . . . . .	4 in.
Bearings . . . . .	Ball
Generator operation . . . . .	Generates current from 675 rpm on tachometer. When properly controlled by regulator, generator will generate up to 50 amperes from 900 to 2,900 rpm on tachometer.

**94. SECOND ECHELON OPERATIONS.**

a. In view of the fact that many second echelon operations are often performed by ordnance maintenance personnel, the information is not repeated in this manual; therefore, ordnance maintenance personnel should refer to TM 9-754, January 21, 1943, for this information.

**95. ECHELON BREAK-DOWN OF MAINTENANCE.**

a. Refer to paragraph 4.

**CHAPTER 7**  
**ELECTRICAL SYSTEM (Cont'd)**

**Section II**  
**TROUBLE SHOOTING**

	Paragraph
General .....	96
Trouble shooting (electrical system) .....	97

**96. GENERAL.**

a. This section should be used as a quick reference in locating any trouble that occurs. A thorough understanding of the reaction of the various gages and controls will greatly assist in this undertaking. As soon as the trouble is segregated by use of this section, refer to the "Diagnosis and Test" as outlined in the following sections for the particular circuit in question.

**97. TROUBLE SHOOTING (ELECTRICAL SYSTEM).**

**a. Starter Motor Fails to Operate.**

Possible Cause	Possible Remedy
Discharged battery.	Recharge or replace (par. 99 a (1)).
Defective starter motor.	Check (par. 99 a (3) (b)).
Starter solenoid switch inoperative.	Check solenoid operation and replace if necessary (par. 99 a (2)).
Open circuit or ground in actuating circuit.	Check actuating circuit and replace defective wiring or unit (par. 99 a (4)).
Open circuit or ground in main circuit.	Check main circuit and replace defective wiring or unit (par. 99 a (3)).

**b. Starter Motor Continues to Operate when Starter Switch Is "OFF."**

Bendix drive pinion stuck on pinion shaft.	Clean or replace Bendix drive (par. 99 b (1)).
Improper connections or short circuit in wiring.	Check and replace defective parts (par. 99 b (2)).

**c. Starter Motor Operates but Pinion Fails to Engage Fan Ring Gear.**

Bendix drive pinion stuck on pinion shaft.	Clean or replace Bendix drive (par. 99 c).
--	--

**ORDNANCE MAINTENANCE—POWER UNIT ACCESSORIES  
FOR MEDIUM TANKS M3A4 AND M4A4**

**d. Generator Does not Charge but Battery Box Circuit Breaker Remains Closed.**

<i>Possible Cause</i>	<i>Possible Remedy</i>
Loose or corroded connections. Instruments inoperative.	Clean and tighten. Check (par. 105 c and d) and replace if necessary.
Drive belt broken or slipping.	Check (par. 105 e) and adjust or replace.
Generator regulator defective.	Check (par. 105 f (1)) and repair or replace.
Open circuit or ground in generator circuit.	Check (par. 105 f (2), (3), and (5)), and replace defective parts.
Defective generator.	Check (par. 105 f (4)) and repair or replace.

**e. Generator Does not Charge and Battery Box Circuit Breaker Opens.**

Ground between battery box circuit breaker and generator regulator.	Check (par. 105 g (1) and (2)) and replace or repair defective part.
---	--

**f. Generator Charge Rate Too Low.**

Loose or corroded connections.	Clean and tighten.
Drive belt slipping.	Check (par. 105 e) and adjust.
Generator defective.	Check (par. 105 h (2)) and repair if necessary.
Generator regulator defective.	Check (par. 105 h (3)) and repair or adjust if necessary.

**g. Generator Charge Rate Too High.**

Generator defective.	Check (par. 105 i (1)) and repair if necessary.
Short circuit between generator and regulator.	Check (par. 105 i (2)) and replace wiring if necessary.
Defective generator regulator.	Check (par. 105 i (3) and (4)) and repair if necessary.

**h. All Gages and Warning Indicator Lights Fail to Operate.**

Open circuit between bus bar and instrument circuit breaker.	Check (par. 122 b (1) and (2)).
Ground in one of the gage circuits.	Check (par. 122 b (3)).

**i. Faulty Operation of Warning Indicator Lights.**

Open circuit between sending unit and warning indicator light.	Check (par. 122 c) and replace or repair where necessary.
--	---

## TROUBLE SHOOTING

Possible Cause	Possible Remedy
Ground between sending unit and warning indicator light.	Check (par. 122 c) and replace or repair where necessary.
Faulty calibration of sending unit.	Replace sending unit.
<b>j. Faulty Operation of Instrument Box Gages.</b>	
Open circuit between sending unit and gage.	Check (par. 122 d) and repair or replace where necessary.
Ground between sending unit and gage.	Check (par. 122 d) and repair or replace where necessary.
Faulty calibration of sending unit or gage.	Replace defective unit.
Improper ground between gage and instrument box.	Check (par. 122 d (7)).
Crossed circuits.	Check (par. 122 d (8)).

ORDNANCE MAINTENANCE—POWER UNIT ACCESSORIES  
FOR MEDIUM TANKS M3A4 AND M4A4

CHAPTER 7

ELECTRICAL SYSTEM (Cont'd)

Section III

STARTER CIRCUIT AND STARTER MOTOR

	Paragraph
Starter circuit .....	98
Diagnosis and tests .....	99
Starter motor .....	100
Starter solenoid switch .....	101
Master battery switch .....	102
Instrument box starter (push button) switch .....	103

98. STARTER CIRCUIT.

a. **Description.** The starter circuit consists of the main circuit and the actuating circuit. The starter main circuit (fig. 195) beginning at the plus terminal of the battery, includes the master battery switch (fig. 196), starter solenoid switch (fig. 196), and starter. The actuating circuit (fig. 195) branches off from the master battery switch and includes the battery box shunt (fig. 196), 6 contact connector, bus bar (fig. 195) in instrument box, starter (push button) switch, and the solenoid coil in the starter solenoid switch.

b. **Operation.** When the instrument box starter switch button is operated, it closes the actuating circuit. Closing of this circuit actuates a plunger in the starter solenoid and closes the main circuit, from battery to starter motor. The use of the actuating circuit obviates the necessity of carrying the starter current to the instrument box starter switch. With the main circuit closed, current flows through to the starter.

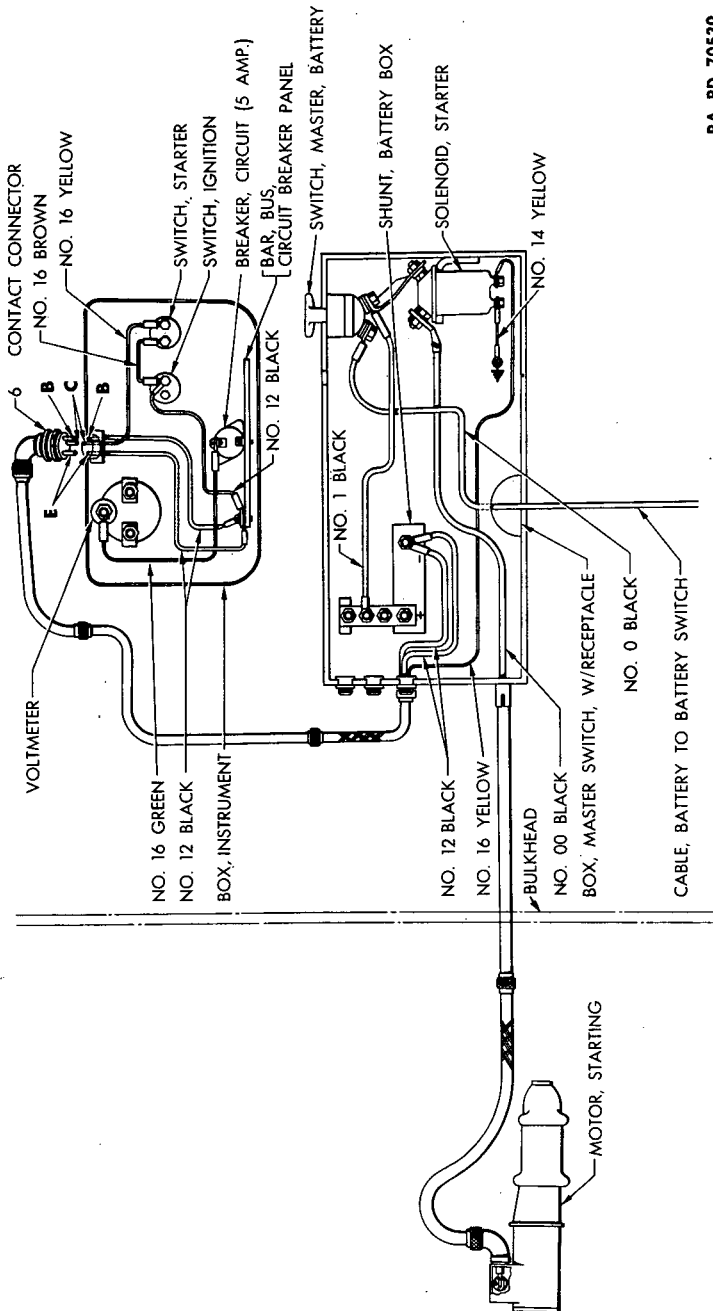
99. DIAGNOSIS AND TESTS.

HYDROMETER, battery  
LAMP, test  
PLIERS, side cutting  
SCREWDRIVER

WRENCH, open-end, 1/4-in.  
WRENCH, open-end, 3/8-in.  
WRENCH, socket, 3/8-in.

**NOTE:** Before starting the procedure as outlined below, the starter circuit diagram (fig. 195) should be thoroughly studied to assist in understanding each circuit and why each step is taken. In order to simplify instructions, the various steps are listed in the sequence in which tests are to be made. Follow these steps, in the order listed, when making the tests.

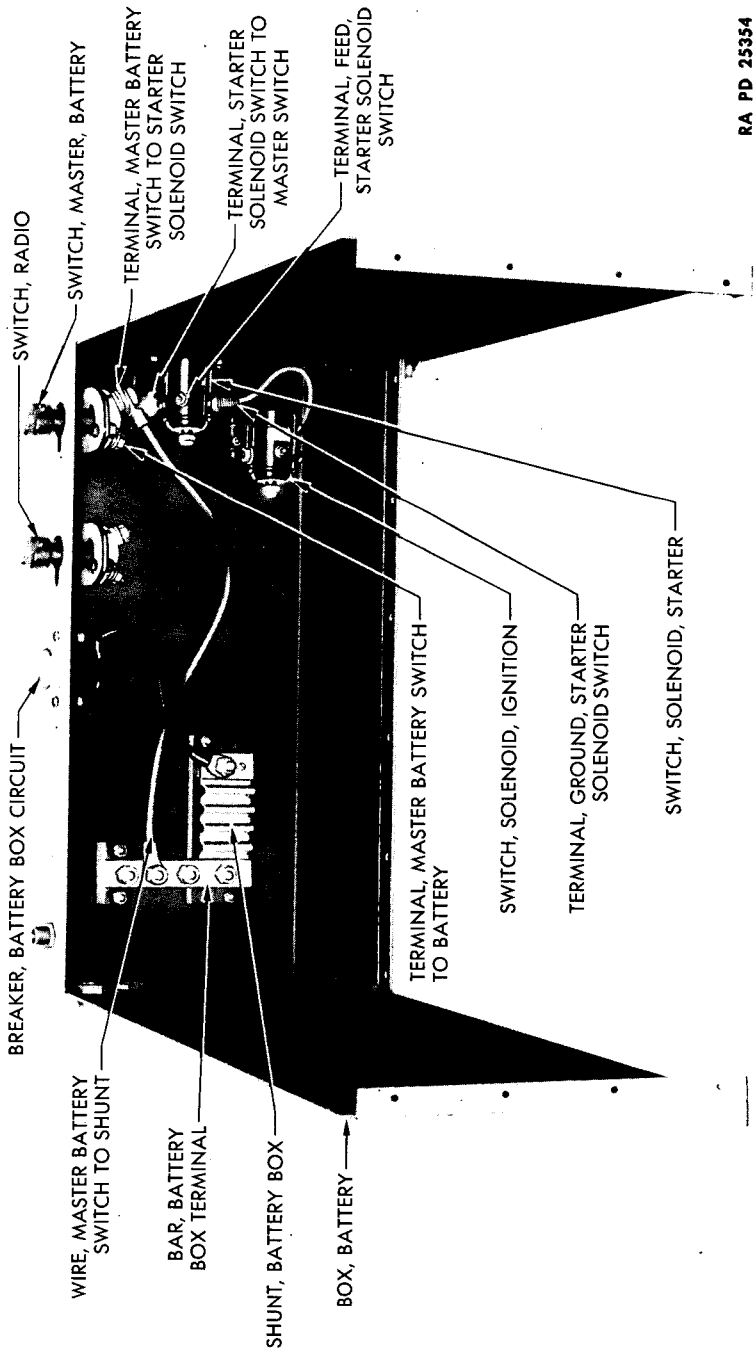
STARTER CIRCUIT AND STARTER MOTOR



RA PD 70530

Figure 195—Starter Circuit

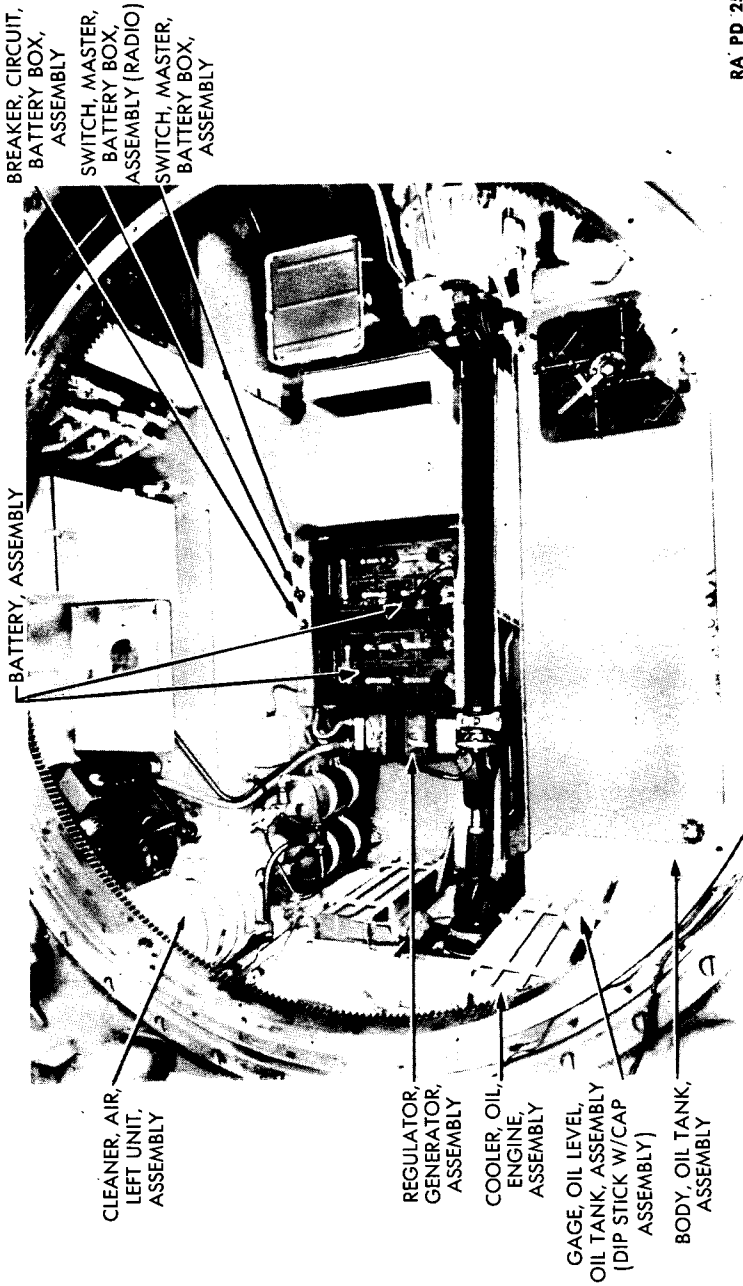
**ORDNANCE MAINTENANCE—POWER UNIT ACCESSORIES  
FOR MEDIUM TANKS M3A4 AND M4A4**



RA PD 25354

**Figure 196—Battery Box and Controls**

STARTER CIRCUIT AND STARTER MOTOR



RA PD 25584

Figure 197—Location of Batteries and Generator Regulators



**ORDNANCE MAINTENANCE—POWER UNIT ACCESSORIES  
FOR MEDIUM TANKS M3A4 AND M4A4****a. Starter Motor Fails to Operate.****(1) CHECK BATTERY (fig. 197).**

Using a hydrometer, check the specific gravity of the battery which should not be lower than 1.250. Replace or charge with auxiliary generator, if necessary, and recheck for starter operation.

**(2) CHECK SOLENOID SWITCH OPERATION.**

With master battery switch closed, have starter switch push button operated and listen for click in starter solenoid switch located in battery box control compartment (fig. 196). If click is heard, proceed to check main circuit. If click is not heard, proceed to check actuating circuit.

**(3) CHECK MAIN CIRCUIT.**

With master battery switch closed, touch one lead of test lamp to ground and other test lamp lead to the following terminals in order listed:

**(a) Large Terminal on Solenoid Switch Which Connects to Master Battery Switch (fig. 196).**

Lamp should burn without starter switch push button being operated. If lamp does not burn, touch the following two points with the test lamp lead. If test lamp burns, proceed to test (b) below.

**1. Terminal on Master Battery Switch Which Connects to Solenoid Switch (fig. 196).**

Lamp should burn without starter switch push button being operated. If lamp burns, trouble is between master battery switch and solenoid switch. If lamp does not burn, proceed as follows:

**2. Terminal on Master Battery Switch (fig. 196) Which Leads to Battery.**

Lamp should burn without starter switch push button being operated. If lamp burns, trouble is in master battery switch. If lamp does not burn, trouble is in No. 0 black wire from battery to master battery switch.

**(b) Terminal on Solenoid Switch Which Connects to Starter (fig. 195).**

Have starter switch push button operated. If lamp does not burn, trouble is in the solenoid switch. If lamp burns, proceed to substep (c).

**(c) Terminal on Starter Motor (fig. 195).**

This terminal can be reached only by removing the terminal shielding box cover (fig. 211) ( $\frac{1}{4}$ -in. open-end wrench and side cutting pliers). Have starter switch push button operated. If lamp burns, trouble is in starter. Inspect starter motor brushes for proper contact by removing head band with screwdriver. If brushes are making proper contact, replace starter (par. 100 c and h). If lamp does not burn, trouble is

**STARTER CIRCUIT AND STARTER MOTOR**

in No. 00 black wire from starter to solenoid switch. NOTE: It will be noted when checking those terminals at which the test lamp burns without the starter switch push button being operated (unless there is an actual break) that when the switch is operated, the lamp dims. If there is a marked difference in the dimming between any two points, it indicates a dirty or high resistance connection or partial ground between the points where the difference occurs. Any complete ground in the starter circuit will result in a burnout or open circuit. If there is evidence of an open circuit due to a burnout, check for the ground (from burnout towards starter) before replacing the burned out part.

**(4) CHECK ACTUATING CIRCUIT.**

With main switch closed, touch one lead of test lamp to ground; touch the other lead of test lamp to the small terminal (feed side) of solenoid switch (fig. 196). Have starter switch push button operated. If lamp burns, the actuating circuit up to the solenoid switch is operating. Check the ground connection of the solenoid switch. If this is clean and tight, the solenoid is defective. Replace solenoid. If the lamp does not burn, ground one lead of test lamp and touch the other test lamp lead to the following terminals in the order listed:

*(a) Terminal "C" in 6 Contact Connector Female Side (fig. 195) at Instrument Box (to Which No. 16 Yellow Wire Is Attached).*

Have starter switch push button operated. If lamp burns, trouble is between this point and solenoid switch, in No. 16 yellow wire. If lamp does not burn, proceed to substep (b).

*(b) Terminal on Starter Switch (to Which No. 16 Yellow Wire Is Attached) Which Connects with 6 Contact Connector (fig. 195).*

If lamp burns, trouble is in No. 16 yellow wire from starter switch to 6 contact connector. If lamp does not burn, proceed to substep (c).

*(c) Terminal on Starter Switch Which Connects to Ignition Switch (to Which No. 16 Brown Wire Is Attached) (fig. 195).*

If lamp burns, trouble is in starter switch. If lamp does not burn, proceed to substep (d).

*(d) Terminal on Ignition Switch (to Which No. 16 Brown Wire Is Attached Which Leads to Starter Switch).*

If lamp burns, trouble is in the No. 16 brown wire between ignition switch and starter switch. If lamp does not burn, proceed to substep (e).

*(e) Terminal on Instrument Box Bus Bar (to Which Three No. 12 Black Wires Are Attached) (fig. 195).*

If lamp burns, trouble is in No. 12 black wire from bus bar to ignition switch. If lamp does not burn, proceed to substep (f).

*(f) Terminals "B" and "E" in 6 Contact Connector (to Which No. 12 Black Wires Are Attached) (fig. 195).*

**ORDNANCE MAINTENANCE—POWER UNIT ACCESSORIES  
FOR MEDIUM TANKS M3A4 AND M4A4**

If lamp burns, trouble is between 6 contact connector and bus bar. If lamp does not burn, proceed to substep (g).

(g) *Terminal on Battery Box Shunt (to Which the Two No. 12 Black Wires Are Attached)* (fig. 195).

If lamp burns, trouble is between this terminal and 6 contact connector in instrument box. **CAUTION:** Two black wires are necessary to carry the required voltage; therefore, it is imperative that two wires, of this size, between these two points be used at all times. If lamp does not burn, trouble is between battery box shunt and master switch.

(h) If there is evidence of an open circuit due to a burnout, check for grounds between burnout and solenoid switch before replacing the burned out part.

**b. Starter Motor Continues to Operate When Starter Push Button Switch Is "OFF."**

**NOTE:** To protect starter, turn off ignition switch. If starter continues to operate, turn off master battery switch.

**(1) IF STARTER MOTOR DOES NOT OPERATE AFTER IGNITION SWITCH IS TURNED "OFF."**

With master switch closed, but with ignition switch turned "OFF," press the starter switch push button. If the engine cranks, but without the familiar pinion engagement noise, the pinion is stuck on the pinion shaft. Remove starter motor (par. 100 c, e (7), and h) and clean or replace Bendix drive assembly.

**(2) IF STARTER MOTOR CONTINUES TO OPERATE AFTER THE IGNITION SWITCH IS TURNED "OFF."**

(a) Leave ignition and starter switch "OFF." Remove connections at the following points in order:

**(1) NO. 16 YELLOW WIRE FROM STARTER PUSH BUTTON SWITCH TERMINAL** (fig. 195).

Using a 3/8-inch socket wrench momentarily close master battery switch. If starter does not operate, trouble is in starter switch. If starter operates, open master switch and proceed as follows:

**(2) 6 CONTACT CONNECTOR IN INSTRUMENT BOX** (fig. 195).

Momentarily close master battery switch. If starter does not operate, trouble is in improper connections at 6 contact connector or the No. 16 yellow wire from starter switch to connector being chafed and shorted against a live wire. If starter operates, open master switch and proceed as follows:

**(3) NO. 16 YELLOW WIRE FROM STARTER SOLENOID SWITCH SMALL TERMINAL WHICH LEADS TO THE 6 CONTACT CONNECTOR** (fig. 195).

Using a 3/8-inch open-end wrench momentarily close master battery

**STARTER CIRCUIT AND STARTER MOTOR**

switch. If starter does not operate, trouble is in the No. 16 yellow wire from solenoid switch to 6 contact connector due to an improper connection at connector or being chafed and shorted against a live wire. If starter operates, the trouble is a short circuit in the solenoid switch due to the contacts welding together. Replace solenoid switch.

**c. Starter Motor Operates but Pinion Fails to Engage Fan Ring Gear.**

Pinion gear stuck on pinion shaft due to an accumulation of oil and dust in spiral thread of shaft. Remove starter and clean with SOLVENT, dry-cleaning (par. 100 c, e (7), and h).

**100. STARTER MOTOR.**

**a. Description.** The starter motor is a series motor operating off the 24-volt battery. It is mounted on the power unit between No. 1 engine and No. 2 engine, and extends through an opening in the radiator core to enable it to engage with the fan ring gear. The starter motor (fig. 198) consists of an armature with a gear reduction between armature and drive shaft and a Bendix drive.

**b. Operation.** When current reaches the starter it causes the armature to rotate. This movement travels through the drive shaft and gear and rotates the Bendix drive. Rotation of the Bendix drive forces the pinion out on the screw threads of the pinion shaft until it contacts the stop nut. In this position it is engaged with the fan ring gear and thereby cranks the power unit.

**c. Removal.**

**PLIERS**

**PLIERS, side cutting**

**SCREWDRIVER**

**WRENCH, open-end, 1/4-in.**

**WRENCH, open-end, 3/8-in.**

**WRENCH, socket, 9/16-in.**

**WRENCH, socket, 3/8-in., with 6-in. extension.**

**(1) REMOVE STARTER MOUNTING BOLTS FORWARD OF RADIATOR.**

**PLIERS, side cutting**

**WRENCH, open-end, 3/8-in.**

Remove locking wires (side cutting pliers) and remove the two mounting bolts (3/8-in. open-end wrench).

**(2) DISCONNECT STARTER WIRE.**

**PLIERS**

**WRENCH, open-end, 1/4-in.**

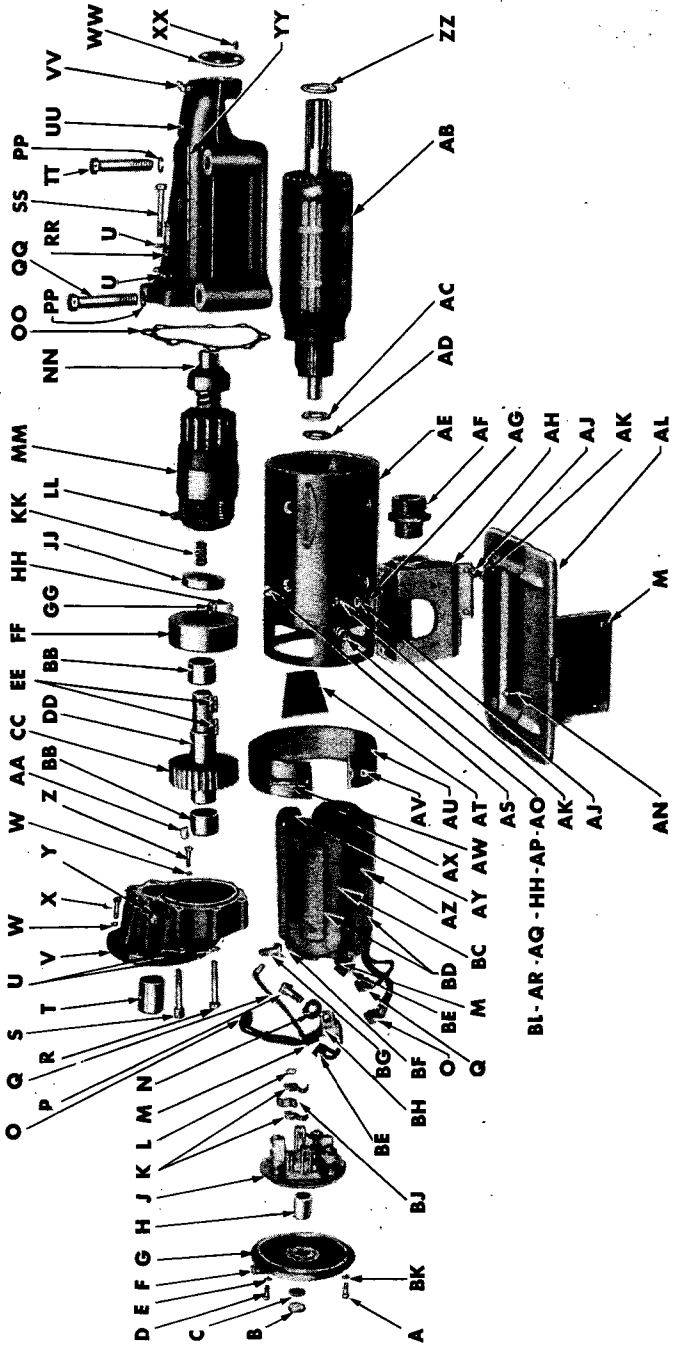
**PLIERS, side cutting**

**WRENCH, socket, 9/16-in.**

**SCREWDRIVER**

Remove locking wires (side cutting pliers) and remove the four screws securing the cover on the terminal shielding box (1/4-in. open-end wrench) (fig. 199). Remove the terminal post nut (9/16-in. socket wrench) and remove wire. Remove titeflex nut on end of the terminal

ORDNANCE MAINTENANCE—POWER UNIT ACCESSORIES  
FOR MEDIUM TANKS M3A4 AND M4A4



RA PD 24562

Figure 198—Parts of Starter Motor

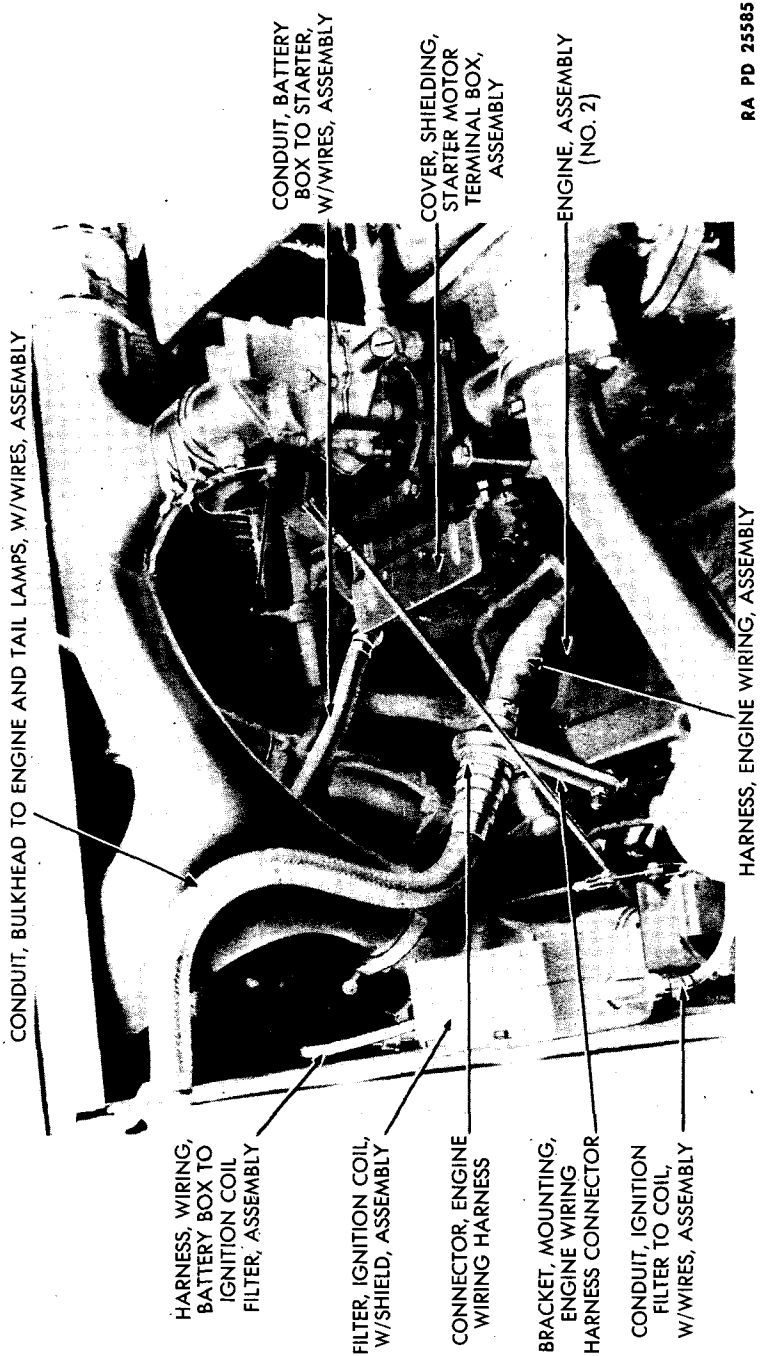
STARTER CIRCUIT AND STARTER MOTOR

- A—SCREW, ATTACHING, STARTER MOTOR COMMUTATOR END HEAD
- B—COVER, BEARING, STARTER MOTOR COMMUTATOR END
- C—PAD, FELT, STARTER MOTOR COMMUTATOR END BEARING
- D—SCREW, ATTACHING, STARTER MOTOR BRUSH HOLDER PLATE
- E—WASHER, LOCK, STARTER MOTOR BRUSH HOLDER PLATE ATTACHING SCREW
- F—OILER, STARTER MOTOR COMMUTATOR END HEAD
- G—HEAD, END, STARTER MOTOR COMMUTATOR, PARTIAL, ASSEMBLY
- H—BEARING, BRONZE, STARTER MOTOR COMMUTATOR END
- J—PLATE, HOLDER, STARTER MOTOR BRUSH, ASSEMBLY
- K—SPRING, BRUSH, STARTER MOTOR
- L—CLIP, HOLDER, STARTER MOTOR BRUSH
- M—BRUSH, STARTER MOTOR, SINGLE PIGTAIL, SHORT
- N—WASHER, INSULATING, STARTER MOTOR BRUSH TERMINAL
- O—BRUSH, STARTER MOTOR, DOUBLE PIGTAIL, LONG
- P—POST, TERMINAL, STARTER MOTOR
- Q—BRUSH, STARTER MOTOR, SINGLE PIGTAIL, LONG
- R—SCREW, HEX. HEAD, STARTER MOTOR PINION HOUSING
- S—SCREW, FILLISTER HEAD, STARTER MOTOR PINION HOUSING
- T—BEARING, SHAFT, STARTER MOTOR ARMATURE
- U—WASHER, LOCK, STARTER MOTOR PINION HOUSING SCREW
- V—HOUSING, INTERMEDIATE, STARTER MOTOR, ASSEMBLY
- W—WASHER, LOCK, STARTER MOTOR INTERMEDIATE HOUSING SCREW
- X—SCREW, STARTER MOTOR INTERMEDIATE HOUSING
- Y—PLUG, PIPE, STARTER MOTOR INTERMEDIATE HOUSING
- Z—SCREW, STARTER MOTOR INTERMEDIATE HOUSING
- AA—PLUG, CORK, STARTER MOTOR INTERMEDIATE HOUSING, INNER
- BB—BEARING, BRONZE, STARTER MOTOR DRIVE SHAFT
- CC—GEAR, DRIVE, STARTER MOTOR
- DD—SHAFT, DRIVE, STARTER MOTOR
- EE—KEY, STARTER MOTOR DRIVE SHAFT
- FF—BEARING, INTERMEDIATE, STARTER MOTOR DRIVE SHAFT
- GG—NUT, STARTER MOTOR TERMINAL POST
- HH—WASHER, PLAIN, STARTER MOTOR TERMINAL POST
- JJ—SEAL, OIL, STARTER MOTOR DRIVE SHAFT BEARING
- KK—SPRING, MESHING, BENDIX DRIVE
- LL—SCREW, LOCK, BENDIX DRIVE
- MM—DRIVE, BENDIX, STARTER MOTOR, ASSEMBLY
- NN—WASHER, THRUST, STARTER MOTOR PINION SHAFT INTERMEDIATE HOUSING
- OO—GASKET, STARTER MOTOR PINION HOUSING TO INTERMEDIATE HOUSING
- PP—WASHER, LOCK, STARTER MOTOR MOUNTING BOLT
- QQ—BOLT, MOUNTING, STARTER MOTOR, REAR
- RR—SCREW, HOUSING, STARTER MOTOR PINION, SHORT
- SS—SCREW, HOUSING, STARTER MOTOR PINION, LONG
- TT—BOLT, MOUNTING, STARTER MOTOR, FRONT
- UU—HOUSING, PINION, STARTER MOTOR, ASSEMBLY
- VV—FITTING, LUBRICATION, STARTER MOTOR PINION HOUSING
- WW—PLATE, BEARING, STARTER MOTOR PINION SHAFT
- XX—SCREW, PLATE, STARTER MOTOR PINION SHAFT BEARING
- YY—LOCKWIRE, MOUNTING BOLT, STARTER MOTOR
- ZZ—WASHER, THRUST, STARTER MOTOR ARMATURE SHAFT, DRIVE END
- AB—ARMATURE, STARTER MOTOR, ASSEMBLY
- AC—WASHER, THRUST, STARTER MOTOR ARMATURE SHAFT, COMMUTATOR END
- AD—WASHER, SHAFT, STARTER MOTOR ARMATURE
- AE—FRAME, STARTER MOTOR
- AF—BUSHING, CONNECTOR, STARTER MOTOR TERMINAL SHIELDING BOX CONDUIT
- AG—PLATE, LOCK, STARTER MOTOR SHIELDING BOX MOUNTING
- AH—BOX, SHIELDING, STARTER MOTOR TERMINAL
- AJ—WASHER, LOCK, STARTER MOTOR TERMINAL SHIELDING BOX TO FRAME SCREW
- AK—SCREW, STARTER MOTOR TERMINAL SHIELDING BOX TO FRAME
- AL—COVER, STARTER MOTOR TERMINAL SHIELDING BOX
- AM—SCREW, STARTER MOTOR TERMINAL SHIELDING BOX COVER TO SHIELDING BOX, SHORT
- AN—SCREW, STARTER MOTOR TERMINAL SHIELDING BOX COVER TO SHIELDING BOX, LONG
- AO—NUT, STARTER MOTOR TERMINAL POST
- AP—WASHER, LOCK, STARTER MOTOR TERMINAL POST
- AQ—WASHER, INSULATING, STARTER MOTOR TERMINAL POST, OUTER
- AR—SCREW, INSULATING, STARTER MOTOR TERMINAL POST
- AS—SCREW, STARTER MOTOR FRAME POLE PIECE
- AT—INSULATION, STARTER MOTOR FIELD CONNECTION
- AU—BAND, HEAD, STARTER MOTOR, ASSEMBLY
- AV—NUT, STARTER MOTOR HEAD BAND SCREW
- AW—SCREW, STARTER MOTOR HEAD BAND
- AX—COIL, FIELD, STARTER MOTOR, LOWER, LEFT
- AY—COIL, FIELD, STARTER MOTOR, LOWER, RIGHT
- AZ—COIL, FIELD, STARTER MOTOR, UPPER, RIGHT
- BC—COIL, FIELD, STARTER MOTOR, PLANE
- BD—PIECE, POLE, STARTER MOTOR, DOUBLE PIGTAIL, SHORT
- BE—BRUSH, STARTER MOTOR, DOUBLE PIGTAIL, SHORT
- BG—CONNECTOR, STARTER MOTOR TERMINAL POST
- BH—POST, TERMINAL, STARTER MOTOR
- BH—TERMINAL, BRUSH, STARTER MOTOR
- BJ—SPACER, PLATE, STARTER MOTOR BRUSH HOLDER
- BK—WASHER, LOCK, STARTER MOTOR COMMUTATOR END HEAD ATTACHING SCREW
- BL—WASHER, PLAIN, STARTER MOTOR TERMINAL POST

RA PD 24562B

Legend for Figure 198—Parts of Starter Motor

ORDNANCE MAINTENANCE—POWER UNIT ACCESSORIES  
FOR MEDIUM TANKS M3A4 AND M4A4



RA PD 25585

Figure 199—Starter Motor Conduit

**STARTER CIRCUIT AND STARTER MOTOR**

shielding box by hand or with pliers and pull out wire from terminal shielding box (tape end of wire to guard against grounding).

(3) REMOVE STARTER MOUNTING BOLTS TO REAR OF RADIATOR AND REMOVE STARTER.

PLIERS, side cutting  
WRENCH, socket,  $\frac{7}{8}$ -in., with 6-in. extension

Remove locking wires (side cutting pliers) and remove the two mounting bolts ( $\frac{7}{8}$ -in. socket wrench, with 6-in. extension). Have two men lift starter from power unit. NOTE: It will be necessary to raise starter  $\frac{1}{4}$  inch to clear dowel pins in bracket.

**d. Disassembly.**

DRIFT  
PRESS, bench  
HAMMER, brass  
SCREWDRIVER  
HAMMER, steel  
WRENCH, open-end,  $\frac{9}{16}$ -in.  
PLIERS, side cutting  
WRENCH, socket,  $\frac{5}{16}$ -in.

(1) REMOVE TERMINAL POST SHIELDING BOX (fig. 211).

PLIERS, side cutting  
WRENCH, open-end,  $\frac{1}{2}$ -in.  
SCREWDRIVER

Remove locking wire (side cutting pliers) and remove three screws and lock washers securing terminal shielding box to starter frame. Remove shielding box.

(2) REMOVE STARTER MOTOR PINION HOUSING (fig. 210).

PLIERS, side cutting  
WRENCH, open-end,  $\frac{1}{2}$ -in.

Remove locking wires (side cutting pliers) and remove the eight cap screws and lock washers securing pinion housing to intermediate housing. Remove gasket.

(3) REMOVE BENDIX ASSEMBLY AND DRIVE GEAR AND SHAFT FROM PINION HOUSING (fig. 209).

PRESS, bench  
SCREWDRIVER

Remove the four screws (screwdriver) securing pinion housing bearing plate and remove plate. Use suitable arbor and press Bendix and drive gear and shaft out of pinion housing.

(4) REMOVE BENDIX ASSEMBLY FROM DRIVE SHAFT (fig. 208).

SCREWDRIVER

Snap the lock wire off the lock screw holding Bendix to drive shaft and remove screw with screwdriver. Pull drive shaft, gear, and intermediate bearing assembly away from Bendix drive. Remove Bendix drive meshing spring from inside Bendix drive.

(5) REMOVE INTERMEDIATE BEARING ASSEMBLY FROM DRIVE SHAFT (fig. 208).

DRIFT  
HAMMER, steel

Remove keys from drive shaft and slide intermediate bearing assembly off shaft.



**ORDNANCE MAINTENANCE—POWER UNIT ACCESSORIES  
FOR MEDIUM TANKS M3A4 AND M4A4**

(6) REMOVE COMMUTATOR END HEAD (fig. 205).

HAMMER, brass  
PLIERS, side cutting  
SCREWDRIVER

Remove locking wires from head band screw, commutator end head screws, and commutator end head brush holder plate screws (side cutting pliers). Remove screw securing head band (screwdriver) and remove band. Lift the brush springs and take the brushes out of their holders. Remove four screws (screwdriver) securing commutator end head and gently tap head off of motor (brass hammer). Remove four screws (screwdriver) securing brush holder plate to commutator end head and remove brush holder plate from head.

(7) REMOVE INTERMEDIATE HOUSING FROM STARTER FRAME (fig. 198).

PLIERS, side cutting  
SCREWDRIVER  
WRENCH, socket,  $\frac{5}{16}$ -in.

Remove lock wires from five cap screws (side cutting pliers) and remove the five cap screws and lock washers ( $\frac{5}{16}$ -in. socket wrench) on outside of intermediate housing. Remove two cork plugs inside housing and remove the two cap screws underneath the plugs with a screwdriver or  $\frac{5}{16}$ -inch socket wrench. Pull housing from starter frame.

(8) REMOVE ARMATURE (fig. 198).

Lift out armature and thrust washers. *The field coils and starter frame are dipped and baked as one piece and should not be disassembled.*

**e. Inspection and Repair.**

COPPER, soldering	PRESS, bench
GROWLER, Federal Stock No. 17-G-5940	SCALE, spring
LAMP, test	SCREWDRIVER
LATHE	TOOL, special, for installing bearings (3)
PLIERS, clinching	WRENCH, open-end, $\frac{9}{16}$ -in.

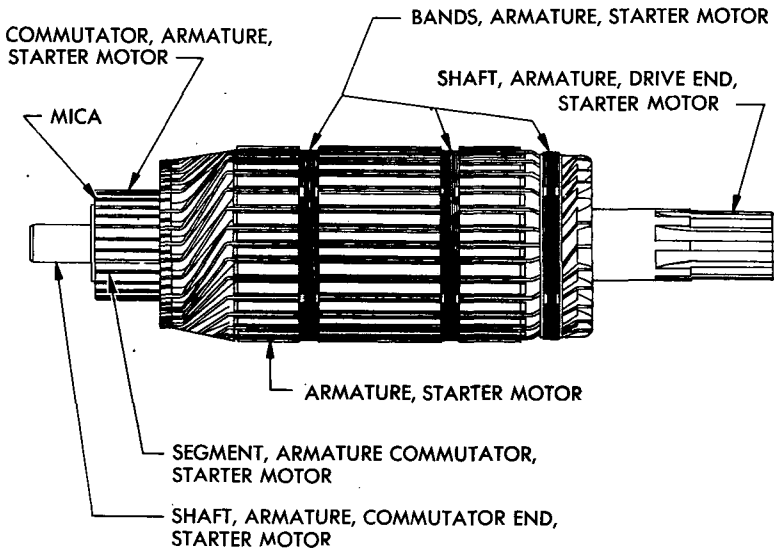
(1) INSPECT ARMATURE (fig. 200).

GROWLER, Federal Stock No. 17-G-5940  
LAMP, test  
LATHE

(a) Inspect armature and commutator for evidence of wear. Inspect the insulation and soldering to make sure all coils are in proper working order. Inspect bands to make sure they are tight. Make sure the coils are properly staked to the commutator slots. If armature shaft or gear is worn, the armature should be replaced.

(b) If commutator is dirty or discolored it can be cleaned by holding a piece of No. 00 sandpaper against it while turning armature slowly. If commutator is worn or rough it should be turned on a lathe. Take only

**STARTER CIRCUIT AND STARTER MOTOR**



RA PD 25882

**Figure 200—Starter Motor Armature—Side View**

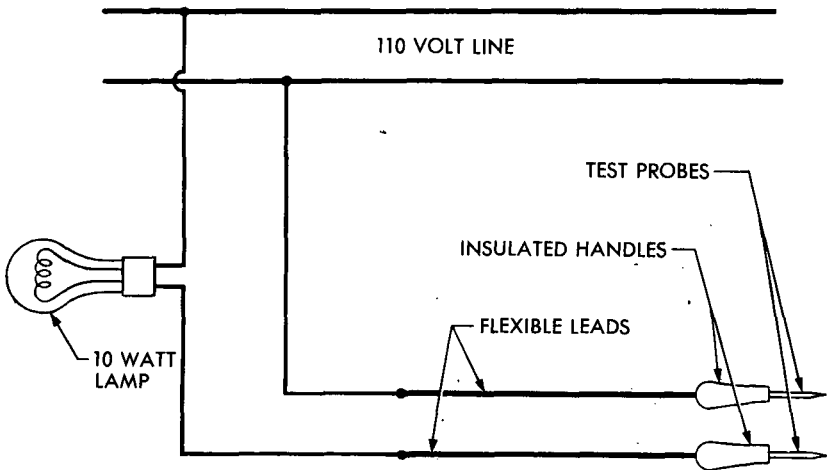
a light cut with the armature mounted on the bearing seats *and not on the shaft centers*. Remove all burrs from the commutator and undercut the mica to a depth of  $\frac{1}{32}$  inch. This undercut must be square and free from burrs.

(c) Check the armature for grounds with test probes, consisting of a lamp in series with two test probes (fig. 201). Touch one probe to the shaft and touch each commutator segment (fig. 200) in turn with the other probe. If a ground is present the lamp will burn. *Do not touch the probes to the bearing or brush surface as an arc would burn the smooth finish*. Replace armature if ground is found.

(d) Check the armature for an open circuit by touching one of the test probes to a commutator segment, and with the other probe find the two bars (fig. 200) approximately opposite that will cause the lamp to burn. If only one bar can be found that causes the lamp to burn, a coil is open circuited and the armature must be replaced. Repeat this test on all the bars.

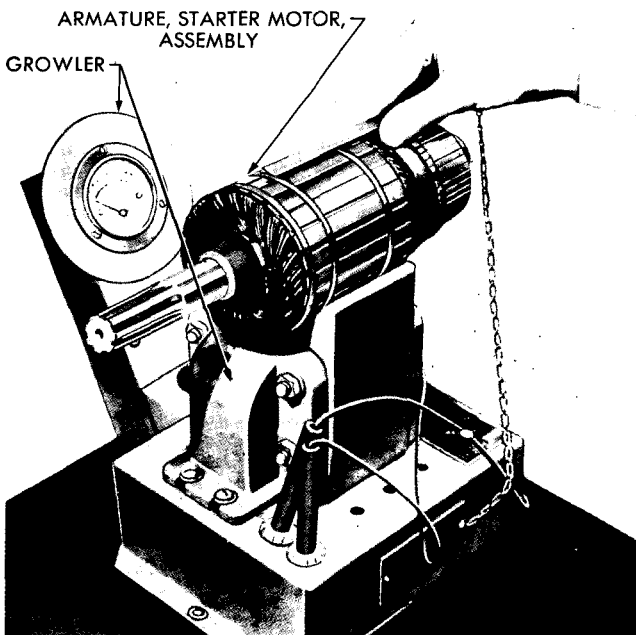
(e) Check the armature for shorts on a growler (Federal Stock No. 17-G-5940) (fig. 202). Place the armature on the growler and hold a steel strip on the core. Rotate the armature slowly and, if a short is present, the steel strip will vibrate. Replace armature if short is found.

ORDNANCE MAINTENANCE—POWER UNIT ACCESSORIES  
FOR MEDIUM TANKS M3A4 AND M4A4



RA PD 24635

Figure 201—Test Lamp



RA PD 25456

Figure 202—Testing Starter Motor Armature on Growler

**STARTER CIRCUIT AND STARTER MOTOR****(2) INSPECT STARTER FRAME AND FIELDS (fig. 198).****COPPER**, soldering**SCREWDRIVER****LAMP**, test**WRENCH**, open-end,  $\frac{1}{16}$ -in.**PLIERS**, clinching

(a) Clean starter frame with **SOLVENT**, dry-cleaning, and inspect for cracks.

(b) Inspect the brushes. If they are oil-soaked or are worn to less than  $\frac{3}{8}$  inch in length, they must be replaced. If brush pigtails are broken or insulation frayed, new brushes must be installed. To remove the grounded brushes (fig. 202), unsolder the brush pigtails from the terminal. Clinch the new brush pigtails securely and solder to make a good contact. To remove the insulated brushes (fig. 203) unclinch and unsolder the brush pigtails from the field coil and insert the new brush pigtail to its full depth in the field coil loop. Clinch and solder in order to make a strong, low resistance connection.

(c) Check the field coils and terminal post for grounds and open circuits.

1. Make sure the insulated brushes are not touching the frame or grounded brushes and then touch one probe of test lamp to the insulated terminal post (fig. 203) and the other probe to the frame. If the lamp burns, a ground is present. Remove insulated terminal ( $\frac{1}{16}$ -in. open-end wrench) if ground is present and check the field coils for ground by touching the probes to an insulated brush (fig. 203) and the frame. If the lamp burns, the coils are grounded and the frame and field assembly must be replaced. If the lamp does not burn, the ground is in the insulated terminal post. Install terminal post, using new insulating washers and bushing ( $\frac{1}{16}$ -in. open-end wrench). Recheck for ground by touching one probe of test lamp to insulated terminal post and other probe to starter frame. If the lamp does not burn, the trouble has been corrected.

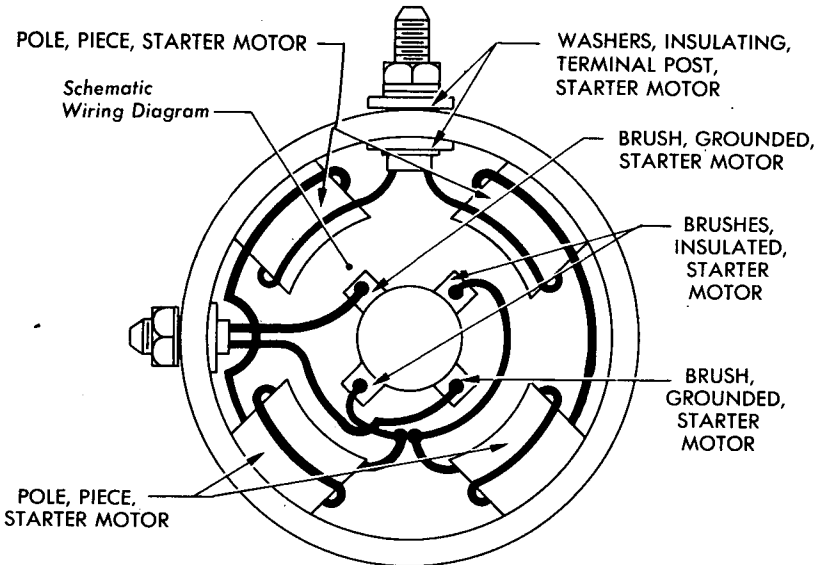
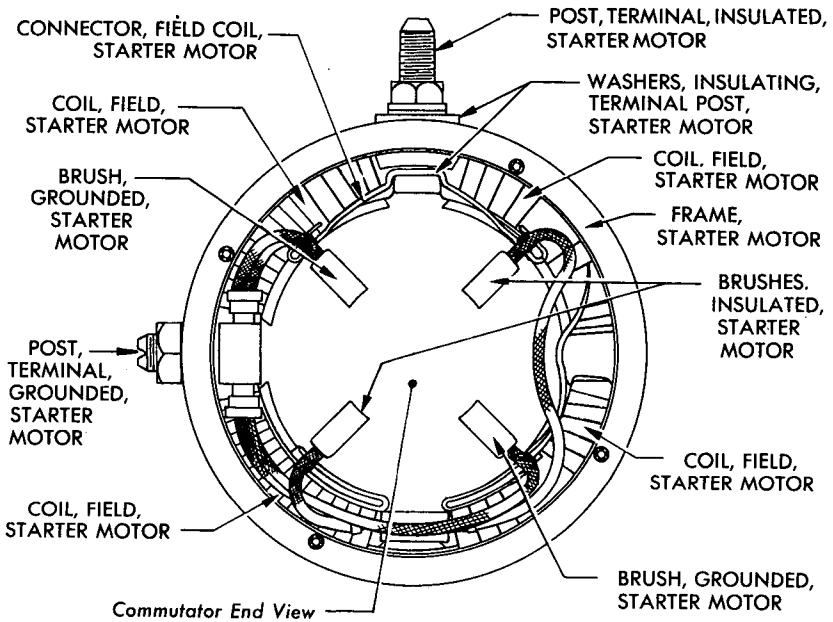
2. Check the field coils (fig. 203) for an open circuit by touching one of the test lamp probes to the insulated terminal post and the other probe to an insulated brush. If lamp burns, field coils are not open circuited. If lamp does not burn, coils are open circuited and the starter frame and field coils must be replaced.

**(3) INSPECT COMMUTATOR END HEAD AND BRUSH HOLDER PLATE.****LAMP**, test**TOOL**, special, for installing**PRESS**, bench

bearing

(a) Clean the commutator end head and brush holder plate (fig. 204) thoroughly with **SOLVENT**, dry-cleaning, and inspect for wear or cracks. Inspect the brush holders for distortion and replace plate if this condition

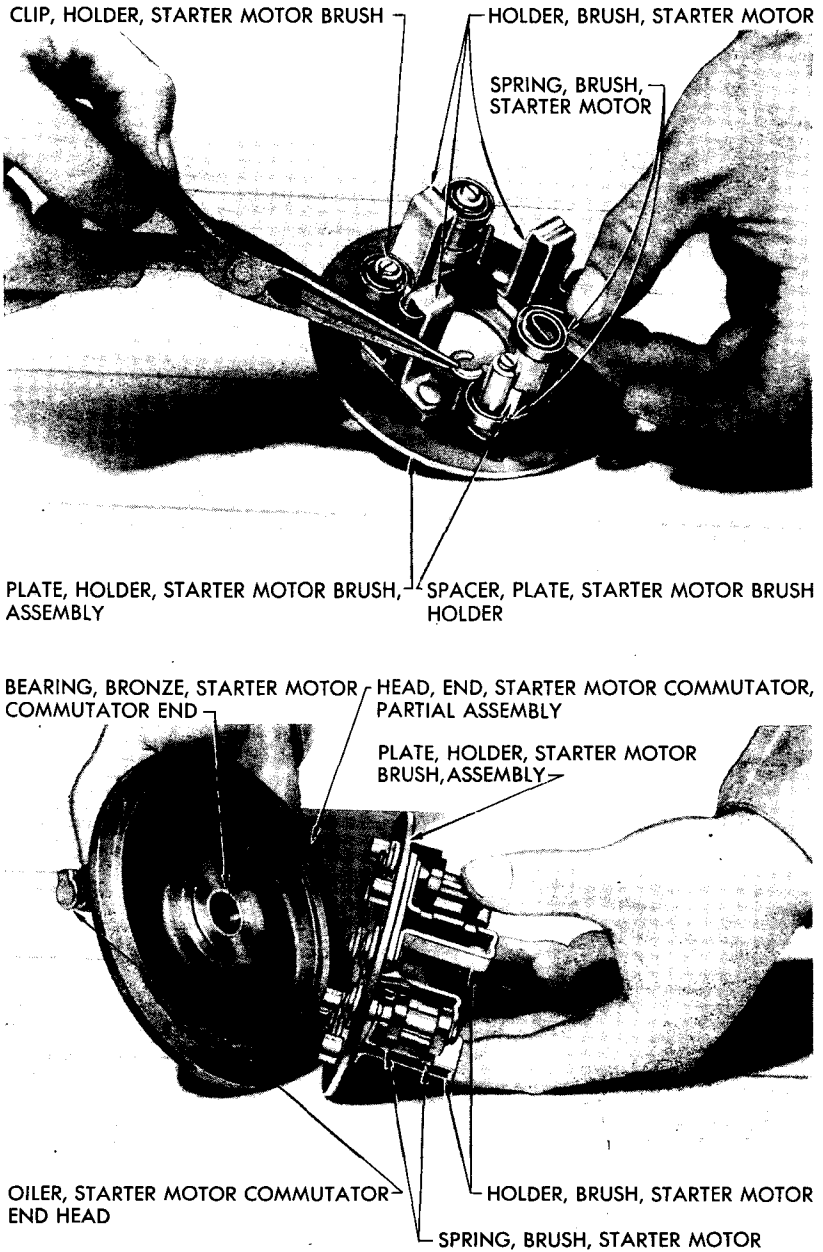
**ORDNANCE MAINTENANCE—POWER UNIT ACCESSORIES  
FOR MEDIUM TANKS M3A4 AND M4A4**



RA PD 25881

**Figure 203—Starter Motor Wiring Diagram**

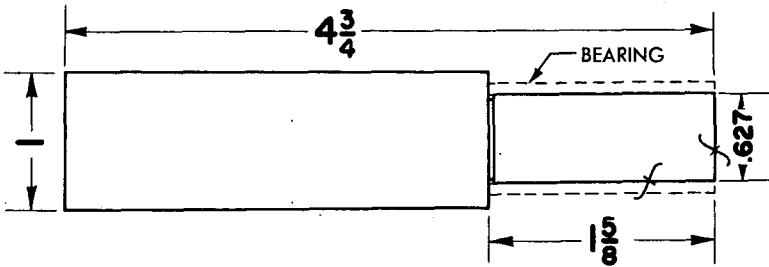
**STARTER CIRCUIT AND STARTER MOTOR**



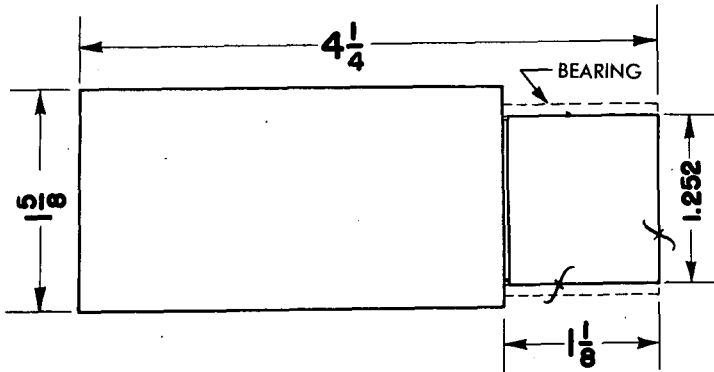
RA PD 25366

**Figure 204—Brush Plate Holder to Commutator End Head Assembly**

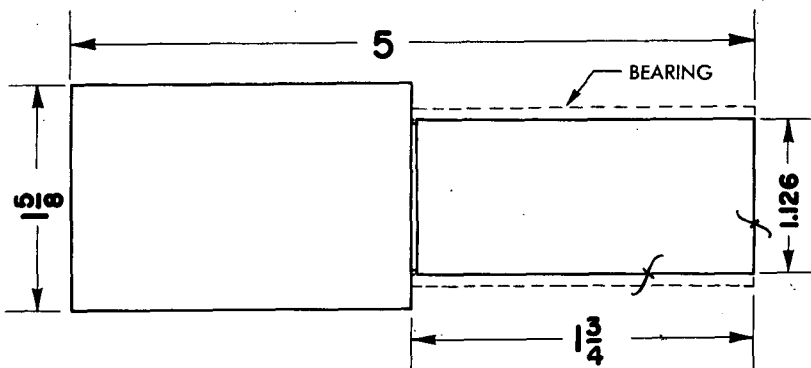
**ORDNANCE MAINTENANCE—POWER UNIT ACCESSORIES  
FOR MEDIUM TANKS M3A4 AND M4A4**



**SPECIAL ARBOR FOR INSTALLING STARTER  
MOTOR DRIVE SHAFT BRONZE BEARING**



**SPECIAL ARBOR FOR INSTALLING STARTER MOTOR  
COMMUTATOR END HEAD BRONZE BEARING**

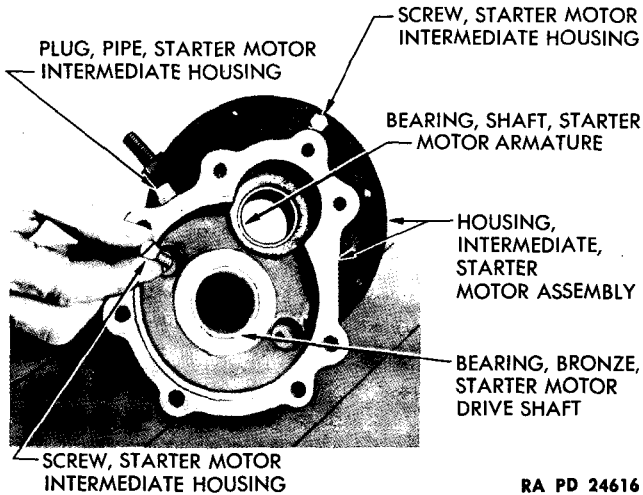


**SPECIAL ARBOR FOR INSTALLING STARTER  
MOTOR ARMATURE SHAFT BRONZE BEARING  
(IN INTERMEDIATE HOUSING)**

RA PD 25876

**Figure 205—Special Arbors for Installing Starter Motor Bearings**

**STARTER CIRCUIT AND STARTER MOTOR**



RA PD 24616

**Figure 206—Location of Armature Shaft and Drive Shaft Bearings**

is found. If bronze bearing in commutator end head has an inside diameter greater than 0.627 inch, press out old bearing and install new bearing using a tool as shown in figure 205. Place bearing on tool and press into place using bench press. This tool holds bearing in shape while being installed and insures that bearing is properly positioned in commutator end head.

(b) Install brush holder plate to commutator end head (fig. 204) and secure with four screws (screwdriver). Check for grounds by touching one probe of test lamp to commutator end head and other probe to each of the brush holders (fig. 204). If lamp burns, the holder is grounded and brush holder plate should be replaced.

(c) Install the commutator end head on the armature with the thrust washers between the head and commutator. Install a pair of spare brushes in the holder and inspect the alinement of the brushes with the commutator segments. If the brushes are not in perfect line with the commutator, the brush holder plate must be replaced.

(d) Check the brush spring tension with a spring scale. Fasten the scale under the spring and pull on a line parallel to the face of the brush. Take the reading just as the spring leaves the brush. This tension must be between 40 and 50 ounces. Adjustment can be made by bending the spring where it enters the spring holder (fig. 204). Check all the springs.

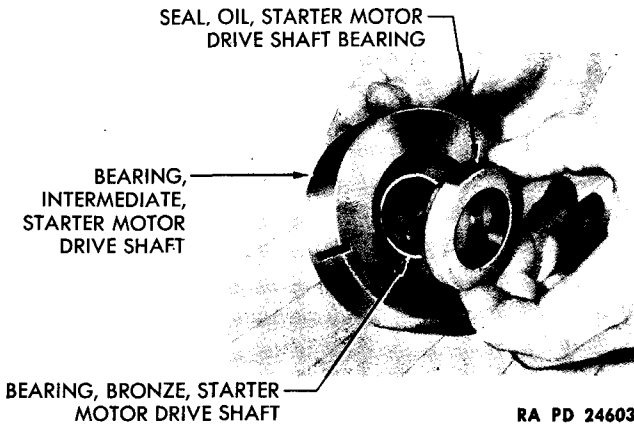
(4) **INSPECT INTERMEDIATE HOUSING** (fig. 206).

PRESS, bench

TOOL, special, for installing bearings



**ORDNANCE MAINTENANCE—POWER UNIT ACCESSORIES  
FOR MEDIUM TANKS M3A4 AND M4A4**



**Figure 207—Oil Seal in Intermediate Drive Shaft Bearing Installation**

(a) Clean the housing thoroughly with SOLVENT, dry-cleaning, and inspect for cracks or worn bearings.

(b) If the armature shaft bearing has an inside diameter greater than 1.125 inch, or if the drive shaft bearing is greater than 1.252 inch, they must be replaced. Press out the armature shaft bearing (bench press) and, using a puller, remove the drive shaft bearing. Use the appropriate tool as shown in figure 205 and after placing the new bearing on the tool, use a bench press and press bearing into place. The special tool will hold the bearing in shape while installing, and insure that the bearing is properly positioned in housing. Bearings must be flush with face of housing.

(5) INSPECT DRIVE SHAFT INTERMEDIATE BEARING ASSEMBLY (fig. 207).

PRESS, bench

TOOL, special, for installing bearing

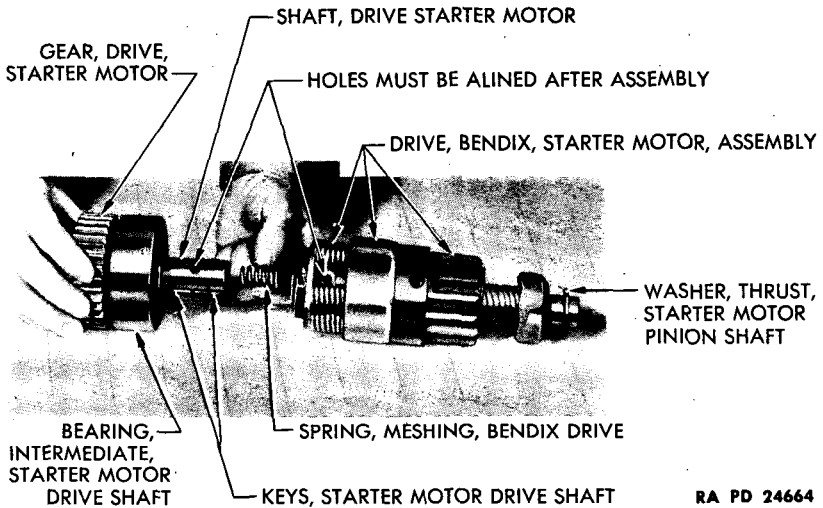
Clean the intermediate bearing assembly and check for wear. If the bronze bearing inside diameter is greater than 1.252 inch, it must be replaced. Using a bench press and suitable arbor, press out the bearing. Using the suitable tool as shown in figure 205, place new bearing on tool and press into place. The special tool will hold the bearing in shape and insure that the bearing is properly positioned.

(6) INSPECT DRIVE SHAFT AND GEAR (fig. 208).

PRESS, bench

(a) Clean the drive shaft and gear with SOLVENT, dry-cleaning, and inspect for wear.

**STARTER CIRCUIT AND STARTER MOTOR**



**Figure 208—Assembling Drive Shaft to Bendix Assembly**

(b) If gear teeth are worn or broken, press gear off the drive shaft with a bench press and press on a new gear.

(7) **INSPECT BENDIX DRIVE** (fig. 208).

(a) Clean the Bendix drive with clean cloth and SOLVENT, dry-cleaning. **CAUTION:** Do not allow SOLVENT, dry-cleaning, to enter Bendix clutch.

(b) Inspect Bendix drive for distorted springs or excessive wear of pinion or pinion shaft. Replace Bendix drive if any of these conditions is found. **CAUTION:** Do not attempt to disassemble Bendix drive assembly.

**f. Assembly.**

**GUN**, grease

**HAMMER**

**PLIERS**, side cutting

**SCREWDRIVER**

**WRENCH**, open-end, 1/2-in.

**WRENCH**, socket, 5/16-in.

(1) **INSTALL ARMATURE, COMMUTATOR END HEAD, AND INTERMEDIATE HOUSING TO STARTER FRAME.**

**PLIERS**, side cutting

**WRENCH**, socket, 5/16-in.

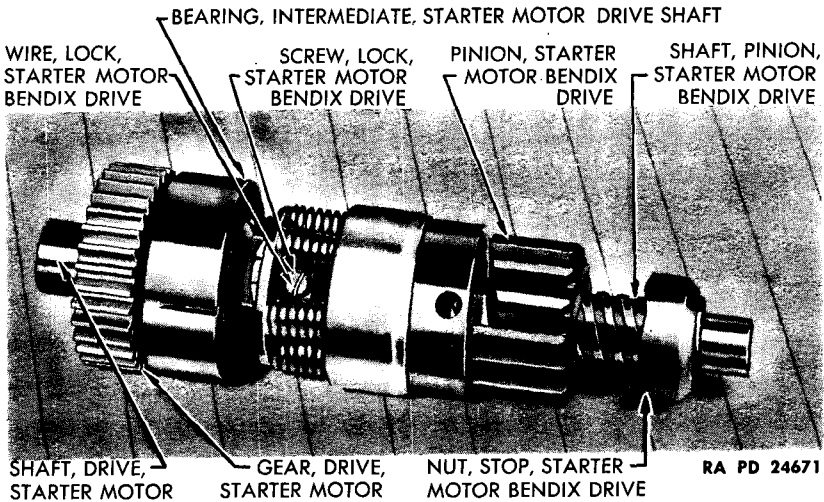
**SCREWDRIVER**

(a) Soak bearings in medium engine oil and wipe off the excess oil.

(b) Place armature inside the frame and field coils.

(c) Install thrust washer on intermediate housing end of armature shaft. Position intermediate housing (fig. 206) on frame and armature

**ORDNANCE MAINTENANCE—POWER UNIT ACCESSORIES  
FOR MEDIUM TANKS M3A4 AND M4A4**



**Figure 209—Drive Shaft and Bendix Assembled**

shaft and secure with five cap screws and lock washers ( $\frac{5}{16}$ -in. socket wrench) on outside of housing and two cap screws and lock washers inside housing (screwdriver or  $\frac{5}{16}$ -in. socket wrench).

(d) Install fiber thrust washer and then steel thrust washer on commutator end of armature shaft (fig. 198). Position the commutator end head (fig. 204) on the starter frame, and secure with four screws (screwdriver).

(e) Check end play of armature shaft. If end play is not between 0.005 to 0.030 inch, remove commutator end head and install the correct fiber washer to give this end play.

(f) Install lock wires (side cutting pliers) in intermediate housing screws, commutator end head screws, and brush holder plate screws. Install cork plugs tightly against the two screws inside intermediate housing.

(g) Install the felt pad in bearing opening in commutator end head and install the bearing cover so that the oil drain hole is at bottom (fig. 211).

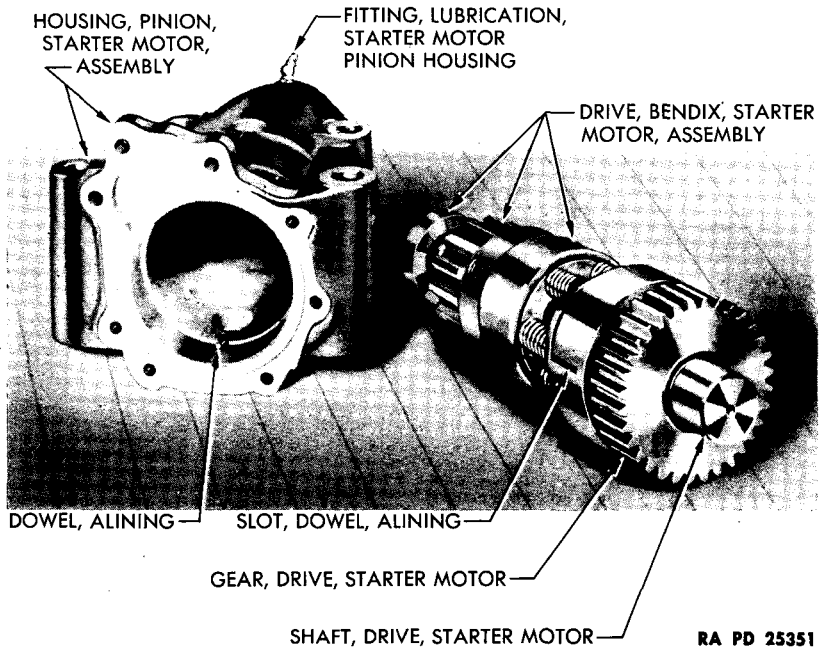
**(2) INSTALL BRUSHES IN THEIR HOLDERS.**

Lift up brush springs and slip brushes into place.

**(3) INSTALL OIL SEAL IN INTERMEDIATE BEARING AND INSTALL BEARING ASSEMBLY ON DRIVE SHAFT.**

**HAMMER**

**STARTER CIRCUIT AND STARTER MOTOR**



**Figure 210—Location of Alining Dowel and Slot**

(a) Install oil seal in intermediate bearing. Drive in carefully to avoid distorting the seal (hammer) (fig. 207).

(b) Install bearing assembly on drive shaft (fig. 208); and place keys in shaft.

**(4) INSTALL DRIVE SHAFT AND GEAR TO BENDIX DRIVE.**

(a) Slide drive shaft into Bendix after placing meshing spring in Bendix (fig. 208).

(b) Tighten the lock screw which secures Bendix to drive shaft (fig. 209) (screwdriver). Snap lock wire over screw.

**(5) INSTALL BENDIX IN PINION HOUSING AND ATTACH PINION HOUSING TO INTERMEDIATE HOUSING.**

**GUN**, grease

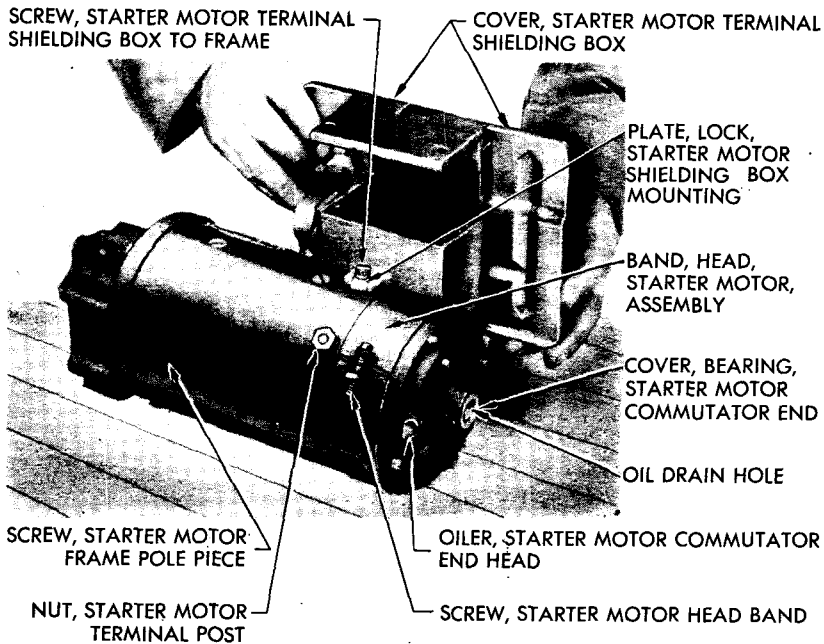
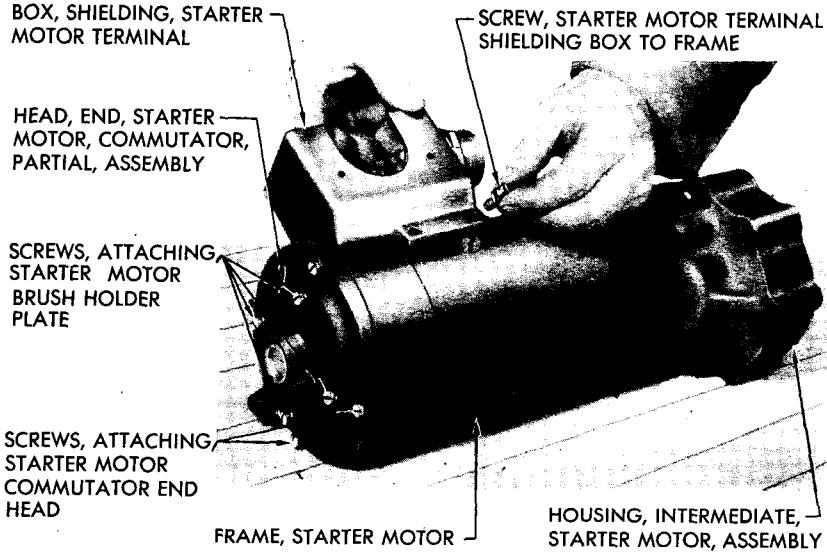
**PRESS**, bench

**PLIERS**, side cutting

**WRENCH**, open-end, ½-in.

(a) Slide Bendix into pinion housing. Turn intermediate bearing assembly so that dowel pin in housing fits into slot in bearing (fig. 210). Press bearing assembly down against shoulder in pinion housing (bench press). Cover the drive gear teeth with a high melting point gear grease. Install gasket on pinion housing and position pinion housing to inter-

**ORDNANCE MAINTENANCE—POWER UNIT ACCESSORIES  
FOR MEDIUM TANKS M3A4 AND M4A4**

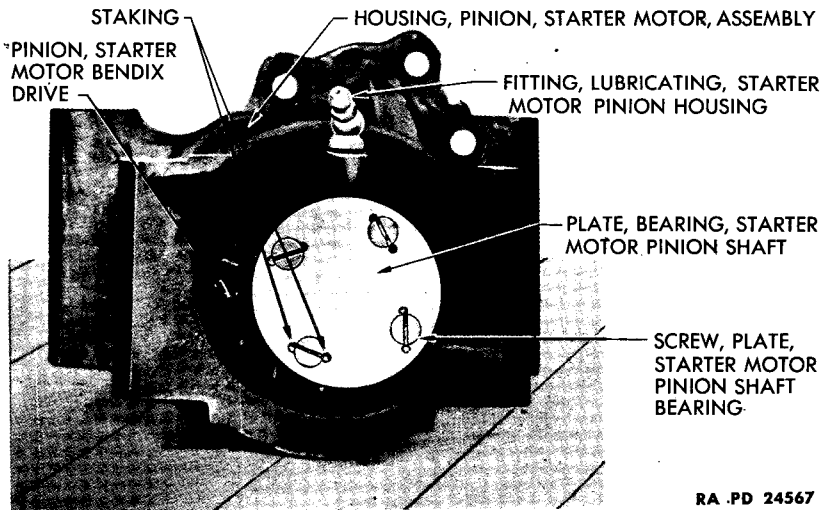


RA PD 25371

**Figure 211—Shielding Box and Cover to Frame Assembly**



**ORDNANCE MAINTENANCE—POWER UNIT ACCESSORIES  
FOR MEDIUM TANKS M3A4 AND M4A4**



**Figure 212—Staking Pinion Shaft Bearing Plate Attaching Screws**

**(1) INSTALL STARTER MOTOR ON POWER UNIT.**

**PLIERS**, side cutting

**WRENCH**, socket,  $\frac{7}{8}$ -in., with

**WRENCH**, open-end,  $\frac{7}{8}$ -in.

6-in. extension

Lift starter motor into position and slip over dowel pins in bracket. Secure with the four mounting bolts ( $\frac{7}{8}$ -in. open-end wrench for the two bolts forward of radiator and  $\frac{7}{8}$ -in. socket wrench, with 6-in. extension for two bolts to rear of radiator). Install locking wires through holes in heads of mounting bolts (side cutting pliers).

**(2) CONNECT STARTER WIRE AND INSTALL SHIELDING BOX COVER.**

**PLIERS**

**WRENCH**, open-end,  $\frac{1}{4}$ -in.

**PLIERS**, side cutting

**WRENCH**, socket,  $\frac{5}{16}$ -in.

**SCREWDRIVER**

Install wire in terminal shielding box and secure with titeflex nut on end of terminal shielding box (pliers). Untape end of wire and install on terminal post and secure with terminal post nut, plain washer, and lock washer ( $\frac{5}{16}$ -in. socket wrench). Install terminal shielding box cover (fig. 211) and secure with four screws ( $\frac{1}{4}$ -in. open-end wrench). Install locking wires (side cutting pliers).

**101. STARTER SOLENOID SWITCH.**

**a. Description.** The starter solenoid switch is mounted in the battery box control compartment (fig. 196). Its operation is controlled by

**STARTER CIRCUIT AND STARTER MOTOR**

the actuating circuit. The solenoid switch consists of two heavy alloy headed studs, contacted by a heavy copper contactor plate fastened to a plunger that is forced down against the pressure of a coiled spring by a solenoid coil.

b. When the actuating circuit is closed, by operating the starter switch push button, the current in the solenoid coil forces the contactor plate and plunger down against the coiled spring until contact is made with the two studs. This closes the main circuit and allows current to flow from the battery to the starter motor.

**c. Removal.**

SCREWDRIVER  
WRENCH, open-end,  $\frac{3}{8}$ -in.                      WRENCH, open-end,  $\frac{1}{2}$ -in.  
WRENCH, open-end,  $\frac{5}{8}$ -in.                      WRENCH, open-end,  $\frac{5}{8}$ -in.

(1) REMOVE BATTERIES.

SCREWDRIVER  
WRENCH, open-end,  $\frac{1}{2}$ -in.                      WRENCH, open-end,  $\frac{5}{8}$ -in.

Open master battery switch. Loosen nuts which secure wire connector to battery post ( $\frac{1}{2}$ -in. open-end wrench). Insert screwdriver in opening in split connector, to spread connector. Lift wire free of battery post. CAUTION: Do not twist wire connector to loosen, as this is likely to twist the battery terminal off its connection to plates, thereby ruining battery. Remove two nuts from battery hold-down straps ( $\frac{5}{8}$ -in. open-end wrench) and lift batteries out of box.

(2) LIFT OUT SLIDING PANEL BETWEEN BATTERIES AND CONTROLS.

(3) DISCONNECT STRAP AND WIRES.

WRENCH, open-end,  $\frac{3}{8}$ -in.                      WRENCH, open-end,  $\frac{5}{8}$ -in.

Remove nut from forward terminal on battery switch and disconnect wire and strap from terminal ( $\frac{5}{8}$ -in. open-end wrench). Remove nut from large terminal post on solenoid switch (which leads to starter, (No. 00 black wire) and disconnect wire ( $\frac{5}{8}$ -in. open-end wrench)). Remove the two small nuts from the terminals to which the No. 16 and No. 14 yellow wires attach, and remove wires ( $\frac{3}{8}$ -in. open-end wrench).

(4) REMOVE SWITCH FROM BATTERY BOX (fig. 196).

SCREWDRIVER                      WRENCH, open-end,  $\frac{3}{8}$ -in.

Hold nuts with  $\frac{3}{8}$ -inch open-end wrench, inside box, and remove the two screws which secure switch to battery box (screwdriver).

**d. Inspection and Tests.**

AMMETER, 200-ampere                      RHEOSTAT, carbon pile  
BATTERY, 12-volt (2)                      VOLTMETER, 30-volt



**ORDNANCE MAINTENANCE—POWER UNIT ACCESSORIES  
FOR MEDIUM TANKS M3A4 AND M4A4**

**(1) CLEAN SOLENOID SWITCH AND TERMINALS THOROUGHLY.**

Use SOLVENT, dry-cleaning, and clean cloth. Make sure all terminals are clean and bright to insure good connections.

**(2) VOLTAGE TESTS.**

AMMETER, 200-ampere

RHEOSTAT, carbon pile

BATTERY, 12-volt (2)

VOLTMETER, 30-volt

(a) Connect a carbon pile rheostat and two 12-volt batteries in series with the two terminals to which the No. 16 and No. 14 yellow wires attach. Connect a voltmeter between the two terminals. Increase the voltage slowly and note the voltmeter reading when switch closes, as indicated by a click. Reduce the voltage slowly, noting the opening voltage. The switch should operate at the following figures: All M3A4 and M4A4 up to and including serial No. M4A4-16559, closing volts 12.5 to 15.5, opening volts 1.5 to 2.0. After serial No. M4A4-16559, closing volts 8.0 to 12.0, opening volts 0.5 to 3.0. Replace the switch if it does not operate at the above figures.

(b) Connect the batteries, carbon pile rheostat, and 200-ampere ammeter in series with the two large terminals of the solenoid switch. Connect the voltmeter across the two large terminals. Connect the two small terminals to the batteries. Adjust the current to 100 amperes and read the voltmeter. If the voltmeter shows a reading larger than 0.05 volts, replace the solenoid switch.

**e. Installation.**

SCREWDRIVER

WRENCH, open-end, 1/2-in.

WRENCH, open-end, 3/8-in.

WRENCH, open-end, 5/8-in.

**(1) INSTALL SWITCH IN BATTERY BOX (fig. 196).**

SCREWDRIVER

WRENCH, open-end, 3/8-in.

Position switch in battery box and secure with two screws, using screwdriver and 3/8-inch open-end wrench.

**(2) CONNECT STRAP AND WIRES.**

WRENCH, open-end, 3/8-in.

WRENCH, open-end, 5/8-in.

Install the No. 16 and No. 14 yellow wires on the two small terminals (fig. 195) and secure with nuts and lock washers (3/8-in. open-end wrench). Install the No. 00 black wire which leads from starter to the large terminal post (toward the rear) and secure with nut and lock washer (5/8-in. open-end wrench). Install No. 1 black wire and strap to battery box switch and secure with nut and lock washer (5/8-in. open-end wrench).

**(3) INSTALL SLIDING PANEL BETWEEN BATTERIES AND CONTROLS.**

**(4) INSTALL BATTERIES (fig. 197).**

WRENCH, open-end, 1/2-in.

WRENCH, open-end, 5/8-in.

**STARTER CIRCUIT AND STARTER MOTOR**

Lower batteries into battery box, with posts to receive wires at end of box toward propeller shaft. Place battery hold-down strap in position, install nuts, and tighten ( $\frac{5}{8}$ -in. open-end wrench). Coat battery posts and inside of connectors with PETROLATUM, to prevent corrosion, push connector over post, and tighten nuts securely ( $\frac{1}{2}$ -in. open-end wrench).

**102. MASTER BATTERY SWITCH.**

**a. Description.** The master battery switch (fig. 196), located on the left side of the battery box, is provided to cut off the battery power at the source.

**b. Operation.** To open switch, pull up on handle and turn to lock in position.

**c. Removal.**

SCREWDRIVER  
WRENCH, open-end,  $\frac{7}{16}$ -in. (2)  
WRENCH, open-end,  $\frac{1}{2}$ -in.  
WRENCH, open-end,  $\frac{5}{8}$ -in.  
WRENCH, socket,  $\frac{1}{2}$ -in.

**(1) DISCONNECT BATTERY WIRES.**

SCREWDRIVER  
WRENCH, open-end,  $\frac{1}{2}$ -in.

Loosen nuts holding wire connectors to battery posts ( $\frac{1}{2}$ -in. open-end wrench), and pry open connectors with screwdriver. Pull off wire connectors. CAUTION. Do not twist connectors to loosen. This may twist battery post loose from plates.

**(2) REMOVE WIRES FROM SWITCH (fig. 196).**

SCREWDRIVER  
WRENCH, open-end,  $\frac{5}{8}$ -in.

Lift out sliding panel which separates batteries from controls. Remove the screw (screwdriver) from center of switch handle and lift handle off. Remove the two nuts and remove wires and strap connections from switch terminals ( $\frac{5}{8}$ -in. open-end wrench).

**(3) REMOVE SWITCH FROM BATTERY BOX (fig. 196).**

WRENCH, open-end,  $\frac{7}{16}$ -in.  
WRENCH, socket,  $\frac{1}{2}$ -in.

(2)

Remove the two bolts and nuts which attach the switch mounting bracket to the side of battery box ( $\frac{1}{2}$ -in. socket wrench on inside of box,  $\frac{7}{16}$ -in. open-end wrench on outside of box). Remove the two bolts and nuts which secure switch to mounting bracket, and separate switch from bracket (two  $\frac{7}{16}$ -in. open-end wrenches).

**d. Installation.**

SCREWDRIVER  
WRENCH, open-end,  $\frac{5}{8}$ -in.  
WRENCH, open-end,  $\frac{1}{2}$ -in.  
WRENCH, socket,  $\frac{1}{2}$ -in.

(2)

**ORDNANCE MAINTENANCE—POWER UNIT ACCESSORIES  
FOR MEDIUM TANKS M3A4 AND M4A4****(1) INSTALL SWITCH IN BATTERY BOX (fig. 196).****SCREWDRIVER****WRENCH, socket, 1/2-in.****WRENCH, open-end, 7/16-in.****(2)**

Install switch in mounting bracket and secure with two bolts and nuts (two 7/16-in. open-end wrenches). Position switch in battery box and secure with two bolts and nuts (7/16-in. open-end wrench on outside and 1/2-in. socket wrench inside battery box). Install switch handle on shaft of switch and secure with screw (screwdriver).

**(2) CONNECT WIRES AND STRAP TO SWITCH.****WRENCH, open-end, 5/8-in.**

Connect No. 0 black wire from battery to one terminal and No. 1 black wire from shunt and strap from starter solenoid switch to other terminal (fig. 196) (5/8-in. open-end wrench).

**(3) CONNECT BATTERY WIRES.****WRENCH, open-end, 1/2-in.**

Install sliding panel between batteries and controls. Place battery wire connectors over battery posts, after covering with PETROLATUM, and tighten nuts with 1/2-inch open-end wrench.

**103. INSTRUMENT BOX STARTER (PUSH BUTTON) SWITCH.**

**a. Description.** A starter switch, of the push button type, is mounted on the instrument box cover, near the right end. It is operated without turning the ignition switch "ON."

**b. Operation.** When the push button is pushed "IN" the actuating circuit is closed, which, in turn, operates the solenoid switch. When pressure is released, a spring returns button to normal or "OFF" position.

**c. Removal (with Instrument Box Cover Removed from Box).****WRENCH, socket, 3/8-in.****WRENCH, socket, 3/4-in.****(1) DISCONNECT WIRES.****WRENCH, socket, 3/8-in.**

Hold wires with fingers (to prevent terminal posts from turning) and remove the two nuts and lock washers.

**(2) REMOVE SWITCH FROM INSTRUMENT BOX.****WRENCH, socket, 3/4-in.**

From front of cover, remove hexagonal nut and flat washer and withdraw switch from back of cover.

**d. Installation.****WRENCH, socket, 3/8-in.****WRENCH, socket, 3/4-in.****(1) INSTALL SWITCH IN INSTRUMENT BOX COVER.****WRENCH, socket, 3/4-in.**

**STARTER CIRCUIT AND STARTER MOTOR**

Install switch from back of cover and place flat washer and nut on front face of cover. Tighten nut while holding switch in position.

**(2) CONNECT WIRES.**

**WRENCH**, socket,  $\frac{3}{8}$ -in.

Install No. 16 yellow wire (labeled "C") on right terminal post, install lock washer and start nut with fingers, to hold wire in place. Place end of No. 16 brown wire (labeled "B") over left terminal post, install lock washer, and start nut with fingers. Hold wires with fingers, near terminal post, and tighten nuts securely.

**ORDNANCE MAINTENANCE—POWER UNIT ACCESSORIES  
FOR MEDIUM TANKS M3A4 AND M4A4**

**CHAPTER 7**

**ELECTRICAL SYSTEM (Cont'd)**

**Section IV**

**GENERATOR CIRCUIT AND GENERATOR**

	Paragraph
Generator circuit .....	104
Diagnosis and tests .....	105
Generator .....	106
Generator removal (multiple water pump type power unit) .....	107
Generator removal (single water pump type power unit) .....	108
Generator disassembly .....	109
Generator inspection and repair .....	110
Generator assembly .....	111
Generator final tests and adjustments .....	112
Generator installation (multiple water pump type power unit) .....	113
Generator installation (single water pump type power unit) .....	114
Polarize generator .....	115
Generator regulator .....	116
Voltmeter .....	117
Ammeter .....	118

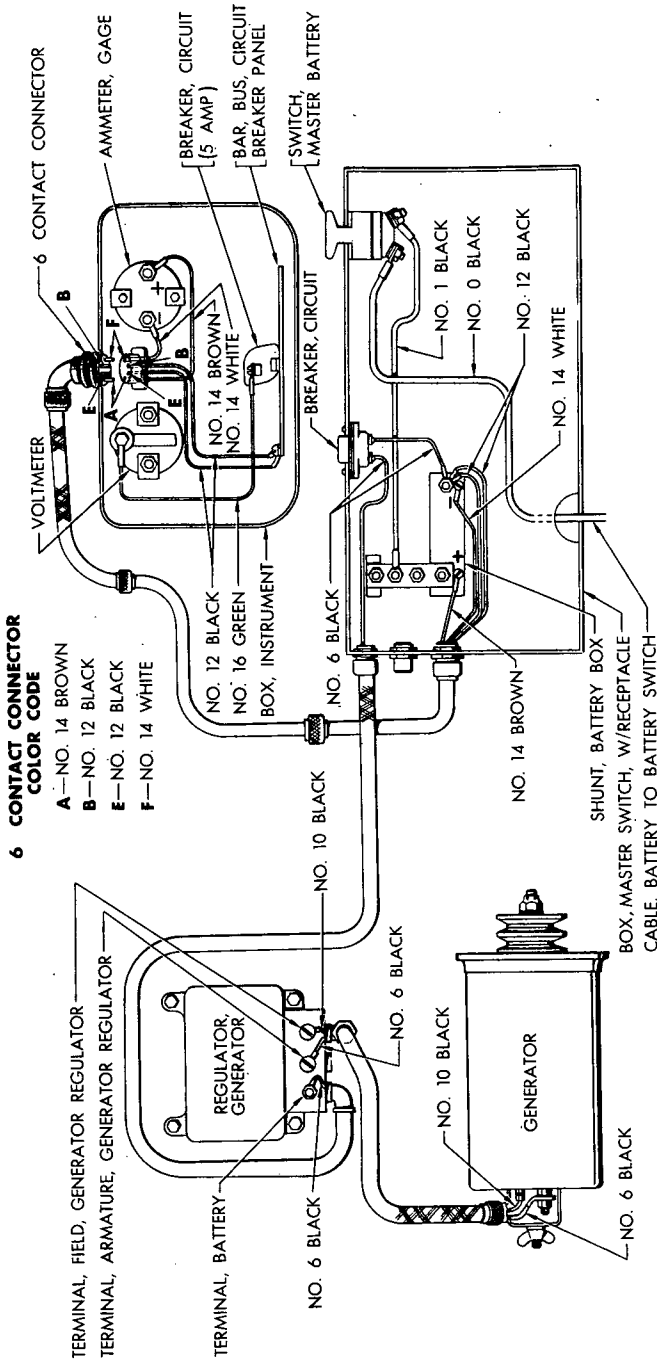
**104. GENERATOR CIRCUIT.**

a. **Description.** The generator circuit (fig. 213) consists of the generator, generator regulator, battery box circuit breaker, battery box shunt, 6-contact connector, and ammeter. A separate parallel circuit includes the voltmeter, protected by its own circuit breaker.

b. **Operation.** The generator supplies the charging current to the generator regulator which controls the amount of current going to the battery or accessory load. The ammeter and voltmeter convey to the operator the output of the generator; a circuit breaker or reverse current relay in the generator regulator prevents a discharge of current in the opposite direction when the generator is not operating or operating at very low speeds. A circuit breaker in the battery box protects the generator regulator if the contacts in the generator regulator reverse current relay are accidentally jarred closed by a severe shock, while the generator is not charging. By noting the ammeter and voltmeter readings, the operator can check for normal and abnormal indications as listed below:

(1) NORMAL INDICATIONS.

GENERATOR CIRCUIT AND GENERATOR



RA PD 25266

Figure 213—Generator Circuit

**ORDNANCE MAINTENANCE—POWER UNIT ACCESSORIES  
FOR MEDIUM TANKS M3A4 AND M4A4**

(a) Voltmeter reading of 24 when power unit is not operating, if battery is in good condition and no heavy load circuit in use.

(b) Voltmeter reading of 27 to 30 and ammeter reading of 10 to 15 with power unit operating, if battery is in good condition and no heavy load circuits in use. NOTE: Ammeter reading may be as high as 50 if battery is only partially charged.

(2) **ABNORMAL INDICATIONS (WITH POWER UNIT OPERATING AT FAST IDLE).**

(a) Voltmeter reading of 24, ammeter reading of zero (generator not charging).

(b) Voltmeter reading below 27 while charging (with no heavy load circuit in use) plus battery becoming discharged frequently (generator charging rate too low).

(c) Voltmeter reading above 30 and ammeter reading above 30 plus the necessity of frequently adding water to battery (generator charging rate too high).

**105. DIAGNOSIS AND TESTS.**

LAMP, test

PLIERS, side cutting

SCREWDRIVER

WIRE, jumper

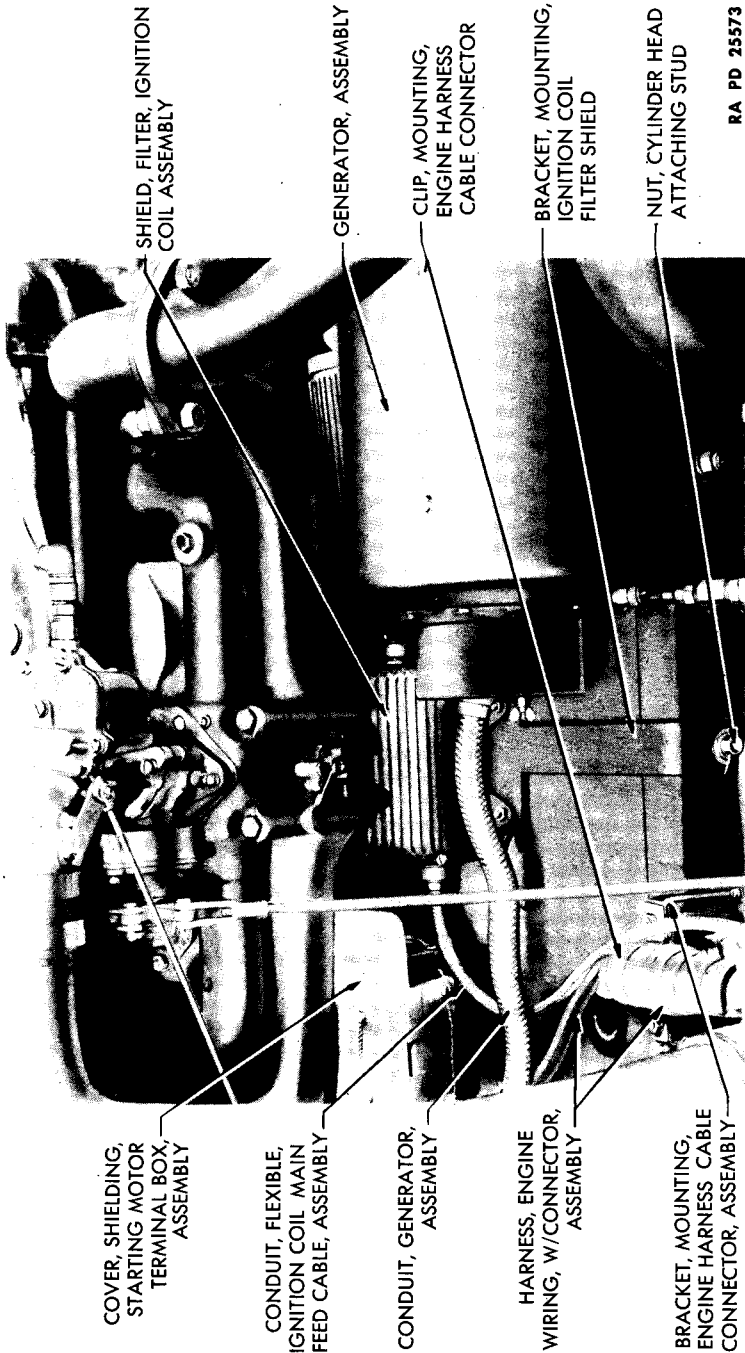
WRENCH, open-end, 3/8-in.

**a. General.** Before starting the procedure as outlined below, the generator circuit diagram (fig. 213) should be thoroughly studied to assist in understanding the circuits and why each step is taken. In the following discussion, the generator armature terminal (large terminal, fig. 224) will be referred to as "A;" the generator field terminal (small terminal, fig. 224) as "F;" the generator regulator armature terminal as "A" (this terminal may be marked "A" or "ARM.," fig. 226); the generator regulator field terminal as "F" (this terminal may be marked "F" or "FIELD," fig. 226); and the generator regulator battery terminal as "B" (this may be marked "B" or "BAT," fig. 226). CAUTION: Before changing or removing any leads, the power unit must be stopped and the master switch opened. When new connections have been made or loose leads taped to prevent grounding, the master switch can be turned on again. Further, the power unit speed should not be increased beyond 750 revolutions per minute when test lamp is connected, to protect the test lamp.

**b. Check Connections from Battery to Battery Box Shunt.** Check all connections for tightness or corrosion before starting to check generator circuit.

**c. Check Ammeter (fig. 213).** With power unit stopped and all

**GENERATOR CIRCUIT AND GENERATOR**



RA PD 25573

**Figure 214—Generator and Ignition Filter Conduits (Multiple Water Pump Type)**



**ORDNANCE MAINTENANCE—POWER UNIT ACCESSORIES  
FOR MEDIUM TANKS M3A4 AND M4A4**

other loads turned off, operate lights and siren. With these operating properly, the ammeter should show a 10- to 15-ampere discharge. If the ammeter does not show this discharge, the ammeter or wiring from ammeter to battery box shunt is defective. Tighten all connections and, if necessary, replace defective parts.

**d. Check Voltmeter (fig. 213).** The voltmeter should indicate 24 volts after cranking the power unit for 10 seconds with the ignition switch off, and no other loads turned on. Allow about one minute for the voltmeter reading to become stabilized. If the voltmeter shows no reading or one very different from 24 volts, the fault is in loose connections or an open circuit. Tighten all connections and replace defective wiring or voltmeter if necessary.

**e. Check Generator Drive Belt.** Check to make certain the generator drive belt is in good condition and tightly adjusted so that it does not slip in generator pulley. On the multiple water pump type power units the generator is mounted on the No. 2 engine (fig. 214) and belt driven by the No. 2 water pump. On the single water pump type power units the generator is mounted in the fighting compartment (fig. 215) and belt driven by the propeller shaft. If the belt is tight and still slips, the armature is tied up in the generator and generator must be removed and reworked (pars. 107 to 115).

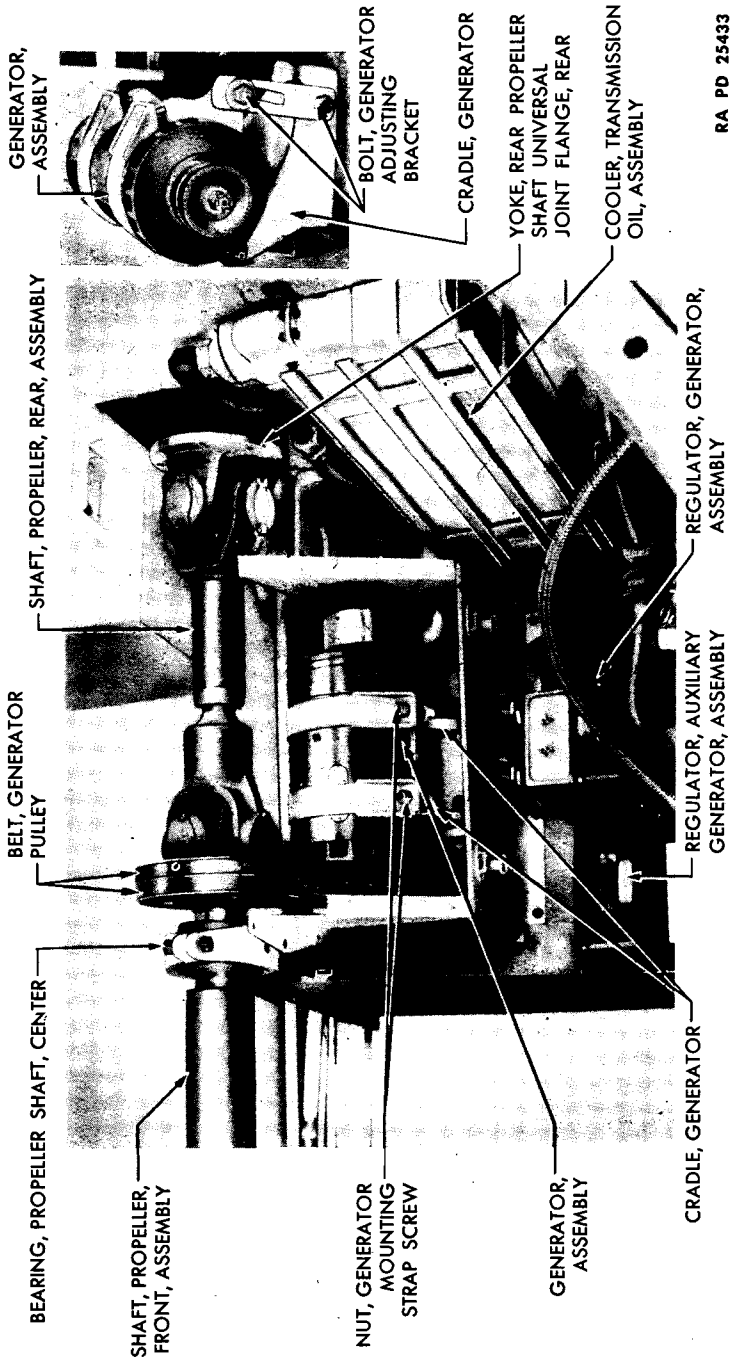
**f. Generator Does Not Charge but Battery Box Circuit Breaker Remains Closed.**

(1) **GENERATOR REGULATOR CIRCUIT BREAKER OR CURRENT REGULATOR FAILURE.** Operate power unit at idle (750 rpm on tachometer). Remove generator regulator terminal box cover by removing locking wire (side cutting pliers) and unscrewing both wing nuts at the same time with fingers. Remove cover. Touch one test lamp lead to ground and touch other test lamp lead to the regulator "A" terminal. If lamp burns bright, then touch the "B" terminal. If the lamp burns brighter on the "A" terminal than on the "B" terminal, the regulator is defective (par. 116).

(2) **OPEN CIRCUIT BETWEEN "B" TERMINAL OF REGULATOR AND BATTERY BOX SHUNT.** If lamp burns bright and with the same intensity on "A" and "B" terminals of the regulator in test described in step (1) above, stop power unit and again touch test lamp to the "B" terminal. If lamp does not burn, the open circuit is between the regulator and battery box shunt. Touch one lead of test lamp to ground and touch the other test lamp lead to the following terminals in order listed.

(a) Terminal on circuit breaker (fig. 213) in battery box which con-

GENERATOR CIRCUIT AND GENERATOR



RA PD 25433

Figure 215—Position of Generator Inside Fighting Compartment

**ORDNANCE MAINTENANCE—POWER UNIT ACCESSORIES  
FOR MEDIUM TANKS M3A4 AND M4A4**

nects to regulator. If lamp burns, open circuit is between circuit breaker and regulator in the No. 6 black wire. If lamp does not burn, proceed to substep (b).

(b) Terminal on circuit breaker (fig. 213) in battery box which connects to battery box shunt. If lamp burns, open circuit is in circuit breaker. If lamp does not burn, open circuit is between circuit breaker and battery box shunt.

(3) OPEN CIRCUIT OR GROUND BETWEEN "A" TERMINAL OF REGULATOR AND "A" TERMINAL OF GENERATOR. If lamp failed to burn when one lead was grounded and other lamp lead touched to the "A" terminal of regulator in test described in step (1) above, then remove generator commutator end head terminal cover by unscrewing wing nut (side cutting pliers) and with one lead of test lamp grounded, touch other test lamp lead to the "A" terminal on the generator (large terminal, fig. 224). Operate power unit at idle (750 rpm on tachometer). If lamp burns, the trouble is in the No. 6 black wire from the generator "A" terminal to the regular "A" terminal. If lamp does not burn, proceed to test described in step (4) below.

(4) DEFECTIVE GENERATOR. Remove the No. 10 black wire from the small, "F" terminal on the generator ( $\frac{3}{8}$ -in. open-end wrench) (fig. 214). Connect a jumper wire between "A" and "F" generator terminals. Operate power unit at idle (750 rpm on tachometer). Ground one of test lamp leads and touch other lamp lead to the "A" generator terminal. If lamp does not burn, the generator is defective. Inspect generator brushes (par. 110 c (1)) and if the brushes are correct, then remove and repair generator (pars. 107 to 115). If lamp burns, proceed to test described in step (5) below.

(5) OPEN CIRCUIT OR GROUND BETWEEN GENERATOR AND REGULATOR "F" TERMINALS (fig. 213). Remove jumper wire from generator terminals and connect it between the "A" and "F" regulator terminals after installing the No. 10 black wire on the "F" generator terminal. Operate power unit at idle (750 rpm on tachometer). Ground one lead of test lamp and touch other lead of lamp to "A" terminal on generator. If lamp does not burn, trouble is in the No. 10 black wire from generator to regulator "F" terminals. If lamp burns, the regulator is defective or wires are not properly connected to terminals. If wires are found connected to the wrong terminals on the regulator and after connecting to the proper terminals, the generator does not charge, the regulator has been damaged due to the improper connections and must be replaced. If, after the new regulator is installed, an early similar trouble develops, it may be due to a partially grounded field. Generator should be removed and checked (pars. 107 to 115) before a second regulator is installed.

**GENERATOR CIRCUIT AND GENERATOR****g. Generator Does Not Charge and Battery Box Circuit Breaker Opens.**

(1) **GROUND IN CIRCUIT BREAKER** (fig. 213). Stop power unit and open master battery switch. Remove No. 6 black wire from battery box circuit breaker terminal, which leads to regulator (screwdriver). Close battery box circuit breaker by depressing push button. Close master battery switch. If battery box circuit breaker clicks open, the ground is in this unit. If battery box circuit breaker does not click open, proceed to test described in step (2) below.

(2) **GROUND IN NO. 6 BLACK WIRE FROM BATTERY BOX CIRCUIT BREAKER TO REGULATOR** (fig. 213). Open master battery switch. Install No. 6 black wire (which was removed in previous test) on terminal at battery box circuit breaker. Remove regulator terminal cover by unscrewing wing nuts after removing lock wires (side cutting pliers) and after making sure that No. 6 black wire is not loose on "B" terminal, remove wire from this terminal and tape to prevent grounding. Close master battery switch and, if battery box circuit breaker clicks open, ground is in the No. 6 black wire from battery box circuit breaker to regulator. If battery box circuit breaker does not open, ground is in the regulator and this unit must be removed and reworked (par. 116).

**h. Generator Charge Rate too Low.**

(1) **CHECK ALL CONNECTIONS.** Check connections from generator to battery for loose or corroded condition and correct where necessary.

(2) **CHECK GENERATOR OPERATION.** Stop power unit and open master battery switch. Connect jumper wire between "A" and "F" regulator terminals, making sure that jumper does not ground either terminal. Start power unit and idle. **CAUTION:** Do not bring engine speed up too fast or exceed 1,000 revolutions per minute on tachometer while jumper wire is in place. Bring engine speed up to 900 revolutions per minute on tachometer. If ammeter does not show 50 amperes charge, the generator is defective and must be removed and reworked (pars. 107 to 115). Remove jumper wire from regulator.

(3) **CHECK GENERATOR REGULATOR OPERATION.** With ignition turned off, crank the power unit for 5 or 10 seconds; then turn on ignition and start power unit. If ammeter fails to register 50 amperes at 1,000 revolutions per minute on tachometer immediately after power unit is started the current regulator is set too low. If 50 amperes charge is indicated on both tests described in steps (2) and (3) above, and the voltmeter still reads below 27 volts when the generator is charging steadily, the voltage regulator is set too low. Refer to paragraph 116 for generator regulator adjustments.

**ORDNANCE MAINTENANCE—POWER UNIT ACCESSORIES  
FOR MEDIUM TANKS M3A4 AND M4A4**

**i. Generator Charge Rate too High.**

(1) **CHECK GENERATOR OPERATION.** Disconnect No. 10 black wire from "F" terminal (fig. 224) ( $\frac{3}{8}$ -in. open-end wrench) on generator, and operate power unit at 1,000 revolutions per minute on tachometer. If charging rate does not fall to zero, there is a short circuit between armature and field inside generator. Remove and repair generator (pars. 107 to 115). If charge falls to zero proceed to test, described in step (2) below.

(2) **CHECK FOR SHORTS BETWEEN GENERATOR AND REGULATOR.** Replace No. 10 black wire on "F" terminal of generator and remove No. 10 black wire from "F" terminal on regulator. Operate power unit at 1,000 revolutions per minute on tachometer. If charge rate does not show zero, there is a short in the No. 6 black wire or No. 10 black wire from generator to regulator (fig. 213). If charge rate falls to zero, proceed to test, described in step (3) below.

(3) **CHECK VOLTAGE REGULATOR.** If removal of wire from "F" terminal of regulator and "F" terminal of generator reduces the charge to zero, the fault is in the setting of the voltage regulator (par. 116).

(4) **CHECK CURRENT REGULATOR.** If the current regulator is set too high, it will not register on the ammeter while the tank is in operation. It is, therefore, possible to burn out the generator before any trouble will be noted. Should the generator give off a pungent odor or seem to run too hot, the current regulator should be checked as follows: With the ignition turned off, crank power unit over for approximately 15 seconds; then turn on ignition and note ammeter reading as the engine speed is brought up to 1,200 revolutions per minute on tachometer. If the ammeter reads in excess of 52 amperes, the charge rate is too high. Refer to paragraph 116. **CAUTION:** If generator has already burned out, be sure to check current regulator when new generator is installed.

**106. GENERATOR.**

**a. Description.** The generator is a shunt type unit. On power units with multiple type water pumps, the generator is mounted on the No. 2 engine (fig. 214) and belt driven from the No. 2 water pump pulley. On power units with the single water pump, the generator is mounted in the fighting compartment (fig. 215) and belt driven from the propeller shaft. When properly controlled by the generator regulator, it will generate up to 50 amperes at all speeds from 900 to 2,900 revolutions per minute on the tachometer. It begins to charge at 675 revolutions per minute on the tachometer.

**GENERATOR CIRCUIT AND GENERATOR**

**107. GENERATOR REMOVAL (MULTIPLE WATER PUMP TYPE POWER UNIT).**

**PLIERS**, side cutting  
**SCREWDRIVER**

**WRENCH**, socket,  $\frac{3}{8}$ -in., with  
3-in. extension

**WRENCH**, open-end,  $\frac{3}{8}$ -in.

**WRENCH**, socket,  $\frac{1}{2}$ -in., with  
3-in. extension

**WRENCH**, open-end,  $\frac{1}{2}$ -in.

**WRENCH**, open-end,  $\frac{9}{16}$ -in.

**WRENCH**, spanner, closed,  
MTM A4-7

**WRENCH**, open-end,  $\frac{5}{8}$ -in.

**a. Disconnect Generator Wires.**

**PLIERS**, side cutting

**WRENCH**, socket,  $\frac{1}{2}$ -in., with  
3-in. extension

**WRENCH**, socket,  $\frac{3}{8}$ -in., with  
3-in. extension

Remove lock wires (side cutting pliers) from wing nuts on generator terminal cover and unscrew wing nuts to remove cover. Remove nuts which secure wires to terminals and disconnect wires ( $\frac{3}{8}$ -in. and  $\frac{1}{2}$ -in. socket wrenches, with 3-in. extension). Unscrew knurled nut which secures conduit to terminal shield and withdraw wires from shield.

**b. Remove Drive Belt.**

**SCREWDRIVER**

**WRENCH**, spanner, closed,  
MTM A4-7

**WRENCH**, open-end,  $\frac{1}{2}$ -in.

Loosen lock nut ( $\frac{1}{2}$ -in. open-end wrench) on set screw holding pulley flange and loosen set screw (screwdriver) sufficiently to permit turning of flange. Unscrew adjusting flange from pulley hub by turning clockwise with a closed spanner wrench (MTM A4-7) and remove drive belt.

**c. Remove No. 2 Ignition Coil.**

**PLIERS**, side cutting

**WRENCH**, open-end,  $\frac{9}{16}$ -in.

**WRENCH**, open-end,  $\frac{3}{8}$ -in.

Unscrew knurled nut in center of ignition coil and separate high-tension wire from coil. Remove nuts and lock washers ( $\frac{3}{8}$ -in. open-end wrench) and remove wires from coil resistor and coil low tension terminal which connects to distributor. **NOTE:** Do not disconnect wire which is soldered to coil terminal. Remove locking wire (side cutting pliers) and remove the two nuts and washers from coil to bracket studs and lift coil off bracket ( $\frac{9}{16}$ -in. open-end wrench).

**d. Remove Generator and Bracket from Power Unit.**

**PLIERS**, side cutting

**WRENCH**, open-end,  $\frac{5}{8}$ -in.

**SCREWDRIVER**

Remove locking wire (side cutting pliers) and remove screw (screwdriver) which secures water pump relief tube to top of generator. Remove two pal nuts and two generator mounting nuts ( $\frac{5}{8}$ -in. open-end wrench) from studs. Remove the locking wire (side cutting pliers) and



GENERATOR CIRCUIT AND GENERATOR

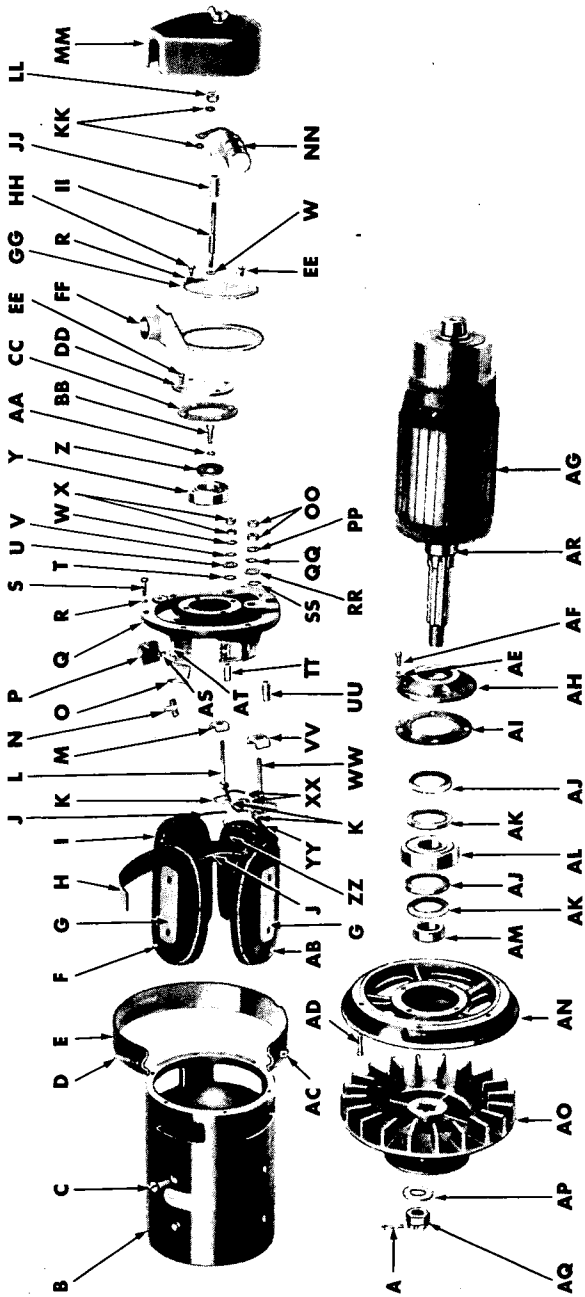
- A—NUT, CONDENSER MOUNTING STUD  
 B—CASE, TERMINAL GENERATOR COMMUTATOR END HEAD, ASSEMBLY  
 C—SCREW, RETAINER, GENERATOR COMMUTATOR END HEAD BEARING  
 D—PLATE, LOCK, GENERATOR COMMUTATOR END HEAD BEARING, RETAINER  
 E—BEARING, BALL, GENERATOR COMMUTATOR END HEAD  
 F—WASHER, FELT, GENERATOR COMMUTATOR END HEAD  
 G—RETAINER, FELT WASHER, GENERATOR COMMUTATOR END HEAD  
 H—WASHER, SPRING, GENERATOR COMMUTATOR END HEAD  
 I—OILER, GENERATOR COMMUTATOR END HEAD  
 J—GASKET, GENERATOR COMMUTATOR END HEAD  
 K—HEAD, COMMUTATOR END, GENERATOR, ASSEMBLY  
 L—SCREW, ATTACHING, COMMUTATOR END HEAD  
 M—SPACER, SHAFT, GENERATOR ARMATURE  
 N—ARMATURE, GENERATOR, ASSEMBLY  
 O—SPACER, SHAFT, GENERATOR ARMATURE  
 P—KEY, SHAFT, GENERATOR ARMATURE  
 Q—COIL, FIELD, GENERATOR, ASSEMBLY  
 R—BAND, HEAD, GENERATOR  
 S—SCREW, ATTACHING, HEAT SHIELD  
 T—SHIELD, HEAT, GENERATOR FRAME AND FIELD  
 U—NUT, LOCK, CYLINDER HEAD STUD NUT  
 V—BRACKET, MOUNTING, GENERATOR FRAME AND FIELD  
 W—SCREW, ATTACHING, MOUNTING BRACKET  
 X—NUT, CYLINDER HEAD STUD  
 Y—SCREW, ATTACHING GENERATOR BEARING RETAINER  
 Z—OILER, GENERATOR DRIVE END HEAD  
 AA—BEARING, BALL, GENERATOR DRIVE END HEAD  
 BB—PULLEY, DRIVE, GENERATOR ARMATURE  
 CC—WASHER, ARMATURE SHAFT, DRIVE END  
 DD—NUT, ARMATURE SHAFT, DRIVE END  
 EE—PLATE, LOCK, ARMATURE SHAFT, DRIVE END  
 FF—SCREW, ATTACHING, DRIVE END HEAD  
 GG—RETAINER, FELT WASHER, GENERATOR DRIVE END HEAD  
 HH—HEAD, DRIVE END, GENERATOR, ASSEMBLY  
 II—GASKET, GENERATOR DRIVE END HEAD  
 JJ—RETAINER, BEARING, GENERATOR DRIVE END, ASSEMBLY  
 KK—SCREW, ATTACHING, MOUNTING BRACKET  
 LL—BOLT, MOUNTING, GENERATOR BRACKET  
 MM—SPACER, GENERATOR BRACKET MOUNTING BOLT  
 NN—WASHER, LOCK, GENERATOR BRACKET MOUNTING BOLT  
 OO—POST, TERMINAL GENERATOR FIELD COIL  
 PP—BUSHING, GENERATOR FIELD COIL TERMINAL POST  
 QQ—WASHER, LOCK, GENERATOR FIELD COIL TERMINAL POST  
 RR—WASHER, INSULATING, GENERATOR FIELD COIL TERMINAL POST  
 SS—WASHER, GENERATOR FIELD COIL TERMINAL POST  
 TT—WASHER, INSULATING, GENERATOR FIELD COIL TERMINAL POST  
 UU—WASHER, FIELD COIL TERMINAL POST, OUTER  
 VV—WASHER, LOCK, FIELD COIL TERMINAL POST  
 WW—NUT, FIELD COIL TERMINAL POST  
 XX—BRUSH, GENERATOR  
 YY—ARM, GENERATOR BRUSH  
 ZZ—SCREW, BRUSH LEAD  
 AB—SPRING, BRUSH, GENERATOR  
 AC—POST, TERMINAL, GENERATOR ARMATURE  
 AD—WASHER, LOCK, ARMATURE TERMINAL POST, INNER  
 AE—WASHER, INSULATING, ARMATURE TERMINAL POST, INNER  
 AF—BUSHING, INSULATING, ARMATURE TERMINAL POST, OUTER (THIN)  
 AG—WASHER, INSULATING, ARMATURE TERMINAL POST, OUTER (THICK)  
 AH—WASHER, INSULATING, ARMATURE TERMINAL POST, OUTER (THICK)  
 AI—WASHER, PLAIN, ARMATURE TERMINAL POST, OUTER  
 AJ—WASHER, LOCK, ARMATURE TERMINAL POST, OUTER  
 AK—NUT, ARMATURE TERMINAL POST  
 AL—RETAINER, FELT WASHER, GENERATOR COMMUTATOR END HEAD  
 AM—SCREW, ATTACHING, GENERATOR TERMINAL CASE  
 AN—COVER, CASE, GENERATOR TERMINAL, ASSEMBLY

RA PD 25342B

Legend for Figure 216—Parts of Generator (Power Unit Mounted Type)



ORDNANCE MAINTENANCE—POWER UNIT ACCESSORIES  
FOR MEDIUM TANKS M3A4 AND M4A4



RA PD 24563

Figure 217—Parts of Generator (Fighting Compartment Mounted Type)

**GENERATOR CIRCUIT AND GENERATOR**

- A—PIN, COTTER, GENERATOR ARMATURE NUT  
 B—FRAME, GENERATOR  
 C—SCREW, GENERATOR POLE PIECE  
 D—SCREW, GENERATOR HEAD BAND  
 E—BAND, HEAD, GENERATOR  
 F—COIL, FIELD, LOWER, RIGHT  
 G—POLE PIECE, GENERATOR  
 H—INSULATION, FIELD CONNECTION  
 I—COIL, FIELD, LOWER, LEFT  
 J—TUBE, INSULATION, FIELD CONNECTION  
 K—TERMINAL, FIELD, GENERATOR  
 L—POST, TERMINAL, GENERATOR FIELD  
 M—INSULATION, TERMINAL, GENERATOR FIELD  
 N—SPRING, BRUSH, GENERATOR COMMUTATOR END HEAD  
 O—ARM, BRUSH, GENERATOR COMMUTATOR END HEAD  
 P—BRUSH, GENERATOR COMMUTATOR END HEAD  
 Q—HEAD, GENERATOR COMMUTATOR END  
 R—WASHER, LOCK, GENERATOR COMMUTATOR END HEAD SCREW  
 S—SCREW, GENERATOR COMMUTATOR END HEAD  
 T—WASHER, INSULATING, GENERATOR COMMUTATOR END HEAD  
 U—WASHER, INSULATING, GENERATOR COMMUTATOR END HEAD  
 V—WASHER, PLAIN, FIELD TERMINAL  
 W—WASHER, LOCK, GENERATOR COMMUTATOR END HEAD COVER STUD  
 X—NUT, FIELD TERMINAL  
 Y—BEARING, BALL, GENERATOR COMMUTATOR END HEAD  
 Z—PLATE, LOCK, GENERATOR COMMUTATOR END HEAD BEARING RETAINER  
 AA—WASHER, LOCK, GENERATOR COMMUTATOR END HEAD BEARING, RETAINER SCREW  
 BB—SCREW, RETAINER, GENERATOR COMMUTATOR END HEAD BEARING  
 CC—GASKET, GENERATOR COMMUTATOR END HEAD  
 DD—CAP, COVER, GENERATOR COMMUTATOR END HEAD  
 EE—SCREW, COVER, GENERATOR COMMUTATOR END HEAD  
 FF—SHIELD, TERMINAL, W/COUPLING  
 GG—BRACKET, SHIELD, GENERATOR COMMUTATOR END HEAD TERMINAL, INNER  
 HH—SCREW, BRACKET, TERMINAL SHIELD  
 II—STUD, COVER, GENERATOR COMMUTATOR END HEAD  
 JJ—BUSHING, INSULATING, GENERATOR COMMUTATOR END HEAD COVER STUD  
 KK—WASHER, PLAIN, GENERATOR CONDENSER ATTACHING NUT  
 LL—NUT, ATTACHING, GENERATOR CONDENSER  
 MM—COVER, TERMINAL, GENERATOR COMMUTATOR END HEAD, ASSEMBLY  
 NN—CONDENSER, GENERATOR COMMUTATOR END HEAD, ASSEMBLY  
 OO—NUT, GENERATOR FIELD TERMINAL  
 PP—WASHER, LOCK, GENERATOR FIELD TERMINAL  
 QQ—WASHER, PLAIN, GENERATOR ARMATURE TERMINAL  
 RR—WASHER, INSULATING, GENERATOR ARMATURE TERMINAL  
 SS—WASHER, INSULATING, GENERATOR ARMATURE TERMINAL  
 TT—BUSHING, INSULATING, GENERATOR COMMUTATOR END HEAD  
 UU—BUSHING, INSULATING, GENERATOR ARMATURE TERMINAL  
 VV—INSULATION, TERMINAL, GENERATOR ARMATURE, INNER  
 WW—POST, TERMINAL, GENERATOR ARMATURE  
 XX—LEAD, GENERATOR, ASSEMBLY  
 YY—TUBE, INSULATING  
 ZZ—COIL, FIELD, GENERATOR, UPPER, LEFT  
 AA—COIL, FIELD, GENERATOR, UPPER, RIGHT  
 AC—NUT, GENERATOR HEAD BAND SCREW  
 AD—SCREW, HEAD, GENERATOR DRIVE END  
 AE—WASHER, LOCK, GENERATOR DRIVE END BEARING RETAINER SCREW  
 AF—SCREW, RETAINER, GENERATOR DRIVE END BEARING  
 AG—ARMATURE, GENERATOR, ASSEMBLY  
 AH—RETAINER, BEARING, GENERATOR DRIVE END  
 AI—GASKET, RETAINER, GENERATOR DRIVE END BEARING  
 AJ—WASHER, FELT, GENERATOR DRIVE END BEARING  
 AK—RETAINER, GENERATOR DRIVE END BEARING, FELT WASHER  
 AL—BEARING, BALL, GENERATOR DRIVE END  
 AM—SPACER, SHAFT, GENERATOR ARMATURE, OUTER  
 AN—HEAD, GENERATOR DRIVE END, ASSEMBLY  
 AO—PULLEY, DRIVE, GENERATOR  
 AP—WASHER, PLAIN, GENERATOR DRIVE PULLEY NUT  
 AQ—NUT, GENERATOR DRIVE PULLEY  
 AR—SPACER, SHAFT, GENERATOR ARMATURE, INNER  
 AS—SCREW, BRUSH, GENERATOR COMMUTATOR END HEAD  
 AT—WASHER, LOCK, GENERATOR COMMUTATOR END HEAD BRUSH SCREW

RA PD 245638

**Legend for Figure 217—Parts of Generator (Fighting Compartment Mounted Type)**

**ORDNANCE MAINTENANCE—POWER UNIT ACCESSORIES  
FOR MEDIUM TANKS M3A4 AND M4A4**

remove the two cap screws securing lower end of bracket ( $\frac{5}{8}$ -in. open-end wrench). Lift generator off power unit.

**108. GENERATOR REMOVAL (SINGLE WATER PUMP TYPE POWER UNIT).**

WRENCH, open-end,  $\frac{7}{16}$ -in.      WRENCH, open-end,  $1\frac{1}{8}$ -in.  
WRENCH, open-end,  $\frac{7}{8}$ -in.

**a. Remove Generator Cover.**

WRENCH, open-end,  $\frac{7}{16}$ -in.

Rotate turret until opening in turret floor is directly over generator (fig. 215). Remove bolt at top of generator cover ( $\frac{7}{16}$ -in. open-end wrench). Unsnap the catches at the bottom and remove cover.

**b. Disconnect Generator Wires.** Disconnect ground wire from stud on back of generator (par. 107 a).

**c. Remove Generator From Cradle (fig. 215).**

WRENCH, open-end,  $\frac{7}{8}$ -in.      WRENCH, open-end,  $1\frac{1}{8}$ -in.

Remove the two mounting nuts ( $\frac{7}{8}$ -in. open-end wrench), loosen adjusting bolt ( $1\frac{1}{8}$ -in. open-end wrench), lift up on cradle, to disconnect belts, and lift generator from cradle.

**109. GENERATOR DISASSEMBLY.**

BAR, brass	WRENCH, open-end, $\frac{7}{16}$ -in.
HAMMER	WRENCH, open-end, $\frac{1}{2}$ -in.
PLIERS, side cutting	WRENCH, open-end, $\frac{9}{16}$ -in.
PRESS, bench	WRENCH, open-end, $1\frac{5}{16}$ -in.
PULLER, generator pulley	WRENCH, socket, $\frac{3}{8}$ -in.
SCREWDRIVER	

**a. Remove Heat Shield and Mounting Bracket (This Applies Only to Generators Which Are Mounted on the Power Unit (fig. 216)).**

PLIERS, side cutting      WRENCH, open-end,  $\frac{9}{16}$ -in.  
SCREWDRIVER

Remove locking wires (side cutting pliers) and remove the six screws (screwdriver) securing heat shield to generator and remove heat shield. Remove locking wires (side cutting pliers) and remove the four cap screws ( $\frac{9}{16}$ -in. open-end wrench) securing mounting bracket to generator. Early models used screws in place of cap screws and a screwdriver will be required.

**b. Remove Pulley from Generator.**

PLIERS, side cutting      WRENCH, open-end,  $1\frac{5}{16}$ -in.  
PULLER, generator pulley

Remove cotter pin (side cutting pliers) and remove nut ( $1\frac{5}{16}$ -in.

**GENERATOR CIRCUIT AND GENERATOR**

open-end wrench) (Lock plate may be used in place of cotter pin in some units.) from drive end of armature shaft. Remove the pulley with a suitable puller (fig. 217). **CAUTION:** Generators mounted on the power unit have a Woodruff key in the drive end of the armature shaft which must be removed.

**c. Remove Head Band and Brushes.**

**PLIERS**, side cutting                      **SCREWDRIVER**

Remove locking wire (side cutting pliers) and remove screw (screwdriver) securing generator head band. Remove head band. Lift brushes out of brush holders.

**d. Remove Terminal Shield and Terminal Shield Bracket (fig. 224).**

**PLIERS**, side cutting                      **WRENCH**, open-end, 1/2-in.  
**SCREWDRIVER**

Remove the nut from the commutator end head stud (1/2-in. open-end wrench) and remove the washers, condenser, and insulating bushing. Unscrew the stud and remove. Remove the lock wire (side cutting pliers) and the three screws (screwdriver) which secure the terminal shield bracket to commutator end head. Remove the terminal shield and bracket from the generator. **NOTE:** Generators which mount on the power unit have a terminal cover in place of the shield and bracket. Remove the four screws securing terminal cover (side cutting pliers and screwdriver) and remove cover. The stud is soldered to the cover and cannot be removed.

**e. Disconnect Field Coil Leads and Field Terminal Post (fig. 224).**

**SCREWDRIVER**                                      **WRENCH**, socket, 3/8-in.

Remove screws (screwdriver) securing field coil leads to brush holders and remove nuts and washers (3/8-in. socket wrench) from generator field terminal post so that it will slide out of commutator end head.

**f. Remove the Generator Commutator End Head Cover Cap (Single Water Pump Power Units Only).**

**SCREWDRIVER**

Remove the screws securing the commutator end head cover cap and remove cap from head. Remove gasket (fig. 224).

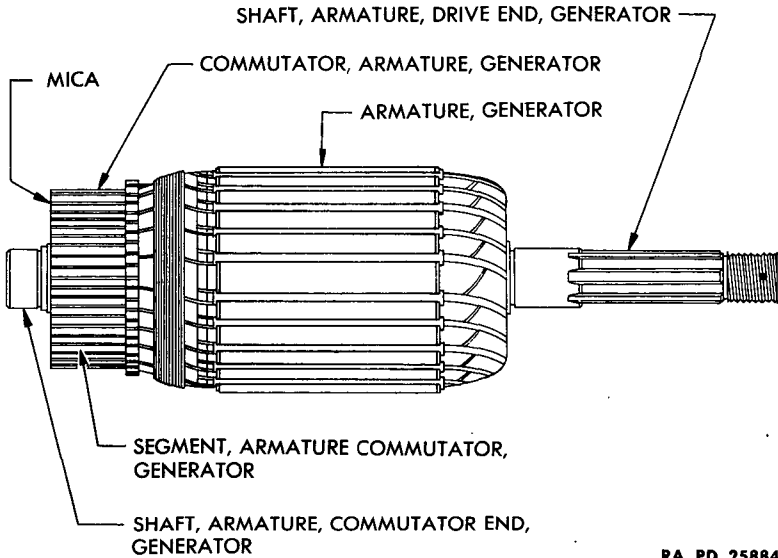
**g. Remove Generator Drive End Head and Generator Armature.**

**BAR**, brass                                      **SCREWDRIVER**  
**HAMMER**                                      **WRENCH**, open-end, 7/16-in.

**PLIERS**, side cutting

Remove lock wire (side cutting pliers) and remove commutator end head bearing retainer screw (7/16-in. open-end wrench). Remove lock

**ORDNANCE MAINTENANCE—POWER UNIT ACCESSORIES  
FOR MEDIUM TANKS M3A4 AND M4A4**



RA PD 25884

**Figure 218—Generator Armature—Side View**

washer and lock plate. Remove the screws (screwdriver) securing the drive end head to frame (fig. 223). Using a brass bar and hammer, drive against commutator end of armature shaft to remove armature and drive end head from frame. This operation will be made easier if a large screwdriver is used as a pry between drive end head and frame at the same time that armature is being driven out from commutator end. **CAUTION:** Do not break drive end head by prying with too much force.

**h. Remove Armature from Drive End Head.**

**PRESS**, bench

Place generator drive end head on press and, with suitable arbor, press armature out of head.

**i. Remove Generator Commutator End Head.**

**PLIERS**, side cutting

**SCREWDRIVER**

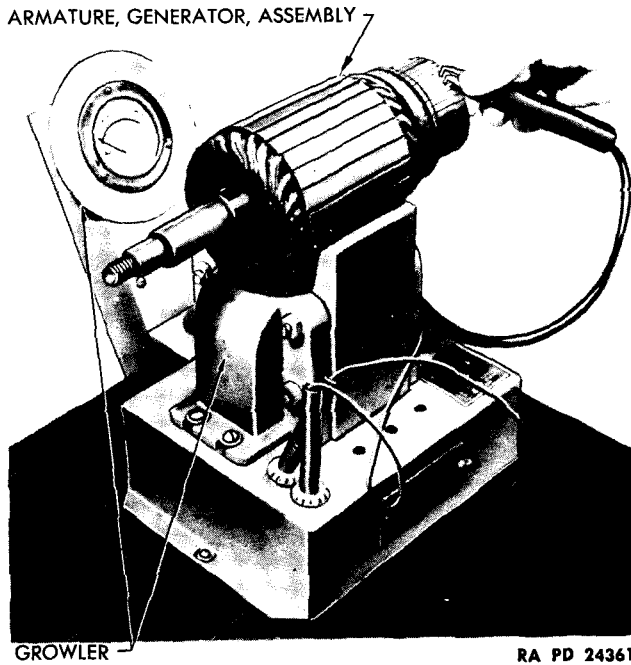
Remove locking wires (side cutting pliers) and remove screws and lock washers (screwdriver) securing commutator end head to generator frame. Punch mark head and frame to assist in proper assembly, before removing head.

**110. GENERATOR INSPECTION AND REPAIR.**

**GROWLER**, Federal Stock No.  
17-G-5940

**LAMP**, test  
**LATHE**

**GENERATOR CIRCUIT AND GENERATOR**



**Figure 219—Testing Generator Armature on Growler**

SCALE, spring

TESTER, condenser, Federal  
Stock No. 17-T-5520

**a. Inspect Armature.**

GROWLER, Federal Stock No.  
17-G-5940

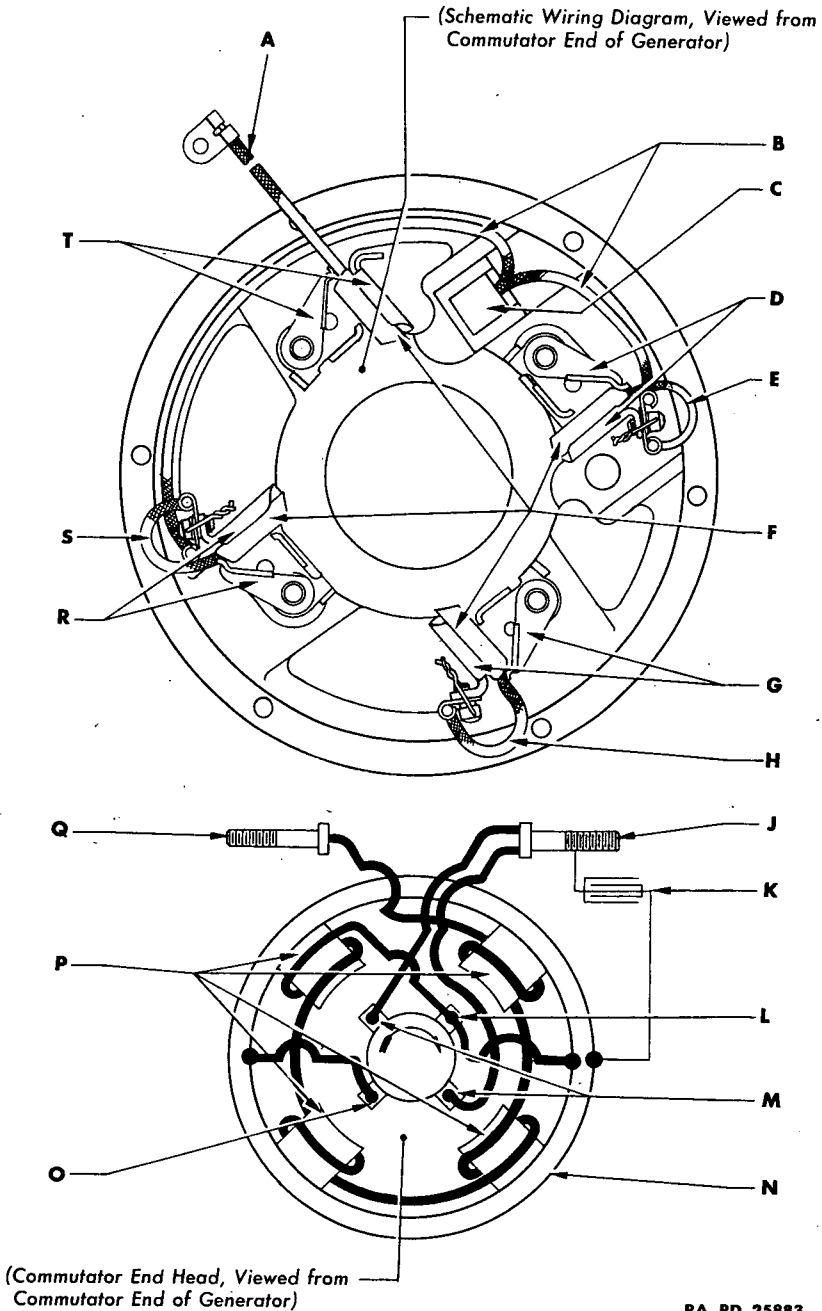
LAMP, test  
LATHE

(1) Inspect the armature (fig. 218) for evidence of wear on the commutator and at the bearing seats. Inspect the insulation and soldering to make sure all coils are in proper working order.

(2) If the commutator (fig. 218) is dirty or discolored, it can be cleaned by holding a piece of No. 00 sandpaper against it while turning the armature slowly. If the commutator is rough or worn it must be turned down on a lathe. **CAUTION:** Mount the armature on the bearing seats and not on the shaft centers. Take only a light cut and remove all burs. Undercut the mica to a depth of  $\frac{1}{32}$  inch after turning the commutator. The undercut must be square and free from burs.

(3) Check the armature for grounds with a test lamp and probes (fig. 201). Touch one probe to the armature shaft and touch the other probe to each commutator segment (fig. 218) in turn. If an armature

**ORDNANCE MAINTENANCE—POWER UNIT ACCESSORIES  
FOR MEDIUM TANKS M3A4 AND M4A4**



**Figure 220—Generator Wiring Diagram**

**GENERATOR CIRCUIT AND GENERATOR**

- A—LEAD, BRUSH, GENERATOR COMMUTATOR END HEAD
- B—LEADS, ARMATURE TERMINAL POST, GENERATOR COMMUTATOR END HEAD
- C—POST, TERMINAL, ARMATURE, GENERATOR COMMUTATOR END HEAD
- D—HOLDER, BRUSH, INSULATED, GENERATOR COMMUTATOR END HEAD
- E—LEAD, BRUSH, GENERATOR COMMUTATOR END HEAD
- F—BRUSH, GENERATOR COMMUTATOR END HEAD
- G—HOLDER, BRUSH, GROUNDED, GENERATOR COMMUTATOR END HEAD
- H—LEAD, BRUSH, GENERATOR COMMUTATOR END HEAD
- J—POST, TERMINAL, GENERATOR ARMATURE
- K—CONDENSER, GENERATOR COMMUTATOR END HEAD
- L—BRUSH, GROUNDED, GENERATOR COMMUTATOR END HEAD
- M—BRUSHES, INSULATED, GENERATOR COMMUTATOR END HEAD
- N—FRAME, GENERATOR
- O—BRUSH, GROUNDED, GENERATOR COMMUTATOR END HEAD
- P—POLE PIECE, GENERATOR
- Q—POST, TERMINAL, FIELD, GENERATOR COMMUTATOR END HEAD
- R—HOLDER, BRUSH, INSULATED, GENERATOR COMMUTATOR END HEAD
- S—LEAD, BRUSH, GENERATOR COMMUTATOR END HEAD
- T—HOLDER, BRUSH, GROUNDED, GENERATOR COMMUTATOR END HEAD

RA PD 25883B

**Legend for Figure 220—Generator Wiring Diagram**



**ORDNANCE MAINTENANCE—POWER UNIT ACCESSORIES  
FOR MEDIUM TANKS M3A4 AND M4A4**

coil or commutator segment is grounded, the lamp will burn. If a ground is found the armature must be replaced. **CAUTION:** Do not touch probes to bearing surfaces or brush contact surfaces as an arc would mar the surface.

(4) Check the armature for open circuits by touching the test probes to each pair of adjacent commutator segments. If the test lamp does not burn, the coil is open and the armature must be replaced.

(5) Check the armature for shorts with an alternating-current millivoltmeter and a growler (Federal Stock No. 17-G-5940) (fig. 219). Place the armature in the growler; adjust the tips of the probe so that they will touch adjacent commutator segments. Using the tips of the test probes as spaced, touch all the segments around the commutator until the highest reading is obtained on the millivoltmeter. While making this test, do not move the armature in the growler. When the highest voltmeter reading is obtained, note the position of the test probe in relation to the growler. *Hold the probe in this position* and rotate the armature in the growler. Read the meter for each pair of segments. The meter reading should be approximately uniform for each pair of segments tested. If a short circuit exists in the armature winding, the meter reading will be near zero. Replace the armature if a short is present.

**b. Inspect Generator Frame and Field Coils.**

**LAMP, test**

(1) Wash frame with cloth dampened in SOLVENT, dry-cleaning, and inspect for cracks.

(2) Check the field coils for grounds with the test lamp and probes (fig. 201). Touch one probe to frame and touch second probe to the field terminal post (fig. 220). If the lamp burns, a ground is present and the frame and field assembly must be replaced. **NOTE:** The frame and field are dipped and baked as one unit and must not be disassembled.

(3) Inspect the field coil leads for breaks and inspect the field terminal and terminal post for corrosion. Replace the frame and field coil assembly if the leads are broken. If the terminal post needs replacing, unsolder the old connection and resolder the new terminal post to the lead to secure a good connection.

(4) Check field resistance with an ohmmeter connected between the two field coil leads. Field resistance should be approximately 18 ohms. If resistance is less than 16 ohms, one field coil is shorted and frame and field assembly must be replaced.

**c. Inspect Commutator End Head.**

**LAMP, test**

**SCALE, spring**

(1) Inspect the generator brushes. The brushes must slide freely in the

## GENERATOR CIRCUIT AND GENERATOR

holder and must be free of dirt and oil. If they are oil-soaked or are worn to less than  $\frac{1}{2}$  inch in length they must be replaced. If the brush leads are broken or frayed, terminals corroded, or improperly soldered, replace the brushes.

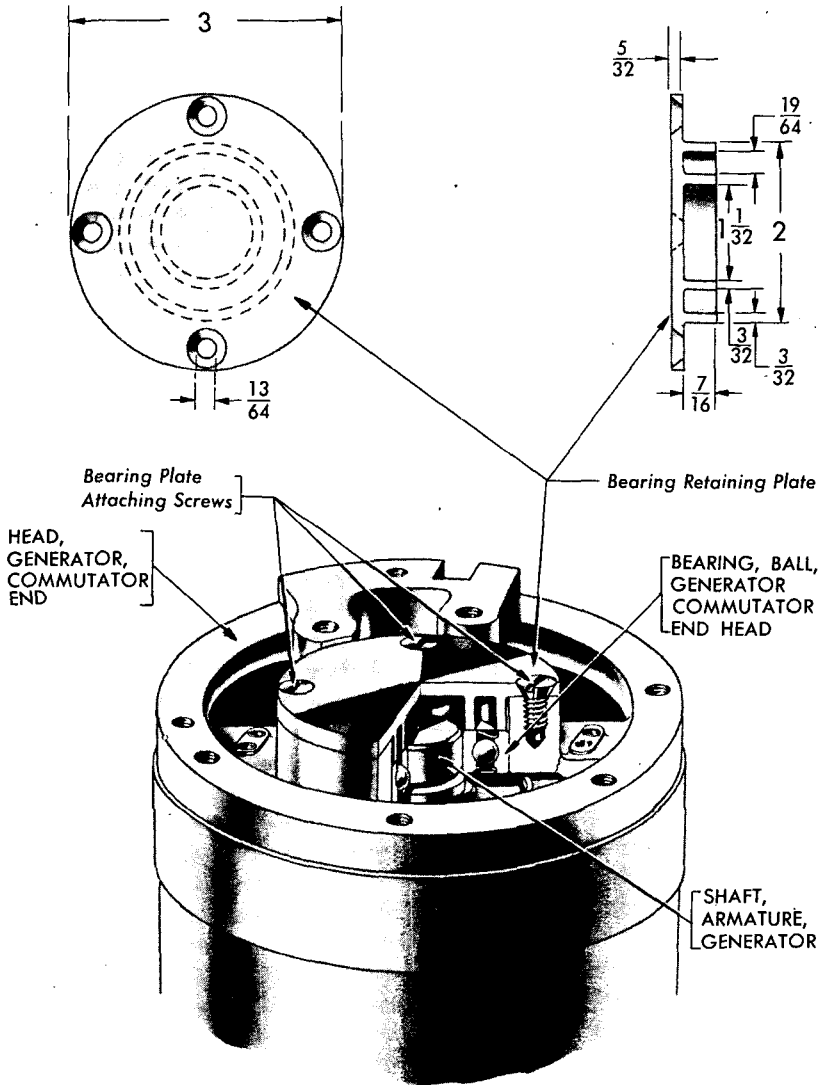
(2) Clean the head thoroughly and inspect for cracks, wear or faulty insulation. **CAUTION:** If a sealed bearing is used, do not wash bearing in SOLVENT, dry-cleaning, as washing will remove lubricant. Replace the insulation on the armature terminal post if cracked or broken and replace the head if the brush holder insulation is faulty. Check the armature terminal post and insulated brush holders with the test lamp and probes (fig. 201) by touching one probe to commutator end head and the other probe to the brush holders and armature terminal post. If the lamp burns when the probe is touched to the insulated brush holders, the commutator end head must be replaced. If the lamp burns when the probe is touched to the armature terminal post, the insulation must be replaced.

(3) Install the commutator end head on the armature shaft temporarily and assemble the brushes in their holders. If the edges of the brushes are not in perfect alignment with the commutator segments, replace the head. If new brushes are being used, sand them to secure the correct fit on commutator. Place a strip of No. 00 sandpaper, cut the exact width of the commutator, under a brush. Hold the sandpaper so that it fits the contour of the commutator and pull the sandpaper so that the brush is forced toward the brush holder. Sand just enough to give 80-percent fit of the brush as additional sanding merely shortens brush life.

(4) Check the brush spring tension with a spring scale. Hook the scale in the hole in the end of the brush arm and pull on a line parallel to the face of the brush. Take the reading just as the arm leaves the brush. If the tension is not between 45 and 55 ounces with new brushes (slightly less with worn brushes) disassemble the brush arm and spring. Bend the spring at the loop that rests on the spring stop to give the correct tension. Remove the brushes before taking head off the armature.

(5) Check the bearing for free rotation. If bearing is sticky or rough it must be replaced. On power unit mounted generators, the bearing is a semi-shielded type. Wash this bearing thoroughly in SOLVENT, dry-cleaning, and repack, half full with a high melting point grease. On fighting compartment mounted generators, a sealed bearing is used. Wipe bearing clean but *do not wash in SOLVENT, dry-cleaning*, as this will remove the lubricant. If bearing does not rotate freely and appears to be well lubricated, bearing must be replaced.

ORDNANCE MAINTENANCE—POWER UNIT ACCESSORIES  
FOR MEDIUM TANKS M3A4 AND M4A4



RA PD 25246

**Figure 221—Special Retaining Plate for Installing Generator Commutator End Head Bearing**

(a) To remove and install commutator end head bearing on power unit mounted generators.

PRESS, bench

1. Place head on bench press and press old bearing out of head, from

## GENERATOR CIRCUIT AND GENERATOR

armature side of head. Remove felt washer and retainers and spring washer from head.

2. Install spring washer and new felt washer with retainer on each side of washer. Place head on bench press and with a suitable arbor that contacts the outside race of the new bearing, press bearing into head. Be sure bearing is half full of a high melting point grease.

(b) To remove and install commutator end head bearing on fighting compartment mounted generator.

**PRESS**, bench

1. Place head on bench press and press out old bearing.

2. Attach special tool (fig. 221) to head and then place head on bench press and, using suitable arbor, press bearing into head until it rests against the special tool. Leave tool attached to head as it is used in the assembly of the head to the armature shaft and frame.

### d. Inspect Drive End Head and Bearing.

**DRIFT**

**PRESS**, bench

**HAMMER**

**SCREWDRIVER**

**PLIERS**, side cutting

(1) Clean the drive end head and bearing retainer and inspect for cracks or distortion. **NOTE:** Do not allow **SOLVENT**, dry-cleaning, to come in contact with felt washers on either side of bearing or in bearing if it is a sealed bearing.

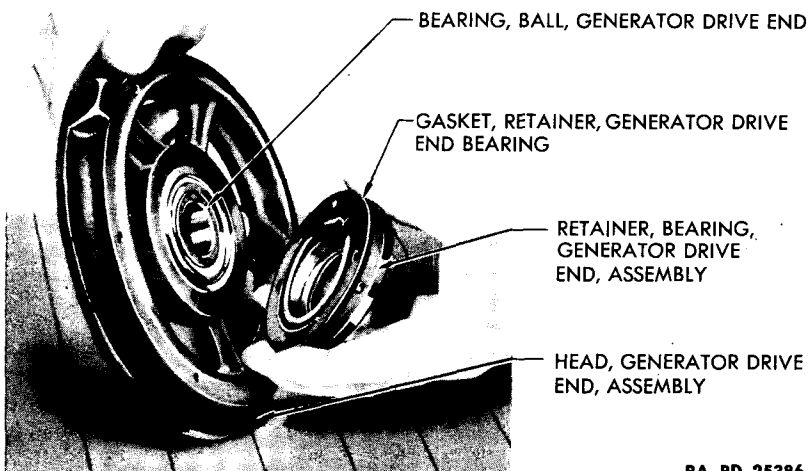
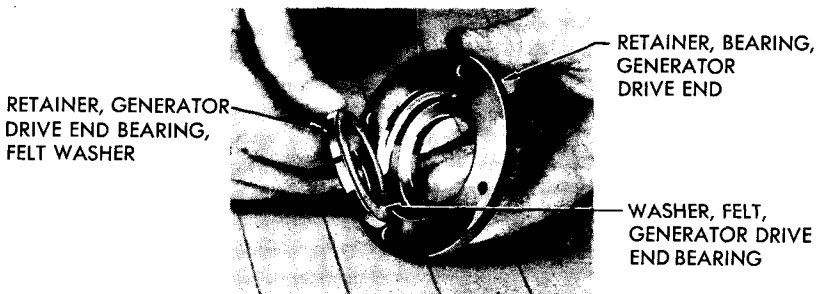
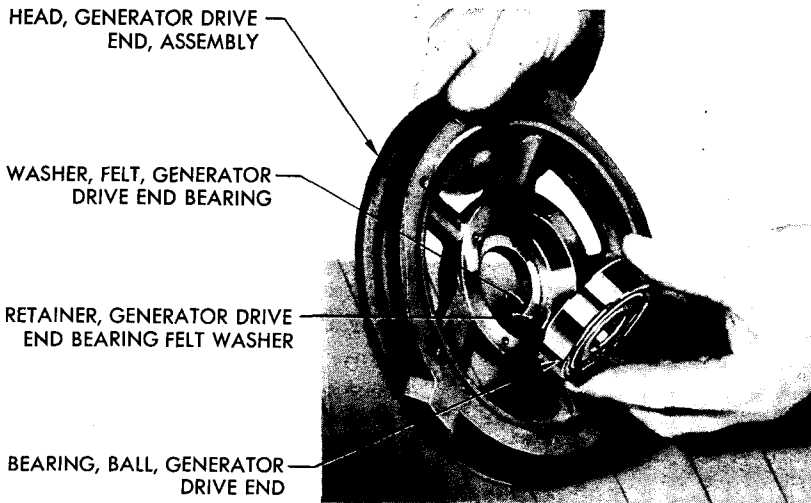
(2) Check the ball bearing for free rotation. On power unit mounted generators, a plain ball bearing is used. It should be half full of high melting point grease. If the bearing does not rotate freely and smoothly, remove and clean or install new bearing. On fighting compartment mounted generators, a sealed bearing is used. Check for free rotation and smoothness. If bearing is rough, replace bearing. This bearing must not be washed as the **SOLVENT**, dry-cleaning, would remove the lubricant.

(3) **REMOVE AND INSTALL DRIVE END BALL BEARING FROM DRIVE END HEAD** (fig. 222).

(a) Remove locking wire (side cutting pliers) and remove the four screws (screwdriver) securing the bearing retainer to the drive end head. Remove the bearing retainer and gasket. Place drive end head on bench press and, with suitable arbor, press bearing, felt washer and retainer, and outer shaft spacer from the drive end head. Pry out bearing felt washer and retainer from drive end bearing retainer.

(b) Place armature shaft outer spacer in drive end head and install new felt washer and washer retainer in head. Drive washer and retainer in carefully to avoid damage to retainer (hammer and drift). Place drive end head on bench press and, with suitable arbor, press bearing into place. Install felt washer and washer retainer in bearing retainer

**ORDNANCE MAINTENANCE—POWER UNIT ACCESSORIES  
FOR MEDIUM TANKS M3A4 AND M4A4**



RA PD 25386

**Figure 222—Drive End Bearing and Retainer Installation**

**GENERATOR CIRCUIT AND GENERATOR**

(hammer and drift). Position *new* gasket on drive end head, and secure bearing retainer to head with four screws (screwdriver). Install locking wires (side cutting pliers).

e. Inspect and clean field terminal insulation and washers. Replace if cracks or breaks are found. Inspect and clean terminal shield and cover, heat shield, and drive pulley. Replace if cracks, wear, or distortion are found.

f. Check the condenser on a condenser tester (Federal Stock No. 17-T-5520) for both capacity and leakage. Its capacity should be 1.0 microfarad.

**111. GENERATOR ASSEMBLY.**

PLIERS, side cutting

WRENCH, open-end, 1/2-in.

PRESS, bench

WRENCH, open-end, 9/16-in.

SCREWDRIVER

WRENCH, open-end, 1 5/16-in.

WRENCH, open-end, 7/16-in.

WRENCH, socket, 3/8-in.

**a. Install Armature in Drive End Head.**

PRESS, bench

Install inner shaft spacer on armature. Place drive end head on bench press and press armature into head.

**b. Install Armature and Drive End Head on Generator Frame.**

SCREWDRIVER

Slide armature into frame and field coil assembly and secure drive end head to frame with four screws (screwdriver). Stake screws in place to prevent loosening (fig. 223).

**c. Install Generator Commutator End Head on Generator Frame (fig. 224).**

PLIERS, side cutting

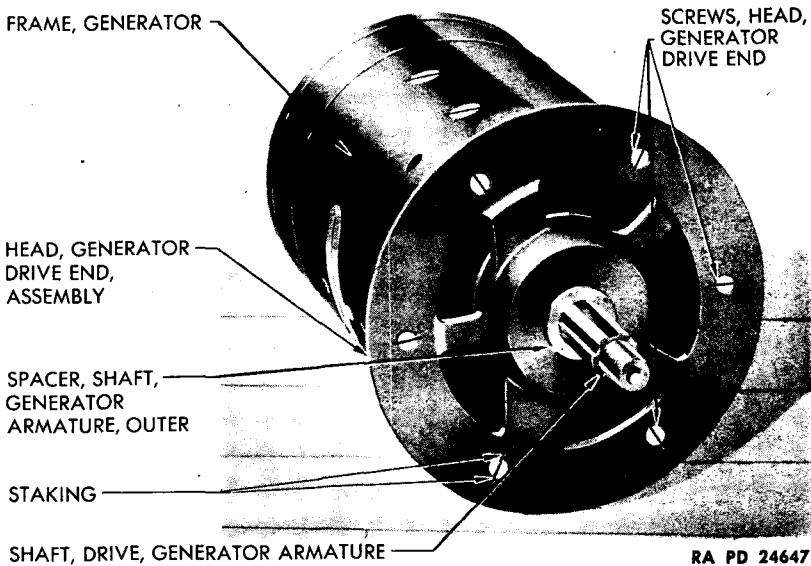
SCREWDRIVER

PRESS, bench

WRENCH, open-end, 7/16-in.

With special tool (fig. 221) attached to head, place generator frame on bench press and press head and bearing assembly on armature shaft until head is tight against frame. Secure with six screws and lock washers (screwdriver) and install locking wires (side cutting pliers). Remove special tool (screwdriver) and install bearing locking plate, lock washer, and retainer screw (7/16-in. open-end wrench). Install locking wire (side cutting pliers). Install gasket in commutator end head and secure cover cap (fig. 224) with three screws (screwdriver). Stake screws to prevent loosening. This cover cap is used on fighting compartment mounted generators only.

**ORDNANCE MAINTENANCE—POWER UNIT ACCESSORIES  
FOR MEDIUM TANKS M3A4 AND M4A4**



**Figure 223—Drive End Head Screws Staked in Position**

**d. Install Field Coil Terminal Post and Leads.**

**SCREWDRIVER**

**WRENCH**, socket,  $\frac{3}{8}$ -in.

Slide field terminal post and insulated bushing through commutator end head, install the two insulating washers, plain washer, and lock washer and secure with nut ( $\frac{3}{8}$ -in. socket wrench). Connect field coil leads (fig. 220) to brush holders and secure with screws (screwdriver).

**e. Install Terminal Shield and Terminal Shield Bracket (fig. 224).**

**PLIERS**, side cutting

**WRENCH**, open-end,  $\frac{1}{2}$ -in.

**SCREWDRIVER**

Position terminal shield and bracket on commutator end head and secure with three screws (screwdriver). Stake the one countersunk screw and install the locking wire on the two remaining screws. Place lock washer on cover stud and screw stud into commutator end head. Install insulating bushing, plain washer, condenser, plain washer, and secure with nut ( $\frac{1}{2}$ -in. open-end wrench). **NOTE:** On power unit mounted generator a terminal cover is used. Attach with four screws (screwdriver) and install lock wire (side cutting pliers).

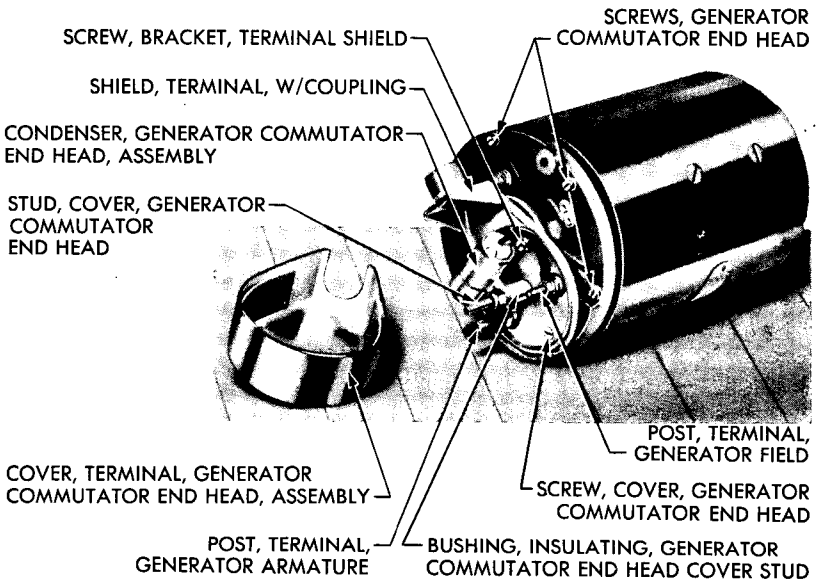
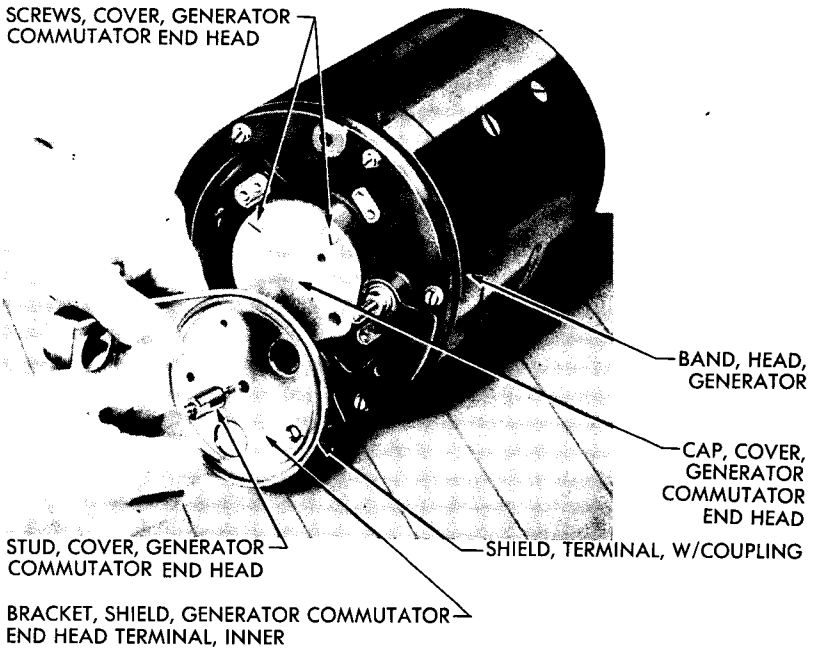
**f. Install Brushes and Head Band.**

**PLIERS**, side cutting

**SCREWDRIVER**

Lift brush springs and install brushes and connect brush leads

**GENERATOR CIRCUIT AND GENERATOR**

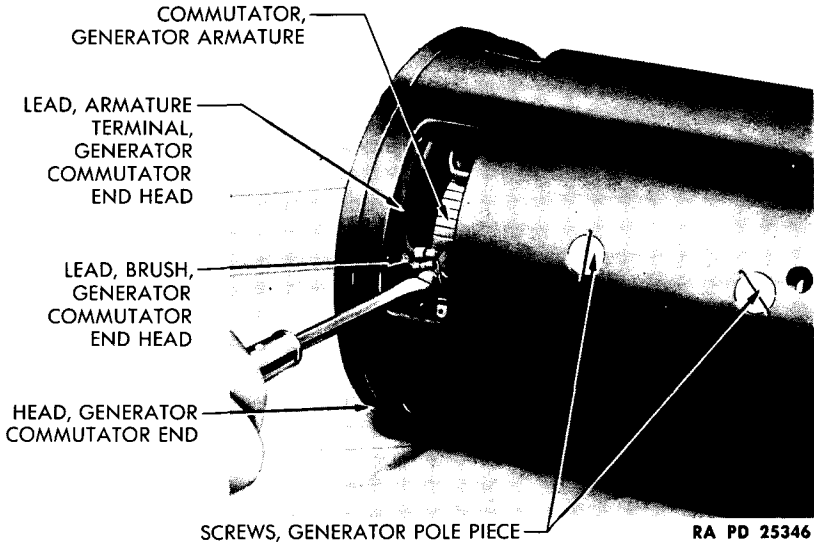


RA PD 25367

**Figure 224—Terminal Shield Installation**



**ORDNANCE MAINTENANCE—POWER UNIT ACCESSORIES  
FOR MEDIUM TANKS M3A4 AND M4A4**



**Figure 225—Connecting Brush Lead**

(fig. 225). Position head band on frame and secure with screw (screwdriver). Install locking wire (side cutting pliers).

**g. Install Drive Pulley on Generator.**

**PLIERS**, side cutting

**WRENCH**, open end,  $1\frac{5}{16}$ -in.

**PRESS**, bench

On power unit mounted generators, install the spacer on the shaft and the key in the shaft. Press the pulley into position (bench press) and secure with washer, lock plate, and nut ( $1\frac{5}{16}$ -in. open-end wrench) (fig. 216). On generators mounted in the fighting compartment, install the washer and nut ( $1\frac{5}{16}$ -in. open-end wrench) and install the cotter pin (inside cutting pliers) (fig. 217).

**h. Install Heat Shield and Mounting Bracket (This Applies Only to Generators Which Are Mounted on the Power Unit) (fig. 216).**

**PLIERS**, side cutting

**WRENCH**, open-end,  $\frac{9}{16}$ -in.

**SCREWDRIVER**

Position mounting bracket on generator and secure with four cap screws ( $\frac{9}{16}$ -in. open-end wrench) or four screws (screwdriver), whichever are on this generator. If screws are used, be sure to stake to prevent loosening. If cap screws are used, install locking wire through heads (side cutting pliers). Position heat shield on generator (fig. 216) and secure with six screws and lock washers (screwdriver). Install locking wires (side cutting pliers).

**GENERATOR CIRCUIT AND GENERATOR**

**i. Lubricate.**

On generators mounted on the power unit, add seven drops of OIL, engine, SAE 20, to each oiler situated in the end heads. Generators mounted in fighting compartment are not provided with exterior oilers, inasmuch as sealed type bearings are used.

**112. GENERATOR FINAL TESTS AND ADJUSTMENTS.**

AMMETER	VOLTMETER
BATTERY, 12-volt (2)	WIRE, jumper
RHEOSTAT, carbon pile	

**a. Field Coil Draw.**

AMMETER	RHEOSTAT, carbon pile
BATTERY, 12-volt (2)	VOLTMETER

Connect an ammeter, carbon pile rheostat and two 12-volt batteries in series with the field terminal post (fig. 224) and ground on the generator frame. Connect a voltmeter from the field terminal post to the generator frame. Adjust the voltage to 26.0 volts and read the ammeter. If the ampere reading is not between 1.0 and 1.51, replace the frame and field.

**b. Motorizing Draw.**

AMMETER	VOLTMETER
BATTERY, 12-volt (2)	WIRE, jumper
RHEOSTAT, carbon pile	

Connect the carbon pile rheostat, ammeter, and two 12-volt batteries in series with the armature terminal and the generator frame. Connect a jumper wire from the field to armature terminals and connect a voltmeter from the armature terminal to generator frame. Adjust the voltage to 26.0 volts. The armature should turn slowly and the ammeter should read from 4.85 to 5.35 amperes. If the current is not within these limits it indicates high resistance connections, worn bearings, or poor brush contact.

**113. GENERATOR INSTALLATION (MULTIPLE WATER PUMP TYPE POWER UNIT).**

PLIERS, side cutting	WRENCH, socket, $\frac{3}{8}$ -in., with 3-in. extension
SCREWDRIVER	WRENCH, socket, $\frac{1}{2}$ -in., with 3-in. extension
WRENCH, open-end, $\frac{3}{8}$ -in.	WRENCH, spanner, closed, MTM A4-7
WRENCH, open-end, $\frac{1}{2}$ -in.	
WRENCH, open-end, $\frac{9}{16}$ -in.	
WRENCH, open-end, $\frac{5}{8}$ -in.	

**ORDNANCE MAINTENANCE—POWER UNIT ACCESSORIES  
FOR MEDIUM TANKS M3A4 AND M4A4****a. Install Generator on Power Unit.****PLIERS**, side cutting  
**SCREWDRIVER****WRENCH**, open-end,  $\frac{5}{8}$ -in.

Position generator and bracket on mounting studs and secure with two nuts and pal nuts ( $\frac{5}{8}$ -in. open-end wrench). Install the two cap screws, plain washers, and lock washers in lower end of bracket and tighten ( $\frac{5}{8}$ -in. open-end wrench). Install locking wires (side cutting pliers). **CAUTION:** Aline generator pulley and drive pulley so that belt will not be under a side strain when operating. Position water pump relief tube on heat shield, secure with screw (screwdriver), and install locking wire (side cutting pliers).

**b. Install No. 2 Ignition Coil.****PLIERS**, side cutting  
**WRENCH**, open-end,  $\frac{3}{8}$ -in.**WRENCH**, open-end,  $\frac{9}{16}$ -in.

Install coil on bracket and secure with two nuts and lock washers ( $\frac{9}{16}$ -in. open-end wrench). Install locking wire (side cutting pliers). Place wire, with knurled nut, in opening in center of coil and with fingers screw nut into opening securely. Place black wire from distributor on terminal of coil to which there are no wires attached and secure with nut and lock washer ( $\frac{3}{8}$ -in. open-end wrench). Connect the two No. 12 blue wires to the coil resistor terminal on rear of coil and secure with nut and lock washer ( $\frac{3}{8}$ -in. open-end wrench).

**c. Install Drive Belt.****SCREWDRIVER**  
**WRENCH**, open-end,  $\frac{1}{2}$ -in.**WRENCH**, spanner, closed,  
**MTM A4-7**

Place drive belt on drive pulley and generator pulley, install pulley flange, and tighten with a closed spanner wrench (MTM A4-7). Tighten flange until there is between  $\frac{1}{2}$  and  $\frac{5}{8}$ -inch slack in belt when measured by pushing inward midway between the pulleys. Tighten set screw (screwdriver) and secure with lock nut ( $\frac{1}{2}$ -in. open-end wrench).

**d. Connect Generator Wires.****PLIERS**, side cutting  
**WRENCH**, socket,  $\frac{3}{8}$ -in., with  
3-in. extension**WRENCH**, socket,  $\frac{1}{2}$ -in., with  
3-in. extension

Place wires in terminal shield and tighten knurled nut. Connect the No. 6 black wire to the armature (large) terminal (fig. 224) and the No. 10 black wire to the field (small) terminal (fig. 224). Secure with lock washers and nuts ( $\frac{3}{8}$ -in. and  $\frac{1}{2}$ -in. socket wrenches, with 3-in. extension). Place terminal cover in position and screw on with wing nut. Install lock wire (side cutting pliers).

## GENERATOR CIRCUIT AND GENERATOR

### 114. GENERATOR INSTALLATION (SINGLE WATER PUMP TYPE POWER UNIT).

WRENCH, open-end,  $\frac{7}{16}$ -in.      WRENCH, open-end,  $1\frac{1}{8}$ -in.  
WRENCH, open-end,  $\frac{7}{8}$ -in.

a. **Install Generator in Cradle** (fig. 215).

WRENCH, open-end,  $\frac{7}{8}$ -in.      WRENCH, open-end,  $1\frac{1}{8}$ -in.

Position generator in cradle (placing the drive belts in pulley grooves while generator is being lowered into position). NOTE: Locate generator so that dowel pin in cradle fits hole in generator frame. Lower straps into position over generator and secure with two mounting washers and nuts ( $\frac{7}{8}$ -in. open-end wrench). With the adjusting bolts loosened, locate generator and cradle so there is  $\frac{1}{2}$ -inch deflection of belts (measured midway between pulleys) when belts are placed under 8- to 10-pound pull. Hold generator in this position and tighten lock bolts (fig. 215) ( $1\frac{1}{8}$ -in. open-end wrench).

b. **Connect Generator Wires** (par. 113 d).

Connect ground wire to stud on back of generator.

c. **Install Generator Cover.**

WRENCH, open-end,  $\frac{7}{16}$ -in.

Position cover and secure with the bolt at top ( $\frac{7}{16}$ -in. open-end wrench) and two clamps at bottom.

### 115. POLARIZE GENERATOR.

a. Polarize the generator before operation by momentarily connecting a jumper from the battery to the generator armature terminal.

### 116. GENERATOR REGULATOR.

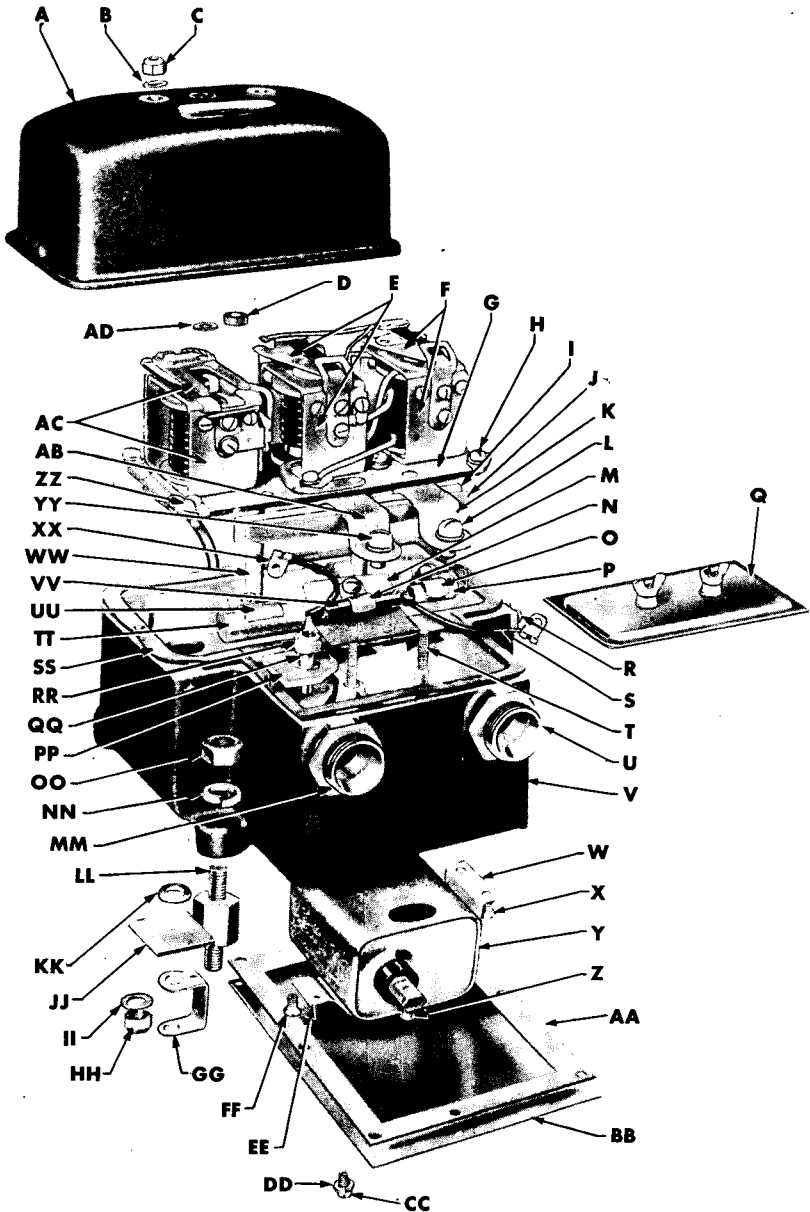
a. **Description.** The generator regulator (fig. 226) mounted in the fighting compartment at the rear of the battery box, consists of three units mounted on a common base. The circuit breaker closes to permit current from the generator to charge the battery and opens to prevent a discharge of current in the opposite direction when the generator is not operating or operating at a very low speed. The current regulator limits the generator current to 50 amperes. The voltage regulator maintains the circuit voltage fairly constant between 27 and 30 volts and controls the charge to the battery. As the battery becomes more completely charged, the charge rate will decrease. The filterette, which is built into the base of the regulator, is a heavy coil of few turns. It suppresses electrical oscillations which would, otherwise, cause harmful noise in the radio set.

b. **Removal.**

PLIERS, side cutting  
SCREWDRIVER

WRENCH, socket,  $\frac{1}{2}$ -in., with  
8-in. extension

**ORDNANCE MAINTENANCE—POWER UNIT ACCESSORIES  
FOR MEDIUM TANKS M3A4 AND M4A4**



RA PD 25479

**Figure 226—Parts of Generator Regulator**

**GENERATOR CIRCUIT AND GENERATOR**

- A**—COVER, GENERATOR REGULATOR
- B**—WASHER, PLAIN, COVER HOLDING, GENERATOR REGULATOR
- C**—NUT, COVER HOLDING, GENERATOR REGULATOR
- D**—WASHER, RUBBER, COVER HOLDING, GENERATOR REGULATOR
- E**—REGULATOR, CURRENT, GENERATOR REGULATOR
- F**—REGULATOR, VOLTAGE, GENERATOR REGULATOR
- G**—BASE, SUB, GENERATOR REGULATOR
- H**—SCREW, MOUNTING, SUB BASE TO BASE, GENERATOR REGULATOR
- I**—GASKET, TERMINAL SLOT, CORK, GENERATOR REGULATOR
- J**—INSULATION, TERMINAL SLOT, GENERATOR REGULATOR
- K**—TERMINAL, FIELD, GENERATOR REGULATOR
- L**—SCREW, TERMINAL, ARMATURE, GENERATOR REGULATOR
- M**—INSULATION, RESISTOR MOUNTING, GENERATOR REGULATOR
- N**—CLIP, MOUNTING, RESISTOR, GENERATOR REGULATOR
- O**—CLIP, MOUNTING, CONDENSER, GENERATOR REGULATOR
- P**—CONDENSER (RADIO TYPE), GENERATOR REGULATOR
- Q**—COVER, TERMINAL, GENERATOR REGULATOR
- R**—SCREW, GROUND, GENERATOR REGULATOR
- S**—LEAD, CONDENSER (RADIO TYPE) TO VOLTAGE REGULATOR, GENERATOR REGULATOR
- T**—STUD, TERMINAL COVER, GENERATOR REGULATOR
- U**—COUPLING, GENERATOR REGULATOR
- V**—BASE, GENERATOR REGULATOR, ASSEMBLY
- W**—STRAP, MOUNTING, FILTERETTE, GENERATOR REGULATOR
- X**—SCREW, MOUNTING, FILTERETTE STRAP, GENERATOR REGULATOR
- Y**—FILTERETTE, GENERATOR REGULATOR
- Z**—SCREW, TERMINAL, FILTERETTE, GENERATOR REGULATOR
- AA**—GASKET, BOTTOM COVER, CORK, GENERATOR REGULATOR
- BB**—PLATE, COVER, BOTTOM, GENERATOR REGULATOR
- CC**—SCREW, MOUNTING, BOTTOM COVER PLATE, GENERATOR REGULATOR
- DD**—WASHER, LOCK, BOTTOM COVER PLATE MOUNTING SCREW, GENERATOR REGULATOR
- EE**—STRAP, MOUNTING, FILTERETTE, GENERATOR REGULATOR
- FF**—SCREW, MOUNTING, FILTERETTE STRAP, GENERATOR REGULATOR
- GG**—CONNECTOR, BATTERY TERMINAL STUD TO FILTERETTE, GENERATOR REGULATOR
- HH**—NUT, BATTERY TERMINAL STUD, GENERATOR REGULATOR
- II**—WASHER, BATTERY TERMINAL STUD, LOWER, GENERATOR REGULATOR
- JJ**—INSULATION, BATTERY TERMINAL STUD, LOWER, GENERATOR REGULATOR
- KK**—WASHER, INSULATING, BATTERY TERMINAL STUD, GENERATOR REGULATOR
- LL**—STUD, MOUNTING, GENERATOR REGULATOR
- MM**—COUPLING, GENERATOR REGULATOR
- NN**—WASHER, LOCK, MOUNTING STUD, GENERATOR REGULATOR
- OO**—NUT, MOUNTING STUD, GENERATOR REGULATOR
- PP**—INSULATION, BATTERY TERMINAL STUD, UPPER, GENERATOR REGULATOR
- QQ**—STUD, TERMINAL, BATTERY, GENERATOR REGULATOR
- RR**—NUT, BATTERY TERMINAL STUD, GENERATOR REGULATOR
- SS**—GASKET, COVER, GENERATOR REGULATOR
- TT**—CONDENSER (AUTOMOTIVE TYPE), GENERATOR REGULATOR
- UU**—CLIP, MOUNTING, CONDENSER (AUTOMOTIVE TYPE), GENERATOR REGULATOR
- VV**—RESISTOR, GENERATOR REGULATOR
- WW**—STUD, COVER, GENERATOR REGULATOR
- XX**—LEAD, CONDENSER (AUTOMOTIVE TYPE) TO CURRENT REGULATOR, GENERATOR REGULATOR
- YY**—SCREW, TERMINAL, FIELD, GENERATOR REGULATOR
- ZZ**—PLATE, LOCK, BASE MOUNTING SCREW, GENERATOR REGULATOR
- AB**—TERMINAL, ARMATURE, GENERATOR REGULATOR
- AC**—BREAKER, CIRCUIT, GENERATOR REGULATOR
- AD**—WASHER, PLAIN, COVER HOLDING, GENERATOR REGULATOR

RA PD 25479B

**Legend for Figure 226—Parts of Generator Regulator**

**ORDNANCE MAINTENANCE—POWER UNIT ACCESSORIES  
FOR MEDIUM TANKS M3A4 AND M4A4**

## (1) DISCONNECT WIRES.

PLIERS, side cutting  
SCREWDRIVER

WRENCH, socket, 1/2-in.

Remove locking wires (side cutting pliers) and loosen the two wing nuts at the same time and remove terminal box cover. Remove locking wires (side cutting pliers), and remove screws (screwdriver) from armature and field terminals. Remove lock nut from battery terminal with 1/2-inch socket wrench. Remove titeflex nuts from side of terminal box and withdraw wires from box.

## c. Tests and Adjustments.

BATTERY, 12-volt (2)  
GAGE, feeler, 0.010- to 0.016-in.  
GAGE, pin  
LAMP, test

OHMMETER  
PLIERS, side cutting  
SCREWDRIVER  
WRENCH, open-end, 7/16-in.

**NOTE:** The generator regulator should never be disassembled unless the following tests have been made and then only the defective parts should be removed and replaced.

## (1) VISUAL INSPECTION.

Before making any of the following tests or adjustments, a close visual inspection should be given to the following points. Before this inspection can be made the following parts must be disassembled. Remove the two nuts and washers securing the cover and remove cover (7/16-in. open-end wrench). Remove the locking wire (side cutting pliers) and remove the eight screws and lock washers (screwdriver) and remove the bottom cover plate (fig. 226). Remove the locking wires (side cutting pliers) and remove the six screws and lock washers (screwdriver) securing the subbase to the casting. Remove lock wire (side cutting pliers) and remove the two screws in the adjusting brackets (fig. 227) to which the black wires from the condensers are attached. Disconnect wires. Disconnect lead from circuit breaker to filterette in bottom of base (screwdriver and side cutting pliers). Lift subbase with units off of base.

- (a) Evidence of burning or abnormally high temperatures.
- (b) Loose connections, either soldered or screw type.
- (c) Contacts loose or misaligned.
- (d) Bent armatures, distorted armature hinges, bent or distorted armature springs; bent armature stop on circuit breaker.
- (e) Field yoke bent.
- (f) Corrosion.
- (g) Broken carbon resistors, gaskets, etc.
- (h) Reversed armature springs.

**GENERATOR CIRCUIT AND GENERATOR****(2) CHECK RESISTORS (figs. 226 and 229).****OHMMETER****SCREWDRIVER****PLIERS**, side cutting

Remove the resistors one at a time (side cutting pliers and screwdriver) and check them on an ohmmeter. Replace any that is cracked or is not within the following limits: (Replace each resistor before removing the next one). R 1 (carbon type) marked 100, mounted on bottom of subbase, 95 to 105 ohms; R 2 (carbon type) marked 70, mounted on bottom of subbase, 68 to 72 ohms; R 3 (wire type) mounted on bottom of subbase, 130 to 140 ohms; R 4 (radio type) mounted in base underneath subbase, 100 ohms.

**(3) CHECK CIRCUIT BREAKER SHUNT COIL.****OHMMETER**

With an ohmmeter, measure the resistance from the shunt coil terminal (yellow wire which was grounded to the base by the subbase mounting screw) to the stationary contact of the circuit breaker (fig. 227). Replace the circuit breaker (par. 116 d (2)) if resistance is not between 98.0 to 108.0 ohms. (Early models had a resistance of 215 to 237 ohms.)

**(4) CHECK VOLTAGE REGULATOR COIL.****OHMMETER****SCREWDRIVER****PLIERS**, side cutting

(a) Remove the locking wires (side cutting pliers) and remove the two screws securing the voltage regulator coil leads to the subbase. Connect an ohmmeter between the two leads and check the resistance of the coil. Replace the voltage regulator unit (par. 116 d (3)) if the resistance is not between 63.6 and 70.4 ohms. **CAUTION:** Connect leads in exactly the same positions as interchanged lead would reverse the polarity and make the unit inoperative.

(b) Disconnect the voltage regulator coil lead where it fastens to the armature terminal through the base (fig. 227) (side cutting pliers and screwdriver), and measure the resistance of the frequency winding from this lead to the current regulator adjusting bracket (fig. 227). Replace the voltage regulator (par. 116 d (3)) if the resistance is not between 0.065 and 0.071 ohms.

**(5) CHECK CONDENSERS (fig. 226).****PLIERS**, side cutting**TESTER**, condenser, Federal**SCREWDRIVER**

Stock No. 17-T-5520

Remove the condensers one at a time (side cutting pliers and screwdriver) and check them on a condenser tester for capacity and grounds (Federal Stock No. 17-T-5520). Replace if grounded or if capacity is



**ORDNANCE MAINTENANCE—POWER UNIT ACCESSORIES  
FOR MEDIUM TANKS M3A4 AND M4A4**

not as follows: C 1 (automotive type) capacity 0.15 to 0.19 microfarads; C 2 (radio type) capacity 0.006 microfarads.

(6) **CHECK CONTACTS.**

(a) *Inspection and Cleaning.*

In normal use the contacts will become grayed. If the contacts are dirty, clean them with linen tape and SOLVENT, dry-cleaning. Dampen the tape in the SOLVENT, dry-cleaning, and draw the tape between the contacts. Repeat with a dry piece of tape to remove any residue. If the contacts are burned excessively, replace the unit as described in paragraph 116 d.

(b) *Contact Pressure Tests.*

BATTERY, 12-volt (2)

SCALE, spring

LAMP, test

SCREWDRIVER

PLIERS

1. *Voltage Regulator and Current Regulator.*

Connect the batteries and test lamp in series with the generator regulator "A" and "F" terminals. Remove the adjusting nut from the armature spring (fig. 228) (pliers) and remove the screw securing the adjusting bracket (screwdriver). Hold the armature down firmly with fingers and with a spring scale hooked at the upper contact, pull the contacts apart. Take the reading as the contacts separate as indicated when the test lamp ceases to burn. If the tension is not between seven and eight ounces, replace the unit (par. 116 d).

(7) **CHECK ARMATURE AIR GAP.**

BATTERY, 12-volt (2)

LAMP, test

GAGE, pin

(a) *Circuit Breaker (fig. 228).*

Use a pin gage inserted between the armature and magnet core next to the brass pin in the core and on the side nearest the contacts. Adjust the gap to 0.0595 to 0.0625 inch by bending the armature stop (fig. 227) making sure the stop does not interfere with the armature movement.

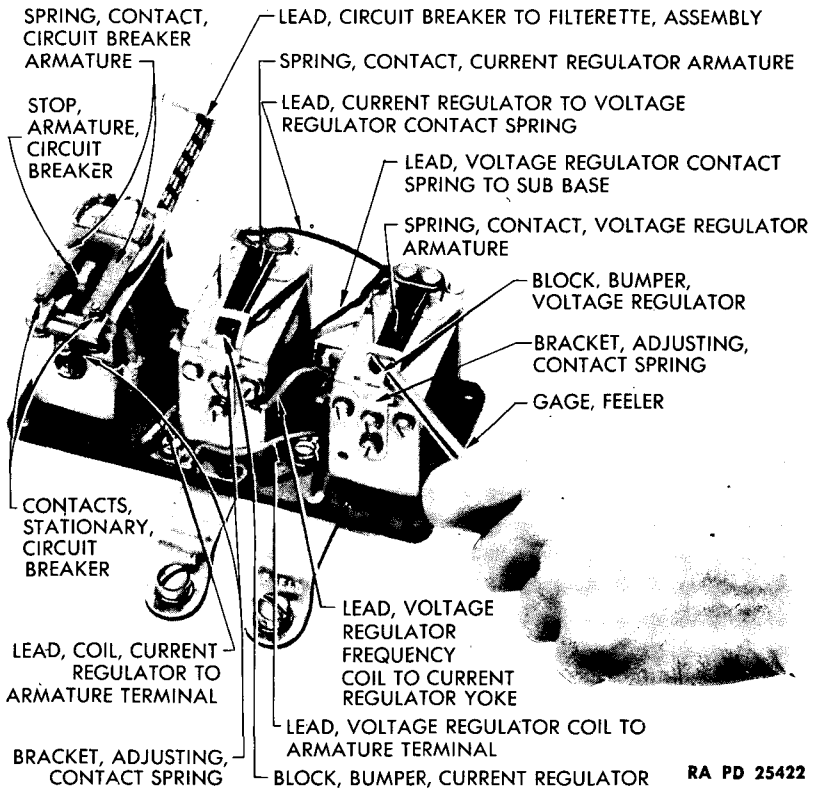
(b) *Voltage Regulator (fig. 228).*

Use a pin gage in the same position as in the circuit breaker check. The contacts should be closed when a 0.042-inch gage is in place and open when a 0.040-inch gage is used. Apply pressure near the center of the armature when measuring the air gap, but be careful that contact spring (fig. 227) is not touched. Adjust the gap by raising or lowering the contact spring adjusting bracket (fig. 227).

(c) *Current Regulator (fig. 228).*

Measure the air gap in the same manner as outlined for the voltage regulator using 0.047-inch and 0.049-inch gages. NOTE: Use a test lamp in series with the generator regulator "A" and "F" terminals and two

**GENERATOR CIRCUIT AND GENERATOR**



**Figure 227—Generator Regulator Subbase—Front View**

12-volt batteries to indicate when the contacts are closed and open. The lamp will burn brightly when the contact is closed and will go out or dim when the contact is open.

(8) CHECK GAP BETWEEN CONTACT SPRING AND ADJUSTING BRACKET ON VOLTAGE AND CURRENT REGULATORS.

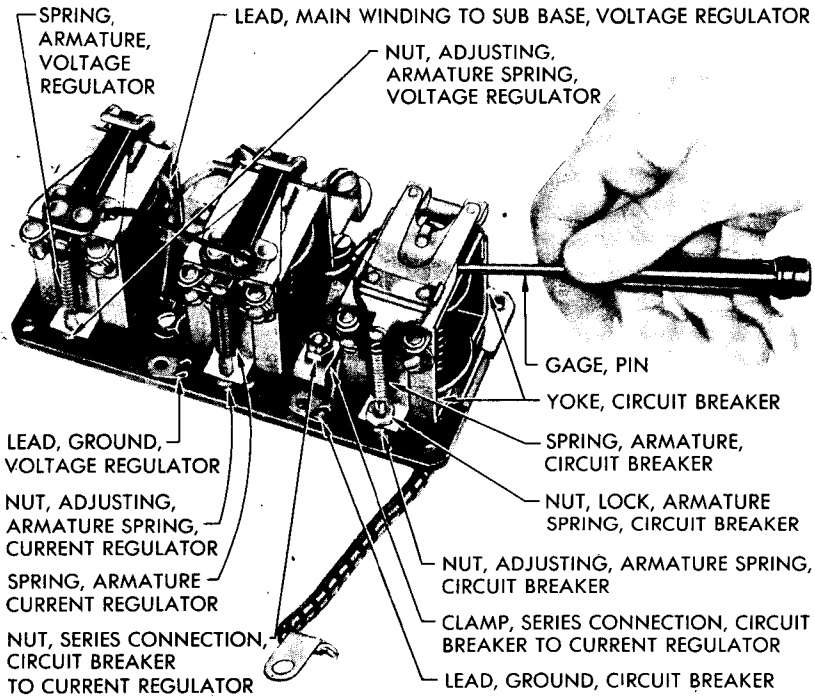
GAGE, feeler, 0.010- to 0.016-in.

Hold the armature down against the magnet core stop pin and, with a feeler gage, measure the gap between the contact spring and the adjustable bracket (fig. 227). Gap should be 0.010 to 0.016 inch. Make sure bumper block (fig. 227) is in place on adjustable bracket and then adjust bracket to obtain the required gap by bending that portion of the bracket on which the bumper block is mounted.

(9) CHECK GENERATOR REGULATOR FILTERETTE (fig. 226).  
OHMMETER

(a) Check for Loose Terminals. Connect the ohmmeter between the

**ORDNANCE MAINTENANCE—POWER UNIT ACCESSORIES  
FOR MEDIUM TANKS M3A4 AND M4A4**



RA PD 25421

**Figure 228—Generator Regulator Subbase—Rear View**

two terminals on the filterette. Try to move the terminals with fingers; if the ohmmeter fluctuates, the terminals are loose and the filterette must be replaced.

(b) *Check for Grounds.* Connect the ohmmeter between one of the terminals and the case. If a high reading is obtained there are no grounds. If no reading or a very low reading is obtained there is a ground in the filterette and it must be replaced.

**d. Unit Replacement Procedure.**

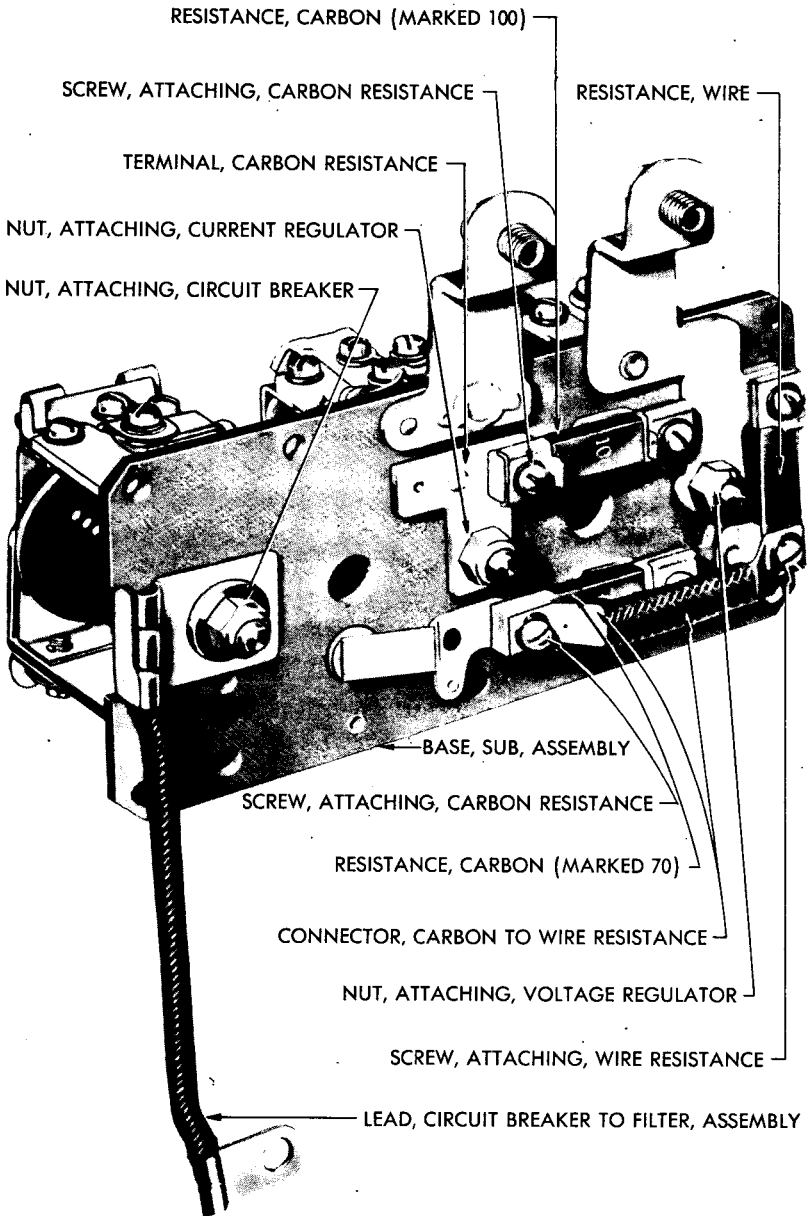
**NOTE:** It is unnecessary to disassemble the regulator further unless the previous tests and inspection show that replacement parts are needed.

**(1) REPLACEMENT OF CIRCUIT BREAKER UNIT (fig. 226).**

**WRENCH**, open-end,  $\frac{7}{16}$ -in.      **WRENCH**, socket,  $\frac{3}{8}$ -in.

(a) Remove the nut ( $\frac{3}{8}$ -in. socket wrench) and clamp on the series connection between the circuit breaker and current regulator (fig. 228). Remove the nut, washer, and lead ( $\frac{7}{16}$ -in. open-end wrench) from the circuit breaker core (fig. 229) and lift unit from subbase.

**GENERATOR CIRCUIT AND GENERATOR**



RA PD 25477

**Figure 229—Generator Regulator Subbase—Bottom View**

**ORDNANCE MAINTENANCE—POWER UNIT ACCESSORIES  
FOR MEDIUM TANKS M3A4 AND M4A4**

(b) Install the new unit on the subbase and assemble the lead, washer, and nut, and tighten with a  $\frac{7}{16}$ -inch open-end wrench. Make sure the alining lug enters the hole in the subbase. Install the clamp, lock washer and nut on the series connection and tighten with a  $\frac{3}{8}$ -inch socket wrench.

**(2) REPLACEMENT OF VOLTAGE REGULATOR UNIT (fig. 226).**

**PLIERS**, side cutting

**WRENCH**, open-end,  $\frac{7}{16}$ -in.

**SCREWDRIVER**

(a) Remove the lock wire (side cutting pliers) and remove the screw (screwdriver) which secures the main winding lead to the base between the voltage and current regulators. Remove the lock wires (side cutting pliers) and remove the screws (screwdriver) which secure the frequency coil leads to the current regulator yoke and to the current regulator winding where it is fastened through the subbase to the generator regulator armature terminal. On early regulators, unsolder the connection on the voltage regulator contact spring to which the wire from the current regulator contact spring and the wire which leads to the subbase is connected (fig. 228). On later models, remove the lock wire (side cutting pliers) and remove the screw (screwdriver) which secures these two wires to the subbase. Remove the core nut underneath the subbase ( $\frac{7}{16}$ -in. open-end wrench) and lift unit from subbase (fig. 229).

(b) Install the new voltage regulator on the subbase, making sure the lug on the regulator yoke enters the hole in the base and secure with the nut ( $\frac{7}{16}$ -in. open-end wrench) (fig. 229). On early model regulators, solder the lead from the base (black wire, fig. 227) and the lead from the current regulator contact spring (black wire, fig. 227) to the contact spring of the voltage regulator. Inspect the contact spring to be sure it has not lost its temper due to overheating. On later models, secure the two leads to the subbase with a screw (screwdriver) and install locking wire (side cutting pliers). The main winding leads come out of the coil at the top. The lead from the center must be secured to the base (fig. 228) between the voltage and current regulators (screwdriver) in the hole toward the back of the subbase. The other main winding lead is grounded by the base mounting screw (fig. 228) during the final assembly. Connect the upper lead from the frequency winding to the current regulator yoke (fig. 227) and connect the lower lead to the current regulator winding where it connects to the "A" terminal through the base (fig. 227). Lock wire all screws (side cutting pliers).

**(3) REPLACEMENT OF CURRENT REGULATOR UNIT (fig. 226).**

**PLIERS**, side cutting

**WRENCH**, open-end,  $\frac{7}{16}$ -in.

**SCREWDRIVER**

**WRENCH**, socket,  $\frac{3}{8}$ -in.

(a) Remove the nut and clamp ( $\frac{3}{8}$ -in. socket wrench) from the

## GENERATOR CIRCUIT AND GENERATOR

series coil connection (fig. 228) and then remove the lock wire (side cutting pliers) and screw (screwdriver) securing the voltage regulator frequency coil lead to the current regulator yoke (fig. 227). Remove the locking wire (side cutting pliers) and remove the screw (screwdriver) which secures the coil winding to the "A" terminal (fig. 227). On early model regulators unsolder the connection on the contact spring (fig. 228). On later models, remove the lock wire (side cutting pliers) and remove the screw (screwdriver) which secures this lead to the subbase. Remove the lock wire (side cutting pliers) and the screw (screwdriver) which secures the 100-ampere resistor to the connector (fig. 229) on the bottom of the subbase (this is to prevent cracking the resistor when the unit is removed). Remove the nut ( $\frac{7}{16}$ -in. open-end wrench) from the core on the bottom of the subbase (fig. 229) and lift current regulator from subbase.

(b) Install the new unit on the subbase, making sure lug on bottom of current regulator yoke enters hole in subbase, place the resistor connector in place, and secure with nut ( $\frac{7}{16}$ -in. open-end wrench) (fig. 229). Install the resistor and clamp, and secure with lock washer and screw (screwdriver) (fig. 229). Assemble the bottom lead from the voltage regulator and the coil winding of the current regulator and secure to the "A" terminal with a screw, flat washer, and lock washer (fig. 227). On early model regulators, solder the lead from the contact spring of the voltage regulator to the contact spring of the current regulator (fig. 228). Inspect contact spring to make sure it has not lost its temper due to overheating. On late model regulators, secure this wire to the subbase with a screw (screwdriver) and then lock wire (side cutting pliers). Install the clamp and nut on the series connection between the circuit breaker and current regulator and tighten nut ( $\frac{3}{8}$ -in. open-end wrench) (fig. 228).

### (4) TO REPLACE THE FILTERETTE (fig. 226).

PLIERS, side cutting

SCREWDRIVER

(a) Remove the lock wire (side cutting pliers) and remove the two screws which secure the filterette terminals to the battery terminal connector and the lead from the circuit breaker. Remove the lock wire (side cutting pliers) and remove the two screws (screwdriver) securing the upper end of the filterette bracket (screwdriver) and remove the bracket and filterette.

(b) Position the filterette and bracket in the base and secure with the three screws (screwdriver). Lock wire the two screws at the upper end of the bracket. Connect the lead from the circuit breaker and secure with lock washer and screw (screwdriver). Secure the battery terminal con-

**ORDNANCE MAINTENANCE—POWER UNIT ACCESSORIES  
FOR MEDIUM TANKS M3A4 AND M4A4**

nection to the other terminal with lock washer and screw (screwdriver).  
Lock wire both screws (side cutting pliers).

**e. Assembly of Subbase, Base, and Bottom Cover Plate.**

**PLIERS**, side cutting

**WRENCH**, open-end,  $\frac{7}{16}$ -in.

**SCREWDRIVER**

**(1) INSTALL SUBBASE TO BASE ASSEMBLY.**

**PLIERS**, side cutting

**SCREWDRIVER**

Position subbase and secure with six screws and lock washers (screwdriver), after connecting the two ground leads (fig. 228) from circuit breaker and voltage regulator to two of the screws. The four corner screws also have lock plates which fit over the corners of the subbase. Connect the lead from the automotive type condenser to the current regulator yoke and connect the lead from the radio type condenser to the voltage regulator yoke with the screws, lock washers, and plain washers (screwdriver) (fig. 226). Lock wire all screws (side cutting pliers).

**(2) INSTALL BOTTOM COVER PLATE.**

**PLIERS**, side cutting

**SCREWDRIVER**

Connect the lead from the circuit breaker, which attaches on the bottom of the subbase (fig. 229) to the "in" terminal of the filterette (end opposite that which connects to the battery terminal) and secure with screw, lock washer, and plain washer (screwdriver). Install locking wire (side cutting pliers). Place new gasket on bottom of base and position bottom cover plate and secure with eight screws and lock washers (screwdriver). Install locking wire through all eight screws (side cutting pliers). After regulator is completely assembled, its base should be struck sharply on the bench several times to insure that all parts are settled in place. **CAUTION:** Be sure to strike base squarely so that mounting lugs are not damaged.

**f. Installation.**

**PLIERS**, side cutting

**WRENCH**, socket,  $\frac{1}{2}$ -in., with

**SCREWDRIVER**

8-in. extension

**(1) INSTALL REGULATOR ON MOUNTING PADS.**

**WRENCH**, socket,  $\frac{1}{2}$ -in., with 8-in. extension.

Position regulator on mounting pads and secure with four nuts and lock washers.

**(2) CONNECT WIRES.**

**SCREWDRIVER**

**WRENCH**, socket,  $\frac{1}{2}$ -in.

Insert wires through openings in side of terminal box and secure with titeflex nuts. Connect wires to respective posts (figs. 213) and secure with screws on armature and field terminals (screwdriver) and lock nut

**GENERATOR CIRCUIT AND GENERATOR**

on battery terminal ( $\frac{1}{2}$ -in. socket wrench). Place locking wire through the two screws (side cutting pliers). Attach cover to terminal box and tighten wing nuts. Install locking wire through wing nuts and studs (side cutting pliers).

**g. Polarization.**

**WIRE**, jumper

After the regulator is connected to the generator and battery and before any runs are made, the generator should be polarized with the battery. Make a momentary connection with a jumper wire from the battery terminal to the generator "A" terminal.

**h. Final Tests and Adjustments.**

**AMMETER**

**HEADPHONE**, 2,000-ohm

**PLIERS**, side cutting

**RHEOSTAT**, carbon pile

(3-amp—50-ohm capacity)

**SCREWDRIVER**

**THERMOMETER**

**VOLTMETER**

**WRENCH**, open-end,  $\frac{7}{16}$ -in.

**WRENCH**, socket,  $\frac{1}{2}$ -in.

**CAUTION:** In making the final tests and adjustments, do not attempt to remove or replace regulator cover until power unit is shut down and master switch is open. To do so, may cause severe damage to the regulator due to possibility of shorting the regulator to a ground.

**(1) CIRCUIT BREAKER (fig. 226).**

**AMMETER**

**HEADPHONE**, 2,000-ohm

**PLIERS**, side cutting

**RHEOSTAT**, carbon pile

(3-amp—50-ohm capacity)

**SCREWDRIVER**

**VOLTMETER**

**WRENCH**, socket,  $\frac{1}{2}$ -in.

(a) Connect a reliable ammeter in series with the regulator "B" terminal and the lead removed from the "B" terminal ( $\frac{1}{2}$ -in. socket wrench). Connect a voltmeter from the regulator "A" terminal to the regulator ground screw (screwdriver and side cutting pliers). Disconnect the lead from the regulator "F" terminal and insert a carbon pile rheostat between the lead and the terminal (3-amp—50-ohm capacity).

(b) Operate the power unit at 1,000 revolutions per minute on the tachometer and insert all the resistance in the field circuit; then slowly reduce the resistance, noting the voltage just before the change caused by the closing of the circuit breaker. Increase the charging rate to 25 amperes and then reduce the charging rate by inserting resistance in the field circuit. Note the amperage discharge just before the circuit breaker opens and the reading drops to zero. The contacts should close between 25.7 and 26.7 volts and open between 15.0 and 20.0 amperes discharge after the charging rate of 25 amperes.



**ORDNANCE MAINTENANCE—POWER UNIT ACCESSORIES  
FOR MEDIUM TANKS M3A4 AND M4A4**

(c) An accurate method of checking the exact instant of opening and closing of the contacts is to connect a headphone (2,000-ohm or higher) between the "B" and "A" terminals of the regulator. When the contacts open or close a click will be heard in the headphone.

(d) To adjust the closing voltage, change the armature spring (fig. 228) tension by adjusting the thumb nut at the lower end of the spring. Increase the spring tension to raise the voltage and decrease the tension to lower the voltage. To adjust the opening amperage, raise or lower the stationary contact, keeping the contacts perfectly alined so that contact is made on both sets simultaneously. Do not adjust the gap to less than 0.025 inch.

(2) VOLTAGE REGULATOR (fig. 226).

AMMETER

HEADPHONE, 2,000-ohm

SCREWDRIVER

THERMOMETER

VOLTMETER

WRENCH, socket, 1/2-in.

(a) Connect an ammeter in series with the regulator "B" terminal and the lead removed from that terminal (1/2-in. socket wrench). Connect the voltmeter from the regulator "B" terminal to the regulator ground screw (screwdriver). Place a reliable thermometer about 2 inches from the regulator.

(b) Operate the power unit for 25 minutes at a speed that gives a generator output of 25 amperes on the test ammeter, to make sure that regulator is at normal operating temperature. If battery is near a full charge, it will be necessary to apply a load by turning on the various accessory circuits until the output, as read on the test ammeter, is 25 amperes. Have regulator cover on during this warm-up period. Stop the power unit; then start and bring the power unit speed up to 1,300 revolutions per minute on tachometer. Adjust the amperage to 25 on the test voltmeter. This reading should be within the limits tabulated below:

Temp.	F	50	60	70	80	90	100	110	120
Volts.	±.40	28.58	28.54	28.50	28.46	28.41	28.37	28.33	28.29

(c) In order to obtain an accurate indication of the operation of the voltage regulator unit, connect a headphone (2,000-ohm or higher) between "F" terminal and ground. Clicks should be regular and clear. If the tone is not clear and regular, inspect the contacts. They should be flat and not burned excessively and should make full face contact.

(d) To adjust the operating voltage, change the armature spring tension by turning the thumb nut on the lower end of the armature spring (fig. 228). Stop power unit while making adjustment; then restart and bring power unit speed up to 1,300 revolutions per minute on tachometer and adjust the amperage to 25 amperes before taking the voltage reading.

### GENERATOR CIRCUIT AND GENERATOR

(3) CURRENT REGULATOR (fig. 226).

AMMETER	VOLTMETER
HEADPHONE, 2,000-ohm	WRENCH, socket, 1/2-in.
SCREWDRIVER	

(a) Connect an ammeter in series with the regulator "B" terminal and the lead removed from that terminal (1/2-in. socket wrench). Connect the voltmeter from the regulator "B" terminal to the regulator ground screw (screwdriver).

(b) Crank the power unit for approximately 15 seconds with ignition switch "OFF;" then operate the power unit at 1,600 revolutions per minute on tachometer. Turn on lights and accessories so that the generator must charge at its maximum rate. The test ammeter must show between 50 and 53 amperes.

(c) In order to obtain an accurate indication of the operation of the current regulator unit, connect a headphone (2,000-ohm or higher) between the regulator "F" terminal and ground. Clicks should be clear and regular. If the tone is not clear and regular, inspect the contacts. They should be flat and not burned excessively and should align to make full face contact.

(d) To adjust the operating amperage, change the armature spring tension by turning the adjusting nut at the lower end of the armature spring (fig. 228). Stop the power unit and open master battery switch while adjusting; then restart and bring power unit speed up to 1,600 revolutions per minute on tachometer and take the ammeter reading. Replace cover after each adjustment.

(4) RECHECK.

Operate the power unit for 5 minutes with a 25-ampere output with cover in place and then repeat each check as described above to make sure all units are now operating correctly.

(5) INSTALL REGULATOR COVER AND TERMINAL BOX COVER.

PLIERS, side cutting	WRENCH, open-end, 7/16-in.
----------------------	----------------------------

(a) Check all screws to make sure they are lock wired before installing cover.

(b) Place cover on regulator after installing a new gasket and secure with two nuts and flat washers on the studs (7/16-in. open-end wrench).

(c) Install terminal box cover in place and tighten the two wing nuts with fingers. Install lock wire through wing nuts and studs (side cutting pliers).

### 117. VOLTMETER.

a. **Description.** The voltmeter is mounted in the instrument box and is connected so that it reads the voltage across the 24-volt battery

**ORDNANCE MAINTENANCE—POWER UNIT ACCESSORIES  
FOR MEDIUM TANKS M3A4 AND M4A4**

(fig. 213). It is protected by a 5-ampere circuit breaker mounted on the bus bar at the top of the instrument box. The voltmeter is of the thermo-static type and, therefore, must be connected for a short time before it reads correctly.

**b. Removal (with Cover Removed).**

**WRENCH**, open-end,  $\frac{3}{8}$ -in.

Disconnect wire from terminal post by holding wire near terminal with fingers and removing nut from post. Remove the two nuts and lock washers and withdraw unit through face of cover.

**c. Installation.**

**WRENCH**, open-end,  $\frac{3}{8}$ -in.

Insert unit through face of cover (from front of cover) and place clamp over each mounting stud on unit and secure with lock washer and nut on each stud. Connect the No. 16 green wire to terminal post (fig. 213) and secure with nut while holding wire near terminal to prevent turning of post.

**118. AMMETER.**

**a. Description.** The ammeter is mounted in the instrument box and is connected in the generator circuit (fig. 213) so that it indicates the charging or discharging of the battery, depending on the generator output and electric units in operation. It reads from minus 100 to plus 100 amperes.

**b. Removal (with Cover Removed).**

**WRENCH**, open-end,  $\frac{3}{8}$ -in.

Hold wires near terminal posts with fingers (to prevent turning of posts) and remove the two nuts which secure the two wires to terminal posts. Remove the two wires. Remove the nuts and lock washers which secure the mounting clamps and remove clamps. Withdraw unit from front of cover.

**c. Installation.**

**WRENCH**, open-end,  $\frac{3}{8}$ -in.

Insert unit through opening in cover (from face of cover) and place a clamp over each mounting stud on unit. Secure with lock washer and nut on each stud. Place No. 14 brown wire (fig. 213) on right-hand terminal. Place No. 14 white wire (fig. 213) on left-hand terminal. Secure with nut on each stud while holding wire near terminal to prevent turning of post. Do not allow terminals of wires to touch mounting studs or other instruments.

**CHAPTER 7**  
**ELECTRICAL SYSTEM (Cont'd)**

**Section V**

**POWER UNIT SENDING UNITS AND GAGES**

	Paragraph
General .....	119
Description .....	120
Removal and installation .....	121
Diagnosis and tests .....	122

**119. GENERAL.**

a. The gages and sending units covered in this section are those which pertain to the power unit only and indicate whether it is operating normally or not.

b. These units are as follows:

- (1) Oil pressure gage and sending unit.
- (2) Low oil pressure warning indicator light and sending unit.
- (3) Oil temperature gage and sending unit.
- (4) Water temperature gage and sending units.
- (5) High water temperature warning indicator light and sending unit.
- (6) Exhaust stack temperature warning indicator lights and sending units.
- (7) Fuel gage and fuel tank sending units.

c. For the sake of simplicity, the wiring diagram for the entire system has been divided into two wiring diagrams (figs. 230 and 231). Figure 230 covers the oil and water temperature gage circuits. Figure 231 covers the oil pressure gage and low oil pressure warning indicator light, fuel gage, and exhaust stack temperature warning indicator circuits.

d. The circuit for these units starts at the bus bar (it is assumed that the power unit can be started, which means that current is reaching the bus bar) and passes through the ignition switch and then to a 10-ampere instrument circuit breaker which is mounted separate from the bus bar in the instrument box. From the instrument circuit breaker the following five branches are fed:

- (1) Through a set of seven resistors to the five exhaust stack temperature warning indicator lights and to the high water temperature warning indicator light and low oil pressure warning indicator light.
- (2) To the oil temperature gage.
- (3) To the water temperature gage.
- (4) To the oil pressure gage.
- (5) To the fuel gage.

**ORDNANCE MAINTENANCE—POWER UNIT ACCESSORIES  
FOR MEDIUM TANKS M3A4 AND M4A4**

e. These five branches, in turn, continue to the appropriate sending unit in the power unit or fuel tanks.

f. The transmission oil temperature circuit is shown in the wiring diagram (fig. 230) because of its connection and use of the same oil temperature gage in the instrument box, but no further discussion of it will be given in this manual since it does not pertain directly to the power unit.

**120. DESCRIPTION.**

a. **Resistors.** The seven resistors of 120 ohms each, are mounted in the instrument box and are designed to permit the use of six-volt lamp bulbs in the 24-volt circuit.

b. **Instrument Circuit Breaker.** The ten-ampere circuit breaker is mounted in the instrument box and connected to the ignition switch but is not attached to the bus bar. The current used, therefore, in the five branches leading from it, is not available unless the ignition switch is turned on. The instrument circuit breaker can be closed by pushing the "reset" button which is on the face of the instrument box.

**c. Exhaust Stack Temperature Warning Indicator Lights and Sending Units.**

(1) The warning indicator lights are mounted in a horizontal row in the center and upper half of the instrument box. They are six-volt, one-candlepower bulbs with a miniature base.

(2) The sending units are located on each engine on the top of the exhaust manifold, toward the radiator end of the power unit.

(3) When the power unit is cold and the ignition switch is turned on, the five indicator lights should burn. When the temperature of each engine at the exhaust manifold reaches 320 F, the light for that engine will cease to burn. If the temperature drops below 250 F, the light will again burn, indicating that that engine is not operating properly.

**d. Water Temperature Gage, Selector Switch, High Water Temperature Warning Indicator Light and Sending Units.**

(1) The high water temperature warning indicator light is mounted above the water temperature gage and to the right of the selector switch. It is the same as the exhaust stack temperature warning indicator lights. The water temperature gage is mounted just to the left and below the center line of the instrument box. It is calibrated to read from 100 to 260 F. The selector switch is mounted to the left of the temperature gage. It is a six-position switch, marked with numerals one to five and "TEST."

(2) The high water temperature warning indicator sending unit is

## POWER UNIT SENDING UNITS AND GAGES

located in the top of the cylinder head adapter. On multiple water pump power units, one is provided for each engine. On the single water pump power units, one is provided for the No. 1 engine only. The water temperature sending units are located on the right side of each cylinder head, at the radiator end. One is provided for each engine.

(3) With the power unit in operation, the indicator light will not burn unless the water temperature rises above 230 to 240 F, and ceases to burn when the temperature drops to 215 F. The temperature of each engine can be checked by using the selector switch and noting the gage reading as each point on the selector switch is connected. If the warning indicator light is not burning, its operation can be checked by turning the selector switch to the position marked "TEST." If the light burns, the warning indicator light is in operating condition.

### e. Oil Pressure Gage, Low Oil Pressure Warning Indicator Light, Oil Temperature Gage, Oil Temperature Gage Selector Switch, and Sending Units.

(1) The oil pressure gage is mounted to the right of the water temperature gage. It is calibrated to read from 0 to 80 pounds pressure. The low oil pressure warning indicator light is mounted above the oil pressure gage and is the same construction as the high water temperature and exhaust stack temperature warning indicator lights. The oil temperature gage is located in the lower left-hand corner of the instrument box and is calibrated to read from 100 to 325 F. The selector switch is mounted above the temperature gage.

(2) The oil pressure gage sending unit is located on the underneath side of No. 4 engine, on multiple water pump type power units and on the upper side of the No. 3 engine, in the oil gallery, on single water pump type power units. The low oil pressure warning indicator sending unit is located on the lower side of the No. 4 engine, on multiple water pump type power units and on the right side of the No. 1 engine, at the radiator end, on single water pump type power units. The oil temperature sending unit is located in a T-connector at the lower left side of the crankcase.

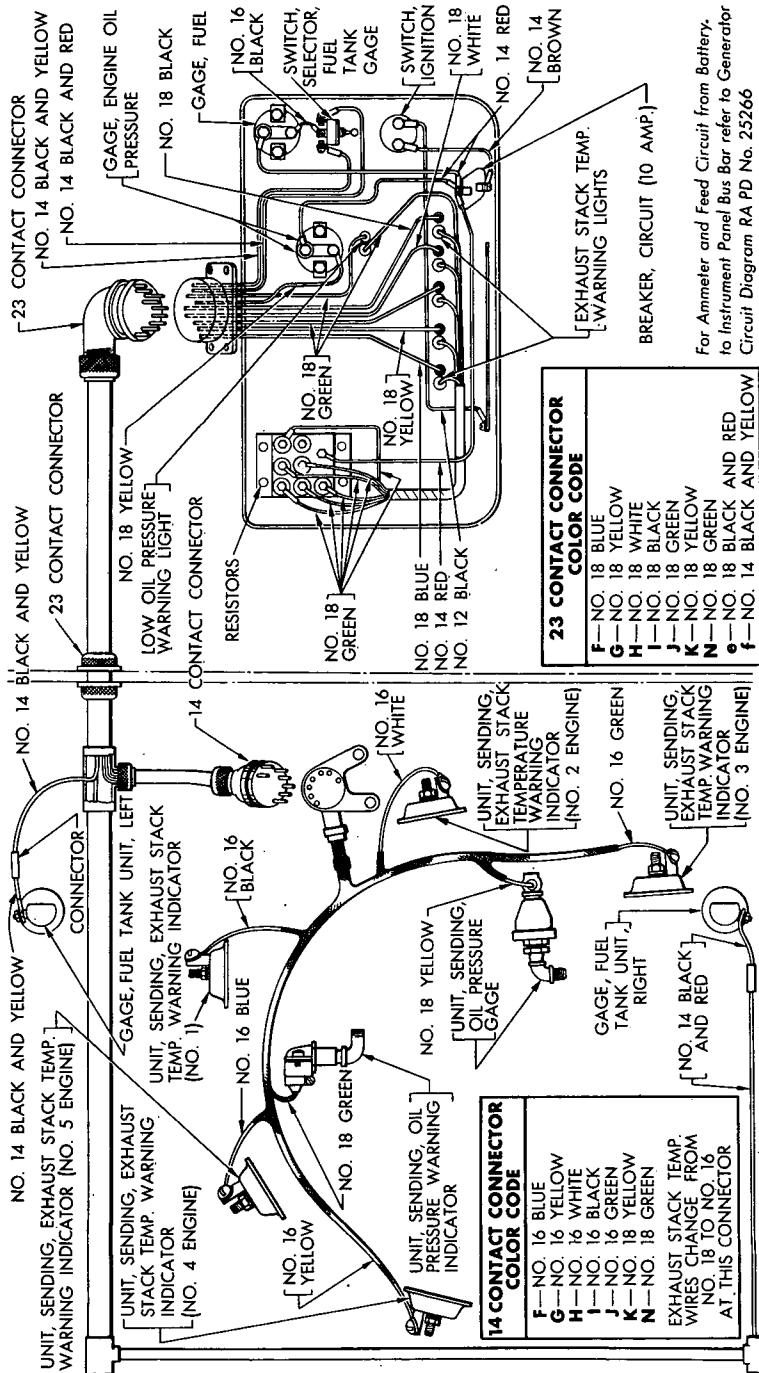
(3) With the power unit operating, the low oil pressure warning indicator light will not burn unless the oil pressure drops below 9 to 13 pounds pressure. The oil temperature may be read by moving the selector switch to the side marked "ENG."

### f. Fuel Gage and Sending Units.

(1) The fuel gage is mounted on the lower right-hand corner of the instrument box and is calibrated to read from "E" (empty) to "F" (full). The selector switch is mounted above the fuel gage and has two positions, right and left, which connect the gage to the respective fuel tank.



POWER UNIT SENDING UNITS AND GAGES



For Ammeter and Feed Circuit from Battery,  
to Instrument Panel Bus Bar refer to Generator  
Circuit Diagram RA PD No. 25266

RA PD 25265

Figure 231—Exhaust Stack Temperature and Oil Pressure  
Sending Unit Circuit



**ORDNANCE MAINTENANCE—POWER UNIT ACCESSORIES  
FOR MEDIUM TANKS M3A4 AND M4A4**

(2) The fuel gage sending units are mounted on the top and toward the front of the right-and left-hand fuel tanks.

**121. REMOVAL AND INSTALLATION.**

a. The removal and installation of all sending units and gages are covered in TM 9-754 and will not be repeated in this manual. Refer to the above mentioned manual for any operations that are found necessary due to the following "Diagnosis and Tests."

**122. DIAGNOSIS AND TESTS.**

LAMP, test

WIRE, jumper

a. Before starting the test procedure as outlined below, the two wiring diagrams (figs. 230 and 231) should be thoroughly studied to assist in understanding each circuit and why each step is taken.

**b. All Gages and Warning Indicator Lights Fail to Operate.**

(1) If, with the ignition switch "ON," all gages and warning indicator lights fail to operate, press instrument circuit breaker to make sure it is closed. If instrument circuit breaker clicks open there is a ground in one of the gage circuits or in the circuit breaker (refer to test described in step (3) below). If instrument circuit breaker remains closed and gages and indicator lights fail to operate, there is an open circuit between the bus bar and the instrument circuit breaker (refer to test described in step (2) below).

(2) Crank the power unit. If power unit does not fire, refer to ignition section in TM 9-1750F. If power unit fires, the circuit to the ignition switch is operating. Touch one lead of test lamp to ground and touch the other test lamp lead to the following points in order listed:

*(a) Terminal on Instrument Circuit Breaker to Which the Five Wires Are Attached.*

If lamp burns, there is no open circuit. If lamp does not burn, proceed to substep (b).

*(b) Terminal on Instrument Circuit Breaker to Which No. 14 Brown Wire Attaches (fig. 230).*

If lamp burns, open circuit is in instrument circuit breaker. If lamp does not burn, open circuit is between instrument circuit breaker and ignition switch in No. 14 brown wire (fig. 230).

(3) If the instrument circuit breaker opens when reset, disconnect all five branch circuits from the instrument circuit breaker. Reset the instrument circuit breaker and then connect each branch separately (figs. 230 and 231). When the grounded circuit is connected, the instrument circuit breaker will again click open. Only grounds in the resistors,

**POWER UNIT SENDING UNITS AND GAGES**

feed wire to the resistor, gages or feed wires to the gages will cause the instrument circuit breaker to open. These are the only parts that need to be checked. Trouble in the sending units or wiring to the warning indicator lights and gages will affect only the particular circuit in which it is located (refer to tests described in subparagraphs c and d below).

**c. Faulty Operation of Warning Indicator Lights.**

(1) The operation of each of the warning indicator lights should be thoroughly understood (par. 120) in order to interpret their actions correctly.

(2) The testing is broken down into two tests which apply to all the warning indicator lights. Steps (3), (4), and (5) below, indicate which test to make, depending on the unit being checked, and the particular trouble encountered.

**(3) LOW OIL PRESSURE WARNING INDICATOR LIGHT TROUBLE.**

(a) If light does not burn when ignition switch is turned on, see test described in step (6) below.

(b) If light burns when oil pressure is above 13 pounds, see test described in step (7) below. NOTE: If light burns and oil pressure is below nine pounds with power unit operating, stop power unit and check lubricating system (par. 34).

(c) If light operates normally except that it does not go out until oil pressure is above 13 pounds, the calibration of the sending unit is faulty. Replace sending unit.

**(4) EXHAUST STACK TEMPERATURE WARNING INDICATOR LIGHT TROUBLE.**

(a) If any of the warning indicator lights do not burn when first starting a cold power unit, see test described in step (6) below.

(b) If any of the indicator lights burn after power unit is thoroughly warmed up and operating on all five engines, see test described in step (7) below.

(c) If any of the indicator lights burn continuously after power unit is warm and power unit operation is rough, refer to TM 9-1750F (pars. 12 and 13).

**(5) HIGH WATER TEMPERATURE WARNING INDICATOR LIGHT TROUBLE.**

(a) As this light does not operate under normal conditions, a test position has been provided on the water temperature selector switch which grounds the bulb and if it is not burned out the bulb will burn. If bulb does not burn, replace bulb. If bulb still does not burn, see test described in step (6) below.

(b) If indicator light starts to burn and water temperature of all

**ORDNANCE MAINTENANCE—POWER UNIT ACCESSORIES  
FOR MEDIUM TANKS M3A4 AND M4A4**

five engines checks somewhat below 230 F, the calibration of the sending unit is faulty. Replace sending unit.

(c) If indicator light burns continuously regardless of the water temperature, see test described in step (7) below.

**(6) CHECK FOR OPEN CIRCUIT IF WARNING INDICATOR LIGHT DOES NOT BURN (WITH IGNITION SWITCH TURNED "ON").**

(a) Touch jumper wire to ground and terminal on bulb socket. If bulb burns, trouble is between warning indicator light and sending unit, see test described in substep (b) below. If bulb does not burn, replace bulb. If bulb still does not burn, touch one lead of test lamp to ground and touch other lead of test lamp to the following points in order listed:

1. *Terminal on Resistor Block Which Connects to Warning Indicator Light Being Checked.*

If test lamp burns, open circuit is in wire from this terminal to warning indicator light. If test lamp does not burn, proceed as follows:

2. *Terminal on Resistor to Which Wire from Instrument Circuit Breaker Is Attached (No. 14 Red).*

If test lamp burns, open circuit is in resistor. If test lamp does not burn, open circuit is in No. 14 red wire between resistor block and instrument circuit breaker.

(b) If open circuit is between warning indicator light and sending unit, ground one end of jumper wire and connect other end of jumper wire to the following points in the order listed:

1. *Terminal on Sending Unit.*

If warning indicator light burns, fault is in the sending unit. If warning indicator light does not burn, proceed as follows:

2. *Contact Plug in 14 Contact Connector Located on Power Unit (See Wiring Diagrams for Color Code and Contact Letter of Circuit Being Checked).*

If warning indicator light burns, fault is in wire from sending unit to socket of 14 contact connector. If warning indicator light does not burn, proceed as follows:

3. Contact socket in 23 contact connector located in back of instrument box. If warning indicator light burns, fault is in wiring between the two contact connectors. If warning indicator light does not burn, fault is between socket in 23 contact connector and warning indicator light. **NOTE:** If fault is between the two contact connectors checked, a third connector at the bulkhead can be checked to limit further the area of trouble.

**(7) CHECK FOR GROUNDS IF WARNING INDICATOR LIGHT BURNS CONTINUOUSLY (WITH IGNITION SWITCH TURNED "ON").**

**POWER UNIT SENDING UNITS AND GAGES**

(a) Break connections at the following points in order listed:

1. *At Sending Unit.*

If warning indicator light ceases to burn, fault is in the sending unit (figs. 230 and 231). If warning indicator light still burns, proceed as follows:

2. *14 Contact Connector on Power Unit.*

If warning indicator light ceases to burn, fault is between contact connector and sending unit (figs. 230 and 231). If warning indicator light still burns, proceed as follows:

3. *23 Contact Connector at Instrument Box.*

If warning indicator light ceases to burn, fault is between 23 contact connector and 14 contact connector (figs. 230 and 231). If warning indicator light still burns, fault is between 23 contact connector and warning indicator light. **NOTE:** If fault is between the 14 contact connector and 23 contact connector on instrument box, a third connector, at the bulkhead, can be used to further limit the area of trouble.

**d. Faulty Operation of Instrument Box Gages.**

(1) Abnormal indications and methods for checking are the same on all gages. If a gage reads "ZERO" with the ignition switch turned "ON," there is an open circuit between the sending unit and the gage. To check for an open circuit, ground one end of jumper wire and touch the connection in the order listed as given below for that particular gage. If a gage reads at the extreme high end of the scale, with the ignition switch turned "ON," there is a ground in the circuit between the sending unit and the gage. To check for a ground, break connections at the points listed, which are given for that particular gage. The same points apply whether the fault is a ground or an open circuit. In checking for an open circuit, when the jumper wire is touched to a point which caused the gage to read at the extreme high end, open circuit will be found between that point and point previously checked. In either check, if indication is at the first point, which is the sending unit terminal, trouble is in the sending unit.

(2) **INCORRECT CALIBRATION.**

If gage pointer operates but does not appear to be indicating correctly, the calibration of gage or sending unit is incorrect. Substitute, temporarily, a gage unit which is known to be correct. If indication is still incorrect, trouble is in sending unit and sending unit must be replaced. If indication is correct, fault is in the gage and a new gage must be installed.

(3) **"CHECK POINTS" FOR ENGINE OIL TEMPERATURE GAGE AND CIRCUIT.**

(a) Terminal on sending unit (fig. 230).

**ORDNANCE MAINTENANCE—POWER UNIT ACCESSORIES  
FOR MEDIUM TANKS M3A4 AND M4A4**

(b) Contact plug in 14 contact connector on power unit (fig. 230).

(c) Contact socket in 23 contact connector at instrument box (fig. 230). NOTE: If trouble is between (b) and (c), a further check may be made at the contact connector, in the bulkhead, to limit further the field of trouble.

(d) Terminal of selector switch to which the No. 18 white wire attaches (fig. 230).

(e) Center terminal of selector switch to which No. 16 green wire attaches (fig. 230).

(f) Terminal on gage which connects to selector switch to which No. 16 green wire attaches.

**(4) "CHECK POINTS" FOR ENGINE WATER TEMPERATURE GAGE AND CIRCUITS (WITH SELECTOR SWITCH SET TO POSITION CORRESPONDING TO CIRCUIT AT FAULT).**

(a) Terminal on sending unit (fig. 230).

(b) Contact plug in 14 contact connector on power unit (fig. 230).

(c) Contact socket in 23 contact connector at instrument box (fig. 230). NOTE: If trouble is between (b) and (c), a further check may be made at the contact connector, in the bulkhead, to limit further the field of trouble.

(d) Terminal on selector switch which connects to circuit at fault (fig. 230).

(e) Terminal on selector switch marked "G" which connects to gage (fig. 230).

(f) Terminal on water temperature gage which connects to selector switch (fig. 230).

**(5) "CHECK POINTS" FOR ENGINE OIL PRESSURE GAGE AND CIRCUIT.**

(a) Terminal on sending unit (fig. 231).

(b) Contact plug in 14 contact connector on power unit (fig. 231).

(c) Contact socket in 23 contact connector at instrument box (fig. 231). NOTE: If trouble is between (b) and (c), a further check may be made at the contact connector, in the bulkhead, to limit further the field of trouble.

(d) Terminal of oil pressure gage to which No. 18 yellow wire is attached (fig. 231).

**(6) "CHECK POINTS" FOR FUEL GAGE AND CIRCUITS.**

(a) Terminal of fuel gage at fuel tank (depending on whether right or left fuel tank circuit is being checked) (fig. 231).

(b) Contact socket in 23 contact connector at instrument box (fig. 231), which connects to the fuel tank circuit being checked. NOTE: If trouble is between (a) and (b), a further check may be made at the contact connector, at the bulkhead, to limit further the field of trouble.

**POWER UNIT SENDING UNITS AND GAGES**

(c) Selector switch terminal which connects to the fuel tank circuit being checked (fig. 231).

(d) Center terminal of selector switch which connects to fuel gage (No. 16 black wire) (fig. 231).

(e) Terminal of fuel gage which connects to selector gage (No. 16 black wire) (fig. 231). **NOTE:** Be sure selector switch is in proper position for the fuel tank circuit being checked.

**(7) IF GAGE READS AT HIGH END OF SCALE AND NO GROUND CAN BE FOUND.**

The gage is not properly grounded to instrument box. Loosen gage mounting brackets and scrape the paint off of instrument box where gage makes contact.

**(8) CROSSED CIRCUITS.**

If the wiring becomes crossed, start at the gage unit and check color of wires at each connection. Follow color code in figure 230 or 231.

**ORDNANCE MAINTENANCE—POWER UNIT ACCESSORIES  
FOR MEDIUM TANKS M3A4 AND M4A4**

**CHAPTER 8**

**REFERENCES**

	Paragraph
Standard nomenclature lists .....	123
Explanatory publications .....	124

**123. STANDARD NOMENCLATURE LISTS.**

**a. Ammunition.**

- Ammunition, fixed and semifixed, all types, for pack, light and medium field artillery including complete round data ..... SNL R-1
- Ammunition, revolver, automatic pistol, and sub-machine guns ..... SNL T-2
- Ammunition, rifle, carbine, and automatic gun .. SNL T-1

**b. Armament.**

- Gun, machine, cal. .30, Browning, M1919A4, fixed and flexible ..... SNL A-6
- Gun, machine, cal. .30, Browning, M1919A5, fixed .. SNL A-6
- Gun, machine, cal. .50, Browning, M2, heavy barrel, fixed and flexible ..... SNL A-39
- Gun, submachine, cal. .45, Thompson, M1 ..... SNL A-32
- Gun, submachine, cal. .45, Thompson, M1928A1 .. SNL A-32
- Gun, 75-mm, M2 (tank) ..... SNL C-34
- Gun, 75-mm, M3 ..... SNL C-34
- Mount, gun, 75-mm, M1 (tank) ..... SNL C-34

**c. Maintenance.**

- Cleaning, preserving and lubricating materials; recoil fluids, special oils, and miscellaneous related items ..... SNL K-1
- Soldering, brazing and welding material, gases and related items ..... SNL K-2
- Tank, medium, M4A4 ..... SNL G-104  
Vol. IX
- Tools, maintenance, for repair of automatic guns, automatic gun antiaircraft materiel, automatic and semiautomatic cannon, and mortars ..... SNL A-35
- Truck, small arms repair, M1 ..... SNL G-72

Current Standard Nomenclature Lists are as tabulated here. An up-to-date list of SNL's is maintained as the "Ordnance Publications for Supply Index" ..... OPSI

REFERENCES

124. EXPLANATORY PUBLICATIONS.

a. Ammunition.

Ammunition, general .....	TM 9-1900
Grenades .....	FM 23-30
Small arms ammunition .....	OFSB 3-5

b. Armament.

Browning machine gun, cal. .30, HB, M1919A4 (mounted in combat vehicles) .....	FM 23-50
Browning machine gun, cal. .50, HB, M2 (mounted in combat vehicles) .....	FM 23-65
Grenades .....	FM 23-30
Instruction guide; small arms data .....	TM 9-2200
Thompson submachine gun, cal. .45, M1928A1 .....	FM 23-40
75-mm gun materiel, M2 and M3 (tank) .....	TM 9-307

c. Communications.

Radio fundamentals .....	TM 11-455
Radio sets, SCR-508, SCR-528 and SCR-538 .....	TM 11-600
The radio operator .....	TM 11-454

d. Maintenance.

Automotive brakes .....	TM 10-565
Automotive lubrication .....	TM 10-540
Automotive power transmission units .....	TM 10-585
Chassis, body, and trailer units .....	TM 10-560
Cleaning, preserving, lubricating, and welding materials and similar items issued by the Ordnance Department .....	TM 9-850
Defense against chemical attack .....	FM 21-40
Detailed lubrication instructions for ordnance materiel .....	OFSB 6-series
Echelon system of maintenance .....	TM 10-525
Fire prevention, safety precautions, accidents .....	TM 10-360
Medium tank M4A4 .....	TM 9-754
Motor transport inspections .....	TM 10-545
Ordnance maintenance: Power unit for medium tanks M3A4 and M4A4 .....	TM 9-1750F
Ordnance maintenance: Stabilizers, all types .....	TM 9-1798
Sheet metal work, body, fender, and radiator repairs .....	TM 10-450
The motor vehicle .....	TM 10-510



**ORDNANCE MAINTENANCE—POWER UNIT ACCESSORIES  
FOR MEDIUM TANKS M3A4 AND M4A4**

**e. Miscellaneous.**

Automotive electricity . . . . .	TM 10-580
Camouflage . . . . .	FM 5-20
Electrical fundamentals . . . . .	TM 1-455
Fuels and carburetion . . . . .	TM 10-550
List of publications for training . . . . .	FM 21-6
Military motor transportation . . . . .	TM 10-505
Military motor vehicles . . . . .	AR 850-15
Motor transport . . . . .	FM 25-10
The internal combustion engine . . . . .	TM 10-570

**f. Storage and Shipment.**

Rules governing the loading of mechanized and motorized Army equipment, also, major caliber guns for the United States Army and Navy, on open top equipment—Published by the Operations and Maintenance Department of Association of American Railroads.

Storage of motor vehicle equipment . . . . .	AR 850-18
--	-----------

INDEX

<b>A</b>	Page No.		Page No.
Adjustments:		power unit lubricating system	
clutch pressure spring retainer		absorption type lubricating oil	
bolts	247-248	filters	133
clutch release lever	271-272	full flow oil strainer	144-146
generator	341	lubricating oil supply tank	150
generator regulator	346-350	pressure oil pump	115-120
governor	42-44	scavenger oil pump	129-132
starter motor	305	Automatic fuel shut-off valve	
Air cleaners		assembly	94-95
removal	149	cleaning and inspection	94
trouble shooting	19	data and specifications	16
(See also Carburetor air cleaners)		description	88-90
Air vent hose, installation	151	disassembly	90-94
Alinement:		installation	95
flywheel ring and pressure plate	247	trouble shooting	18-19
oilholes	62-63		
release lever holes	243	<b>B</b>	
Ammeter		Battery, checking specific gravity	284
description, removal and installation	358	Battery switch (See Master battery switch)	
diagnosis and tests	314-316	Bearing retainer	
Ammunition boxes and racks, maintenance duties by echelons	5	installation	170-171, 194
Armature		removal	180
inspection	292-293	Bendix assembly, removal from drive shaft	291
installation on generator frame	337	Bendix drive, inspection	301
removal	292	Bottom cover plate, installation	354
from drive end head	328	Bypass type thermostat	
Assembly:		description	204
clutch		operation	207
model M3A4	267-272	<b>C</b>	
model M4A4	241-254	Capacity of fuel tanks	95-99
cooling system		Carburetor	
radiator	201-202	assembly	38-41
single water pump type power unit	185-196	carburetor air cleaners	44-46
electrical system		cleaning and inspection	38
generator	337-341	data and specifications	13-15
starter motor	301-305	description	24-32
subbase, base, and bottom cover plate	354	disassembly	32-37
fuel system		governor	41-44
automatic fuel shut-off valve	94-95	installation	41
carburetor	38-41	removal	32
fuel filter	88	trouble shooting	17
fuel pump	57-63	Carburetor air cleaners	
fuel pump adapter assembly	79-83	cleaning	46
fuel pump drive	68-74	description	44
		installation	46
		removal	44
		Carburetor air horn, removal	32-33

**ORDNANCE MAINTENANCE—POWER UNIT ACCESSORIES  
FOR MEDIUM TANKS M3A4 AND M4A4**

<b>C—Cont'd</b>	<b>Page No.</b>		<b>Page No.</b>
Carburetor needle and seat		data and specifications	257-260
installation	39	description	257
removal	33	disassembly	262-264
Carburetor pump piston and plunger		fits and tolerances	273-274
assembly	40-41	inspection	265-266
disassembly	33	second echelon operation	260
Cautions:		trouble shooting	261
aligning holes in flywheel ring and		model M4A4	
plate	247	assembly	241-254
altering clutch pedal rod	219	data and specifications	219-225
generator and drive pulley alignment	342	description	218-219
governor adjustment	44	disassembly	232-238
leaks in main vent tube assembly	26-28	fits and tolerances	255-256
mounting armature	329	inspection	239-240
unplugging armature	19	installation	254
Centrifugal type water pump	173-179	second echelon operation	229
Choke circuit, description	30-32	trouble shooting	230-231
Choke type thermostat		Clutch assembly, data and specifications	257-260
description	204	Clutch center plate, inspection	265-266
operation	207	Clutch controls	219-225, 260
Choke valve		Clutch pressure plate and spring	
installation	40	housing	
removal and disassembly	33	assembly	267-271
Circuit breaker (unit)		disassembly	262-264
replacement	350-352	Clutch pressure plate spring carrier	
test and adjustment	255-256	assembly	241-242
Cleaning:		installation on clutch flywheel	
clutch parts		ring	242
model M3A4	265	Clutch pressure spring retainer bolts,	
model M4A4	239	adjustment	247-248
cooling system		Clutch release arm	
radiator parts	200	installation	269
single water pump type power unit	182	removal	263
electrical system		Clutch release lever	
commutator end head and brush		adjustment	271-272
holder plate	295	removal	233-235
intermediate housing	300	Clutch release lever height, adjustment	250-251
solenoid switch	308	Clutch release lever spring	
starter frame and fields	295	installation	251
fuel system		removal	232
automatic fuel shut-off valve	94	Clutch release sleeve	
carburetor	38	fits and tolerances	256
carburetor air cleaner	46	installation	246-247
fuel filter	86-88	Clutch spindle front bearing	
lubricating fittings	165	lubrication	268
Clutch		removal	232, 263
differences among models	4	Clutch spindle oil slinger	
model M3A4		installation	253-254
assembly	267-272	removal	237

INDEX

<b>C—Cont'd</b>	<b>Page No.</b>		<b>Page No.</b>
Clutch spindle rear bearing		instrument box starter (push	
installation . . . . .	253	button) switch . . . . .	310
lubrication . . . . .	269-270	master battery switch . . . . .	309
Clutch spring housing, inspection . .	265	power unit sending units and	
Commutator end head		gages . . . . .	360-364
inspection and repair . . . . .	295-299, 332-335	starter circuit . . . . .	280
installation on generator frame . .	337	starter motor . . . . .	287
removal . . . . .	292	starter solenoid switch . . . . .	306-307
Contact pressure tests . . . . .	348	voltmeter . . . . .	357-358
Cooling system		fuel system	
data and specifications . . . . .	154-155	automatic fuel shut-off valve . . .	88-90
description . . . . .	154	carburetor	
differences among models . . . . .	3	choke circuit . . . . .	30-32
fits and tolerances . . . . .	216-217	float circuit . . . . .	24
trouble shooting . . . . .	156-157	high speed circuit . . . . .	26-28
Current regulator (unit)		idling circuit . . . . .	24-26
replacement . . . . .	352-353	pump circuit . . . . .	28-30
test and adjustment . . . . .	357	carburetor air cleaners . . . . .	44
		fuel filter . . . . .	84
		fuel pump . . . . .	47
		fuel tanks . . . . .	95-99
		governor . . . . .	41-42
		power unit lubricating system	
		absorption type lubricating oil	
		filters . . . . .	133
		full flow oil strainer . . . . .	133
		pressure oil pump . . . . .	114
		scavenger oil pump . . . . .	121-123
		Diagnosis and tests	
		generator and generator cir-	
		cuit . . . . .	314-320
		power unit sending units and	
		gages . . . . .	364-369
		Differences among models . . . . .	3-4
		Disassembly:	
		clutch	
		model M3A4 . . . . .	262-264
		model M4A4 . . . . .	218-219
		clutch pressure plate and fly-	
		wheel ring . . . . .	232-238
		removal from vehicle . . . . .	232
		cooling system	
		multiple water pump type	
		power unit . . . . .	162-164
		radiator . . . . .	197-200
		single water pump type power	
		unit . . . . .	179-181
		electrical system	
		ammeter . . . . .	358
		generator . . . . .	320
		generator circuit . . . . .	312
		generator regulator . . . . .	343
		generator . . . . .	326-328
		starter motor . . . . .	291-292

**ORDNANCE MAINTENANCE—POWER UNIT ACCESSORIES  
FOR MEDIUM TANKS M3A4 AND M4A4**

<b>D—Cont'd</b>	<b>Page No.</b>	<b>Page No.</b>
Disassembly—Cont'd		Filterette
fuel system		description and location..... 343
automatic fuel shut-off valve. 90-94		replacement..... 353-354
carburetor..... 32-37		Final drive, maintenance duties by
fuel pump..... 49-56		echelons..... 5
fuel pump adapter assembly 75-78		Final reduction, maintenance duties
fuel pump drive..... 65-68		by echelons..... 6
power unit lubricating system		Fire extinguishing system, maintenance duties by echelons..... 10
full flow oil strainer..... 136-144		Fits and tolerances
lubricating oil filters, absorption type..... 133		clutch
lubricating oil supply tank..... 150		model M3A4..... 273-274
pressure oil pump..... 114-115		model M4A4..... 255-256
scavenger oil pump..... 123-127		cooling system..... 216-217
Discharge and intake check balls		Float
installation..... 38-39		installation..... 40
removal..... 37		removal..... 33
Disengaging clutch..... 219		Float circuit, description..... 24
Dragging clutch		Flooded carburetor, trouble shooting 17
model M3A4..... 261		Flywheel
model M4A4..... 230		fits and tolerances..... 256
Drive end head and bearing, inspection and repair..... 335-337		inspection..... 240
Drive pulley, installation on generator..... 340		outside diameter..... 219, 257
Drive shaft and gear		Flywheel hub, fits and tolerances... 255
inspection..... 300-301		Flywheel ring
installation to bendix drive..... 303		fits and tolerances..... 256
Drive shaft intermediate bearing assembly, inspection..... 300		inspection..... 239
Driving plate, inspection..... 240		Fuel filter
		assembly..... 88
<b>E</b>		cleaning..... 86-88
Echelons, definition of..... 4		data and specifications..... 16
Electrical system		description..... 84
data and specifications..... 275-276		inspection..... 86-88
description..... 275		removal..... 84-86
differences among models..... 4		trouble shooting..... 18
general discussion of..... 275		Fuel filter element, removal..... 33-37
maintenance duties by echelons... 7-8		Fuel filter head
Engine, maintenance duties by echelons..... 8-9		assembly..... 88
		disassembly..... 84-86
<b>F</b>		Fuel gage, location and description..... 361-364
Fan, removal and installation..... 213		Fuel pump
Fan and fan ring gear, inspection... 240		assembly..... 57-63
Field coil draw..... 341		data and specifications..... 15
Field coil terminal post and leads, installation..... 338		description..... 47
Filter head and element assembly		disassembly..... 49-56
assembly..... 145		fuel pump drive (See Fuel pump drive)
removal..... 136		inspection..... 56-57
		installation..... 64
		removal..... 47
		trouble shooting..... 18

INDEX

<b>F—Cont'd</b>		<b>Page No.</b>	<b>G</b>		<b>Page No.</b>
Fuel pump adapter assembly			Generator		
assembly	79-83		assembly	337-341	
disassembly	75-78		data and specifications	276	
Fuel pump drive			description	320-321	
assembly	68-74		disassembly	326-328	
disassembly	65-68		inspection and repair	326-328	
inspection	68		installation		
installation	74-75		multiple water pump type		
removal	65		power unit	341-342	
Fuel pump drive end bearing, in-			single water pump type power		
stallation	62-63		unit	343	
Fuel pump drive gear, installation.	81-83		polarizing	343	
Fuel pump drive shaft (bearing oil			removal		
seal)			multiple water pump type		
assembly	60-61		power unit	321-326	
installation	62, 71		single water pump type power		
removal	49, 65-68		unit	326	
Fuel pump drive shaft key			tests and adjustments	341	
installation	74		Generator and bracket, removal from		
removal	65		power unit	321-326	
Fuel pump relief valve spring, re-			Generator circuit		
moval	49		ammeter	358	
Fuel pump rotor, removal	49		description	312	
Fuel pump rotor shaft bearing, in-			diagnosis and tests	314-320	
stallation	58-59		generator regulator	343-357	
Fuel system			operation	312-314	
data and specifications	13-16		trouble shooting	316-318	
description	13		voltmeter	357-358	
differences among models	3		Generator commutator end head,		
maintenance duties by echelons	10		removal	328	
second echelon operations	16		Generator frame and field coils, in-		
trouble shooting			spection and repair	332	
air cleaners	19		Generator regulator		
automatic fuel shut-off valve	18-19		assembly of subbase, base, and		
carburetor	17		bottom cover plate	354	
fuel filter	18		description	343	
fuel pump	18		installation	354-355	
fuel tank cap	19		polarization	355	
Fuel tanks			removal	343-346	
data and specifications	16		tests and adjustments	346-350	
description	95-99		final	355-357	
removal and installation	99		unit replacement procedure	350-354	
Full flow oil strainer			Governor		
assembly	144-146		adjustment	42-44	
description	133		description and functioning	41-42	
disassembly	136-144				
inspection	144		<b>H</b>		
removal	133-136		Head band and terminal shielding		
Function of pressure vent valve	202		box, installation	305	
			Heat shield and mounting bracket,		
			removal	326	







**ORDNANCE MAINTENANCE—POWER UNIT ACCESSORIES  
FOR MEDIUM TANKS M3A4 AND M4A4**

<b>P—Cont'd</b>		<b>Page No.</b>			<b>Page No.</b>
Pressure plate			fits and tolerances	.....	216
model M3A4			generator		
fits and tolerances	.....	273	installation	.....	343
inspection	.....	265	removal	.....	326
model M4A4			inspection and repair	.....	182-185
fits and tolerances	.....	255	installation	.....	196
inspection	.....	239	removal	.....	179
Pressure spring carrier, inspection	.....	239	Slipping clutch		
Pressure vent valve			model M3A4	.....	261
data and specifications	.....	155	model M4A4	.....	230-231
operation	.....	202	Solenoid switch (See Starter solenoid switch)		
removal	.....	200	Specific gravity, checking in battery		284
Pump circuit, description	.....	28-30	Specifications (See Data and specifications)		
<b>R</b>					
Radiator			Spindle		
assembly	.....	201-202	fits and tolerances		
disassembly	.....	197-200	model M3A4	.....	273
general discussion of	.....	197	model M4A4	.....	255
inspection and repair	.....	200-201	inspection (model M4A4)	.....	240
removal	.....	197	Starter circuit and starter motor		
Rebuild defined	.....	5	diagnosis and test	.....	280-287
Release arm assembly, fits and tolerances	.....	274	instrument box starter (push button) switch	.....	310-311
Relief valve assembly			master battery switch	.....	309-310
assembly	.....	144-145	starter motor (See Starter motor)		
disassembly	.....	144	starter solenoid switch (See Starter solenoid switch)		
Repair defined	.....	5	Starter frame and fields, cleaning	.....	295
Resistors, description	.....	360	Starter motor		
Retainer washer lock ring, installation	.....	187-188	assembly	.....	301-305
<b>S</b>					
Seal retainer washer, installation	.....	169-170	data and specifications	.....	275-276
Second echelon operations			description	.....	287
clutch			disassembly	.....	291-292
model M3A4	.....	260	inspection and repair	.....	292-301
model M4A4	.....	229	installation on power unit	.....	306
electrical system	.....	276	operation	.....	287
fuel system	.....	16	removal	.....	287-291
power unit lubricating system	.....	111	tests and adjustments	.....	305-306
Selector switch, description	.....	360-361	Starter motor pinion housing, removal	.....	291
Service defined	.....	4	Starter solenoid switch		
Side supports			checking operation	.....	284
installation	.....	201	cleaning	.....	308
removal	.....	200	description	.....	306-307
Single water pump type power unit			installation	.....	308-309
assembly	.....	185-196	removal	.....	307-308
description	.....	173-179	Subbase, assembly	.....	354
disassembly	.....	179-181	Supply tank (See Lubricating oil supply tank)		

