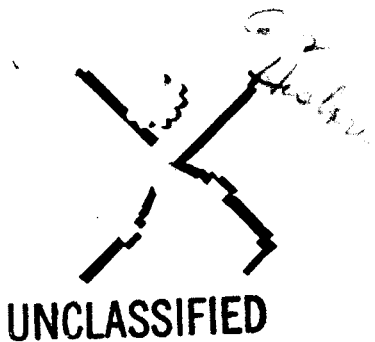
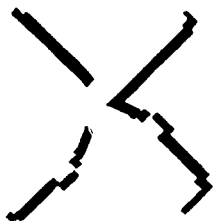


U  
15  
U635  
no. 25  
c. 3

SPECIAL SERIES NO. 25 . . . NOVEMBER 1944

# JAPANESE FIELD ARTILLERY



REGRADED UNCLASSIFIED BY  
AUTHORITY OF DOD DIR. 5200.1 R  
BY RAKERS ON 5-23-03

MILITARY INTELLIGENCE DIVISION  
WAR DEPARTMENT • WASHINGTON, D. C.

# JAPANESE FIELD ARTILLERY

MILITARY INTELLIGENCE DIVISION  
WAR DEPARTMENT WASHINGTON, D. C.

---



United States Government Printing Office  
Washington: 1944

---

UNCLASSIFIED  
PROPERTY OF US ARMY

15  
JUN 25  
1944  
8.18

5762

OLL # 63370.

~~RESTRICTED~~

MILITARY INTELLIGENCE DIVISION  
WAR DEPARTMENT  
WASHINGTON 25, D. C. 15 October 1944.

SPECIAL SERIES  
No. 25  
MID 461

**NOTICE**

1. *Special Series* is published for the purpose of providing officers with reasonably confirmed information from official and other reliable sources.
2. Reproduction within the military service is encouraged provided that (1) the source is stated, (2) the classification is maintained, and (3) one copy of the publication in which the material is reproduced is forwarded to the Military Intelligence Division, War Department, Washington 25, D. C.

~~RESTRICTED~~

# CONTENTS

	Page
<b>SECTION I. ORGANIZATION</b> .....	1
1. GENERAL.....	1
2. DIVISION ARTILLERY.....	1
a. Command.....	1
b. The Standard Artillery Regiment (Horse-drawn).....	1
c. The Standard Artillery Regiment (Motorized).....	4
d. The Mountain Artillery (Pack) Regiment.....	4
e. The Mixed Artillery Regiment.....	4
f. Artillery in the Strengthened Division.....	4
g. The Medium Artillery Battalion.....	5
3. HEAVY ARTILLERY.....	5
4. OBSERVATION (INTELLIGENCE) REGIMENTS.....	5
a. General.....	5
b. The Observation (Intelligence) Regiment.....	6
<b>II. BASIC DOCTRINE</b> .....	7
5. RELATION OF ARTILLERY TO INFANTRY.....	7
a. Offensive.....	7
b. Defensive.....	7
c. Application to Artillery.....	8
6. FORWARD EMPLACEMENT.....	8
a. General.....	8
b. Jungle Fighting.....	8
c. The Meeting Engagement.....	9
d. Use of Terrain.....	9
e. Defensive Dispositions.....	10
7. CONCLUSIONS.....	10
8. TRENDS: INCREASE OF FIRE POWER.....	10
<b>III. APPLIED TACTICS</b> .....	12
9. OFFENSIVE.....	12
a. The Advance Guard.....	12
b. Reconnaissance.....	12
c. Choice of Positions.....	13
d. Meeting Engagement—Coordinated Attack.....	13
e. Attack of Position.....	14
f. Weaknesses of Japanese Attacks of Position.....	15
g. Night Attacks.....	15
h. Pursuit.....	16
i. Offensive Tactics in the Jungle.....	16
10. DEFENSIVE.....	17
a. General.....	17
b. Command.....	17
c. Defensive Artillery Positions.....	18
d. Types and Methods of Fire.....	18
e. Defense in the Jungle.....	18
f. Raiding Parties.....	18
g. Delaying Actions and Withdrawals.....	19
h. Retreat.....	20
i. Field Artillery in Coast Defense.....	20
11. CHARACTERISTICS OF JAPANESE ARTILLERY FIRE.....	20
a. In the Philippines and Guadalcanal.....	20
b. In Bougainville Operations.....	21
c. In Burma.....	21
d. On Saipan.....	24
e. Counterbattery.....	25

## CONTENTS—Continued

	<i>Page</i>
<b>IV. EQUIPMENT</b> .....	26
12. CONSTRUCTION OF JAPANESE FIELD ARTILLERY MATÉRIEL.....	26
13. SUMMARY ESTIMATE OF JAPANESE ARTILLERY MATÉRIEL.....	29
a. Light Weight.....	29
b. Other Factors.....	32
14. DESCRIPTION OF JAPANESE FIELD ARTILLERY.....	32
a. Model 38 (1905) 75-mm Gun Improved.....	32
b. Model 90 (1930) 75-mm Gun.....	33
c. Model 88 (1928) 75-mm AA Gun.....	37
d. Model 94 (1934) 75-mm Mountain Gun.....	42
e. Model 41 (1908) 75-mm Cavalry Gun.....	45
f. Model 95 (1935) 75-mm Gun.....	46
g. Model 91 (1931) 105-mm Howitzer.....	49
h. Model 14 (1925) 105-mm Gun.....	50
i. Model 92 (1932) 105-mm Gun.....	50
j. Model 4 (1915) 150-mm Howitzer.....	58
k. Model 96 (1936) 150-mm Howitzer.....	64
l. Heavy Artillery.....	69
(1) Model 89 (1929) 150-mm gun.....	69
(2) Other heavy artillery.....	70
m. Obsolete or Obsolescent Equipment.....	74
n. Fire-control Equipment.....	78
(1) On-carriage fire control.....	78
(2) Operation of on-carriage fire control.....	80
(3) Off-carriage equipment.....	81
o. Ammunition Charts.....	86
<b>V. OPERATIONAL DETAILS OF JAPANESE ARTILLERY</b> .....	89
15. DISASSEMBLY AND OPERATION OF THE MODEL 94 (1934) 75-MM MOUNTAIN GUN.....	89
a. Disassembly.....	89
b. Disassembly of Breech Mechanism.....	95
c. Preparing for Action.....	96
16. RECOIL AND COUNTERRECOIL SYSTEMS.....	98
a. General.....	98
b. Model 94 (1934) 75-mm Howitzer Recoil Mechanism.....	99
c. Model 88 (1928) 75-mm Antiaircraft Gun.....	103
d. Model 92 (1932) 105-mm Gun.....	106
e. Model 4 (1915) 150-mm Howitzer.....	108

## ILLUSTRATIONS

FRONT COVER: The stylized canon on the cover are symbols or special types of Japanese artillery units. The symbols indicate (left to right) mountain artillery, heavy artillery and Taiwan (Formosa) mountain artillery. Ordinary field artillery is distinguished only by color of arm (yellow). The symbols are worn on the coat collar behind insignia of rank.

<i>Figure</i>	<i>Page</i>
1. The Standard Artillery Regiment (Horse-drawn).....	2
2. The Motorized Field Artillery Regiment.....	2
3. Part of a motorized 105-mm gun battery.....	2
4. The Mountain Artillery (pack) Regiment.....	3
5. The Mixed Artillery Regiment.....	3
6. Model 92 (1932) 105-mm gun in position.....	3
7. (1) Model 95 (1935) 75-mm gun; (2) Model 95 (1935) 75-mm gun; (3) Model 91 (1931) 105-mm howitzer; (4) Model 88 (1928) 75-mm antiaircraft gun.....	22
8. Partially camouflaged Model 4 (1915) 150-mm howitzer.....	24
9. Model 38 (1905) 75-mm gun improved, left side.....	30
10. Model 38 (1905) 75-mm gun improved, right side.....	30
11. Model 38 (1905) 75-mm gun improved, showing equilibrators.....	30
12. Breech of Model 38 (1905) 75-mm gun improved, left side.....	31
13. Breech of Model 38 (1905) 75-mm gun improved, right side.....	31
14. Model 90 (1930) 75-mm gun horse-drawn. Insert shows gun limbered.....	34
15. Battery of motorized Model 90 (1930) 75-mm guns in action in China.....	35

## ILLUSTRATIONS—Continued

<i>Figure</i>	<i>Page</i>
16. Model 90 (1930) 75-mm gun, motorized.....	35
17. Model 88 (1928) 75-mm AA gun, emplaced.....	38
18. Model 88 (1928) 75-mm AA gun in traveling position.....	38
19. Model 88 (1928) 75-mm AA gun, right side.....	39
20. Model 88 (1928) 75-mm AA gun, front view of elevating and traversing gear.....	39
21. Model 88 (1928) 75-mm AA gun, left side.....	40
22. Model 88 (1928) 75-mm AA gun, breech detail.....	40
23. Model 94 (1934) 75-mm mountain gun, right side.....	41
24. Model 94 (1934) 75-mm mountain gun, left side.....	43
25. Model 94 (1934) 75-mm guns in action in China.....	43
26. Model 41 (1908) 75-mm cavalry gun.....	44
27. Model 41 (1908) 75-mm cavalry gun, rear view.....	44
28. Model 95 (1935) 75-mm gun.....	47
29. Breech of Model 95 (1935) 75-mm gun.....	47
30. Above—Model 91 (1931) 105-mm howitzer. Below—Rear view.....	48
31. Model 91 (1931) 105-mm howitzer battery in action in China.....	48
32. Model 14 (1925) 105-mm gun.....	51
33. Model 14 (1925) 105-mm gun, limbered.....	51
34. Breech of Model 14 (1925) 105-mm gun.....	51
35. Battery of Model 14 (1925) 105-mm guns emplaced.....	52
36. Model 92 (1932) 105-mm gun, right side.....	54
37. Model 92 (1932) 105-mm gun, front three-quarters.....	54
38. Model 92 (1932) 105-mm gun, left side.....	54
39. Model 92 (1932) 105-mm gun: winch in position on cradle.....	55
40. Breech of Model 92 (1932) 105-mm gun.....	55
41. Model 92 (1932) 105-mm gun: wheel brake lever.....	56
42. Model 92 (1932) 105-mm gun: two trail plates driven into ground, with trail plate removing levers in position.....	56
43. Model 92 (1932) 105-mm gun: detail of right side, showing elevating handwheel and trail.....	57
44. Trail ends in traveling position, with lock closed.....	57
45. Model 4 (1915) 150-mm howitzer, right side.....	59
46. Model 4 (1915) 150-mm howitzer, left side.....	59
47. Model 4 (1915) 150-mm howitzer emplaced.....	60
48. Breech of Model 4 (1915) 150-mm howitzer with breechblock raised.....	60
49. Model 4 (1915) 150-mm howitzer with crew.....	61
50. Wheel brake of Model 4 (1915) 150-mm howitzer.....	61
51. Assembly of Model 4 (1915) 150-mm howitzer: bringing up the tube and rear trail section.....	62
52. Assembly of Model 4 (1915) 150-mm howitzer: connecting rear trail section to carriage.....	62
53. Assembly of Model 4 (1915) 150-mm howitzer: placing tube in battery.....	62
54. Assembly of Model 4 (1915) 150-mm howitzer: removing wheels of the rear trail and tube carrying section.....	63
55. Assembly of Model 4 (1915) 150-mm howitzer: tube in battery, removable rails removed.....	63
56. Winch on left side of Model 4 (1915) 150-mm howitzer trail.....	63
57. Model 96 (1936) 150-mm howitzer, limbered.....	65
58. Model 96 (1936) 150-mm howitzer, left side.....	65
59. Model 96 (1936) 150-mm howitzer, right side.....	66
60. Model 96 (1936) 150-mm howitzer, front view.....	66
61. Model 96 (1936) 150-mm howitzer: (1) left side, showing sight mount and traversing handwheel; (2) front detail, showing recoil mechanism and brake lever.....	67
62. Model 96 (1936) 150-mm howitzer emplaced in the jungle.....	68
63. Model 89 (1929) 150-mm gun.....	71
64. Model 89 (1929) 150-mm gun battery in China.....	71
65. Model 45 (1912) 240-mm howitzer in revetted emplacement.....	72
66. Model 45 (1912) 240-mm howitzer, right side.....	72
67. Model 45 (1912) 240-mm howitzer, emplacement nearing completion.....	72
68. Model 45 (1912) 240-mm howitzer, left side.....	73
69. Breech of Model 45 (1912) 240-mm howitzer.....	73
70. Model 45 (1912) 240-mm howitzer being emplaced.....	73
71. Model 38 (1905) 105-mm gun.....	74

## ILLUSTRATIONS—Continued

<i>Figure</i>	<i>Page</i>
72. Breech of Model 38 (1905) 105-mm gun.....	75
73. Characteristics of obsolete weapons—firing data.....	75
74. Breech of the Model 38 (1905) 75-mm field gun.....	76
75. Model 38 (1905) 120-mm howitzer.....	76
76. Model 38 (1905) 75-mm field gun.....	77
77. Characteristics of obsolete weapons—movement data.....	77
78. Sight mount on Model 4 (1915) 150-mm howitzer.....	78
79. Model 38 (1905) 75-mm gun improved: range rack with sight mounted.....	79
80. (1) Mounting the range rack; (2) range rack with angle of site micrometer and level.....	81, 82
81. Gunner's quadrants.....	83
82. Battery commander's telescopes.....	83
83. One-meter base range-finder.....	84
84. Aiming circle.....	84
85. Detail of aiming circle.....	85
86. Japanese 75-mm ammunition.....	86
87. Japanese 105-mm ammunition.....	87
88. Japanese 150-mm ammunition.....	88
89. Model 94 (1934) 75-mm mountain gun.....	89
90. Disassembly of Model 94 mountain gun—first step: removal of trail sections.....	89
91. Second step: removal of shield.....	90
92. Third step: removal of tube.....	92
93. Fourth step: (1) removal of the breech (position of breech latch); (2) removal of the breech.....	91, 92
94. Fifth step: (1) trunnion cap lock; (2) removal of the cradle.....	93
95. Sixth step: removal of front trail sections.....	94
96. Seventh step: removal of wheels.....	94
97. Disassembly of breech mechanism.....	95
98. First step: removal of traveling bar.....	96
99. Second step: preparation of trail spades.....	97
100. Third step: mounting the sight mount.....	98
101. Japanese air-filling tube.....	100
102. Adapter for fitting U. S. air-filling tube to Japanese recoil and counterrecoil mechanism.....	100
103. Front end of cradle.....	101
104. Front end of cradle with adapter, air-filling tube (C61285), air-filling tube, flexible (C419), gauge (B747), in position for reestablishing gas pressure in counterrecoil system.....	101
105. Front end of cradle showing connections for filling counterrecoil system with liquid using the M3 "Blackhawk" liquid pump.....	102
106. Rear end of cradle.....	103
107. Front end of cradle of Model 88 75-mm anti-aircraft gun.....	104
108. Rear of Model 88 75-mm AA gun showing index plug sleeves.....	104
109. Breech of Model 88 75-mm AA gun, showing piston retainer nut.....	105
110. Front end of cradle, with protective door open.....	106
111. Front end of cradle with adapter, air-filling tube (C61285), air-filling tube, flexible (C419), gauge (B747), in position for reestablishing gas pressure in counterrecoil system.....	107
112. Rear end of cradle.....	108
113. Bottom of cradle with adapter.....	109
114. Location of purge plug on cradle of Model 4 (1915) 150-mm howitzer.....	110
115. Rear end of cradle showing the M3 liquid pump attached for adding the recoil mechanism liquid.....	110
116. Front of Model 96 (1936) 150-mm howitzer, showing counterrecoil liquid level window and air or liquid filler valve.....	111
117. Rear of Model 96 (1936) 150-mm howitzer cradle, showing counterrecoil cylinder and recoil cylinder with drain, filler and purge plugs.....	111

JAPANESE  
FIELD ARTILLERY





## Section I. ORGANIZATION.

---

**1. GENERAL.** A salient feature of the organization of Japanese artillery prior to the outbreak of the present war was the absence of any adequate provision for the control of artillery by higher echelons. Preponderant, indeed almost exclusive, employment of artillery in the role of a forward infantry-support weapon justified, in the minds of Japanese staff officers, the allocation of small artillery units to infantry control, and a disproportionate number of independent artillery units. Even the absence of effective provisions for divisional control was justified under this concept.

Within the past 2 years, however, both army artillery headquarters (or artillery commands) and group artillery headquarters have been identified. The army artillery headquarters has a total personnel of 110 and is commanded by a lieutenant general or major general. The commander exercises direct command over all artillery directly attached to the army, and provides for unified control of army and division artillery.

The artillery group headquarters is commanded by a major general or colonel and includes a total personnel of 170 officers and enlisted men. This headquarters exercises control of all division artillery and ensures coordination of the regimental artillery of the constituent regiments of the divisions.

**2. DIVISION ARTILLERY.—a. Command.** According to Japanese doctrine, "The division commander as a rule consolidates all the artillery, both divisional and attached, and entrusts its direction to the division artillery commander." Nevertheless, the regulations state that "depending on the situation, an important part of the artillery may be placed at the disposal of front-line commanders," and thus far in actual practice this allocation of artillery has been the rule rather than an exception.

Theoretically, at least, the division commander defines the basic principles relating to the disposition of artillery and the intensity of fire, and incorporates in his field order directions necessary to ensure effective cooperation between infantry and artillery. The division artillery commander, in turn, usually a colonel, assigns missions to each battalion or other unit under his control and provides for coordinated control of fire.

**b. The Standard Artillery Regiment (Horse-drawn).** The normal artillery component of the Japanese triangular division is the 36-gun regiment of 75-mm field or mountain artillery. The regiment may be either horse-drawn or motorized; if the former, it has a personnel of about 2,300. The horse-drawn regiment consists of a regimental headquarters, three bat-

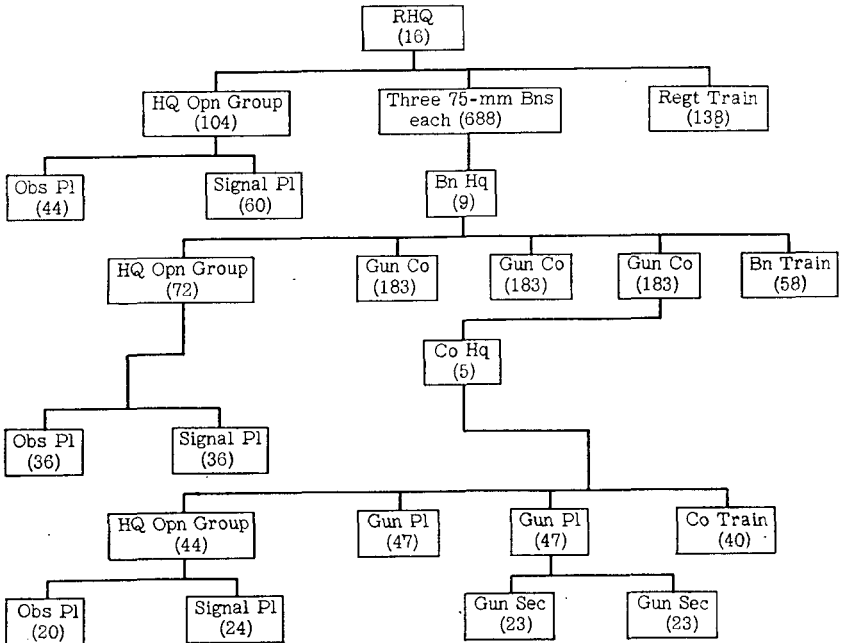


Figure 1.—The Standard Artillery Regiment (Horse-drawn).

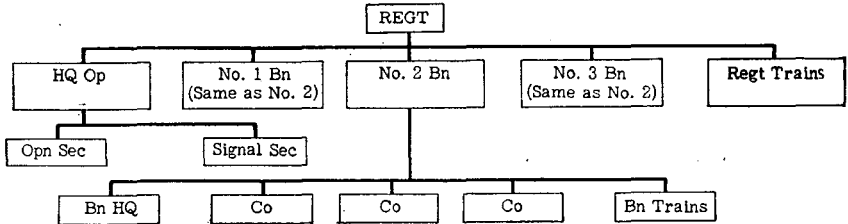
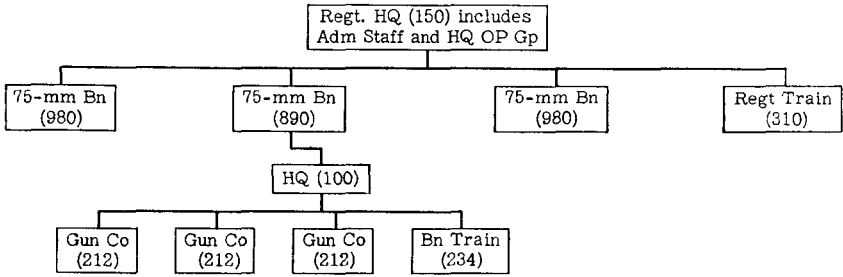


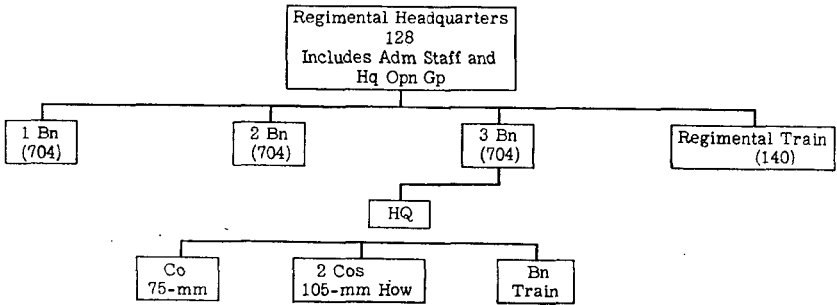
Figure 2.—The Motorized Field Artillery Regiment.



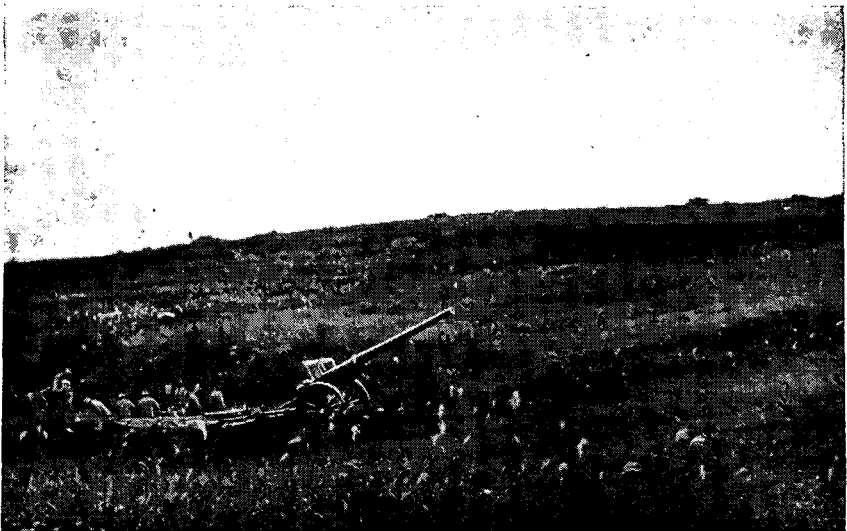
Figure 3.—Part of a motorized 105-mm gun battery. (The tractors are 4-ton Model 94 Sumidas; one draws two Model 92 gun caissons, each holding 24 rounds, the other a Model 92 105-mm gun. The touring car is a Model 1929 Buick. Beyond the Buick is a Model 94 truck chassis fitted as a battery detail vehicle.)



*Figure 4.—The Mountain Artillery (pack) Regiment*



*Figure 5.—The Mixed Artillery Regiment.*



*Figure 6.—Model 92 (1932) 105-mm gun in position in a depression on the reverse slope of a hill.*

talions armed with 75-mm guns, and a regimental train. Approximately 2,000 horses are used for traction and mounts.

The regiment is commanded by a colonel or lieutenant colonel, with an adjutant and a staff of 14 noncommissioned officers and enlisted men. Its headquarters operational group, with a total personnel of 104, comprises an observation platoon and a signal platoon of two sections (one wire and one radio). The regimental train, commanded by a captain or a lieutenant, has a personnel of 138 officers and enlisted men allocated to three ammunition platoons and one field baggage platoon. Each battalion has a total strength of 688 officers and enlisted men; each gun company (battery) has a complement of 183, while 58 officers and enlisted men are in charge of each battalion train.

**c. The Standard Artillery Regiment (Motorized).** The total strength of the motorized version of the standard artillery regiment is somewhat smaller than that of the horse-drawn regiment, with 124 men in headquarters, 107 assigned to regimental trains, and 563 to each of three battalions. The total authorized regimental strength is 1,920.

**d. The Mountain Artillery (Pack) Regiment.** The organization of the mountain artillery regiment is similar to that of the standard regiment, except that all equipment is carried on pack animals, and the companies (batteries) are armed with thirty-six 75-mm mountain guns instead of the field pieces. Its strength is somewhat greater than that of the standard field artillery regiment. A table showing the strength of the Hosokawa field artillery of the Kawagishi Unit gives the total strength of the mountain artillery regiment as 2,894. In some cases, however, it may be more than 3,000.

Some regiments include a battalion of 105-mm pack howitzers, for the existence of such a weapon has been reported, and there is reference to it in a Japanese document. The traverse of the weapon as reported is very narrow, in contrast to the current tendency in the construction of new Japanese artillery pieces which have a traverse of at least 30°. This factor, together with certain other evidence, suggests that the weapon may be an old one.

**e. The Mixed Artillery Regiment.** Mixed artillery regiments have basically the same organization as the other types. They normally are equipped with twelve 75-mm guns and twenty-four 105-mm howitzers. When horse-drawn, the regiment numbers approximately 2,380 officers and men; this figure will be materially reduced with motorization.

**f. Artillery in the Strengthened Division.** In the strengthened division, as distinguished from the normal triangular type, the artillery element consists of an artillery group commanded by a major general or colonel. Such a group comprises a headquarters and a regiment of field artillery, armed with 75-mm guns and 105-mm howitzers. It also includes a battalion of medium artillery equipped with 150-mm howitzers. Other independent artillery units also may be attached if the missions of the group or tactical

exigencies warrant such increases in its strength. Antiaircraft and anti-tank units also may operate under the control of the artillery group.

**g. The Medium Artillery Battalion.** The medium artillery battalion, as pointed out in f above, may be assigned or attached to the artillery group of a strengthened division. Possibly because the Japanese are inadequately supplied with this type of artillery, constituent companies, or even smaller units of the battalion in many instances, will be attached piecemeal. A medium artillery battalion on Saipan was equipped with twelve 150-mm howitzers, eight 105-mm howitzers, and four unidentified pieces. Usually, the battalion will have a total of twelve pieces.

The battalion consists of a headquarters, with the usual administrative staff and operational group, and three companies each equipped with four 150-mm howitzers. The total strength of the battalion is estimated at 950 officers and enlisted men. Traction of guns and trains is afforded by 769 horses. It is to be expected that such battalions may be motorized, but no such organizations thus far have been encountered.

**3. HEAVY ARTILLERY.** There is little information about Japanese heavy artillery; but it is known that there are heavy artillery regiments of both the mobile and fixed type. Although no organizations of the mobile type are believed to have been in existence prior to 1937, there now are as many as 12 regiments. The fixed heavy artillery regiments were designed originally to consist of two battalions, each having 4-gun batteries, and it is believed that the mobile type are similarly organized

The mobile units are tractor-drawn and are armed with 150-mm (5.9 inches) and 240-mm (9.45 inches) howitzers. The fixed type, in addition to 240-mm howitzers, are reported to be equipped with an undetermined number of 300-mm howitzers.

#### **4. OBSERVATION (INTELLIGENCE) REGIMENTS. a. General.**

The technical efficiency of Japanese observation equipment and techniques was notably low prior to the outbreak of the present war. Since the beginning of hostilities, however, three observation (intelligence) regiments have been identified. In instances such as in the Hong Kong campaign, where Japanese counterbattery has been very accurate, these results were achieved, it is believed, by use of sound ranging, flash ranging, and well-coordinated air observation. Existence of observation regiments and evidence of their satisfactory performance afford additional reason to anticipate improvement in Japanese artillery techniques. Balloon regiments are known to exist, and independent balloon companies were employed for artillery observation at Singapore. A motorized balloon company, with a total personnel of 145, is equipped with one observation balloon, and its transport is handled by 23 motor vehicles.

**b. The Observation (Intelligence) Regiment.** The observation regiment, which is commanded by a lieutenant colonel, has a total personnel of 675. Such units thus far identified have been horse-drawn, although motorization may have begun. Normal organization includes a headquarters group, a survey unit, a plotting unit, and a sound detector unit. Headquarters unit, in addition to administrative personnel, includes a meteorological, a photographic, and a signal section. The survey unit is organized into three platoons, each of which has three survey sections and one computing section. The plotting unit also has three platoons, each of which maintains three plotting stations. The unit is believed to include facilities and personnel for target plotting, flash spotting, and the interpretation of aerial photographs. The sound-detector unit is responsible for the operation of six listening posts.

## Section II. BASIC DOCTRINE.

---

### 5. RELATION OF ARTILLERY TO INFANTRY. a. *Offensive.*

Any study of Japanese artillery doctrine must be predicated upon a thorough understanding of their infantry tactical doctrines. Constant insistence upon the superiority of the offense is the dominant consideration of Japanese infantry tactics. The primary objective is to close with the enemy as soon as possible, so that the assumed inherent superiority of the Japanese soldier in hand-to-hand fighting may be exploited with maximum advantage. Time after time this emphasis upon the offense has engendered decisions to attack in situations where orthodox tactical doctrine would indicate the necessity of assuming the defensive. Attacks are likely to be launched without adequate reconnaissance and without consideration of time and space factors, with the result that the vital principle of concentration of effort has often been flouted.

Envelopments, either single or double, are the preferred maneuvers in Japanese offensive tactics. A determined frontal pressure is maintained by a holding attack, while the main force is thrown against one or both enemy flanks. The classic objective of envelopment tactics is to attain complete encirclement of the hostile forces. Frontal attacks may be delivered, however, if the desire to deny the enemy time to build up his forces and fire power outweighs the usual prudent restrictions on this form of attack which the Japanese normally recognize. In a frontal attack the main effort is made against a soft spot in the opposing line, with the objective of scoring a swift, deep penetration along a narrow front.

If tanks are employed, Japanese combat regulations stipulate that leading tanks are expected to rush deeply into the zone of hostile artillery. Friendly artillery, on the other hand, is assigned a mission of covering the advance of the tanks through the forward areas of hostile antitank weapons.

**b. *Defensive.*** There are occasions when the Japanese commander is confronted with a hostile force so overwhelmingly superior in numbers, fire power, or position that reversion to the defense is unavoidable despite doctrinal precepts. Yet a profound dislike of the defense permeates all tactical manuals and imbues officers and enlisted men alike with the conviction that it is nothing more than a passing phase in combat. The objective of defense, according to Japanese doctrine, is to inflict such losses on a temporarily superior enemy that eventually his advantages will be neutralized and the offensive can be resumed. This conviction has the effect of stimulating eagerness to initiate counterattacks which are often, accordingly, delivered without adequate preparation.

**c. Application to Artillery.** The doctrinal principles that so completely permeate infantry doctrine have their corollaries in artillery tactics. The primary function of Japanese field artillery is conceived to be the immediate and close support of infantry assault. The speed of movement and the constant endeavor to achieve surprise, considered so essential in an infantry offensive, apply with equal validity to artillery doctrine.

To be sure, the Japanese recognize other important artillery objectives. Enemy infantry is to be crushed and the weapons emplaced on his flanks are to be destroyed by artillery fire, according to Japanese artillery instruction. Obstacles that impede infantry advance are assigned to the artillery for destruction, and the capabilities of artillery for the disruption of hostile rear lines of communication are stressed. In actual practice, nevertheless, the function of artillery as a direct infantry support weapon has been emphasized almost to the exclusion of other missions.

Preoccupation with the close-support mission of artillery has been, in turn, primarily responsible for the incorporation of artillery subunits with infantry in regimental gun companies and the battalions, as well as sub-allotments of independent artillery units. Technical deficiencies of Japanese artillery and serious production limitations have militated against the mass employment of artillery under high-echelon control. But basically the Japanese method of allocating artillery has resulted from the doctrine of close support for infantry.

**6. FORWARD EMPLACEMENT. a. General.** Insistence upon the necessity of keeping artillery well forward in support of advancing infantry amounts almost to a fetish among Japanese artillery officers, and the enlisted men seem eager to demonstrate that they are just as ready as the infantrymen to brave the dangers of front-line combat. Positions are sited with a few hundred yards of foremost enemy defense points, and command posts, in many cases, are located right beside the guns to make voice control of fire possible. There have been instances when Japanese artillery fire was laid only 50 yards ahead of advancing troops. Japanese doctrine also teaches that, except in a jungle, the artillery should be behind the center of the infantry so that covering fire can be laid over most of the front of both holding and enveloping attacks, despite the restrictions on attack directions that such disposition would entail.

**b. Jungle Fighting.** Jungle fighting aggravates the difficulties of extending close fire support because of the difficulty of locating friendly infantry and the necessity of firing over the trees and thus too far ahead of the infantry to enable full advantage to be taken of the artillery support. As stated in Japanese doctrine:

If an artillery position in the rear of the front line is selected, it usually means that the position must be well to the rear in order to permit firing safely over the trees and above the head of our own troops. To choose such a position means that in



jungle country the infantry will usually be unable to take full advantage of the artillery fire. Therefore it is better when siting guns to place them directly at the flanks of the infantry. This will have the advantage of simplifying calculations of the line of fire and it will also enable the artillery to fire immediately in front of the advancing infantry without endangering them should a shell [explode] prematurely as a result of having hit a tree.

Disposition of the artillery behind the flanks apparently has worked to the satisfaction of the Japanese, for the same document points out that, in the Salamaua fighting, "the gun positions of [a] battery during this encounter were directly on the flanks of the infantry advance. We were thus able to fire, in spite of the jungle, as close as 55 yards to our advancing troops."

Although the Japanese doctrines of artillery employment in the jungle might be organically sound, confidence in the inherent superiority of their infantry has led them to attack time and again without adequate artillery preparation. In theory, enemy artillery must be neutralized as a prerequisite for successful attack, but this principle is seldom observed, and the infiltration of artillery-destroying raiding parties is utilized instead of counterbattery fire.

**c. The Meeting Engagement.** Keeping artillery well forward is also strengthened in doctrinal concepts by the Japanese predilection for the meeting engagement, which receives more attention in tactical writings than any other form of combat. Japanese ground forces deliberately seek such engagements, which may be defined as the collision of two forces in motion, or the combat that ensues when a force in motion meets one at rest or without an organized position. Initiative and assumption of extensive freedom of action on the part of subordinate commanders in this type of fighting are stressed, so that immediate attacks may be made to seize and occupy important points, or even to achieve a decision. The artillery must be ready to displace forward as quickly as possible in order to play its prescribed part in supporting the infantry attack.

**d. Use of Terrain.** Japanese offensive doctrine holds that difficult terrain should not be permitted to inhibit operations but, on the contrary, should be used as an asset. By passing through presumably impenetrable terrain Japanese forces attempt to take the enemy by surprise, or to attack him where his defenses are weak because of his reliance upon terrain obstacles. The artillery, too, is bound by this doctrine. In the advance on Port Moresby, Japanese artillery units dragged their pieces through dense jungle and up the precipitous slopes of the Owen Stanley Range. In the fighting on Bougainville the "incredibly difficult terrain" normally would have made artillery support impossible, yet "with a brilliant, dogged effort the desperate Japanese packed a very respectable number of pieces over narrow mountain trails and through dank, tropical-rain forest to positions overlooking the [United Nations] perimeter."

**e. Defensive Dispositions.** On the defense the Japanese usually throw out an advance line ahead of their main line of resistance, to delay the enemy and afford additional time to strengthen the line where the major defensive effort is to be made. One or two artillery companies initially may be disposed in forward positions to support the advance defense line, but the bulk of it, according to Japanese doctrine, will be echeloned approximately 1,700 to 2,200 yards behind the main line. As the hostile infantry begins to mass for its attack the defense brings down counterpreparation fires. When the hostile attack actually begins, Japanese defensive artillery lays down concentrations and standing barrages ahead to upset the enemy's preparations for attack, while the artillery is expected to provide cover for such movements. The principle of keeping the artillery forward appropriately applies to the defense; in fact, Japanese overeagerness to begin counterattacks often leads to lack of adequate depth in the disposition of their artillery.

**7. CONCLUSIONS.** Thus far Japanese doctrine conceives combat as essentially an infantryman's battle. Artillery has been allocated sparingly, almost too much so, and has been used primarily in close support roles which demand its emplacement well forward and its ability to follow close on the heels of the infantry. The necessity of neutralizing enemy artillery as a prerequisite to infantry attack ostensibly has been recognized; yet excessive confidence in the self-sufficiency of the infantry thus far has militated against development of doctrine and its practical application to attain massed fire and real predominance of fire power, which are considered so vital in the tactics of other armies.

**8. TRENDS: INCREASE OF FIRE POWER.** It should be remembered that Japanese artillery has been encountered thus far primarily in jungle fighting. It can be expected that in more open country there will be adjustments made toward more centralized control and the assignment of diversified roles to artillery, but without abandonment of emphasis upon close support missions.

As the war progresses the traditional reliance upon infantry has become too ineffective and too costly to escape the notice of the Japanese high command. There is evidence that the lessons taught by the deadly accuracy and shattering power of allied artillery have begun to be reflected in Japanese artillery doctrine. Efforts are being made to augment fire support in offensive tactics, and increasing stress is being laid upon the need for neutralizing the fire support of hostile forces. In working toward these two objectives the Japanese are not so much revising their artillery doctrine as they are striving to regain the alleged superiority of their infantry which has been temporarily jeopardized, according to their military thinking, by the admitted superiority of allied artillery.

The Japanese candidly acknowledge that "we have often received effec-

tive shelling in front of the enemy position. There have even been instances where the shelling disorganized our ranks and finally made it impossible for us to charge. Artillery support is therefore essential for any successful attack against the enemy." The need for thorough artillery preparation is now being stressed, even for night attacks; hitherto it has been virtually nonexistent because of conditions conducive to the success of the favored infiltration and surprise tactics.

Recently propounded defensive doctrine has called attention to the fact that allied infantry attacks behind a curtain of shell fire. The Japanese are instructed, accordingly, to attempt to split the assault with artillery and machine-gun fire laid down to isolate the attacking infantry from its protective cover; then, at a favorable opportunity, the Japanese force can counterattack. Obviously no such objective could be achieved unless a major increase of Japanese artillery fire power were envisioned. Inclusion of more medium and heavy guns in artillery units likewise can be anticipated, and ammunition expenditure, limited in comparison with allied standards, will be increased.

## Section III. APPLIED TACTICS.

---

In section II of this study, the basic doctrinal principles of Japanese artillery employment were discussed, with particular emphasis upon the close relationship between infantry and artillery. When basic tactical situations are studied, it will be noted that in theory the broad doctrinal precepts are implemented. Yet in cases where Japanese artillery thus far has been encountered its use has been on too small a scale to warrant formulation of any but the most tentative conclusions and appreciation of probable trends. Any discussion of tactics that aims at reasonable fullness of treatment must be a composite of material garnered from both Japanese theoretical writings and actual experience.

**9. OFFENSIVE. a. The Advance Guard.** The advance guard of the Japanese infantry division is expected to secure information about the enemy and the terrain for the use of the division commander. It also protects the deployment of the main body and secures terrain features which will facilitate the progress of the main attack.

Advance-guard artillery accordingly leap-frogs from position to position in rear of the infantry advance guard, to afford continuity of support. Its other missions are to interdict or harass the movement of enemy columns and to lay down limited counterbattery fire. Theoretically, artillery attached to the advance guard will engage targets at maximum ranges of from 7,500 to 9,000 yards; in practice, however, the maximum range is seldom more than 5,500 yards. After completion of its forward missions, the advance-guard artillery reverts to regimental control in time to support the attack of the main body of the division.

**b. Reconnaissance.** Since reconnaissance is an important function of a Japanese advance guard, requisite attention is paid to the location of suitable positions for the deployment of the main artillery strength. Reconnaissance for the selection of the main artillery positions has for its first object the choice of observation posts, which must be located before gun sites are chosen. Regimental and battalion commanders in observation posts observe both friendly and enemy situations, and pay particular attention to the effect of shelling so they can direct the fire of the units under their respective commands. They designate the objectives, explain the purposes and opportunities of the fire, stipulate the duration and rate of fire, and prescribe both the type and the amount of ammunition.

After the observation posts are suitably located, the gun positions are selected, as well as proper locations for the trains. Great care is taken

during reconnaissance to secure complete information about possible routes of advance as well as the routes being utilized by the enemy.

**c. Choice of Positions.** For effective operations Japanese doctrine and practice favor the choice of artillery positions in the rear of the center of their infantry line, except in the jungle. The positions will be selected so that fire power can be concentrated upon the principal area of their attack, and so that a large part of this area can be fired on even if unexpected changes in the situation occur. The position should be as far forward as possible and concealed from the enemy. It should afford a wide field of fire which can be narrowed in direct proportion to the proximity of the enemy. Moderate inclines on back slopes of hills or ridges are favored. Woods on reverse slopes also are preferred, although woods under enemy observation are avoided where possible. In a forest or jungle, low sections, well in from the fringes, are selected. If the position is changed the ammunition is replenished and preferably concentrated in a new position before the batteries move.

Japanese artillery tactics were carefully observed during the recent fighting around Imphal in Burma. Japanese battery positions usually were in depth, with the guns behind each other along the line of fire. Distances between guns were from 100 to 200 yards. Medium batteries usually were emplaced with two guns in front and two from 500 to 1,000 yards behind them. Pieces of 105-mm caliber often were sited beside 150-mm pieces; there also were instances where one 105-mm howitzer was flanked by two 75-mm pieces.

Dummy positions are considered extremely important; Japanese doctrine holds that such positions are almost as valuable as actual ones, since they draw hostile artillery fire and cause a waste of enemy ammunition. Such decoy positions are, of course, far away from the locations of the guns.

Ammunition trains are located in positions where their communications with the firing line are secure and convenient. Telephonic lines, with the two-wire system, are laid between the battalion commander and the company (battery) commanders, as well as between the company commanders and the observation posts. Auxiliary means of communication employed are semaphore and wig-wag signals, runners, and, where possible, mounted messengers.

**d. Meeting Engagement—Coordinated Attack.** The meeting engagement is a favored form of Japanese tactics in which commanders are urged to seize the initiative resolutely and attack as quickly as possible. Preferably the attack will be coordinated, rather than piecemeal, and, if this is the case, close cooperation of artillery with the infantry is requisite.

As a Japanese division approaches the enemy, and contact is believed imminent, the rate of march of the infantry is reduced to about 1.2 miles an hour as soon as it enters the zone of possible enemy artillery fire. The

artillery, moving forward by bounds of battalions, maintains a speed of advance of from 2.5 to 5 miles per hour depending on local conditions.

The division commander prepares separate attack orders for both infantry and artillery. The artillery order will attach the artillery directly to the infantry if the front is wide, liaison is difficult to maintain, the terrain is broken and wooded, or if combat has begun unexpectedly. In normal cases, however, the division commander will control the artillery and attempt to coordinate its action with infantry operations.

In the approach and deployment phases of the meeting engagement, Japanese division artillery will take under fire hostile artillery and machine-gun emplacements to cover the deployment of friendly infantry. When the attack actually begins, it shifts its fire to hostile infantry and reserves, as well as enemy artillery, and, of course, concentrates on its primary close-support mission. In the final assault phase the artillery fire is concentrated on the area of decisive action and enemy reserves, and a most important mission is to interdict the forward movement of enemy reinforcements.

**e. Attack of Position.** A fundamental difference between a Japanese coordinated meeting engagement attack and an attack of position is that, in the latter, the infantry go into assembly areas prior to moving to the line of departure from where the attack will be initiated. The hour chosen for the jump-off is usually 1 to 2 hours after dawn, for the Japanese apparently have little confidence that their artillery will adjust and fire an effective night preparation.

When a Japanese division is engaged in an attack of position, division artillery often is reinforced by battalions of light and medium artillery. In this case, one or two battalions may be assigned to each flank; none is held in general support. If the artillery regiment of the division is of the four-battalion type, the extra battalion may be employed in counterbattery.

The first phase of an attack of position is aimed at the enemy outpost line; for this phase one battalion of the standard artillery regiment ordinarily will be assigned a counterbattery mission. The other two will fire direct-fire support missions, with the major concentration in support of the main effort, which almost invariably is made on one of the flanks. Fires of lesser volume and intensity are delivered in support of the frontal holding attack.

After the occupation of the enemy's outpost line, the division artillery fires counterbattery, harassing, and interdiction rounds until the time assigned for the opening of the artillery preparation for the main attack. The artillery preparation is usually of 1 to 2 hours duration; of the total fire laid down about one-third each is devoted to ranging, wire-cutting, and antipersonnel bursts on the enemy infantry position. When the attack begins, the mission of the artillery becomes one of support, with special attention to the flank or flanks chosen for envelopment. Often one or two

companies (batteries) may be attached to the infantry assigned the major attack role to ensure maximum coordination.

Gunnery methods in attack on fixed defensive positions generally are quite elementary. Axial ground observation, with the observation posts usually quite close to the guns, most often is employed. Ammunition allowances are stated to be 3 to 3½ days of fire, with the day of fire computed at 300 rounds.

Although Japanese attacks usually are launched after daybreak, because of the inability of their artillery effectively to lay down night preparations, combat regulations imply that the artillery nevertheless is capable of registering at night so that fire for effect can be opened promptly at dawn. Recent documentary evidence shows that increased consideration is being given to the dawn attack. In a dawn attack it is believed that a range of about 3,000 yards is deemed most suitable by the Japanese. The field of fire is narrowed in accordance with the proximity of the enemy, and Japanese artillery commanders are admonished to move their observation posts farther forward if the gun positions themselves cannot be so moved to compensate for the increasing difficulties of night observation and range registration.

**f. Weaknesses of Japanese Attacks of Position.** Aside from unwillingness to fire night preparations, other weaknesses of Japanese artillery in attacks on fixed positions are apparent. For one thing, there is not enough artillery for the satisfactory performance of the basic mission to neutralize enemy defenses. No real neutralization of a strongly wired-in defensive position can be achieved by a division utilizing three, or at most four, battalions of light artillery. The practice of daylight firing for adjustment reduces tactical surprise and, in considerable measure, diminishes the effect on morale of preparatory fire. It will be noted that, even in cases where the division artillery is considerably strengthened, it is committed entirely, with none kept in reserve for general support missions that subsequently may be necessary or expedient as the attack progresses. This factor seriously reduces the flexibility of artillery fire, and curtails the ability of the division commander to intervene decisively with his artillery. Thus far, however, lack of adequate artillery preparation has not dissuaded Japanese commanders from delivering their infantry attacks as scheduled. The infantry jumps off, even with the enemy wire and machine-gun emplacements largely intact, and incurs the most costly consequences. There is evidence, however, that the Japanese lack of appreciation of the fire power of modern artillery has been so forcibly brought home that, as pointed out in section II, more effective tactics learned from experience and observation will bring about major changes in the tactical employment of their artillery.

**g. Night Attack.** Night attacks are favored by Japanese commanders, despite the loss of effective lateral communications, difficulty of maintain-

ing unified direction, and the greater chance of mistakes and confusion they entail. These dangers are believed offset by the concealment and the relative avoidance of losses afforded by night attacks. Night attacks are utilized when the superiority of enemy forces prevents daylight attacks, or to exploit or complete a success won in daylight operations. They also may be employed to prevent a hostile night withdrawal, or, quite commonly, to seize and occupy points vital to the success of operations planned for the ensuing day. The effectiveness of local night attacks in distracting or misleading the enemy likewise is not overlooked.

Japanese tactical doctrine distinguishes between night attack by surprise and night attack by force. In the former there is no artillery preparation, since it is hoped that the advantage of surprise will more than compensate for its absence. In the attack by force, on the other hand, both preparatory and coordinated support fire are prescribed, although seldom achieved in practice. The artillery commander, in this type of attack, is expected to prepare to fire on designated target areas on signal, communicated from the infantry by a rocket. Special consideration also is given to fire missions that will limit the enemy's ability to mount a counterattack. Fire for destruction of enemy wire likewise may be laid down, but this is considered wasteful of ammunition.

Recent Japanese tactical trends emphasize that in a night attack the main mission of the artillery should be to silence hostile guns, especially those guarding enemy flanks. Furthermore, it is pointed out that artillery in support of a night attack should be kept as mobile as possible, and excessive rigidity in the formulation of fire plans is condemned.

**h. Pursuit.** As soon as it is discovered that the enemy is withdrawing, the Japanese attach most of the artillery to forward infantry regiments to facilitate coordination and rapid liquidation of enemy covering positions. The general mission of the artillery is to disrupt the enemy's retreat by interdicting junctions and bottlenecks in the road net, bridges, defiles, etc. As the pursuing infantry penetrates the enemy covering position, the attached artillery follows it by bounds and, when necessary, concentrates its fire on resisting enemy infantry. Battery commanders are directed to retain the ability to occupy firing positions quickly, and the line of command is kept as direct as possible. It also is held to be advantageous in pursuit operations to fire on the enemy's flanks wherever possible, and that reconnaissance must be vigorous in order that successive firing positions will be in readiness as the pursuit continues. Routes of advance to these new positions of course must be prescribed and carefully concealed from the enemy.

**i. Offensive Tactics in the Jungle.** Japanese offensive artillery tactics in the jungle are governed to a considerable degree by the preponderant desire to maintain close support of their infantry. If the artillery is placed behind



the center of the infantry line, the distance between it and the enemy is increased so that the pieces can fire over the heads of friendly infantry without danger from shells exploding against treetops. The difficulties of infantry advance through the jungle make it impossible for full advantage to be taken of artillery support.

In the jungle, therefore, the Japanese, in offensive operations, site their guns on a flank of the line on which their infantry is advancing. Errors in the calculation of direction are believed to be slight, and shells exploded prematurely as a result of striking treetops will not jeopardize their own troops. The Japanese artillery commanders endeavor to lay these flanking fires within 50 yards of advancing infantry.

It is recognized, however, that artillery preparation in the jungle, particularly when fired on a scale as modest as that employed by the Japanese, will not destroy the enemy's positions or annihilate his personnel. Therefore the infantry are expected to try to exploit the artillery support as quickly as possible, and are counseled against expecting too much from it.

Instances have not been wanting, on the other hand, where Japanese troops in the jungle have shown lack of confidence in the accuracy of their artillery fire. On one occasion, as a Japanese document points out, "when the artillery was firing at targets well forward of the front line and with little danger to our own troops, there was fear of our own shrapnel and they frequently asked us to cease fire." In general, orders to Japanese artillery in the jungle have been vague; artillery preparations for attack have been inadequate, and, despite doctrinal principles, there has been no effective neutralization of hostile artillery.

**10. DEFENSIVE. a. General.** Basic Japanese defensive doctrine states the need for the establishment of a forward defense, or outpost line, to retard the advance of the enemy while the main defensive line is strengthened. Some artillery is allocated to the support of the outpost line, but most of it is emplaced behind the main line of resistance. In some instances, the artillery is emplaced within the zone of infantry resistance, but every precaution is taken then to avoid constriction of its field of fire. Observation posts usually are behind the zone of infantry resistance, although locations actually within this zone are considered feasible.

**b. Command.** The Japanese division commander on the defense prescribes the direction of the defensive fire, designates the most vital sectors in the main defense line, and selects the areas for artillery emplacement that will serve best to support the infantry defense of such sectors. He also stipulates the time for adjustment fire and the rate of fire for effect. When this order is communicated to the artillery commander, he, in turn, issues orders for the deployment of the regiment or such other units as are under his control, assigns missions, and prescribes the type and method of fire.

**c. Defensive Artillery Positions.** On the defense, Japanese artillery directs its largest volume of fire on the area between the main line of resistance and the forward defense positions. Its greatest concentrations are fired in front of, and subsequently within, the network of infantry fire from the main line of resistance, and artillery commanders are directed to retain the possibility of bringing their fire within the main defensive zone itself. The densest fire is laid down in the direction where the main enemy attack effort is anticipated, but consideration also is given to the direction of counterattack in the disposition of the defensive guns.

A cardinal principle of Japanese artillery defensive tactics requires the batteries to be echeloned in depth, usually from 1,700 to 2,200 yards behind the main line of resistance. Positions are chosen also with a view for firing effective interdiction missions at extreme ranges, but the guns are so sited as to make possible their immediate shift to direct support of the defensive infantry without change of position. Indeed, the Japanese artillery commander is required to be prepared to deliver the maximum fire power in infantry support missions from the very beginning of the defensive engagement.

**d. Types and Methods of Fire.** Normally Japanese artillery, on the defensive, follows interdiction fire with a limited barrage as the enemy approaches the main line of resistance. Relatively few of the available guns fire such missions, however, in order that the strength and position of most of the artillery may be concealed until the enemy is within closer range. Counterbattery may be fired at this stage of the operations, but under no circumstances are artillery duels begun when the enemy is believed to possess superior artillery fire power. Alternative, or switch, positions are available if it becomes necessary to take steps to elude hostile counterbattery, and constant vigilance is maintained if penetrations of hostile tanks into the area of Japanese artillery positions is considered possible.

**e. Defense in the Jungle.** On the defensive in the jungle, Japanese guns are sited on the flanks of the friendly infantry as in the case of attack. Premature disclosures of positions are avoided, and in most instances fire is withheld until the attackers come within wide or close range. Japanese counterbattery has been for the most part ineffective, although considerable improvement has been noted on Saipan. In the jungle, chief reliance has been placed upon raiding parties to neutralize hostile artillery.

**f. Raiding Parties.** The organization, strength, and equipment of Japanese raiding parties for the neutralization of hostile artillery naturally vary according to the exigencies of the local situation and the resources at hand. The normal organization, however, consists of from 20 to 30 men, a headquarters group, a demolition section, an assault section, a covering section, and a section held in reserve. After hostile artillery has been located, by

range finding, flash ranging, or other techniques, all routes of approach to the position are explored. Prior to the raid enemy communication lines in the vicinity of his guns are destroyed to prevent, or at least to impede, prompt dispatch of reinforcements to the endangered artillery. The assault section is assigned the mission of liquidating the hostile personnel, while the demolition section destroys the guns or damages them beyond repair. The covering section protects the flanks and if advisable puts down smoke to cover the activities of the demolition section.

In a raid on a British artillery position in Burma a party of about 30 Japanese was concealed on a hill about 100 yards from the British battery. After nightfall the assault group brought light machine-gun fire to bear on the personnel of three gun positions and made them all casualties. The four-gun emplacement then was charged by about 20 men with grenades and bayonets, and, while this charge was occurring with the accompaniment of as much noise as possible, the demolition section used sticky bombs and a Bangalore torpedo to destroy the guns.

**g. Delaying Actions and Withdrawals.** (1) *Delaying actions.* Delaying actions, or "holding-out combat" as they are termed by the Japanese, include, in addition to delaying actions properly speaking, demonstrations, reconnaissance in force, and night attacks initiated to cover withdrawals. The purpose of such tactics, according to Japanese doctrine, is to gain time, or so to divert or contain the enemy as to avoid decisive combat. The Japanese prefer to conduct delaying actions from successive positions, thus avoiding the risk of involvement in decisive combat or the necessity of withdrawal before an enemy that has been permitted to come too close.

In line with these broad considerations the artillery takes the enemy under fire at extreme ranges from positions close behind the infantry. Pieces and batteries are grouped together for ease of fire direction, for the Japanese believe that there is little to fear from enemy counterbattery at this stage of the delaying action. A battalion of artillery (or smaller units if less than a division is involved) is kept in reserve behind the position as the next line of defense. When the main forces move from the original position to the next successive defense line, in accordance with delaying action doctrine, this reserve artillery has the mission of covering the withdrawal.

(2) *Withdrawal.* In a daytime withdrawal movement the division commander organizes a covering force, behind which he reforms the elements of his command. This covering force usually comprises a portion of the division which has been held in reserve. The artillery employs behind the covering position to protect the withdrawal. If the withdrawal occurs at night, a covering position need not be organized according to Japanese practice. Instead, a number of squads, well equipped with many automatic weapons are organized to act as a "shell" and left behind as cover, and the march columns are organized

the withdrawal much closer to the front line than during the day. A small amount of artillery normally is allocated to the "shell," which is expected to sacrifice itself, if necessary, to safeguard the orderly withdrawal of the main body. The artillery, however, after remaining until nearly dawn in support of the "shell," ordinarily will be withdrawn to revert to the control of the main body.

**h. Retreat.** In retreat, Japanese artillery naturally attempts to withdraw under cover by utilizing good routes concealed as much as possible from enemy observation. Artillery commanders are directed to emplace their batteries so they will be able to fire until the pursuing enemy are near. The doctrine of siting Japanese artillery on the flanks also is applied in withdrawal actions so that fire can be maintained without endangering the route of the main body.

**i. Field Artillery in Coast Defense.** In several instances Japanese field artillery has been used in coast defense. According to Japanese military thinking, coast defense is considered primarily offensive in character, since its purpose is to destroy the enemy before a landing can be effected, or very soon thereafter. On Attu, Japanese field artillery batteries, armed with 75's, were boldly emplaced and sited so their fire could be concentrated on landing craft, and antipersonnel fire could be brought to bear on troops already landed. In the Marshalls and Gilberts, guns were sited to lay flat trajectory fire on landing boats and vehicles. The guns were placed well forward for direct laying, and the positions were not in depth. Batteries had local fire control, with 2 or 3 guns usually controlled from observation towers at the gun positions. On Saipan, single pieces were sited to fire on landing craft, while batteries were emplaced to fire concentrations on the channel through which the boats had to pass to reach the beach, and to deliver flanking fire on the beach itself.

**11. CHARACTERISTICS OF JAPANESE ARTILLERY FIRE.** **a. In the Philippines and Guadalcanal.** In the Philippines campaign, Japanese artillery generally was well handled, although personnel obviously were unaccustomed to operations against hostile artillery fire. Fire from Japanese batteries usually was light but quite accurate. In the attack on Corregidor, 105-mm and 150-mm pieces were used effectively, and a few 240-mm guns were employed. Observation planes and balloons were used for reconnaissance and, to some extent, for fire control. In the Guadalcanal campaign, however, Japanese artillery usually was committed piecemeal. Fire from isolated pieces was opened at infrequent intervals, and was not timed to synchronize with American fire. There was little thought of targets of plan or opportunity had been chosen with the care demanded by artillery practice demands. Several concentrations were fired, but they were ineffective and poorly coordinated with infantry operations.

Counterbattery was virtually futile, primarily because of the lack of medium artillery.

**b. In Bougainville Operations.** One of the most extensive employments of Japanese artillery in the war to date featured their abortive attack on the Torokina perimeter on Bougainville. Here the artillery was assigned the neutralization of the airfields as its principal mission, a most important one in view of the failure of Japanese planes to arrive from Rabaul to counteract allied air strength. Concentration of the artillery on the airfields left the mission of direct support of ground troops entirely to the mortar units.

Full equipment of all identified artillery units would have aggregated 144 guns and howitzers. However, it can be assumed that not all units had their full table of equipment allowances, and a number of pieces were diverted to other sectors or were lost in bringing them over narrow mountain trails and through the jungle. The total number actually in use probably was from 40 to 50. There were no massed fires and few barrages on the targets which, besides the airfields, included road junctions and allied tank areas. Individual guns often were fired independently, and the intensity of fire varied from day to day. Fire usually was heaviest in the early morning and again at dusk. After relatively heavy shelling of the airfields for 2 days, during which several planes were destroyed, the number of shells dwindled to from five to six per day. On 23 March however, about 70 rounds were fired in less than 2 hours. This fire, although extremely light in comparison with allied standards, was quite accurate.

**c. In Burma.** In the Tiddim area of northwestern Burma, Japanese artillery tactics showed considerable adherence to principles regarded as orthodox by other modern armies, although, of course, the volume of fire was characteristically low, with the total expenditure for harassment aggregating only about 40 to 50 rounds per day. Prior to infantry attacks, preparatory fire was directed against battery positions, observation posts, headquarters, and rear installations. Fire was opened on two or three targets simultaneously, with individual targets being engaged successively by different types of guns.

Harassing fire was quite common. In the Tiddim region no registration rounds were fired, but in other instances in Burma several ranging rounds were fired prior to fire for effect. A recent Burma report recounts how Japanese medium artillery fired intermittent registration rounds for 2 or 3 days preparatory to fire for effect, which then was very accurate. It also has been noted that, after a position had been captured from the Japanese, an interval of about 2 hours elapsed before they brought artillery fire down on such positions, and then it usually was quite accurately placed.

When the 75-mm mountain gun has been used, as frequently has been the case thus far in the various combat areas, the guns usually are emplaced



*Figure 7.—(1) Model 95 (1935) 75-mm gun in position on a Saipan beach.*



*Figure 7.—(2) Model 95 (1935) 75-mm gun in position on a Saipan beach.*



Figure 7.—(3) Model 91 (1931) 105-mm howitzer on Saipan, sited for coast defense fire.

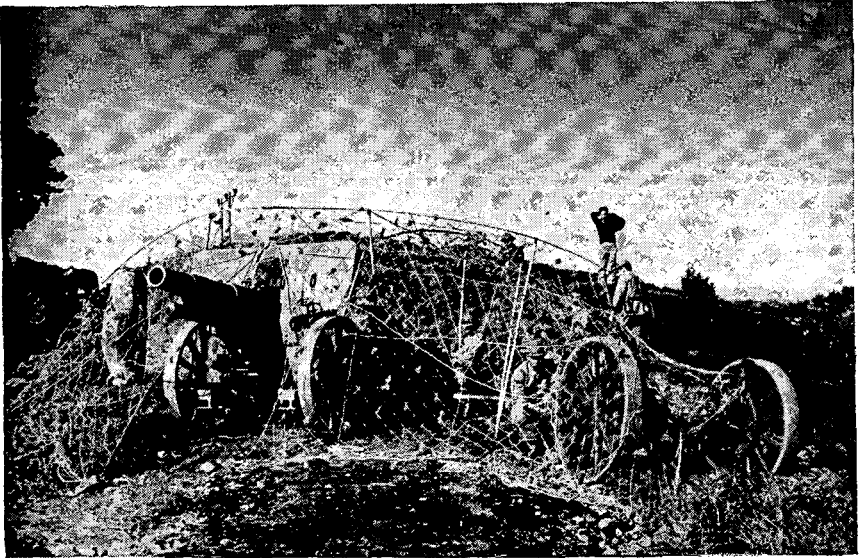


Figure 7.—(4) Model 88 (1928) 75-mm anti-aircraft gun on Guadalcanal, sited for coast defense fire.

on hilltops and fired at a range of about 9,000 yards. One or two shots are fired for adjustment, and the fire for effect is delivered from guns firing singly or by twos or threes. In only one reported instance were more than four of these mountain guns fired at one time. In the Philippines campaign, on the other hand, five-gun batteries were employed. One gun fired for registration on one target, while the other four were firing for effect on another.

In the Imphal campaign, Japanese intentions to attack could be gauged rather accurately by the nature and volume of their artillery fire. Ordinarily 20 to 40 rounds were fired for registration from a total of two medium and one mountain artillery regiment. Duration of registration fire was from 15 to 45 minutes, and the rate of fire was very slow. Prior to a small-scale attack, harassing fire usually lasted from 45 to 60 minutes at a slow rate. Ammunition expenditure was from 50 to 100 rounds. Preparatory to a large attack, however, harassing fire was laid down from 18 to 36 hours, with 200 to 300 rounds fired at a slow rate. Just prior to the main assault the rate of fire quickened, and this accelerated rate persisted from 45 to 60 minutes. Counterbattery just prior to the attack usually lasted from 10 to 15 minutes.

**d. On Saipan.** On Saipan, Japanese mobile artillery comprised a total of thirty-nine 75-mm pieces, eight 105-mm, twelve 150-mm, and four unidentified guns. Observation posts were extremely well situated and registration had been completed some time before the landings occurred. As the leading waves of the American landing forces approached the beach,



*Figure 8.—Partially camouflaged Model 4 (1915) 150-mm howitzer.*



a curtain barrage was laid down. Concentrations were fired on the channel through which the landing craft passed, and on other important targets. Such concentrations were of comparatively short duration, however, with only about 25 to 30 rounds fired, probably from one or two guns. In some instances, concentrations were shifted from target to target, apparently in accordance with a prearranged sequence, but there was no provision for adequate coverage of the entire area by zones. After the landings were consummated, however, Japanese artillery fire was scattered, and ammunition expenditure was characteristically low. By and large they failed to exploit their artillery resources to maximum advantage.

**e. Counterbattery.** Costly experiences with the fire power of modern allied artillery have induced Japanese artillery units to take every precaution against counterbattery. The excellence of their camouflage, of course, is a great asset, and the guns usually have a number of alternative positions. To confuse hostile observers, several guns are fired simultaneously from widely separated locations, and the fire of Japanese artillery often is synchronized with that of hostile guns. In a number of instances this synchronization also has been effective in deceiving hostile infantry into believing that it was jeopardized by the fire of its own artillery. Synchronization of artillery and mortar fire likewise is quite common for the same purposes. The Japanese also employ sniping tactics to hamper effective counterbattery, and make good use of flash cover. Night firing is avoided if there is imminent danger of heavy counterbattery, and the guns likewise remain silent in the presence of enemy air strength.

## Section IV. EQUIPMENT.

---

### 12. CONSTRUCTION OF JAPANESE FIELD ARTILLERY MATÉRIEL.

Construction of Japanese ordnance has always been handicapped by the comparatively late entry of Japan into the field of modern industrial practices. Prior to the opening up of Japan by Perry in 1853, the successful policy of isolation had prevented Japanese from acquiring knowledge of foreign manufacturing methods and products. Although firearms had been imported at an early date, their use was extremely limited. Bushido doctrine militated against modern arms, in that their use was considered cowardly and dishonorable. The restoration of the emperors thus found Japan not only without modern firearms, but without factories to make them. Such mechanical appliances as were made were the products of small groups of artisans. Hand made without advantage of manufacturing machinery, these differed one from another.

The great field artillery program of 1905—the 38th year of the Meiji reign—was therefore instituted only 38 years after the decision to re-arm and westernize Japan on a national scale. Model 38 75-mm guns which have been encountered in the Pacific were in fact built only 33 years after the Oksaka Arsenal completed the first modern piece of artillery, in this case a mountain gun, of French design.

Artillery pieces produced in 1905 included the 75-mm Model 38 field gun, the 105-mm (10-cm) Model 38 field gun, the 120-mm Model 38 howitzer, and the 150-mm Model 38 howitzer. The inception of such a large scale-artillery program immediately upon the close of a war is typical of Japanese arms policy. It is unusual, in that it is usually the vanquished instead of the victor who finds need for new arms.

Artillery produced at this time was either identical with or modified from European designs. This Japanese practice has been common up to and including the present era. By adopting foreign designs, or by basing their weapons on successful patterns of foreign weapons, the Japanese not only have been saved the expense and drain on their industrialization program that such action would incur; they also have gained the benefit of the experience and skill of arms designers of great European arms firms.

The 75-mm field gun Model 38 was a Krupp design with sliding wedge breechblock. The 120-mm howitzer and 105-mm gun of the same year were of basic Krupp design, but had interrupted thread breechblocks. All had hydrospring recoil systems and box trails.

The 1905 models remained standard in all calibers until 1915 when the Model 4 was made the basic medium artillery howitzer. At this time, also, the Model 38 (1905) 75-mm gun was drastically improved according

to current foreign practice. The introduction of the Model 4 and the improved 75 ushered into common Japanese use some basic principles of modern artillery construction. The trunnioning of the tube forward of the center of balance, the use of equilibrators, and the open box trail made their appearance at this time in the improved 75-mm gun. Though this piece retained the hydrospring recoil, the Model 4 (1915) 150-mm howitzer employed for the first time the more modern hydropneumatic recoil system. The Model 4 appears to be a peculiarly Japanese design, elements of which were repeated only in the Model 14 (1925) 105-mm gun. The Model 4 is also characterized by an unusual vertical drop spring loaded breechblock not used on any other piece.

From 1915 to 1930 large-scale field artillery production was apparently confined to the Model 4, the improved Model 38, and the Model 41 (1908) mountain gun. The Model 14 (1925) 105-mm gun was introduced at this time. It had the additional modern features of split-trail and pintle traverse. Evidently not a success, the Model 14 was not produced in quantity. In 1928, however, the present standard model Japanese antiaircraft gun was put into production. This weapon, the Model 88, because of its high muzzle velocity and reasonable mobility, is now also used for fire against ground targets.

The appearance of the Model 89 (1929) 150-mm gun, shortly followed by the Model 90 (1930) 75-mm gun, marked the beginning of a second great period in Japanese artillery construction. The weapons of this era have been closely patterned after designs originated by Schneider-Creusot in France, and have been designed to replace previous models, and to introduce new weapons required in modern warfare. The exception is the Model 94 (1934) 75-mm mountain gun. Though fitted with hydropneumatic recoil, split-trails with spade plate stabilization, and pintle traverse made possible by equalizing action on the axle, the breechblock after the Model 94 is the sliding wedge type, instead of the Schneider interrupted thread breechblock mechanism. The Krupp type breechblock of the Models 90, 94, and 95 is thus similar to that used in the improved Model 38 75-mm gun, and in the Model 88 75-mm antiaircraft gun. It is a horizontal sliding wedge block with continuous-pull firing mechanism, and is apparently considered to be capable of faster operation than the interrupted thread type used in the Model 41 (1908) cavalry gun. The Model 90 and Model 95 75-mm guns also are fitted with sliding wedge breechblocks, though the remainder of their design is Schneider. All other pieces of this program employ Schneider type interrupted thread breechblock. No Japanese artillery weapons use the de Range obturator, with the possible exception of the Model 89 (1929) 150-mm gun, the method of obturation of which is unknown. The Japanese have instead adopted the German practice of using cartridge-case obturation. Of the weapons of this series, the Model 90 75-mm field gun and Model 94 mountain gun used fixed ammunition.

The Schneider hydropneumatic recoil systems are contained in the cradle. Unlike the Model 4 150-mm howitzer and the Model 88 75-mm antiaircraft gun, which have floating piston type recuperators, the recuperator cylinders of the post 1929 series of Japanese artillery have direct contact between liquid and air. The recoil mechanism functions independently of the counterrecoil buffer. Recoil is throttled by action of the recoil piston on the liquid in the recoil cylinder, and by compression of the liquid and air mixture in the counterrecoil cylinders. The tube is returned to battery by pressure exerted on the counterrecoil piston by the air in the counterrecoil cylinder compressed in recoil.

The split-trails and spade-plate stabilization characteristic of these new Japanese weapons were first introduced with the Model 14 (1925) 105-mm gun. This weapon also had another feature of modern Japanese design—an equalizing device accompanying the pintle traverse so as to secure three-point suspension. However, the Model 14 had the conventional spade-plate arrangement common to earlier Japanese weapons. The new pieces have trail blocks and spade plates. This method of stabilization was first tried out by the Italian Army in their Deport 75-mm guns in World War I. It has since been widely employed in artillery designed by Schneider, Skoda, and Ansaldo.

These plates cut down on the weight of the stabilizing device because of their good angle of entrance into the ground and their relatively high holding surface in proportion to their size. The size and the number of the plates used are varied according to the force of recoil that they are required to absorb. Light artillery has one plate per trail driven through a trail block integral with the trail. The other weapons have three plates per trail driven through blocks that are dismounted for travel. These weapons supplement the stabilizing effect of the spade plates with chocks under the wheels of the piece. This system of stabilization is said almost completely to avoid lateral displacement of the piece in firing. However, especially, on the lighter weapons, the plates must be driven deeply and evenly in the trails themselves and must be level with one another or the weapon tends to pull the spades free by jumping vertically. Spade plates also make it difficult for the weapon to engage tanks at fairly close ranges, since, when the piece has reached its limit of traverse in tracking a tank, the spade plates must be jacked out before trails can be shifted and redriven preparatory to firing.

Of the series of weapons introduced in the post-1929 modernization program, the Japanese in their Model 92 (1932) 105-mm gun attained a goal they had unsuccessfully tried to reach in 1925 in their quest for an extremely long-range medium artillery weapon. The Model 94 (1934) 75-mm mountain gun has now almost entirely replaced the Model 41 mountain gun as the weapon of pack artillery. Unlike other weapons of the new program, the new 75-mm field guns and the new 150-mm howitzer Model 96 (1936)

do not appear to have displaced older weapons in their categories. To date the Model 4 150-mm howitzer has been encountered in combat at least as frequently as the Model 96. Until the Model 95 75-mm gun was found on Saipan, the only 75-mm pieces that forces have encountered on a large-scale have been the improved Model 38 and the Model 94 mountain gun. The Model 90 75-mm gun has not been reported or identified in action since Singapore, where the Model 90 and Model 95 were both employed. The Model 90 appears to be a modification of an 85-mm Schneider weapon, and has a Schneider type muzzlebrake. As Japanese industry still suffers from inability to manufacture complicated artillery matériel, it is believed that the Model 95 75-mm gun, modified from the Model 1933 Schneider 75, may be intended as a replacement to the Model 90, which it resembles.

The only new category filled by the new program was that of the light field howitzer—a type previously lacking in the Japanese Army. The weapon for this mission was selected from a Schneider 105-mm howitzer, numbers of which were bought in France. The Japanese-produced 105-mm howitzers are designated Model 91 (1931).

On the whole it appears that Japanese artillery designers have been reasonably successful in their primary object of making their guns light without thereby being forced into excessive reductions of range and fire power. There remains, however, the question of ruggedness. The weight saving on these weapons has been attained by fairly drastic reductions in the weight of the tube, the equilibrators, and most notably the recoil system and trails. In general, on the weapons with hydropneumatic recoil system the recoil and counterrecoil cylinders are extraordinarily light for the recoil and force which they must absorb. It does not appear that an extensive amount of the recoil energy can be passed into the trails since they too are remarkably light. As late as 1940 there were reports of failures in the recoil mechanism of the Model 92 105-mm gun when it fired with supercharge at maximum elevations. Further information on the ability of Japanese artillery weapons to perform adequately under adverse conditions is lacking. Until such information is available, final judgment on the success of the Japanese artillery design must be held in abeyance.

A known defect of Japanese artillery stems from the lack of proper industrial facilities for artillery production. In a recent press article, Lt. Gen. Katsuzo Kosuda, said to be chief of Ordnance Administration Headquarters for the period October 1943–March 1944, admitted that tooling both for standardization and for mass production is lacking, and that little study had been given to the problem prior to the war. These factors have resulted in a dearth of artillery on one hand, and in difficulty of maintenance due to poor interchangeability of parts on the other.

### **13. SUMMARY ESTIMATE OF JAPANESE ARTILLERY MATÉRIEL.**

**a. Light Weight.** One characteristic sharply distinguished practically every standard Japanese artillery piece from its corresponding weapons in

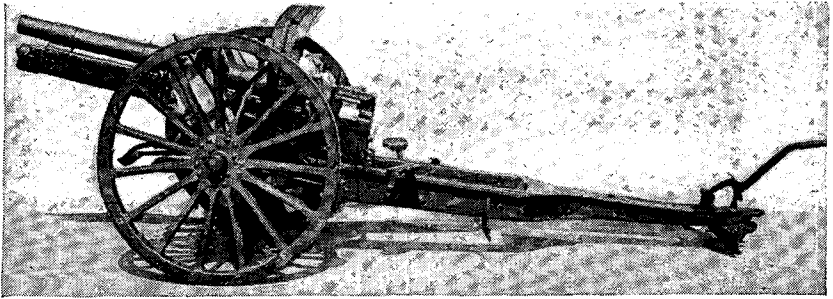


Figure 9.—Model 38 (1905) 75-mm gun improved, left side.

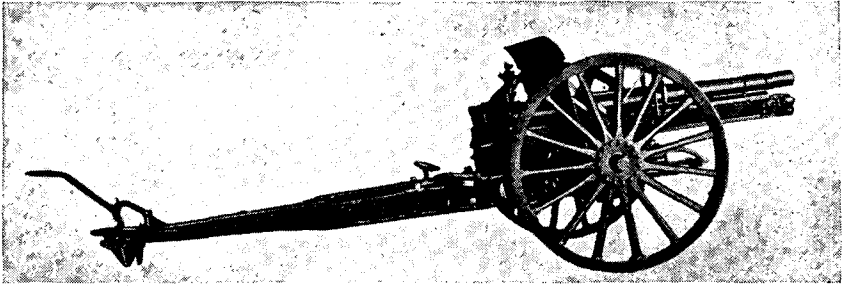


Figure 10.—Model 38 (1905) 75-mm gun improved, right side.

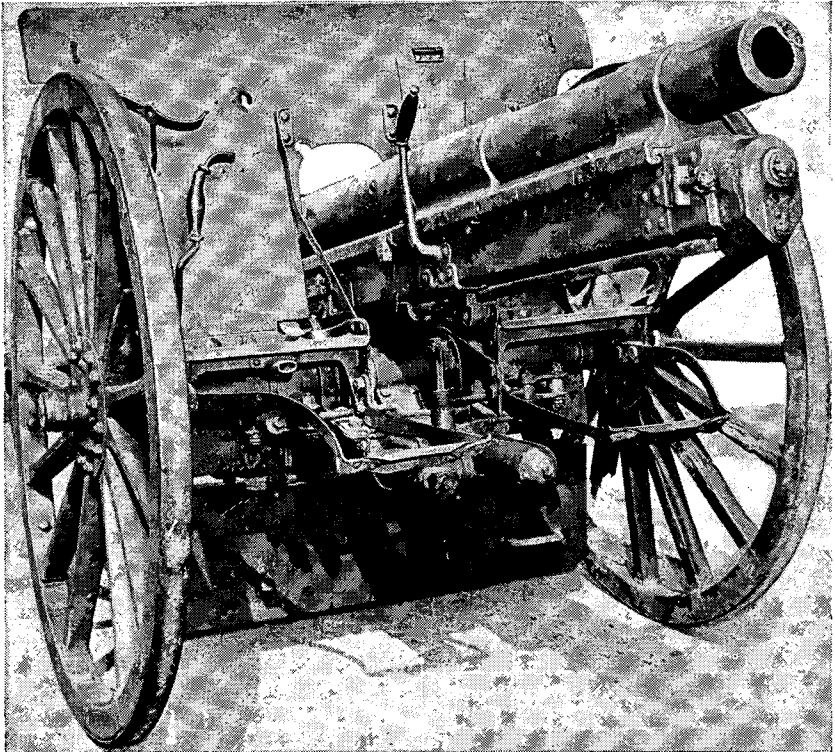
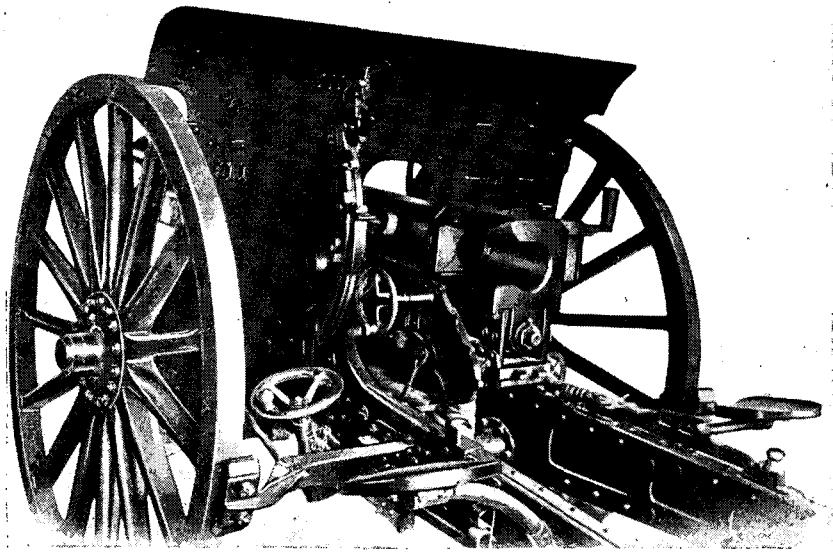
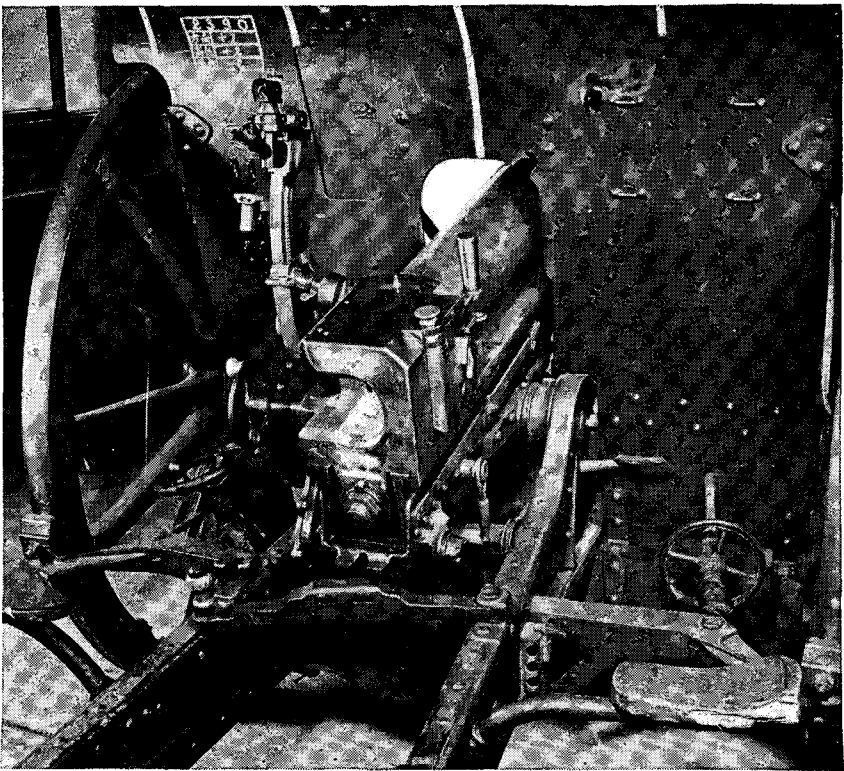


Figure 11.—Model 38 (1905) 75-mm gun improved, showing equilibrators.



*Figure 12.—Breech of Model 38 (1905) 75-mm gun improved, left side.*



*Figure 13.—Breech of Model 38 (1905) 75-mm gun improved, right side.*

the artillery of the other great powers. The basic principle and primary effort of Japanese artillery construction appear to have been to achieve lightness, if necessary at the expense of other characteristics frequently deemed desirable in artillery design. A comparison of the weights of several Japanese artillery pieces with the corresponding German pieces will illustrate the extent to which the principle of lightness has governed the design of Japanese guns.

Type of Gun	Weight—pounds (approx.)		Percent Weight	
	Japanese	German	Japanese	German
105-mm Howitzer	3,300	4,250	70	100
105-mm Gun	8,200	12,300	66½	100
150-mm Howitzer	6,160 (1915)	12,300	50	100
	9,100 (1936)		73	100

Japanese 105-mm howitzers are actually over 250 pounds lighter than their Schneider prototype. The Model 38 (Improved) is also light for its caliber. In fact, the only standard Japanese pieces nearly equal in weight to their equivalents elsewhere are the Model 90 75-mm gun and the Model 94 mountain gun. In some instances lightness has been attained at some sacrifice of relative range.

Type of Gun	Range—yards (approx.)	
	Japanese	German
105-mm Howitzer	12,000	12,000
105-mm Gun	19,900	20,800
150-mm Howitzer	10,000 (1915)	14,000
	13,000 (1936, Ptd. Shell)	
	11,500 (1936, HE Shell)	

**b. Other Factors.** The weights of the projectile used in Japanese artillery weapons are approximately the same as those used by other great powers in artillery of corresponding caliber except in the case of the 150-mm pieces, where the Japanese shells are about 15 pounds lighter.

**14. DESCRIPTION OF JAPANESE FIELD ARTILLERY. a. Model 38 (1905) 75-mm Gun Improved.** During World War I the Japanese made major modifications in the construction of the Model 38 (1905) 75-mm gun. The piece was trunnioned forward and equilibrators were added to compensate for muzzle heaviness. The plain box trail was modified into an open box. This allowed for an elevation of 43°. Axle traverse was retained, thus limiting the effectiveness of this piece as an antitank weapon. The hydrospring recoil mechanism also remained, but was made variable to permit firing at high elevations. Although the Japanese have produced far more modern 75-mm guns in the Models 90 and 95, there is little evidence that the Improved Model 38 has been generally replaced as the standard light division artillery piece.



## GENERAL

Weapon.....	75-mm gun, Model 38 (1905) improved.
General Characteristics.....	A modification of one of the 1905 series or Japanese guns providing it with greater flexibility.
Identification.....	1. Modified box trail. 2. Long cradle flush with muzzle of piece. 3. Marking on breech face.
Organization to Which Issued.....	Division artillery.

## FIRING CHARACTERISTICS

Length of Tube.....	7 ft. 6 in. 31 calibers.
Muzzle Velocity.....	HE Shell 1,640 f/s. Pointed Shell 1,977.8 f/s.
Maximum Range.....	HE Shell 8,938 yards. Pointed Shell 13,080 yards.
Elevation.....	43°.
Depression.....	-8°.
Traverse.....	3° 30' right, 3° 30' left
Rate of Fire:	
2 minutes.....	15 rpm.
15 minutes.....	4 rpm.
Continuous.....	100-120 rph.
Ammunition.....	HE, APHE, shrapnel, pointed, incendiary, smoke, illuminating. (For further data, see fig. 86).
Type of Breechblock.....	Horizontal sliding wedge.
Type of Firing Mechanism.....	Continuous pull percussion (Krupp type).

## CONSTRUCTION AND MOVEMENT DATA

Weight of Gun:	
Firing.....	2,501.5 lb.
Traveling.....	4,207.4 lb.
Over-all Length:	
Firing.....	17 ft.
Traveling.....	29 ft. 4 in.
Width:	
Track.....	4 ft. 6 in.
Maximum.....	5 ft. 2 in.
Height.....	4 ft. 10 in.
Road Clearance.....	1 ft. 4 in.
Method of Transport.....	Horse-drawn—six horses.
Practical Speed on Good Roads.....	24.8 miles per day.
Time to Emplace.....	2 minutes.
Type of Traverse.....	Axle.
Type of Equilibrator.....	Spring.
Type of Brakes.....	Hand friction brake (ordinary wagon brake).
Wheels and Tires.....	Wood spoked artillery wheels; steel band.
Trail.....	Modified box adjustable spade.
Recoil System:	
Standard.....	19.5-48.8 in.
Maximum.....	48.8 in.
Type of Recoil System.....	Hydrospring automatically variable.
Quantity Fluid Recoil Cylinder.....	4.7 qt.

**b. Model 90 (1930) 75-mm Gun.** Model 90 (1930) 75-mm gun has the most modern appearance of any Japanese artillery weapon. It has a very long tube and is the only Japanese artillery piece using a muzzle brake. It has been manufactured in two types, one with artillery wheels for horse draft, the other with pneumatic tires and disk wheels for tractor or truck draft. In its second version it is a highly mobile weapon. The chamber of the Model 90 is longer than the chamber of the Model 38, so that, although it fires the same projectiles, its cartridge case is longer, and the propellant charge is larger. The high velocity attained by this piece makes it the only Japanese weapon suitable for antitank fire against heavy armor at considerable ranges. The adaptability of the Model 90 for this purpose is increased by the extensive traverse of which it is capable because of the

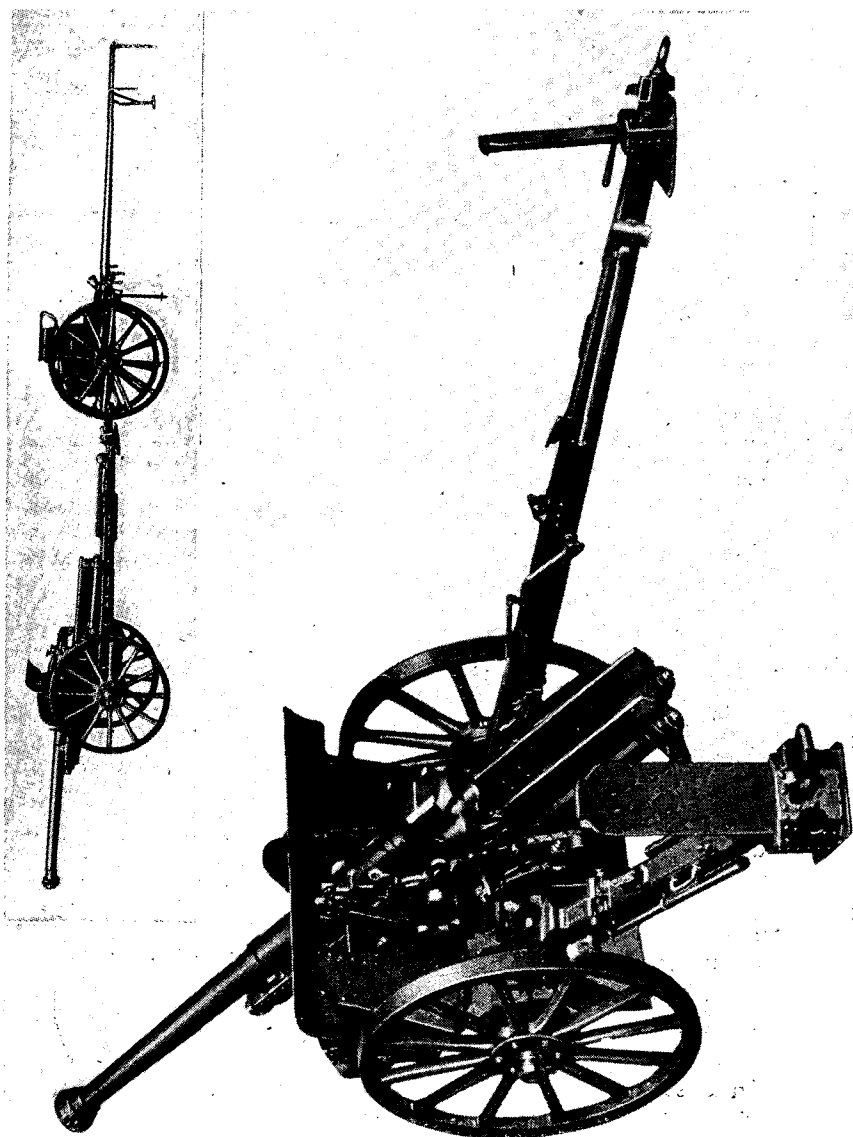


Figure 14. Model 90 (1930) 75-mm gun horse-drawn. Insert shows gun limbered.



*Figure 15. Battery of motorized Model 90 (1930) 75-mm guns in action in China.*



*Figure 16. Model 90 (1930) 75-mm gun, motorized.*

use of pintle traverse in its construction, but this is diminished by the use of spade plates which makes trail shifting a rather lengthy process. The Model 90 appears to be adapted from the 85-mm Schneider Model 1927 built for Greece. It is believed that early models had the original Schneider interrupted thread breechblock, while newer guns have sliding wedge breechblocks.

#### GENERAL

Weapon.....	75-mm gun, Model 90 (1930) mobile field.
General Characteristics.....	A long range, light artillery weapon with a high muzzle velocity.
Identification.....	Long barrel weapon equipped with muzzle brake. Tube extends well beyond the end of cradle. Stabilized in action by spade plates.
Organization to Which Issued.....	Pneumatic tired version for motorized units. Artillery wheel version in field artillery units.
Tactical Employment.....	Light artillery, also suitable for antitank fire.

#### FIRING CHARACTERISTICS

Length of Tube.....	112.4 in.; 38.44 calibers.
Muzzle Velocity.....	2,296 f/s.
Maximum Range.....	16,350 yards.
Elevation.....	43°.
Depression.....	-8°.
Traverse.....	25° right, 25° left
Rate of Fire:	
2 minutes.....	15 rpm.
15 minutes.....	4 rpm.
Continuous.....	100-120 rph.
Ammunition.....	HE, APHE, shrapnel, incendiary, smoke, and pointed (for further data, see fig. 86).
Type of Breechblock.....	Horizontal sliding.
Rifling.....	28 grooves.

#### CONSTRUCTION AND MOVEMENT DATA

Weight of Gun:	
Firing.....	3,085.6 lb.
Traveling.....	4,408 lb.
Over-all Length:	
Firing.....	17 ft. 2 in.
Traveling.....	12 ft. 8½ in.
Width:	
Track.....	4 ft. 11 in.
Maximum.....	5 ft. 9 in.
Height.....	5 ft. 5 in.
Road Clearance.....	17 ft. 6 in.
Method of Transport.....	4-ton tractor drawn or horse-drawn—six horses.
Practical Speed on Good Roads.....	Maximum: 24.8 miles per hour. Average: 9.3 miles per hour. 124.2 miles per day.
Time to Emplace.....	2 minutes.
Type of Traverse.....	Pintle.
Wheels and Tires.....	Steel band on artillery wheels and pneumatic tires on disk wheels.
Trail.....	Split with demountable spade plates and fixed trail blocks.
Recoil System:	
Standard.....	35.9 in.-38.2 in.
Maximum.....	41 in.
Type of Recoil System.....	Hydropneumatic, constant
Type Fluid Recoil Cylinder.....	Mineral oil.
Type Fluid Counterrecoil Cylinder.....	2 parts glycerine, 1 part water.
Quantity Fluid Recoil Cylinder.....	3.07 qts.
Quantity Fluid Counterrecoil Cylinder.....	4.03 qts.
Air Pressure Counterrecoil Cylinder.....	596-709.5 lbs./sq. in.

**c. Model 88 (1928) 75-mm AA Gun.** Model 88 (1928) 75-mm AA gun is the standard Japanese mobile antiaircraft artillery weapon. It has been encountered more generally in U. S. campaigns against the Japanese than any other artillery weapon. It has a high velocity which makes it suitable for use against ground targets, especially armor. It has been used both in defense of airfields against ground attack and in a dual-purpose role as an antiaircraft and coast-defense gun. For antitank purposes it has the advantage of all-round traverse and the disadvantage of limited mobility. It thus can be quite effective when fired from ambush against tanks, but it cannot shoot and run.

**GENERAL**

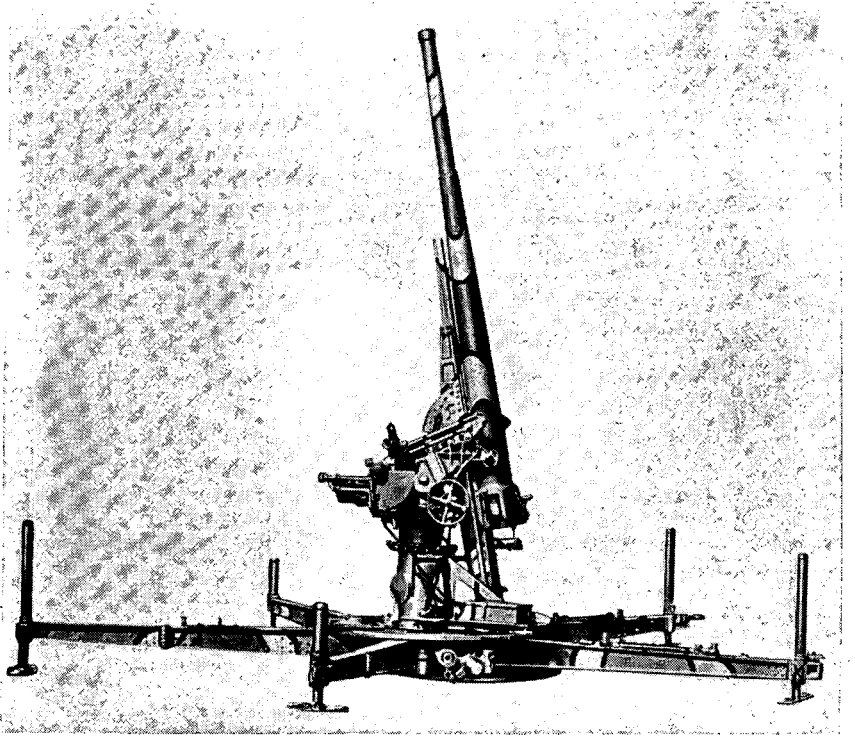
Weapon.....	75-mm AA gun, Model 88 (1928), 7-cm field gun.
General Characteristics.....	Semiautomatic loading and firing.
Identification.....	Five out-riggers. Pedestal mount.
Tactical Employment.....	Ordinarily air defense but also in battle as 4-gun field battery.

**FIRING CHARACTERISTICS.**

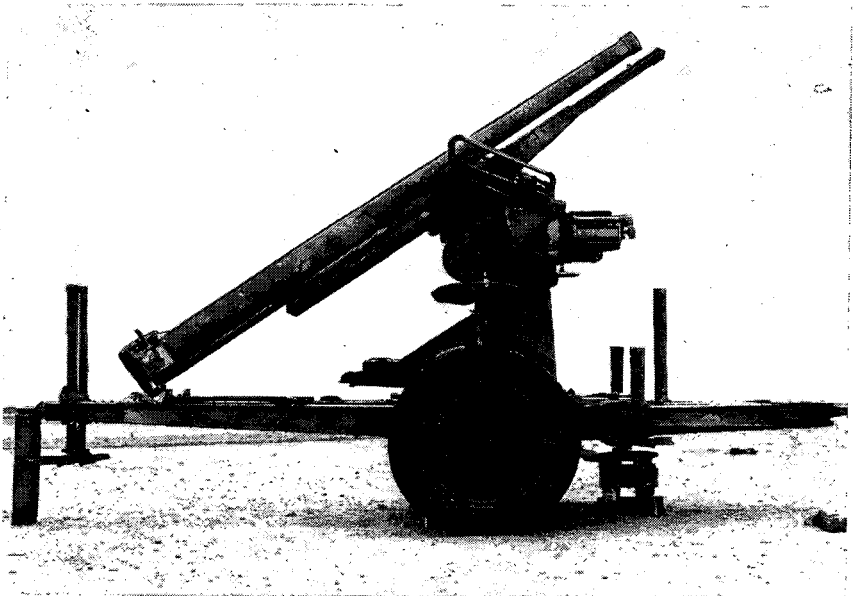
Length of Tube.....	130.5 in.; 44.2 calibers.
Muzzle Velocity.....	2,360 f/s.
Maximum Range.....	29,848 feet (vertical).
Elevation.....	85°.
Depression.....	0°.
Traverse.....	360°, 5 minutes for complete traverse.
Rate of Fire: Maximum.....	15-20 rpm.
Ammunition.....	AA pointed shell, HE, shrapnel, smoke, incendiary, and illuminating (for further data, see fig. 86).
Type of Breechblock.....	Semiautomatic horizontal sliding.
Type of Firing Mechanism.....	Continuous pull percussion (Krupp type).
Rifling.....	28 grooves. 1 turn, 25.6 calibers.
Twist.....	Uniform right hand.
Length.....	101.5 in.

**CONSTRUCTION AND MOVEMENT DATA**

Weight of Gun:	
Firing.....	5,390 lb.
Traveling.....	6,039 lb.
Over-all Length:	
Firing.....	16 ft. 6 in.
Traveling.....	14 ft. 9 in.
Width:	
Track.....	5 ft. 3 in.
Maximum.....	6 ft. 4 in.
Height.....	6 ft. 7 in.
Road Clearance.....	1 ft. 2 in.
Method of Transport.....	Tractor-drawn or 6-by-6 truck with winch.
Practical Speed on Good Roads.....	Maximum: 12 miles per hr. Normal: 3 miles per hr.
Type of Equilibrator.....	Spring cable.
Type of Brakes.....	Hand.
Wheels and Tires.....	36 by 6, 90 pounds pressure, rubber.
Trail.....	5 out-riggers with jacks for leveling.
Recoil System:	
Standard.....	At 0° 54.6 in.; from 50°-85°, 23.4 in.
Maximum.....	60.5 in.
Type of Recoil System.....	Hydropneumatic, variable.
Type Fluid Recoil Cylinder.....	Light fluid lubricating oil.
Type Fluid Counterrecoil Cylinder.....	Light fluid lubricating oil.
Quantity Fluid Recoil Cylinder.....	4 qt.
Air Pressure Counterrecoil Cylinder.....	830.1-1,419 lb./sq in.



*Figure 17. Model 88 (1928) 75-mm AA gun, emplaced.*



*Figure 18. Model 88 (1928) 75-mm AA gun in traveling position.*

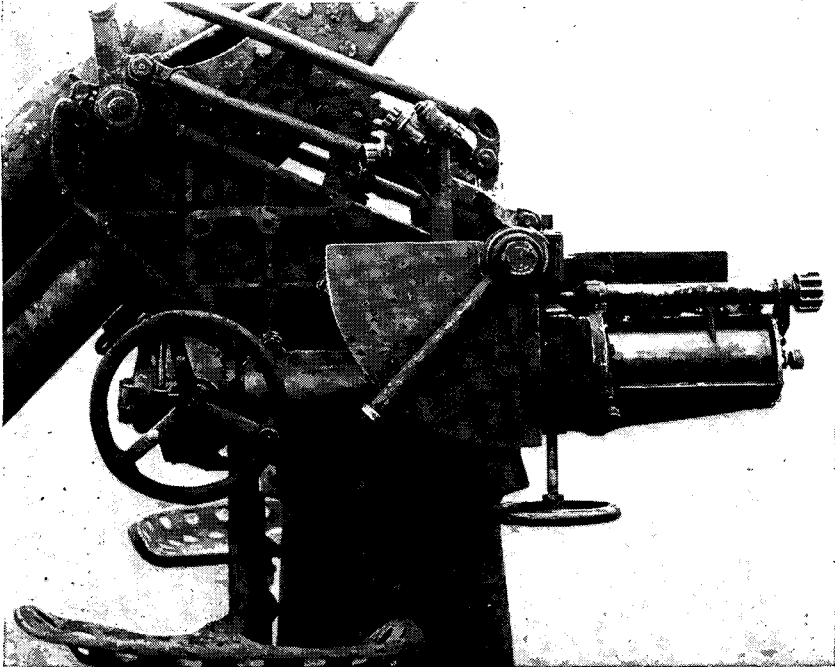


Figure 19. Model 88 (1928) 75-mm AA gun, right side: Azimuth fan-shaped plate with altitude pointer arm; and (right) lateral deflection drum and pointer. The large handwheel (placed vertically) is the traversing handwheel; the other (horizontal) handwheel is the fuze setting handwheel.

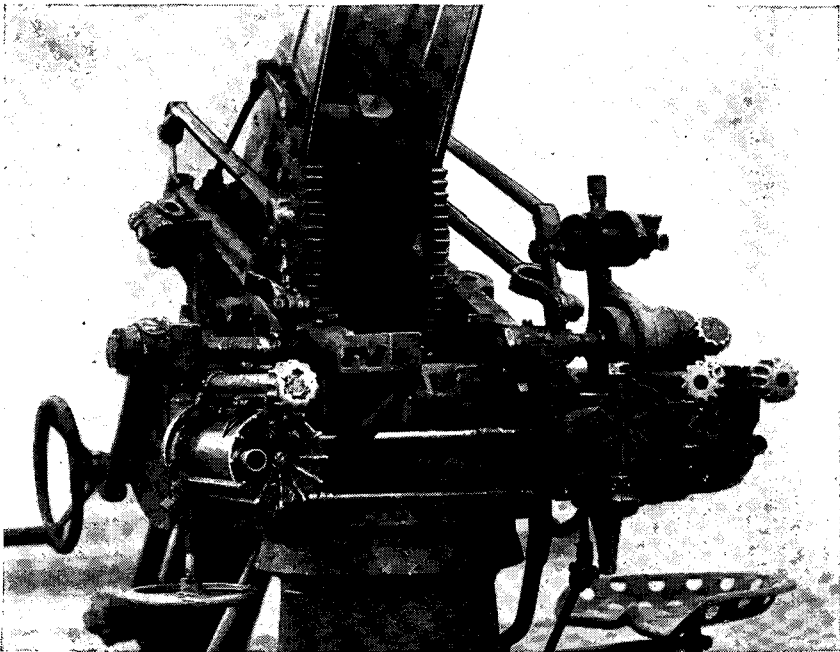


Figure 20. Model 88 (1928) 75-mm AA gun: front view of elevating and traversing gear.

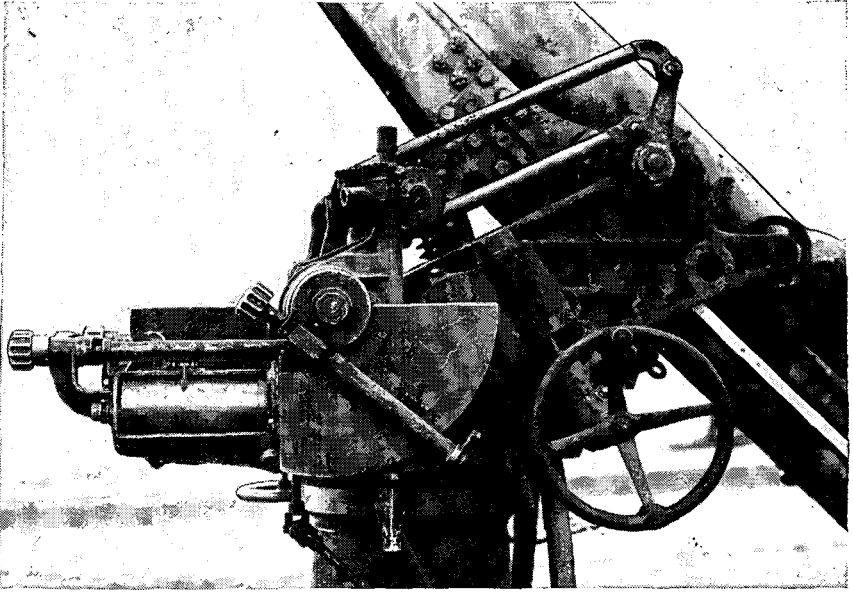


Figure 21. Model 88 (1928) 75-mm AA gun, left side: Elevation fan-shaped plate with altitude pointer arm and pointer; and (left) vertical deflection drum and course angle pointer.

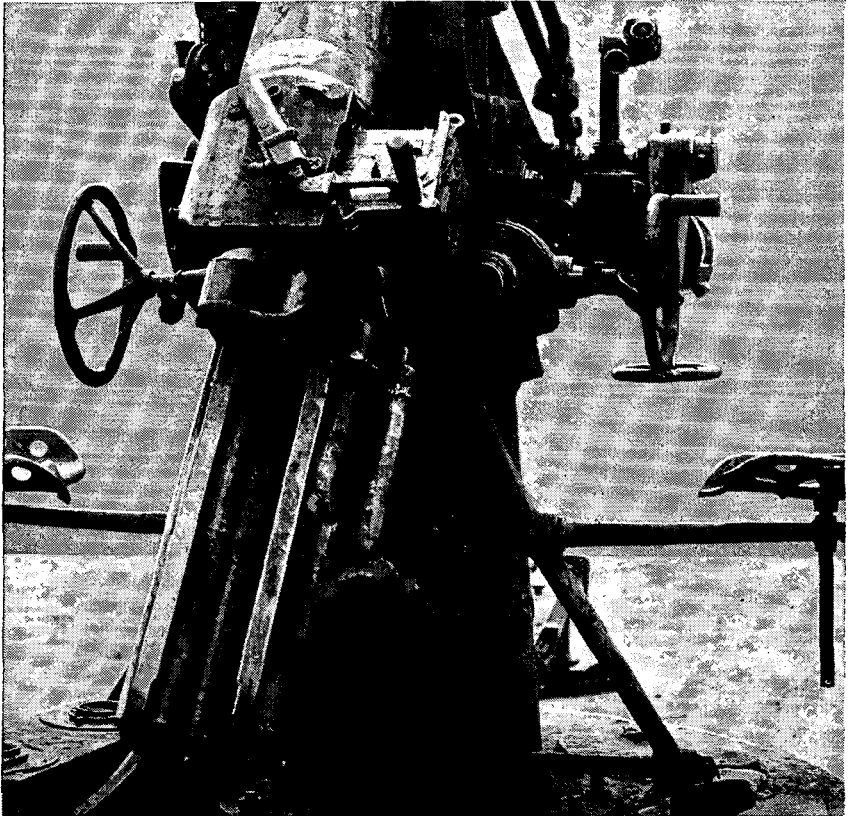


Figure 22. Model 88 (1928) 75-mm AA gun, breech detail.



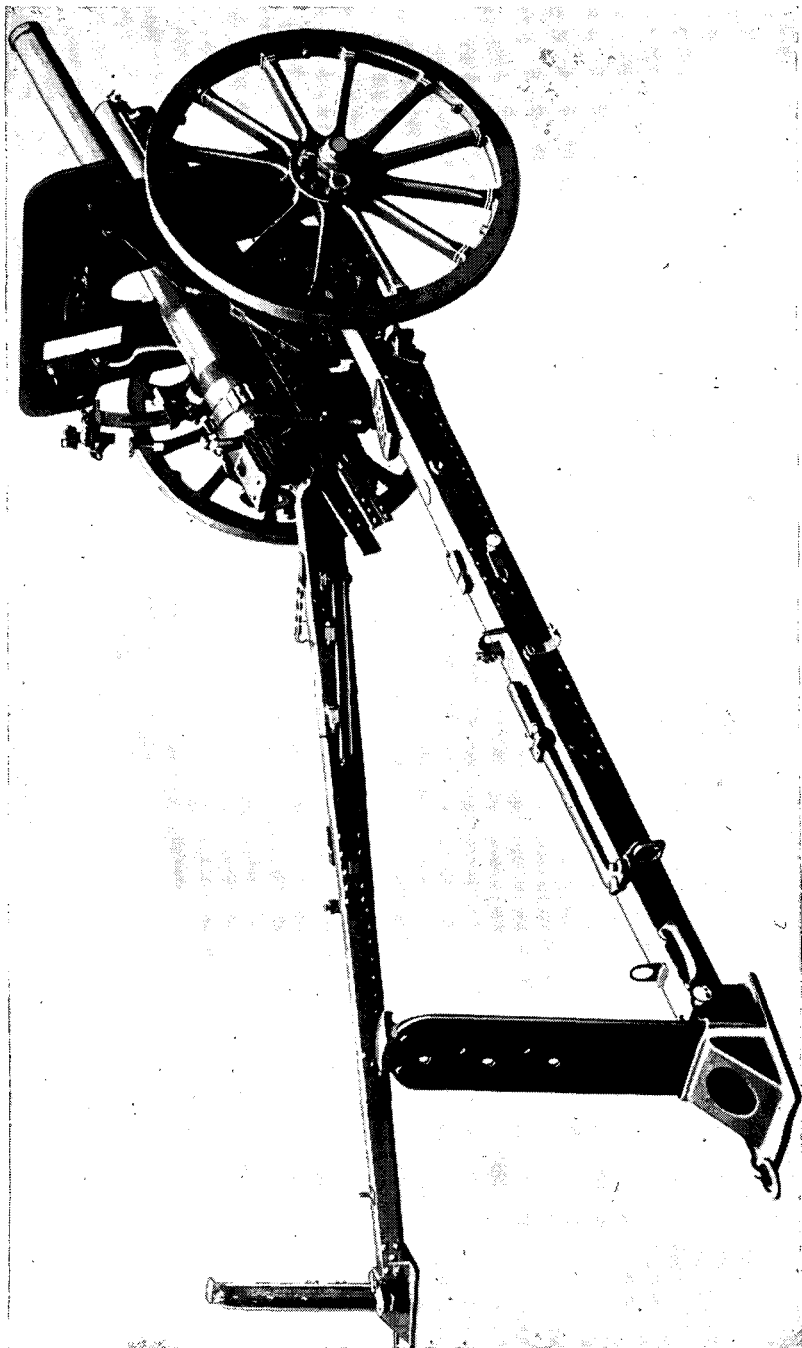


Figure 23. Model 94 (1934) 75-mm mountain gun, right side.

**d. Model 94 (1934) 75-mm Mountain Gun.** Model 94 (1934) 75-mm mountain gun has replaced the Model 41 (1908) 75-mm mountain gun as the standard weapon of the pack artillery. For so light a weapon, it embodies a remarkable number of modern construction features. It has a Schneider type, hydropneumatic independent recoil system, a Krupp type horizontal sliding-wedge breechblock, split trails with spade plates for stabilizers, pintle traverse, and an equalizing arrangement which gives it three-point suspension. Since it is trunnioned at the center of balance, it does not require equilibrators. It can be fired with trails closed or open.

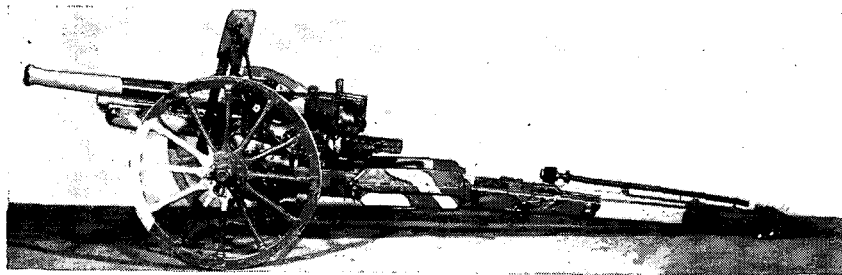
The gun can be rapidly disassembled for packing and can be packed by animals or men. It is reported that it can be assembled in about 10 minutes and disassembled in from 3 to 5 minutes. At night, after the parts are rubbed with luminous bark, the same operations can be performed, although 5 to 10 minutes longer are required. Using lifting bars and ropes, 18 men can carry the entire weapon. On Bougainville, however, 41 men were assigned to carry each gun, doubtless because of the extremely difficult terrain. It fires the same projectiles as other 75-mm pieces and has a cartridge case identical in length with that used in the Model 38. This case is longer than that used in the Model 41 mountain gun. This is necessary because the propelling charge used in Model 94 ammunition is less than that used in the ammunition for Model 38, and firing the latter ammunition from Model 94 would damage the gun. Lack of a howitzer trajectory and of varying charges increases the dead space for the Model 94 when it fires in mountainous terrain, and the counterrecoil is said to be so slow when the piece is fired at elevations above 30° that, rather than fire above that elevation, the battery displaces forward.

#### GENERAL

Weapon.....	75-mm, Model 94 (1934), mountain (pack) gun.
General characteristics.....	Light, highly mobile pack artillery weapon suitable for horse draft or motor draft as well.
Identification.....	Low silhouette, demountable spade plates, very long trails in proportion to tube length.
Organization to Which Issued.....	Pack artillery units attached or organic to infantry divisions.
Tactical Employment.....	Furnishes artillery support in terrain where heavier weapons cannot go.

#### FIRING CHARACTERISTICS

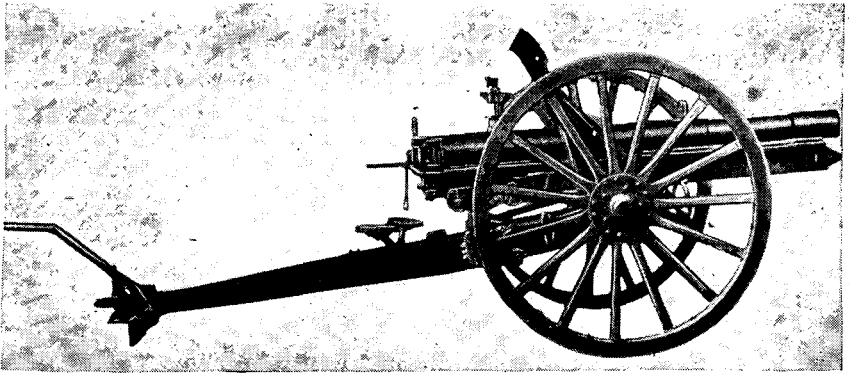
Length of Tube.....	61.5 in. 20.8 calibers.
Muzzle Velocity.....	Pointed Shell: 1,285.8 f/s. Shrapnel Shell: 1,165.4 f/s.
Maximum Range.....	Pointed Shell: 8,938 yards (9,400). HE Shell: 7,957 yards.
Elevation.....	45°.
Depression.....	—10°.
Traverse.....	20° right, 20° left.
Rate of Fire:	
2 minutes.....	15 rpm.
15 minutes.....	4 rpm.
Continuous.....	100–120 rph.
Ammunition.....	HE, APHE, shrapnel, incendiary, illuminating, and pointed (for further data, see fig. 86).
Type of Breechblock.....	Horizontal sliding.
Type of Firing Mechanism.....	Continuous pull percussion (Krupp type).
Rifling.....	28 grooves.
Twist.....	Uniform right hand, 1 turn, 22½ calibers.
Length.....	39.25 in.



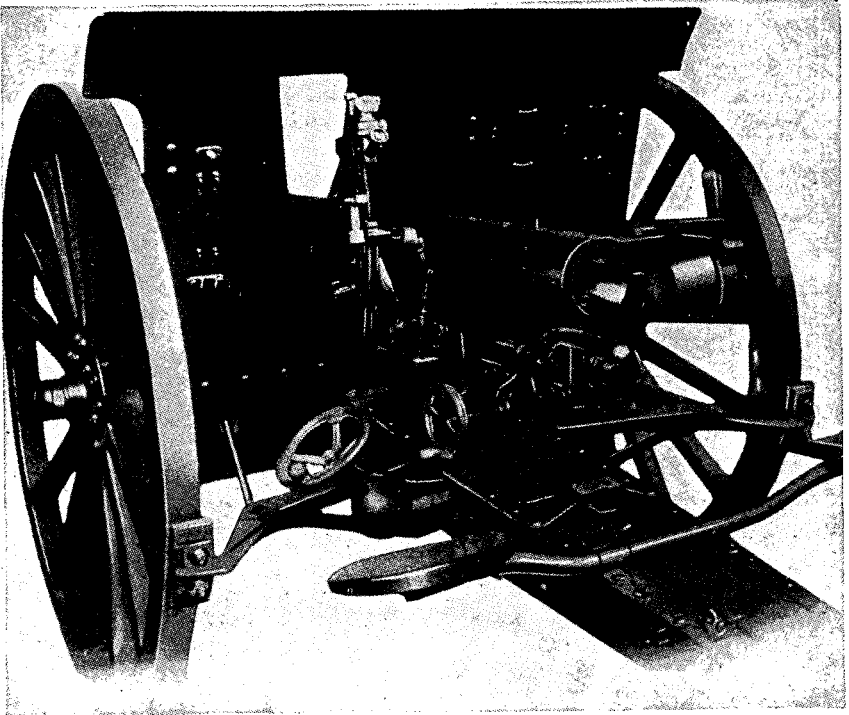
*Figure 24. Model 94 (1934) 75-mm mountain gun, left side.*



*Figure 25. Model 94 (1934) 75-mm guns in action in China.*



*Figure 26. Model 41 (1908) 75-mm cavalry gun.*



*Figure 27. Model 41 (1908) 75-mm cavalry gun, rear view.*

## CONSTRUCTION AND MOVEMENT DATA

<b>Weight of Gun:</b>	
Firing.....	1,181.3 lb.
Traveling.....	1,091 lb. (horse or motor draft).
<b>Weight of Assemblies:</b>	
Tube.....	206 lb.
Cradle.....	207 lb.
Left Trail.....	138 lb.
Right Trail.....	131 lb.
Wheels.....	152 lb.
Sight Bracket.....	10 lb.
Breech.....	82 lb.
<b>Over-all Length:</b>	
Firing.....	12 ft. 6 in. (trails open) 12 ft. 9 in. (trails closed).
Traveling.....	13 ft.
<b>Width:</b>	
Track.....	3 ft. 4 in.
Maximum.....	4 ft. 5 in.
Height.....	2 ft. 11 in.
Road Clearance.....	10.14 in.
Method of Transport.....	Horse-drawn, motor-drawn, 6-horse pack. This piece can also be manhandled easily by 3 men.
Practical Speed on Good Roads.....	Pack: 12.4-15.5 miles per day. 1-2 horse draft: 24.8-31 miles per day. Man-pack: 327-1,090 yards per hour.
Time to Emplace.....	Approximately 5 minutes to unpack and assemble. 2 minutes when horse-drawn.
Type of Traverse.....	Pintle.
Type of Equilibrator.....	None.
Type of Brakes.....	None.
Wheels and Tires.....	Steel band tires on spoked wheels.
Trail.....	Split with demountable spade plates, and fixed trail blocks.
<b>Recoil System:</b>	
Standard.....	33.1-34.3 in.
Maximum.....	35.9 in.
Type of Recoil System.....	Hydropneumatic, constant, independent.
Type Fluid Recoil Cylinder.....	Light machine oil.
Type Fluid Counterrecoil Cylinder.....	2 parts glycerine, 1 part water.
Quantity Fluid Recoil Cylinder.....	2.5 qt.
Quantity Fluid Counterrecoil Cylinder.....	1 qt.
Air Pressure Counterrecoil Cylinder.....	567.6 lb./sq. in.

**e. Model 41 (1908) 75-mm Cavalry Gun.** This Schneider type gun was especially constructed to give artillery support to cavalry regiments. Its design is almost identical with that of the original Model 38 75-mm gun. It is somewhat lighter than the Model 38 improved 75-mm gun, the corresponding direct-support artillery in the infantry division. Since no Japanese cavalry brigades have yet been in combat against U. S. forces, it is not certain whether this old-fashioned gun with unmodified box trails and hydrospring recoil remains in general use or has been superseded by a more modern weapon. It can readily be differentiated from the Model 38 75-mm gun by its interrupted thread breechblock.

### GENERAL

Weapon.....	75-mm, Model 41 (1908) cavalry gun.
Organization to Which Issued.....	Cavalry brigades.
Tactical Employment.....	Cavalry support.

### FIRING CHARACTERISTICS

Length of Tube.....	85.6 in.; 29.27 calibers.
Muzzle Velocity.....	1,672.8 f/s.
Maximum Range.....	HE (?) Shell: 9,265 yards. Pointed (?) Shell: 11,990 yards.
Elevation.....	16° 30'.
Depression.....	—8°.
Traverse.....	6° right, 6° left.
Rate of Fire: Maximum.....	8 rpm.

Ammunition.....	HE, APHE, shrapnel, pointed, incendiary, smoke, and illuminating (for further data, see fig. 86).
<b>CONSTRUCTION AND MOVEMENT DATA</b>	
Weight of Gun:	
Firing.....	2,018.9 lb.
Traveling.....	3,306 lb.
Over-all Length:	
Firing.....	14 ft. 5 in.
Traveling.....	26 ft. 5 in.
Width:	
Track.....	4 ft. 6 in.
Maximum.....	5 ft. 2 in.
Height.....	5 ft. 2 in.
Road Clearance.....	16.4 in.
Method of Transport.....	Horse-drawn—six horses.
Practical Speed on Good Roads.....	4.35–4.97 miles per hour.
Time to Emplace.....	2 minutes (estimated).
Type of Traverse.....	Axle.
Trail.....	Plain box.
Recoil System:	
Standard.....	46.8–48.8 in.
Maximum.....	52.5 in.
Type of Recoil System.....	Hydrospring.
Quantity Fluid Recoil Cylinder.....	4.7 qt.

**f. Model 95 (1935) 75-mm Gun.** The Model 95 75-mm gun has an appearance similar to the Model 90 75-mm gun. It is derived from the Model 1933 Schneider 75, which it closely resembles. Since it weighs only 400 pounds more than the Model 41 cavalry gun, it is possible that the Model 95 may be intended to replace that weapon. However, its use on Saipan and its close resemblance to the heavier Model 90 may indicate that the latter weapon is too heavy for efficient horse-draft, and too complex for the capabilities of Japanese industry. Though the Model 95 is split-trailed, it weighs actually less than the improved Model 38 75-mm gun. The Model 95 is much lighter than its Schneider prototype, and has a sliding wedge rather than an interrupted thread breechblock. It incorporates all features of modern Japanese design.

#### GENERAL

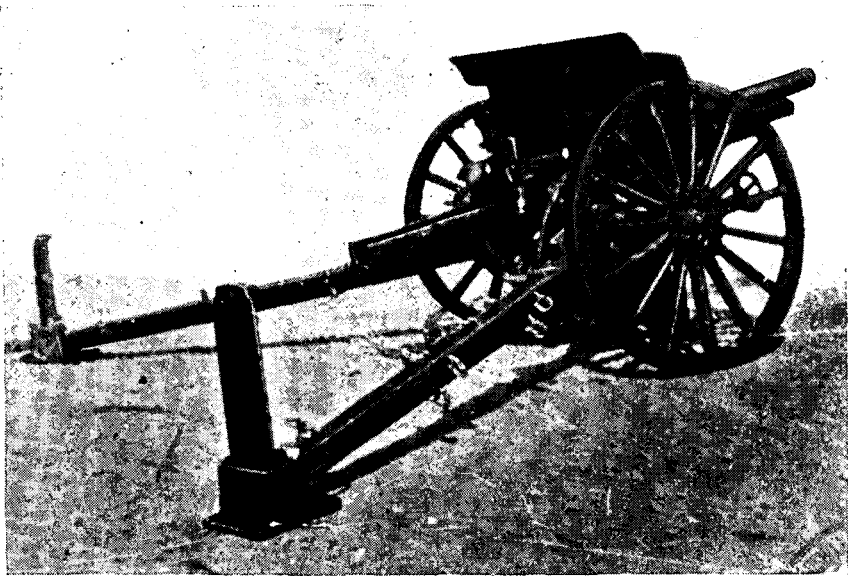
Weapon.....	75-mm, Model 95 (1935) field gun.
Organization to Which Issued.....	Possible replacement for Model 41 (1908) cavalry gun in cavalry unit artillery.

#### FIRING CHARACTERISTICS

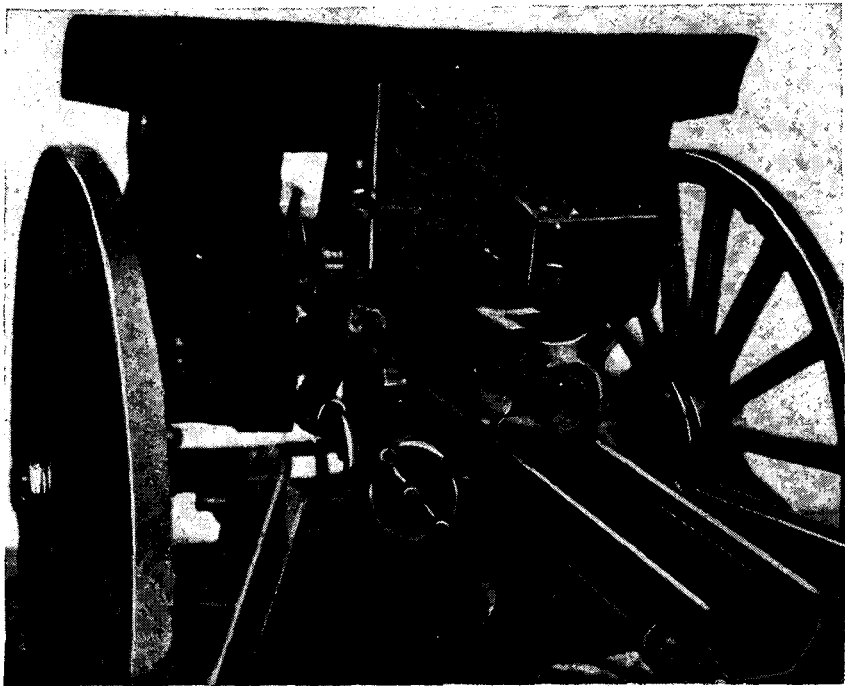
Length of Tube.....	89.7 in.; 30.67 calibers.
Muzzle Velocity.....	1,640 f/s.
Maximum Range.....	Pointed (?): 11,990 yards. HE (?) Shell: 9,810 yards.
Elevation.....	43°.
Depression.....	—8°.
Traverse.....	25° right, 25° left.
Rate of Fire: Maximum.....	10–12 rpm.
Ammunition.....	HE, APHE, shrapnel, smoke, incendiary, illuminating, and pointed (for further data, see fig. 86).
Type of Breechblock.....	Horizontal sliding.

#### CONSTRUCTION AND MOVEMENT DATA

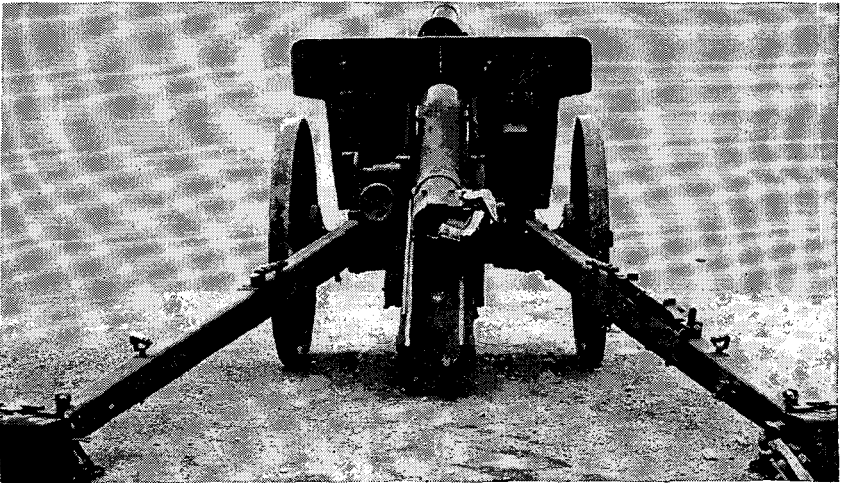
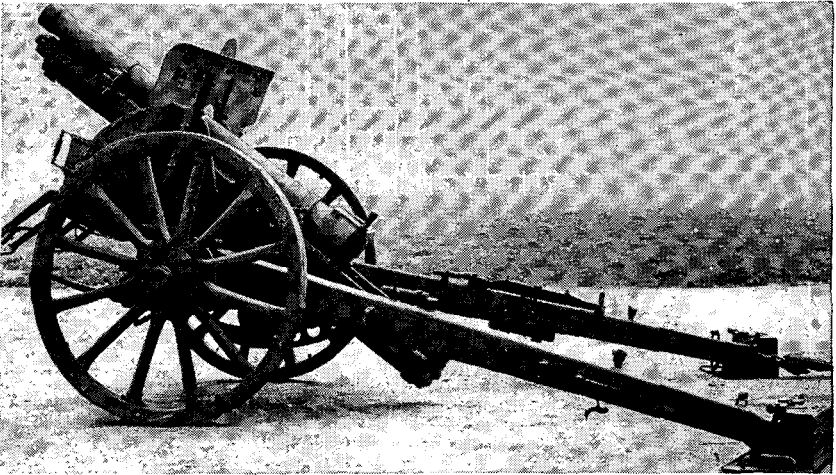
Weight of Gun:	
Firing.....	2,437.6 lb.
Traveling.....	4,252.6 lb.
Over-all Length:	
Firing.....	14 ft. 8 in.
Traveling.....	29 ft. 1 in.
Width:	
Track.....	4 ft. 11 in.
Maximum.....	5 ft. 10 in.



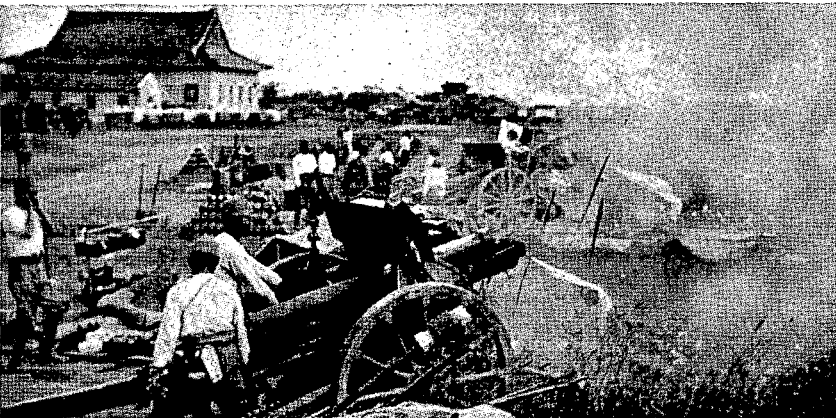
*Figure 28. Model 95 (1935) 75-mm gun.*



*Figure 29. Breech of Model 95 (1935) 75-mm gun.*



*Figure 30. Above—Model 91 (1931) 105-mm howitzer. Below—rear view.*



*Figure 31. Model 91 (1931) 105-mm howitzer battery in action in China.*



Height.....	5 ft. 3 in.
Road Clearance.....	14.2 in.
Method of Transport.....	Horse-drawn—six horses.
Practical Speed on Good Roads.....	31.1 miles per day.
Type of Traverse.....	Pintle.
Trail.....	Split, demountable spade plates fixed trail blocks.
Recoil System:	
Standard.....	46.8 in.
Maximum.....	48.7 in.
Type of Recoil System.....	Hydropneumatic, constant.
Quantity Fluid Recoil Cylinder.....	1.4 qt.
Quantity Fluid Counterrecoil Cylinder.....	3.1 qt.
Air Pressure Counterrecoil Cylinder.....	568 lb./sq. in.

**g. Model 91 (1931) 105-mm Howitzer.** For a weapon of modern design the Model 91 (1931) 105-mm howitzer is by U. S. standards an extremely crude-looking piece. It is much smaller and lighter than the German and U. S. howitzers of the same caliber, weighing even less than the standard 75-mm guns used in Europe in World War I. Despite its lightness and its appearance of not having been quite finished, it is capable of throwing a 35-pound shell very nearly as far as can the heavier and far more formidable looking German 105-mm howitzer.

#### GENERAL

Weapon.....	105-mm howitzer, Model 91 (1931), 10-cm.
General Characteristics.....	A standard 105-mm artillery piece of extremely light construction relative to range and weight of projector.
Identification.....	Demountable spade plates, long cradle extending almost to muzzle end of tube.
Organization to Which Issued.....	Division artillery.
Tactical Employment.....	Used on targets difficult for field guns to reach, such as defiladed machine gun positions.

#### FIRING CHARACTERISTICS

Length of Tube.....	8 ft. 4 in.; 24 calibers.
Muzzle Velocity.....	1,790 f/s.
Maximum Range.....	Charge 1: 11,772 yards. Charge 2: 8,502 yards. Charge 3: 6,322 yards. Charge 4: 5,123 yards.
Elevation.....	45°.
Depression.....	—5°.
Traverse.....	20° right, 20° left.
Rate of Fire:	
Maximum.....	6-8 rpm.
15 Minutes.....	2 rpm.
Continuous.....	50-60 rph.
Ammunition.....	HE, APHE, pointed, shrapnel, incendiary (for further data, see fig. 87).
Type of Breechblock.....	Interrupted screw.
Type of Firing Mechanism.....	Percussion hammer.

[Note unusual Japanese charge-numbering system.]

#### CONSTRUCTION AND MOVEMENT DATA

Weight of Gun:	
Firing.....	3,306 lb.
Traveling.....	4,363.9 lb.
Over-all Length:	
Firing.....	15 ft. 6 in.
Traveling.....	29 ft. 4 in.
Width:	
Track.....	5 ft. 2 in.
Maximum.....	6 ft. $\frac{1}{2}$ in.
Height.....	5 ft. 8 in.
Road Clearance.....	1 ft. 3 in.
Method of Transport.....	Horse-drawn—6 horses.
Practical Speed on Good Roads.....	24.8 miles per day except on bad roads.
Time to Emplace.....	3 minutes.
Type of Traverse.....	Pintle.

Type of Equilibrator.....	Spring (?).
Type of Brakes.....	Foot operated brake with pedal below traveling seat in front of shield.
Wheels and Tires.....	Steel tires on artillery wheels.
Trail.....	Split trail, demountable spade plates, trail blocks integral to trails.
Recoil System:	
Standard.....	42.9-45.6 in.
Maximum.....	46.8 in.
Type of Recoil System.....	Hydropneumatic.
Quantity Fluid Recoil Cylinder.....	4.6 qt.
Quantity Fluid Counterrecoil Cylinder.....	4.4 qt.
Air Pressure Counterrecoil Cylinder.....	610.6-639 lb./sq. in.

**h. Model 14 (1925) 105-mm Gun.** Model 14 (1925) 105-mm gun was designed to replace the Model 38 (1905) 105-mm gun. It had a longer range and was the first Japanese artillery piece with split trails. It appears, however, that it was unsatisfactory for the uses to which the Japanese intended to put it, for in 1932 a new 105-mm gun was introduced. As far as is known, only 64 of the 1925 Model guns were produced before they were discontinued in favor of the new design.

#### GENERAL

Weapon.....	105-mm, Model 14 (1925), 14th year type, 10-cm cannon.
Identification.....	Built-up tube construction, curved shield top, cylindrical recoil mechanism visible beneath tube.
Organization to Which Issued.....	Army artillery.
Tactical Employment.....	Counterbattery long range.

#### FIRING CHARACTERISTICS

Length of Tube.....	140 in.; 34.19 calibers.
Muzzle Velocity.....	2,033.6 f/s.
Maximum Range.....	14,497 yards.
Elevation.....	33°.
Depression.....	-5°.
Traverse.....	15° right, 15° left.
Rate of Fire: Maximum.....	6-8 rpm.
Ammunition.....	HE, APHE, shrapnel, pointed, incendiary, smoke. Separate loading cartridge case obturation (for further data, see fig. 87).
Type of Breechblock.....	Interrupted screw.

#### CONSTRUCTION AND MOVEMENT DATA

Weight of Gun:	
Firing.....	6,865 lb.
Traveling.....	8,221 lb.
Over-all Length:	
Firing.....	21 ft. 3 in.
Traveling.....	26 ft. 10 in.
Width:	
Track.....	4 ft. 11 in.
Maximum.....	6 ft. 4½ in.
Height.....	5 ft. 9 in.
Road Clearance.....	14 in.
Method of Transport.....	Horse-draft-8 horses and tractor-drawn.
Type of Traverse.....	Pintle.
Wheels and Tires.....	Steel tires on artillery wheels.
Trail.....	Split with integral spades.
Recoil System:	
Standard.....	29.3-58.5 in.
Maximum.....	60 in.
Type of Recoil System.....	Hydropneumatic, variable.
Quantity Fluid Recoil Cylinder.....	8 qt.
Air Pressure Counterrecoil Cylinder.....	1,278 lb./sq. in.

**i. Model 92 (1932) 105-mm Gun.** This piece appears to have almost completely replaced the Model 14 (1925) 105-mm gun. It has all the

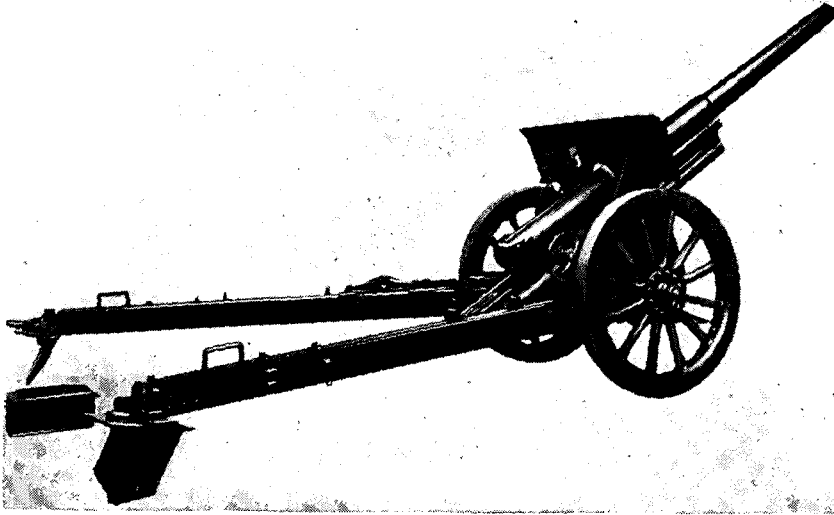


Figure 32. Model 14 (1925) 105-mm gun.

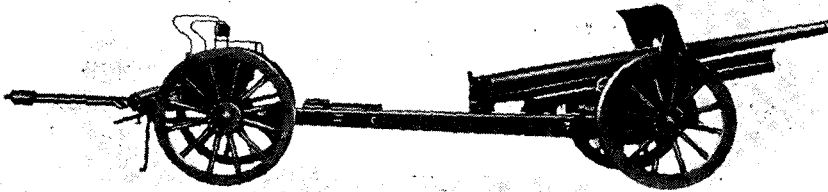


Figure 33. Model 14 (1925) 105-mm gun, limbered.

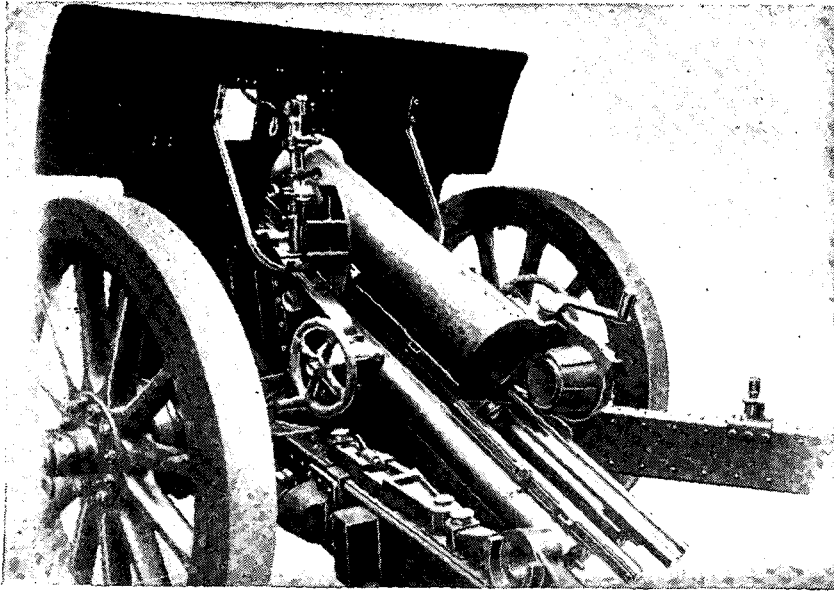


Figure 34. Breech of Model 14 (1925) 105-mm gun.



*Figure 35. Battery of Model 14 (1925) 105-mm guns emplaced.*

standard features of the 1930-36 period of Japanese gun design. Its long barrel, short cradle, long trails, and relatively low silhouette gives it the most graceful appearance of any Japanese artillery piece. In traveling position the tube is retracted by means of a winch and locked to the cradle. The most remarkable fact about the Model 92, aside from its appearance, is the great range that it attains with a 35-pound shell in proportion to its unusually low weight. It has been reported that the weapon is rarely fired at extreme ranges, which require the use of a supercharge, because of malfunctions in the recoil system caused thereby. Some years ago troubles with the recoil system were so frequent that extra glands and packing for the recoil cylinders were carried in the firing battery, and replacing them was equivalent to first-echelon maintenance in U. S. practice. Difficulties were also reported when the weapon was fired at or near the limits of traverse. Whether this was due to a unique "bug" in the design of the Model 92 or was inherent in the use of spade-plate stabilization is not known. The Model 92 is stabilized by three spade plates for each trail. Both spade plates and trail blocks are demountable.

#### GENERAL

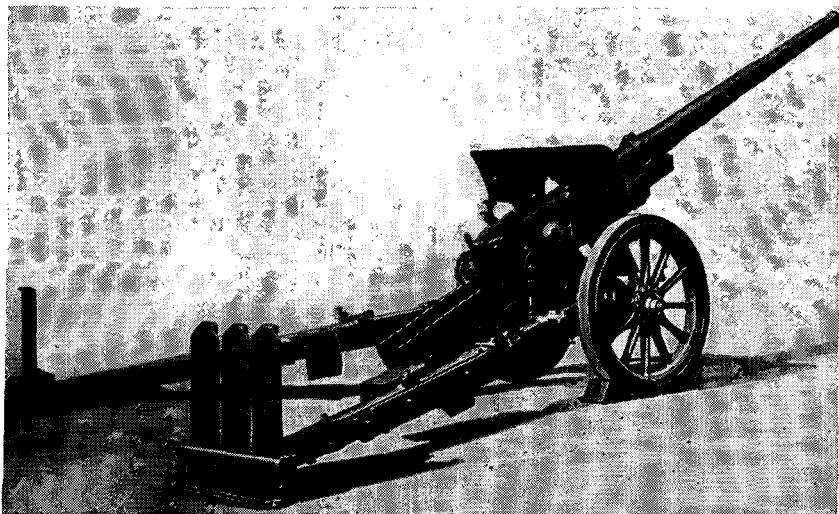
Weapon.....	105-mm gun, Model 92 (1932), 10-cm cannon.
General Characteristics.....	A medium gun with extremely long range.
Identification.....	Extremely long tube extending several feet beyond end of cradle. Generally long, graceful lines. Three spade plates at the end of each trail for stabilizing during firing.
Organization to Which Issued.....	Army artillery.
Tactical Employment.....	Counterbattery at long ranges.

#### FIRING CHARACTERISTICS

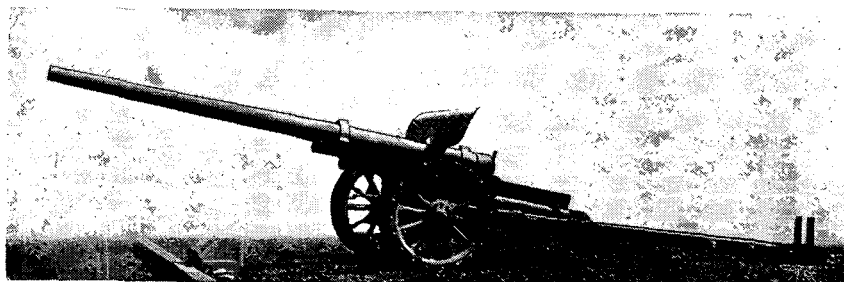
Length of Tube.....	184.3 in.; 45 calibers.
Muzzle Velocity.....	2,492.8 f/s.
Maximum Range.....	Pointed Shell: 20,000 yards. HE Shell: 14,800 yards.
Elevation.....	45°.
Depression.....	-5°.
Traverse.....	18° right, 18° left.
Rate of Fire:	
Maximum.....	6-8 rpm.
15 minutes.....	2 rpm.
Continuous.....	50-60 rph.
Ammunition.....	HE, APHE, pointed, incendiary, and shrapnel; separate loading cartridge case obturation (for further data, see fig. 87).
Type of Breechblock.....	Stage interrupted screw.
Type of Firing Mechanism.....	Continuous pull percussion.
Rifling.....	32 grooves. Uniform right-hand twist.

#### CONSTRUCTION AND MOVEMENT DATA

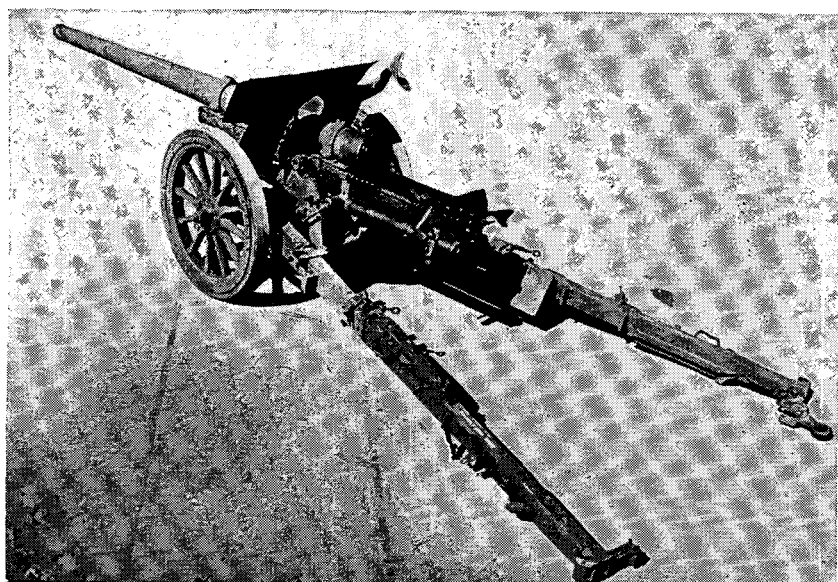
Weight of Gun:	
Firing.....	8,220.9 lb.
Traveling.....	9,620.5 lb.
Over-all Length:	
Firing.....	26 ft.
Traveling.....	32 ft. 1 in.
Width:	
Track.....	4 ft. 11 in.
Maximum.....	6 ft. 2 in.
Height.....	5 ft. 11 in.
Road Clearance.....	14.04 in.
Method of Transport.....	5-ton tractor-drawn.
Practical Speed on Good Roads.....	8.7 miles per hour. 49.7-62.1 miles per day.
Time to Emplace.....	5 minutes.
Type of Traverse.....	Pintle.



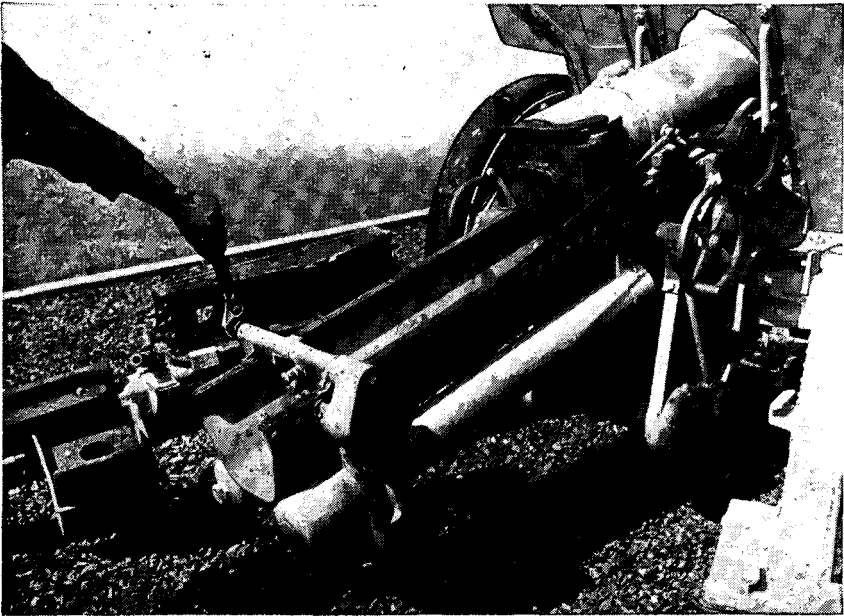
*Figure 36. Model 92 (1932) 105-mm gun, right side.*



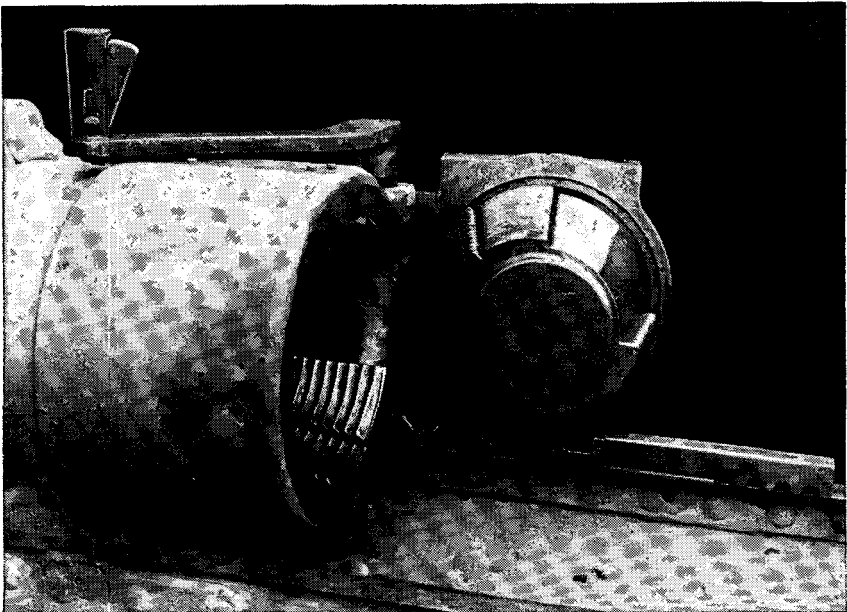
*Figure 37. Model 92 (1932) 105-mm gun, front three-quarters.*



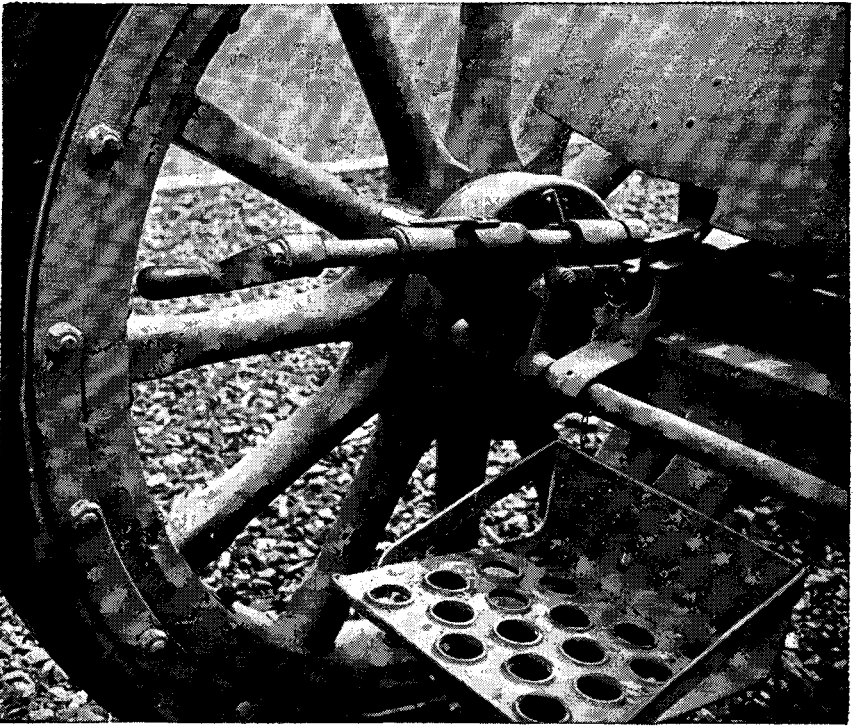
*Figure 38. Model 92 (1932) 105-mm gun, left side.*



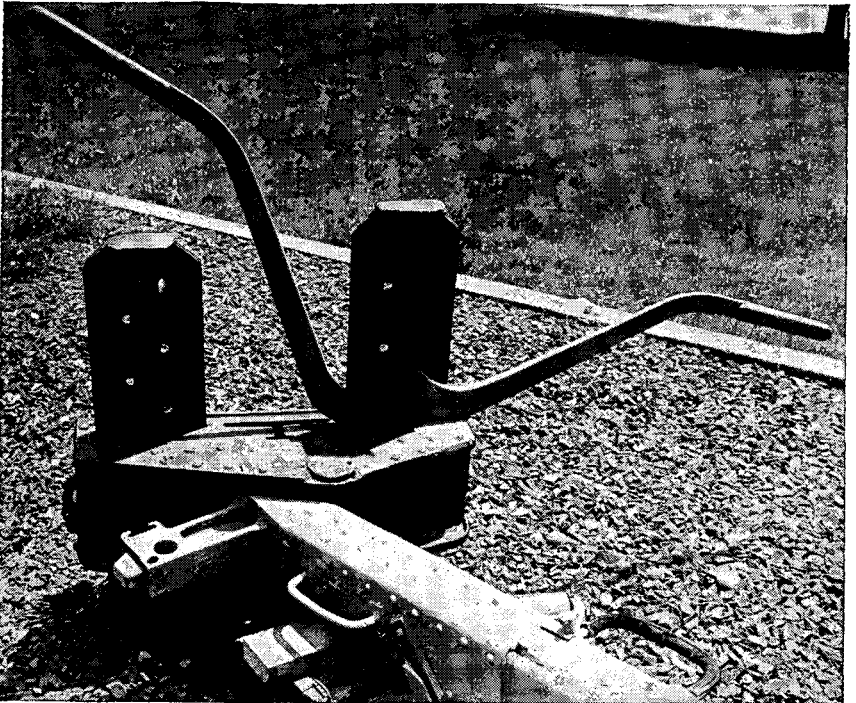
*Figure 39. Model 92 (1932) 105-mm gun: winch in position on cradle. This winch is used to bring the piece into battery from traveling position, or to draw the tube into traveling position from battery (as above).*



*Figure 40. Breech of Model 92 (1932) 105-mm gun.*

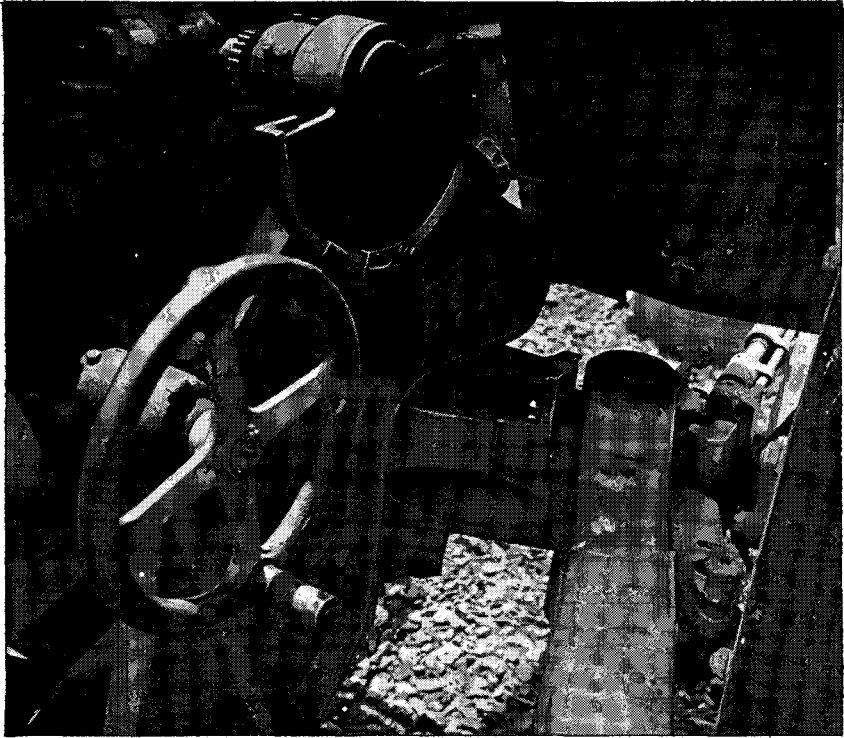


*Figure 41. Model 92 (1932) 105-mm gun: wheel brake lever.*

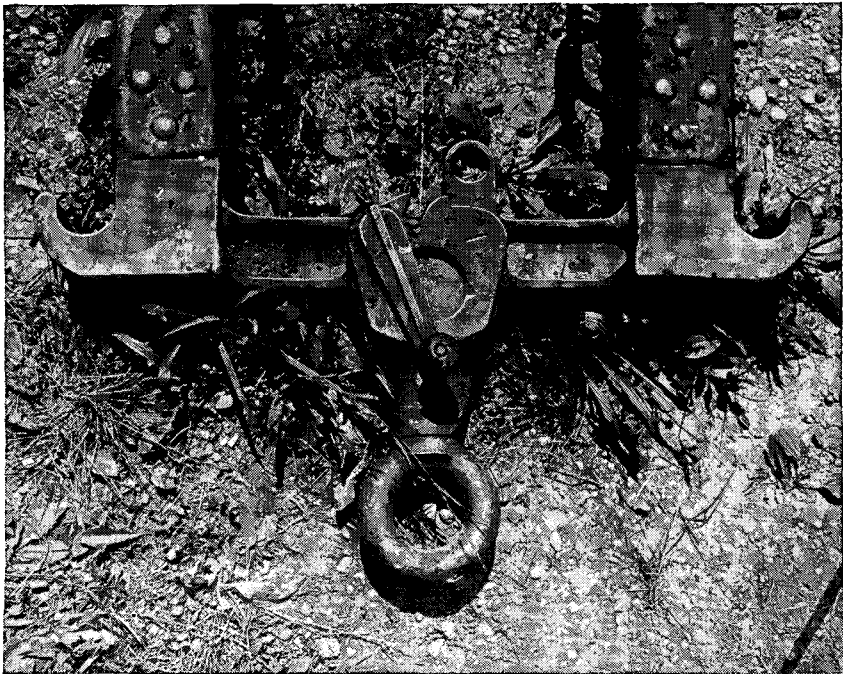


*Figure 42. Model 92 (1932) 105-mm gun: two trail plates driven into ground, with trail plate removing levers (carried on back of gun shield) in position.*





*Figure 43. Model 92 (1932) 105-mm gun: detail of right side, showing elevating handwheel and trail.*



*Figure 44. Trail ends in traveling position, with lock closed.*

Type of Equilibrator.....	Spring equilibrator in cylinders on cradle.
Type of Brakes.....	Hand-operated internal expansion.
Wheels and Tires.....	Solid rubber tires on wooden wheels.
Trail.....	Split 3 demountable spade plates and demountable trail blocks on each trail; wheel chocks carried in traveling in metal pockets inside trails.
Recoil System:	
Standard.....	39 in.
Maximum.....	41 in.
Type of Recoil System.....	Hydropneumatic, constant.
Quantity Fluid Recoil Cylinder.....	5.3 qt.
Quantity Fluid Counterrecoil Cylinder.....	7.4 qt.
Air Pressure Counterrecoil Cylinder.....	639-710 lb./sq. in.

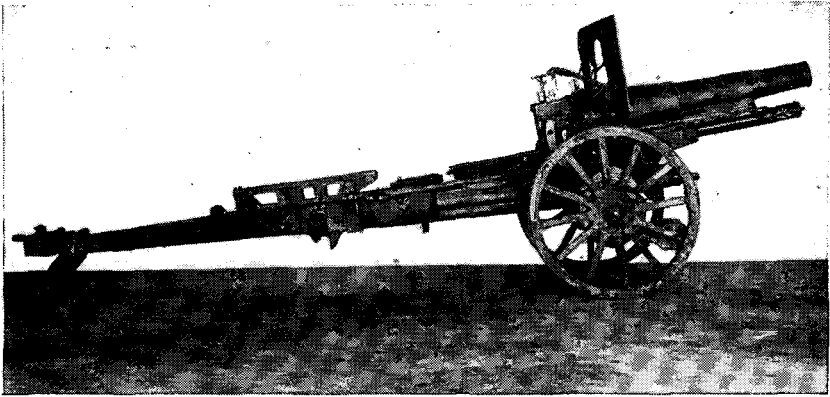
**j. Model 4 (1915) 150-mm Howitzer.** Model 4 (1915) 150-mm howitzer was designed during World War I to replace the Model 38 (1905) 150-mm howitzer. It was manufactured in considerable quantities and remained the standard Japanese medium artillery piece until 1936. It still has by no means been completely superseded, and has been encountered during the present war on many fronts. Its most remarkable characteristic is its extreme lightness in relation to the weight of the ammunition it fires. The howitzer is broken down into two loads—the tube and the cradle assembly—for travel. This operation increases the time necessary to emplace it, but in areas where bridges are flimsy or nonexistent, two-load draft considerably increases the mobility of the piece. Although it is possible to tow the Model 4 in one load, it is not safe to do this for considerable distances or over bad roads because of the extreme length of the trail which would be likely to break if subjected to any considerable jolting. The Model 4 is the first Japanese weapon to replace the hydrospring recoil system with the hydropneumatic. Its modified box trail allows it to fire at extreme elevations, increasing its usefulness in jungle or rugged terrain.

#### GENERAL

Weapon.....	150-mm (149.1-mm) howitzer, Model 4 (1915), 4th year type, 15-cm.
General Characteristics.....	A light weight, medium artillery weapon that breaks into two loads, suitable for transportation in areas of poor roads and light bridges.
Identification.....	Long recoil cylinder, extending to the end of the muzzle. Long open box trail. Short tube.
Tactical Employment.....	General support.

#### FIRING CHARACTERISTICS

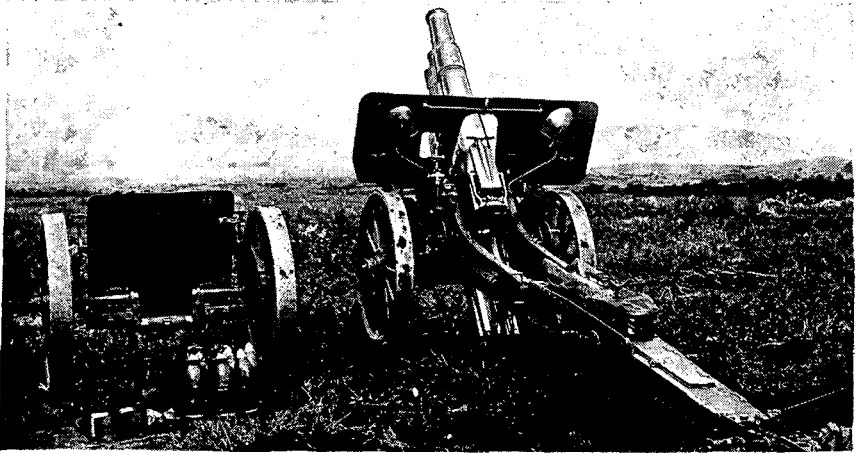
Length of Tube.....	85.4 in.; 14.6 calibers.
Muzzle Velocity.....	1,344.8 f/s.
Maximum Range.....	10,464 yards.
Elevation.....	65°.
Depression.....	—5°.
Traverse.....	3° right, 3° left.
Rate of Fire:	
Maximum.....	3-4 rpm.
15 minutes.....	1 rpm.
Continuous.....	30-40 rph.
Ammunition.....	HE, pointed shrapnel, APHE, smoke, incendiary, and illuminating (for further data, see fig. 88).
Type of Breechblock.....	Vertical, sliding, separate loading ammunition with cartridge case obturation.
Type of Firing Mechanism.....	Percussion.
Rifling.....	36 grooves.
Length.....	5 ft.



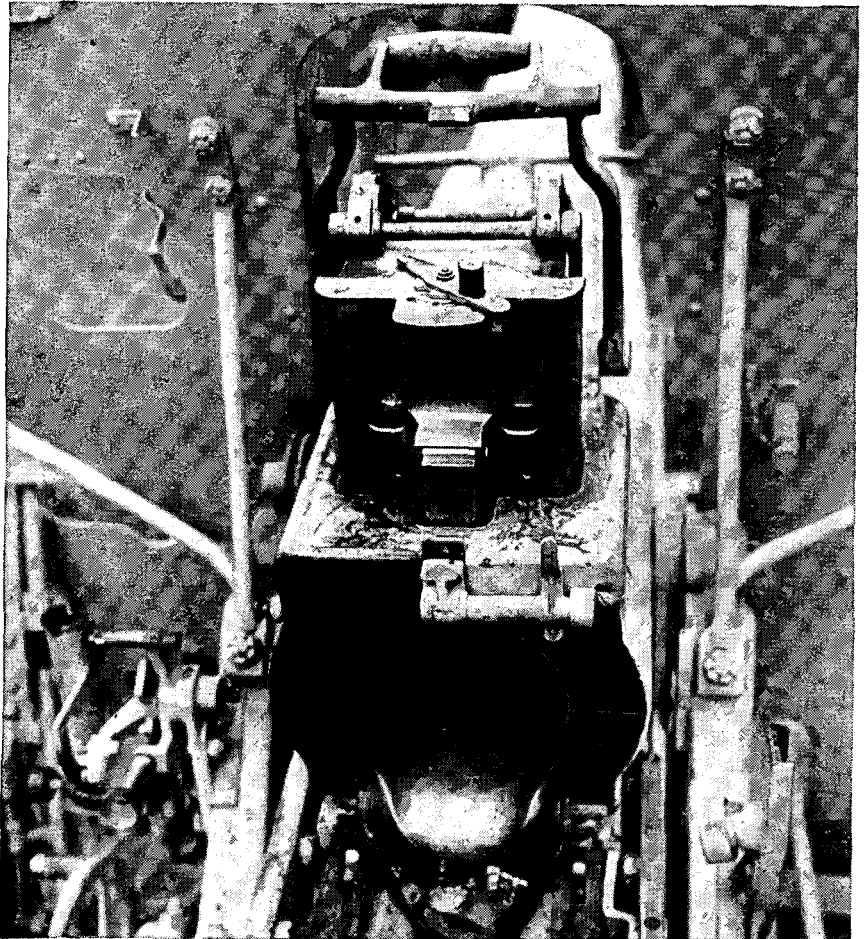
*Figure 45. Model 4 (1915) 150-mm howitzer, right side.*



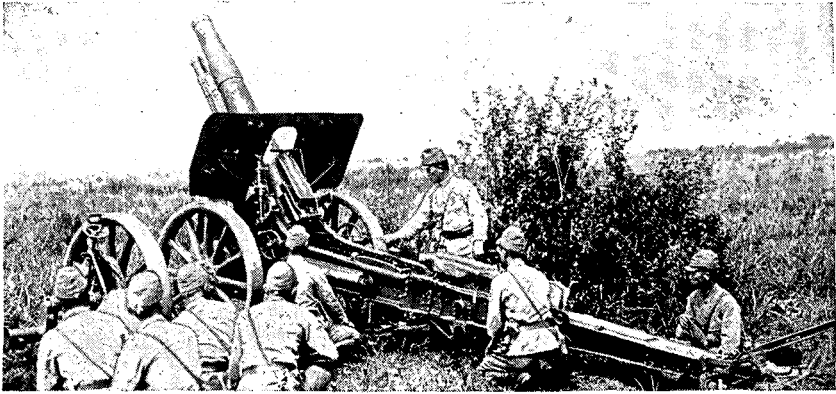
*Figure 46. Model 4 (1915) 150-mm howitzer, left side.*



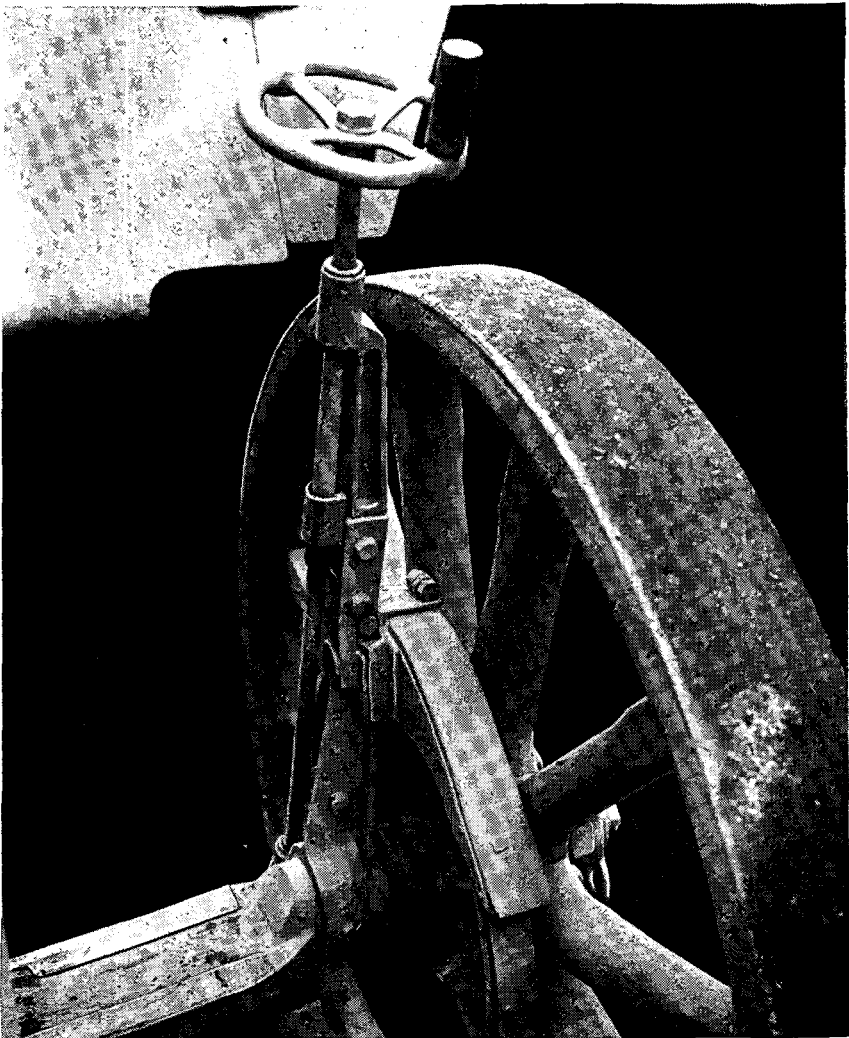
*Figure 47. Model 4 (1915) 150-mm howitzer emplacement.*



*Figure 48. Breech of Model 4 (1915) 150-mm howitzer with breechblock raised.*



*Figure 49. Model 4 (1915) 150-mm howitzer with crew.*



*Figure 50. Wheel brake of Model 4 (1915) 150-mm howitzer.*



Figure 51. Assembly of Model 4 (1915) 150-mm howitzer: bringing up the tube and rear trail section.



Figure 52. Assembly of Model 4 (1915) 150-mm howitzer: Connecting rear trail section to carriage.



Figure 53. Assembly of Model 4 (1915) 150-mm howitzer: placing tube in battery. The second man from the left is using the winch on the side of the rear trail section to pull the tube over the removable rails to the slides.

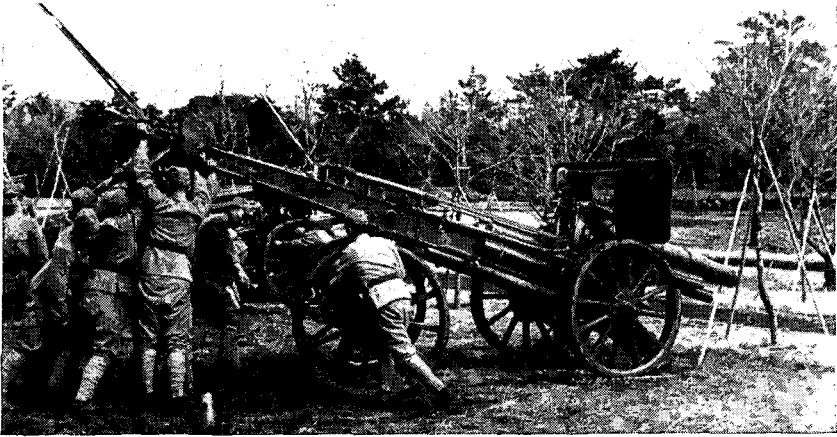


Figure 54. Assembly of Model 4 (1915) 150-mm howitzer: removing wheels of the rear trail and tube carrying section. Note position of removable rails, which carry tube from traveling position on rear trail section, to battery on sleigh of carriage.

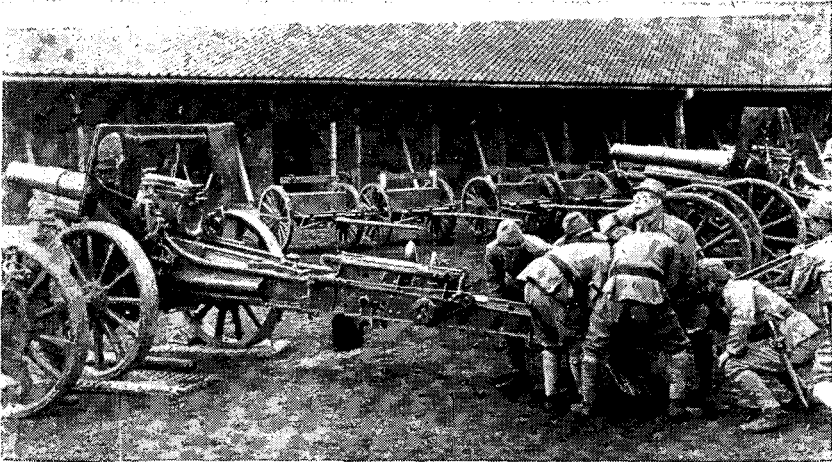


Figure 55. Assembly of Model 4 (1915) 150-mm howitzer: tube in battery, removable rails removed. Note winch on side of rear trail section similar to that on right side.

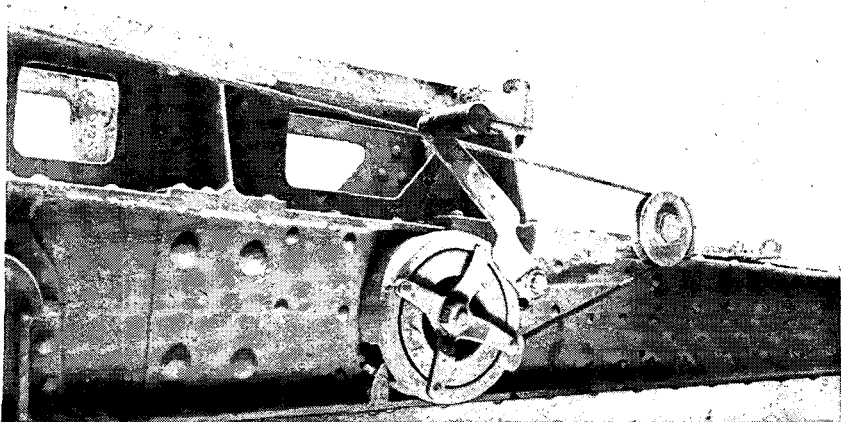


Figure 56. Winch on left side of Model 4 (1915) 150-mm howitzer trail.

## CONSTRUCTION AND MOVEMENT DATA

<b>Weight of Gun:</b>	
Firing.....	6,160 lb.
Traveling.....	Barrel: 4,838 lb. Cradle: 4,729.78 lb.
<b>Over-all Length:</b>	
Firing.....	8 ft. 6 in.
Traveling.....	27 ft. 4 in.
<b>Width:</b>	
Track.....	5 ft.
Maximum.....	Barrel: 6 ft. 1 in.; Cradle: 6 ft. 2 in.
Height.....	Barrel: 4 ft. 4 in.; Cradle: 6 ft. 11 in.
Road Clearance.....	Barrel: 10.4 in.; Cradle: 13.5 in.
Method of Transport.....	Can be transported for short distances in single load. Horse-drawn, 2 loads, 6 horses each load.
Practical Speed on Good Roads.....	40 miles per day.
Time to Emplace.....	10 minutes.
Type of Traverse.....	Axle.
Type of Equilibrator.....	Spring and cable.
Type of Brakes.....	Hand brakes.
Wheels and Tires.....	Iron tires on wooden wheels.
Trail.....	Modified box.
<b>Recoil System:</b>	
Standard.....	35.1-50.7 in.
Maximum.....	51.9 in.
Type of Recoil System.....	Hydropneumatic, dependent.
Quantity Fluid Recoil Cylinder.....	14.8 qt.
Air Pressure Counterrecoil Cylinder.....	468.6 lb./sq. in.

**k. Model 96 (1936) 150-mm Howitzer.** Although the Model 96 (1936) 150-mm howitzer has been made in considerable quantity since the time of its adoption, it has not yet completely replaced the Model 4 (1915) 150-mm howitzer in Japanese medium artillery units. The Model 96, the last artillery weapon developed during the period of redesigning, is heavier than the Model 4, has a somewhat greater range, and travels as a single load drawn by tractor. In travel, it is jacked up on a leaf spring. During firing, the spring is depressed so the piece fires off its axle. The Model 96 uses the same ammunition as the Model 4.

### GENERAL

Weapon.....	150-mm (149.1-mm) howitzer, Model 96 (1936), 15-cm.
Identification.....	Relatively short tube with muzzle only slightly forward of rectangular cradle. Three demountable spade plates and demountable trail block for each trail end. Wheel chocks. Leaf spring above axle.

### FIRING CHARACTERISTICS

Length of Tube.....	11 ft. 6 in.; 23.37 calibers.
Maximum Range.....	Pointed Shell: 12,971 yards. HE Shell: 11,336 yards.
Elevation.....	65°.
Depression.....	-5°.
Traverse.....	15° right, 15° left.
<b>Rate of Fire:</b>	
Maximum.....	3-4 rpm.
15 minutes.....	1 rpm.
Continuous.....	30-40 rph.
Ammunition.....	HE, APHE, shrapnel, pointed, smoke, and incendiary (for further data, see fig. 88).
Type of Breechblock.....	Step interrupted screw.
Type of Firing Mechanism.....	Percussion.
Rifling.....	36 grooves. Uniform right-hand twist. 9 ft. 3 in.



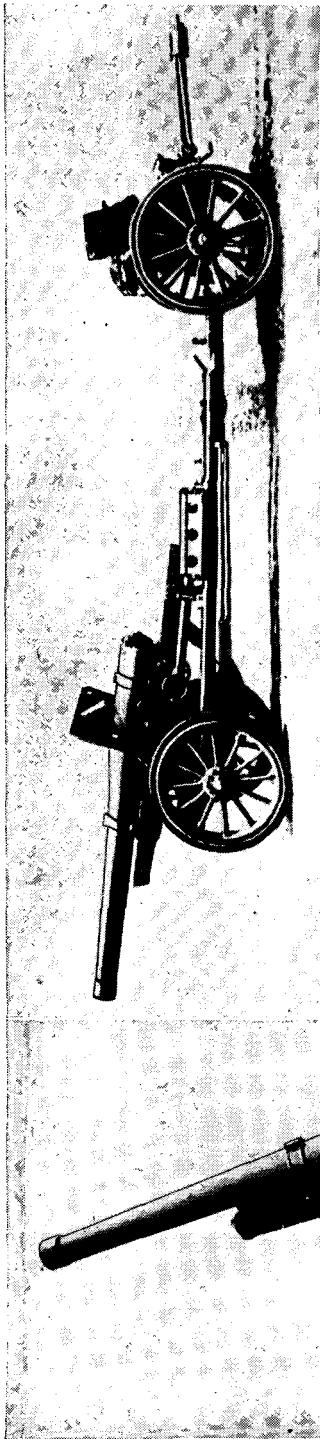


Figure 57. Model 96 (1936) 150-mm  
howitzer, limbered.

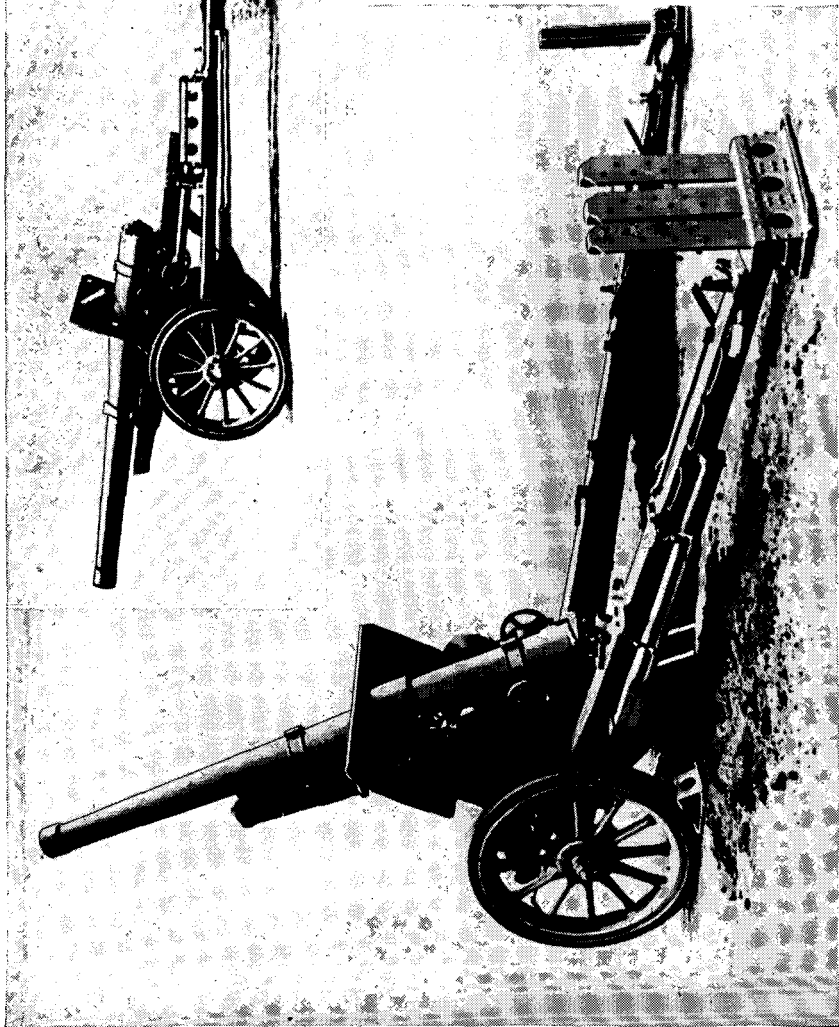
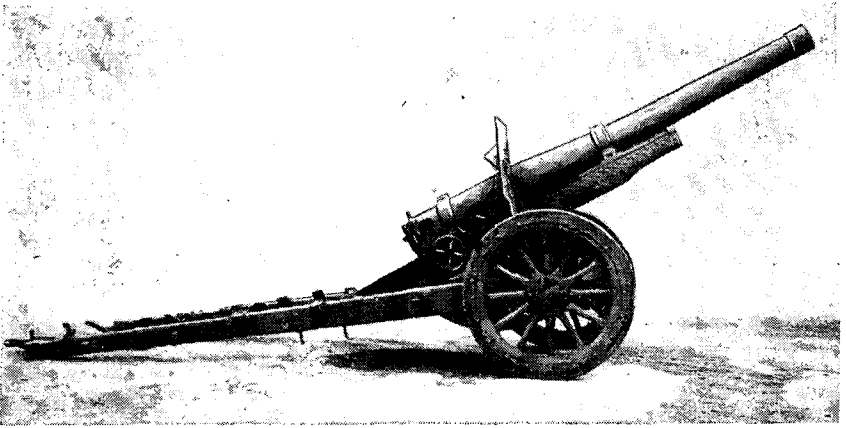
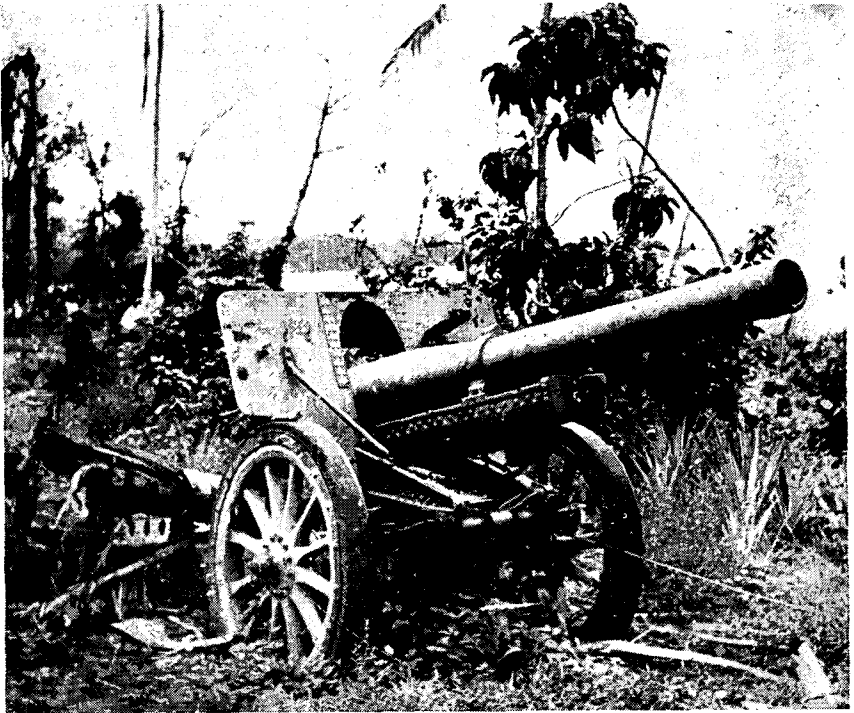


Figure 58. Model 96 (1936) 150-mm  
howitzer, left side.



*Figure 59. Model 96 (1936) 150-mm howitzer, right side.*



*Figure 60. Model 96 (1936) 150-mm howitzer, front view.*

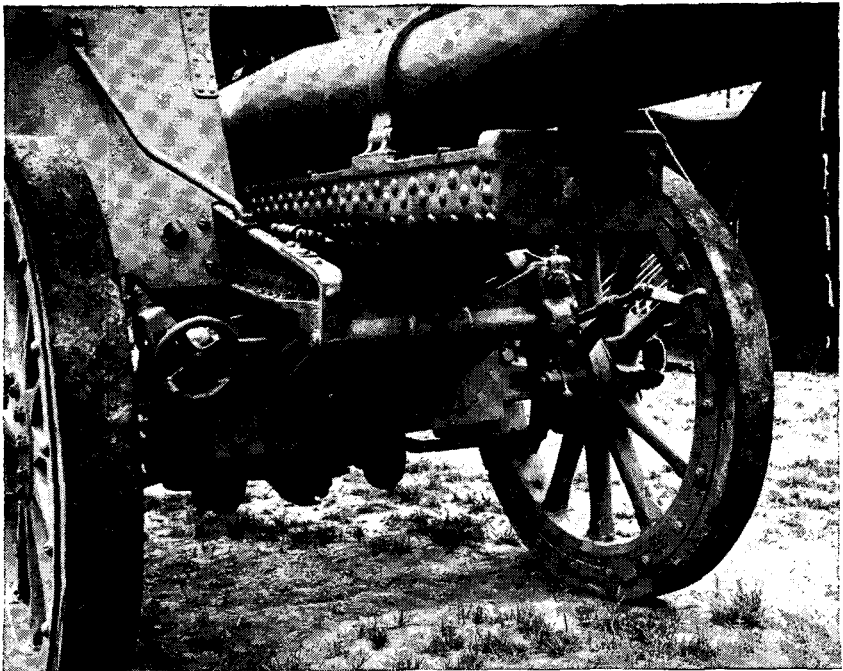
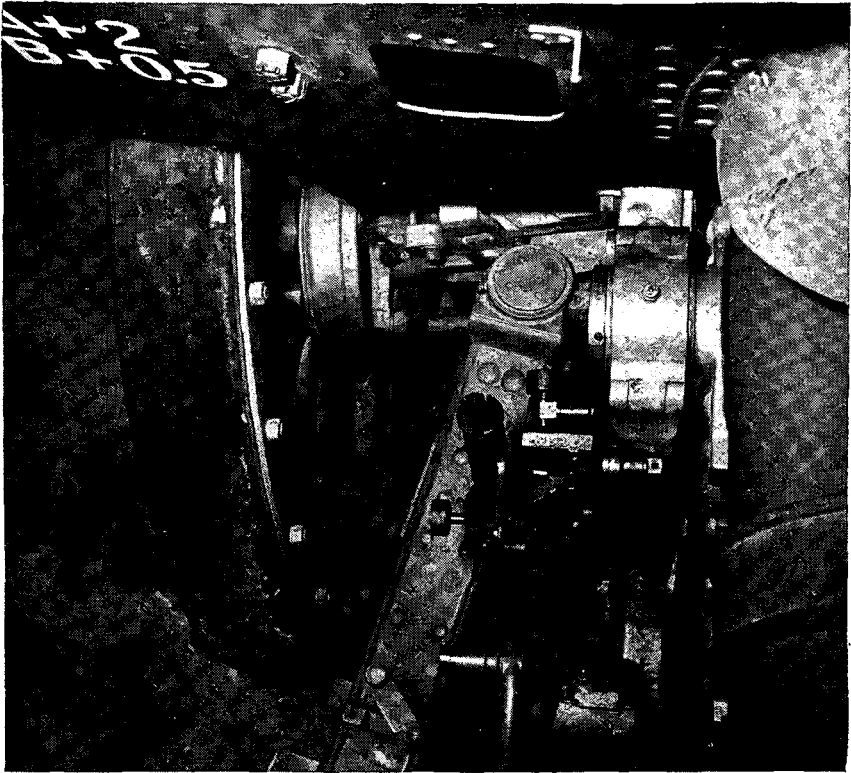


Figure 61. Model 96 (1936) 150-mm howitzer: (1) left side, showing sight mount and traversing hand-wheel; (2) front detail, showing recoil mechanism and brake lever.



*Figure 62. Model 96 (1936) 150-mm howitzer emplaced in the jungle. The tube is in full recoil.*

## CONSTRUCTION AND MOVEMENT DATA

Weight of Gun:	
Firing.....	9,108 lb.
Traveling.....	10,846 lb.
Over-all Length:	
Firing.....	22 ft.
Traveling.....	30 ft. 4 in.
Width, Track.....	5 ft. 5 in.
Height.....	6 ft. 7 in.
Road Clearance.....	12.9 in.
Method of Transport.....	5-ton tractor.
Practical Speed on Good Roads.....	19.9 miles per hour (maximum). 8.7 miles per hour (average). 49.7-62.1 miles per day.
Time to Emplace.....	7 minutes.
Type of Traverse.....	Pintle.
Type of Equilibrator.....	Spring attached to rear of cradle.
Type of Brakes.....	Internal expansion, hand.
Wheels and Tires.....	Solid rubber tires, wooden artillery wheels.
Trail.....	Split with 3 spade plates and a trail block for each trail. Plates and blocks demountable.
Recoil System:	
Standard.....	39 inches.
Maximum.....	40.6 inches.
Type of Recoil System.....	Hydropneumatic, constant, independent.
Quantity Fluid Recoil Cylinder.....	10.2 qt.
Quantity Fluid Counterrecoil Cylinder.....	8.5 qt.
Air Pressure Counterrecoil Cylinder.....	738.4 lb./sq. in.

**I. Heavy Artillery.** (1) *Model 89 (1929) 150-mm Gun.* This gun is apparently the basic heavy artillery weapon of the Japanese which is comparable with the U. S. 155-mm gun. No example of this weapon has been captured, although it was probably used in the Malay and Philippine campaigns. It fires a shell considerably heavier than that used in the 150-mm howitzer. The Japanese were sufficiently satisfied with this gun to provide it with a fixed mount for siege use in 1930, but as a heavy field piece it has certain definite limitations. Traveling in two loads, it takes longer to emplace than weapons of corresponding caliber in other modern armies and yet it is outranged by all of them.

### GENERAL

Weapon.....	150-mm (149.1-mm) gun, Model 89 (1929), 15-cm. cannon.
General Characteristics.....	Standard Japanese heavy artillery.
Identification.....	Built-up tube. Large, long barrel piece with split trails.
Organization to Which Issued.....	Army.
Tactical Employment.....	Counterbattery long-range interdiction.

### FIRING CHARACTERISTICS

Length of Tube.....	
Muzzle Velocity.....	2,250 f/s.
Maximum Range.....	21,800 yards.
Elevation.....	43°.
Depression.....	—5°.
Traverse.....	20° right, 20° left.
Rate of Fire: Maximum.....	2 rpm.
Ammunition.....	APHE, HE, shrapnel, pointed, illuminating (for further data, see fig. 88).
Type of Breechblock.....	Stage, interrupted.

### CONSTRUCTION AND MOVEMENT DATA

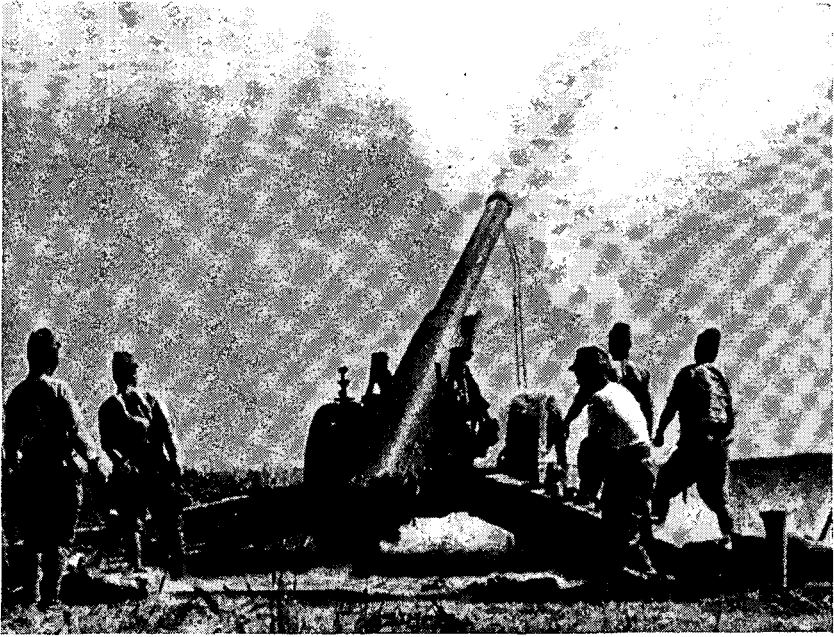
Weight of Gun:	
Firing.....	22,928.4 lb.
Barrel.....	17,215 lb.
Cradle.....	16,645.2 lb.
Over-all Length:	
Firing.....	29 ft. 6 in.
Traveling.....	Barrel: 25 ft. 2 in.; Cradle: 23 ft. 11 in.

Width:	
Track.....	5 ft. 8 in.
Maximum.....	7 ft. 3 in.
Height.....	3 ft. 6 in.
Road Clearance.....	Barrel: 10.9 in.; Cradle: 12.1 in.
Method of Transport.....	8-ton tractor-drawn—2 loads.
Time to Emplace.....	2 hours.
Type of Traverse.....	Pintle.
Type of Equilibrator.....	Pneumatic (?).
Wheels and Tires.....	Metallic disk wheels with solid rubber tires.
Trail.....	Split.
Recoil System:	
Standard.....	35.1—58.5 in.
Maximum.....	73 in.
Type of Recoil System.....	Hydropneumatic, variable.
Quantity Fluid Recoil Cylinder.....	17.5 qt.
Quantity Fluid Counterrecoil Cylinder.....	10.1 qt.
Air Pressure Counterrecoil Cylinder.....	1,562 lb./sq. in.

(2) *Other heavy artillery:* The Model 45 (1912) 240-mm howitzer is reported in use by Japanese heavy artillery units. The piece allegedly is disassembled into units which are transported in ten vehicles. Its maximum range is reputed to be about 11,000 yards, and it is believed to fire a semifixed round weighing approximately 400 pounds.

It is known that the Japanese have purchased 17-cm, 21-cm, and 24-cm weapons from Germany in recent years. It therefore is possible that Japanese copies of these pieces may have been manufactured and may be employed in operations where they could be used to advantage. Several other Japanese heavy artillery pieces have been reported but, since none have been captured, the characteristics given in the table below have not been verified.

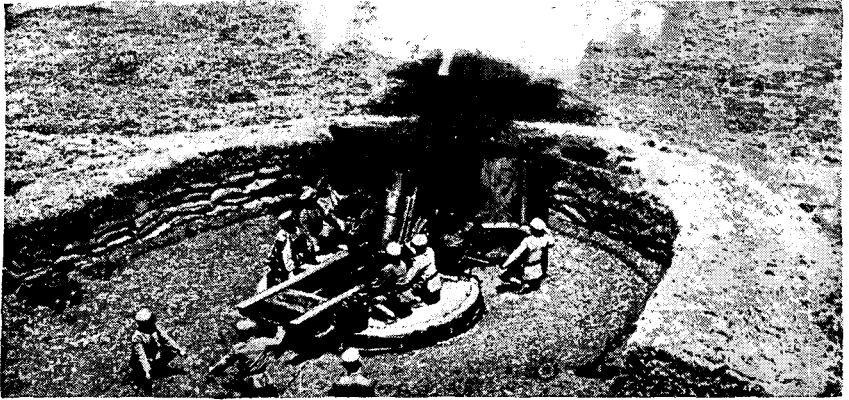
Cal.	Type	Length of bore (in.)	Muzzle Velocity (f/s)	Type of shell	Weight of shell (lb.)	Maximum range (yd.)	Elevation	Weight in action (tons)
24-cm	Railway gun	-----	3560	HE	440	54500	-----	35
30-cm	How. M 18	196	1310	HE	880	12750	46°	14.72
30-cm	How. M 18	324	1140	HE	1100	16600	48°	19.76
41-cm	How. (siege)	538	1760	HE	2200	21200	45°	80



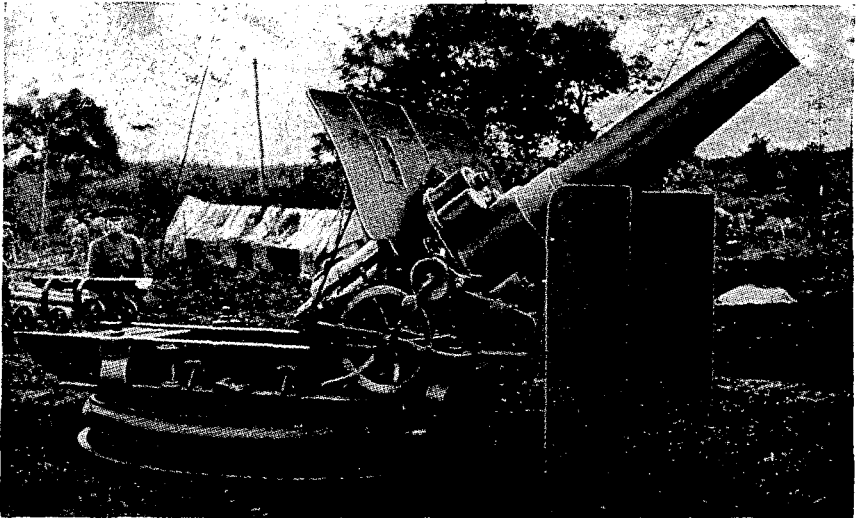
*Figure 63. Model 89 (1929) 150-mm gun.*



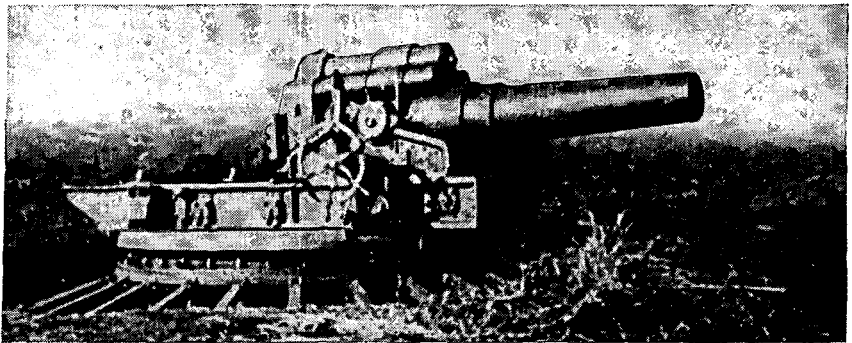
*Figure 64. Model 89 (1929) 150-mm gun battery in China.*



*Figure 65. Model 45 (1912) 240-mm howitzer in revetted emplacement.*

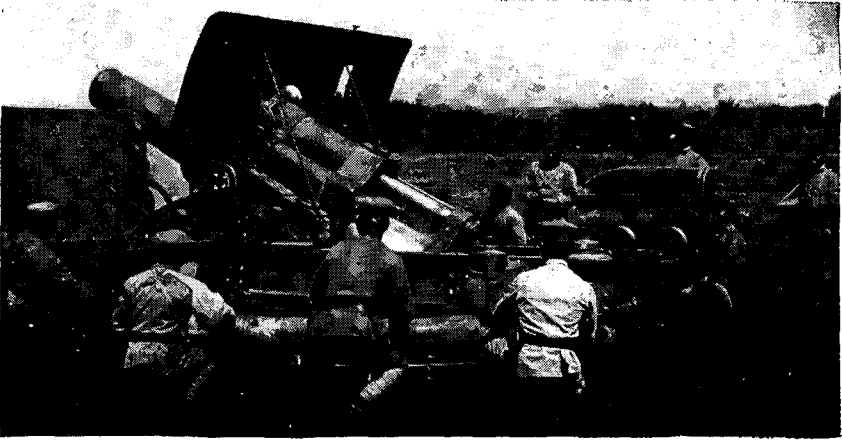


*Figure 66. Model 45 (1912) 240-mm howitzer right side.*

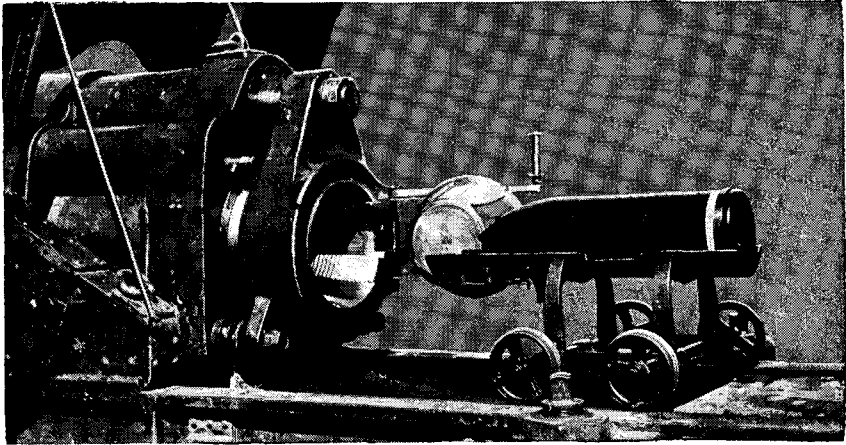


*Figure 67. Model 45 (1912) 240-mm howitzer, emplacement nearing completion.*

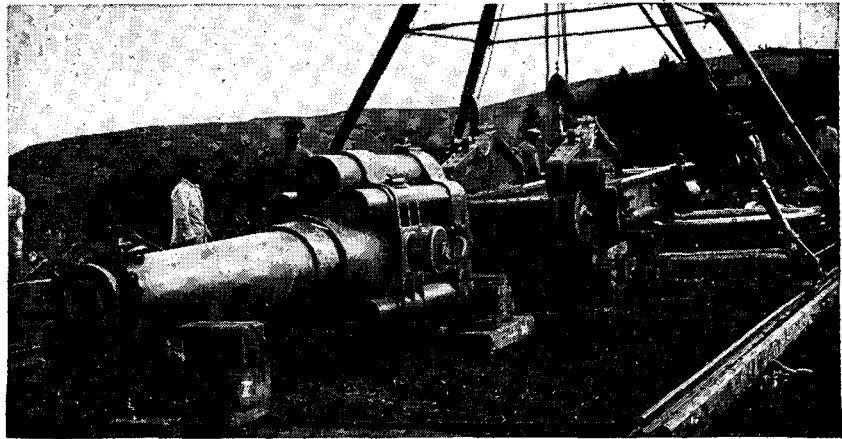




*Figure 68. Model 45 (1912) 240-mm howitzer, left side.*



*Figure 69. Breech of Model 45 (1912) 240-mm howitzer.*



*Figure 70. Model 45 (1912) 240-mm howitzer being emplaced.*

Most recent evidence, however, gives the following data in regard to heavy artillery weapons, which is believed to be more reliable.

Weapon	Cal. mm	Length (cal.)	Range (yd.)	Tra- verse (degrees)	Wt. Proj. (lb.)	Wt. Weapon (lb.).		Notes
						position: firing	position: traveling	
24-cm how.	240	24	15,310	240	AP 440	83,909	-----	Disassembled and transported in four loads.
Heavy mort	305	8	4,480	120	296 lb. 6 oz.	46,300	Heaviest vehicle 26,460 lb.	Disassembled and motor-drawn.
30-cm how. (short)	305	16.4	13,130	360	AP 881 lb. 13 oz.	169,800	Heaviest vehicle 55,110 lb.	Disassembled and transported in seven loads.
30-cm how. (long)	305	24	16,630	360	AP 881 lb. 13 oz.	271,070	Heaviest vehicle 66,140 lb.	-

**m. Obsolete or Obsolescent Equipment.** Certain Japanese artillery weapons, first standardized in 1905, are probably no longer in general use among front-line units. These pieces, the Model 38 series, were manufactured in four calibers—75-mm, 105-mm, 120-mm, and 150-mm. They were characterized by the unusual shortness of the tube, hydrospring recoil mechanism, and plain box trails, which sharply limited their flexibility for artillery use. They fire the same projectiles as the more modern weapons of the same caliber. Although their ranges appear to be inadequate for use against a modern army, these pieces were still being employed by the Japanese in China only a few years ago.

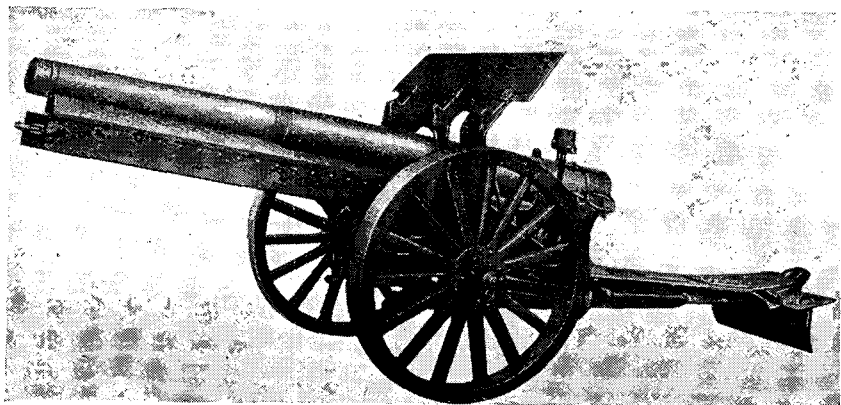


Figure 71. Model 38 (1905) 105-mm gun.

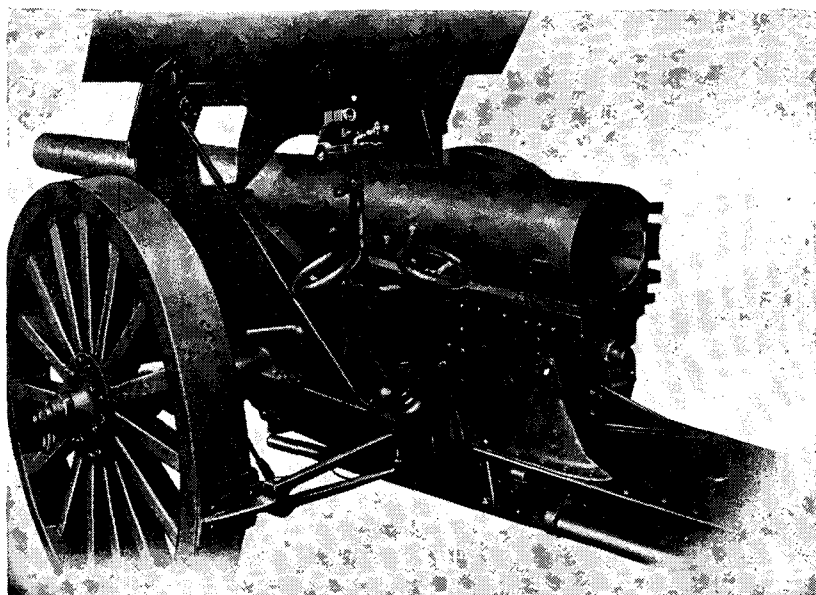
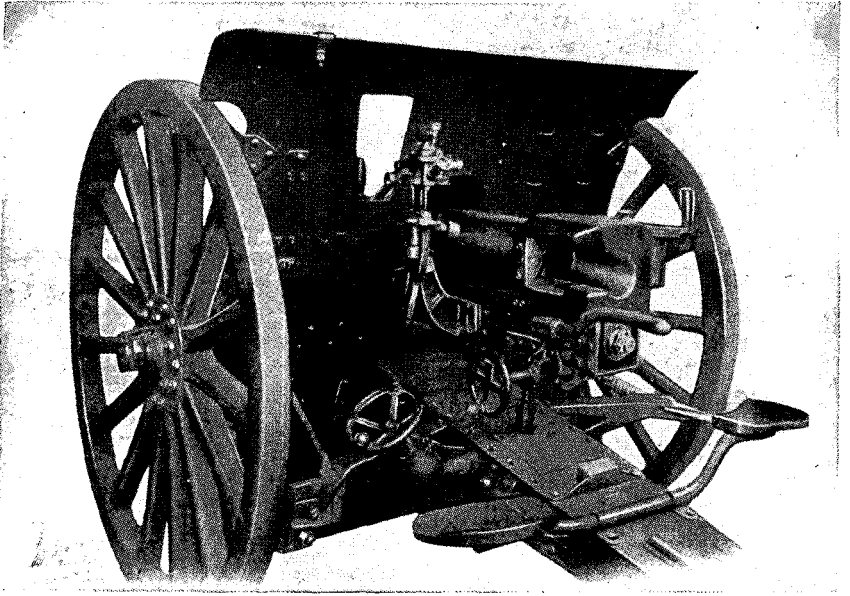


Figure 72. Breech of Model 38 (1905) 105-mm gun.

Weapon	Lgt. tube (in.)	Muz. zle vel. (f/s)	Eleva- tion	De- pres- sion	Rate of fire				Breechblock	Firing mechanism	Remarks
					Tra- verse	2 min.	15 min.	Cont.			
75-mm Model 38 (1905) field gun.	90.7 31 cal	1640	16.5°	-8°	3.5° R 3.5° L	15 rpm	4 rpm	100-120 rph.	Interrupted screw later modified to horiz. sliding wedge.	Continu- ous pull percus- sion on sliding wedge block.	Plain box trail, no equilibra- tors, trun- nioned at center of balance.
105-mm Model 38 (1905) 10-cm cannon.	129.7 31.67 cal.	1771.2	15°	-2°	3° R 3° L also, 15° R 15° L				Interrupted screw.		
120-mm howitzer Model 38 (1905) 12-cm			43°	-5°	1.45° R. 1.45° L.						
150-mm howitzer Model 38 (1905) 15-cm.			43°	0°							

Figure 73. Characteristics of obsolete weapons—firing data.



*Figure 74. Breech of the Model 38 (1905) 75-mm field gun.*



*Figure 75. Mod. 38 (1905) 120-mm howitzer.*

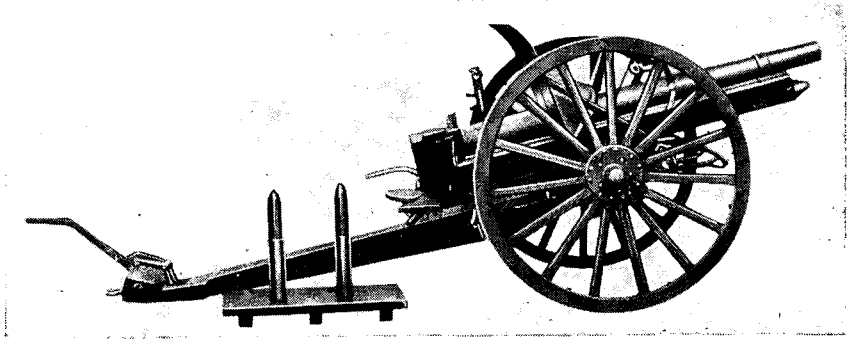


Figure 76. Model 38 (1905) 75-mm field gun.

OBSOLETE WEAPONS—MOVEMENT DATA

MOVEMENT DATA

WEAPON

	<i>75-mm Model 38 (1905) field gun</i>	<i>105-mm Model 38 (1905) 10-cm cannon</i>	<i>120-mm howitzer Model 38 (1905) 12-cm</i>	<i>150-mm howitzer Model 38 (1905) 15-cm</i>
Weight:				
Firing-----	2,197.2 lb.	5,715.2 lb.	2,770.4 lb.	4,598 lb.
Traveling-----	3,822 lb.	7,085.9 lb.	4,771.7 lb.	5,698 lb.
Length:				
Firing-----	176.5 in.	16 ft. 5 in.	12 ft. 4 in.	13 ft. 5 in.
Traveling-----	383 in.	27 ft. 7 in.	16 ft. 1 in.	26 ft. 6 in.
Width:				
Track-----	54.6 in.	4 ft. 5 in.	4 ft. 10 in.	4 ft. 9 in.
Maximum-----	58.1 in.	5 ft. 10 in.	4 ft. 10 in.	4 ft. 9 in.
Height-----	62.8 in.	3 ft. 6 in.	5 ft. 11 in.	6 ft.
Road clearance-----	15.6 in.	5 ft. 3 in.	11.9 in.	1 ft. 1 in.
Speed-----	24.8 m/d			
Emplacement time-----	2 minutes			
Type of traverse-----	Axle	Axle	Axle	Axle
Type of equilibrator-----	None			
Type of brakes-----	Hand friction brake.	Hand friction brake.		
Recoil system:				
Standard-----	46.8 in.	62.4 in.	22.6 in.	23 in.
Maximum-----	50.1 in.	65.5 in.	24.2 in.	25.7 in.
Type-----	Hydrospring	Hydrospring	Hydrospring	Hydrospring
Quantity recoil fluid-----	4.7 qt	10.58 lb.	3.7 qt.	8 qt

Figure 77. Characteristics of obsolete weapons—movement data.

**n. Fire-control Equipment.** (1) *On-carriage fire control.* Two basic types of on-carriage fire-control devices are employed on Japanese field artillery weapons. Pieces up to the 105-mm howitzer (that is, light artillery) are equipped with plain or modified range racks. The gunner sets ranges, angles of sight, and deflections and lays the gun in elevation and direction. Guns from 105-mm up have sights mounted in cant-compensating mounts on the left side of the piece and range disks geared to the trunnions on the right side. On these weapons, the gunner sets deflections and lays for direction, while the No. 1 cannoneer sets ranges and lays for elevation.

The range rack (fig. 79) is a curved metallic bar carrying a rack of teeth. A worm knob on the mount engages the teeth on the rack, raising or lowering it. The curved bar is marked with an elevation scale and one or more range scales. Fixed to the rack is an angle-of-site micrometer and knob and a level vial. Ranges are set and read at the junction of the rack with the top surface of the rack mount, and the gun is laid for elevations, the appropriate range having been set by elevating or depressing the piece until the bubble in the level vial is centered. On the older Japanese artillery pieces, the Model 38 series, the Model 38 (1905) 75-mm gun, improved, and the Model 41 (1908) cavalry gun, the elevation scale on the range rack is graduated in degrees and sixteenths of a degree, a sixteenth of a degree equaling 1.1 mils. Since no rack for a Model 94 mountain gun has been captured, the type of elevation graduation employed on it is not known. There are also range scales for one or more types of Japanese shells, the type of shell to which the particular range scale applies being marked above the scale with the appropriate Japanese characters. The range rack is equipped with a cross-level vial. The rack thus can be brought perpendicular to the ground and the degree of cant measured on a scale on the mounts, but this provides no automatic compensation for cant. A correction must be applied by the

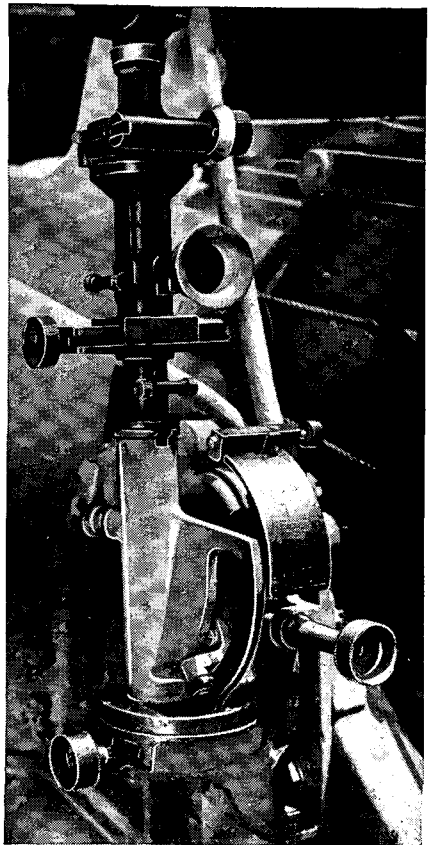
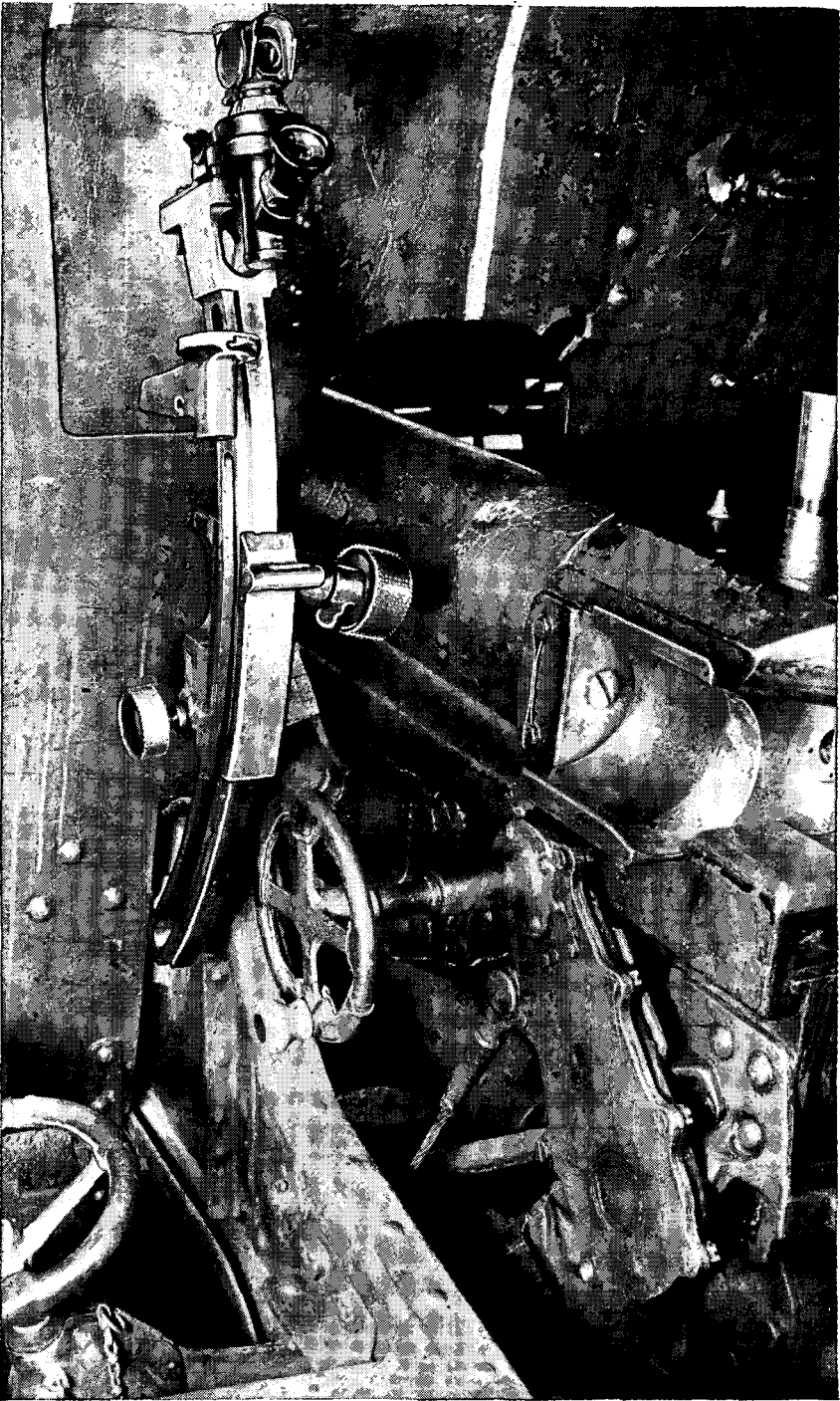


Figure 78. Sight mount on Model 4 (1915) 150-mm howitzer.



*Figure 79. Model 38 (1905) 75-mm gun (improved): range rack with sight mounted.*

gunner at each elevation setting. The mount itself is sometimes sprung out of correct alignment and this must be compensated by a constant correction, probably applied to the angle of site.

The sight is mounted on top of the range rack. The Japanese panoramic telescopic sight is of German design; it uses a mil scale for setting horizontal angles and is almost identical in construction with the standard U. S. artillery sights. Since it is mounted on top of the range rack, there is no automatic correction for the deflection of effect of cant and, as in the case of range, a deflection correction must be applied by the gunner with each elevation shift.

(2) *Operation of on-carriage fire control.* (a) *Mounting the range rack.* Turn the throwout lever backward and downward to its open position. Press the shank of the range rack as far down as possible in its mount. If necessary, turn the throwout lever to closed position, and, turning the range knob with one hand, force the shank down into the mount with the other. When 0 (zero) on the rack elevation coincides with the top of the range-rack mount, the rack is properly seated. With range rack in place, turn the cross-level knob until the bubble is centered. The reading on the cross-level correction index is in degrees.

(b) *Mounting the sight.* The sight slides into the dovetailed projection at the top of the range rack, and is held in place by a spring.

(c) *Calibrating the range rack.* After giving a gunner's quadrant an end-to-end test, place in position on the breech and set the tube at 0 elevation by the quadrant. Turn the range rack to 0 elevation. Level the angle-of-site bubble with the angle-of-site knob, and take the reading on the micrometer. Check this calibration by repeating the process, setting the tube at 100 and elevation at 100. The micrometer reading will be used as 0 (U. S. 300) angle of site in all changes of firing data.

(d) *Setting ranges, elevation, and angles of site.* Elevations on range racks for the Model 38 75-mm gun and the Model 41 75-mm gun are in degrees and  $\frac{1}{16}$ 's. The battery executive converts elevation commands in mils to degrees and sixteenths. Rough elevation settings are made by freeing the rack with the throwout lever, raising or lowering the rack to approximately the correct elevation, and clamping the rack in place. Exact adjustment for elevation is made with the range knob by bringing the appropriate elevation on the rack in coincidence with the top of the mount.

Ranges are set in a similar manner, using the rack-range scale for appropriate shell instead of the elevation scale. The common markings on Japanese shell racks are for HE, pointed shell, and shrapnel.

Angles of site are applied on the angle-of-site micrometer by turning the angle-of-site knob. The angles are applied to the constant correction which was obtained during calibration of the range rack.

Example:	Constant correction reading:	—83
	Si command	308
	Final angle-of-site reading	91



(e) *Setting deflections.* The gunner sets deflections after he has laid the gun in elevation. The operation of the Japanese panoramic sight is identical in all respects with that of the U. S. panoramic sight.

(3) *Off-carriage equipment.* Like all Japanese optical instruments, artillery optical equipment is well made, sturdy, and sufficiently versatile. There are no significant features, however, that differ materially from the designs utilized by other armies.

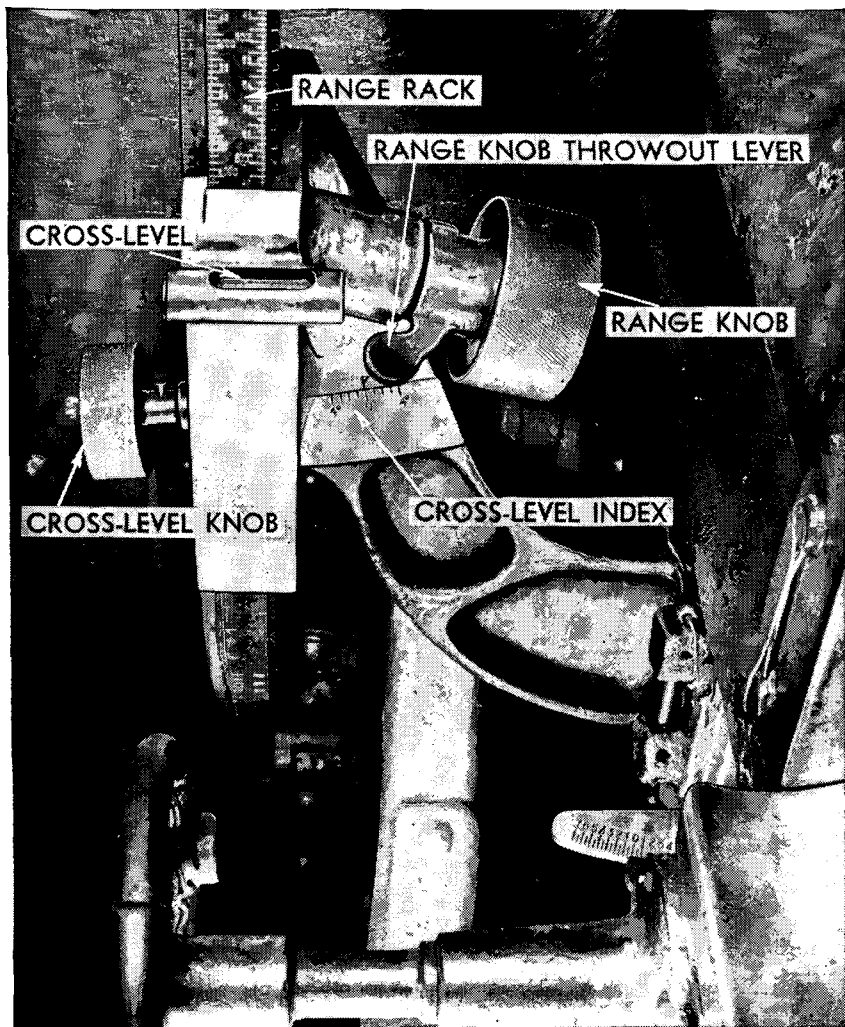


Figure 80. (1) Mounting the range rack.

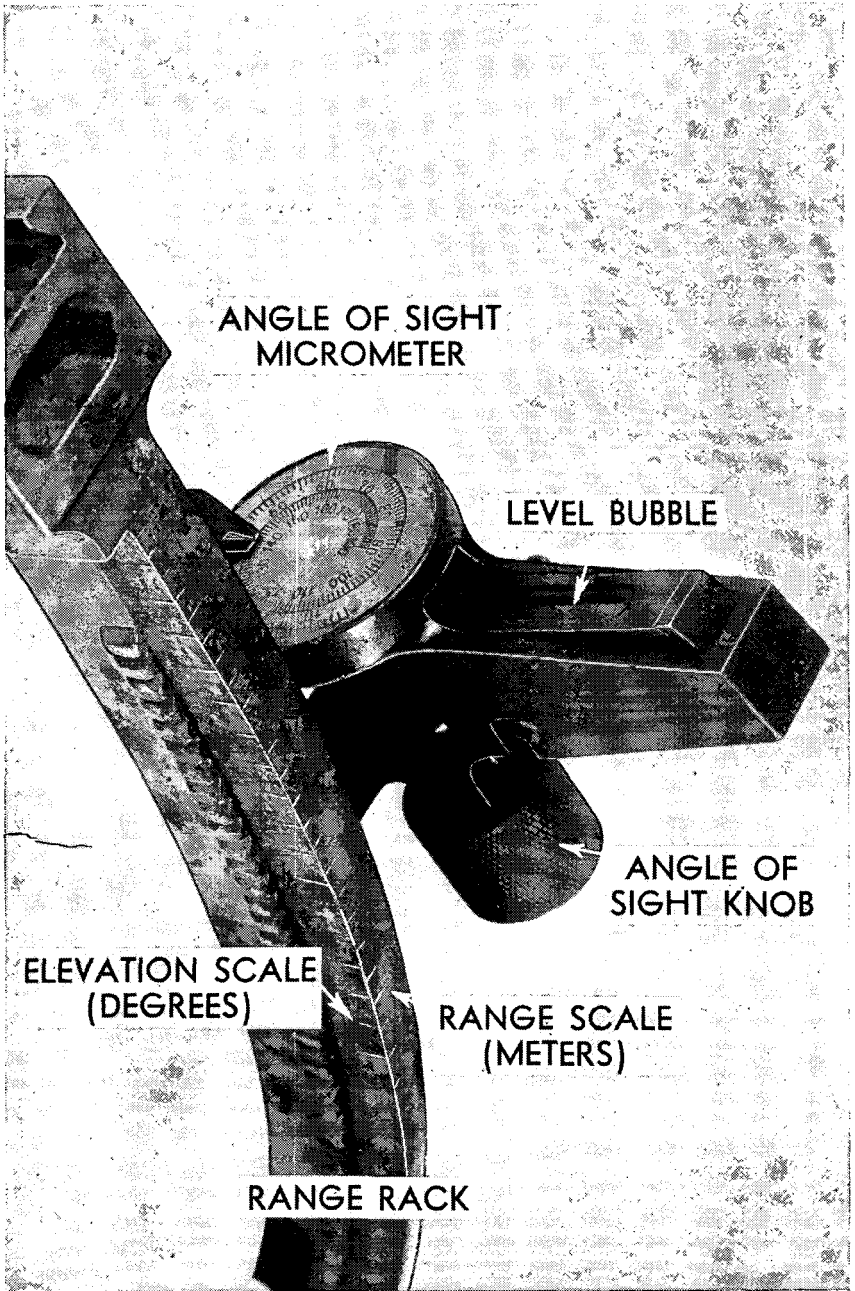


Figure 80. (2) Range rack with angle of site micrometer and level.

The one-meter base stereoscopic range finder is widely employed by Japanese artillery units. Its reticle is graduated from 250 to 6,000 units, which are presumed to be meters. The instrument has 8-power magnification, and its fields of view are  $4.5^\circ$  vertical and  $5^\circ$  horizontal.

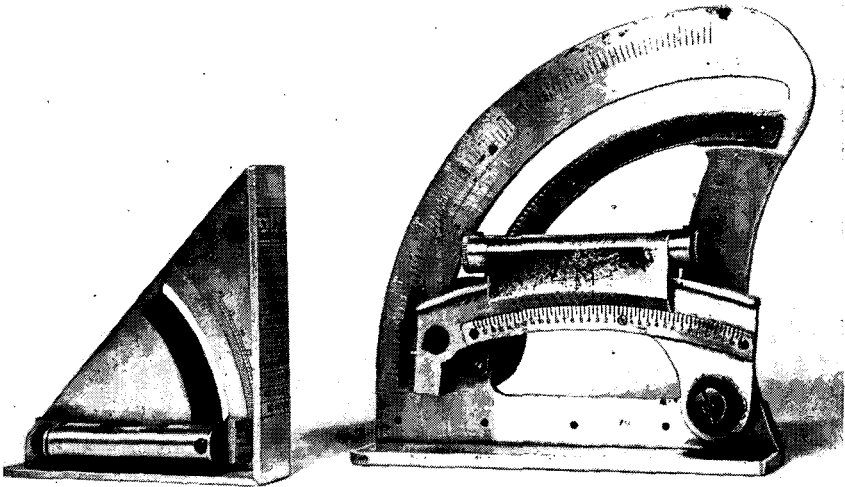


Figure 81. Gunner's quadrants.

Probably the best of the battery commander's telescopes is the Model 93 which permits measurement of angle of site from  $-300$  mils to  $+300$  mils, as well as measurement of azimuth. It has 8-power magnification and a  $6^\circ$  field of view. A deficiency of the instrument is the fact that it cannot be placed in a horizontal position for better stereoscopic view. However, another model is in use which permits such adjustment.

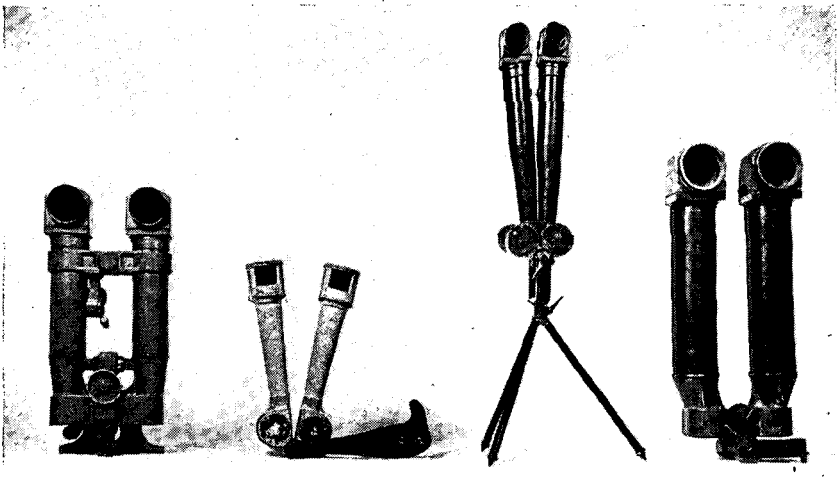
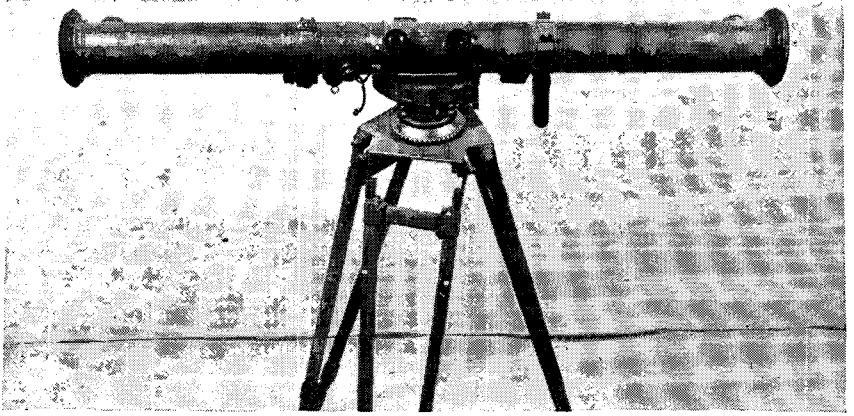
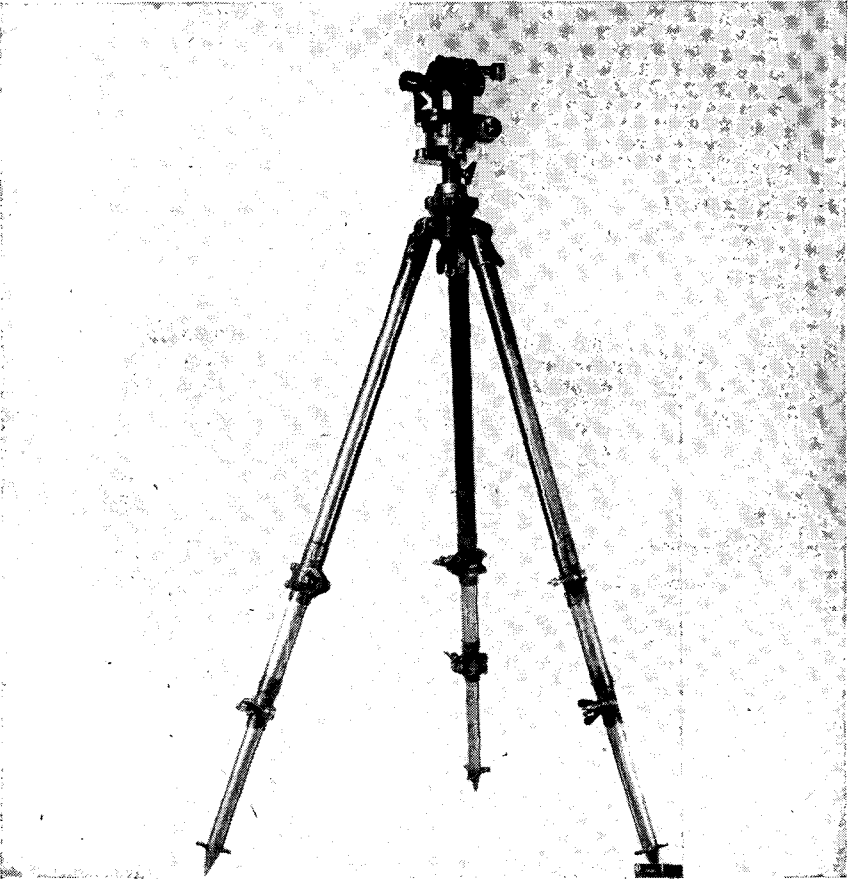


Figure 82. Left to right: Model 93 battery commander's telescope, hand-held battery commander's telescope, 8-power battery commander's telescope with integral tripod, newer type battery commander's telescope.



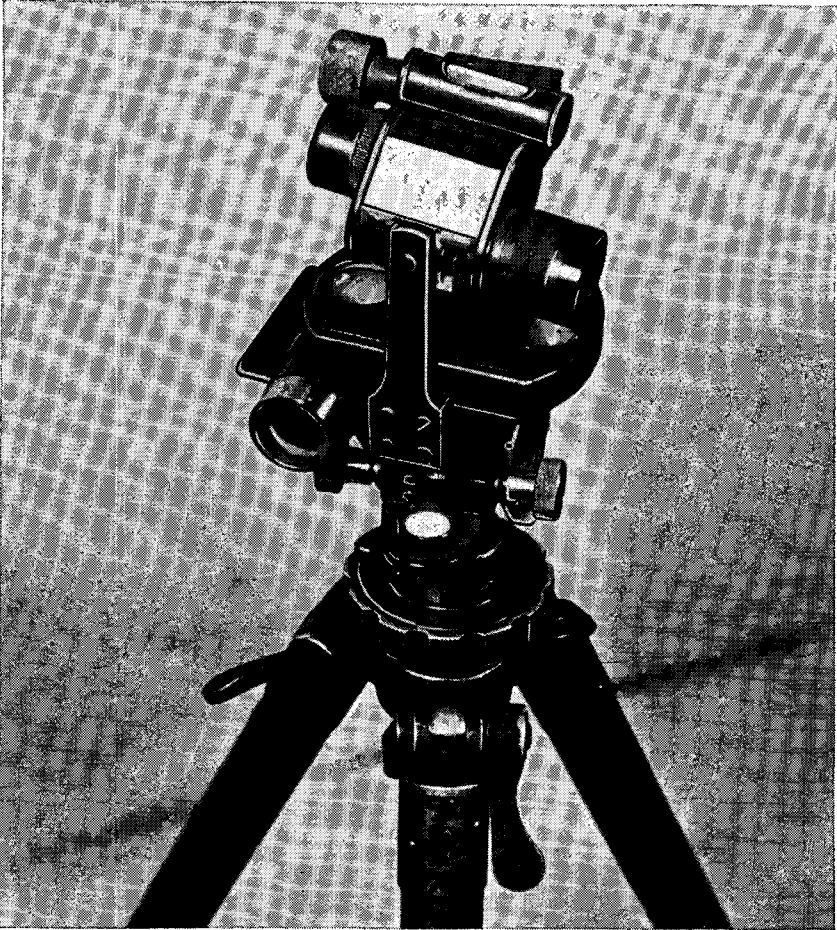
*Figure 83. One-meter base range-finder.*



*Figure 84. Aiming circle.*

The artillery spotting telescope usually furnished to artillery units is capable of use with three different eyepieces giving three different magnifications up to 33 power. In addition to azimuth, elevation from  $-30^{\circ}$  to  $+30^{\circ}$  can be measured.

An aiming circle with a 4-power magnification and a  $10^{\circ}$  field of view is also used by Japanese artillery units for the measurement of angles in azimuth and site, and for general topographical work. It is similar to the U. S. aiming circle.



*Figure 85. Detail of aiming circle.*

# 86 o. Ammunition charts.

Description	Bursting Charge		Projectile Weight including fuze (lbs)	Standard fuze	M41 Mtn	M38 Field	M38 Cav. (Horse)	M38 Field (Improved)	M95 Field	M94 Mtn	M90 Field	M88 A/A
	Type	Weight										
Cartridge Case Length (inches)												
Propellant												
Projectile												
M84 HE	TNT	1.79	13.27	M88 Inst. M88 Delay	x	11.51	11.51	11.51	11.51	x	16.71	19.55
M84 HE	Ammonium Nitrate Cyanidine Nitrate	1.78	13.27		x					x		
M85 APHE	Cyclonite and TNT Picric Acid and Dinitro.	1.08	13.69	M85 AP Small	x					x		
M80 HE	TNT	1.98	12.59	M88 Inst. M88 Delay	x					x		
M10 HE	TNT	2.05	12.35		x					x		
"A" HE	Picric Acid and Dinitro.	----	14.24	M3 Comb.	x					x		
"B" HE	Picric Acid and Dinitro.	1.45	14.57	M88 Inst. M88 Delay	x					x		
M80 or M97 HE	TNT	0.83	13.62		x					x		
M90 Strapsnel	Black Powder	0.22	15.43	M5 Comb. (for guns)	x					x		
M88 Strapsnel	Black Powder	0.22	15.06	M3 Comb. M5 Comb. (for guns)	x					x		
M80 Smoke	Picric Acid and Dinitro.	0.22	12.63	M88 Inst.	x					x		
M80 Incendiary	Black Powder	----	15.30	M5 Comb. (for guns)	x					x		
M80 Illuminating	-----	----	12.46		x					x		
M80 Ptd HE	TNT	----	13.98 or 14.04	M88 Inst. M88 Delay	x					x		
M10 HE	TNT	----	14.44		x					x		
M87 HE	TNT	----	14.33	"	-					-		
M80 A/A Ptd HE	TNT	0.84	14.33 or 14.40	M88 Ptd A/A	-					-		
A/A HE	Picric Acid and Dinitro.	----	14.55	M10 A/A Time	-					-		
APHE	Cyclonite and Beeswax	0.12	14.45	Base Delay	?					?		
M2 HE AT	Cyclonite and TNT (Hollow charge)	1.10	8.34	M88 Inst.	?					?		
M98 HE (Impr)	TNT	2.07	----	M88 Inst. M88 Delay	?					?		

Figure 86. Japanese 75-mm ammunition.

Description	Bursting Charge	Projectile Wgt (Lbs)	Fuze	M91	M92 Gun	M14 Gun
				Howitzer		
Cartridge Case Length (inches)				?	Approx. 29.00	?
Propellent				No.2 Flake	No.3 Strip	No.3 Strip
Projectile						
M91 AA Ptd HE	TNT	35.26	M89 Ptd AA	-	-	-
M91 HE	TNT	35.26	M88 Inst. M88 Delay	x	x	x
M91 HE	Ammonium Nitrate Guanidine Nitrate Cyclonite Nitrate	34.91	"	x	x	-
M95 APHE	Picric Acid Dinitro.	35.06	M95 AP Small base	x	x	x
M14 HE	TNT	35.26	M88 Inst. M88 Delay	x	-	x
M91 HE	TNT	35.26	"	x	x	x
M14 HE	TNT	35.26	"	x	-	x
M91 Ptd HE	TNT	34.74	"	x	x	x
M95 Ptd HE	TNT	34.74	"	x	x	x
M95 Incendiary	---	35.26	M5 Comb.	x	x	x
M95 Shrapnel	Black Powder	36.94	M5 Comb.	x	-	-
M14 Shrapnel	" "	36.94	M5 Comb.	-	x	x
M14 Ptd HE	TNT	35.26	M88 Inst. M88 Delay	-	-	x
M14 Smoke	Black Powder	35.64	M5 Comb.	-	-	x
A APHE	Picric Acid Dinitro.	39.76	M88 Small base (for guns)	-	-	-
B APHE	" "	39.76	"	-	-	-
A Cast iron APHE	" "	40.18	"	-	-	-
B Cast iron APHE	" "	39.67	M88 No. 2 Small base	-	-	-
C Cast iron APHE	Black Powder	39.17	"	-	-	-
M38 Shrapnel	" "	39.67	M5 Comb.	-	-	-

Figure 87. Japanese 105-mm ammunition.

Description	Bursting Charge	Proj. wt. incl. fuze (lbs)	Standard fuze	M4 How	M38 How	M89 Gun	M90 Gun	M96 How
Cartridge Case Length (inches)				A 10 B 8.86	?	None	48.03	?
Propellent				No. 2 Flake	No. 1 Flake	No. 4 Strip	No. 5 Strip	No. 2 Flake
Projectile APHE	Picric Acid and TNT	79.34	M88 small base (for H & M)	x	x	-	-	
M95 APHE	Picric Acid and Dinitro.	79.08	M95 AP medium base (H & M)	x	x	-	-	
Cast APHE "A" iron	Picric Acid and TNT	79.34	M88 small base (for H & M)	x	x	-	-	
Cast APHE "D" iron	Picric Acid and TNT	79.34	M88 No. 2 small base (for H & M)	x	x	-	-	
M92 HE	TNT	79.34	M88 Inst. M88 Delay	x	x	-	-	
M92 HE	Ammonium Nitrate Guanidine Nitrate Cyclonite	78.46	"	x	x	-	-	
M11 HE	TNT	80.23	"	x	x	-	-	
M10 HE	TNT	79.34	"	x	x	-	-	
M92 Ptd HE	TNT	68.54	"	x	-	-	-	x
"A" Shrapnel	Black Powder	79.34	M5 Comb. (for H & M)	x	x	-	-	
"B" Shrapnel	Black Powder	79.34	M88 35 Sec Comb. M5 Comb. (for H & M)	x	x	-	-	
M13 Smoke	Picric Acid	73.39	M88 Inst.	x	x	-	-	
M89 Illuminating		80.45	M5 Comb. (for H & M)	x	x	-	x	
APHE	Picric Acid and Dinitro.	98.98	M88 small base (for guns)	-	-	x	x	
M95 APHE	Picric Acid and Dinitro.	101.12	M95 AP medium base (for guns)	-	-	x	x	
M93 HE	TNT	89.48	M90 Double action (for Fd and Mtn guns)	-	-	x	x	
M93 HE	Ammonium Nitrate Guanidine Nitrate Cyclonite	88.14	"	-	-	x	x	
M93 Ptd HE	TNT	88.60	"	-	-	x	x	
Shrapnel	Black Powder	98.06	M5 Comb. (for guns)	-	-	x	x	

Figure 88. Japanese 150-mm ammunition.



## Section V. OPERATIONAL DETAILS OF JAPANESE ARTILLERY.

15. DISASSEMBLY AND OPERATION OF THE MODEL 94 (1934) 75-MM MOUNTAIN GUN. a. Disassembly. (1) *First step: removal of rear trail sections.* The Model 94 gun is split-trailed. Each of the trails is divided into two sections, the division point occurring halfway down each trail leg. The rear sections are joined to the front sections by inserting the fore ends of the rear sections in the front trail sections. The locking levers securing the front and rear trail sections are located behind the junction points on the outer sides of the rear trail sections. They are just forward of the gear carried atop the rear trail section (on right rear section, sponge and staff; on left rear section, aiming posts). To unlock, the spring-loaded knobs on the locking levers are drawn out, and the locking levers

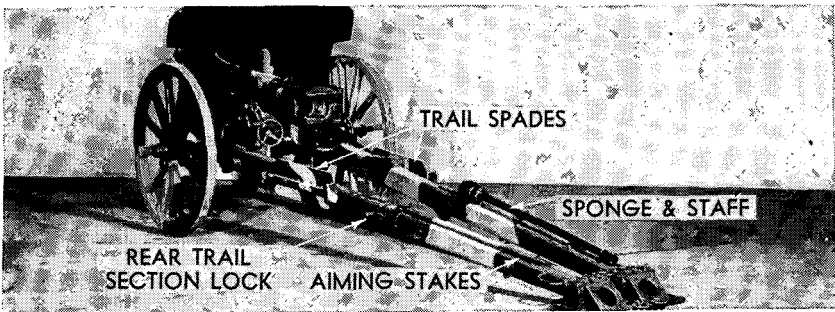


Figure 89. Model 94 (1934) 75-mm mountain gun.

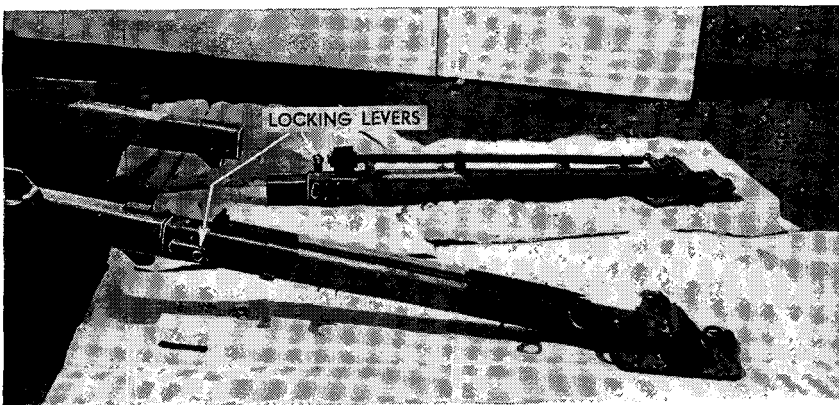


Figure 90. First step: removal of trail sections.

raised to a vertical position. The right trail-locking lever rotates clockwise; the left, counterclockwise. The rear trails sections may then be withdrawn from their sockets in the front trail section.

(2) *Second step: removal of the shield.* The shield is divided vertically into two halves. The halves are joined by an arm located on the rear of the top portion of the shield. This arm is locked in position by two butterfly nuts, one on the rear and one on the front of the shield. To remove the

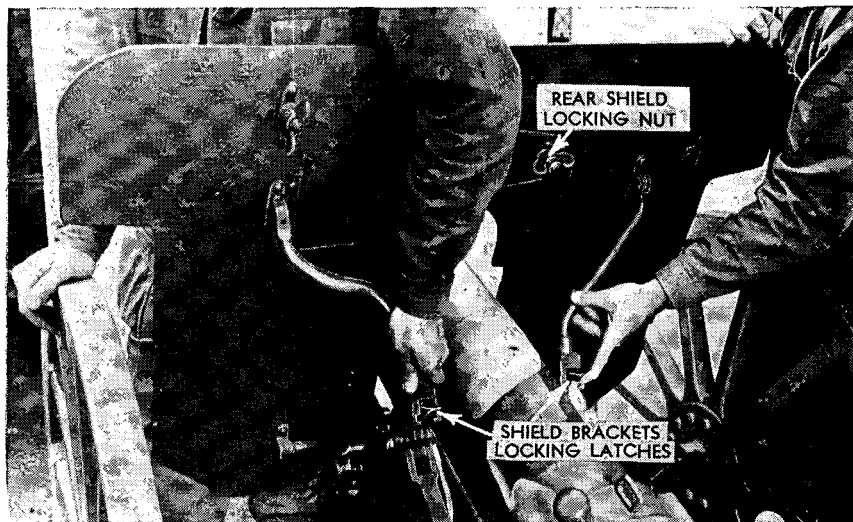


Figure 91. Second step: removal of shield.

shield, the butterfly nuts are loosened, and the shield divided into halves. Next, the two tubular brackets, each supporting the upper part of the shield and locking at points trunnions, are freed. This is accomplished by pressing forward the latches located on the supports at the points at which they lock to the trunnions. Each half of the shield is then moved sideways off the lower supporting brackets.

(3) *Third step: removal of the tube.* The tube is secured to the breech ring by lugs locked in place by a latched collar. The fore part of the tube is held to the cradle by a large **L**-shaped lug on the underside of the tube. To remove the tube, first level the cradle by means of the elevating hand-wheel, then open the breechblock fully and press the extractor lugs forward. Next, rotate in a counterclockwise direction the knob located on the left side of the collar locking holding the tube to the breech ring. Raise this tube lock until it is engaged by the holding pawl located at the base of the movable part of the locking collar. Rotate the tube counterclockwise until the forward **L** lug is free of its cradle retaining slot. The tube may now be lifted from the cradle. After the tube is removed, press the pawl on the locking collar to the left, lower the tube lock, turning the locking knob clockwise to lock.

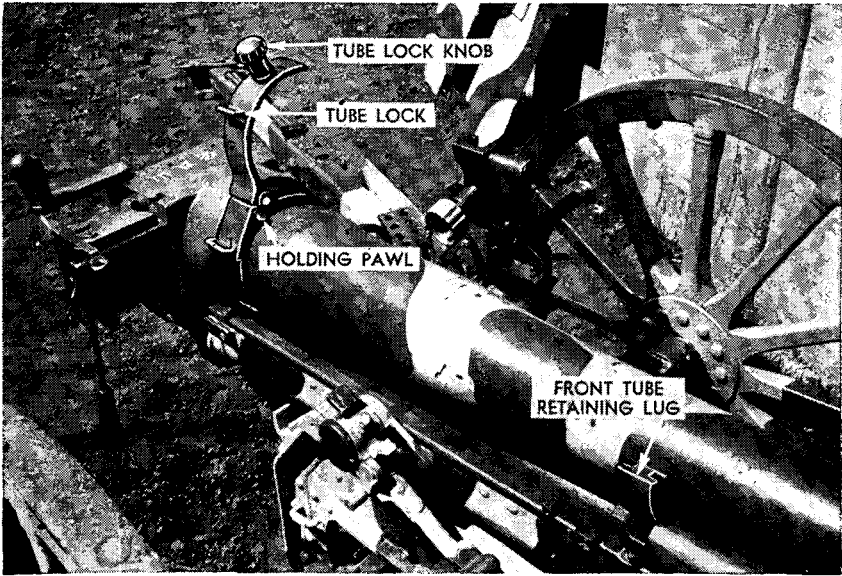


Figure 92. Third step: removal of tube.

(4) *Fourth step: removal of breech.* The breech is held to the cradle by the collar which locks the tube to the breech. Close the breech. Rotate the locking collar counterclockwise, and push the breech about  $\frac{1}{2}$  inch forward. The breech now may be lifted and removed.

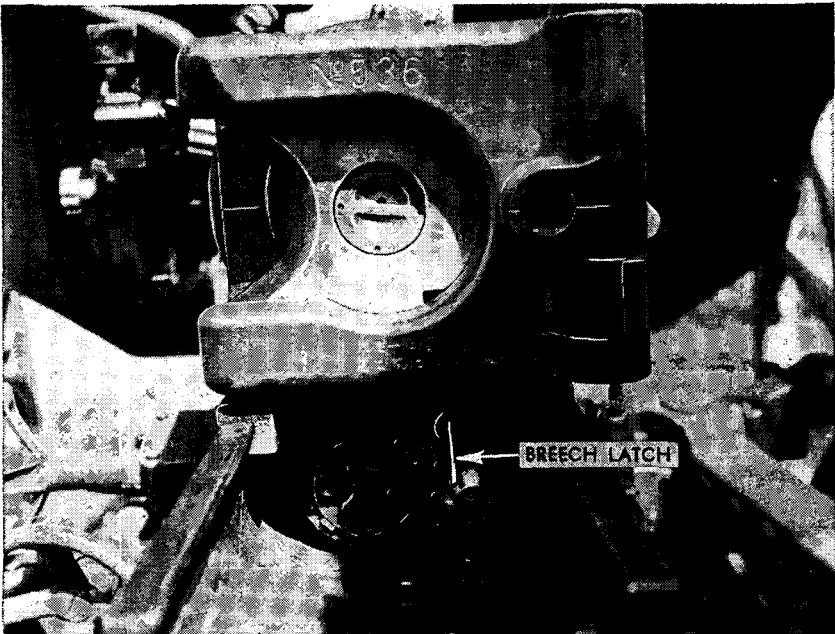


Figure 93. Fourth step: (1) removal of the breech (position of breech latch).



Figure 93. Fourth step: (2) removal of the breech.

(5) *Fifth step: removal of cradle.* The cradle is fastened to the carriage at the top of the elevating arc, and at the trunnions. Depress the cradle slightly below zero elevation. Rotate the trunnion cap locks forward and upward, and open the trunnion caps. Rotate the elevating arc latch lock (located on the left side of the arc near the top) to its rearward position in a counterclockwise direction. Allow the arc to drop. Remove the cradle, and close and lock the trunnion caps.

(6) *Sixth step: removal of front trail sections.* The front trail sections have two sets of locking levers. On the outside of each trail section near its junction with the carriage is a trail locking lever, designed to lock the trail in traveling firing position. Trail removing lugs, each located to the rear of the trail securing locks, assist in retaining the forward trail section.

To remove the front trail sections, spread the trails. Rotate the trail-locking levers to the rear (counterclockwise). Pull the spring-loaded knobs of the trail-securing locks outward, and rotate these locking levers forward until the knobs snap back into position. These knobs should be

facing forward. Turn the trail-removing lugs one-fourth turn down. With one man holding the carriage as a precaution against its falling, close the trails as far as possible, and then reopen until the trail legs drop off.

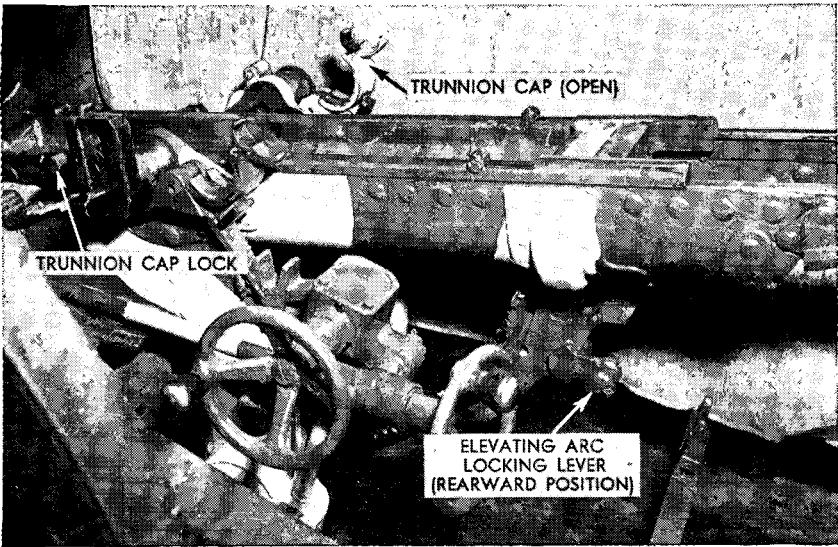
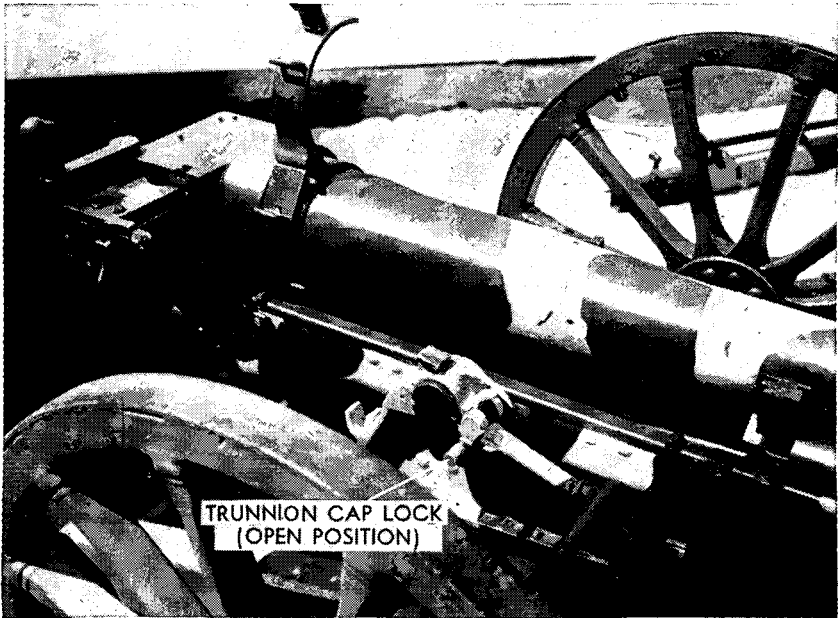


Figure 94. Fifth step: (1) trunnion cap lock; (2) removal of the cradle.

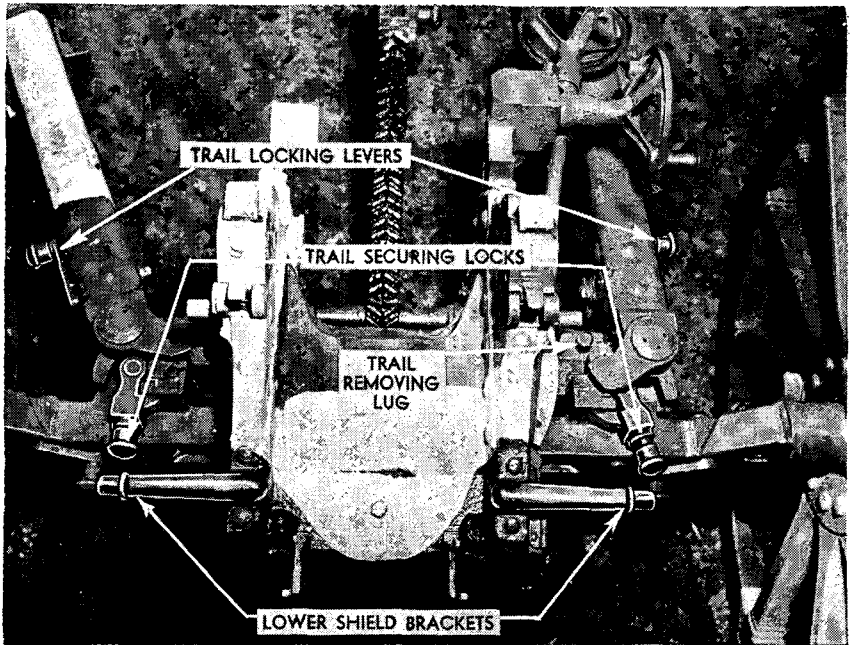


Figure 95. Sixth step: removal of front trail sections.

(7) *Seventh step: removal of wheels.* The wheels are secured to the axle by locking levers with spring-loaded knobs. Pull the knobs outward, and turn the levers inward until approximately paralleled with the axle. The wheels now may be pulled from the axles.

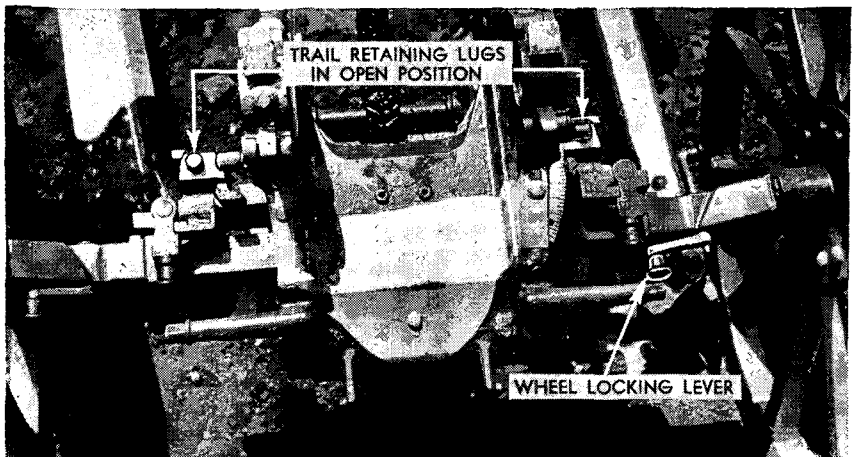
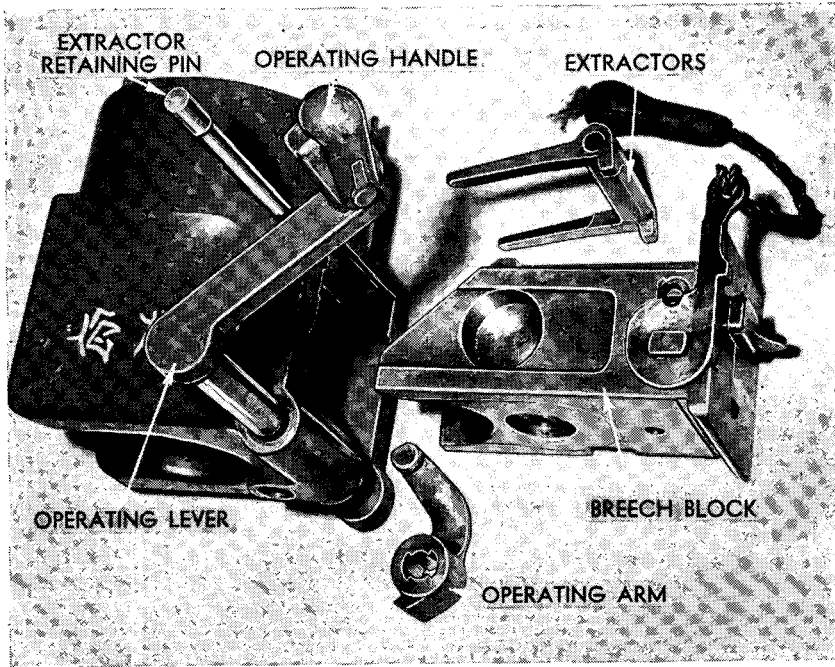


Figure 96. Seventh step: removal of wheels.

**b. Disassembly of Breech Mechanism.** At the rear right corner of the breech ring is located the cylindrical housing for the crankshaft operated by the operating lever. On the upper side of this housing, and on the side of the operating lever, are graven two vertical index lines. Rotate the operating lever until these lines coincide. Lift the operating lever upward and out of the breech ring. Slide the breechblock out of the breech ring toward the right. Slide out the breechblock operating arm (located in the lower part of the breech-ring housing for the operating lever crank-



*Figure 97. Disassembly of breech mechanism.*

shaft). Push the extractor pin upward from the bottom and lift it from the top of the breech ring. Slide the extractors out the right side of the breech ring. With a drift or screw-driver, press down the safety plunger sleeve. With the safety plunger retained in downward position, pull the firing lever as far as possible to the rear, raise it up, and remove it. Remove the spring from the firing-lever recess. Lift out the safety assembly sleeve and safety plunger from its recess. Slide the safety lever from its recess. Slide the firing mechanism from its recess, and left, off the sear and trigger from the firing mechanism. Turn the firing-spring retainer one-fourth turn and lift out the retainer, spring, firing pin, and rubber bushing.

**c. Preparing for Action.** (1) *First step: removal of traveling bar and spreading of trails.* The piece being assembled, place it in firing position. To free the traveling bar, pull outward the cradle-locking latches on the traveling bar until they will slip into open position. Depress the muzzle of the tube by means of the elevating handwheel until the cradle clears the traveling bar. Pull the pin locking the traveling bar to the right trail toward that trail, and then pull the traveling bar toward the left trail. Latch the free end of the traveling bar to its seat on the left-hand trail. Pull the spring-loaded knobs of the trail-locking levers outward (they are located on the outside of the front part of the trails) and rotate the levers upward and forward. Spread the trails.

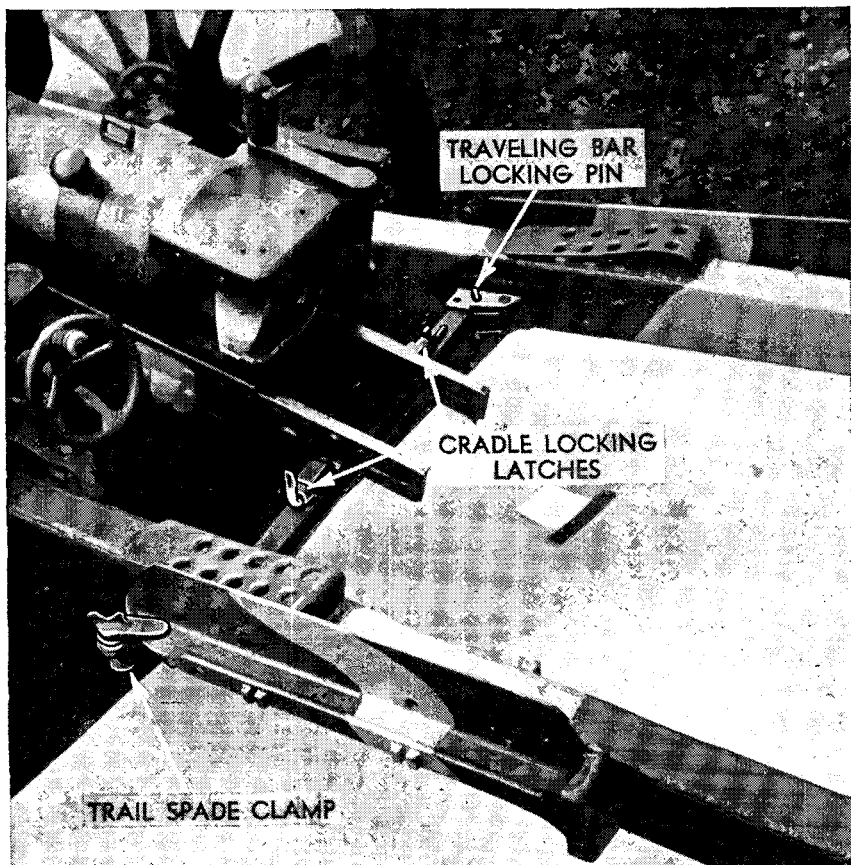


Figure 98. First step: removal of traveling bar.

(2) *Second step: preparation of trail spades.* The trail spades are carried on the outside of each front-trail-section, and are secured there by clamps with butterfly grips. To remove, turn the clamps outward. Raise the plates through 90° angles, and lift away from the trail sections. Drop the



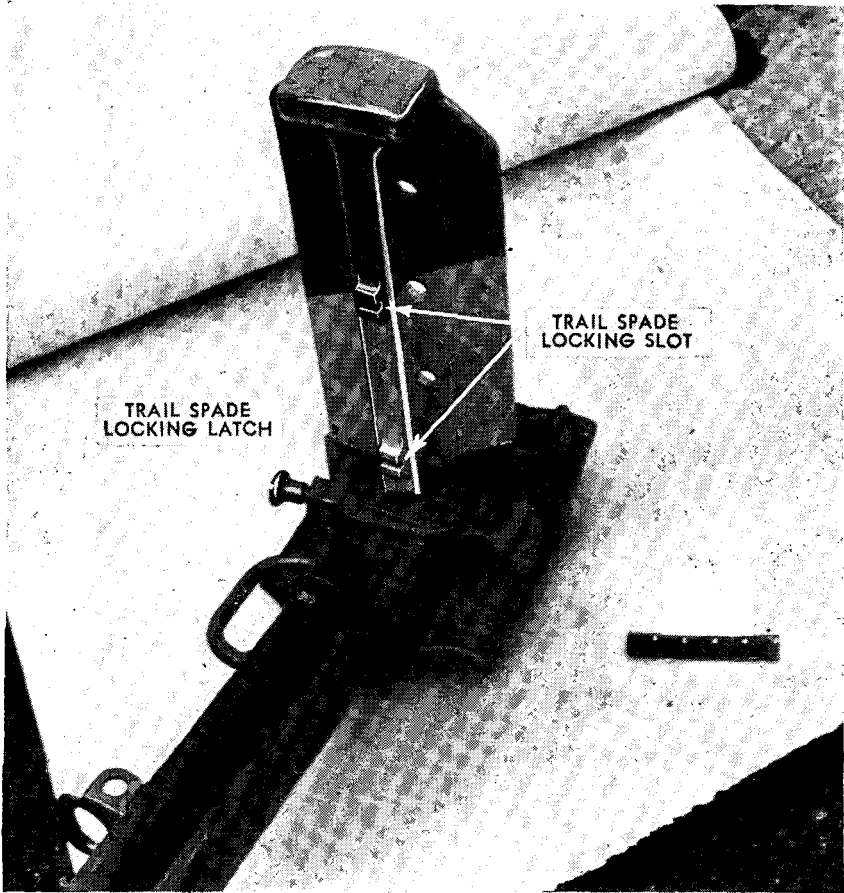


Figure 99. Second step: preparation of trail spades.

spades in the slots on the trail blocks. They may now be driven into the ground. Either the lower or upper slots are used to lock the trail spades in position, depending on the hardness of ground. When the trail spades have been driven in so that the locking latches will secure, pull outward the spring-loaded knob on each locking lever, and push each lever to the rear until the lever engages the locking slots on the corresponding spade.

(3) *Third step: mounting the sight mount.* Using its knob, press the mount latch lever as far forward as it will go. Raise outward the U-shaped latch at the bottom of the mount. Insert the shank of the mount in the slotted seat on the left trunnion of the gun. Pull the knobbed latch handle to the rear as far as it will go.

(4) *Fourth step: adjusting the sight.* (See par. 14n (1). One turn of ele-

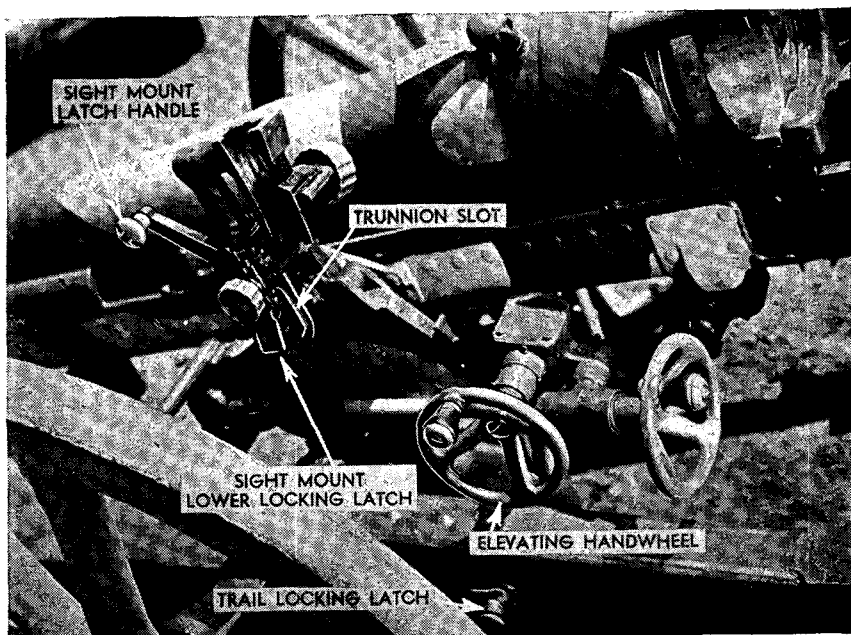


Figure 100. Third step: mounting the sight mount.

vating handwheel clockwise elevates the piece 12 mils, one turn of traversing handwheel clockwise traverses the piece to the right 9 mils.

(5) *Fifth step: checking recoil liquid.* The recoil liquid may be inspected through a window located on the front end of the recoil mechanism housing under the gun tube. (See fig. 103.) With a hammer and drift, knock upward and out the pin retaining the window-cover latch. Raise the latch and unscrew the cover. The recoil liquid should be half way up the window gauge on the recoil cylinder.

## 16. RECOIL AND COUNTERRECOIL SYSTEMS. a. General.

Japanese recoil and counterrecoil systems are of two types. The earlier type is the hydrospring system, which may be found on weapons antedating the Model 4 (1915) 150-mm howitzer. In this group are the 75-mm guns Model 38 (1905) and 38 (Improved), the Model 41 (1908) cavalry gun and obsolete weapons, such as the Model 38 (1905) 120-mm howitzer, the Model 38 (1905) 120-mm howitzer, the Model 38 (1905) 105-mm gun, and the Model 38 (1905) 150-mm howitzer.

Artillery of modern design is characterized by hydropneumatic recoil mechanism. This system may be subdivided into two types: that with counterrecoil mechanisms with a floating piston (Model 88 [1928] 75-mm antiaircraft gun, Model 4 [1915] 150-mm howitzer), and those with the Schneider type of counterrecoil with direct contact between fluid and gas.

In the latter class are the Model 91 (1931) 105-mm howitzer, which is constructed on a Schneider export design; the Model 92 (1932) 105-mm gun; the Model 96 (1936) 150-mm howitzer, and the Model 94 (1934) 75-mm mountain gun. (It is believed that the Model 90 (1930) 75-mm gun, constructed on a Schneider pattern, is also filled with a direct-contact counter-recoil mechanism.) All these weapons with direct contact counterrecoil mechanisms may easily be identified by the liquid level window found on the front end of each cradle.

Observation indicates that the Japanese use a water-and-glycerine mixture in their counterrecoil systems of the hydropneumatic type, and that a mineral oil is used in the recoil cylinders of weapons in this class. It is believed that the Japanese use air instead of nitrogen as the gas filler for hydropneumatic recoil mechanisms, but nitrogen may be used if available. Oxygen is not to be employed under any circumstances. It should be noted that counterrecoil systems of the floating-piston type have purge plugs, to permit exhausting of air or gas when the system is filled with liquid.

In filling Japanese recoil systems, the most convenient air-filling tube is that issued by the Japanese. (See fig. 101.) When a captured air-filling tube is unavailable, an adapter after the pattern shown in figure 102 will permit use of the U. S. air-filling tube and gauge. Pressures to be maintained in hydropneumatic counterrecoil systems of common Japanese artillery pieces are listed below.

WEAPON	GAS PRESSURE	
	kg/cm <sup>2</sup>	lb./sq. in.
Model 88 (1928) 75-mm AA gun	95 to 100	1350 to 1420
Model 91 (1931) 105-mm howitzer	43 to 50	611 to 710
Model 4 (1915) 150-mm howitzer	33	469
Model 96 (1936) 150-mm howitzer	52	738
Model 14 (1925) 105-mm gun	90	1278
Model 92 (1932) 105-mm gun	45 to 50	639 to 710
Model 89 (1929) 150-mm gun	110	1562
Model 94 (1934) 75-mm mountain gun	40	568
Model 95 (1935) 75-mm gun	40	568

For illustrative purposes, detailed procedure has been provided for checking and filling recoil and counterrecoil mechanisms in the Model 4 (1915) 150-mm howitzer, the Model 88 (1928) 75-mm antiaircraft gun, the Model 94 (1934) 75-mm mountain gun, and the Model 92 (1932) 105-mm gun. Procedure for checking and filling recoil and counterrecoil systems of the Model 91 (1931) 105-mm howitzer, and Model 96 (1936) 150-mm howitzer, is similar to that employed for the Model 92 (1932) 105-mm gun. Labeled photographs of the pertinent parts of the Model 91 and Model 96 are appended to indicate location of index windows, filler valves, and drain and purge plugs.

**b. Model 94 (1934) 75-mm Howitzer Recoil Mechanism.** (1) *Checking levels and pressures.* (a) Uncovering index window for checking counterrecoil



Figure 101. Japanese air-filling tube.

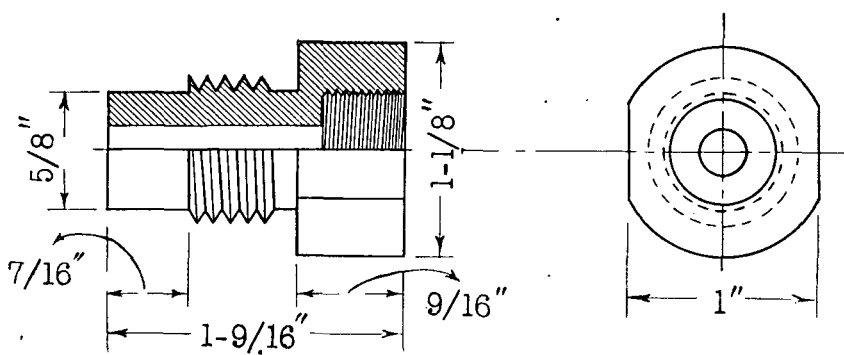


Figure 102. Adapter for fitting U. S. air-filling tube to Japanese recoil and counterrecoil mechanism.

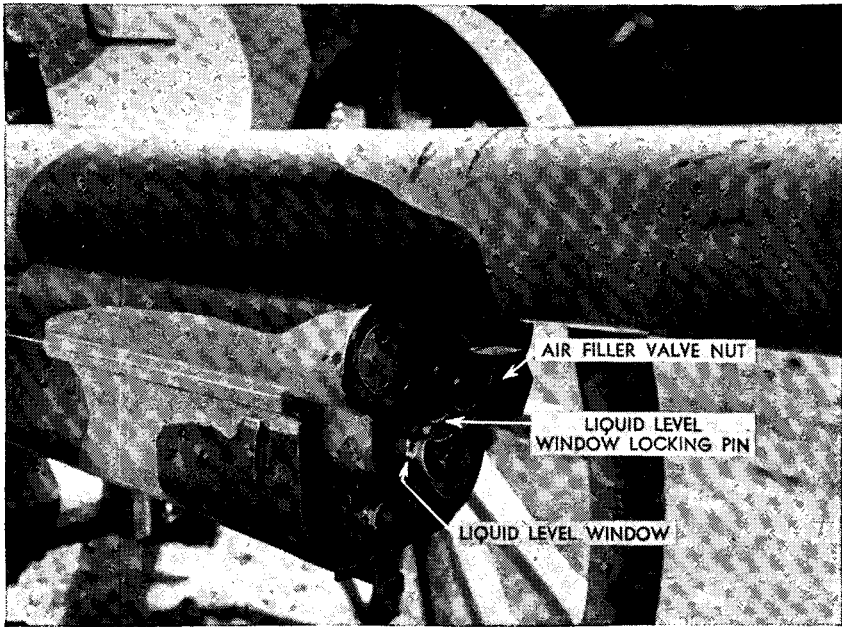


Figure 103. Front end of cradle.

liquid level: Referring to figure 103, remove pin, swing lock out of the way, and remove both nuts.

(b) Checking liquid in counterrecoil systems: place cradle at 0° elevation

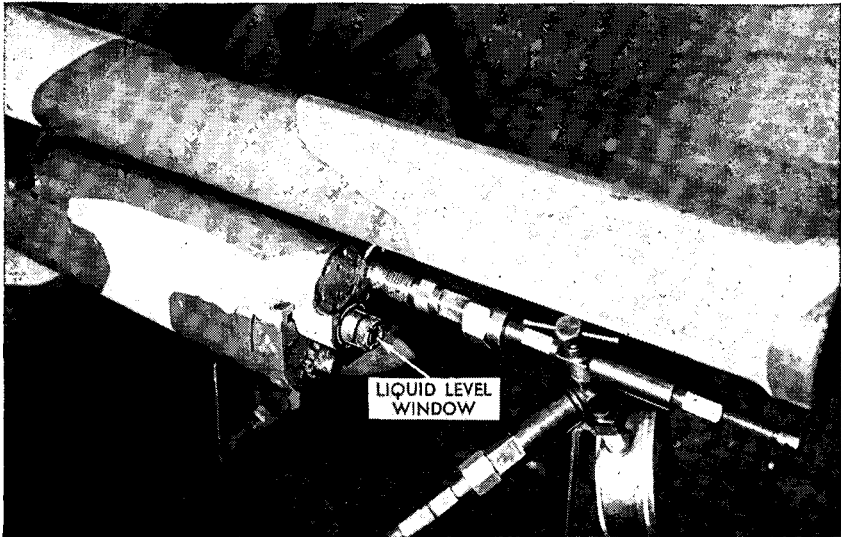


Figure 104. Front end of cradle with adapter (see fig. 102), air-filling tube (C61285), air-filling tube, flexible (C419), gauge (B747), in position for reestablishing gas pressure in counterrecoil system.

and cross level. If liquid level appearing at the COUNTERRECOIL LIQUID LEVEL WINDOW is just at the middle of the window (where a red line appears in the glass) the volume of liquid in the counterrecoil system is correct.

(c) Checking gas pressure in counterrecoil system: Attach adapter, air-filling tube, and gauge as shown in figure 104. Screw PRESSURE RELEASE VALVE in tight. Turn VALVE RELEASE HANDLE until reading can be made on gauge. The correct pressure is 40 kg/cm<sup>2</sup>.

(2) *Exhausting gas from counterrecoil system.* With adapter, air-filling tube, and gauge in position shown in figure 104 (air-filling tube, flexible would not be as shown, and opening would be capped), screw in VALVE RELEASE HANDLE, and open PRESSURE RELEASE VALVE.

(3) *Filling counterrecoil system with liquid.* Release gas from counterrecoil system as explained under (2) above. Bring cradle to 0° elevation and cross level. Pump in liquid until it appears at middle of COUNTERRECOIL LIQUID LEVEL WINDOW. (The correct total liquid in the counterrecoil system is reported to be 1 quart of light mineral oil.)

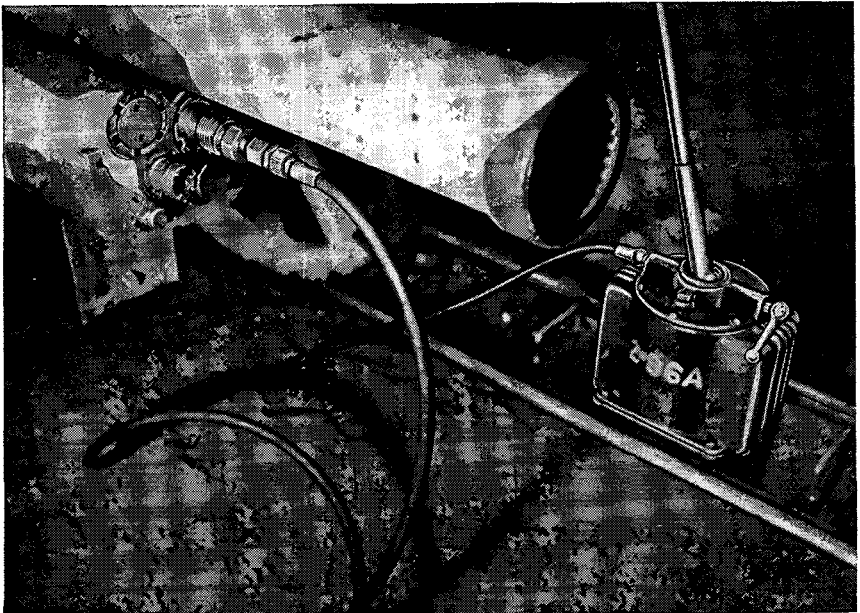


Figure 105. Front end of cradle showing connections for filling counterrecoil system with liquid using the M3 "Blackhawk" liquid pump.

(4) *Reestablishing correct pressure in counterrecoil system.* Attach adapter, air-filling tube, air-filling tube flexible, gauge, and either tank of nitrogen or compressed air. (**Caution:** Under no conditions is oxygen to be used.) Add air or nitrogen until proper pressure (40 kg/cm<sup>2</sup>) is reached.

(5) *Filling recoil cylinder.* Remove cradle and stand on its front end. Remove two plugs. Pour in recoil liquid mineral oil until the cylinder is filled to overflowing. Remove approximately 30cc. Replace plugs. Testing serviceability of recoil mechanism: recoil mechanism should be exercised after charging, if possible.

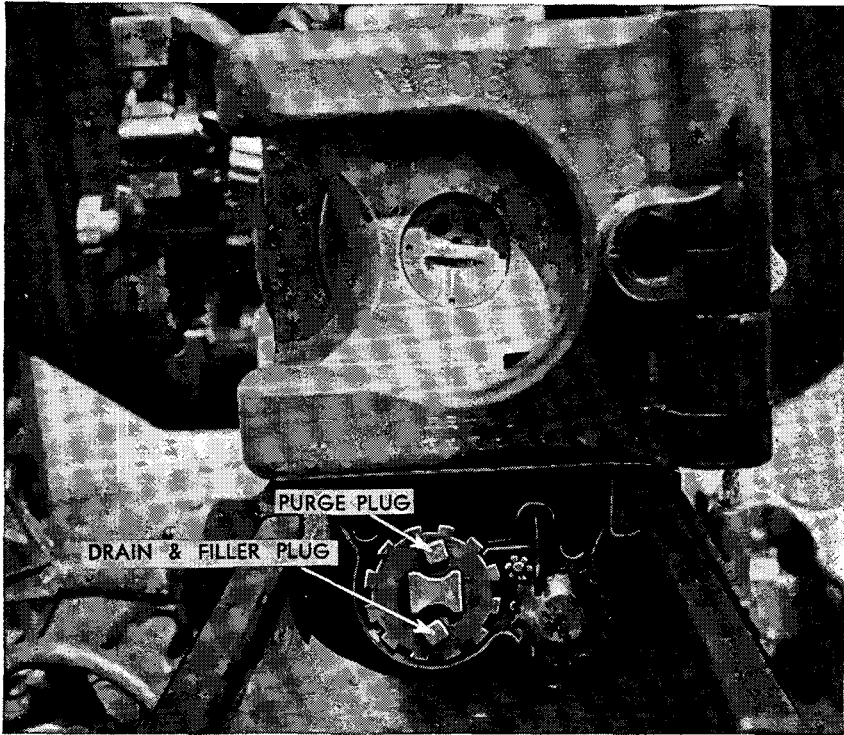


Figure 106. Rear end of cradle.

c. **Model 88 (1928) 75-mm Antiaircraft Gun.** (1) *Checking levels and pressures.* The recoil system of the Model 88 consists of two counterrecoil cylinders, one on each side of the cradle, and a recoil cylinder. The recoil cylinder is located above and between the counterrecoil cylinders, and is well forward on the cradle, even extending for some distance in front of it. Correct gas and liquid level is indicated by index plugs at the rear ends of the two recuperator cylinders. It has been reported that the weapons normally operates with index plug ends opposite the midpoint marks on the index plug-sleeves.

(2) *Checking gas pressure.* To check gas pressure, attach adapter, air-filling tube, and gauge to the air-filler valve located at the front end of the cradle.

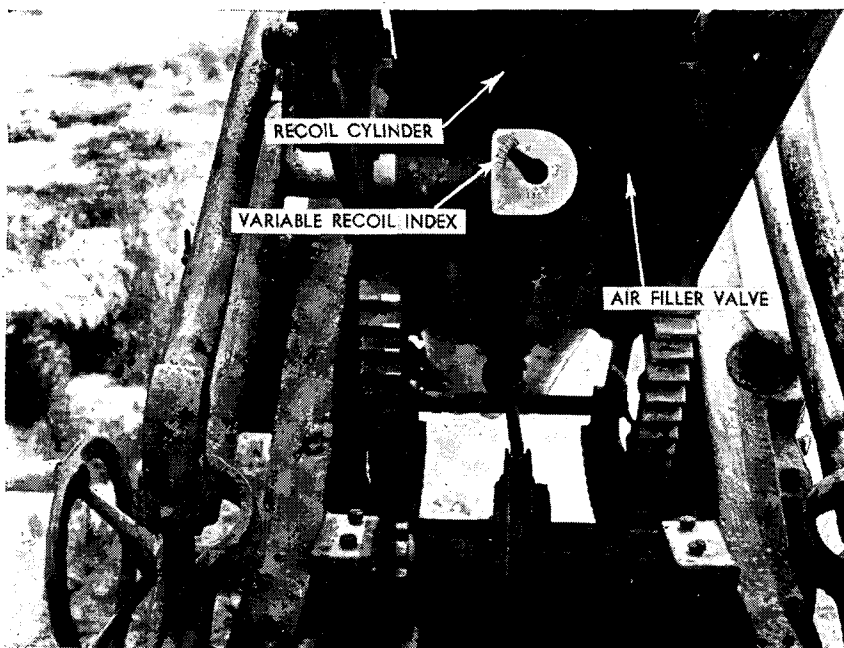


Figure 107. Front end of cradle of Model 88 75-mm antiaircraft gun.

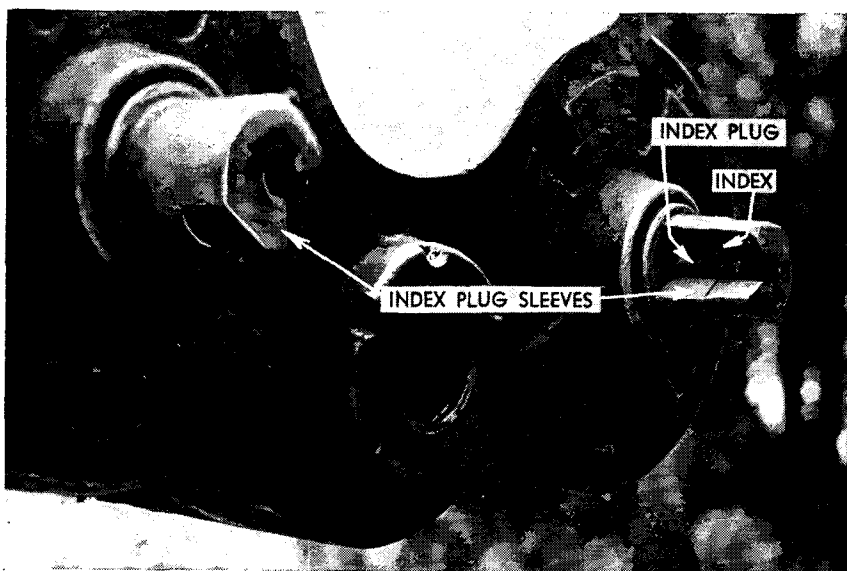


Figure 108. Rear of Model 88 75-mm AA gun showing index plug sleeves.



The U. S. air-filling tube will not fit into the space available unless an elbow adapter is constructed. The Japanese air-and-liquid filler tube, illustrated in figure 101, is the most convenient device to use in this case. Screw pressure-release valve in tight. Turn valve-release handle until reading can be made on the gauge. The correct pressure is 1,350 to 1,420 pounds per square inch (95 to 100 kilo. per sq. cm.).

(3) *Exhausting gas from recoil mechanism.* To exhaust the gas from the recoil mechanism, attach winch cable to keep the tube from falling out of battery. The air-filling tube is positioned as described above. Turn pressure-release valve.

(4) *Filling recoil mechanism with liquid.* To accomplish this operation release gas from system as described above. Bring weapon to 0° elevation



Figure 109. Breech of Model 88 75-mm AA gun, showing piston retainer nut.

and cross level. Unscrew piston retainer nut. Pull tube to the rear until recoil cylinder purge plug is exposed. This plug is located about 12 inches behind the trunnions. Remove this plug. Attach M3 "Blackhawk" fluid pump to the liquid filler valve and add liquid until it comes out the

purge hole. Depress and elevate the tube slightly to make sure that there are no air pockets in the system. (*Note.* In case the recoil system is entirely empty, the two purge holes on top of the recuperator cylinders would also have to be opened until the lower cylinders are full and clear of air pockets.)

(5) *Reestablishing correct pressure in recoil mechanism.* To reestablish the correct pressure, attach adapter, air-filling tube, air-filling tube (flexible), gauge, and a tank of either nitrogen or compressed air. (**Caution:** *Under no conditions is oxygen to be used.*) Add nitrogen or air until the correct pressure—1,350 to 1,420 pounds per square inch—is reached. The mechanism should be exercised after charging.

**d. Model 92 (1932) 105-mm Gun.** (1) *Checking levels and pressures.*

(a) Uncovering index window for checking counterrecoil liquid level: remove pin and swing open protective door, located at front end of cradle.

(b) Checking liquid level in counterrecoil system: Bring cradle to 0° elevation and cross level. If liquid level, appearing in the counterrecoil

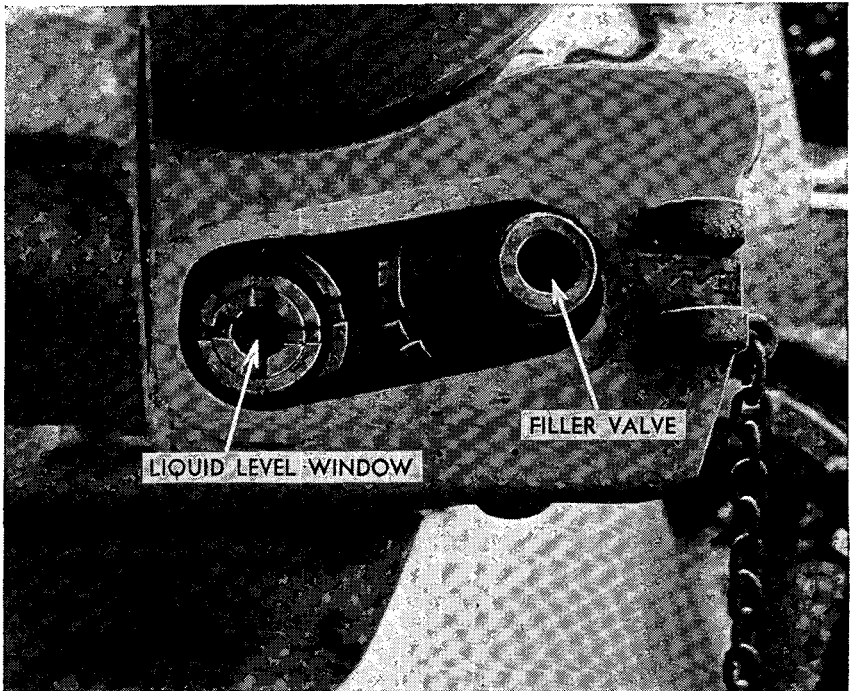


Figure 110. Front end of cradle, with protective door open.

liquid level window (fig. 110), is just at the middle of the window, the volume of liquid in the counterrecoil system is correct.

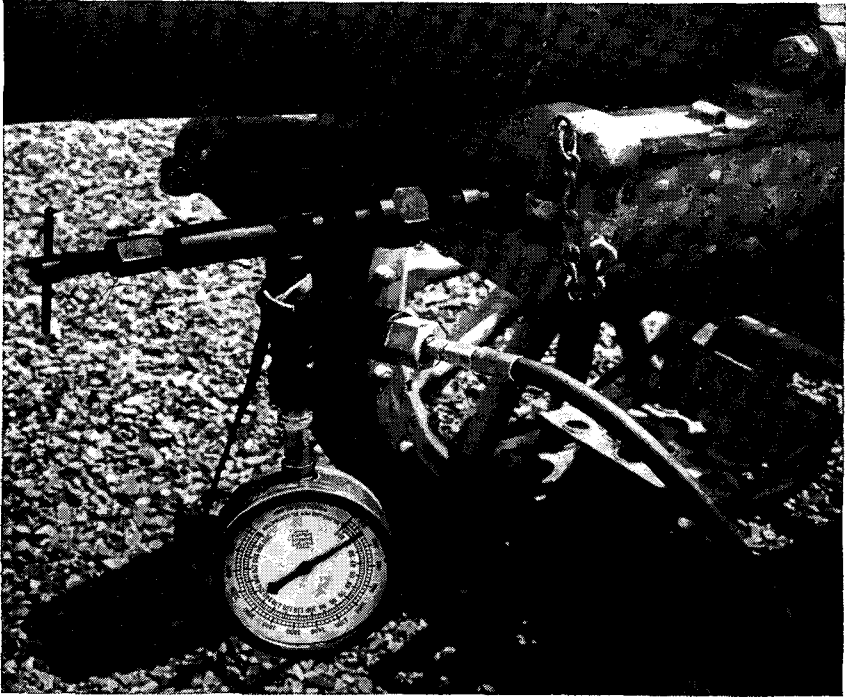


Figure 111. Front end of cradle with adapter (see fig. 102) air-filling tube (C61285), air-filling tube, flexible (C419), gauge (B147), in position for reestablishing gas pressure in counterrecoil system.

(c) *Checking gas pressure in counterrecoil system.* Attach adapter, air-filling tube, and gauge as shown in figure 111. Screw PRESSURE RELEASE VALVE in tight. Turn VALVE RELEASE HANDLE until reading can be made on gauge. The correct pressure is 45–50 kg/cm<sup>2</sup>.

(2) *Exhausting gas from counterrecoil system.* Bring piece to 0° elevation, attach winch to prevent tube from slipping out of battery. With adapter, air-filling tube, and gauge in position shown in figure 111 (air-filling tube, flexible, would not be attached and this hole would be capped), screw in VALVE RELEASE HANDLE, and open PRESSURE RELEASE VALVE.

(3) *Filling counterrecoil system with liquid.* Release gas from counterrecoil system as explained under (2) above. Bring cradle to 0° elevation and cross level. Screw in adapter and attach M3 "Blackhawk" liquid pump in a manner similar to that shown in figures 105 and 111. Pump in fluid until it appears at the middle of the COUNTERRECOIL LIQUID LEVEL WINDOW. (The correct total volume of liquid in the counterrecoil system is reported to be 7 liters.)

(4) *Reestablishing correct pressure in the counterrecoil system.* Attach adapter, air-filling tube and air-filling tube flexible (C419), gauge, and a tank of either nitrogen or compressed air. (**Caution:** Under no condition is oxygen to be used) to the counterrecoil air and liquid filler valve. (See fig. 111.) Add air or nitrogen until proper pressure (45-50 kg/cm<sup>2</sup>) is reached.

(5) *Filling recoil cylinder.* Unscrew purge plug at top of back end of REPLENISHER CYLINDER. (See fig. 112.) If liquid leaks out, unscrew the DRAIN PLUG CAP and drain to level of the PURGE PLUG. If liquid fails to run out of PURGE PLUG, remove FILLER PLUG CAP, and pump in fluid (using M3 "Blackhawk" liquid pump, as described for the Model 94 howitzer) until it runs out PURGE PLUG HOLE. Replace plugs. Testing serviceability of recoil mechanism: Recoil mechanism should be exercised after charging.

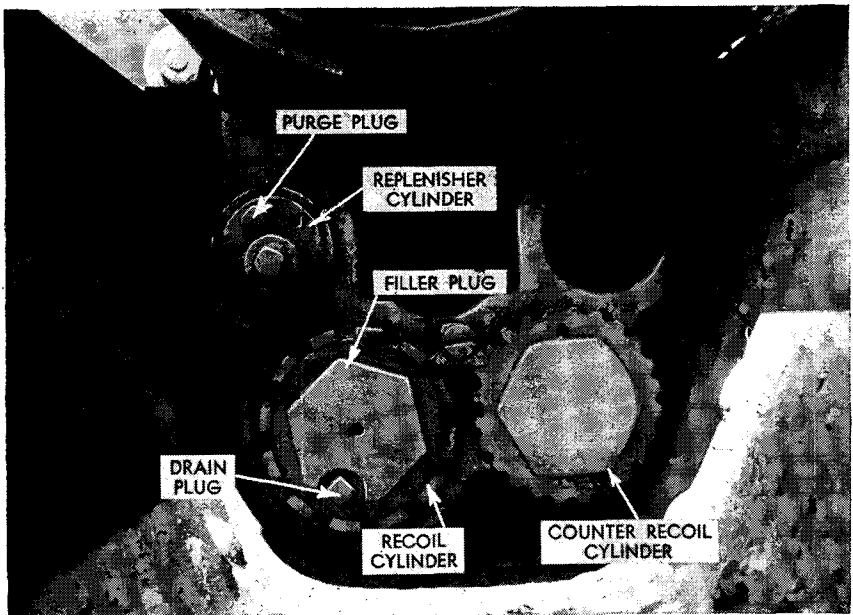


Figure 112. Rear end of cradle.

e. **Model 4 (1915) 150-mm Howitzer.** (1) *Checking levels and pressures*  
(a) *Checking liquid level in recoil mechanism:* There is no window or index by which the liquid level may be checked. In order to be sure you have the correct liquid level, follow the procedure described below for filling recoil mechanism with liquid.

(b) *Checking gas pressure in recoil mechanism:* Bring the howitzer to 0° elevation. Attach adapter, air-filling tube, and gauge as shown in figure 113. (Air-filling tube, flexible, would not be in place, as shown, and the opening would be capped.) Close PRESSURE RELEASE VALVE.

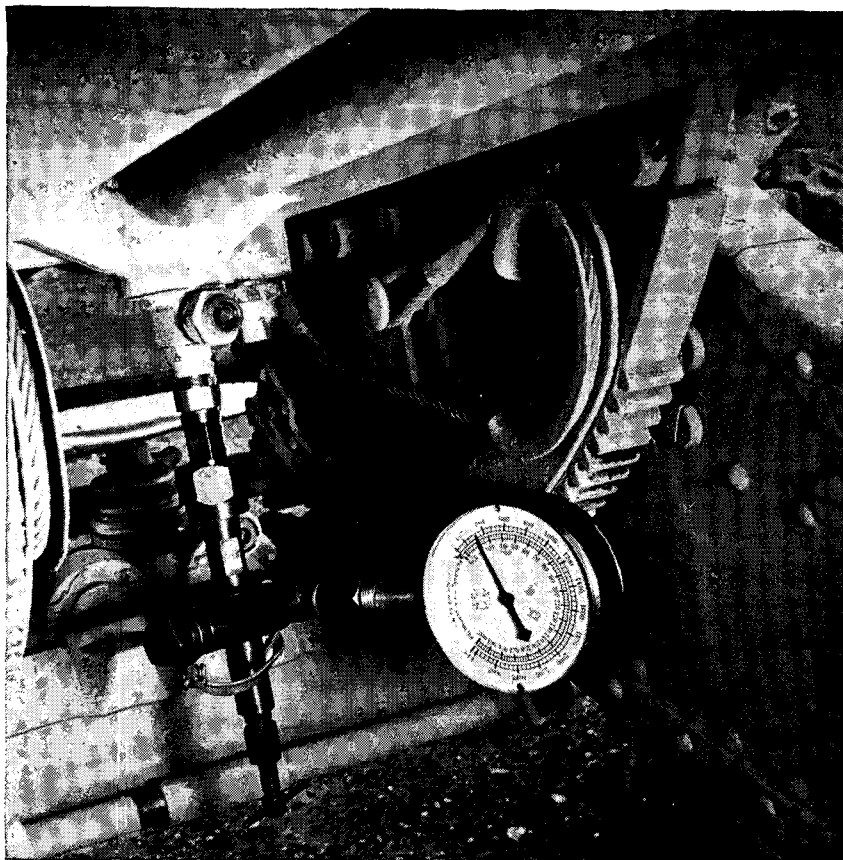


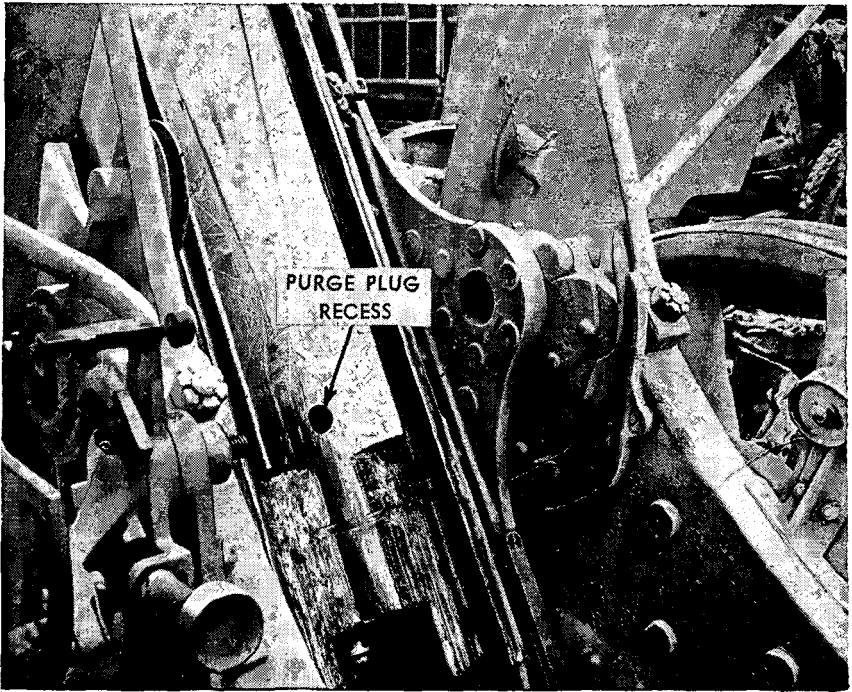
Figure 113. Bottom of cradle with adapter. Air-filling tube and gauge in position for reestablishing proper air pressure in recoil mechanism.

Open AIR-FILLING VALVE until reading can be made on gauge. The correct pressure is 33 kg/cm<sup>2</sup>.

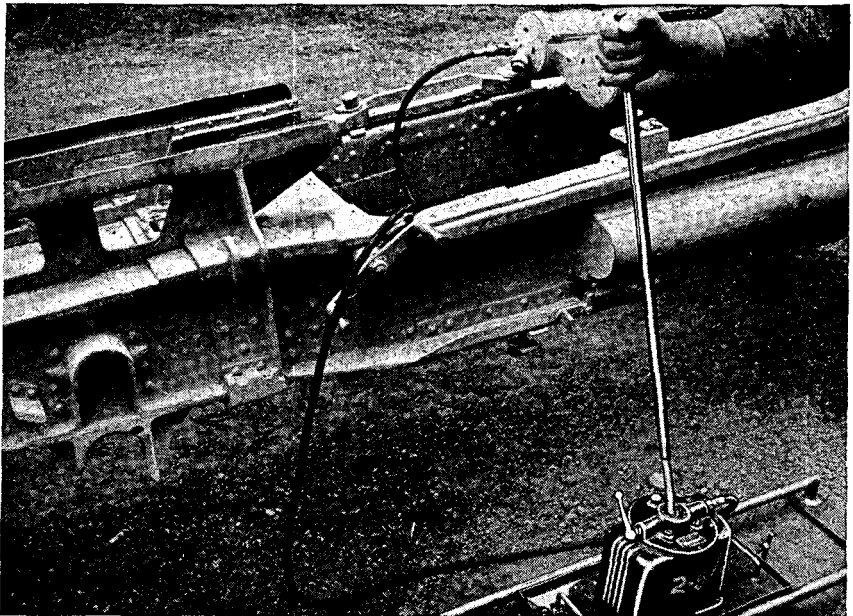
(2) *Exhausting gas from recoil mechanism.* With the weapon at 0° elevation and the wind cable and winch in place to prevent tube from coming out of battery, open AIR-FILLING VALVE.

(3) *Emptying recoil mechanism of liquid.* Bring tube back to its traveling position, attach auxiliary wheels, and remove rear trail section with barrel. Bring recoil mechanism to 0° elevation. Release air from system as described under (2) above. Remove purge plug (fig. 114). Elevate the recoil mechanism (by turning the elevating handwheel) to maximum elevation (approx.), open liquid filling valve, and drain liquid from recoil system

(4) *Filling recoil mechanism with liquid.* Cleanliness is of utmost importance throughout the following steps. Clean receptacles. Care to avoid



*Figure 114. Location of purge plug on cradle of Model 4 (1915) 150-mm howitzer.*



*Figure 115. Rear end of cradle showing the M3 liquid pump attached for adding the recoil mechanism liquid.*

getting dust or dirt into cylinders, or recoil fluids, is essential. Bring recoil mechanism to 0° elevation. Attach the adapter (fig. 101) to the liquid filling hole. Attach hose from the M3 liquid pump (fig. 105) to adapter

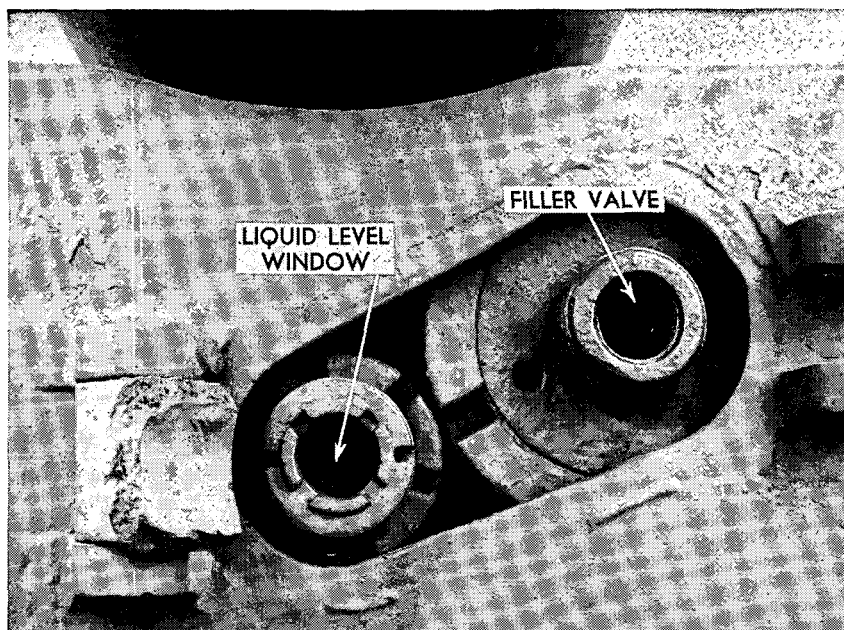


Figure 116. Front of Model 96 (1936) 150-mm howitzer, showing counterrecoil liquid level window and air or liquid filler valve, with protective cover missing.

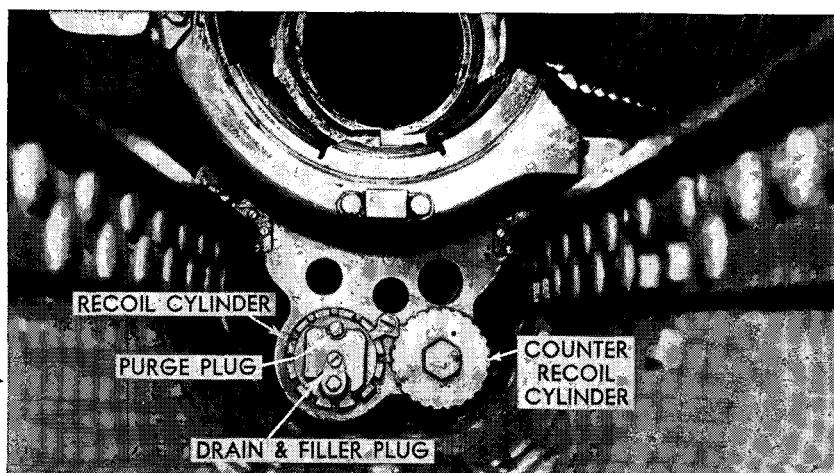


Figure 117. Rear of Model 96 (1936) 150-mm howitzer cradle, showing counterrecoil cylinder (right) and recoil cylinder (left) with drain, filler and purge plugs.

and pump in fluid, counting strokes to determine the amount of fluid added\*, until liquid runs out of the PURGE HOLE. As soon as liquid stops bubbling, pump in more (not counting the strokes on the pump handle by which you are recording the total volume of fluid in the recoil mechanism). When the fluid running out the PURGE HOLE is clear, elevate and depress recoil mechanism slightly to eliminate air pockets, and when you are sure there is no more air in the recoil cylinder, replace the PURGE PLUG. Continue to pump in fluid, counting the strokes again until a total of 14 liters is in the system. Close valve; remove adapter and pump.

(5) *Reestablishing correct pressure in recoil mechanism.* Attach adapter (fig. 102), air-filling tube, air-filling tube, flexible, gauge and either a tank of nitrogen or compressed air (*under no condition is oxygen to be used*). Open air-filling valve, add air or nitrogen until the proper pressure is reached (33 kg/cm<sup>2</sup>). Remove adapter and air-filling tube. Return tube to firing position. Testing serviceability of recoil mechanism: Recoil mechanism should be exercised after charging.

---

\* The liquid pump must have been calibrated.