

UNCLASSIFIED

U
15
U635
no. 19
c. 4

[REDACTED]
U. S. Army Military History Institute

SERIES, NO. 19

31 DECEMBER 1951

JAPANESE INFANTRY WEAPONS

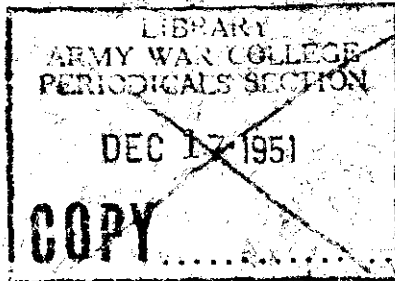

BAKER
OF EC 321
5/6

PREPARED BY

MILITARY INTELLIGENCE DIVISION

WAR DEPARTMENT - *General Staff*
ARMY

[REDACTED]

UNCLASSIFIED

MILITARY INTELLIGENCE DIVISION
WAR DEPARTMENT
WASHINGTON 25, D. C., 31 December 1943

SPECIAL SERIES
No. 19
MID 461

NOTICE

1. Publication of *Special Series* is for the purpose of providing officers with reasonably confirmed information from official and other reliable sources. This issue has been prepared with the assistance of the Ordnance Intelligence Unit, Technical Division, Office of the Chief of Ordnance, and the Foreign Matériel Branch and Mobile Artillery Branch, The Proving Center, Aberdeen Proving Ground.

2. In order to meet the special requirements of certain headquarters, or in order to conserve shipping space, the distribution of any particular issue may be modified from the standard of 150 copies to a division, 30 to a non-divisional group or regiment, 6 to an independent squadron or battalion, and 2 to an independent troop or company. In an infantry division organized according to T/O & E 7 (15 July 1943), redistribution should be effected as follows:

Div Hq.....	7
Div Hq Co.....	2
MP Plat.....	1
Rcn Tp.....	2
Ord Co.....	2
QM Co.....	2
Slg Co.....	2
Engr Bn.....	6
Med Bn.....	6
Div Arty.....	30
Inf Regts (3).....	90
<u>TOTAL, INF DIV.....</u>	<u>150</u>

Hq.....	4
Hq Btry.....	2
Bns (4).....	24
<u>TOTAL, DIV ARTY.....</u>	<u>30</u>

Regtl Hq.....	4
Regtl Hq Co.....	2
Serv Co.....	2
Cn Co.....	2
AT Co.....	2
Bns (3).....	18
<u>TOTAL, INF REGT.....</u>	<u>30</u>

3. In addition to *Special Series*, publications of the Military Intelligence Division include *Tactical and Technical Trends* (biweekly), *Intelligence Bulletin* (monthly), and *Military Reports on the United Nations* (monthly). Distribution to AAF units and installations is made by the Assistant Chief of Air Staff, Intelligence, Army Air Forces, and quantities sent to AGF addresses are recommended by the Commanding General, Army Ground Forces. Requests for additional copies of any MID publication should be made through channels.

4. Every command should circulate available copies among its officers. Reproduction within the military service is permitted provided that (1) the source is stated, (2) the classification is maintained, and (3) one copy of the publication in which the material is reproduced is forwarded to the Dissemination Unit, Military Intelligence Division, War Department, Washington 25, D. C. Comments on this publication and suggestions for future issues may be sent directly to the same address.

RESTRICTED
LIBRARY

UNCLASSIFIED US ARMY WAR COLLEGE
CARLISLE BARRACKS, PA

CONTENTS

	Page
Section I. INTRODUCTION.....	1
II. NOMENCLATURE.....	4
1. GENERAL.....	4
2. MODEL NUMBERS.....	4
3. CALIBERS.....	6
4. COMMON NAMES.....	6
III. PISTOLS AND RIFLES.....	7
5. NAMBU 8-MM PISTOL.....	7
a. General.....	7
b. How to Identify.....	8
c. Characteristics.....	8
d. How to Operate.....	10
e. Ammunition.....	12
f. Maintenance.....	12
g. Accessories.....	14
6. MODEL 14 (1925) 8-MM PISTOL.....	14
a. General.....	14
b. How to Identify.....	15
c. Characteristics.....	16
d. How to Operate.....	18
e. Ammunition.....	18
f. Maintenance.....	19
g. Accessories.....	20
7. MODEL 94 (1934) 8-MM PISTOL.....	21
a. General.....	21
b. How to Identify.....	22
c. Characteristics.....	22
d. How to Operate.....	23
e. Ammunition.....	24
f. Maintenance.....	24
g. Accessories.....	25
8. MODEL 38 (1905) 6.5-MM RIFLE.....	25
a. General.....	25
b. How to Identify.....	27
c. Characteristics.....	27
d. How to Operate.....	31
e. Ammunition.....	32
f. Maintenance.....	32
g. Accessories.....	33

Section III. PISTOLS AND RIFLES—Continued.

	Page
9. MODEL 99 (1939) 7.7-MM RIFLE.....	39
a. General.....	39
b. How to Identify.....	39
c. Characteristics.....	41
d. How to Operate.....	42
e. Ammunition.....	44
f. Maintenance.....	44
IV. GRENADES AND LAND MINES.....	45
10. MODEL 91 (1931) HAND GRENADE.....	45
a. General.....	45
b. How to Identify.....	45
c. Characteristics.....	45
d. How to Operate.....	46
11. MODEL 97 (1937) HAND GRENADE.....	49
a. General.....	49
b. How to Identify.....	49
c. Characteristics.....	49
d. How to Operate.....	50
12. MODEL "KISKA" HAND GRENADE.....	51
a. General.....	51
b. How to Identify.....	51
c. Characteristics.....	51
d. How to Operate.....	53
13. HIGH-EXPLOSIVE STICK HAND GRENADE.....	53
a. General.....	53
b. How to Identify.....	53
c. Characteristics.....	53
d. How to Operate.....	55
14. INCENDIARY STICK HAND GRENADE.....	56
a. General.....	56
b. How to Identify.....	56
c. Characteristics.....	56
d. How to Operate.....	56
15. BANGALORE TORPEDO.....	58
a. General.....	58
b. How to Identify.....	58
c. Characteristics.....	58
d. How to Operate.....	59
16. MODEL 93 (1933) MINE.....	61
a. General.....	61
b. How to Identify.....	61
c. Characteristics.....	61
d. How to Operate.....	62

Section IV. GRENADES AND LAND MINES—Continued.

	Page
17. MODEL 99 (1939) ARMOR-PIERCING MINE.....	63
a. General.....	63
b. How to Identify.....	64
c. Characteristics.....	64
d. How to Operate.....	66
V. GRENADE DISCHARGERS.....	68
18. INTRODUCTION.....	68
19. MODEL 10 (1921) 50-MM GRENADE DISCHARGER.....	68
a. General.....	68
b. How to Identify.....	69
c. Characteristics.....	69
d. How to Operate.....	70
e. Ammunition.....	71
f. Maintenance.....	71
20. MODEL 89 (1929) 50-MM GRENADE DISCHARGER.....	73
a. General.....	73
b. How to Identify.....	74
c. Characteristics.....	74
d. How to Operate.....	76
e. Ammunition.....	80
f. Maintenance.....	85
VI. MACHINE GUNS.....	88
21. MODEL 11 (1922) 6.5-MM LIGHT MACHINE GUN.....	88
a. General.....	88
b. How to Identify.....	89
c. Characteristics.....	89
d. How to Operate.....	91
e. Ammunition.....	94
f. Maintenance.....	94
g. Accessories.....	96
22. MODEL 96 (1936) 6.5-MM LIGHT MACHINE GUN.....	96
a. General.....	96
b. How to Identify.....	97
c. Characteristics.....	97
d. How to Operate.....	98
e. Ammunition.....	103
f. Maintenance.....	103
g. Accessories.....	104
23. MODEL 99 (1939) 7.7-MM LIGHT MACHINE GUN.....	106
a. General.....	106
b. How to Identify.....	107
c. Characteristics.....	108
d. How to Operate.....	111
e. Ammunition.....	112

Section VI. MACHINE GUNS—Continued.

23. MODEL 99 (1939) 7.7-MM LIGHT MACHINE GUN—Con.	Page
f. Maintenance.....	113
g. Accessories.....	115
24. MODEL 92 (1932) 7.7-MM HEAVY MACHINE GUN.....	115
a. General.....	115
b. How to Identify.....	116
c. Characteristics.....	117
d. How to Operate.....	119
e. Ammunition.....	121
f. Maintenance.....	124
g. Accessories.....	127
25. MODEL 93 (1933) 13-MM TWIN HEAVY MACHINE GUN.....	127
a. General.....	127
b. How to Identify.....	128
c. Characteristics.....	128
d. How to Operate.....	128
e. Ammunition.....	133
f. Maintenance.....	134
VII. MORTARS.....	135
26. MODEL 98 (1938) 50-MM MORTAR.....	135
a. General.....	135
b. How to Identify.....	136
c. Characteristics.....	138
d. How to Operate.....	138
e. Ammunition.....	140
f. Maintenance.....	140
27. MODEL 11 (1922) 70-MM MORTAR.....	142
a. General.....	142
b. How to Identify.....	142
c. Characteristics.....	142
d. How to Operate.....	143
e. Ammunition.....	145
f. Maintenance.....	146
28. 70-MM BARRAGE MORTAR.....	146
a. General.....	146
b. How to Identify.....	147
c. Characteristics.....	147
d. How to Operate.....	148
e. Ammunition.....	148
f. Maintenance.....	150
29. MODEL 97 (1937) 81-MM MORTAR.....	150
a. General.....	150
b. How to Identify.....	150

Section VII. MORTARS—Continued.

	<i>Page</i>
29. MODEL 97 (1937) 81-MM MORTAR—Continued.	
c. Characteristics.....	151
d. How to Operate.....	152
e. Ammunition.....	152
f. Maintenance.....	152
30. MODEL 99 (1939) 81-MM MORTAR.....	152
a. General.....	152
b. How to Identify.....	153
c. Characteristics.....	153
d. How to Operate.....	155
e. Ammunition.....	157
f. Maintenance.....	159
31. MODEL 94 (1934) 90-MM MORTAR.....	160
a. General.....	160
b. How to Identify.....	160
c. Characteristics.....	160
d. How to Operate.....	162
e. Ammunition.....	164
f. Maintenance.....	168
VIII. ANTITANK AND INFANTRY GUNS.....	170
32. MODEL 97 (1937) 20-MM ANTITANK RIFLE.....	170
a. General.....	170
b. How to Identify.....	170
c. Characteristics.....	171
d. How to Operate.....	172
e. Ammunition.....	175
f. Maintenance.....	175
33. MODEL 98 (1938) 20-MM ANTI-AIRCRAFT-ANTITANK MACHINE CANNON.....	177
a. General.....	177
b. How to Identify.....	178
c. Characteristics.....	179
d. How to Operate.....	181
e. Ammunition.....	182
f. Maintenance.....	185
g. Accessories.....	187
34. MODEL 11 (1922) 37-MM GUN.....	188
a. General.....	188
b. How to Identify.....	190
c. Characteristics.....	190
d. How to Operate.....	190
e. Ammunition.....	193
f. Maintenance.....	194

Section VIII. ANTITANK AND INFANTRY GUNS—Continued.

	Page
35. MODEL 94 (1934) 37-MM GUN.....	194
a. General.....	194
b. How to Identify.....	195
c. Characteristics.....	195
d. How to Operate.....	198
e. Ammunition.....	200
f. Maintenance.....	203
g. Accessories.....	206
36. MODEL 1 (1941) 47-MM GUN.....	206
a. General.....	206
b. How to Identify.....	206
c. Characteristics.....	208
d. How to Operate.....	209
e. Ammunition.....	209
37. MODEL 92 (1932) 70-MM HOWITZER (BATTALION GUN).....	210
a. General.....	210
b. How to Identify.....	211
c. Characteristics.....	211
d. How to Operate.....	213
e. Ammunition.....	216
f. Maintenance.....	218
g. Accessories.....	219
38. MODEL 41 (1908) 75-MM MOUNTAIN (INFANTRY) GUN.....	222
a. General.....	222
b. How to Identify.....	223
c. Characteristics.....	223
d. How to Operate.....	225
e. Ammunition.....	226
f. Maintenance.....	232
IX. SMALL-ARMS AMMUNITION.....	234
39. INTRODUCTION.....	234
40. COLOR OF BANDS.....	234
41. MODEL 38 (1905) 6.5-MM AMMUNITION.....	234
a. How to Identify.....	234
b. Where to Use.....	235
42. MODEL 38 (1905) 6.5-MM REDUCED-CHARGE AMMUNITION.....	235
a. How to Identify.....	235
b. Where to Use.....	236
43. 7.7-MM AMMUNITION.....	236
a. How to Identify.....	236
b. Where to Use.....	237
44. 8-MM PISTOL AMMUNITION.....	238

	Page
APPENDIX	239
45. GENERAL.....	239
46. SNIPER'S 6.5-MM RIFLE.....	239
47. LONG 7.7-MM RIFLE.....	240
48. MODEL 97 (1937) 7.7-MM TANK MACHINE GUN (GROUND MOUNT).....	240

ILLUSTRATIONS

Figure	Page
1. Organization and armament of a Japanese infantry regiment.....	XIV
2. <i>Nambu</i> 8-mm pistol (left side).....	7
3. <i>Nambu</i> 8-mm pistol (three-quarter view), showing marking on right side.....	9
4. <i>Nambu</i> 8-mm pistol (top view).....	10
5. Cross section of <i>Nambu</i> 8-mm pistol in firing position.....	11
6. Cross section of <i>Nambu</i> 8-mm pistol, showing recoil.....	12
7. <i>Nambu</i> 8-mm pistol with wooden combination shoulder-stock- holster attached.....	14
8. Model 14 (1925) 8-mm pistol (left side).....	15
9. <i>Nambu</i> 8-mm pistol (left) and Model 14 (1925) 8-mm pistol (right)..	16
10. Cross section of Model 14 (1925) 8-mm pistol.....	17
11. Model 14 (1925) 8-mm pistol (right side), showing lanyard.....	20
12. Model 94 (1934) 8-mm pistol (left side), showing also holster and spare magazine.....	21
13. Model 38 (1905) 6.5-mm rifle, showing bolt closed.....	25
14. Model 38 (1905) 6.5-mm rifle, showing also bayonet in scabbard..	25
15. Two views of Model 38 (1905) 6.5-mm carbine, showing also bayonet scabbard.....	26
16. Three views of Model 44 (1911) 6.5-mm cavalry carbine.....	28
17. Model 38 (1905) 6.5-mm rifle, showing its unusual length.....	29
18. Close-up of bolt and leaf sight of Model 38 (1905) 6.5-mm rifle..	30
19. Model 38 (1905) 6.5-mm rifle with bayonet attached, showing bolt open with cartridge clip about to be inserted.....	31
20. Model 30 (1897) bayonet and accessories.....	33
21. Ammunition belt and pouches, and bayonet frog.....	34
22. Armor-piercing rifle grenade and cup-type grenade launcher....	35
23. Cross section of armor-piercing rifle grenade, showing hollow charge.....	36
24. High-explosive rifle grenade and spigot-type grenade launcher..	37
25. Rifle grenades and accessories.....	38
26. Model 99 (1939) 7.7-mm rifle: ① top view; ② right side, with monopod down; ③ bottom view, showing hinged floor plate open, and sling; ④ left side, showing sight raised.....	40
27. Model 38 (1905) 6.5-mm rifle (top), Model 38 (1905) 6.5-mm carbine (center), and Model 99 (1939) 7.7-mm rifle (bottom)..	41

Figure	Page
28. Model 99 (1939) 7.7-mm rifles being cleaned.....	43
29. Model 91 (1931) hand grenade.....	47
30. Two views of packing box for Model 91 (1931) hand grenades (20 grenades).....	48
31. Model 89 (1929) shell (left), Model 91 (1931) hand grenade (left center), Model 97 (1937) hand grenade (right center), and Model "Kiska" hand grenade (right).....	50
32. Cross section of Model "Kiska" hand grenade.....	52
33. High-explosive stick hand grenade.....	54
34. Incendiary stick hand grenade.....	57
35. Bangalore torpedo: ① ready for use and ② with fuze detached for shipment.....	59
36. Fuze used in bangalore torpedo.....	60
37. Model 93 (1933) mine.....	61
38. Cross section of Model 93 (1933) mine.....	62
39. Model 99 (1939) armor-piercing mine and accessories.....	64
40. Diagrammatic drawings of Model 99 (1939) armor-piercing mine (top, right) with its carrying pouch (top, left) and cross section of fuze assembly (bottom).....	65
41. Model 99 (1939) armor-piercing mine disassembled.....	66
42. Model 10 (1921) 50-mm grenade discharger.....	69
43. Three views of Model 10 (1921) 50-mm grenade discharger: ① assembled, ② assembled for carrying, and ③ disassembled.....	72
44. Model 89 (1929) 50-mm grenade discharger.....	75
45. Model 89 (1929) 50-mm grenade discharger, showing also canvas carrying case.....	76
46. Firing Model 89 (1929) 50-mm grenade discharger from kneeling position.....	77
47. Firing Model 89 (1929) 50-mm grenade discharger from prone position.....	78
48. Modified version of Model 89 (1929) 50-mm grenade discharger..	78
49. Diagrammatic drawings of Model 89 (1929) 50-mm grenade discharger, showing range scales (left) and cross section of firing mechanism (right).....	79
50. Two types of ammunition fired in Model 89 (1929) 50-mm grenade discharger.....	80
51. 50-mm incendiary grenade for use in Model 89 (1929) 50-mm grenade discharger.....	81
52. Packing box for fuzes used in Model 89 (1929) 50-mm shells (100 fuzes).....	82
53. Two views of packing box for Model 89 (1929) 50-mm shells, showing method of packing individual shells (40 rounds with- out fuzes).....	82

Figure	Page
54. Crate of five Model 89 (1929) 50-mm shells used in Model 89 (1929) 50-mm grenade discharger.....	83
55. Disassembled parts of Model 89 (1929) 50-mm grenade discharger.....	87
56. Model 11 (1922) 6.5-mm light machine gun (left side).....	88
57. Close-up of feed hopper (empty) of Model 11 (1922) 6.5-mm light machine gun.....	90
58. Loaded feed hopper of Model 11 (1922) 6.5-mm light machine gun.....	91
59. Diagrammatic cross section of Model 11 (1922) 6.5-mm light machine gun, showing also various parts.....	92
60. Model 11 (1922) 6.5-mm light machine gun, showing also accessories.....	95
61. Model 96 (1936) 6.5-mm light machine gun partially disassembled.....	99
62. Diagrammatic cross section of Model 96 (1936) 6.5-mm light machine gun, showing also various parts.....	99
63. Firing Model 96 (1936) 6.5-mm light machine gun from standing position.....	100
64. Model 96 (1936) 6.5-mm light machine guns with bipods attached.....	105
65. Model 99 (1939) 7.7-mm light machine gun, showing adjustable rear monopod.....	107
66. Close-up of Model 99 (1939) 7.7-mm light machine gun, showing method of withdrawing barrel.....	108
67. Model 96 (1936) 6.5-mm light machine gun (left) and Model 99 (1939) 7.7-mm light machine gun (right).....	110
68. Model 92 (1932) 7.7-mm heavy machine gun (right side).....	116
69. Model 92 (1932) 7.7-mm heavy machine gun (rear view).....	118
70. Model 92 (1932) 7.7-mm heavy machine gun (left side).....	119
71. Model 93 (1933) telescopic sight (left) and Model 94 (1934) telescopic sight (right).....	120
72. Base for telescopic sight (top view).....	122
73. Base for telescopic sight (right side).....	122
74. Model 96 (1936) telescopic sight.....	123
75. Model 92 (1932) 7.7-mm heavy machine gun equipped with Model 96 (1936) telescopic sight.....	124
76. Model 92 (1932) 7.7-mm heavy machine gun disassembled.....	125
77. Model 92 (1932) 7.7-mm heavy machine gun, showing tool and spare-parts box.....	126
78. Model 93 (1933) 13-mm twin heavy machine gun (left side).....	129
79. Model 93 (1933) 13-mm twin heavy machine gun, showing maximum elevation.....	130
80. Antiaircraft sight on Model 93 (1933) 13-mm twin heavy machine gun.....	131

CONTENTS

XI

Figure	Page
81. Receiver of Model 93 (1933) 13-mm twin heavy machine gun as seen from above.....	132
82. Model 98 (1938) 50-mm mortar assembled, with cleaning tool..	136
83. Stick bombs which are inserted in muzzle of Model 98 (1938) 50-mm mortar.....	137
84. Adjusting graduated range slide on Model 98 (1938) 50-mm mortar.....	139
85. Base of Model 98 (1938) 50-mm mortar, showing primer seat..	140
86. Model 98 (1938) 50-mm mortar in carrying box.....	141
87. Model 11 (1922) 70-mm mortar.....	143
88. Gunner's quadrant with carrying case.....	144
89. 70-mm barrage mortars, captured in the Aleutians.....	147
90. 70-mm barrage mortar, showing spike and block used as balance..	148
91. Shell used in 70-mm barrage mortar and its method of operating..	149
92. Front view of Japanese Model 97 (1937) 81-mm mortar (left) and U. S. 81-mm mortar, M1 (right).....	151
93. Model 99 (1939) 81-mm mortar and shell.....	154
94. Mortar sight.....	154
95. Unloading Model 99 (1939) 81-mm mortar.....	156
96. Two views of packing box for Model 100 (1940) shells used in Model 99 (1939) 81-mm mortar (four complete rounds).....	158
97. Model 99 (1939) 81-mm mortar disassembled.....	159
98. Model 94 (1934) 90-mm mortar.....	161
99. Laying-in Model 94 (1934) 90-mm mortar.....	163
100. Loading Model 94 (1934) 90-mm mortar.....	164
101. Model 94 (1934) 90-mm mortar shell.....	165
102. Incendiary shell for Model 94 (1934) 90-mm mortar.....	166
103. Model 94 (1934) 90-mm mortar shell with two views of its packing box (two complete rounds).....	167
104. Model 94 (1934) 90-mm mortar disassembled.....	168
105. Model 97 (1937) 20-mm antitank rifle (right side).....	171
106. Model 97 (1937) 20-mm antitank rifle (left rear view).....	173
107. Model 97 (1937) 20-mm antitank rifle with shield and rear carrying handles in place.....	173
108. Model 97 (1937) 20-mm antitank rifle with shield and front carrying handles in place.....	174
109. Model 97 (1937) 20-mm antitank rifle disassembled.....	176
110. Model 98 (1938) 20-mm antiaircraft-antitank machine cannon in traveling position.....	177
111. Model 38 (1938) 20-mm antiaircraft-antitank machine cannon in action.....	178
112. Model 98 (1938) 20-mm antiaircraft-antitank machine cannon (left side).....	179

Figure	Page
113. 20-mm high-explosive round for Model 98 (1938) antiaircraft-antitank machine cannon.....	182
114. 20-mm high-explosive tracer shell.....	183
115. Cross section of point-detonating fuze used in 20-mm high-explosive tracer shell.....	184
116. 20-mm armor-piercing round with cardboard container.....	185
117. Packing box for Model 100 (1940) 20-mm armor-piercing ammunition (70 complete rounds).....	186
118. Magazine of Model 98 (1938) 20-mm antiaircraft-antitank machine cannon.....	187
119. Two views of Model 11 (1922) 37-mm gun, showing accessories.....	188
120. Model 11 (1922) 37-mm gun in action.....	189
121. Method of carrying Model 11 (1922) 37-mm gun by hand.....	189
122. Close-up of breech of Model 11 (1922) 37-mm gun.....	191
123. Telescopic sight mounted on Model 11 (1922) 37-mm gun.....	192
124. Breechblock operating cam of Model 11 (1922) 37-mm gun in lower, or nonautomatic, position.....	193
125. Model 94 (1934) 37-mm gun (right side).....	195
126. Model 94 (1934) 37-mm gun, showing parts.....	196
127. Armor-piercing (left) and high-explosive (right) shells for Model 94 (1934) 37-mm gun.....	201
128. Cross section of Model 94 (1934) high-explosive shell.....	202
129. Cross section of small instantaneous nose fuze used in Model 94 (1934) high-explosive shell.....	202
130. Cross section of Model 94 (1934) armor-piercing shell.....	202
131. Cross section of base fuze used in Model 94 (1934) armor-piercing shell.....	203
132. Two views of metal carrying case for 37-mm shells used in Model 94 (1934) 37-mm gun (12 complete rounds).....	205
133. Model 1 (1941) 47-mm gun (right side).....	207
134. Model 1 (1941) 47-mm gun (front view).....	207
135. Close-up of breech of Model 1 (1941) 47-mm gun.....	208
136. Model 92 (1932) 70-mm howitzer with trails closed.....	210
137. Model 92 (1932) 70-mm howitzer with breech and trails open.....	211
138. Model 92 (1932) 70-mm howitzer with trails open.....	212
139. Panoramic artillery sight.....	214
140. Model 92 (1932) 70-mm howitzer (battalion gun) in action.....	215
141. 70-mm high-explosive shell for Model 92 (1932) 70-mm howitzer.....	217
142. Gun-carriage type of packing box for 70-mm high-explosive shells (eight complete rounds).....	219
143. Model 92 (1932) 70-mm howitzer captured on Guadalcanal.....	220
144. Metal carrying case for 70-mm high-explosive shells (five complete rounds).....	221

CONTENTS

XIII

Figure	Page
145. Manner of packing 70-mm high-explosive shells (three complete rounds).....	222
146. Model 41 (1908) 75-mm mountain (infantry) gun.....	223
147. Gun crew of Model 41 (1908) 75-mm mountain (infantry) gun in action.....	224
148. 75-mm armor-piercing round.....	227
149. Fuzes for 70- and 75-mm shells: instantaneous type (left) and delayed-action type (right).....	228
150. Packing box for Model 97 (1937) 75-mm high-explosive shells (two complete rounds).....	229
151. Packing box for 75-mm armor-piercing shells (four complete rounds).....	229
152. Metal carrying case for 75-mm high-explosive shells (three complete rounds).....	230
153. Metal carrying case for 75-mm high-explosive shells (six complete rounds).....	231
154. Label and markings used on box of Model 38 (1905) 6.5-mm semirimmed, reduced-charge ball ammunition.....	236
155. Label and markings used on box of Model 92 (1932) 7.7-mm ammunition.....	237
156. Infantry small-arms ammunition chart.....	238
157. Sniper's 6.5-mm rifle.....	239
158. Long 7.7-mm rifle with muzzle cover attached.....	241
159. Model 97 (1937) 7.7-mm tank machine gun on ground mount..	241
160. Schematic drawing, indicating ranges of principal Japanese infantry weapons.....	<i>follows</i> 241
— Graphic comparison of millimeters and inches.....	<i>inside back cover</i>

Section I. INTRODUCTION

The purpose of this study is to provide a concise description of Japanese infantry weapons. The successful operations of United Nations forces on Guadalcanal, New Guinea, New Georgia, and the Aleutians have resulted in the capture of large amounts of Japanese matériel. Many types of this matériel are available, and wherever possible, the descriptions are based upon an examination of actual weapons. Furthermore, reports from the various theaters of war have been compared and evaluated in order to present in the simplest and most compact form all the pertinent information concerning the main Japanese infantry weapons. No attempt has been made to provide all the details that would be required for permanently servicing them, but enough are given to enable U. S. troops to identify, to deal with, and, if necessary, to operate them.

As is well known, the industrialization of Japan took place in relatively recent times, and Japan's experience in the manufacture of modern weapons is comparatively brief. As a consequence, since the Japanese purchased European and American weapons and imitated them in their factories, the design of their weapons inevitably reflects their studies of foreign matériel. In some cases the imitation is meticulous and slavish, but it would be a mistake to conclude that the Japanese are incapable of manufacturing first-class weap-

ons or of creating original designs of their own. All reports agree that the Japanese infantry encountered in recent combats has been well armed. While antitank weapons have so far been found only in small numbers, it is probable that they will be more numerous when engagements are fought on terrain that favors the employment of tanks. Much of the fighting thus far has been in jungle country, and the Japanese weapons have been well suited to the tactical requirements of such terrain. In this connection, the efficiency of the Model 89 (1929) 50-mm grenade discharger should be especially noted. In many respects it is a unique weapon and provides the Japanese with something between the hand grenade and the standard type of mortar; for jungle fighting, it has proved to be a most effective weapon.

In only one respect does Japanese equipment appear not to have been entirely suited to the situation. At the beginning of the war, the Japanese Army was equipped generally with the Model 38 (1905) 6.5-mm rifle and the Models 11 (1922) and 96 (1936) 6.5-mm light machine guns. While the advantages of light weight and mobility were considerable, and while the calibers of these weapons have been particularly useful in the jungle, nevertheless the size and weight of the bullets proved to be not so effective as was required. Consequently the Japanese Army has been replacing its 6.5-mm infantry weapons with 7.7-mm weapons capable of delivering a fire comparable with that of calibers .30 and .303 weapons used by the United Nations. The Model 99 (1939) 7.7-mm rifle was first captured on Guadal-

canal, where it was apparently present in small numbers, but on Attu whole units were armed exclusively with the new rifle and with its companion piece, the Model 99 (1939) 7.7-mm light machine gun. Both of these weapons are thoroughly dependable, modern pieces.

In addition to the weapons mentioned above, there are known to exist several modifications of Japanese standard small arms which have not yet been encountered in combat areas. Details concerning some of these will be found in the appendix, page 239.¹

For the organization and armament of a Japanese infantry regiment, the principal unit which employs the weapons described herein, see figure 1, page xiv.

¹Also, as a result of early Japanese successes in the present war, various U. S., Dutch, and British weapons are in use among Japanese units. From time to time, a few German weapons likewise will be encountered. Descriptions of these weapons, however, are not included in this study.

Section II. NOMENCLATURE

1. GENERAL

The weapons described in this volume have been named in accordance with a standardized system. This system of nomenclature is based on (a) the Japanese model number, (b) the caliber, and (c) the common ordnance name of the weapon. The model number is written first, followed by the year of the Christian Era in parentheses, the bore of the piece in millimeters, and the common ordnance name: for example, Model 38 (1905) 6.5-mm rifle.

2. MODEL NUMBERS

The Japanese model number may often be found among the markings inscribed on the weapons.

Before the death of Emperor Meiji in 1912, Japanese ordnance was marked in accordance with the year of his reign: for example, Model 44 (1911) 6.5-mm carbine, which was adopted in the 44th year of the Meiji Era. (The Japanese characters for *Meiji* are 明治.)

Similarly, during the reign of Emperor Taisho (1912-25), Japanese weapons were marked with the year of their adoption, the Japanese calendar year then being the year of the Taisho Era: for example, model

11 (1922) 6.5-mm light machine gun, which was adopted during the 11th year of the Taisho Era. (The Japanese characters for *Taisho* are 天正.)

Subsequent to the death of Emperor Taisho, most Japanese ordnance has been marked with the last two digits of the year since the foundation of the Japanese Empire; for example, Model 89 (1929) 50-mm grenade discharger, the Japanese year referred to in this instance being 2589. Beginning with the Japanese year 2601 (1941), only the last digit has been used: for example, Model 1 (1941) 47-mm antitank gun, which was adopted during the Japanese year 2601. The Japanese year 2600 (1940) is usually represented by the last digit, 0, as in the Type (or Model) Zero airplane, but in at least some instances, in connection with ammunition, 100 is used (see fig. 96, p. 158, and fig. 117, p. 186). Presumably the system of referring to the Japanese year by the last digit will be used through the year 2609 (1949).

However, while most of the recent Japanese weapons are marked in accordance with the year of the Empire, ordnance may occasionally be marked with the year of the present Emperor, Hirohito, who began to rule on 26 December 1925. The era of his reign has been given the name *Showa*, the Japanese characters for which are 昭和. Thus *Showa 17* is 1942, *Showa 18* is 1943, and so on.

In addition to the model number, there also appears on each Japanese piece or munition its date of manufacture. In the case of an assembled weapon, each part may bear its respective date of manufacture. The manufacturer's serial number is also commonly found.

3. CALIBERS

Like the Germans, the Japanese use the metric system for designating the calibers of weapons. Artillery calibers are often only approximate: for example, the Model 88 (1928) 7-cm high-angle gun is really a 75-mm antiaircraft gun. Weapons up to 70-mm are usually referred to in millimeters, and higher calibers either in millimeters or in centimeters. Small arms (up to 20-mm) present no difficulties except for the Model 93 (1933) 13-mm heavy machine gun, which actually has a caliber of 13.2 mm (par. 25, p. 127).

4. COMMON NAMES

With the exception of the grenade dischargers, no novel Japanese weapons have appeared which cannot be given one of the common ordnance terms. Some difficulty arises, however, when the Japanese themselves do not use a common ordnance name. For example, they refer to one of their weapons, the Model 11 (1922) 70-mm mortar (par. 27, p. 142), as a high-angle infantry gun despite the fact that the common ordnance name would be "mortar." In such cases the common name is used.

Section III. PISTOLS AND RIFLES

5. NAMBU 8-MM PISTOL¹

a. General

The *Nambu* 8-mm pistol (fig. 2), which is popularly called the *Nambu* pistol from the name of its designer,

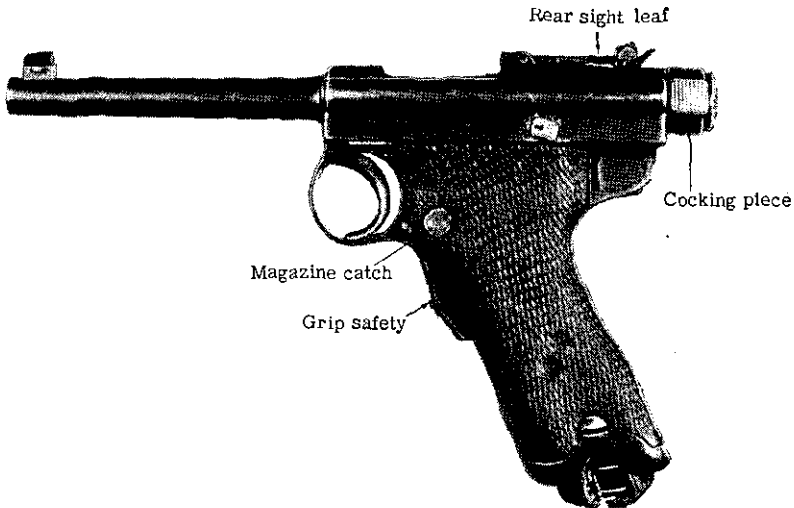

Figure 2.—*Nambu* 8-mm pistol (left side).

¹This weapon is listed by the Japanese as 南部拳銃, which is read (from left to right) *Nambu Kenju*, meaning "Nambu pistol." The Japanese often use the word *pistol* in place of *Kenju*. Note that the order of characters prevailing in Japanese printed matter is from top to bottom in columns from the right of the page to the left. When characters are written horizontally, as on weapons, the order is often from right to left. However, the newer practice, now in common use, follows the English order from left to right.

Colonel Kijiro Nambu, somewhat resembles the German Luger pistol² in outward appearance, but the Luger and the *Nambu* have entirely different mechanisms. In fact, the *Nambu* is one of the weapons created and developed by the Japanese themselves.

Although the *Nambu* pistol is no longer manufactured and is being replaced by the Model 14 (1925) 8-mm pistol (par. 6, p. 14), many are still in service.

b. How to Identify

The *Nambu* 8-mm pistol may be identified by—

- (1) The rear sight leaf.
- (2) The horizontal bulge (recoil-spring housing) on the left side of the receiver (see figs. 2 and 4).
- (3) The slot cut for the wooden combination shoulder-stock-holster at the heel of the butt.
- (4) The grip safety just below the trigger guard on the butt.
- (5) The marking 式部南 which is on the right side of the receiver at the rear (fig. 3). (This marking, which is read *Nambu Shiki* from right to left,³ means "Nambu model.")

c. Characteristics

(1) *General*.—The *Nambu* 8-mm pistol is a semiautomatic, recoil-operated, magazine-fed hand weapon. Its 8-round magazine fits into the butt and is held secure by a magazine catch similar to that on the U. S. service automatic pistol (M1911 or M1911A1 Colt .45).

² For a description of the German Luger pistol, see "German Infantry Weapons," *Special Series*, No. 14 (25 May 1943), par. 1, pp. 3-10.

³ See p. 7, note 1.



Figure 3.—Nambu 8-mm pistol (three-quarter view), showing marking on right side.

(2) *Table of characteristics.*—

Caliber.....	8 mm (.315 inch).
Principle of operation.....	Recoil-operated, semiautomatic.
Ammunition.....	Semirimmed, bottle-necked case, roundnosed bullet.
Capacity of magazine.....	8 rounds.

Sights:

Front-----	Inverted V blade on T base.
Rear-----	Leaf with open V notch sliding on ramp, graduated from 100 to 500 meters (109.4 to 546.8 yards) (fig. 4); no windage adjustment.
Length of barrel-----	4½ inches.
Weight (empty)-----	31 ounces.
Range:	
Effective-----	50 feet.
Maximum-----	547 yards.
Muzzle velocity-----	950 feet per second.

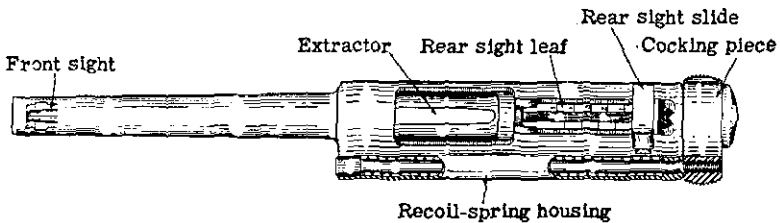

Figure 4.—Nambu 8-mm pistol (top view).

d. How to Operate

(1) *Safety*.—A grip safety is provided just below the trigger guard. This is a simple mechanism that catches the trigger in its forward position and prevents any rearward movement unless the grip safety is depressed.

Unlike the U. S. service automatic pistol, the *Nambu* has no disconnecter.⁴ The firing pin, being of the

⁴In the U. S. service automatic pistol the disconnecter prevents the release of the hammer unless the slide and barrel are in the forward position safely interlocked. It also prevents more than one shot following each squeeze of the trigger. See FM 23-35, "Automatic Pistol Caliber .45 M1911 and M1911 A1" (30 Apr 1940), par. 26, p. 26.

plunger type, does not have sufficient momentum to fire a second round.

(2) *To load and fire.*—Insert a loaded magazine into the butt and shove it home until the magazine catch locks. This is similar to the operation used in loading the U. S. service automatic pistol.

To move one of the cartridges forward into the chamber for firing, pull the cocking piece to the rear and then let it snap forward. This operation will carry forward a cartridge from the lips of the magazine into the chamber. The pistol is then ready to be fired (fig. 5). The pistol is fired by squeezing the grip safety and trigger at the same time.

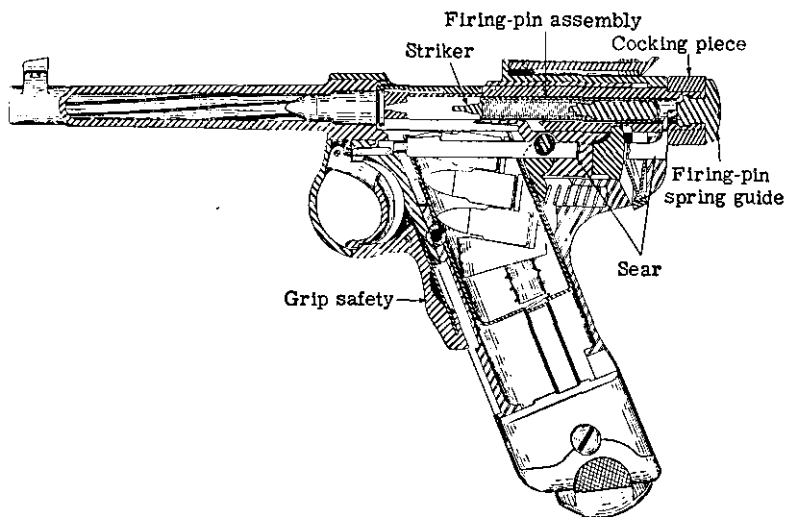

Figure 5.—Cross section of Nambu 8-mm pistol in firing position.

(3) *To unload.*—First, press the magazine catch, allowing the magazine to drop out of the butt. Then, to extract any cartridge that may be in the chamber, grasp the cocking piece and pull it to the rear as far

as it will go (fig. 6). This operation will usually extract and eject any cartridge in the chamber. Repeat this operation several times as a safety precaution.

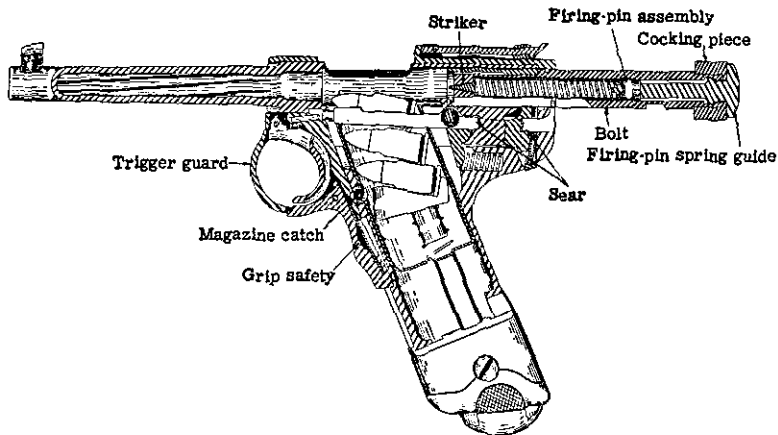

Figure 6.—Cross section of Nambu 8-mm pistol, showing recoil.

e. Ammunition

The 8-mm cartridge used in this pistol is bottlenecked and semirimmed, and at first glance resembles the caliber .30 Luger ammunition. At the present time no definite information is available as to the name and packing of the cartridge. The same type of cartridge is also used in the Model 14 (1925) pistol (par. 6, p. 14) and the Model 94 (1934) pistol (par. 7, p. 21). (See also par. 44, p. 238.)

f. Maintenance

(1) *Oiling and cleaning.*—This pistol requires the same type of care as the U. S. service automatic pistol. It should be cleaned and oiled frequently. However, in sandy or dusty regions, oil should be used sparingly or not at all.

(2) *Stripping*.—No particular tools are required to strip this pistol. Press in on the magazine catch and remove the magazine. With the thumb pressing in on the firing-pin spring guide,⁵ turn it counterclockwise a quarter turn and remove it. Pull the cocking piece to the rear until it clears the rear end of the bolt and unscrew it from the recoil-spring guide. Remove the recoil spring and the recoil-spring guide to the front; this can be done easily, as the recoil spring will not be under compression. Squeeze simultaneously both the trigger and the grip safety, and allow the firing-pin assembly and its spring to drop out to the rear. Turn the magazine-catch lock a quarter turn counterclockwise and remove it and the magazine-catch spring. Remove the magazine catch itself by turning it clockwise.

Remove the left grip after removing the grip screw. Push the barrel to the rear approximately one-eighth of an inch and allow the trigger and grip-safety group to drop to the bottom of the slot milled in the lower front portion of the receiver. Remove to the front the barrel, the bolt, and the bolt lock. Then remove the bolt-lock spring. Pull the grip safety outward and slide the trigger downward until it is free of the grooves. Turn the bolt stop until the arrow points down, and then pull the bolt stop out. Taking care that the sear spring, located at the forward end of the sear, is not lost, remove the sear.

(3) *Assembly*.—To assemble the weapon, proceed in the reverse order to that followed in stripping. Be-

⁵The firing-pin spring guide is located on the center of the rear face of the cocking piece (see figs. 5 and 6).

fore attempting to insert the barrel, the bolt, and the bolt-lock assemblies, care must be taken that the arrow on the bolt stop is pointed forward.

g. Accessories

A wooden holster, which has a telescopic section, is used both as a holster and as a stock to attach to the butt of the pistol to form a carbine (fig. 7). However, a leather holster is used more extensively than the wooden combination shoulder-stock-holster, which is obsolete.

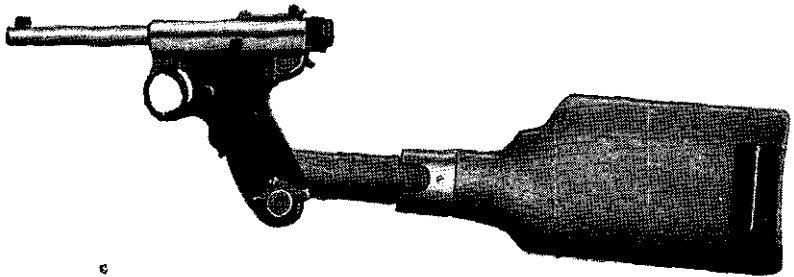

Figure 7.—Nambu 8-mm pistol with wooden combination shoulder-stock-holster attached.

6. MODEL 14 (1925) 8-MM PISTOL ⁶

a. General

The Model 14 (1925) 8-mm pistol (fig. 8) is a development of the *Nambu* (par. 5, p. 7). Both pistols use the same ammunition. The design, like that of the *Nambu*, is original, but the workmanship is usually poor. Un-

⁶This weapon is listed by the Japanese as十四年式拳銃, which is read (from left to right) *Juyonen Shiki Kenju*, meaning "14th year model pistol." (See p. 7, note 1.) The Japanese often use the word *pistol* in place of *Kenju*.

like the *Nambu*, this pistol is not fitted for a shoulder stock.

b. How to Identify

The Model 14 (1925) 8-mm pistol, which resembles the *Nambu* pistol but does not have the leaf sight which

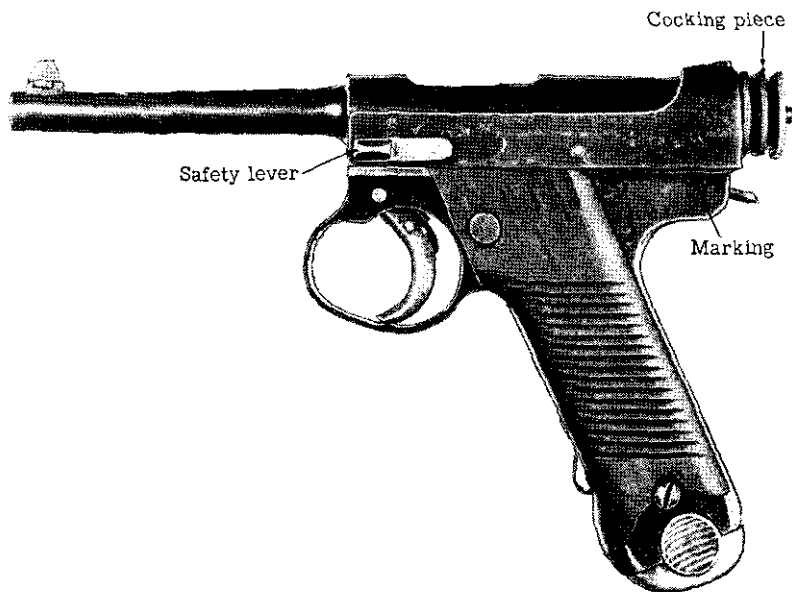

Figure 8.—Model 14 (1925) 8-mm pistol (left side).

distinguishes the latter (see fig. 9), may also be identified by—

- (1) The horizontally grooved wooden grips.
- (2) The distinctive shape of the cocking piece at the rear end of the bolt.
- (3) The absence of the recoil-spring housing on the left side of the receiver, noticeable on the *Nambu*.
- (4) The marking 十四年式 which is on the left side of the receiver at the rear (fig. 8). (This marking,

which is read *Juyonen Shiki* from left to right,⁷ means "14th year model.")

c. Characteristics

(1) *General*.—The Model 14 (1925) 8-mm pistol is a semiautomatic, recoil-operated, magazine-fed hand weapon (fig. 10). There is no slide. The barrel is

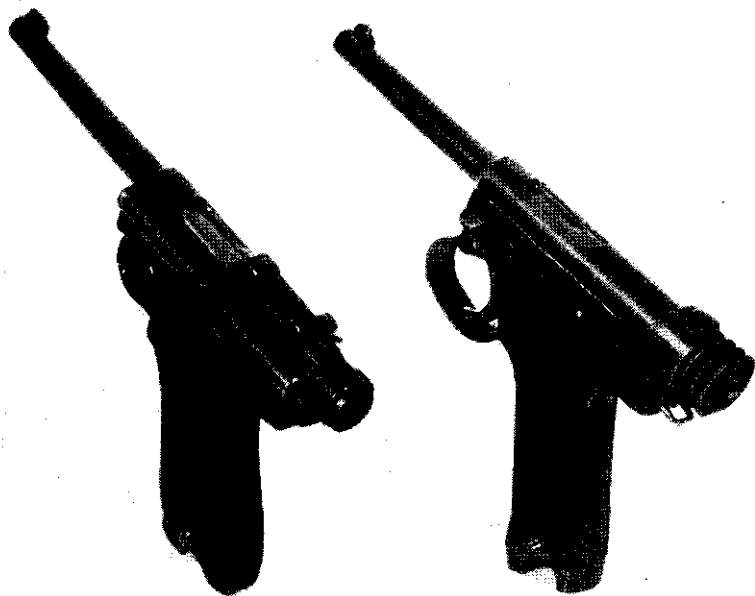

Figure 9.—Nambu 8-mm pistol (left) and Model 14 (1925) 8-mm pistol (right).

extended to the rear and carries the ejection opening and seat for the bolt lock. The bolt moves inside the barrel extension, and energy for the forward movement is supplied by two coil springs situated one on either side of the bolt, inside the barrel extension.

⁷ See p. 7, note 1.

(2) *Table of characteristics.*—

Caliber.....	8 mm (.315 inch).
Principle of operation.....	Recoil-operated, semiauto- matic.
Ammunition.....	Semirimmed, bottle-necked case, roundnosed bullet.
Capacity of magazine.....	8 rounds.
Sights:	
Front.....	Inverted V blade on T base.
Rear.....	Open V notch, nonadjust- able.
Length of barrel.....	4½ inches.
Weight:	
With loaded magazine.....	2.2 pounds.
With empty magazine.....	2 pounds.
Range:	
Effective.....	50 feet.
Maximum.....	547 yards.
Muzzle velocity.....	950 feet per second.

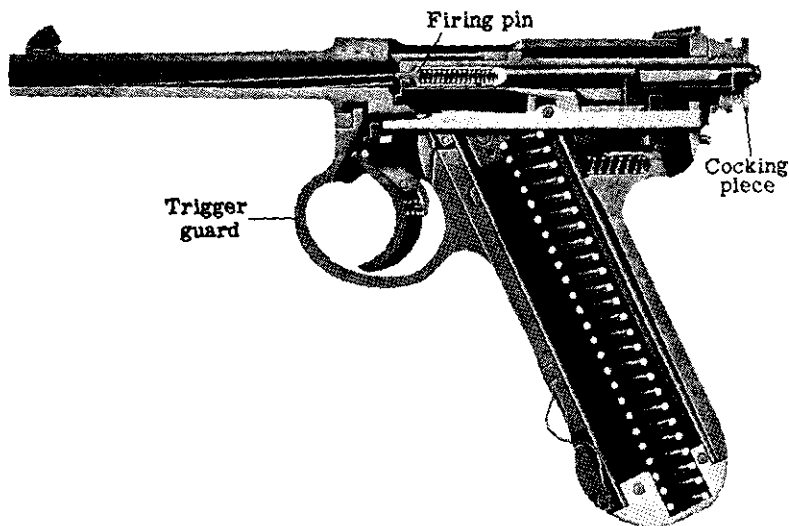

Figure 10.—Cross section of Model 14 (1925) 8-mm pistol.

d. How to Operate

(1) *Safety*.—A safety lever is located on the left side of the receiver directly above the trigger. When this lever is in the forward position (marked 火—*Ka*, “fire”), the action is free, and the pistol can be fired. When the lever is in the rear position (marked 安—*An*, “safe”), the action is locked. Even if there is a round in the chamber, the pistol will not fire unless a magazine is inserted.

(2) *To load and fire*.—Make sure that the safety lever is in the forward position. Insert a loaded magazine into the magazine well, which is situated in the butt, and push it in until it clicks. Pull the cocking piece rearward as far as it will go, and then let it snap forward. The pistol is now loaded and ready to be fired.

(3) *To unload*.—Make sure that the safety lever is in the forward position. Press downward on the magazine, release the button on the right side of the stock, and pull out the magazine. Pull the cocking piece all the way back to eject any cartridge in the chamber. Repeat this operation several times as a safety precaution.

e. Ammunition

The 8-mm cartridge used in this pistol is bottlenecked and semirimmed. The same type of cartridge is also used in the *Nambu pistol* (par. 5e, p. 12) and the Model 94 (1934) pistol (par. 7, p. 21). See also par. 44, p. 238.)

f. Maintenance

(1) *Oiling and cleaning.*—The type of care given the U. S. service automatic pistol will keep this pistol in good working order. It should be cleaned and oiled frequently. However, in sandy or dusty regions, oil should be used sparingly or not at all.

(2) *Stripping.*—A drift and a hammer are necessary to strip this pistol. Insert an empty magazine. Pull back the bolt by drawing the cocking piece fully to the rear. Then remove the cocking piece by depressing the small plunger (firing-pin spring guide) in the center of the cocking piece and unscrewing it counter-clockwise. Remove the firing-pin spring guide, the firing-pin spring, and the firing pin.

Remove the magazine. Push the magazine catch to the right, and pull down on the trigger guard. The barrel, bolt, bolt lock, and two recoil springs may be removed to the front. Complete the removal of the trigger guard, remove the left grip, and remove the magazine catch to the left. Care should be taken that the magazine-catch spring does not fly out and become lost.

Move the safety lever to a downward position and pull it out. Drift out the trigger-release pin and remove the trigger release. Drift out the sear pin and remove the sear. Since the trigger-release spring and plunger and the sear spring are small and under considerable compression, care should be taken that these parts are not lost.

(3) *Assembly.*—To assemble the weapon, proceed in the reverse order to that followed in stripping. In re-

placing the safety, the front end of the sear should be depressed with the firing pin, and after the safety is in position, it should be moved to the "fire," or forward, position before replacing the barrel and bolt assemblies.



Figure 11.—Model 14 (1925) 8-mm pistol (right side), showing lanyard.

g. Accessories

A holster of heavy leather or rubberized canvas is provided, having a flap with a safety catch and containing a pocket for reserve ammunition. Provision is made for attaching a lanyard to the rear of the receiver (fig. 11).

7. MODEL 94 (1934) 8-MM PISTOL ⁸

a. General

The Model 94 (1934) 8-mm pistol (fig. 12) is the latest design of semiautomatic pistol found in use among the Japanese. It is believed to be inferior to the *Nambu*

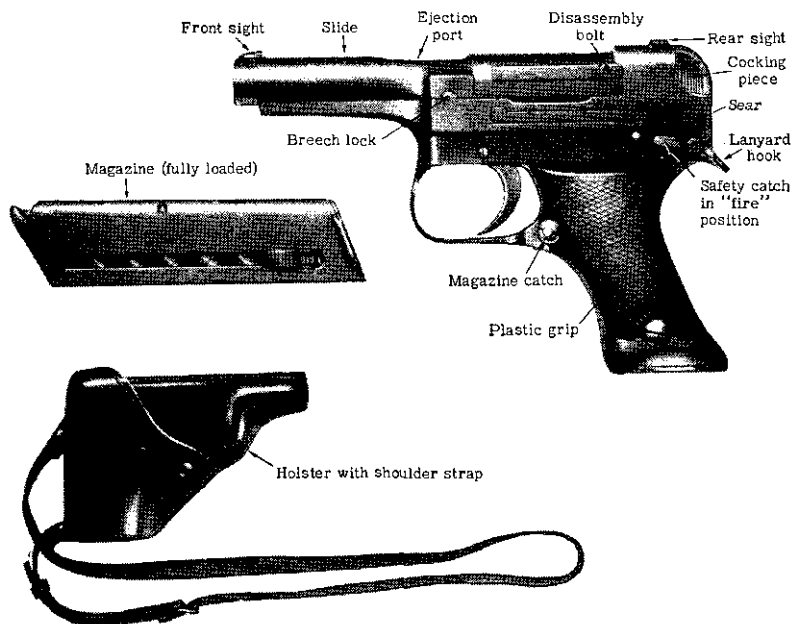

Figure 12.—Model 94 (1934) 8-mm pistol (left side), showing also holster and spare magazine.

and the Model 14 (1925) pistols because of poor manufacture and the design of the grip. Detailed information on the weapon is not yet available. While the

⁸ This weapon is listed by the Japanese as 九四式拳銃, which is read (from left to right) *Kyuyon Shiki Kenju*, meaning "94 model pistol." (See p. 7, note 1.) The Japanese often use the word *pistol* in place of *Kenju*.

action is designed to lock at the moment of firing, it is reported that one specimen fired with the action unlocked—an evidence of poor workmanship.

b. How to Identify

The Model 94 (1934) 8-mm pistol may be identified by—

(1) The unique appearance, sharply distinguishing it from other Japanese pistols.

(2) The slide covering the barrel. (No other Japanese service pistol has its barrel covered by a slide.)

(3) The odd-shaped butt and plastic grips.

(4) The marking 式四九 which is on the left side of the frame above the trigger. (This marking, which is read *Kyuyon Shiki* from right to left,⁹ means “94 model.”)

c. Characteristics

(1) *General.*—The Model 94 (1934) 8-mm pistol is a comparatively new weapon and to date has not often been reported, although it is apparently being manufactured in quantity. It is issued to aircraft crews as well as to ground forces. It is a semiautomatic, recoil-operated, magazine-fed hand weapon. Feed is by a box magazine fitting into the butt in the usual manner.

(2) *Table of characteristics.*—

Caliber-----	8 mm (.315 inch).
Principle of operation-----	Recoil-operated, semiautomatic.
Ammunition-----	Same 8-mm semirimmed, bottle-necked cartridge as used in the <i>Nambu</i> and the Model 14 pistols.
Capacity of magazine-----	6 rounds.

⁹ See p. 7, note 1.

Sights:

Front.....	Inverted V blade.
Rear.....	Open V notch, nonadjustable.
Length of barrel.....	3.8 inches.
Over-all length.....	7.5 inches.
Weight with empty magazine..	1 pound 11 ounces.
Effective range.....	50 feet.
Muzzle velocity.....	900 feet per second.

d. How to Operate

(1) *Safety*.—The safety is on the left side of the receiver, in approximately the same position as the safety on the U. S. service automatic pistol (M1911 of M1911A1 Colt .45). It is a lever, pivoted at the rear end. When the safety catch is pivoted forward so that it is in the horizontal position, it is in the “fire” position. When it is pivoted backward into the vertical position, it is in the “safe” position.

A mechanical safety mechanism is included in the trigger assembly, which contains a disconnecter to insure that the action is locked before the hammer is released and to prevent more than one shot from being fired for one squeeze of the trigger.

(2) *To load and fire*.—Insert a loaded magazine into the butt until the magazine catch clicks. Set the safety catch to the “fire” position and pull the cocking piece to the rear as far as it will go; then let it snap forward. This operation will chamber a round. The pistol is then ready to be fired. If immediate firing is not desired, the safety catch should be moved to the vertical, or “safe,” position.

(3) *To unload*.—Press in the magazine catch, which is located on the left side of the receiver, in the same

position as on the U. S. service automatic pistol (M1911 or M1911A1 Colt .45). The magazine can then be removed. By working the slide back and forth several times, check to be certain that the chamber is clear of the round.

e. Ammunition

The same ammunition used in the *Nambu* pistol (par. 5e, p. 12) and the Model 14 pistol (par. 7, p. 21) is used in this pistol. (See also par. 44, p. 238.)

f. Maintenance

(1) *Oiling and cleaning.*—This pistol requires the same type of care as the U. S. service automatic pistol. It should be cleaned and oiled frequently. However, in sandy or dusty regions, oil should be used sparingly or not at all.

(2) *Stripping.*—Check the pistol to be sure that the chamber is clear. Insert an empty magazine. Turn the safety catch to the “fire” position and pull the slide to the rear until it remains in the rear, or open, position. Turn the pistol over with the slide down, the butt end forward. With the left forefinger push the rear end of the firing pin as far forward as it will go. Push the disassembly lock out to the left, being careful not to allow the slide and bolt to spring apart. Pull the slide, the barrel, and the recoil spring forward off the receiver and remove the bolt from the rear end of the receiver.

(3) *Assembly.*—To assemble the weapon, proceed in the reverse order to that followed in stripping. When assembling the breech lock, the vertical face should be kept forward so that it fits into the recess

in the slide. The firing pin should be assembled with the cutaway section uppermost.

g. Accessories

A heavy leather holster, with a pocket for a spare magazine, is provided. Provision is made for attaching a lanyard to the rear of the receiver.



Figure 13.—Model 38 (1905) 6.5-mm rifle, showing bolt closed.

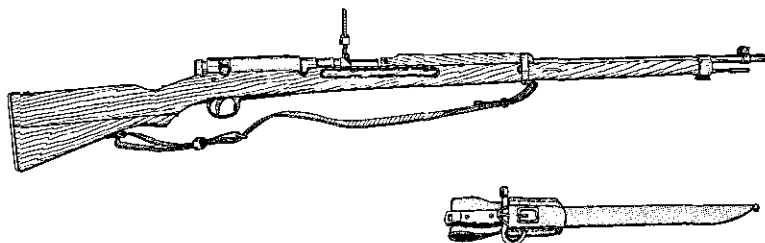

Figure 14.—Model 38 (1905) 6.5-mm rifle, showing also bayonet in scabbard.

8. MODEL 38 (1905) 6.5-MM RIFLE¹⁰

a. General

The Model 38 (1905) 6.5-mm rifle (figs. 13 and 14), a modified Mauser type, has an action somewhat similar to that of the U. S. caliber .30 M1903 (Springfield) rifle. It is a medium-velocity, small-bore weapon of rather clumsy design. The mechanism is sturdy and the

¹⁰This weapon is listed by the Japanese as 三八式歩兵銃, which is read (from left to right) *Sampachi Shiki Hoheiju*, meaning "38 model infantry rifle." (See p. 7, note 1.) It is commonly called the *Arisaka Sampachi*, from the name of its designer, Arisaka. Various Arisaka rifles have been developed over a long period of years.

piece is comparatively light for its length. Because of the light bullet and the small caliber, there is only a slight recoil. The long barrel, the small caliber, the light bullet, and the medium muzzle velocity practically eliminate muzzle flash. This characteristic, however, is evidently considered of little importance by the Japanese, since their latest rifle, the Model 99 (1939) 7.7-mm (par. 9, p. 39), has a shorter barrel (see fig. 27, p. 41), larger caliber, and heavier bullet, thereby increasing the recoil and the muzzle flash.

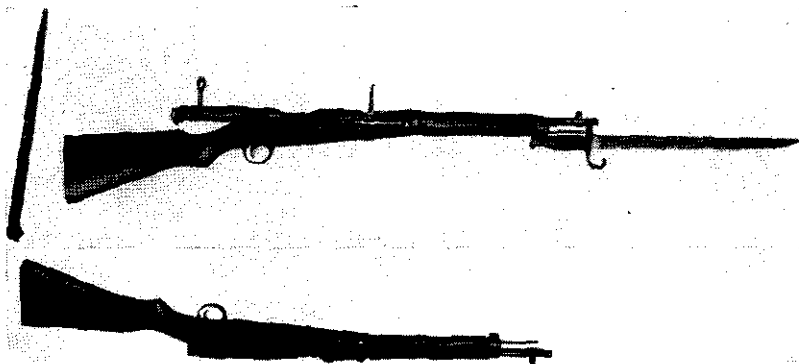

Figure 15.—Two views of Model 38 (1905) 6.5-mm carbine, showing also bayonet scabbard.

A carbine version of this rifle, the Model 38 (1905) 6.5-mm carbine¹¹ (fig. 15), is used by transport and engineer troops. The carbine may be distinguished from the rifle by the short barrel and the smaller rear sight leaf, as well as by the sling's being attached to the side of the carbine. Otherwise the carbine and long rifle are

¹¹ This weapon, commonly called *Sampachi Kiju*, is listed by the Japanese as 三八式騎銃, which is read (from left to right) *Sampachi Shiki Kiju*, meaning "38 model cavalry carbine." (See p. 7, note 1.)

similar (see fig. 27, p. 41). This carbine, like the rifle, is fitted to take the Model 30 (1897) bayonet (see **g** (1), below, and fig. 20, p. 33).

A later carbine, the Model 44 (1911) 6.5-mm cavalry carbine,¹² differs from the Model 38 carbine in having a permanently attached bayonet, which folds under the barrel when not in use (fig. 16). This carbine is used only by mounted troops.

(For a special sniper's 6.5-mm rifle, see par. **46**, p. 239.)

b. How to Identify

The Model 38 (1905) 6.5-mm rifle may be identified by—

- (1) Its unusual length (fig. 17).
- (2) The sling swivels underneath the barrel and stock as in the U. S. caliber .30 M1 (Garand) and M1903 (Springfield) rifles.
- (3) The marking 三八式 which is on top of the receiver immediately below the imperial seal. (This marking, which is read *Sampachi Shiki* from left to right,¹³ means "38 model.")

c. Characteristics

(1) *General.*—The Model 38 (1905) 6.5-mm rifle is a manually operated, bolt-action, air-cooled shoulder weapon. It is loaded by means of a clip containing five rounds of ammunition in a similar manner to the U. S. M1903 (Springfield) rifle. To keep dirt from fouling the mechanism, a detachable semicircular cover of sheet metal slides with the bolt in loading and extracting.

¹²This weapon, commonly called *Kiju*, is listed by the Japanese as 四四式騎銃, which is read (from left to right) *Yonyon Shiki Kiju*, meaning "44 model cavalry carbine." (See p. 7, note 1.)

¹³See p. 7, note 1.

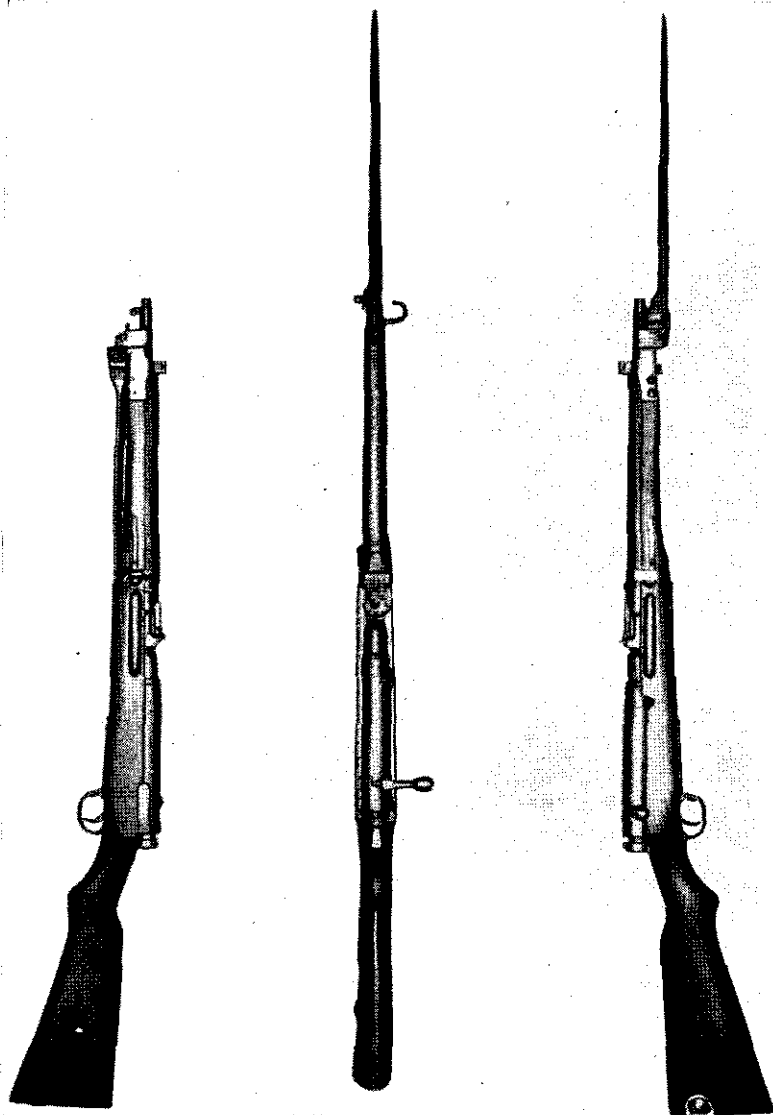

Figure 16.—Three views of Model 44 (1911) 6.5-mm cavalry carbine. (The photograph on the left shows the bayonet folded under the barrel.)



Figure 17.—Model 38 (1905) 6.5-mm rifle, showing its unusual length.

(2) *Table of characteristics.*—

Caliber.....	6.5 mm (.256 inch).
Principle of operation.....	Manually bolt-operated.
Ammunition	Model 38 (1905) ball and tracer; Model 38 (1905) reduced-charge ball.
Capacity of magazine.....	5 rounds.

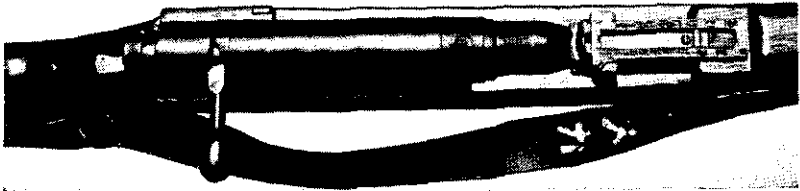

Figure 18.—Close-up of bolt and leaf sight of Model 38 (1905) 6.5-mm rifle.

Sights:

Front.....	Inverted V blade on T base.
Rear.....	Leaf and slide, graduated from 400 to 2,400 meters (437.4 to 2,625 yards) (fig. 18); no windage adjustment; peep battle sight set for 300 meters (328.1 yards) on rifles of late manufacture; open V sight on rifles of early manufacture.
Length of barrel.....	31.4 inches.
Over-all length.....	50.2 inches.
Weight without sling and bayonet.	9 pounds 4. ounces.
Range:	
Effective.....	400 yards.
Maximum.....	2,600 yards.
Muzzle velocity.....	2,400 feet per second.

d. How to Operate

(1) *Safety*.—The safety is in the form of a cylindrical cap on the rear end of the bolt. It can be placed in the safety position only when the action is cocked. To lock the action, push the safety forward with the palm of the hand and turn it clockwise as far as it will go.

(2) *To load and fire*.—The rifle is loaded in the same manner as the U. S. M1903 (Springfield) rifle. To load, pull the bolt fully to the rear, place one end of

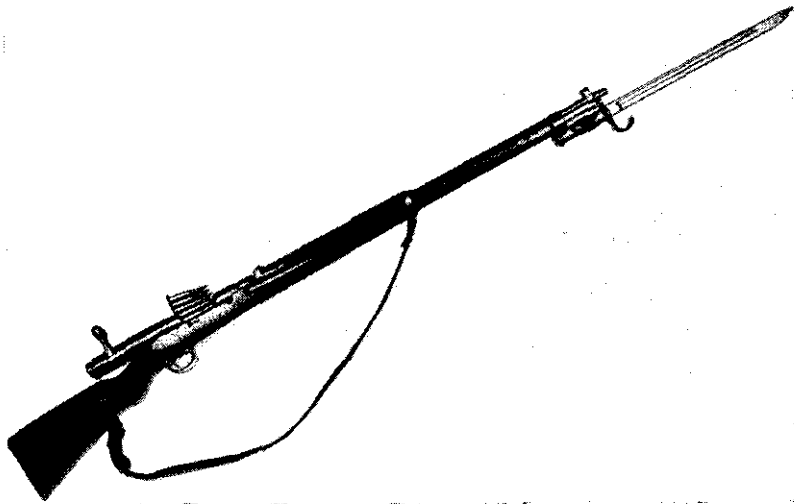

Figure 19.—Model 38 (1905) 6.5-mm rifle with bayonet attached, showing bolt open with cartridge clip about to be inserted.

the loaded clip into its guide seat in the receiver (fig. 19), and, with the fingers of the right hand against the floor plate and the thumb on the top cartridge in the clip, press downward until the top cartridge is caught by the lips of the magazine. The empty clip is forced

out when the bolt is closed. When the bolt is pushed forward, a cartridge is chambered, and the rifle is ready to be fired.

(3) *To unload*.—Open the bolt and work it back and forth until all the cartridges have been removed from the magazine and chamber.

e. Ammunition

The ammunition fired in the Model 38 (1905) 6.5-mm rifle is the standard 6.5-mm ammunition (see par. 41, p. 234). It is semirimmed and has a pointed nose. It is packed in a container containing 15 rounds to a box. This rifle also fires the reduced-charge ball ammunition made for the Models 11 (1922) and 96 (1936) 6.5-mm light machine guns (see par. 42, p. 235, and fig. 154, p. 236). Ball ammunition is distinguished by a pink band around the bullet where it meets the cartridge case, and also by a similarly colored circle on the upper left-hand corner of box labels. Tracer ammunition is similarly marked in green.

f. Maintenance

(1) *Oiling and cleaning*.—The care of this rifle is the same as that required for the U. S. M1903 (Springfield) rifle.

(2) *Stripping*.—(a) *To remove and disassemble bolt*.—Pull out on the bolt stop with one hand and at the same time pull the bolt out from the rear of the receiver with the other hand. Press the safety knob forward and turn it in a clockwise motion until the locking lug on the side of the safety-knob shaft frees itself from the firing pin. Remove the firing pin and main spring. Turn the extractor to the right, forcing

its tongue out of its groove in the front of the bolt, and force the extractor forward and off the bolt.

(b) *To remove and disassemble floor plate and follower.*—Depress the floor-plate catch inside the trigger guard. This releases the floor plate, which may then be removed together with the follower spring and follower. Raise the rear end of the follower spring high enough to clear the shoulder on the floor plate and draw it out of its mortise; in the same manner separate the follower spring from the follower.

(3) *Assembly.*—To assemble the weapon, proceed in the reverse order to that followed in stripping.

g. Accessories

(1) *General.*—A bolt cover is provided. However, most Japanese rifles are without bolt covers, probably because bolt covers retard speedy operation of the bolt and increase the amount of noise made when the bolt is operated. U. S. soldiers using this rifle will also do

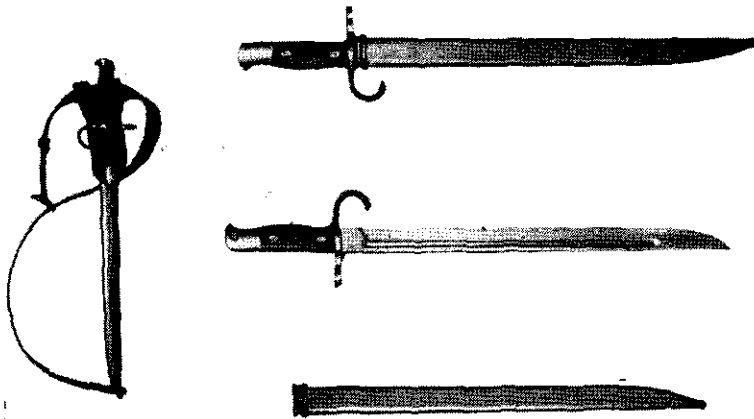

Figure 20.—Model 30 (1897) bayonet and accessories.

well to discard the bolt cover. A straight, one-edged bayonet, the Model 30 (1897) (fig. 20), is provided; it locks firmly to the muzzle and upper band in the same manner as the bayonet for the U. S. M1903 (Springfield) rifle. (See also figs. 14, 15, and 19, pp. 25, 26, and 31, respectively.)

The rifle is fitted with a cleaning rod which is carried in the stock below the barrel and released by pressing on a catch located below the upper band. This rod is only the main section. Brush, eye, and other accessories are carried in a squad kit. A carrying sling (leather, canvas, or rubberized canvas) is normally provided with the rifle. A muzzle cover for shedding rain and keeping out dirt is sometimes used. Older muzzle covers were made of brass; they are now made of plastic.

The standard belt and ammunition pouches (fig. 21), which may be leather or rubberized canvas, are used with this rifle.

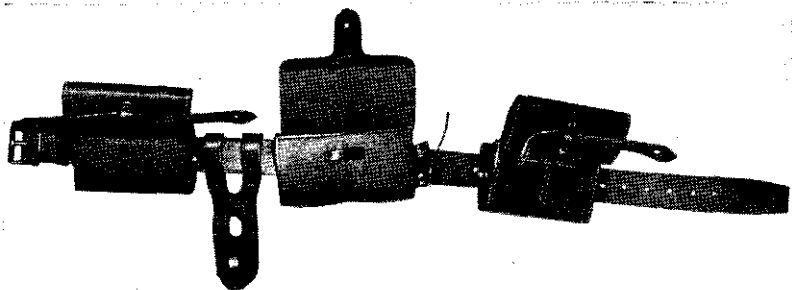

Figure 21.—Ammunition belt and pouches, and bayonet frog. (The two smaller pouches hold 30 rounds each. The larger pouch, containing 60 rounds, is worn at the rear, increasing the total for each man to 120 rounds.)

(2) *Grenade launchers*.—(a) *General*.—There are two types of rifle-grenade launchers—a cup type and a spigot type. The cup-type launcher (fig. 22) is fitted over the muzzle and locked over the front sight of the rifle. It has a short, rifled barrel, and is a faithful copy of the German cup-type launcher (*Schiessbecher*) used to fire the German rifle grenades *G.Pzgr.*¹⁴ and *gr.G.Pzgr.*¹⁵

(b) *Cup-type*.—The armor-piercing grenade (fig. 22) for this cup-type launcher works on the hollow-charge principle (fig. 23)¹⁶ and is a copy of the Ger-

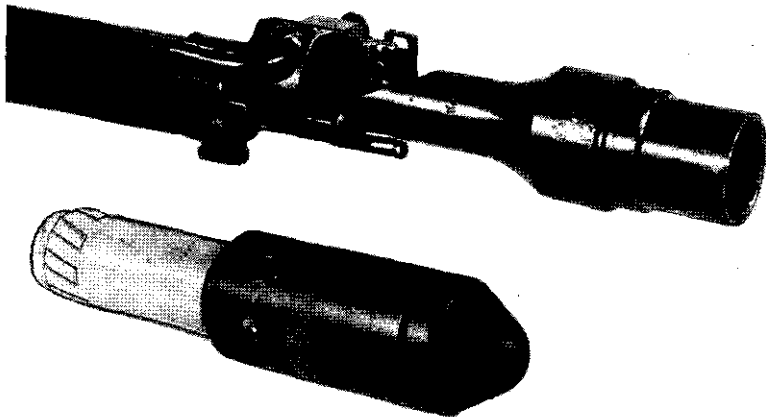

Figure 22.—Armor-piercing rifle grenade and cup-type grenade launcher. (The grenade in this illustration corresponds to the German *gr.G.Pzgr.* type.)

¹⁴ *Gewehr-Panzergranate*. See "German Infantry Weapons," *Special Series*, No. 14 (25 May 1943), par. 4g(3)(b), p. 29.

¹⁵ *Grosse Gewehr-Panzergranate* (see figs. 22 and 23).

¹⁶ A hollow charge concentrates explosive forces of a projectile in order to intensify greatly the penetrating effect against armorplate. The bursting

man rifle grenade *gr.G.Pzgr.* The grenade is 7.08 inches long and 1.58 inches at the greatest diameter, and contains a bursting charge of 3.81 ounces of TNT. It is safe to handle, since the fuze is not armed until after being fired from the rifle. However, the grenade should not be jolted. A special cartridge with a wooden projectile is used to propel the grenade.

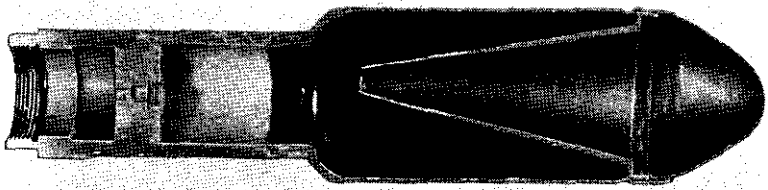

Figure 23.—Cross section of armor-piercing rifle grenade, showing hollow charge. (This grenade corresponds to the German *gr.G.Pzgr.* type.)

(c) *Spigot-type.*—The spigot-type launcher (fig. 24) also fits over the muzzle and is locked behind the front sight of the rifle. Two types of grenades used in the spigot-type launcher are the high-explosive grenade and the smoke grenade.

The high-explosive rifle grenade (figs. 24 and 25) resembles the Model 91 (1931) hand grenade (par. 10, p. 45) except that it has a fin assembly instead of the propelling charge. The exact manner of operating this rifle grenade is not known. It is thought that the rifle grenade is placed over the spigot, the safety pin pulled, and a special cartridge with a wooden projectile fired in the rifle. Setback probably causes the firing pin to

charge is formed to leave a cone-shaped hollow space in the nose end of the projectile.

strike the percussion cap, thereby starting the delay fuze, the duration of which is not known. The special cartridge with a wooden projectile comes packed inside the base of the rifle grenade.

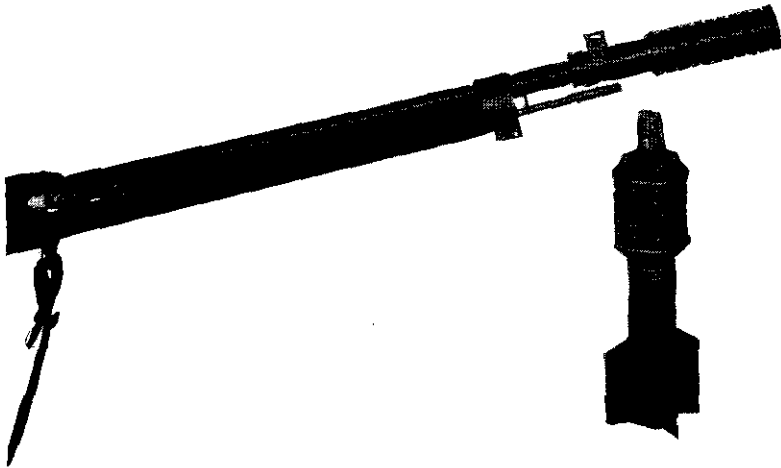

Figure 24.—High-explosive rifle grenade and spigot-type grenade launcher.

The smoke rifle grenade (fig. 25), consisting of a body unit and a tail unit, has the following specifications:

Total weight.....	1.29 pounds.
Length of body unit.....	4 inches.
Length of tail unit.....	2.37 inches.

The body unit has rounded ends, with four smoke ports, which are covered with metal disks at the bottom end. Heat causes the metal disks to drop off, allowing smoke to be emitted. The body contains 0.6 pound of a smoke mixture of the following composition:

	<i>Percent</i>
Hexachlorethane.....	27.6
Zinc, metallic.....	27.6
Zinc chloride.....	2.9
Zinc oxide.....	13.4

There is nothing unusual about this smoke mixture. The tail unit is provided with four vanes to assist in maintaining direction. A 6.5-mm cartridge, fitted with



Figure 25.—Rifle grenades and accessories. (From left to right are a launcher, a smoke grenade, and a high-explosive grenade. The carrying case is in the background.)

a wooden projectile, is the propellant. One such cartridge is packed inside the tube of the tail unit of each smoke rifle grenade. The range is estimated at 150 yards.

9. MODEL 99 (1939) 7.7-MM RIFLE ¹⁷

a. General

In some areas the Model 99 (1939) 7.7-mm rifle (fig. 26) is replacing the Model 38 (1905) 6.5-mm rifle (*Arisaka Sampachi*) (par. 8, p. 25) as the basic Japanese infantry weapon. It is 5 inches shorter and of larger caliber than the Model 38, but otherwise it is identical in construction (see fig. 27). Like the older model, it is fitted to take the Japanese service bayonet (fig. 20, p. 33). (For a long model 7.7-mm rifle, see par. 47, p. 240.)

b. How to Identify

The Japanese Model 99 (1939) 7.7-mm rifle may be identified by—

(1) A monopod which is attached to the lower band and can be rotated forward to catch on the stock when not in use.

(2) The sling, which is attached to swivels on the left side, instead of the bottom, of the rifle.

(3) The slide on the rear sight, which is equipped with two arms (right and left) that can be swung out $2\frac{3}{8}$ inches from the center of the rifle. (These arms are used when firing at aircraft.)

(4) The marking 式九九 which is on top of the receiver immediately below the imperial seal. (This marking, which is read *Kyukyu Shiki* from right to left,¹⁸ means "99 model.")

¹⁷ This weapon, commonly called *Kyukyu Tanshoju*, is listed by the Japanese as 九九式短小銃, which is read (from left to right) *Kyukyu Shiki Tanshoju*, meaning "99 model short rifle." (See p. 7, note 1.)

¹⁸ See p. 7, note 1.

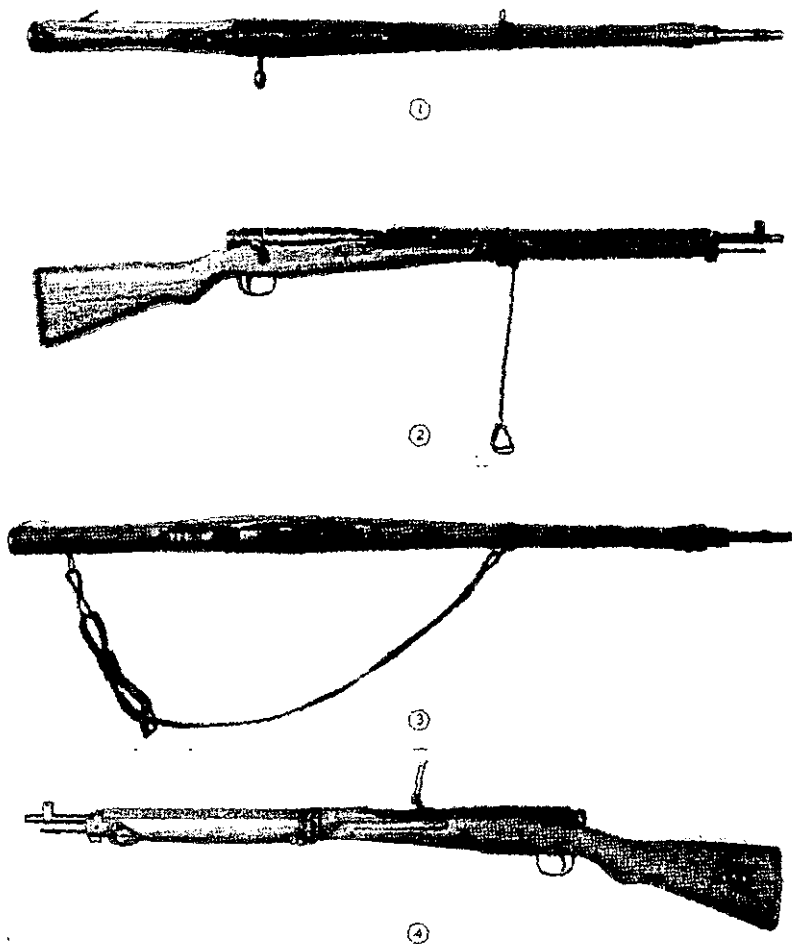

Figure 26.—Model 99 (1939) 7.7-mm rifle: ① top view; ② right side, with monopod down; ③ bottom view, showing hinged floor plate open, and sling; ④ left side, showing sight raised.

c. Characteristics

(1) *General.*—The Model 99 (1939) 7.7-mm rifle is a manually operated, bolt-action, air-cooled shoulder weapon. The rifle is equipped with a full length cleaning rod that fits in the stock and is held in place by a catch. A sling, which is made of rubberized canvas, is attached to swivels on the lower band and stock on the left side of the rifle. A monopod is also attached to the lower band and can be folded forward to catch on the stock when not being used. This monopod is about 12 inches long from the center line of the bore and appears to be too long for use in a prone position. The operating mechanism is protected by a detachable semicircular cover of sheet metal that

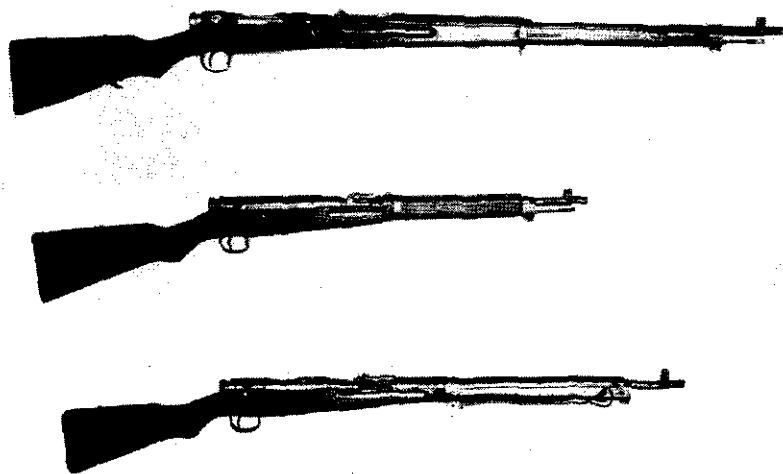

Figure 27.—Model 38 (1905) 6.5-mm rifle (top), Model 38 (1905) 6.5-mm carbine (center), and Model 99 (1939) 7.7-mm rifle (bottom),

slides with the bolt in loading and extracting. The action is exactly the same as that in the Model 38 (1905) 6.5-mm rifle and carbine.

(2) *Table of characteristics.*—

Caliber	-----	7.7 mm (.303 inch).
Principle of operation	-----	Manually bolt-operated.
Ammunition	-----	Model 99 (1939) rimless ball.
Capacity of magazine	-----	5 rounds.
Sights:		
Front	-----	Inverted V blade on T base.
Rear	-----	Leaf and slide, graduated from 300 to 1,500 meters (328.1 to 1,640 yards); no windage adjustment; folding arms for taking leads in antiaircraft fire; peep battle sight set for 300 meters (328.1 yards).
Length of barrel	-----	25¾ inches.
Over-all length	-----	45 inches.
Weight (unloaded with sling)	-----	8.8 pounds.
Range:		
Effective	-----	600 yards.
Maximum	-----	3,000 yards.
Muzzle velocity	-----	2,300 feet per second.

d. How to Operate

(1) *Safety.*—The safety is in the form of a cylindrical cap on the rear end of the bolt. It can be placed in the safety position only when the action is cocked. To lock the action, push the safety forward with the



Figure 28.—Model 99 (1939) 7.7-mm rifles being cleaned.

palm of the hand and turn it clockwise as far as it will go.

(2) *To load and fire.*—The rifle is loaded in the same manner as the U. S. M1903 (Springfield) rifle.

To load, pull the bolt fully to the rear, place one end of the loaded clip into its guide seat in the receiver, and, with the fingers of the right hand against the floor plate and the thumb on the top cartridge in the clip, press downward until the top cartridge is caught by the lips of the magazine. The empty clip is forced out when the bolt is closed. When the bolt is pushed forward, a cartridge is chambered, and the rifle is ready to be fired.

(3) *To unload*.—Open the bolt and work it back and forth until all the cartridges have been removed from the magazine and chamber.

e. Ammunition

The ammunition fired in the Model 99 (1939) 7.7-mm rifle is true rimless and has a pointed nose. It is also used in the Model 99 (1939) 7.7-mm light machine gun (par. **23e**, p. 112), and will function in the Model 92 (1932) 7.7-mm heavy machine gun (par. **24e**, p. 121). The color of the band painted around the circumference of the bullet where the bullet joins the cartridge case is pink, indicating ball ammunition. Tracer ammunition is marked by a green band, and armor-piercing by a black band. (See par. **43b**, p. 237.)

f. Maintenance

The description of the maintenance of the Model 38 (1905) 6.5-mm rifle (par. **8f**, p. 32) applies also to this model (see fig. 28).

Section IV. GRENADES AND LAND MINES

10. MODEL 91 (1931) HAND GRENADE ¹

a. General

The Model 91 (1931) hand grenade (figs. 29 and 30) can be either fired from the Models 10 (1921) (par. 19, p. 68) and 89 (1929) (par. 20e (2), p. 81) 50-mm grenade dischargers or thrown by hand. It can also be modified for use as a rifle grenade by substituting a tubular tail fin assembly for the propellant container (see par. 8g (2) (c), p. 36, and fig. 24, p. 37).

b. How to Identify

The Model 91 (1931) hand grenade may be recognized by the serrated black body, the brass safety cover, and the perforated propellant container screwed into the base.

c. Characteristics

(1) *General*.—The body of the Model 91 (1931) hand grenade is of cast iron, painted black, with a serrated surface.

The firing pin is screwed into the firing-pin holder. In shipment the firing-pin head is flush with the top of

¹ This weapon is listed by the Japanese as 九一式手榴弾, which is read (from left to right) *Kyuichi Shiki Shuryudan*, meaning "91 model hand grenade." (See p. 7, note 1.)

the holder so that the point of the firing pin does not protrude below the holder. Before the grenade can be used, the firing pin must be screwed with a screw driver, or a knife blade, into the firing-pin holder as far as it will go.

The explosive train is initiated by setback action. The fuze has a burning time of approximately 8 to 9 seconds.

(2) *Table of characteristics.*—

Over-all length.....	4.95 inches.
Length without the propellant container.....	3.75 inches.
Diameter.....	1.97 inches.
Weight.....	18.8 ounces.

d. How to Operate

(1) *Safety.*—The safety pin passes through the wall of the protective cover of the fuze and the firing-pin holder and thereby prevents the firing pin from coming into contact with the percussion cap.

(2) *To arm.*—Make sure that the safety pin is in position and that the firing pin is screwed down into the firing-pin holder as far as it will go.

(3) *To use as mortar grenade.*—Remove the safety pin and drop the grenade base-downward into the Model 10 (1921) (par. 19, p. 68) or the Model 89 (1929) (par. 20, p. 73) 50-mm grenade discharger as far as it will go. A firing pin hits the percussion cap in the base of the grenade when the trigger mechanism of the grenade discharger is operated. During the acceleration of the grenade in the barrel of the discharger, the firing pin sets back, overcoming the resistance of the creep spring, and fires the percussion cap.

(4) *To use as hand grenade.*—Grasp the grenade so that the fuze points downward, and withdraw the safety pin. Making sure that the safety cover does not fall off, strike the head of the fuze against some hard object, such as the heel of your shoe or the

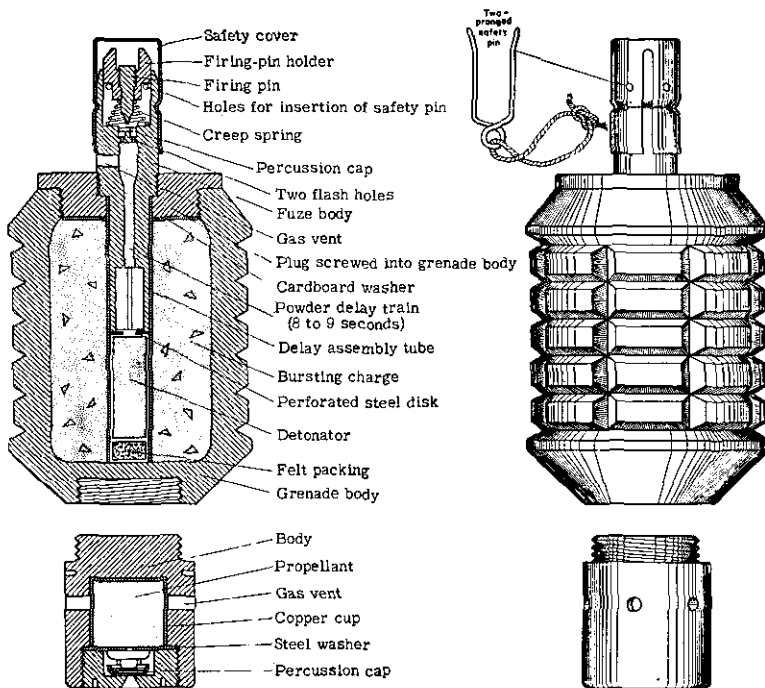

Figure 29.—Model 91 (1931) hand grenade.

top of your helmet. Throw the grenade immediately, as the fuzes are sometimes erratic. A propelling charge is not required when this grenade is used as a hand grenade, and can be removed by unscrewing the propellant container from the grenade body.

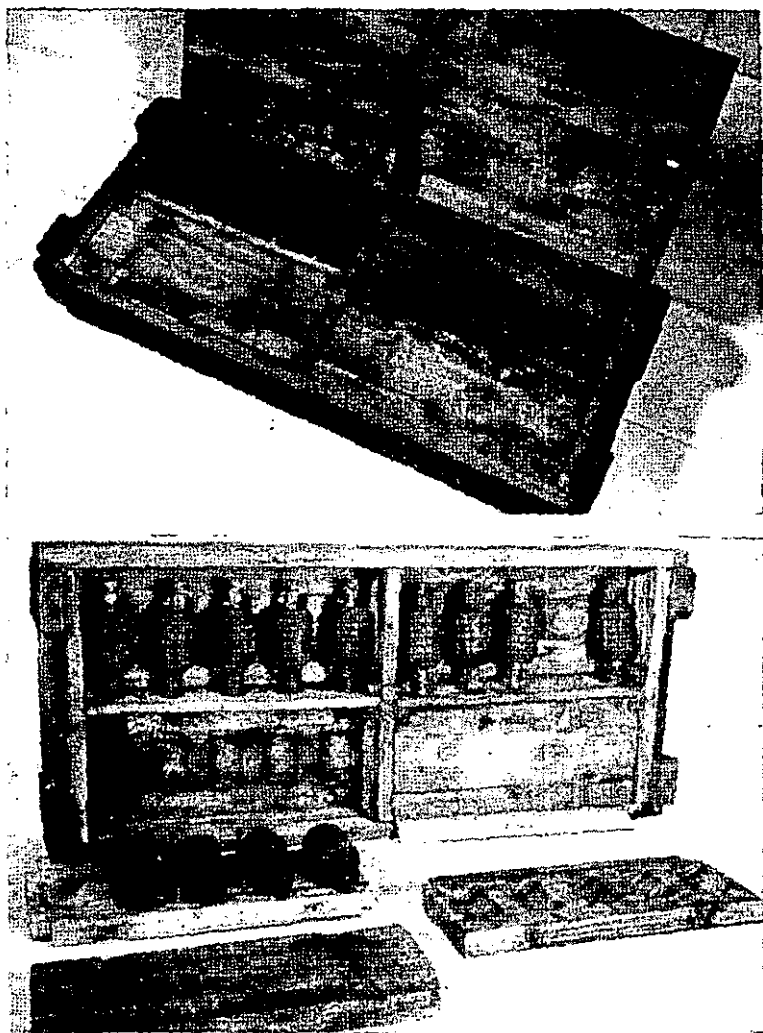

Figure 30.—Two views of packing box for Model 91 [1931] hand grenades (20 grenades).

(5) *To disarm.*—Replace the safety pin. If none is available, use a piece of heavy wire. Unscrew the firing pin until its head is flush with the top of the firing-pin holder.

11. MODEL 97 (1937) HAND GRENADE

a. General

The Model 97 (1937) hand grenade (fig. 31) is believed to be carried by all Japanese front-line troops. It cannot be fired from a grenade discharger.

b. How to Identify

The Model 97 (1937) hand grenade is similar to the Model 91 (1931) hand grenade (par. 10, p. 45) except that it has no provision for a propelling charge. It may be recognized as well by the serrated body and the brass fuze, which is identical with the fuze on the Model 91.

c. Characteristics

(1) *General.*—The body of the Model 97 (1937) hand grenade is of cast iron, painted black, and is serrated to insure maximum fragmentation. It is loaded with TNT. The time delay is 4 or 5 seconds. This is accomplished by a delay train of black powder which is ignited by the flash from the percussion cap set off by the firing pin.

The Model 97 hand grenade can be used as a booby trap by pulling out the safety pin and placing the

grenade under planks, chair seats, or the like. The weight of a man on the fuze is sufficient to set it off.

(2) *Table of characteristics.*—

Over-all length.....	3.75 inches.
Diameter.....	1.97 inches.
Weight.....	1 pound (approximately).

d. How to Operate

(1) *Safety.*—The safety pin passes through the wall of the safety cover of the fuze and the firing-

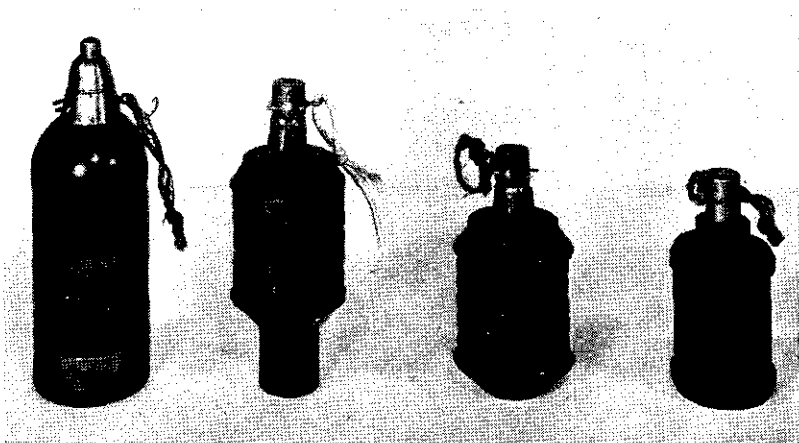

Figure 31.—Model 89 (1929) shell (left), Model 91 (1931) hand grenade (left center), Model 97 (1937) hand grenade (right center), and model "Kiska" hand grenade (right).

pin holder and thereby prevents the firing pin from coming into contact with the percussion cap. Upon withdrawal of the safety pin, there is a further slight safety feature in that a creep spring holds the firing pin away until the head of the cover is struck.

(2) *To arm.*—Make sure that the safety pin is in position and that the firing pin is screwed down into the firing-pin holder as far as it will go.

(3) *To throw.*—Grasp the grenade so that the fuze points downward, and withdraw the safety pin. Making sure that the safety cover does not fall off, strike the head of the fuze cover against some hard object, such as the heel of your shoe or the top of your helmet. There should be no delay in throwing the grenade, for the fuzes are sometimes erratic in behavior.

(4) *To disarm.*—Replace the safety pin. If none is available, use a piece of heavy wire. Unscrew the firing pin until its head is flush with the top of the firing-pin holder.

12. MODEL "KISKA" HAND GRENADE

a. General

The Model "Kiska" offensive hand grenade (fig. 32), hitherto unidentified, was discovered on Kiska. The model number has not been ascertained, but the majority of the captured grenades were manufactured in August 1942.

b. How to Identify

The Model "Kiska" hand grenade is smaller than the Model 97 (1937) hand grenade (par. 11, p. 49), and, unlike both the Model 91 (1931) (par. 10, p. 45) and the Model 97, it is not serrated (see fig. 31).

c. Characteristics

(1) *General.*—The body of the Model "Kiska" hand grenade is smooth and cylindrical both outside and in-

side, with a rim at either end. It is closed by a right-hand threaded plug which contains a hole in the center to receive a right-hand threaded fuze.

The sleeve that holds in place the firing pin and the creep spring is held to the fuze by means of a small screw. The detonator is crimped to the lower part of

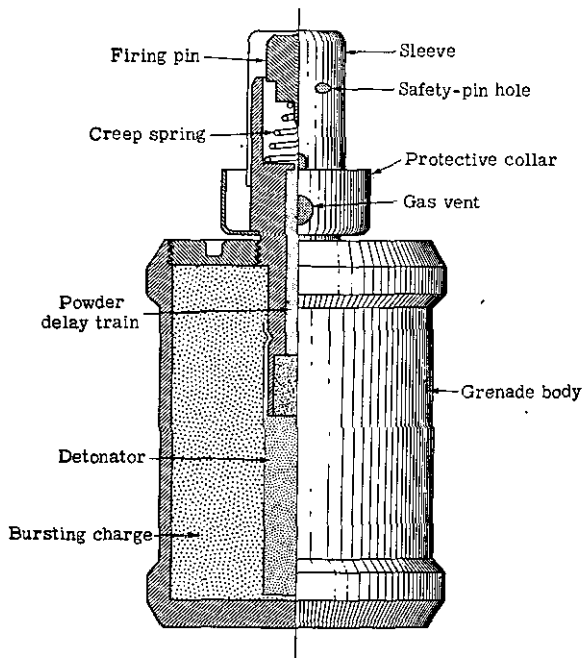

Figure 32.—Cross section of Model "Kiska" hand grenade.

the fuze body. A small collar, which surrounds the base of the sleeve, serves to protect the thrower's hand from the sparks generated when the powder delay train is ignited.

The time delay is 4 to 5 seconds. A gas vent is located between the percussion cap, which is fixed

within the fuze body, and the black-powder train, which initiates the detonator.

(2) *Table of characteristics.*—

Over-all length.....	3½ inches.
Diameter.....	1⅝ inches.
Weight.....	10 ounces (approximately).

d. How to Operate

The safety pin, which is held in place by a cord, prevents the firing pin from striking the percussion cap. The grenade is armed and thrown in the same manner as the Model 91 (par. 10d, p. 46) and the Model 97 (par. 11d, p. 50).

To disarm, replace the safety pin. If none is available, use a piece of heavy wire. Unlike the Models 91 and 97, the firing pin is integral with the firing-pin holder. It therefore cannot be withdrawn.

13. HIGH-EXPLOSIVE STICK HAND GRENADE

a. General

The high-explosive stick hand grenade (fig. 33) is a useful close-range weapon. It is sometimes called the "offensive hand grenade," because it depends in part on blast effect. Fragmentation is probably poor.

b. How to Identify

The high-explosive stick hand grenade may be recognized by its potato-masher shape and the pressed metal cap screwed to the end of the wooden handle.

c. Characteristics.

(1) *General.*—The body of the high-explosive stick hand grenade is cylindrical in shape, is nonserrated,

and has attached to it, by means of wood screws, a wooden handle. Two and three-fourths ounces of

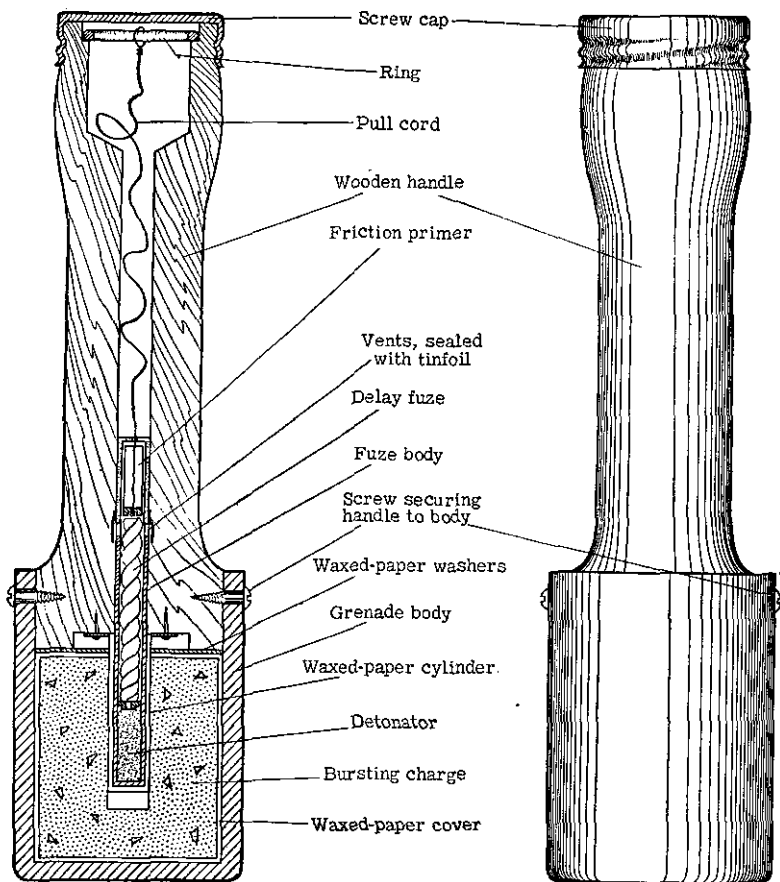

Figure 33.—High-explosive stick hand grenade.

lyddite² make up the bursting charge. The time delay is 4 to 5 seconds.

² A picric-acid explosive.

A trip-wire booby trap can easily be contrived from the high-explosive stick hand grenade; all that is necessary is to attach a wire to the ring of the pull cord (see **d** (2), below) and to something that may possibly be moved, such as a house door, a truck door, a vine, or a trip wire across a path. An attractive souvenir, such as a helmet or the like, supplies an ideal means for setting off such a trap. To render the trap safe, merely cut the wires and replace the ring and screw cap.

(2) *Table of characteristics.*—

Over-all length.....	7.87 inches.
Diameter of grenade body.....	1.97 inches.
Weight.....	1 pound 3½ ounces.

d. How to Operate

(1) *Safety.*—The metal cap screwed to the end of the wooden handle is the safety for the high-explosive stick hand grenade.

(2) *To throw.*—In order to arm and throw the grenade, it is necessary to remove the metal cap screwed to the end of the wooden handle. Inside the hollow handle is a ring attached to a pull cord.

The wooden handle is grasped and the ring placed over a finger, and the grenade is thrown. As the grenade leaves the hand, the ring and cord are retained, thereby pulling out the cord and igniting the friction primer which activates the delaying element.

(3) *To disarm.*—In order to disarm the grenade, merely replace the pull cord and the finger ring in the wooden handle, and screw on the metal cap. Disassembly should be attempted only by trained personnel.

14. INCENDIARY STICK HAND GRENADE

a. General

The incendiary stick hand grenade (fig. 34) is not very well known. That it exists is certain, for there is written information from several sources concerning it, but so far it has not been well identified in the field.

b. How to Identify

The incendiary stick hand grenade cannot be mistaken for the high-explosive stick hand grenade (par. 13, p. 53), for it has curved instead of flat ends.

c. Characteristics

(1) *General*.—The incendiary stick hand grenade has a solid wooden handle with a hole drilled through near the end.

The body of the grenade is filled with phosphorus-impregnated rubber pellets in carbon disulphide. There are some 40 pellets in each grenade, and they are scattered by means of a small central bursting charge, or burster.³

(2) *Table of characteristics*.—

Over-all length	13.2 inches.
Diameter of grenade body.....	2.1 inches.

d. How to Operate

(1) *Safety*.—A safety pin passes through the safety cover of the fuze and prevents the firing pin from

³ It is possible that the grenade is sometimes filled with phosphorous smoke filling.

coming into contact with the percussion cap. On the withdrawal of the safety pin, a creep spring holds the firing pin away until the head of the safety cover is struck.

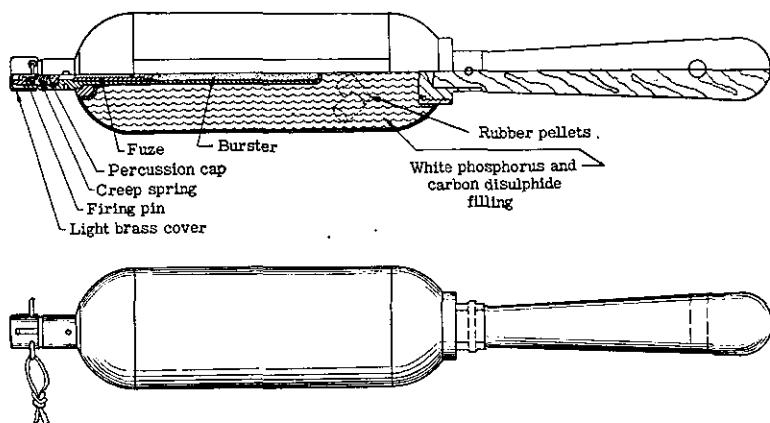

Figure 34.—Incendiary stick hand grenade.

(2) *To arm.*—Make sure that the safety pin is in position and that the firing pin is threaded down into the firing-pin holder.

(3) *To throw.*—With the fuze pointing downward, withdraw the safety pin. Making sure that the safety cover does not fall off, strike the head of the fuze against some hard object, such as the heel of your shoe or the top of your helmet. There should be no delay in throwing the grenade, for the fuzes are sometimes erratic in behavior.

(4) *To disarm.*—Replace the safety pin. If there is none available, use a piece of heavy wire. Then unscrew the firing pin until its head is flush with the top of the firing-pin holder.

15. BANGALORE TORPEDO

a. General

The Bangalore torpedo (fig. 35) is used by the Japanese to demolish barbed-wire entanglements. The fragments sever the wire. The torpedo can also be used as a booby trap, actuated by pull.⁴

b. How to Identify

The Bangalore torpedo consists of an explosive charge placed in a piece of common iron pipe, capped on both ends.⁵ Around the body of the pipe, which is about 2 inches in diameter, there is painted a red band. Hanging from one end of the pipe is a braided cord.

c. Characteristics

(1) *General*.—The fuze of the Bangalore torpedo (fig. 36) is shipped separately. It comprises a cylinder flanged at one end, with two delay tubes projecting beyond the flange, and a braided cord projecting from the other end (fig. 36 ②). For shipment, the delay tubes are covered by a cylinder closed to a point at one end. An open-ended cylinder having spiraled grooves on its surface (fig. 36 ③) is screwed into the pointed cylinder, the end of the fuze with the braided cord projecting through the open-ended cylinder as

⁴ There have been casualties when U. S. soldiers tried to use the pipes as crowbars or fire grates.

⁵ A Bangalore torpedo made of split bamboo was found at Milne Bay. It had five to seven charges placed in the hollow spaces of the pole, connected by a length of primer cord. At one end of the primer cord was a short length of safety fuse and a detonator; the torpedo was functioned by igniting the short length of safety fuse.

shown in figure 36 ①. The pipe containing the explosive is capped at both ends, the caps being removed when the torpedo is made ready for use.

(2) *Table of characteristics.*—

Over-all length..... 40 inches.
Diameter..... 2 inches.

d. How to Operate

Remove the caps from the pipe. Insert the fuze in one end with the delay tubes first, and thread the open-ended cylinder over the fuze. Then thread the pointed cylinder onto the other end of the pipe.

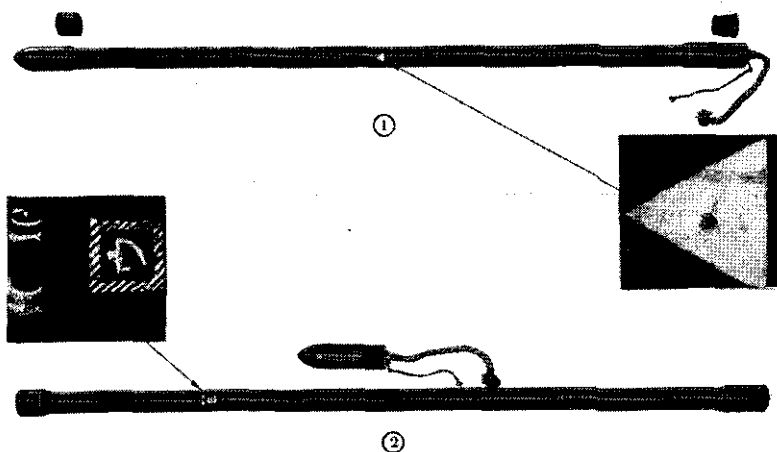

Figure 35.—Bangalore torpedo: ① ready for use and ② with fuze detached for shipment. (The markings shown were found on one torpedo.)

Attach a lanyard to the braided cord that hangs from one end of the pipe. Pull the lanyard sharply to fire a friction primer at the end of the cord within

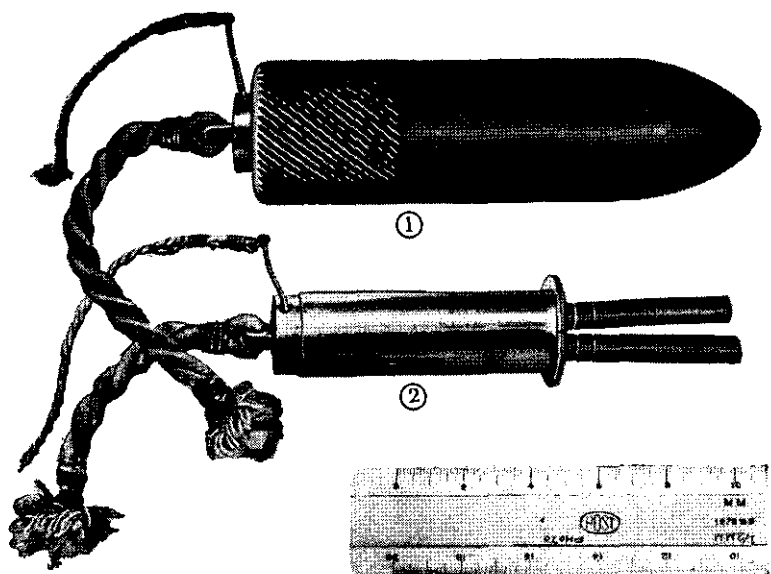

Figure 36.—Fuze used in bangalore torpedo. (The fuze is shown ① assembled for shipment, ② assembled for insertion in pipe, and ③ disassembled.)

the body of the torpedo. Personnel can then take cover, since there is a 6- or 7-second delay before the torpedo will detonate.

16. MODEL 93 (1933) MINE

a. General

The Japanese Model 93 (1933) mine (fig. 37) is commonly called the "tape-measure mine" because of its resemblance to an encased rolled-up tape measure.

b. How to Identify

The Model 93 (1933) mine is painted yellow or olive-drab. There is a brass dome $1\frac{1}{2}$ inches in diameter in the center of the top, with a red ring painted on it. On the side of the mine there are four

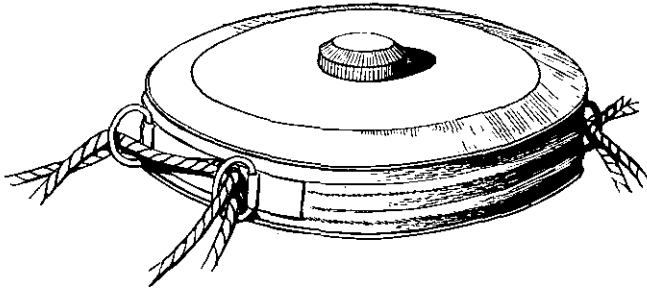

Figure 37.—Model 93 (1933) mine.

metal rings: one pair 2 inches apart on one side, and another pair directly opposite with the same dimension between them.

c. Characteristics

(1) *General.*—The four rings on the side of the Model 93 (1933) mine are carrying rings, but they may also be used to tie the mine in place. The fuze

is under the brass dome (fig. 38). The strength of the shear pin determines the weight which will cause the mine to detonate. This may vary from 7 to 200 pounds. At no time should the brass dome be subjected to any pressure whatsoever.

The mine can be lifted by its rings. But before attempting to do so, examine the vicinity carefully for wires or other contrivances, as this mine is often connected with other explosives to form a booby trap. Usually the mines are laid in a diagonal pattern about 30 inches apart.

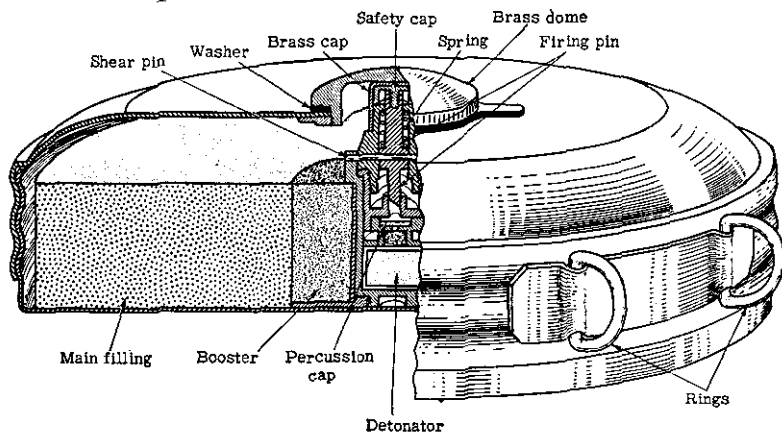

Figure 38.—Cross section of Model 93 (1933) mine.

(2) *Table of characteristics.*—

Diameter	-----	6¾ inches.
Thickness	-----	1¾ inches.
Weight	-----	3 pounds.

d. How to Operate

(1) *Safety.*—There are two safety features on the Model 93 (1933) mine. One is a small safety cap that screws on the end of the firing pin, and when this

is in position, it prevents depression of the firing pin and the explosion of the mine. An additional safety device is a brass cap which fits around the firing pin and safety cap and is surrounded by a washer held in place by the brass dome.

(2) *To arm.*—Unscrew and remove the brass dome. Then remove the brass cap and washer, and unscrew the safety cap from the firing pin. Now replace the dome, and the mine is armed. Pressure on the firing pin will break the shear pin and cause the firing pin to strike the percussion cap, which will fire in succession the detonator, the booster, and the main filling.

(3) *To disarm.*—Unscrew the brass dome and replace the safety cap, brass cap, and washer.

17. MODEL 99 (1939) ARMOR-PIERCING MINE⁹

a. General

The Model 99 (1939) armor-piercing mine (fig. 39) is issued to infantry units and is carried by the individual soldier. The mine is also called a magnetic antitank bomb or a magnetic armor-piercing hand grenade.

Although it is claimed that the Model 99 mine can be thrown by hand, its awkward shape and the position of its magnets make this impracticable. The mine has four permanent magnets attached to its side to hold it against a metal target until it detonates. It should be placed by hand in direct contact with an armored vehicle or with iron doors of pillboxes.

⁹This mine is listed by the Japanese as 九九式破甲爆雷, which is read (from left to right) *Kyukyu Shiki Hako Bakurai*, meaning "99 model armor-piercing mine." (See p. 7, note 1.)

b. How to Identify

The Model 99 (1939) armor-piercing mine is easily recognized by the four equally-spaced permanent magnets attached by khaki webbing to the outer edge of the mine body (figs. 39, 40, and 41).⁷

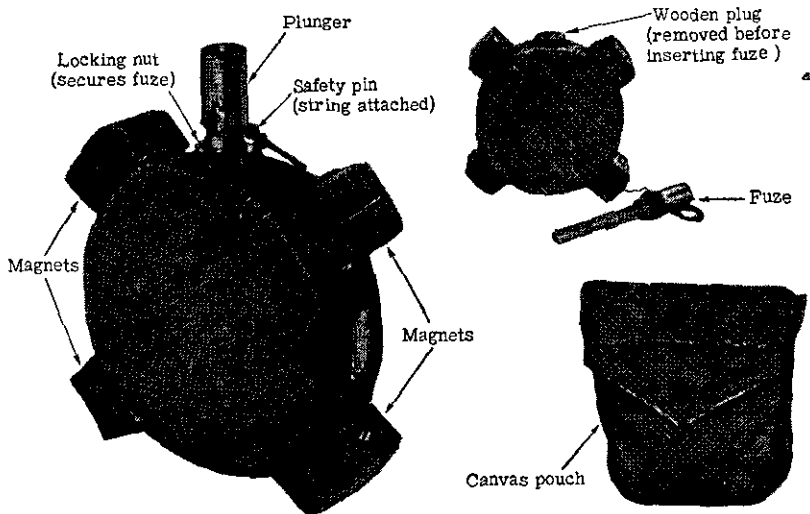

Figure 39.—Model 99 (1939) armor-piercing mine and accessories.

c. Characteristics

(1) *General*.—The Model 99 (1939) armor-piercing mine consists of eight separate sections of cast TNT wrapped in waxed paper, all held together in a khaki-color canvas cover (figs. 40 and 41). The general shape of the mine is that of a flat disk, resembling a water bottle.

⁷ There is a variation of this mine called *Kyuchaku Bakurai*, meaning "magnetic mine." It has the same use as the Model 99, but is shaped like a bun with a flat base. The magnetized surface is the base. This mine, it is believed, can be thrown from a 10-yard range.

The mine is carried in a stiff canvas pouch (figs. 39 and 40) which is attached to the soldier's belt. The fuze is carried separately in a metal cylindrical container which also fits inside the pouch. The fuze

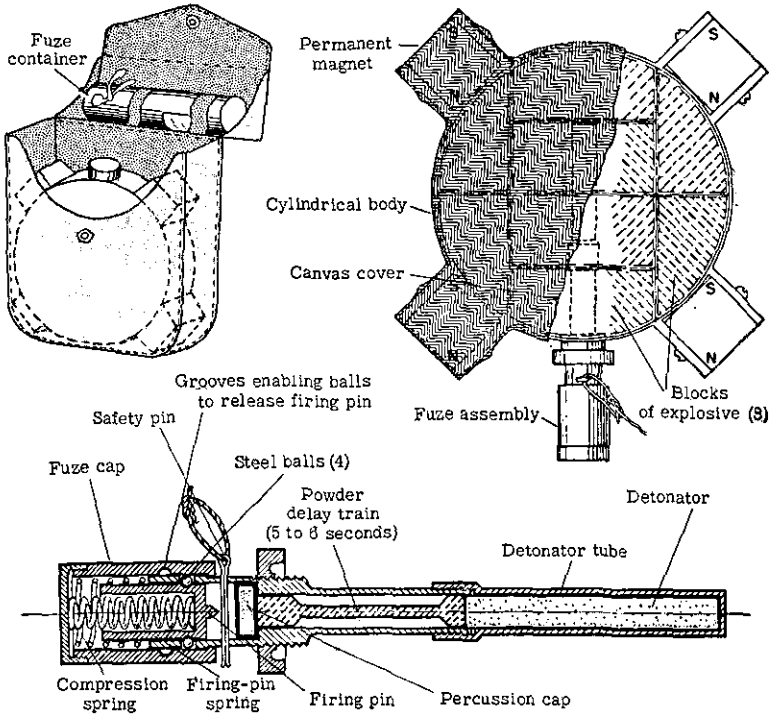

Figure 40.—Diagrammatic drawings of Model 99 (1939) armor-piercing mine (top, right) with its carrying pouch (top, left) and cross section of fuze assembly (bottom).

must be inserted in the mine prior to using. When the mine is carried in the pouch, a wooden plug is inserted in the fuze cavity.

(2) *Table of characteristics.*—

Diameter	-----	4¾ inches.
Thickness	-----	1½ inches.
Total weight	-----	2 pounds 11 ounces.
Length of fuze	-----	5¼ inches.
Size of carrying pouch	-----	7½ by 6½ by 1¾ inches

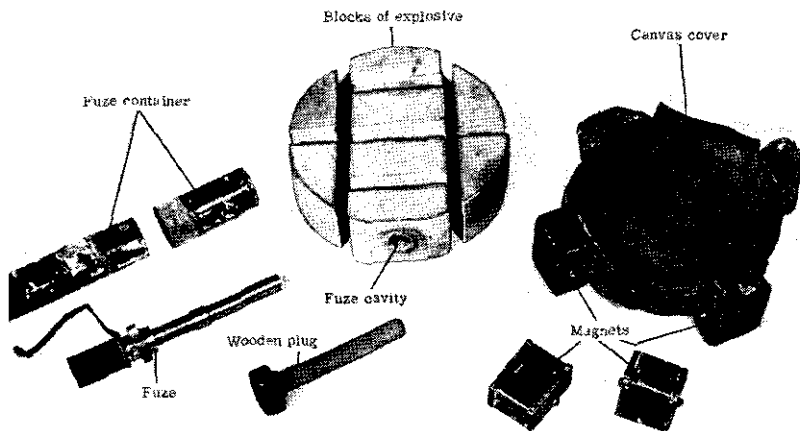

Figure 41.—Model 99 (1939) armor-piercing mine disassembled.

d. How to Operate

(1) *General.*—The Model 99 (1939) mine may be employed singly against three-quarter-inch armorplate or coupled with a second mine for penetration of 1¼-inch plate. Coupled mines are considered the usual method of use. To couple the mines, place one on top of the other so that opposite magnetic poles are together.

(2) *To arm.*—With the fuze inserted in the cavity (fig. 41), the Model 99 armor-piercing mine should be placed by hand in direct contact with any steel or iron part of the objective after the safety pin

has been withdrawn by means of the cord attached. the fuze is armed by giving the fuze cap (fig. 40) a sharp rap after the mine is placed on the objective. A 5- or 6-second delay gives a man time to retire to safety.

(2) *To disarm.*—To disarm the Model 99 armor-piercing mine and render it safe, the following steps should be followed:

(a) Do not put any weight on the fuze cap;

(b) If the safety pin is absent, insert a piece of heavy wire in the safety-pin hole;

(c) Unscrew the fuze.

If the fuze cap has been depressed (this can be easily determined when an attempt is made to replace the safety pin, and the safety-pin holes are not found clear), do not attempt to disarm the mine. Mark the mine as a dud and leave it for trained disposal personnel.

Section V. GRENADE DISCHARGERS

18. INTRODUCTION¹

Designed for use by the individual soldier, grenade dischargers bridge the gap in range between hand grenades and mortars. Sometimes they have been mistakenly called "knee mortars," perhaps because of the curved shape of the small attached base plate. This base plate is made to rest on the ground—not on a soldier's knee or thigh²—while the discharger is being fired.

Two types of grenade discharger, both 50-mm, have been used by the Japanese: the Model 89 (1929) and the Model 10 (1921), which is the smaller of the two.

In the hands of experienced personnel, the grenade discharger is an effective short-range weapon, especially in areas where visibility is poor.

19. MODEL 10 (1921) 50-MM GRENADE DISCHARGER³

a. General

The Model 10 (1921) 50-mm grenade discharger (fig. 42), constructed entirely of steel, was perfected

¹ Grenade dischargers are sometimes referred to as grenade launchers or grenade throwers. See MID *Intelligence Bulletin*, Vol. I, No. 9 (May 1943), p. 15, and TM 30-480, "Handbook on Japanese Military Forces" (21 Sep 1942), par. 33, p. 101.

² When a Marine on Guadalcanal fired one of the dischargers from his thigh, his upper leg bone was broken by the force of the recoil.

³ This weapon is listed by the Japanese as 十年式擲彈筒, which is read (from left to right) *Junen Shiki Tekidanto*, meaning "10th year model

in 1921. Commonly known as the "10-year type," it is still being used by the Japanese, mainly for firing signal pyrotechnics. It also fires the Model 91 (1931) grenade (see par. 10, p. 45).

b. How to Identify

The Model 10 (1921) 50-mm grenade discharger may be distinguished from the Model 89 (1929) (par. 20, p. 73) by observing that its range is regulated by a gas port and that its barrel is not rifled.

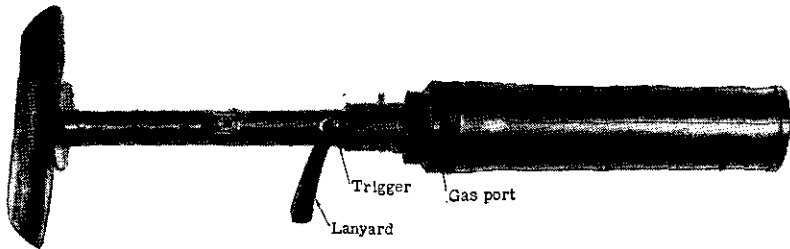

Figure 42.—Model 10 (1921) 50-mm grenade discharger.

c. Characteristics

(1) *General.*—The Model 10 (1921) 50-mm grenade discharger is muzzle-loaded, and is fired by a firing pin which is operated by a lever on the outside of the discharger body. Like the newer type, the 1921 model is fired while attached to a small base plate, which is used as a spade. No bipod attachments are used.

grenade discharger." (See p. 7, note 1.) The Japanese tactical symbol and abbreviation for a grenade discharger are I MW . *MW*, an abbreviation of the German *Minenwerfer* ("mine thrower"), is rarely found with the symbol.

(2) *Table of characteristics.*—

Ammunition-----	Model 91 grenade, Model 11 smoke shell, Model 10 flare shell, Model 10 signal shell, Model 91 practice grenade, Model 10 blank shell, etc.
Length of barrel-----	9½ inches.
Over-all length-----	20 inches.
Weight-----	5¼ pounds.
Range for Model 91 grenade---	65 to 175 yards.
Barrel-----	Smooth bore.
Transport-----	Carried on the man.

d. How to Operate

(1) *Safety.*—There is no safety on this weapon.

(2) *To load and fire.*—The grenade or signal projectile, with safety pin removed, is placed in the barrel, and then the weapon is fired by a trigger attached to the pedestal. When the trigger is pulled, the following action takes place: the trigger pin rotates in a notch, and the trigger lips compress the firing-pin spring by engaging and forcing the cocking-piece sleeve forward on the firing-pin spring guide.

When the sear has rotated approximately one-half the way back, it slips off the notch and releases the firing-pin spring guide, which jumps forward because the firing-pin spring is compressed. Thus the firing pin contacts the primer. When the trigger is released, the firing-pin spring—which still has a slight tension—forces the trigger back into position to be fired again.

Upon being released, the sear moves back over the notch, which has a small leaf spring that depresses and also allows the notch to move downward. This latter

movement allows the sear to go back to its original position so that the piece can be fired again.

This complete operation takes place each time the trigger is pulled, since the firing mechanism is of the continuous-pull type.

The range-control gauge governs the range of the projectile by the opening or closing of a gas port in the base of the barrel which in turn regulates the gas expansion within the barrel. By opening the gas port to its fullest extent, the range is decreased to its minimum; by closing the port, the range is increased to its maximum. The discharger is fired at a constant elevation of 45 degrees.

e. Ammunition

This weapon fires principally the Model 91 (1931) hand grenade (par. 10, p. 45) and signal and smoke projectiles.

f. Maintenance

(1) *Oiling and cleaning.*—Care must be taken to keep the bore clean.

(2) *Stripping.*—The following procedure will permit a complete disassembly of the weapon (see fig. 43):

(a) Release the latch on the pedestal adapter and unscrew the barrel.

(b) Unscrew the gas regulator from the tube.

(c) Unscrew the pedestal-adapter coupling and remove the pedestal adapter and the split bushing.

(d) Remove the axis-pin retaining lock and the axis pin, and lift out the trigger.

(e) Turn the firing pin one-half turn and slip it forward until it engages the shoulders in the pedestal; then turn the pin one-half turn and remove it.

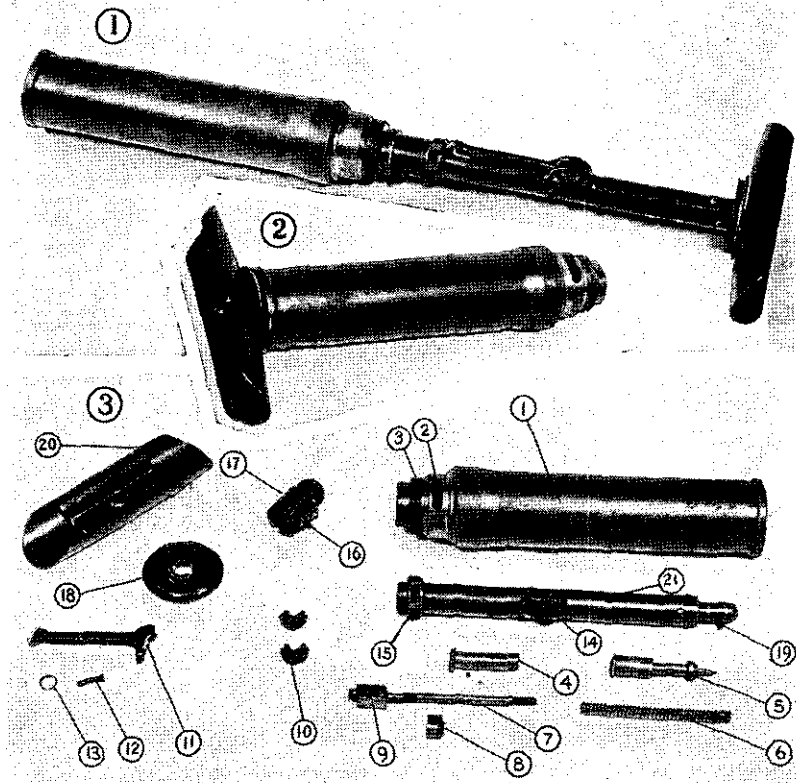

Figure 43.—Three views of Model 10 (1921) 50-mm grenade discharger: ① assembled, ② assembled for carrying, and ③ disassembled.

- | | |
|--|--------------------------------|
| 1. Barrel. | 11. Trigger. |
| 2. Gas port. | 12. Axis pin. |
| 3. Threaded portion of tube for gas regulator. | 13. Axis-pin retaining lock. |
| 4. Firing-pin spring guide. | 14. Scar. |
| 5. Firing pin. | 15. Pedestal-adaptor coupling. |
| 6. Firing-pin spring. | 16. Pedestal-adaptor latch. |
| 7. Striker. | 17. Pedestal adaptor. |
| 8. Firing-pin spring follower. | 18. Muzzle cap. |
| 9. Sear spring. | 19. Base-plate spring latch. |
| 10. Split-pin bushing. | 20. Base plate. |
| | 21. Pedestal. |

(f) Compress the firing-pin spring, unscrew the striker from the firing pin, and remove the spring, guide, and spring follower.

(g) Depress the base-plate spring latch, and remove the base plate and muzzle cap from the pedestal.

(3) *Assembly*.—To assemble the weapon, proceed in the reverse order to that followed in stripping. The weapon may, however, be assembled to the carrying position as shown in figure 43②, by unscrewing the pedestal adapter from the barrel and inserting the pedestal into the barrel. The threaded section of the adapter screws into the base of the barrel from the inside of the barrel, and the muzzle cap screws into the barrel, completely enclosing the interior of the barrel and protecting it from foreign material. The weapon is then in a compact assembly for carrying.

20. MODEL 89 (1929) 50-MM GRENADE DISCHARGER ⁴

a. General

The Model 89 (1929) 50-mm grenade discharger (fig. 44), perfected in 1929, is an improvement over the earlier Model 10 (1921) (par. 19, p. 68). The fourth squad of the Japanese infantry platoon is equipped with three (or four) grenade dischargers (see fig. 1, p. XIV, which, in an attack, are fired to pin the enemy to the ground while the other squads attack.

⁴This weapon, commonly called *Juteki*, is listed by the Japanese as 八九式重擲彈筒, which is read (from left to right) *Hachikyu Shiki Jutekidanto*, meaning "89 model heavy grenade discharger." (See p. 7, note 1.) The Japanese tactical symbol and abbreviation for a grenade discharger are  MW. (See p. 68, note 3.)

b. How to Identify

The Model 89 (1929) 50-mm grenade discharger may be identified by—

- (1) The rifling in the barrel.
- (2) The adjustable firing-pin housing, which moves up and down in the barrel.
- (3) The concave base plate.

c. Characteristics

(1) *General.*—The Model 89 (1929) 50-mm grenade discharger is constructed of steel in the form of a pipe-like rifled barrel which is attached to a small base plate. The plate is curved so that it can be fitted over a medium-sized tree trunk or log (see fig. 45). The trigger housing (pedestal) is a tubular piece of metal with a lengthwise slot. Protruding through this slot is the trigger which cocks and fires in one operation. A spring sleeve covers the trigger housing at the base plate. A range-adjusting assembly is attached to the base cap of the barrel.

(2) *Table of characteristics.*—

Ammunition	Model 89 high-explo- size shell, Model 91 grenade, Model 95 smoke shell, Model 94 practice shell, etc.
Length of barrel.....	10 inches.
Over-all length.....	24 inches.
Weight	10¼ pounds.
Weight of Model 89 shell.....	1 pound 12 ounces.

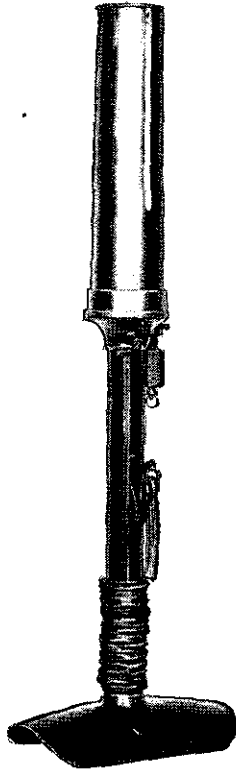

**Figure 44.—
Model 89
(1929)
50-mm
grenade
discharger.**

Range scale:

On left of tube, for Model 89 shell... 120 to 650 meters
(131.2 to 710.8 yards).

On right of tube, for Model 91 40 to 190 meters (43.7
grenade. to 207.8 yards).

Maximum range:

For Model 89 shell..... 770 yards.

For Model 91 grenade..... 175 yards.

d. How to Operate

(1) *Safety.*—There is no mechanical safety on this weapon. The only precaution that can be taken is to keep the bore clean in order to prevent the grenade from becoming stuck in the bore when fired.

(2) *To load and fire.*—The discharger has range scales on both sides of the lengthwise trigger slot, and the weapon can be set at the desired range by turning the elevating knob. When the knob is turned, it lengthens or shortens the trigger housing extending in-

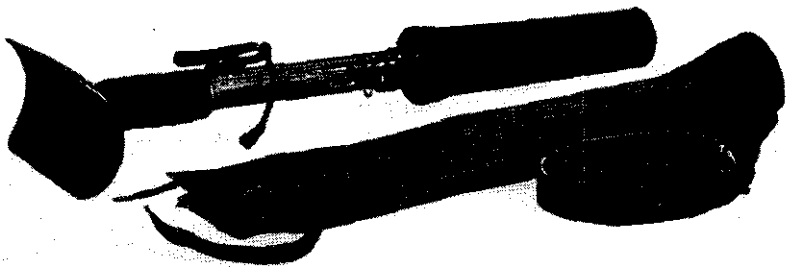

Figure 45.—Model 89 (1929) 50-mm grenade discharger, showing also canvas carrying case.

side the barrel of the discharger. Thus the range of the weapon can be regulated by increasing or decreasing the distance traveled by the projectile through the barrel. The weapon can be fired by resting the spade on the ground or any other solid base (see figs. 46 and 47).

It is believed that the discharger fires most effectively from an angle of about 45 degrees. A modified version of the Model 89 found on Attu has a bubble-leveling device for indicating the angle of fire (see fig. 48). The

Model 89 has no sight except a grooved line which extends from the muzzle for a short distance down the barrel.

Preparatory to operation, the safety pin on the Model 89 (1929) shell (see e (1), below) is removed and the shell is placed in the barrel and allowed to drop to the firing-pin housing, where it remains until fired.



Figure 46.—Firing Model 89 (1929) 50-mm grenade discharger from kneeling position.

When the operator pulls the trigger (by pulling a short leather lanyard which is fastened to the trigger), the following action takes place: cogs in the trigger move the mainspring housing forward by engaging cogs in the front of the housing, thereby causing the mainspring to be compressed (see fig. 49). As this action takes place, the sear engages against the cocking lug



Figure 47.—Firing Model 89 (1929) 50-mm grenade discharger from prone position.

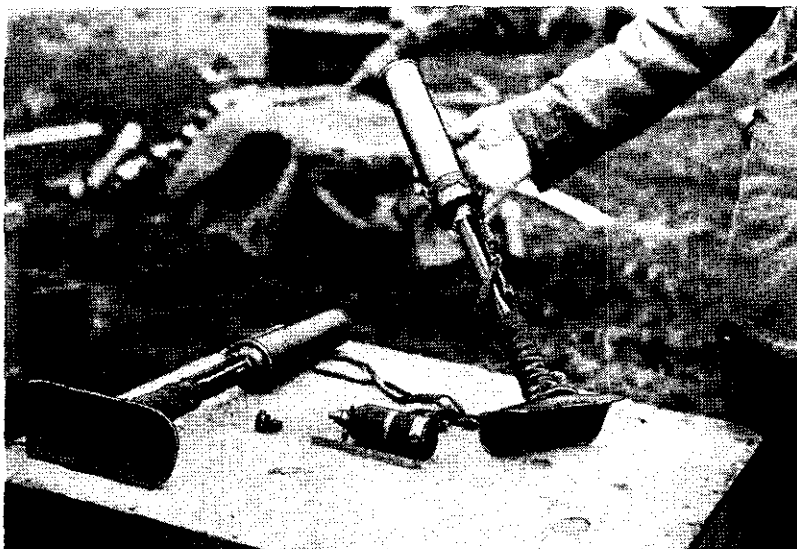

Figure 48.—Modified version of Model 89 (1929) 50-mm grenade discharger.

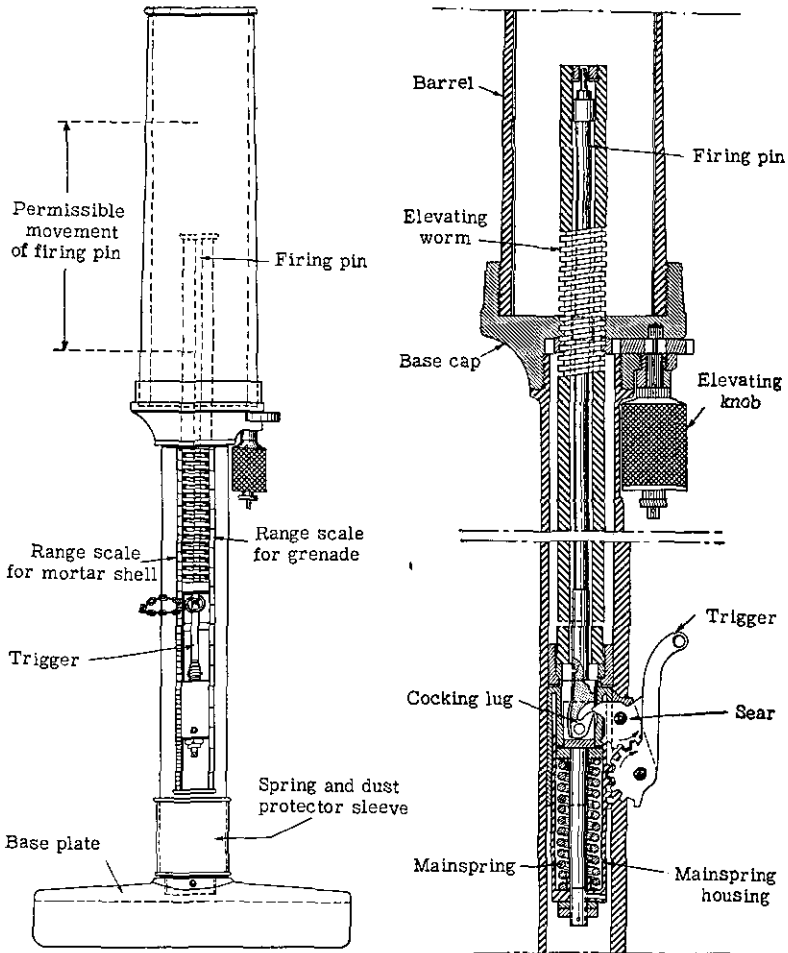

Figure 49.—Diagrammatic drawings of Model 89 (1929) 50-mm grenade discharger, showing range scales (left) and cross section of firing mechanism (right).

of the firing-pin shaft. A continued pull on the trigger allows the sear to become disengaged from the cocking lug, and the compression of the mainspring,

upon being released, sends the firing pin forward and sets off the propellant.

e. Ammunition

(1) *Model 89 (1929) 50-mm high-explosive shell.*—The discharger fires high-explosive (fig. 50; see also fig. 31, p. 50), incendiary (fig. 51), smoke, and signal projectiles. The Model 89 (1929) high-explosive shells which have been examined weigh 1 pound 12

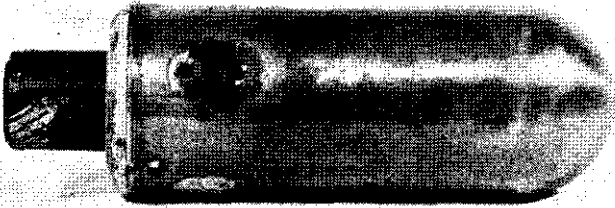

Figure 50.—Two types of ammunition fired in Model 89 (1929) 50-mm grenade discharger. (From left to right are shown the Model 89 (1929) shell ① disassembled, ② assembled; the Model 91 (1931) hand grenade ③ with propellant container, ④ without propellant container.)

ounces, and are painted with black enamel, with a quarter-inch red band at the head and a slightly larger yellow band around the center of the shell body. The shell consists of three major parts: the fuze (Model 88), the body, and the propellant assembly. The fuze is of a simple point-detonating type with a safety pin. The fuze is safe

until the pin is pulled out. It is armed by setback when the shell is fired.

The body of the projectile is made of mild steel. It serves as a receptacle for 0.31 pound of TNT-type explosive filler.



**Figure 51.—50-mm incendiary grenade for use in Model 89 (1929)
50-mm grenade discharger.**

The propellant assembly consists of the percussion cap, the propellant, and an expanding copper rotating band. This unit is assembled to the body by a right-hand screw thread, and is ignited when the firing pin hits the percussion cap. When the firing action occurs, the propelling gases expand the copper band against the rifling. This action causes the projectile to rotate. The fuzes for the Model 89 shells are packed separately (figs. 52, 53, and 54).

(2) *Model 91 (1931) high-explosive grenade.*—The Model 91 (1931) high-explosive grenade (fig. 50) consists of two parts: the body and a base attachment that contains a propellant and primer. The grenade can be



Figure 52.—Packing box for fuzes used in Model 89 (1929) 50-mm shells (100 fuzes).

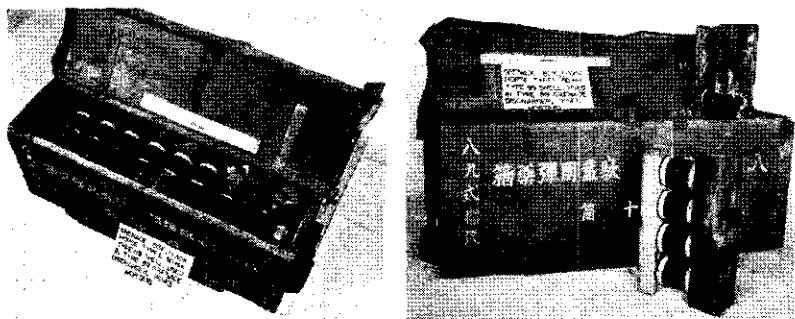

Figure 53.—Two views of packing box for Model 89 (1929) 50-mm shells, showing method of packing individual shells (40 rounds without fuzes).

thrown by hand (see par. 10, p. 45) or fired from a grenade discharger. If thrown by hand, the propelling charge can be removed. To use the grenade in the discharger, the safety pin is removed, the grenade is placed in the barrel, and the trigger is pulled.

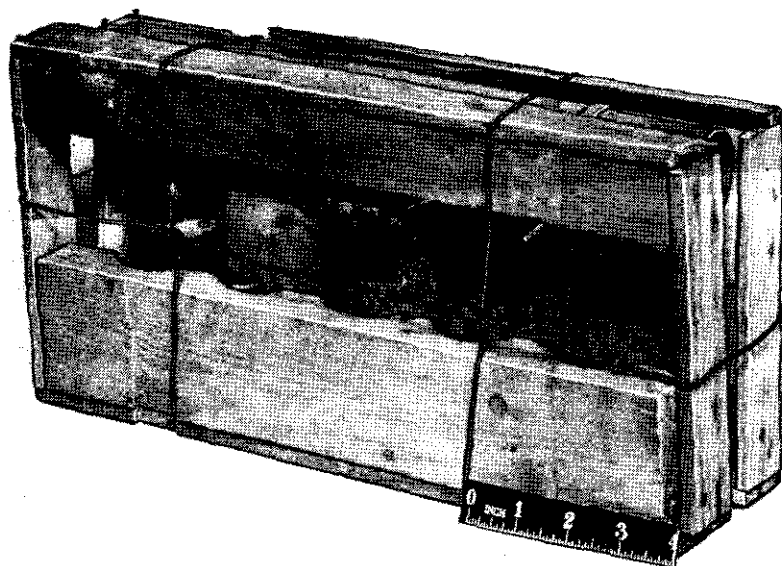

Figure 54.—Crate of five Model 89 (1929) 50-mm shells used in Model 89 (1929) 50-mm grenade discharger.

During shipment the screw, which acts as the firing pin, is flush with the top of the firing-pin holder. The grenade will not operate unless this screw is turned inward until it is in the position shown in figure 29, page 47. The safety pin should be kept in place while the screw is being turned.

The Model 91 grenade is a much less accurate projectile than the Model 89 shell, because the grenade is un-

stable in flight, there being no provision on it to take the rifling in the barrel. The fuze is initiated by setback.

When this grenade is used as a hand grenade, the fuze cover is hit on some hard object to initiate the powder delay train, and then the grenade is thrown. Although the powder delay train is apparently intended to give a delay of 8 to 9 seconds, reports indicate that the delay action is erratic.

(3) *50-mm incendiary grenade*.—The 50-mm incendiary grenade (fig. 51) is a cylindrical sheet-metal tube with a semispherical nose, and is covered with a clear lacquer. Around the side of the grenade are four silver foil disks, each disk covering seven holes through the grenade casing. The base is of light metal, threaded to receive the propelling charge.

The propelling charge is the same type as that used with the Model 91 (1931) grenade.

The grenade weighs 1.25 pounds and contains a charge weighing 0.67 pound of the following specifications:

	<i>Percent</i>
Potassium nitrate.....	47.7
Aluminum.....	21.7
Sulphur.....	19.9
Antimony trisulphide.....	6.1
Wax.....	2.8
	98.2

The charge is ignited by two black-powder pyrotechnic trains that run through the base of the grenade. These are actuated by the flash of the propellant.

(4) *Other ammunition.*—In addition to the Model 89 high-explosive shell and the Model 91 high-explosive grenade, the following types of ammunition may also be used:

- (a) Model 94 practice shell.
- (b) Model 94 dummy shell.
- (c) Model 95 smoke shell.
- (d) Model 11 smoke shell.
- (e) Model 10 flare shell.
- (f) Model 10 signal shell.
- (g) Model 91 practice grenade.
- (h) Model 10 blank shell.

f. Maintenance

(1) *Oiling and cleaning.*—To operate efficiently, the bore and the moving parts of the weapon such as the elevating worm gear and the trigger assembly must be kept free from dirt.

(2) *Stripping.*—The following procedure will permit a complete disassembly of the weapon (see fig. 55):

- (a) Unscrew the barrel from the base cap.
- (b) Remove the elevating-nut lock ring, the elevating-knob retaining nut, and the elevating knob.
- (c) Remove the elevating-knob shaft retaining sleeve and the elevating-knob shaft.
- (d) Remove the elevating-knob gear.
- (e) Unlock the finger lock on the side of the base cap, and unscrew the base cap (right-hand thread).
- (f) Remove the elevating worm gear.
- (g) Remove the trigger-pin lock ring, the trigger pin, and the trigger.

(h) Remove the elevating-worm assembly from the pedestal.

(i) Remove the mainspring housing, the spring-housing retaining-nut lock ring, and the spring-housing retaining nuts from the base of the firing pin.

(j) Remove the mainspring housing and the mainspring.

(k) Remove the trigger housing assembly (which includes the sear pin, sear, and mainspring follower).

(l) Remove the firing pin (which includes the striker, screw, spring, cocking lug, and trigger).

(m) Remove the firing-assembly locking collar.

(n) Remove the two screws holding the pedestal in the base plate.

(o) Remove the base plate.

(p) Remove the spring and dust-protector sleeve from the bottom of the pedestal.

(Key to fig. 55)

- | | |
|--|---|
| 1. Barrel. | 17. Trigger pin. |
| 2. Base cap. | 18. Sear pin. |
| 3. Firing pin. | 19. Elevating-nut lock ring. |
| 4. Pedestal. | 20. Spring-housing retaining-nut lock ring. |
| 5. Elevating worm. | 21. Trigger-pin lock ring. |
| 6. Firing-assembly locking collar. | 22. Elevating-knob retaining nut. |
| 7. Mainspring housing. | 23. Elevating-knob shaft. |
| 8. Mainspring. | 24. Trigger. |
| 9. Mainspring follower. | 25. Base plate. |
| 10. Sear. | 26. Spring and dust-protector sleeve. |
| 11. Trigger housing. | 27. Base-plate screws. |
| 12. Elevating knob. | 28. Striker. |
| 13. Elevating-knob gear. | 29. Screw. |
| 14. Elevating worm gear. | 30. Spring. |
| 15. Spring-housing retaining nuts. | 31. Cocking lug. |
| 16. Elevating-knob shaft retaining sleeve. | |

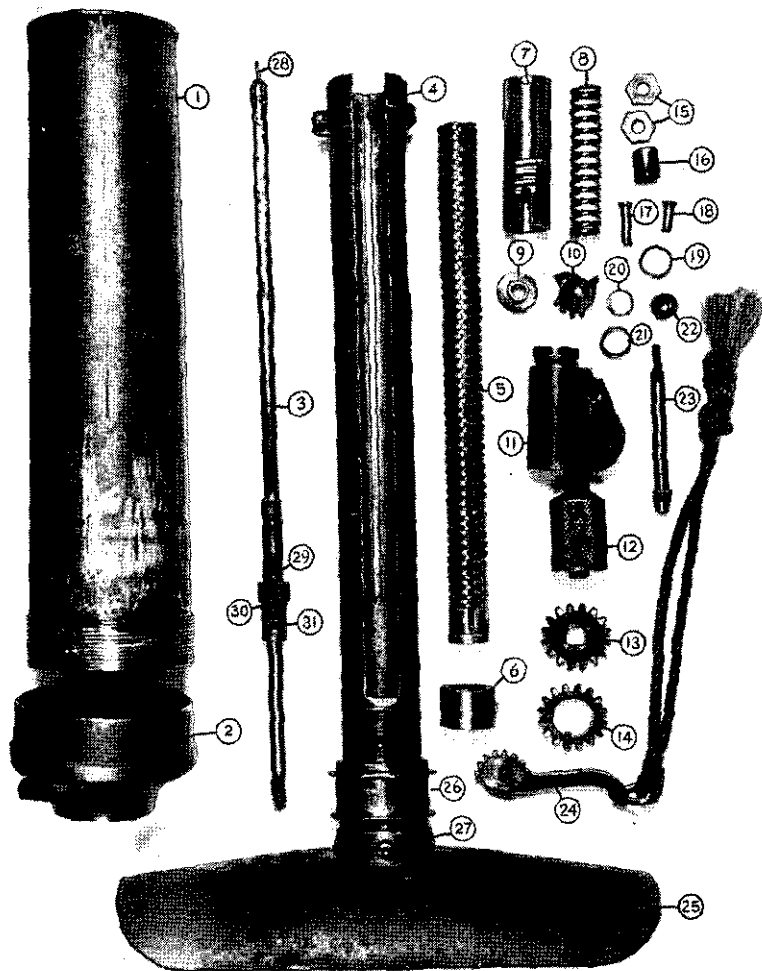

Figure 55.—Disassembled parts of Model 89 (1929) 50-mm grenade discharger.

(Key on opposite page)

Section VI. MACHINE GUNS

21. MODEL 11 (1922) 6.5-MM LIGHT MACHINE GUN ¹

a. General

The Model 11 (1922) 6.5-mm light machine gun (fig. 56) has been standard equipment in the Japanese infantry squad. As compared with other machine guns,

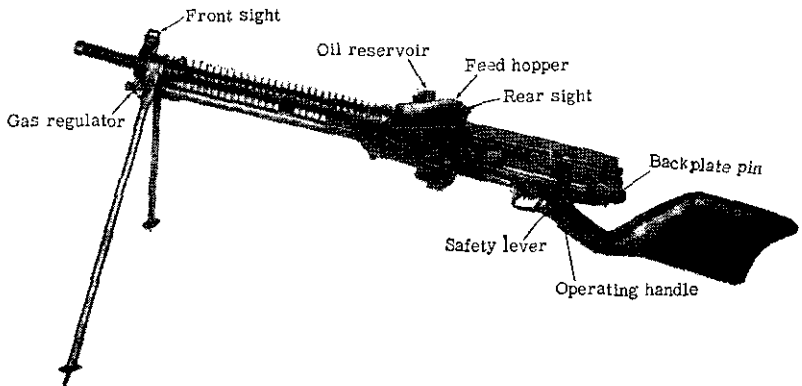

Figure 56.—Model 11 (1922) 6.5-mm light machine gun (left side).

it is unusual in that it is fed by 5-round clips of ammunition. It fires reduced-charge rifle cartridges and will not function properly with the standard-charge rifle ammunition. Although a newer light machine gun of this caliber, the Model 96 (par. 22, p. 96), is

¹This weapon, commonly called *Nambu Keiki*, is listed by the Japanese as 十一年式輕機関銃, which is read (from left to right) *Juichinen Shiki Keikikanju*, meaning "11th year model light machine gun." (See p. 7, note 1.) The Japanese symbol and abbreviation for a light machine gun are ♂ LG. LG, an abbreviation of the German *leichtes Gewehr* ("light gun"), is rarely found with the symbol.

now in use, the Model 11 is still used and is not obsolete. It is employed as a light machine gun on the bipod mount and as a combination heavy and anti-aircraft gun on the tripod mount; the tripod mount is seldom encountered.

b. How to Identify

The Model 11 (1922) 6.5-mm light machine gun may be identified by—

(1) The feed hopper (figs. 57 and 58) by which 30 rounds are loaded, consisting of six 5-round clips of rifle cartridges placed one on top of the other.

(2) The cutout section of the shoulder stock.

(3) The front and rear sights offset to the right.

(4) The marking $+一$ 年式 which is on top of the receiver. (This marking, which is read *Juichinen Shiki* from left to right,² means "11th year model.")

c. Characteristics

(1) *General.*—The Model 11 (1922) 6.5-mm light machine gun is gas-operated, air-cooled, and hopper-fed. Like many Japanese automatic weapons, its design stems from the Hotchkiss (French) gun, but the method of feed, consisting of a hopper attached to the left side of the receiver opposite the feedway and charged with clips of cartridges, is unique.

(2) *Table of characteristics.*—

Caliber	6.5 mm (.256 inch).
Principle of operation	Gas-operated, full-automatic only.
Ammunition	Model 38 (1905) semirimmed, reduced-charge cartridges in 5-round clips.

² See p. 7, note 1.

Type of feed..... Hopper.

Sights:

Front Inverted V blade with guards,
offset to right.

Rear..... Leaf with open V notch sliding
on ramp, graduated from 300
to 1,500 meters (328.1 to 1,640
yards), offset to right; no
windage adjustment.

Length of barrel..... 19 inches.

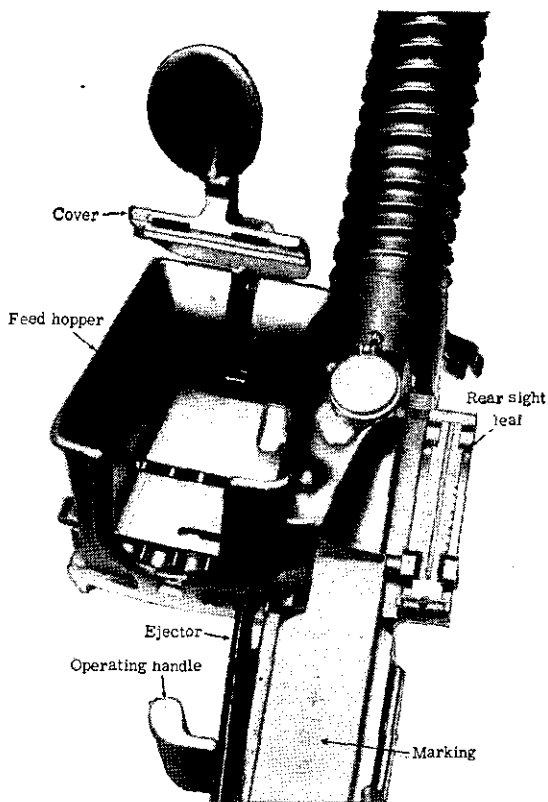

Figure 57.—Close-up of feed hopper (empty) of Model 11 (1922)
6.5-mm light machine gun.

Over-all length	43½ inches.
Weight	22½ pounds.
Range:	
Effective	1,640 yards.
Maximum	4,374 yards.
Muzzle velocity	2,440 feet per second.
Rate of fire:	
Effective	150 rounds per minute in 5-round bursts.
Cyclic (maximum)	500 rounds per minute.

d. How to Operate

(1) *Safety*.—A safety lever on the left of the trigger guard is shifted downward until approximately

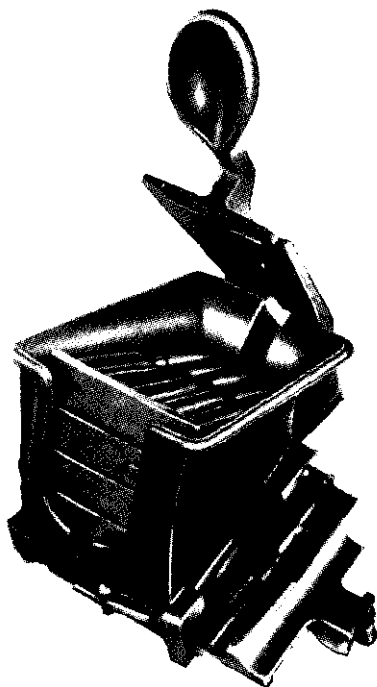

Figure 58.—Loaded feed hopper of Model 11 (1922) 6.5-mm light machine gun.

vertical for "safe." In this position its lower end engages two small notches in the side of the trigger guard and cannot easily be displaced. For "fire," the safety lever is rotated backward and upward until it points horizontally to the rear.

The safety lever is attached to the end of a pin, part of which is cut away. When the safety lever is set at "safe," the solid portion of the pin obstructs the

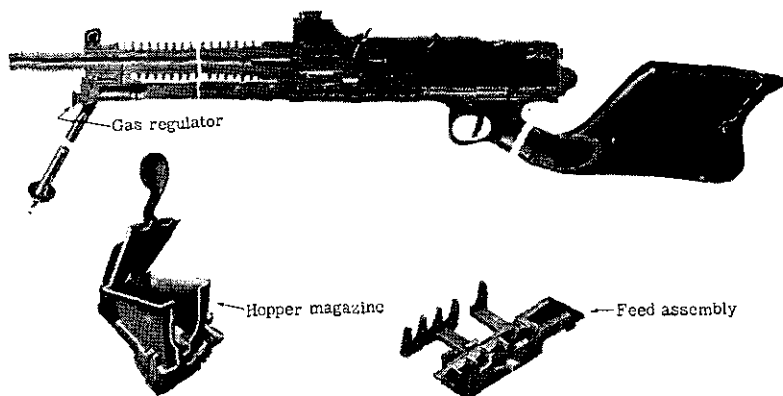

Figure 59.—Diagrammatic cross section of Model 11 (1922) 6.5-mm light machine gun, showing also various parts.

trigger, whereas when it is set on "fire," the cutaway allows the trigger to operate freely and to depress the sear.

(2) *To load and fire.*—(a) *General.*—Be sure that the oil in the oil reservoir is adequate. Raise the follower of the feed hopper and insert horizontally six clips of cartridges. Allow the follower to snap down so as to hold the cartridges and clips in place in the hopper. Cock the gun by pulling back the operating handle on the left until the projection on the piston engages

the sear notch. Push the operating handle forward until its catch clips into the receiver. The gun is now cocked and ready to be fired.

(b) *Regulating rate of fire.*—Similar to the U. S. Browning automatic rifle (BAR) M1918 and modifications, the rate of fire is regulated by means of a gas regulator with several openings of different sizes for the passage of gas through the regulator until it strikes the gas piston. These holes regulate the force with which the bolt recoils. Adjustments are made to “smooth out” the action of the gun so that only enough gas is utilized to force the recoiling parts to the rear smoothly and without their striking the buffer with excessive force. After initial regulation, changes are necessary only when the gun becomes excessively fouled and dirty, so that more force is required to drive the parts rearward.

(3) *Sights.*—The front and rear sights are of necessity offset to the right to prevent obstruction of sighting by the oil reservoir. To set the rear sight, press the knurled catch on the left side of the rear-sight slide, move the slide to the desired range, and release the catch.

(4) *To unload.*—Pull back on the knurled feed-housing lock on the feed-house assembly, where it projects out of the lower center of the right side of the feedway, and remove the feed-housing assembly to the left. Remove the live ammunition from the feed well of the feed-housing assembly and replace the feed-housing assembly in place on the gun. Do not attempt to unload the gun by working live rounds through the

gun, because it fires from an open bolt and will fire when the bolt closes and locks.

e. Ammunition

This gun fires reduced-charge ammunition (par. 42, p. 235), containing 2 grams of propellant instead of the 2.15 grams which is the standard charge for rifle ammunition. All reduced-charge ammunition is marked © on the container (see fig. 154, p. 236). The gun will also fire the standard-charge rifle cartridge, but malfunction will result. The ammunition is loaded in clips of 5, packed 1,440 rounds to the wooden box. Clips are also packed 3 clips (15 rounds) to a cardboard container, and 24 clips (120 rounds) in a small steel case with a handle.

f. Maintenance

(1) *Oiling and cleaning.*—As the rounds are fed into the gun, they pass against an oiled brush. In this manner the ammunition is oiled to prevent ruptured cartridges, as this gun does not have slow initial extraction. The brush is kept oiled from an oil can located above the feed mechanism. Oil should be maintained in this reservoir when the gun is being used.

(2) *Stripping.*—(a) *Backplate.*—Taking care that the backplate does not fly out under spring tension, remove the backplate pin by releasing the catch, turning it down to a vertical position, and pulling it out. Remove the backplate group and operating spring.

(b) *Bolt.*—Pull the bolt slide to the rear and remove the operating slide, the bolt, and the bolt locks. Line up the lugs on the bolt slide with the openings on the

side of the receiver and remove the bolt slide to the left.

(c) *Feed mechanism.*—Pull back on the feed-hopper lock on the feed-hopper assembly where it projects out of the lower center of the right side of the feedway, and remove the feed-hopper assembly to the left.

(d) *Oiler assembly.*—Press down on the oiler lock, which is located directly in front of the rear sight, and remove the oiler by sliding it to the left.

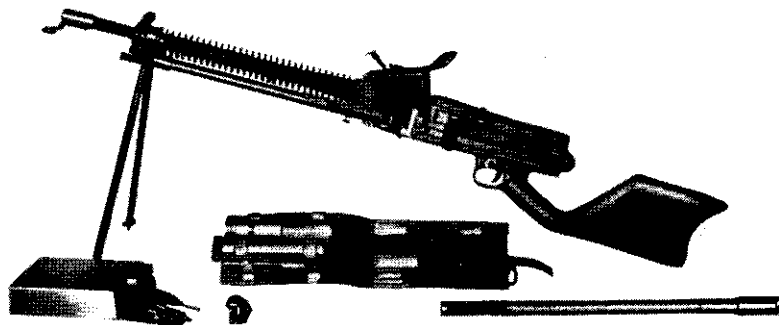

Figure 60.—Model 11 (1922) 6.5-mm light machine gun, showing also accessories.

(e) *Trigger housing.*—Using a drift, drive out the trigger-housing pin from right to left. This pin is located between the trigger housing and the receiver, directly behind the trigger. The trigger housing together with the shoulder stock can now be removed by sliding to the rear.

(f) *Barrel and barrel jacket.*—Remove the barrel-jacket lock retainer plate, located on the left rear part of the gas piston tube. Remove the barrel-jacket lock retainer, and the barrel-jacket lock can now be

driven out to the front. Unscrew the barrel jacket from the receiver (right-hand threads).

(3) *Assembly*.—To assemble the weapon, proceed in the reverse order to that followed in stripping.

g. Accessories

Among the accessories of this weapon are an extra barrel, a box of cleaning equipment, and a kit containing tools, a spare operating spring, and other spare parts. (See fig. 60.)

22. MODEL 96 (1936) 6.5-MM LIGHT MACHINE GUN³

a. General

The Model 96 (1936) 6.5-mm light machine gun (fig. 61) is very similar in appearance to the British Bren light machine gun, caliber .303. In construction, however, it embodies certain features of modern European light machine guns, particularly the Hotchkiss (French) and the Z. B.⁴ (Czech). The mechanism is largely an improvement on the Model 11 (1922) 6.5-mm light machine gun (par. 21, p. 88). It handles well and can be fired easily from the hip. It is fitted to take the Japanese service bayonet Model 30 (1897) (fig. 20, p. 33).

³This weapon, commonly called *Kyuroku Shiki Keiki*, is listed by the Japanese as 九六式軽機関銃, which is read (from left to right) *Kyuroku Shiki Keikikanju*, meaning "96 model light machine gun." (See p. 7, note 1.) The Japanese tactical symbol and abbreviation for light machine gun are ⚡LG. (See p. 88, note 1.)

⁴*Zbrojovka, Brno*, a Czechoslovak armament factory in the city of Brno (Brünn). Now under German control, it is known as *Waffenfabrik, Brünn*.

b. How to Identify

The Model 96 (1936) 6.5-mm light machine gun may be identified by—

(1) The carrying handle directly in front of the receiver.

(2) The operating handle on the left of the receiver.

(3) The drum-controlled peep rear sight.

(4) The quick-change barrel with the swinging-arm type of release catch.

(5) The similarity in appearance to the British Bren light machine gun.

(6) The marking 九六 九 which is on the right side of the receiver. (This marking, which is read *Kyuroku Shiki* from left to right,⁵ means "96 model.")

c. Characteristics

(1) *General*.—The Model 96 (1936) is a later type of Japanese light machine gun. It is gas-operated and air-cooled, a spare barrel being carried for changing should it be necessary. The method of feeding is by a curved-box magazine, containing 30 rounds, which is placed on top of the receiver.

(2) *Table of characteristics*.—

Caliber.....	6.5 mm (.256 inch).
Principle of operation.....	Gas-operated, full-automatic only.
Ammunition	Model 38 (1905) semirimmed reduced-charge.
Type of feed.....	30-round box magazine.

⁵ See p. 7, note 1.

Sights:

Front -----	Inverted V blade with guards, offset to left.
Rear -----	Drum-controlled peep sight, with windage adjustment, graduated from 200 to 1,500 meters (218.7 to 1,640 yards) in jumps of 100 meters (109.4 yards), offset to left.

Telescopic:

Weight -----	1.4 pounds.
Magnifying power -----	2.5 times.
Field of view -----	10 degrees.
Windage -----	10 mils (0.562 degree) right and left.
Length of barrel -----	21.65 inches.
Over-all length -----	42 inches.
Weight of barrel -----	5.24 pounds.
Weight with sling -----	20 pounds.
Range:	
Effective -----	1,640 yards.
Maximum -----	4,374 yards.
Muzzle velocity -----	2,410 feet per second.
Rate of fire (cyclic) -----	550 rounds per minute.

d. How to Operate

(1) *Safety*.—The safety (fig. 62) is located on the left side of the trigger housing in front of and above the trigger. In the horizontal position it is set to “fire”; in the vertical position, to “safe.” At “safe” the trigger mechanism is locked by the surface of the pin preventing movement of the trigger. At “fire” the cutaway portion of the pin allows the sear to move.

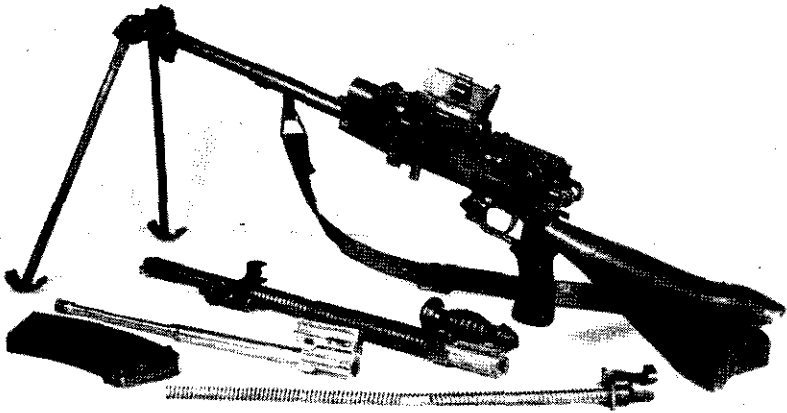

Figure 61.—Model 96 (1936) 6.5-mm light machine gun partially disassembled.

(2) *To load and fire.*—Open the magazine-opening cover on the top of the receiver. Insert a loaded 30-round magazine into the opening, catching the front

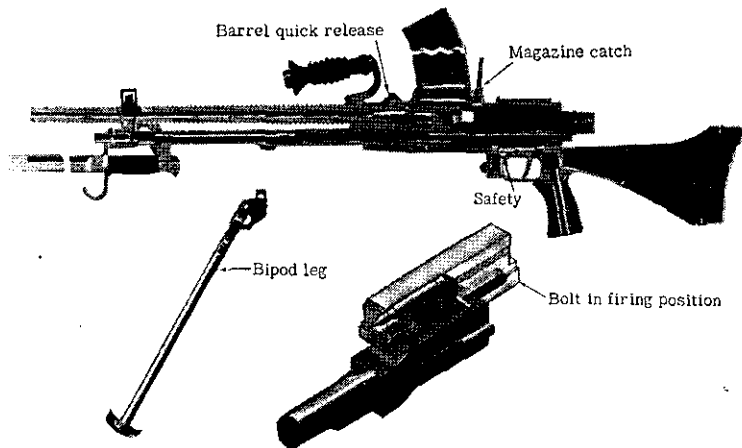

Figure 62.—Diagrammatic cross section of Model 96 (1936) 6.5-mm light machine gun, showing also various parts.

side of the magazine first and pulling it back until the catch on the back of the magazine opening engages the magazine. Pull the operating handle to the rear until the sear engages the operating slide. Return the operating handle to its forward position and set the

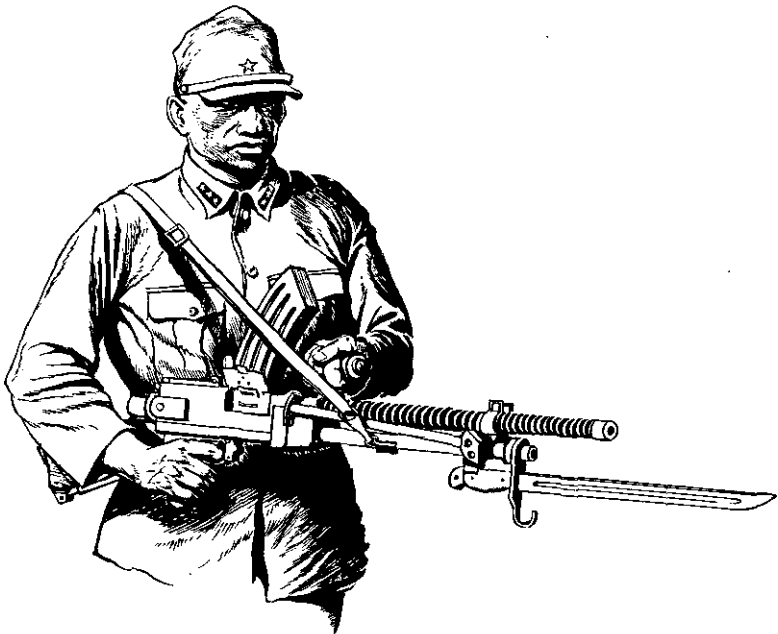

Figure 63.—Firing Model 96 (1936) 6.5-mm light machine gun from standing position.

range on the sight drum. The gun is now ready to be fired (fig. 63).

(3) *To unload.*—(a) Press the magazine catch forward with the base of the palm of the hand, at the same time grasping the magazine and tilting it forward until it is clear of the magazine catch; then lift

off the magazine. Now examine the chamber to be sure that it is empty.

(b) If the safety is at the "on" position, move it to the "off" position.

(c) Press the trigger, cock the gun, and press the trigger again.

(d) Close the magazine and the ejection-opening covers and muzzle cover if attached.

(4) *Adjustments*.—The gas piston plug has five positions. They are numbered one to five, respectively. As the gas piston plug is turned from one toward five, the size of the gas port increases. If the gun is recoiling too hard, a smaller number should be used. If the recoil is too light or is insufficient for operation, a larger number should be used.

(5) *Stoppages*.—The following chart is designed to assist in locating and remedying various causes of trouble which may arise during the use of this weapon:

Stoppage	Cause	Remedy
MAGAZINE		
Fails to feed.....	Bent magazine lip..... Worn-out lug in magazine..... Weak or damaged follower spring.	Replace the magazine. Replace the magazine. Replace the follower spring.
Fails to feed; double loading ..	Bent magazine.....	Replace the magazine.
BARREL		
Chamber scores cartridge case; damages parts.	Corrosion or rust in chamber....	Clean the chamber or replace the barrel.
Damaged bolt breaks extractor spring.	Damaged breech face or bolt lock in receiver. Heavy impact scars on bolt and extractor.	Replace the barrel and bolt lock. Replace the barrel and bolt lock.
Barrel is loose.....	Burred barrel-locking lever slot. Worn-out barrel-locking lever....	File off the burrs in barrel-locking lever slot. Replace the lever.
Seating barrel into receiver is difficult.	Rusted threads on barrel or receiver.	Replace the barrel or clean the locking lever and slot.

Stoppage	Cause	Remedy
GAS PORT, CYLINDER, AND PISTON		
Gas pressure is low.....	Enlarged, worn-out, or fouled gas port. Worn-out or rusted gas-cylinder piston.	Clean the gas port. If in action, replace the barrel. Replace the piston.
Gas-cylinder lock rotates freely.	Worn-out or broken gas-cylinder lock spring.	Replace the spring. If in action, replace the barrel.
Gas-cylinder piston scrapes.....	Bent piston.....	Replace the piston.
RECEIVER		
Ejection is faulty.....	Loose ejector pivot bearing.....	Replace the bolt.
BUFFER AND DRIVING GROUP ASSEMBLY		
Driving spring is twisted.....	Worn-out or bent driving-spring guide.	Straighten or replace the driving-spring guide.
BOLT		
Firing pin strikes light blow on primer.	Firing pin bent or firing-pin slot clogged with carbon.	Replace the firing pin or clean and oil the firing-pin slot.
Fails to fire.....	Cracked bolt.....	Replace the bolt.
Breech will not lock; pre-battery explosion will result.	Bent bolt-locking cam seat.....	Replace the bolt-locking cam seat.
Primers are punctured.....	Enlarged or fouled firing-pin hole.	Replace the bolt.
EXTRACTOR		
Fails to extract.....	Worn-out or broken extractor spring. Worn-out or broken spring retainer. Worn-out or rusted extractor..... Rusted or damaged bolt.....	Replace the extractor spring. Replace the spring retainer. Replace the extractor. Replace the bolt lock.
BOLT LOCK		
Action does not lock.....	Rusted, cracked, or bent bolt lock.	Replace the bolt lock.
MAGAZINE CATCH		
Magazine is not secure.....	Worn-out or damaged magazine catch or spring.	Replace the magazine-catch lever or spring.
SEAR		
Bolt will not stay back.....	Broken or worn sear.....	Replace the sear.
OPERATING HANDLE		
Bolt will not go forward (loose operating handle).	Worn-out operating handle cam.	Replace the cam.
EJECTOR		
Fails to eject.....	Rusted or bent ejector.....	Replace the ejector. If in action, replace the bolt.
BOLT LOCK		
Bolt-lock catch does not function.	Rusted or bent bolt lock.....	Replace the bolt lock.
Assembly of bolt lock to receiver is difficult.	Worn-out or bent bolt-lock spring.	Replace the bolt-lock retaining spring.

e. Ammunition

The Model 96 (1936) 6.5-mm light machine gun will not handle the Japanese 6.5-mm service ammunition without malfunction. Ammunition in containers marked with a Gamma circle, **Ⓒ**, is a special reduced charge for both the Model 11 (1922) and the Model 96 (1936) 6.5-mm light machine guns. (See par. 42, p. 235, and fig. 154, p. 236.)

f. Maintenance

(1) *Oiling and cleaning.*—The Model 96 (1936) 6.5-mm light machine gun is sensitive to dirt, dust, and sand. To function well, it must be kept cleaned and oiled at all times. The magazine- and ejection-opening covers should be kept closed whenever the gun is not being fired. The same type of care and cleaning as is given to similar gas-operated U. S. weapons will suffice.

(2) *Stripping*—(a) *Barrel.*—With the bolt forward, pull out on the barrel-lock knob, which is located on the front left side of the receiver, and turn it about one-third turn upwards. The barrel will now slide forward, disengaging from the receiver. If it sticks, tap lightly on the rear face of the barrel-carrying handle.

(b) *Backplate.*—Rotate about one-eighth of a turn upward the backplate pin knob, located on the rear left side of the receiver. Holding in on the backplate, against the recoil spring action, pull the backplate pin to the left as far as it will go. The backplate group and recoil spring may then be removed.

(c) *Gas piston and bolt.*—Pull the operating handle to the rear and remove the gas-piston assembly bolt. Slide them off from the rear of the receiver.

(d) *Bolt lock.*—Pull down on the bolt-lock cover on the bottom of the receiver in front of the trigger. The bolt lock will then slide out the bottom of the receiver, or it can be pushed out.

(e) *Trigger-guard group.*—Drift out the trigger-guard housing key, located on the bottom rear of the receiver. By pulling the trigger, the stock and trigger housing can be drawn from the rear of the receiver.

(f) *Bipod.*—After the barrel has been removed, the bipod (fig. 64) can be rotated either to the left or right and then be removed from the gas cylinder tube.

(3) *Assembly.*—To assemble the weapon, proceed in the reverse order to that followed in stripping. Make sure that all burrs are removed, that parts are clean and well oiled, that the firing pin is assembled in front of the piston hammer stud, and that the operating or recoil spring is not buckled and is free on its guide.

g. Accessories

The following items are accessories to this weapon:

- (1) Telescope sight and case.
- (2) Muzzle cover and flash hider. (Only one can be used at a time.)
- (3) Leather hand guard used in holding the barrel when firing from the hip.
- (4) Magazine loader. (It accommodates the Model 38 (1905) semirimmed, reduced-charge ammunition in the standard 5-round clips.)



Figure 64.—Model 96 (1936) 6.5-mm light machine guns with bipods attached.

- (5) Spare barrel.
- (6) Spare-parts kit in a metal box. (The contents include a spare bolt assembly, operating and other springs, a bolt lock, a combination tool, and other parts.)
- (7) Bayonet.
- (8) Carrying sling.
- (9) Canvas-and-leather gun cover.

23. MODEL 99 (1939) 7.7-MM LIGHT MACHINE GUN⁶

a. General

The Model 99 (1939) 7.7-mm light machine gun (fig. 65), one of the newest types to appear in action, is an evidence of the Japanese change from 6.5-mm (.256-inch) to 7.7-mm (.303-inch) weapons.

The Model 99 (1939) 7.7-mm light machine gun and the Model 99 (1939) 7.7-mm rifle use the Model 99 (1939) 7.7-mm rimless ammunition. Basically this new Model 99 (1939) 7.7-mm light machine gun is the same as the Model 96 (1936) 6.5-mm light machine gun (par. 22, p. 96). There are, however, two important differences: (1) a new method of changing the barrel (see fig. 66), a device which includes headspace adjustment, and (2) an adjustable rear monopod. Like the Model 96 (1936) 6.5-mm light machine gun, this weapon is fitted to take the Japanese service bayonet (fig. 20, p. 33).

⁶ This weapon, commonly called *Kyukyu Shiki Keiki*, is listed by the Japanese as 九九式軽機関銃, which is read (from left to right) *Kyukyu Shiki Keikikanju*, meaning "99 model light machine gun." (See p. 7, note 1.) The Japanese tactical symbol and abbreviation for a light machine gun are ♂LG. (See p. 88, note 1.)

b. How to Identify

Though differing in caliber, the Model 99 (1939) 7.7-mm light machine gun is quite similar (see fig. 67) to the Model 96 (1936) 6.5-mm light machine gun (par. 22, p. 96) except for—

(1) The adjustable rear monopod.

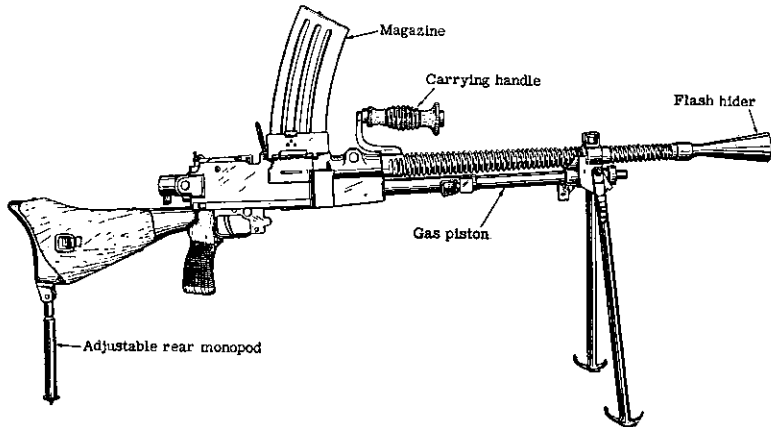

Figure 65.—Model 99 (1939) 7.7-mm light machine gun, showing adjustable rear monopod.

(2) The nut and wedge type of barrel release. (This is used instead of the pivoting barrel-locking knob of the Model 96 light machine gun.)

(3) The safety on the right side of the receiver. (The safety is on the left side of the Model 96 light machine gun.)

(4) The method used to attach the flash hider. (The Model 96 light machine gun has a bayonet-type locking device, whereas the flash hider is screwed on the Model 99.)

(5) The marking 九九式 which is on the receiver. (This marking, which is read *Kyukyū Shiki* from left to right,⁷ means "99 model.")

c. Characteristics

(1) *General.*—The Model 99 (1939) 7.7-mm light machine gun is gas-operated, air-cooled, and maga-

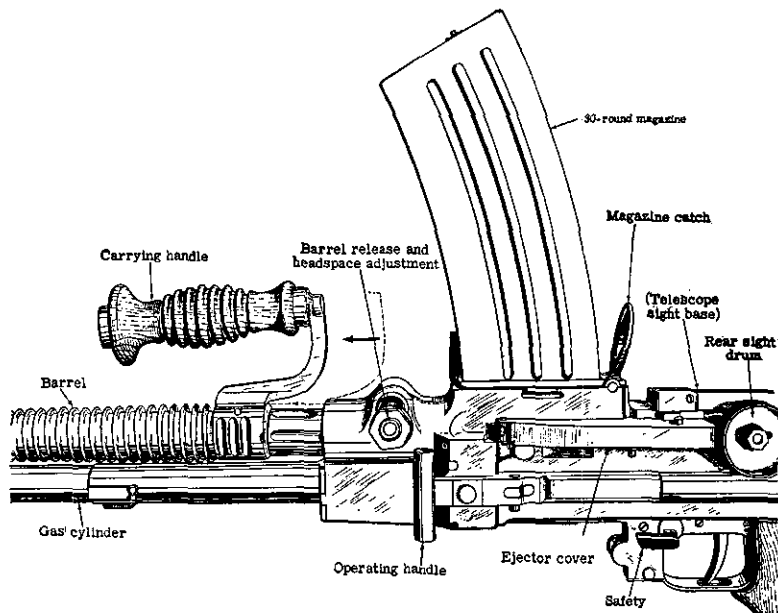

Figure 66.—Close-up of Model 99 (1939) 7.7-mm light machine gun, showing method of withdrawing barrel.

zine-fed. It is fired from a bipod and rear monopod, which is adjustable for elevation. The weapon is fed by a 30-round, curved-box magazine, which is placed on top of the receiver. The mechanism of this

⁷ See p. 7, note 1.

model is virtually the same as that of the Model 96 (1936) 6.5-mm light machine gun. Many parts are common to both guns.

(2) *Table of characteristics.*—

Caliber	7.7 mm (.303 inch).
Principle of operation	Gas-operated, full-automatic only.
Ammunition	Model 99 (1939) 7.7-mm rimless cartridges only. (The use of ball cartridges is known, but no reports of armor-piercing or tracer cartridges have been received.)
Type of feed	30-round box magazine.
Sights:	
Front	Inverted V blade with guards, offset to left.
Rear	Drum-controlled peep sight, with windage adjustment, graduated from 200 to 1,500 meters (218.7 to 1,640 yards) in jumps of 100 meters (109.4 yards), offset to left.
Windage	10 mils (0.562 degree) right and left.
Length of barrel	21.65 inches.
Over-all length	42 inches.
Weight:	
Without magazine	20 pounds.
Magazine (empty)	1.36 pounds.
Magazine (loaded)	3.03 pounds.
Range:	
Effective	1,500 yards.
Maximum	3,800 yards.
Muzzle velocity	2,300 feet per second.
Rate of fire:	
Effective	250 rounds per minute.
Cyclic	800 rounds per minute.

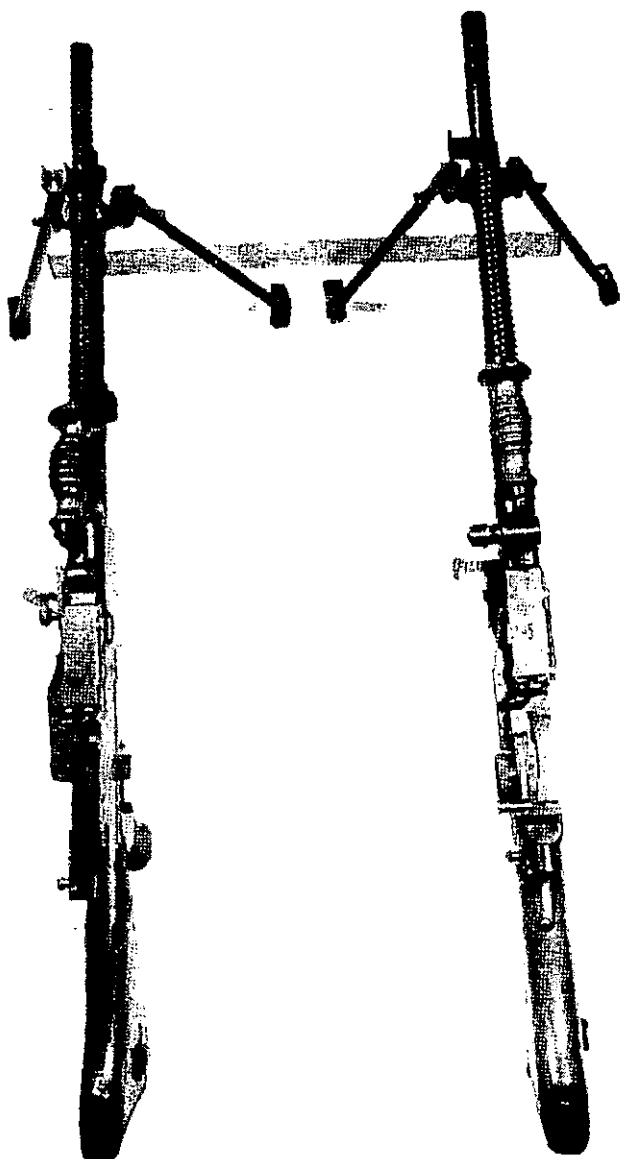

Figure 67.—Model 96 (1936) 6.5-mm light machine gun (left) and model 99 (1939) 7.7-mm light machine gun (right).

d. How to Operate

(1) *Safety*.—A safety lever is located on the right side of the receiver. To put the lever in the “safe” position, rotate it upward until it is in the vertical position. To put the lever in the “fire” position, rotate it downward until it is in the horizontal position. In the “safe” position the sear is prevented from moving. In the “fire” position the cutaway section of the pin attached to the safety lever allows the sear to move.

(2) *To load and fire*.—(a) *General*.—If present, remove the muzzle, or mud, cover. Move the safety lever to the “fire” position. Open the magazine and ejection port covers. Insert a loaded magazine with its inside curve facing forward and engage the front end first in the front end of the magazine opening. Press it down until the magazine catch engages its rear flange. Pull the operating handle to the rear as far as it will go, and then push it forward again, as this will prevent injury to the firer’s hand. Set the sights by turning the elevating drum until the desired range shows in the cut at the rear of the drum. As long as the trigger is pulled, the gun will fire; there is no provision for semiautomatic fire.

(b) *Regulating rate of fire*.—The gas regulator, which regulates the rate of fire, has five positions, numbered one to five, respectively. As the gas regulator is turned from one toward five, the size of the port increases. If the gun is recoiling too hard (that is, pounding), a smaller-numbered port should be used. If the recoiling parts do not come far enough to the rear to operate, a larger hole should be used. Compressing a spring lock allows the gas regulator to be moved for the necessary adjustments.

(3) *Sights*.—(a) *Metallis sights*.—The front and rear sights, of necessity, are offset to the left because of the position of the vertical box magazine placed on top of the receiver. The standard metallic rear sight is set for elevation by turning the elevation drum until the desired range (in meters) is shown in the window on the rear of the rear-sight housing. Adjustment for windage is made by turning the knob located to the left of the peep on the rear sight.

(b) *Telescopic sight*.—The dove-tail base situated on the right of the rear top plate of the receiver takes a 2½-power telescopic sight. A spring-loaded catch locks the sight in place.

(4) *To unload*.—Press forward on the magazine catch and remove the magazine. Press the trigger. Cock the gun. Press the trigger again. Set the safety lever to “safe.” Set the sights to zero. Do not attempt to unload the gun by working live rounds through the action, because the gun fires from an open bolt and will fire when the bolt closes and locks. Close the magazine and ejection port covers, and put the muzzle cover in place.

(5) *Stoppages*.—The stoppages chart for the Model 96 (1936) 6.5-mm light machine gun (see par. **22d** (5), p. 101) applies also to the Model 99 (1939) 7.7-mm light machine gun, as the actions of these guns are identical.

e. Ammunition

This machine gun uses the Model 99 (1939) 7.7-mm (.303-inch) rimless ammunition, which—unlike the Model 92 (1932) 7.7-mm ammunition used in the Model 92 (1932) 7.7-mm heavy machine gun—is true rimless

ammunition, not semirimmed. The Model 99 (1939) 7.7-mm rimless ammunition will function in the Model 92 (1932) 7.7-mm heavy machine gun if it is loaded in the 30-round feed strips for the heavy machine gun, and it has been found loaded in this manner.

The semirimmed ammunition usually found in 30-round feed strips is designed for the Model 92 (1932) 7.7-mm heavy machine gun and will not function in the Model 99 (1939) 7.7-mm light machine gun. (See also par. **43b** (3), p. 237.)

Before loading the magazine, check to see that the oil reservoir on the loader is filled. Attach the empty magazine to the loader. Pull back the loading handle until the 5-round clip can be inserted. Press the rounds into the magazine by pushing down on the loading handle. Remove the empty clip, and repeat until the 30 rounds are loaded into the magazine.

f. Maintenance

(1) *Oiling and cleaning.*—The Model 99 (1939) 7.7-mm light machine gun is less sensitive to dirt, dust, and sand than the Model 11 (1922) 6.5-mm light machine gun. Nevertheless the weapon still requires the care given to similar U. S. weapons. The gas piston and cylinder should be scraped clean just as in the similar assemblies on the Browning automatic rifle (BAR), M1918.

(2) *Stripping.*—(a) *Barrel.*—Unscrew the headspace adjusting bolt, and pull it out as far as it will come. Then withdraw the barrel to the front. If the barrel should stick, tap lightly on the rear face of the barrel-carrying handle while at the same time holding

onto the carrying handle in order to prevent the barrel from falling to the ground.

(b) *Backplate*.—Rotate the backplate pin knob, located on the left rear side of the receiver, about one-eighth of a turn upward. Maintaining pressure on the backplate to prevent the recoil spring from flying out, pull the backplate pin to the left as far as it will go. Ease up on the backplate; both the backplate and the recoil spring can be withdrawn to the rear.

(c) *Gas piston and bolt*.—Pull back the operating handle smartly. The bolt can now be grasped through the open rear end of the receiver and withdrawn. Bring with it the gas-piston assembly, to which it is connected by the hammer stud on the gas piston. Lift the bolt vertically away from the gas piston, and they will readily come apart.

(d) *Bolt lock*.—Pull down the bolt-lock cover located on the bottom plate of the receiver in front of the trigger guard. Inserting a finger through the magazine opening in the top of the receiver, push the bolt lock down until it falls into the hand held underneath to catch it.

(e) *Trigger-guard group*.—Drive out the trigger-housing split pin, located on the bottom rear of the receiver. Pull the trigger and withdraw the trigger-guard group and shoulder-stock group to the rear.

(f) *Bipod*.—With the barrel group removed, the bipod can be removed from the gas cylinder merely by rotating it in either direction until it is free.

(3) *Assembly*.—To assemble the weapon, proceed in the reverse order to that followed in stripping. Make sure that all parts are free from burrs and well oiled.

Check to be certain that the bolt is assembled to the gas-piston assembly so that the gas-piston hammer stud is behind the firing pin in the bolt. Also, make sure that the operating, or recoil, spring is not buckled in assembly and is free on its guide.

g. Accessories

The following items are accessories to this weapon:

- (1) Telescopic sight and case.
- (2) Muzzle cover and flash hider. (Only one can be used at a time.)
- (3) Leather hand guard used in holding the barrel when firing from the hip.
- (4) Magazine loader. (It accommodates the Model 99 (1939) 7.7-mm rimless light machine-gun and rifle ammunition in the standard 5-round clips.)
- (5) Spare barrel.
- (6) Spare-parts kit in a metal box. (The contents include a spare bolt assembly, operating and other springs, a bolt lock, a combination tool, and other parts.)
- (7) Bayonet.
- (8) Carrying sling.
- (9) Canvas-and-leather gun cover.

24. MODEL 92 (1932) 7.7-MM HEAVY MACHINE GUN⁸

a. General

The Model 92 (1932) 7.7-mm heavy machine gun (fig. 68) is the standard Japanese heavy machine

⁸This weapon, commonly called *Juki*, is listed by the Japanese as 九二式重機関銃, which is read (from left to right) *Kyuni Shiki Jukikanju*, meaning "92 model heavy machine gun." (See p. 7, note 1.)

The Japanese tactical symbol for a (heavy) machine gun is ↑.

gun. It is normally mounted on a tripod for use against ground targets. When mounted on its standard tripod with an adapter, it can be used as an antiaircraft machine gun.

b. How to Identify

The Model 92 (1932) 7.7-mm heavy machine gun may be identified by—

- (1) The large radiating rings (air-cooling flanges).
- (2) The adjustable traversing handles (figs. 69 and 70).

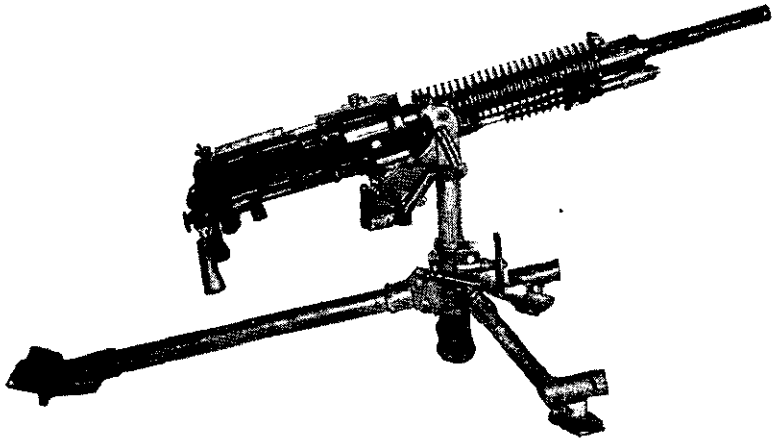

Figure 68.—Model 92 (1932) 7.7-mm heavy machine gun (right side).

- (3) The cocking handle on the right side.
- (4) The trigger thumbpiece (figs. 69 and 70).
- (5) The oiler (fig. 70), which is situated above and to the left of the receiver directly above the feedway.
- (6) The marking $\begin{matrix} 九 \\ 二 \\ 式 \end{matrix}$ which is on top of the receiver.

(This marking, which is read *Kyuni Shiki* from top to bottom,⁹ means "92 model.")

c. Characteristics

(1) *General*.—The Model 92 (1932) 7.7-mm heavy machine gun is a modified Hotchkiss-type weapon. Because of its slow cyclic rate, the gun seldom overheats, and the life of a barrel is unusually long. A base on the receiver accommodates a telescopic sight.

(2) *Table of characteristics*.—

Caliber.....	7.7 mm (.303 inch).
Principle of operation.....	Gas-operated, full-automatic only.
Ammunition.....	Ball, tracer, and armor-piercing. (Both semirimmed and rimless ammunition can be fired.)
Type of feed.....	Strips (30 rounds each).
Sights:	
Front.....	Either V blade with guards, offset to right, or an antiaircraft sight of the cartwheel type.
Rear.....	Either post type, with windage adjustment, graduated from 300 to 2,700 meters (328.1 to 2,953 yards), offset to right, or special antiaircraft sight mounted on ground-sight base.
Telescopic.....	Model 96 (4-power), Model 93 (6-power), and Model 94 (5-power).
Length of barrel.....	29.5 inches.
Over-all length.....	45.5 inches.
Weight:	
Without tripod.....	61 pounds.
With tripod.....	122 pounds.

⁹ See p. 7, note 1.

Traverse (with tripod mount) — 360 degrees (33.5 degrees on an arc).

Elevation (with tripod mount) :

Maximum ----- 11 degrees.

Minimum ----- -15 degrees.

Range :

Effective ----- 1,500 yards.

Maximum ----- 4,587 yards.

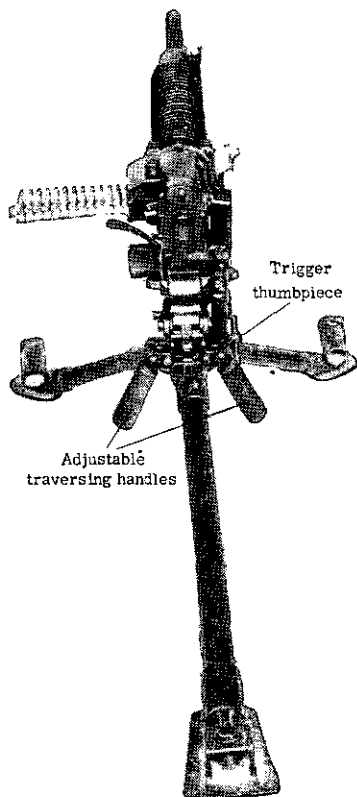

Figure 69.—Model 92 (1932) 7.7-mm heavy machine gun (rear view).

Muzzle velocity (with Model

92 (1932) ball ammunition) .. 2,400 feet per second.

Rate of fire:

Effective ----- 200 rounds per minute.

Cyclic ----- 450 rounds per minute.

d. How to Operate

(1) *Safety*.—Turn the trigger thumbpiece clockwise for “safe.” When the feed strip is removed, the bolt is locked in the rear position. When a strip is inserted and the bolt is unlocked, the gun can be fired by pressing on the trigger thumbpiece (figs. 69, 70, and 75).

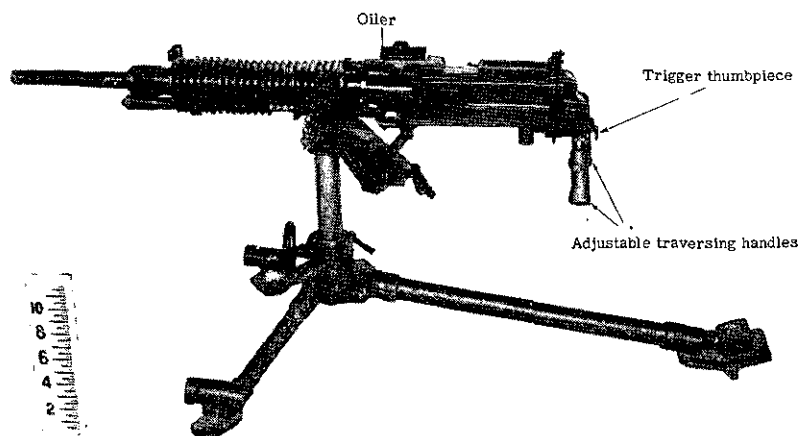

Figure 70.—Model 92 (1932) 7.7-mm heavy machine gun (left side).

(2) *To load and fire*.—Put the traversing handles into the lower, or firing, position. Pull back the cocking handle and push it forward. The feed and ejection opening will automatically open when the cocking handle is moved. Insert a strip of ammunition from the left side of the feed mechanism with the rounds uppermost. The gun is now ready to be fired.

The gun will continue to fire as long as the trigger thumbpiece is pressed forward or until the ammunition is expended, at which time the holding pawl rises up and holds the bolt open until the weapon is reloaded.

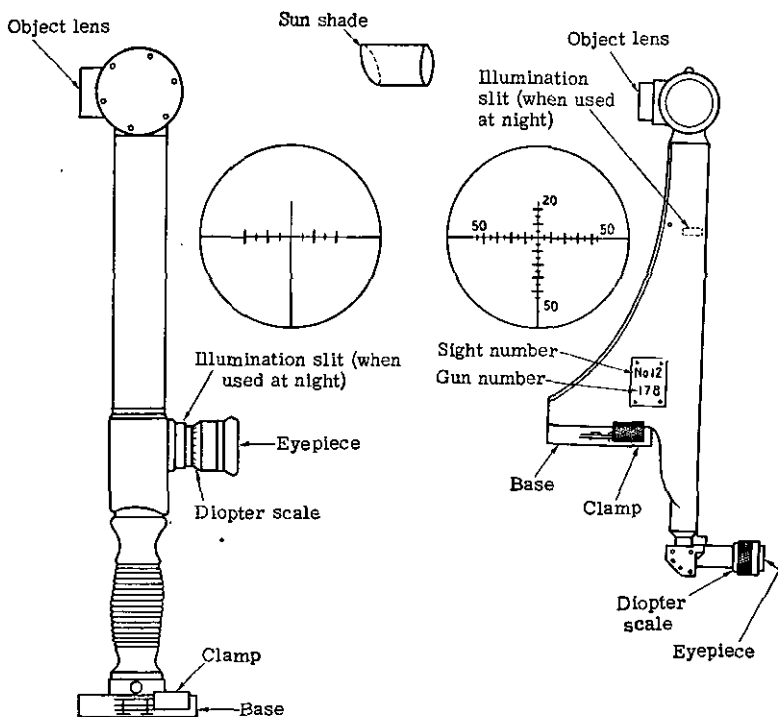

Figure 71.—Model 93 (1933) telescopic sight (left) and Model 94 (1934) telescopic sight (right).

To adjust the gas cylinder, screw the gas cylinder plug in or out, enlarging or decreasing the length of the gas cylinder until the gun functions properly.

(3) *To unload.*—Pull out the feed holding-pawl arm hook underneath the feedway on the left side of the

receiver. Remove the feed strip. Check the chamber to be sure that it is empty.

(4) *Sight*.—Three telescopic sights are available for the Model 92 (1932) 7.7-mm heavy machine gun. All are mounted in grooves provided on top of the receiver.

Both the Model 93 (1933) and the Model 94 (1934) telescopic sights (fig. 71) are periscopic types. The Model 93 is 6-power and the Model 94 is 5-power. The Model 93 measures 8.4 inches from top to bottom. The eyepiece is considerably above the receiver: this sight is used only for laying the gun and is detached before firing. The Model 94 measures 12.8 inches from top to bottom. The eyepiece is on a level with the top of the receiver and the sight is supported much more firmly. The sight base (figs. 72 and 73) is separate from the periscopic sight and contains the adjusting wheels.

The Model 96 (1936) telescopic sight (fig. 74) is mounted directly on the top of the receiver (fig. 75). It is 4-power, and may be used while the gun is firing.

The elevation scale is marked from 1 to 50 mils (0.0562 to 0.281 degrees) plus and minus. It is situated above and to the right of the eyepiece.

e. Ammunition

This gun uses Model 92 (1932) 7.7-mm semirimmed ammunition; it comes as ball, tracer, and armor-piercing. An incendiary round can also be used. Model 99 (1939) rimless 7.7-mm ammunition can be fired in this gun when it is loaded in 30-round feed strips. (See also par. 43b (3), p. 237.)

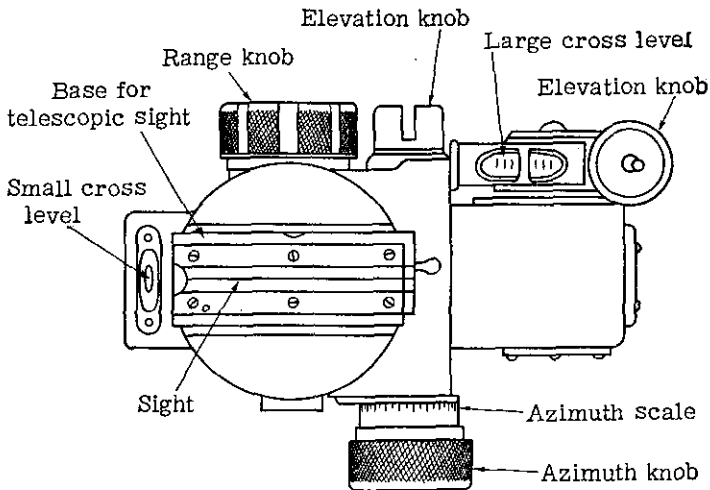

Figure 72.—Base for telescopic sight (top view).

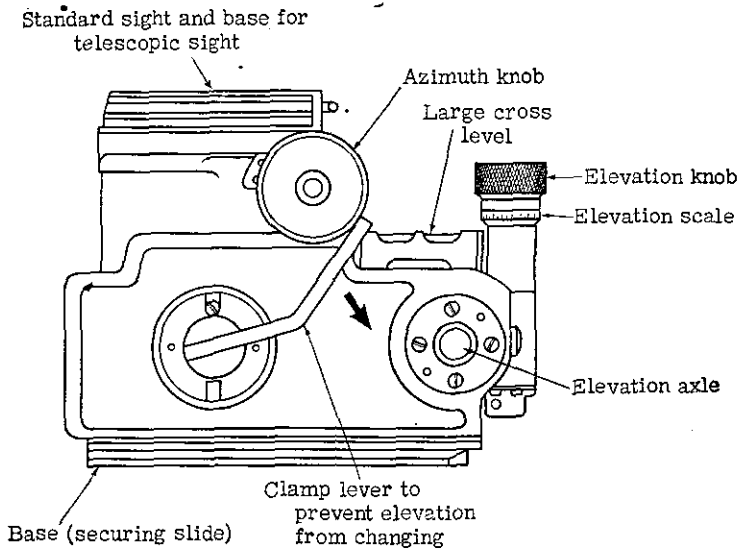

Figure 73.—Base for telescopic sight (right side).

A large box suspended by poles carries a supply of loaded feed strips in cardboard containers. The loaded ammunition box weighs 48.5 pounds.

The ammunition is marked in two lines of characters, which are read from left to right.¹⁰ For example, the

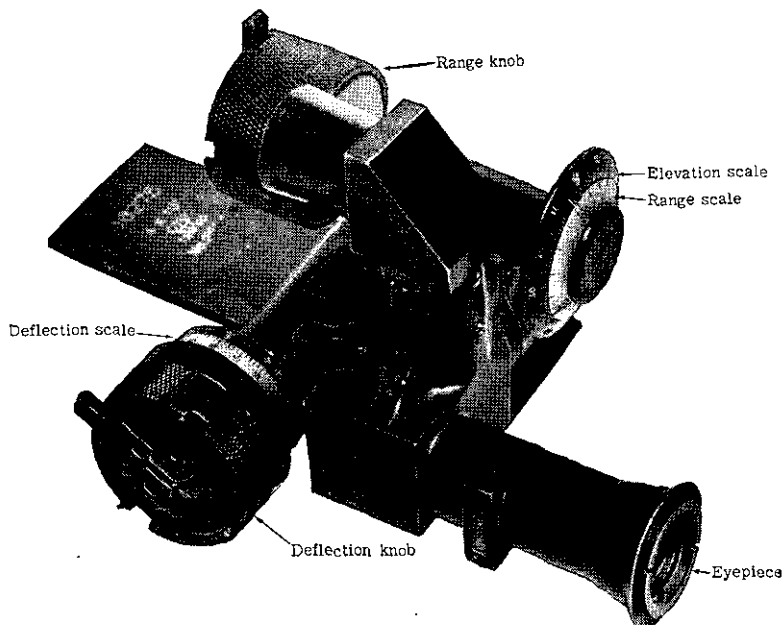

Figure 74.—Model 96 (1936) telescopic sight.

label for ball ammunition is arranged as follows: the first line, 九二式重機關銃彈藥, is read *Kyuni Shiki Jukikanju Danyaku*, meaning “92 model heavy machine-gun ammunition”; the second, 九二式普通實包, is read *Kyuni Shiki Futsu Jippo*, meaning “92 model ordinary ball ammunition.” These lines are followed by characters indicating the number of rounds. (See fig. 155, p. 237.)

¹⁰ See p. 7, note 1.

f. Maintenance

(1) *Oiling and cleaning.*—The same type of care and cleaning as is given to U. S. gas-operated weapons will suffice to keep this weapon in good working order.

(2) *Stripping* (fig. 76).—(a) *Backplate.*—Remove the backplate pin by turning it down to a vertical position and then pulling it out, holding it in place against the pressure of the operating, or recoil, spring. Then remove the backplate group and operating spring.

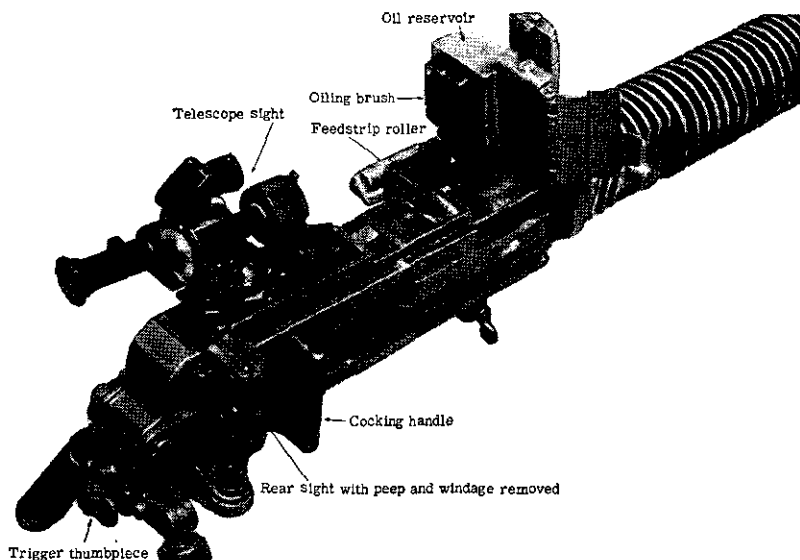

Figure 75.—Model 92 (1932) 7.7-mm heavy machine gun equipped with Model 96 (1936) telescopic sight. (The feedway is opened to show the oiling brush.)

(b) *Bolt.*—Pull the bolt slide to the rear, and remove the operating slide, bolt lock, and bolt. Align the lugs on the bolt slide with the openings on the side of the receiver and remove the bolt slide.

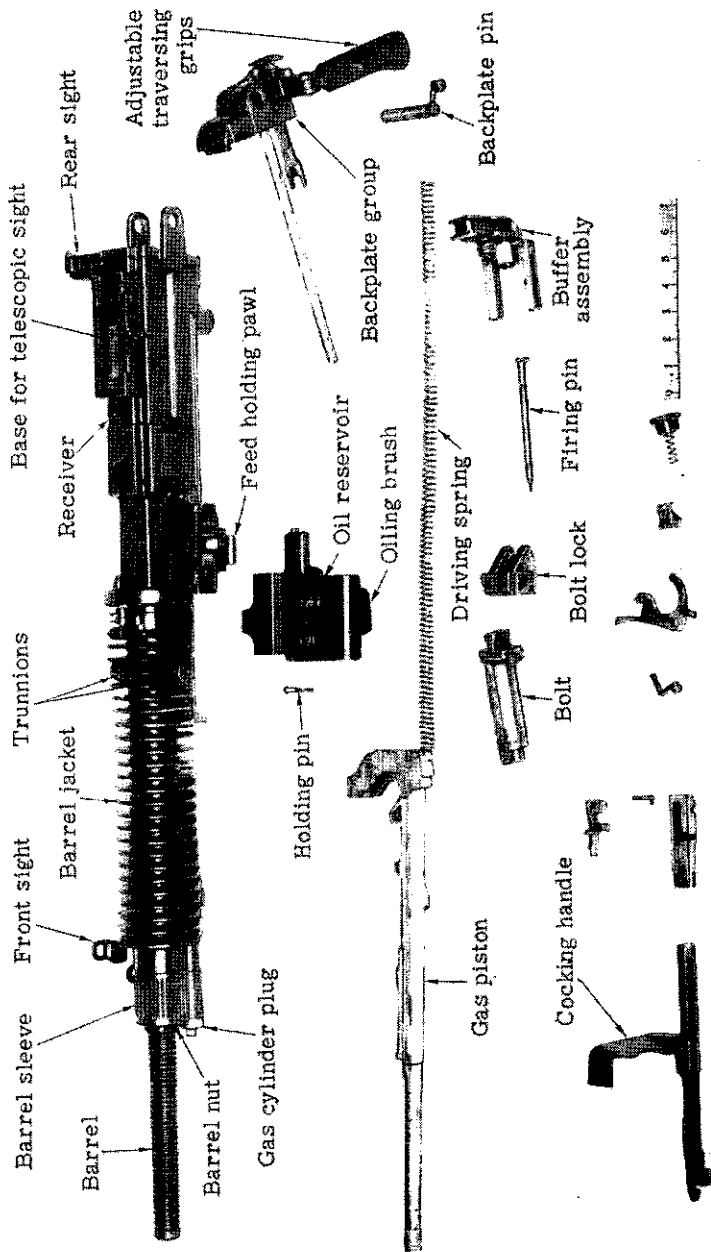

Figure 76.—Model 92 (1932) 7.7-mm heavy machine gun disassembled.

(c) *Oiler*.—Push forward on the oil-reservoir lock, raising up on the rear of the oil reservoir. Remove the oil-reservoir retaining screw, and lift off the oil reservoir.

(d) *Barrel*.—Remove the gas-jet cover from the bottom of the gas cylinder, and unscrew the gas jet



Figure 77.—Model 92 (1932) 7.7-mm heavy machine gun, showing tool and spare-parts box.

from the barrel. Remove the barrel nut. Turn the barrel one-half turn to the right and pull it out. Then pull out the barrel sleeve. A special wrench to remove the barrel will be found in the tool and spare-parts kit.

(e) *Feed mechanism*.—Locate the holding pin, which is at the front and bottom of the feed box. Rotate this pin one-half turn in a downward direction; then pull it out. Remove the holding pawl and holding-

pawl spring. Align the marks on the feed slide with the marks on the feed box, and drift the feed-slide pin out to the front of the feed box. Slide the feed slide to the left, removing the feed pawl and feed-pawl spring at the same time.

(3) *Assembly*.—To assemble the weapon, proceed in the reverse order to that followed in stripping.

g. Accessories

The following accessories are furnished with the weapon (see fig. 77):

- (1) Antiaircraft adapter.
- (2) Antiaircraft ring and blade sights and container.
- (3) One or more telescopic sights and cases.
- (4) Tool and spare-parts kit.
- (5) Handles for carrying the weapon.
- (6) Gun cover.

25. MODEL 93 (1933) 13-MM TWIN HEAVY MACHINE GUN¹¹

a. General

The Model 93 (1933) 13-mm twin heavy machine gun (fig. 78 and 79) is an automatic twin-mounted anti-tank-antiaircraft gun. It is gas-operated, air-cooled, full-automatic only, and magazine-fed. Its actual caliber is 13.2 mm. A single-barreled version of this weapon, likewise known as the Model 93 (1933) 13-mm machine gun, also exists. The mount for the single-barreled version differs from the three known mounts for the double-barreled version.

¹¹ This weapon is listed by the Japanese as 九三式車載十三銃機関銃 which is read (from left to right) *Kyusan Shiki Shasui Jusan Miri Kikanju*, meaning "93 model wheeled 13-mm machine gun." (See p. 7, note 1.)

The Japanese tactical symbol for a (heavy) machine gun is .

b. How to Identify

The Model 93 (1933) 13-mm twin heavy machine gun may be identified by—

- (1) The two barrels.
- (2) The tripod mount.
- (3) The iron gunner's chair.

c. Characteristics

(1) *General*.—The two guns on the Model 93 (1933) 13-mm twin heavy machine gun are mounted separately and can be individually stripped from the mount. There is an iron chair for the gunner, who operates each of the guns with separate pedals.¹²

(2) *Table of characteristics*.—

Caliber.....	13.2 mm (.519 inch).
Principle of operation.....	Gas-operated, full-automatic only.
Ammunition.....	Ball, tracer, and armor-piercing.
Length of barrel:	
With flash hider.....	65 inches.
Without flash hider.....	56½ inches.
Total weight of each gun.....	87 pounds.
Muzzle velocity:	
Ball ammunition.....	2,210 feet per second.
Armor-piercing ammunition.....	2,280 feet per second.

d. How to Operate

- (1) *Safety*.—No safety is provided on this weapon.
- (2) *Sight*.—The Model 93 (1933) 13-mm twin heavy machine gun has two sets of sights: ground and anti-aircraft.

¹² It is believed that the axle stubs may be used for a wheeled mount, which would greatly facilitate the movement of the weapon. However, no wheels have been recovered to date.

The ground sights consist of an inverted **V** blade front sight and a leaf rear sight sliding on a ramp.

The antiaircraft sight (fig. 80) appears to require three men for its operation:

- (a) Gunner. Sets the deflection and elevation;
- (b) No. 1. Estimates for setting target, course, and speed;
- (c) No. 2. Operates the height drum.

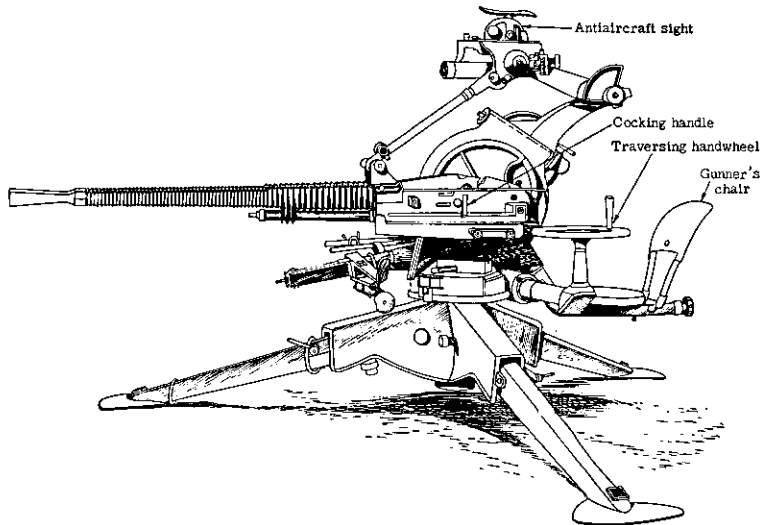

Figure 78.—Model 93 (1933) 12-mm twin heavy machine gun (left side).

The sight consists of a computing head, a positioner, and a height drum. As the weapon is moved about, the computing head always remains horizontal, but the pointer on the height drum moves lengthwise along the drum. The height drum is graduated by transverse lines that appear to represent intervals of 500 or 1,000

meters. No. 2 turns the drum manually to keep the pointer on the appropriate curve, and thus

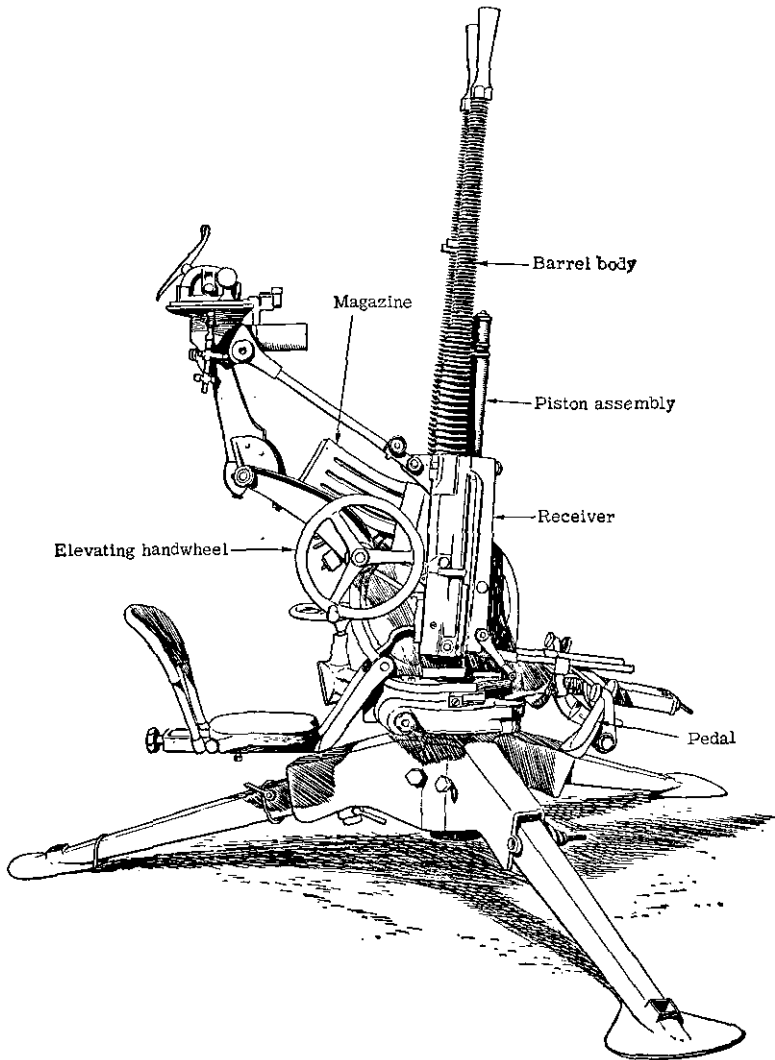

Figure 79.—Model 93 (1933) 13-mm twin heavy machine gun, showing maximum elevation.

changes the reading on the computing head for deflection by an amount proportional to the time of flight.

About the horizontal axis of the computing head is a positioner, crudely shaped like an airplane. When this positioner is put in an upright position pointing

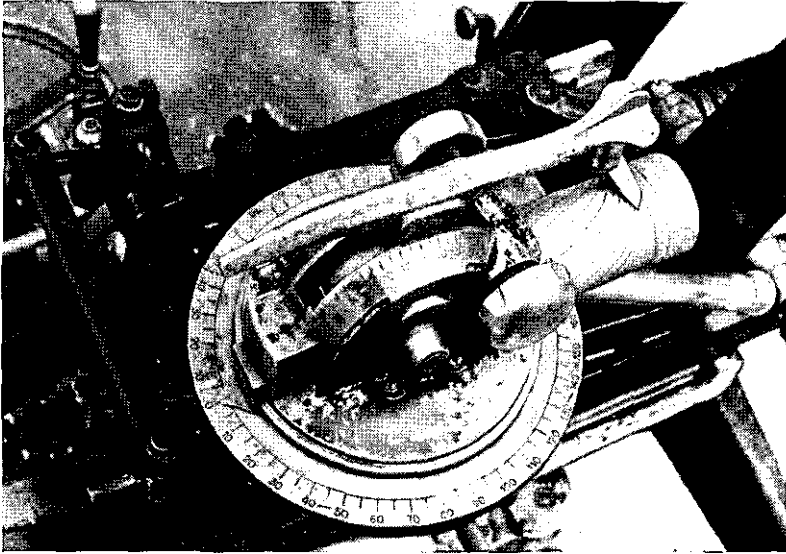

Figure 80.—Antiaircraft sight on Model 93 (1933) 13-mm twin heavy machine gun.

at the target, placed in a position so that it is parallel to the flight of the target, and kept parallel by its operator, the final deflection is referred to the guns.

The target speed is set into the head by a setting knob.

(3) *To elevate.*—The elevating handwheel is on the right of the weapon and will raise the guns from the horizontal to an angle of approximately 85 degrees.

(4) *To traverse.*—The traversing handwheel is on the extreme left of the weapon, and the traversing scale is enclosed in the base of the mount.

(5) *To load and fire.*—The guns are cocked individually by pulling back the cocking handles on the sides of the receivers (see fig. 81). The loaded magazines

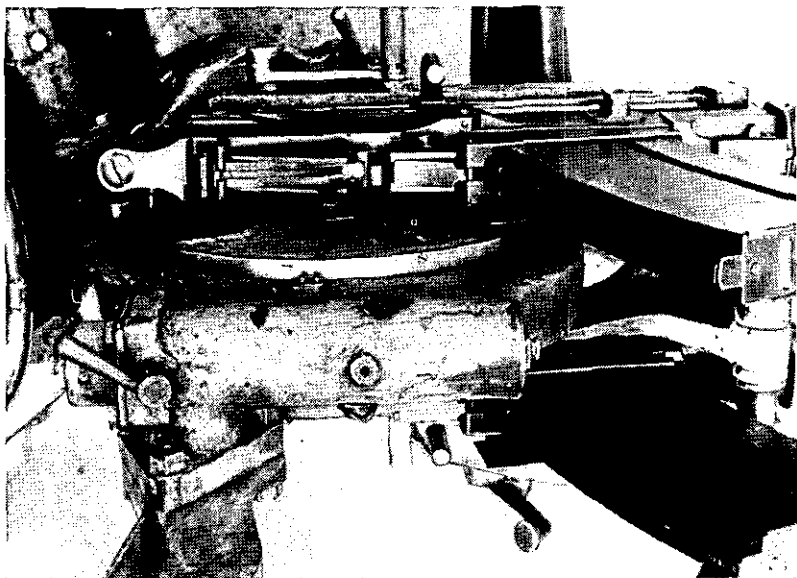

Figure 81.—Receiver of Model 93 (1933) 13-mm twin heavy machine gun as seen from above.

(20 rounds for each vertical box-type magazine) are put on, and the guns are ready to fire. Firing is accomplished by pressing the pedals for each of the guns.

(6) *Stoppages.*—The following comments may be helpful in combatting stoppages:

(a) *Incorrectly filled magazine.*—The feed piece moving forward on the breechblock will strike against

the base of two rounds and try to force them into the breech, causing the gun to jam.

(b) *Misfire*.—When the piston moves forward but the gun fails to fire, remove the magazine, pull back the cocking handle, and inspect the ejected round. If the round shows signs of having been struck, this may indicate a faulty round. Place the magazine on again, and if a misfire recurs, inspect the firing pin.

(c) *Insufficient gas*.—If the gun fires only one round and then stops, there is probably insufficient gas to drive recoiling portions to the rear. Unload, adjust the gas regulator, reload, and continue firing.

(d) *Ruptured case*.—When the piston moves forward but the gun fails to fire, and the ejected shell has a portion missing, the missing portion is stuck in the barrel, thereby preventing a new round from being correctly fitted into the breech.

(e) *Faulty ejection*.—When an empty case does not clear the weapon, the recoiling portions will jam on the forward movement.

(f) *Difficult extraction*.—A swelled case in the breech will impede the piston group in rear movement. Pull the cocking handle by hand or with a rope lanyard.

(7) *To unload*.—Remove the magazines by pressing forward on the magazine release lever and lifting the magazines forward and off.

e. Ammunition

The Model 93 (1933) 13-mm twin heavy machine gun uses ball, armor-piercing, and tracer ammunition. The ammunition is marked by a colored band on the

outer edge of the primer. The ball ammunition has a black band, the armor-piercing a white band, and the tracer a red band. (Four and three-fourths seconds is the time of burning of the tracer element.)

f. Maintenance

(1) *Oiling and cleaning.*—The Model 93 (1933) 13-mm twin heavy machine gun may be given the same care as U. S. gas-operated weapons. The bolt parts may be oiled lightly except in dry, dusty, or sandy country, then not at all.

(2) *Stripping.*—The stripping of the Model 93 (1933) 13-mm twin heavy machine gun is comparatively easy, since it involves only three main groups: piston assembly, barrel body, and rear buffer group in the receiver.

To strip these groups from the gun, see that the gun is not cocked, push out the receiver locking pin which is located at the rear end of the receiver, at the same time taking the weight of the return spring on the rear handle, and withdraw the buffer group.

Give the cocking handle a sharp pull to the rear; this will bring with it the bolt and piston assembly. Raise the tail of the interlocking catch, which is immediately behind the magazine release lever, and remove the piston assembly.

(3) *Assembly.*—To assemble the weapon, proceed in the reverse order to that followed in stripping.

Section VII. MORTARS

26. MODEL 98 (1938) 50-MM MORTAR ¹

a. General

The Model 98 (1938) 50-mm mortar (fig. 82) is easy to set up. It consists of three main parts—the base plate, the bipod, and the barrel. It has a fixed elevation of about 40 degrees. Provision is made for a limited traverse. At the base of the tube is an offset primer seat. Two links, one on each side, extend from the barrel collar. A range slide, graduated from 0 to 60, may be clamped to the muzzle of the mortar.

The Model 98 (1938) 50-mm mortar fires a formidable stick bomb (fig. 83), weighing nearly 10 pounds and containing an explosive charge of approximately 7 pounds of picric acid in rectangular blocks. The body of the bomb, made of sheet metal (three-sixteenths of an inch thick), is rectangular in shape (4½ by 4½ by 6½ inches) and is painted black. A hardwood stick 21 inches long and 1.91 inches in diameter fits into a socket in the base of the body, and is held in place by nails or screws. The bottom end of the stick is covered with a metal cap.

Two friction-type pull igniters, with black-powder delay trains giving a delay interval of approximately 7 seconds, fit into holes in the base of the charge.

¹The Japanese tactical symbol for mortar is .

The propelling charge consists of black-powder increments packed in small silk bags. Each increment is approximately 3.75 inches long and 1.25 inches in diameter. A pull-type friction primer, 0.88 inch in length, equipped with a loop lanyard, is designed to fit into the primer seat, or touch hole.

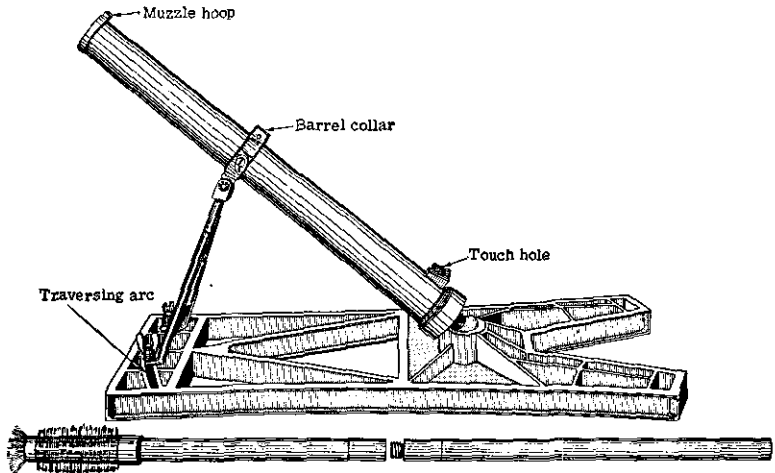

Figure 82.—Model 98 (1938) 50-mm mortar assembled, with cleaning tool.

b. How to Identify

The Model 98 (1938) 50-mm mortar may be identified by—

- (1) The rectangular, sectionalized base plate.
- (2) The fixed position of the bipod.
- (3) The **V** slots painted white and located at 12 o'clock on both the barrel collar and the projection of the muzzle hoop.



Figure 83.—Stick bombs which are inserted in muzzle of Model 98 (1938) 50-mm mortar.

(4) The marking 機擲役式八九 which is on the outside of the container in which the weapon is packed. (This marking, which is read *Kyuhachi Shiki Totekiki* from right to left,² means "98 model discharger.")

c. Characteristics

(1) *General*.—The Model 98 (1938) 50-mm mortar is a smooth-bore, muzzle-loading weapon.

(2) *Table of characteristics*.—

Ammunition.....	10-pound stick bomb.
Total weight.....	48 pounds.
Length of barrel.....	25 inches.
Traverse.....	124 mils (7 degrees).
Elevation (fixed).....	708 mils (40 degrees).

d. How to Operate

(1) *To load*.—Insert one or more powder increments in the muzzle. Place the stick of the stick bomb in the tube.

(2) *To aim*.—Adjust the graduated range slide to the desired distance (fig. 84). This regulates the length of the stick extending into the barrel of the mortar. The greater the distance the stick extends into the barrel, the greater the range. The principle involved is similar to that employed in adjusting the range of the Model 89 (1929) 50-mm grenade discharger (par. 20d(2), p. 76).

To traverse, loosen the two wing nuts that secure the bipod, and swing the bipod feet around the arc in front of the base plate.

² See p. 7, note 1.

(3) *To arm explosive charge.*—Insert the two friction-type pull igniters in the holes provided in the base



Figure 84.—Adjusting graduated range slide on Model 98 (1938) 50-mm mortar.

of the charge. Connect each igniter by cord to one of the two links extending from the barrel collar of the mortar on each side. Insert a pull-type friction primer

in the primer seat, which is on the side of the barrel near the base (fig. 85).

(4) *To fire*.—Pull the loop lanyard attached to the friction primer.

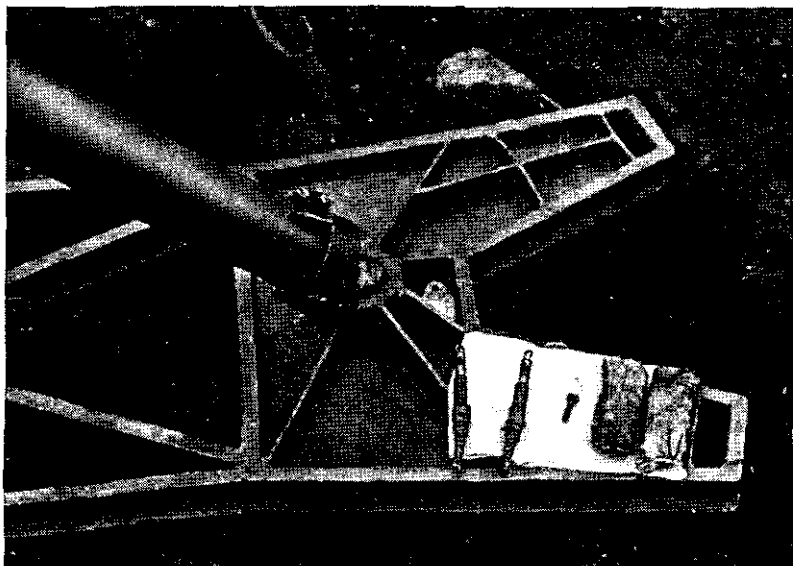

Figure 85.—Base of Model 98 (1938) 50-mm mortar, showing primer seat.

e. Ammunition

The stick bomb described in **a**, above, is the only ammunition for this weapon that has been recovered to date. A recent report states, however, that a finned Bangalore torpedo may also be used (par. 15, p. 58).

f. Maintenance

(1) *Oiling and cleaning*.—The Model 98 (1938) 50-mm mortar may be given the same care as would be given to U. S. mortars. There is a cleaning brush

which comes attached to the underside of the carrying-box cover (fig. 86).

(2) *Stripping*.—The Model 98 (1938) 50-mm mortar is easy to disassemble. Unscrew the thumb screws and

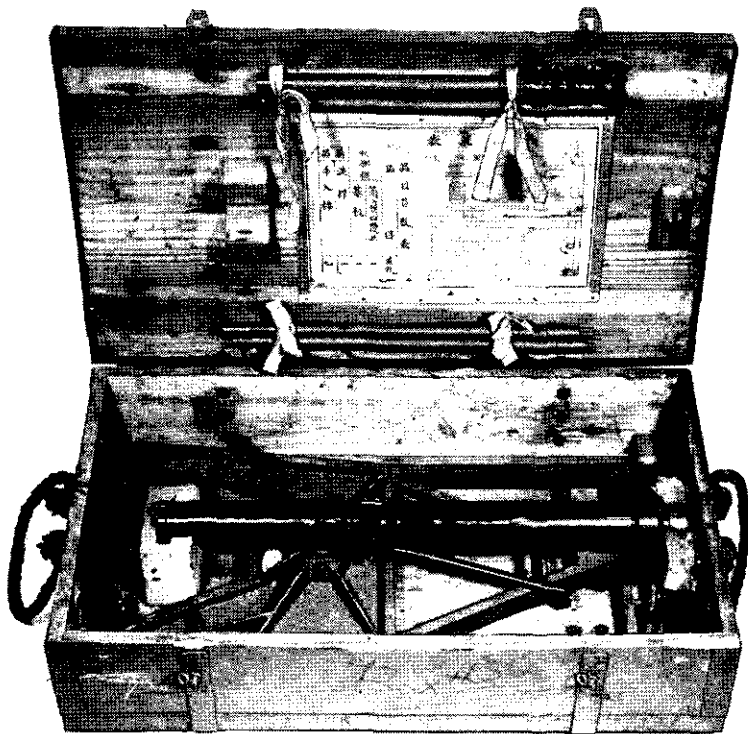

Figure 86.—Model 98 (1938) 50-mm mortar in carrying box.

remove the bipod feet from the traversing arc in the base plate; then remove the barrel-assembly ball out of the socket in the base plate. Remove the collar which attaches the bipod to the barrel.

(3) *Assembly*.—To assemble the weapon, proceed in the reverse order to that followed in stripping.

27. MODEL 11 (1922) 70-MM MORTAR ³

a. General

The Model 11 (1922) 70-mm mortar (fig. 87) is muzzle-loaded, yet has a rifled bore.

b. How to Identify

The Model 11 (1922) 70-mm mortar may be identified by—

- (1) The wooden base plate.
- (2) The barrel supported by an elevating screw without a bipod.
- (3) The side carrying rings.
- (4) The two parallel spades on the base plate.
- (5) The marking 砲兵 歩射 曲 式 年 一 十 which is on the breech end of the barrel. (This marking, which is read *Juichinen Shiki Kyokusha Hoheiho* from right to left,⁴ means “11th year model high-angle infantry gun.”)

c. Characteristics

(1) *General*.—The support of the barrel of the Model 11 (1922) 70-mm mortar by the elevating screw is similar to the support of the U. S. 4.2-inch chemical mortar.

³This weapon is listed by the Japanese as 十一年式曲射歩兵砲, which is read (from left to right) *Juichinen Shiki Kyokusha Hoheiho*, meaning “11th year model high-angle infantry gun.” (See p. 7, note 1.)

The Japanese tactical symbol for a mortar is .

⁴See p. 7, note 1.

(2) *Table of characteristics.*—

Total weight	-----	133.75 pounds.
Weight of base plate	-----	99.5 pounds.
Traverse	-----	410 mils (23 degrees).
Elevation:		
Maximum	-----	1,370 mils (77 degrees).
Minimum	-----	661 mils (37 degrees).
Barrel	-----	Rifled bore.

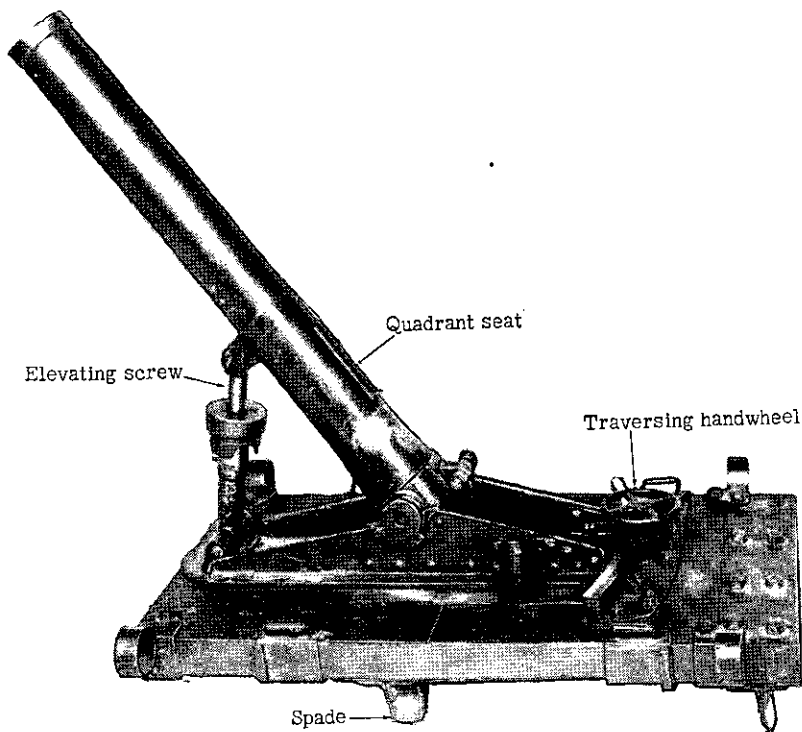

Figure 87.—Model 11 (1922) 70-mm mortar.

d. How to Operate

(1) *Safety.*—The Model 11 (1922) 70-mm mortar has a safety, in that the latch pin on the breech end of

the barrel must be set in its recess in order to fire the weapon.

(2) *Gunner's quadrant.*—The gunner's quadrant (fig. 88) used for laying-in the Model 11 (1922) 70-mm mortar is simple in construction. There is a level vial,

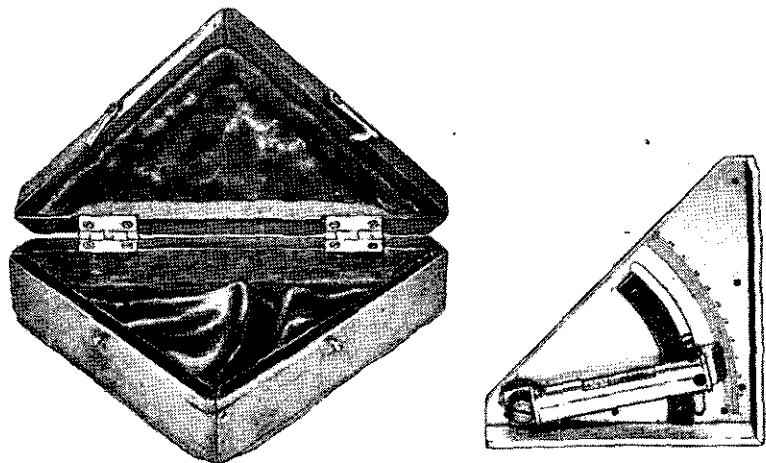

Figure 88.—Gunner's quadrant with carrying case.

which is actuated by a knob, a movable arm, and a fixed elevation scale. The elevation scale is graduated in half-degree intervals from 0 to 55 degrees. The movable arm has a vernier scale which allows readings of one-sixteenth of a degree.

(3) *To load and fire.*—The mortar is fired by means of a lanyard attached to a striker arm.

Set the base-plate level with the spades dug in firmly. Rotate the elevating nut in order to bring the piece to the desired elevation. Traverse by means of the traversing handwheel. Allow the shell to travel down the barrel. At the signal to fire, all members of

the crew, for purposes of safety, should be crouched below the level of the muzzle.

(4) *To unload.*—Release the barrel from the elevating screw. Rotate the barrel to swing it to the rear and disengage the barrel from the trunnions. Lift the barrel from the base plate and tilt it forward a little, being careful that the round slides out very slowly into your hand.

e. Ammunition

(1) *General.*—A three-piece high-explosive shell, similar in appearance and construction to the Model 89 (1929) 50-mm high-explosive shell (par. 20e(1), p. 80), is fired from this mortar. The shell consists of three major parts: the fuze, the body, and the propelling-charge assembly. The fuze is a simple point-detonating type, consisting of a two-piece fuze body, a booster cup, a detonator holder, and a spacing washer. Unlike the Model 89 (1929) 50-mm shell, there is no safety pin. The fuze is of brass.

The shell body is of steel, threaded at the top to receive the fuze assembly, and at the bottom to receive the propelling-charge assembly. It is marked with a white band near its base and with a red band at the nose.

The propelling-charge assembly consists of the percussion cap, the propellant, and an expanding copper rotating band. The propelling charge is ignited when the firing pin hits the percussion cap. The propellant gases expand the copper rotating band against the rifling in the barrel of the mortar. This action causes

the projectile to rotate in flight. Because of this construction, it is believed that this mortar is capable of accurate aimed fire over considerable distances.

(2) *Table of characteristics.*—

Over-all length.....	8.62 inches.
Diameter.....	2.8 inches.
Width of copper rotating band.....	1.05 inches.
Weight of complete round.....	4 pounds 10.8 ounces.

f. Maintenance

(1) *Oiling and cleaning.*—The Model 11 (1922) 70-mm mortar may be given the same care as is given to U. S. mortars. Cleaning materials may be found with the equipment.

(2) *Stripping.*—(a) *To remove barrel.*—The barrel may be removed by releasing it from the elevating screw, rotating the top of the barrel to the rear to disengage it from the trunnions, and lifting it upward.

(b) *To remove breechblock and firing mechanism.*—The breechblock may be removed from the barrel by releasing the latch-pin and unscrewing the breech. There is a spring retainer which can be unscrewed from the breech; when the spring retainer is unscrewed, the firing pin and the firing-pin holder are released.

(3) *Assembly.*—Each of the assemblies may be accomplished by reversing the stripping procedure.

28. 70-MM BARRAGE MORTAR

a. General

The 70-mm barrage mortar (fig. 89) was first encountered on the island of Attu. Consisting only of a barrel, wooden base plate, and spike extension rod,

this weapon is simply designed. The barrel has a smooth bore and fires a shell which contains seven small parachute bombs charged with nitrostarch. The mortar is apparently intended as a defense against low-flying aircraft.

b. How to Identify

The 70-mm barrage mortar may be identified by—

- (1) The wooden block base (fig. 90).
- (2) The spike extension rod.

c. Characteristics

(1) *General.*—The base of the 70-mm barrage mortar is a wooden block approximately 10 by 12 by 8 inches. Two bolts fasten a small base plate to the block. The wooden block absorbs the shock of firing and prevents the mortar from embedding itself in the ground.

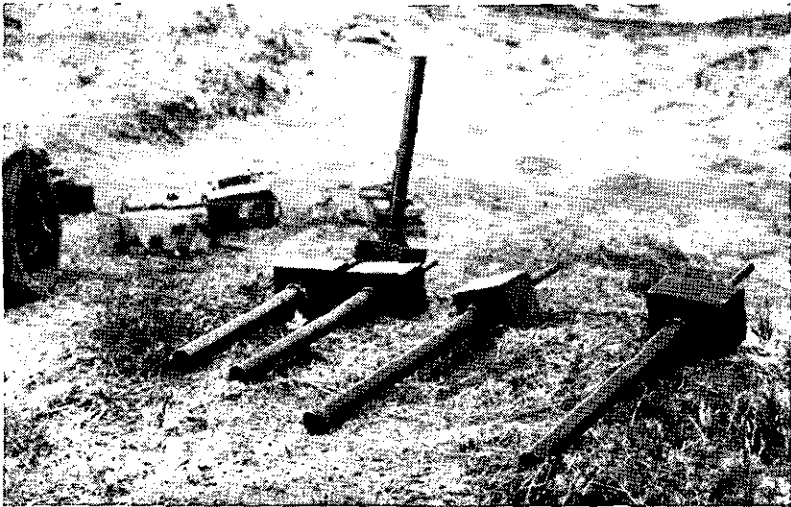

Figure 89.—70-mm barrage mortars, captured in the Aleutians.

(2) *Table of characteristics.*—

Ammunition.....	Shell containing parachute bombs.
Length of barrel.....	48 inches.
Over-all length.....	75 inches (approximately).

d. How to Operate

(1) *Safety.*—There is no safety on the 70-mm barrage mortar.

(2) *To elevate and depress.*—Changes in elevation and depression are accomplished by altering the position in which the rod is pegged into the ground.

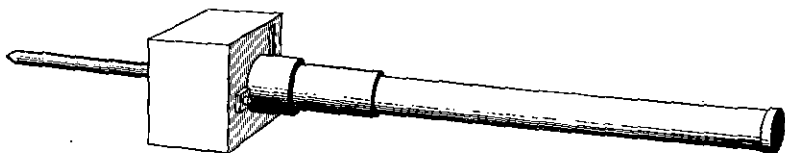

Figure 90.—70-mm barrage mortar, showing spike and block used as balance.

(3) *To load and fire.*—The mortar is muzzle-loading. When ready to fire, the shell is allowed to slide down the barrel, propelling charge first.

(4) *To unload.*—Lift the mortar from the ground and allow the round to slide slowly out of the barrel.

e. Ammunition

Ammunition for the 70-mm barrage mortar is packed 10 rounds to a box. The shell contains 7 parachute bombs 3 inches long by eleven-sixteenths of an inch in diameter. A steel cylinder encases the whole assembly.

The shell (fig. 91) is painted black and is $11\frac{1}{8}$ inches long and $2\frac{3}{4}$ inches in diameter. The nose is

capped with a wooden disk. After the shell is projected from the mortar by a propelling charge in the base, a time train and fixed powder charge cause the

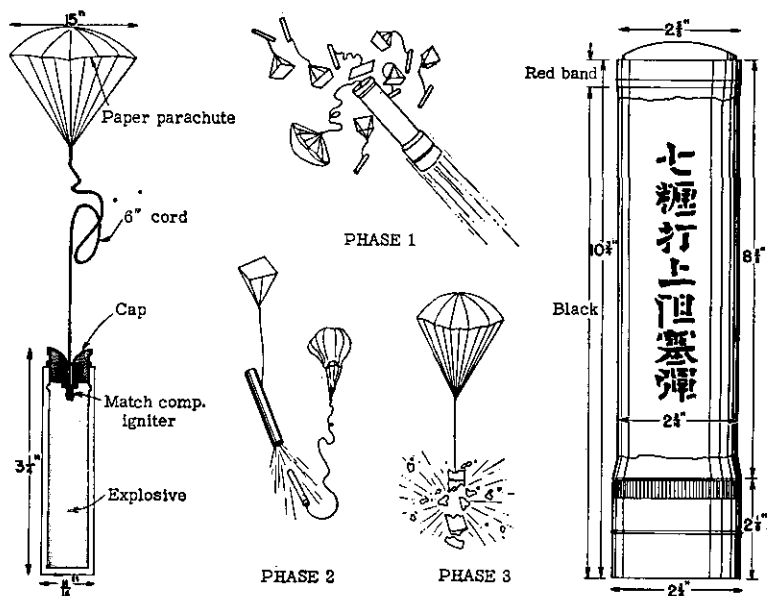

Figure 91.—Shell used in 70-mm barrage mortar and its method of operating. (The marking on the shell is read, from top to bottom, *Nana Sanchi Uchiage Sosaidan*, meaning "7-cm 'shooting-up' barrage shell.")

projection of the seven smaller bombs borne by rice-paper parachutes. At the same time a larger parachute is opened—tilting the main container and thus insuring the scattering of the seven bombs. These small bombs are loaded with three pellets of nitrostarch and are detonated in the air by a sensitive pull-igniter fuze with phosphorus-coated string and delay element. They may also be used as an effective booby trap for the curious or unwary soldier.

f. Maintenance

(1) *Oiling and cleaning.*—The care given to this mortar can be the same as that required for U. S. mortars.

(2) *Stripping.*—The simple construction of the 70-mm barrage mortar makes it easy to strip. The barrel is unscrewed from the metal base plates, the firing pin is unscrewed from the male fitting which holds it to the base plate, and the base plate is unfastened from the wooden block by removing the two bolts. The steel spike can be removed from the base of the wooden block.

(3) *Assembly.*—To assemble the weapon, proceed in the reverse order to that followed in stripping.

29. MODEL 97 (1937) 81-MM MORTAR ⁵**a. General**

The Model 97 (1937) 81-mm mortar is almost identical with the U. S. 81-mm mortar, M1 (see fig. 92). Japanese 81-mm mortar shells can be fired from the U. S. 81-mm mortar, M1, and U. S. 81-mm mortar shells can probably be used in the Japanese Model 97 (1937) 81-mm mortar. Full and adequate information is not yet available on the Model 97 (1937) 81-mm mortar.

b. How to Identify

The Model 97 (1937) 81-mm mortar may be identified by—

(1) The general resemblance that it bears to the U. S. 81-mm mortar, M1.

⁵ The Japanese tactical symbol for a mortar is .

(2) The offset locking nut for the firing pin. (There is no offset locking nut on the U. S. 81-mm mortar, M1.)

(3) The buttress-type thread on the elevating and traversing screws. (The U. S. 81-mm mortar, M1, does not have the buttress-type thread).

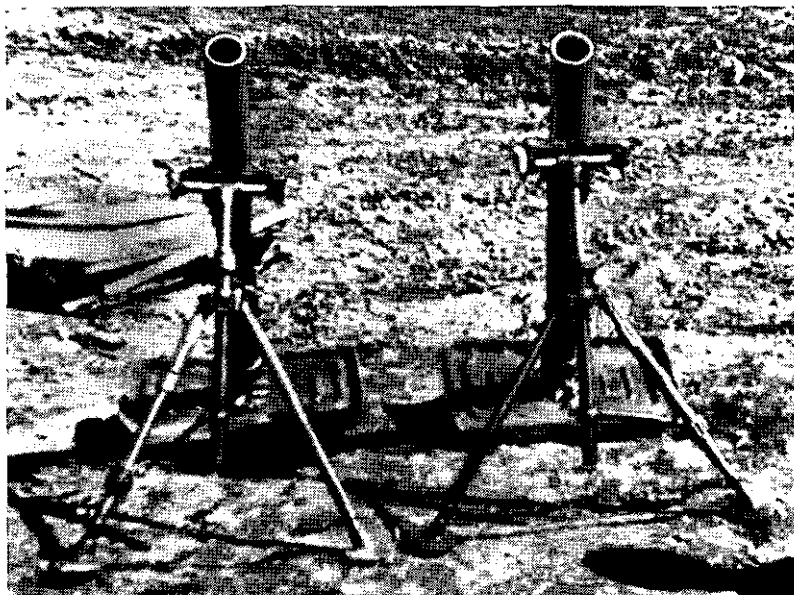

Figure 92.—Front view of Japanese Model 97 (1937) 81-mm mortar (left) and U. S. 81-mm mortar, M1 (right).

(3) The marking 九七式曲射步兵砲 which is at the base of the tube. (This marking, which is read *Kyunana Shiki Kyokusha Hoheiho* from left to right, means “97 model high-angle infantry gun.”)

c. Characteristics

(1) *General.*—The Model 97 (1937) 81-mm mortar is a smooth-bore, muzzle-loading, high-angle-fire

weapon. It is composed of three units: the barrel, the bipod, and the base plate.

(2) *Table of characteristics.*—

Length of barrel (over-all)-----	49.5 inches.
Rate of fire (estimated)-----	18 to 30 rounds per minute.

d. How to Operate

The operation of this weapon appears to be the same as for the U. S. 81-mm mortar, M1.

e. Ammunition

The weapon fires the same types of ammunition as are fired in the Model 99 (1939) 81-mm mortar (par. 30e, p. 157).

f. Maintenance

The same maintenance given the U. S. 81-mm mortar, M1, will keep this weapon in good operating order.

30. MODEL 99 (1939) 81-MM MORTAR^o

a. General

The Model 99 (1939) 81-mm mortar is similar to the Model 97 (1937) 81-mm mortar (par. 29, p. 150) and the U. S. 81-mm mortar, M1, except that it has a shorter barrel, is equipped for trigger firing, and has a close fit between the bore and the projectile to compensate for the shorter barrel.

^oThis weapon is listed by the Japanese as 九九式小迫撃砲, which is read (from left to right) *Kyukyū Shiki Shohakugekihō*, meaning "99 model small trench mortar." The Japanese tactical symbol for a mortar is .

All are patterned after the Stokes-Brandt type of mortar.⁷

Two men can carry the mortar. It can also be transported by horse-cart or motor truck.

b. How to Identify

The Model 99 (1939) 81-mm mortar may be identified by—

(1) The short barrel.

(2) The offset manually operated firing mechanism at the base of the barrel.

(3) The square base plate.

(4) The marking 砲撃迫小式九九 which is on the base of the tube. (This marking, which is read *Kyukyu Shiki Shohakugekiho* from right to left, means “99 model small trench mortar.”)

c. Characteristics

(1) *General*.—The Model 99 (1939) 81-mm mortar incorporates in the barrel collar a buffer system to absorb part of the recoil. There are two cylinders filled with light grease or heavy oil.

The weapon employs a collimator sight⁸ (fig. 94). There is, however, a seat provided on the bipod for a gunner's quadrant (see par. 27d(2), p. 144). Likewise, there is a white line painted along the top of the barrel to aid in sighting.

⁷ The Stokes-Brandt mortar is muzzle-loaded and has a smooth bore. It fires a rocket-shaped projectile with tail fins, which is very stable in flight, with the nose of the shell kept forward throughout the trajectory. The fuze used is the point-detonating type.

⁸ A sight that collimates, or adjusts its line of sight relative to the position of other parts of the mortar.

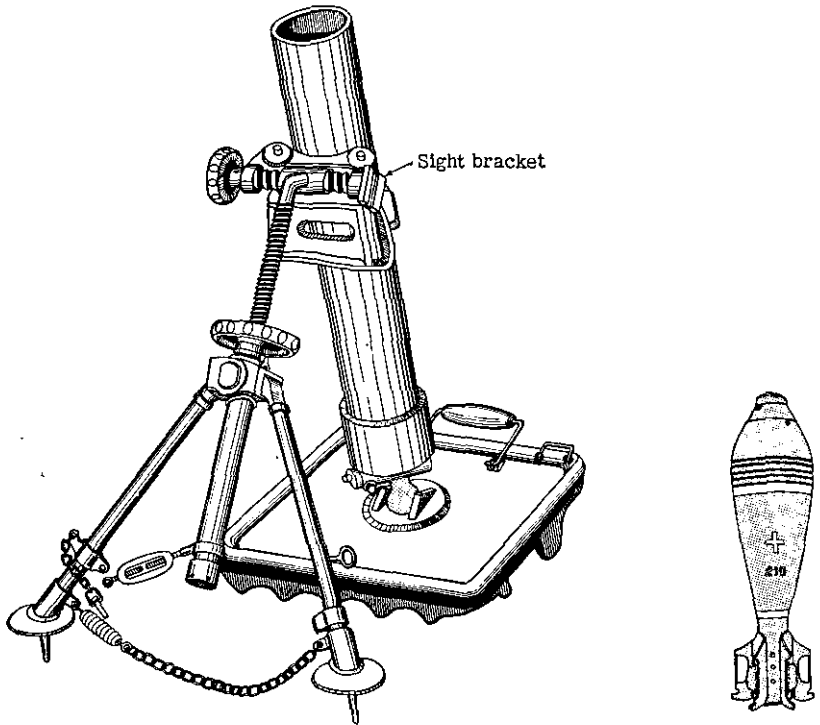

Figure 93.—Model 99 (1939) 81-mm mortar and shell.

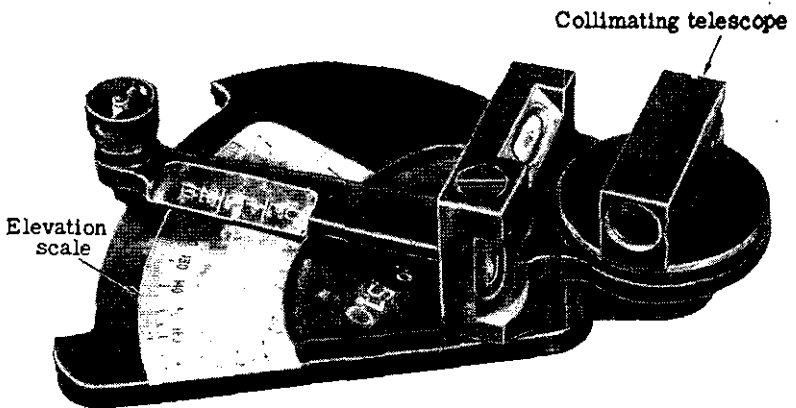

Figure 94.—Mortar sight.

(2) *Table of characteristics.*—

Ammunition.....	7.2 and 14.3-pound shells.
Over-all length.....	25¼ inches.
Total weight.....	52 pounds.
Barrel.....	17¾ pounds.
Base plate.....	18 pounds.
Bipod.....	16½ pounds.
Traverse.....	118 mils (6.7 degrees).
Maximum elevation.....	1,240 mils (70 degrees).
Minimum range:	
7.2-pound shell.....	545 yards.
14.3-pound shell.....	207 yards.
Maximum range:	
7.2-pound shell.....	3,280 yards.
14.3-pound shell.....	1,312 yards.
Rate of fire.....	15 rounds per minute.

d. How to Operate

(1) *Safety.*—There is a safety lever at the side of the base cap at the base of the mortar barrel. When this lever is turned to the right, the firing pin is in the “safe” position. By turning the lever to the left, the firing pin is placed in the firing position.

(2) *Sight.*—The mount is a dovetail bracket. The sight is equipped with a collimating telescope, two level vials, and an elevation scale graduated in 10-mil (0.562-degree) intervals from 800 to 1,600 mils (45 to 90 degrees). The simplicity of construction and method of mounting indicate that this mortar sight may be used with other mortars.

(3) *To load and fire.*—Level and lay-in the mortar as would be done with the U. S. 81-mm mortar, M1.

When ready to fire, load the piece according to the following instructions. With the smaller 7.2-pound shell, hold the shell in one hand and place the shell, fins first, in the muzzle, guiding it with the other hand. However, with the heavier 14.3-pound shell, the shell must be held in both hands in order to place it in the muzzle. At the signal to fire, with either shell, allow the projectile to slide down the barrel, and at the same time clear both your hands from the muzzle. To fire, strike the firing-pin cam shaft (see fig. 97)

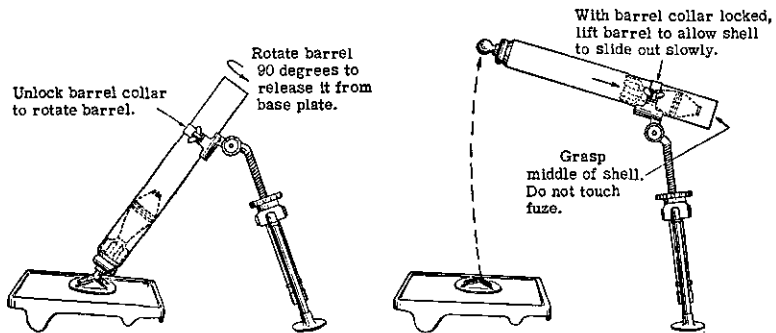

Figure 95.—Unloading Model 99 (1939) 81-mm mortar.

with a wooden mallet. This blow will drive the firing-pin cam shaft into the base cap, and as the cam shaft is driven inward, the cam surface on its upper side cams the firing pin upward into contact with the primer of the cartridge. At this point, as a safety precaution, all members of the crew should crouch down or be lying on the ground.

(4) *To unload.*—In case of a misfire, wait at least 1 minute before attempting to remove the shell.⁹

⁹ Sometimes there is a primer hangfire which will seem dead at first, then suddenly flare up an instant later.

Before proceeding further, first determine if the shell has become lodged in the barrel, somewhere short of the firing pin. By striking the side of the barrel in several places with a timber, the shell may be dislodged. If, however, this fails, then proceed to unload (fig. 95).

e. Ammunition

Two types of ammunition, smoke or chemical, and high-explosive, are known. Likewise, there are two weights of shells—7.2 pounds and 14.3 pounds. The complete 7.2-pound round consists of a percussion fuze, the shell body, the fin assembly, the primer cartridge, and the propelling charge. The propelling charge is made up of increments, each increment consisting of a lacquered silk envelope containing a ballistite-type propellant. The primer cartridge, enclosed at one end by a lacquered brass head, resembles a 12-gauge shotgun shell.

The body of the high-explosive shell is painted black, inside and out, and contains an explosive charge of about 1 pound of TNT. A white band is painted around the base of the body of the shell, a yellow band at the junction of the shell and the fin assembly, and a red band around the nose, on the fuze adapter. The 7.2-pound shell is 11.6 inches long unfuzed.

The fuze of the 81-mm shell functions on impact with instantaneous or delayed action. A hollow brass plug, that can be inserted in the fuze, provides delayed action of probably 0.1 second. For transport, the fuze is carried separately from the rest of the shell in a soldered tinplate cannister with a screw-lid (fig. 96).

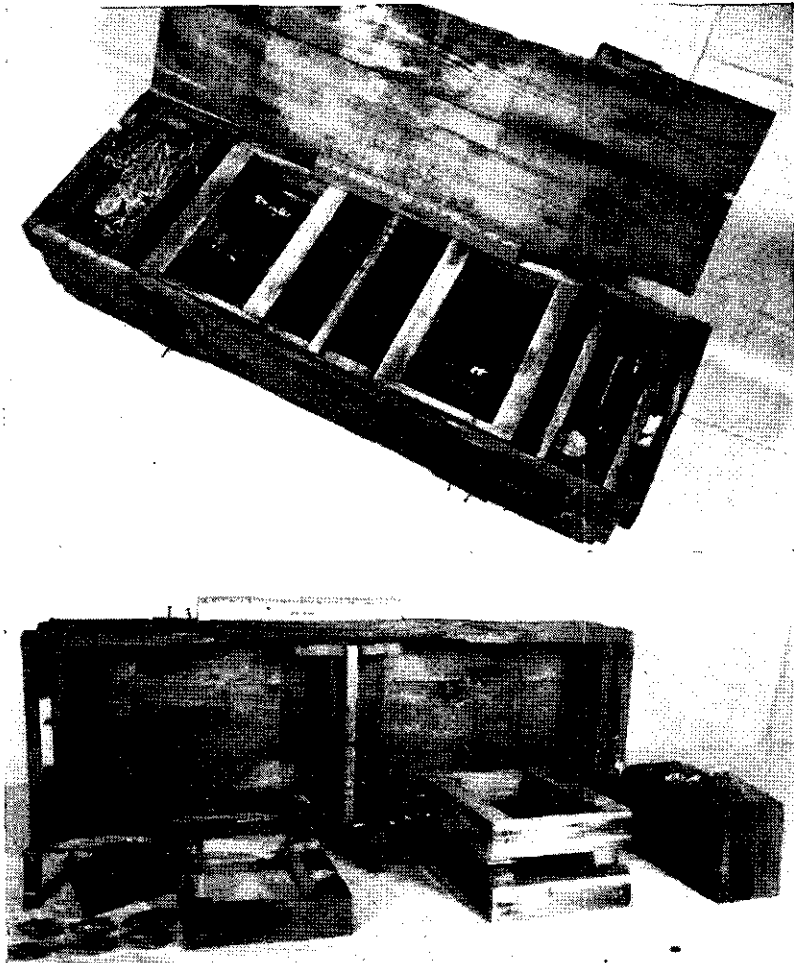

Figure 96.—Two views of packing box for Model 100 (1940) shells used in Model 99 (1939) 81-mm mortar (four complete rounds).

The fuze is held within the cannister by two wooden blocks shaped to take the base and the nose of the fuze. Two holes are drilled in the upper surface of the top block, and in one of these the delay plug rests.

There is also a green signal flare fired from the Model 99 (1939) 81-mm mortar, as well as a parachute smoke signal.

f. Maintenance

(1) *Oiling and cleaning.*—Oiling and cleaning equipment may be found with the mortar. If not, standard U. S. equipment for the U. S. 81-mm mortar,

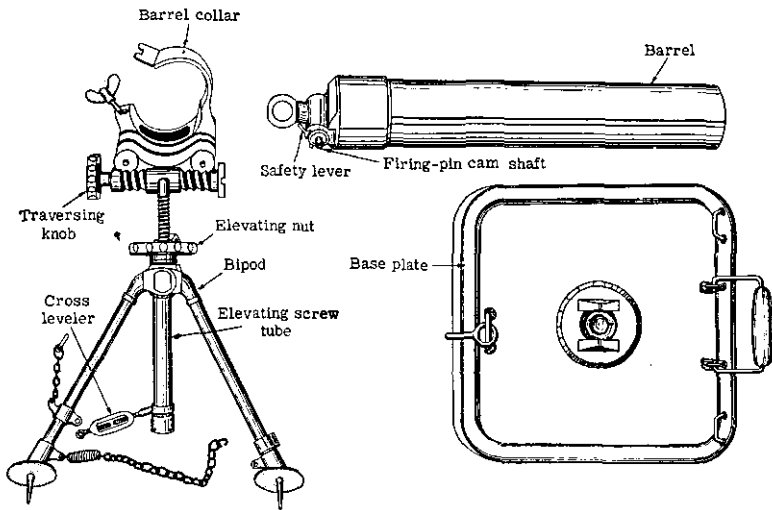

Figure 97.—Model 99 (1939) 81-mm mortar disassembled.

M1, may be used, and the same care as is given to the U. S. mortar may be given to the Model 99 (1939) 81-mm mortar.

(2) *Stripping.*—The mortar may be broken down into three parts (fig. 97). First, the bipod may be removed by unlocking the thumbscrew on the side of the barrel collar. Next, the barrel may be removed from the base plate by freeing the ball of the base cap

from the socket in the base plate. This is accomplished by rotating the barrel 90 degrees.

(3) *Assembly*.—To assemble the weapon, proceed in the reverse order to that followed in stripping.

31. MODEL 94 (1934) 90-MM MORTAR ¹⁰

a. General

The Model 94 (1934) 90-mm mortar (fig. 98) is a smooth-bore, muzzle-loading weapon, with a fixed firing pin. Unlike most mortars, it has a special recoil mechanism. Both chemical and high-explosive shells are used.

b. How to Identify

The Model 94 (1934) 90-mm mortar may be identified by—

(1) The special recoil mechanism.

(2) The large caliber and long barrel.

(3) The marking 砲撃迎輕式四九 which is on the base of the tube. (This marking, which is read *Kyuyon Shiki Keihakugekiho* from right to left, means “94 model light trench mortar.”)

c. Characteristics

(1) *General*.—The feature of the Model 94 (1934) 90-mm mortar is its recoil mechanism, which consists of two equal cylinders mounted on a one-piece U-shaped frame. The frame fits into the base plate by

¹⁰ The Japanese tactical symbol for a mortar is .

a ball-and-socket arrangement. The barrel is connected by a bar to the recoil cylinders, while the recoil cylinders are also attached to bipod shock absorbers.

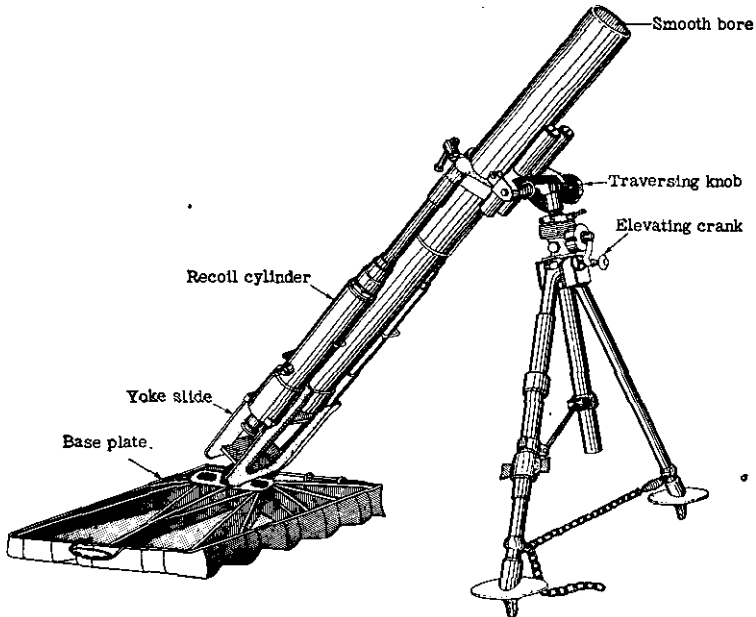

Figure 98.—Model 94 (1934) 90-mm mortar.

(2) *Table of characteristics.*—

Ammunition.....	HE and incendiary shells.
Length of barrel with breech cap..	51 $\frac{1}{16}$ inches.
Weight in action.....	340 pounds.
Total traverse.....	177 mils (10 degrees).
Maximum range.....	4,150 yards.
Length of recoil.....	5.67 inches.

d. How to Operate

(1) *To elevate.*—Elevating is accomplished by turning the crank at the junction of the bipod legs and the elevating screw.

(2) *To traverse.*—Traversing is accomplished by turning the knob situated at the end of the traversing screw where the barrel is collared to the bipod (fig. 99).

(3) *To load and fire.*—Level and lay-in the mortar in the same manner as would be done with the U. S. 81-mm mortar, M1. The sight is also operated in the same way. The cross-leveling device is the knurled nut and collar on the bipod leg.

At the signal to fire, all members of the crew, for purposes of safety, should crouch below the level of the muzzle. Then the projectile can be allowed to slide down the barrel, fins first (fig. 100).

If the mortar fails to fire when the projectile is allowed to slide down the barrel, in all probability the firing pin is not long enough to fire the igniting charge. To remedy this, turn the round nut at the lower rear of the breech ring a quarter turn and remove it. Then tighten the split nut at the top rear of the breech ring until the shoulders match the milled recess.

(4) *To unload.*—If there is a misfire, wait at least 1 minute before attempting to unload the weapon. Then try to find whether the shell has become lodged in the barrel somewhere short of the firing pin. Use a piece of timber, and strike the barrel at several places. If that fails, proceed to unload. (See fig. 95, p. 156, for the method of unloading.)



Figure 99.—Laying-in Model 94 (1934) 90-mm mortar.

e. Ammunition

The Model 94 (1934) 90-mm mortar fires high-explosive and chemical shells (see figs. 101, 102, and



Figure 100.—Loading Model 94 (1934) 90-mm mortar.

103). The incendiary shell is 16 inches long and weighs 11.6 pounds. The incendiary mixture is white phosphorus, carbon disulphide,¹¹ and some 40 impreg-

¹¹ A highly inflammable liquid.

nated cylindrical rubber pellets. A bursting charge of 2.8 ounces scatters the mixture upon impact of the shell at the target. The propelling charge consists of 1 cartridge and 6 increments.

In appearance, the incendiary shell is very similar to the U. S. 81-mm mortar projectile. The body is

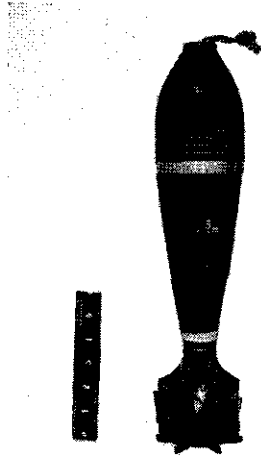

Figure 101.—Model 94 (1934) 90-mm mortar shell. (Note the propelling increments between the fins.)

painted with four colored bands painted around its circumference, as follows:

- (1) Red band just below the fuze;
- (2) Blue band halfway between the fuze and the bourrelet;
- (3) Yellow band halfway between the bourrelet and the fin assembly;
- (4) White band at the junction of the shell body and the fin.

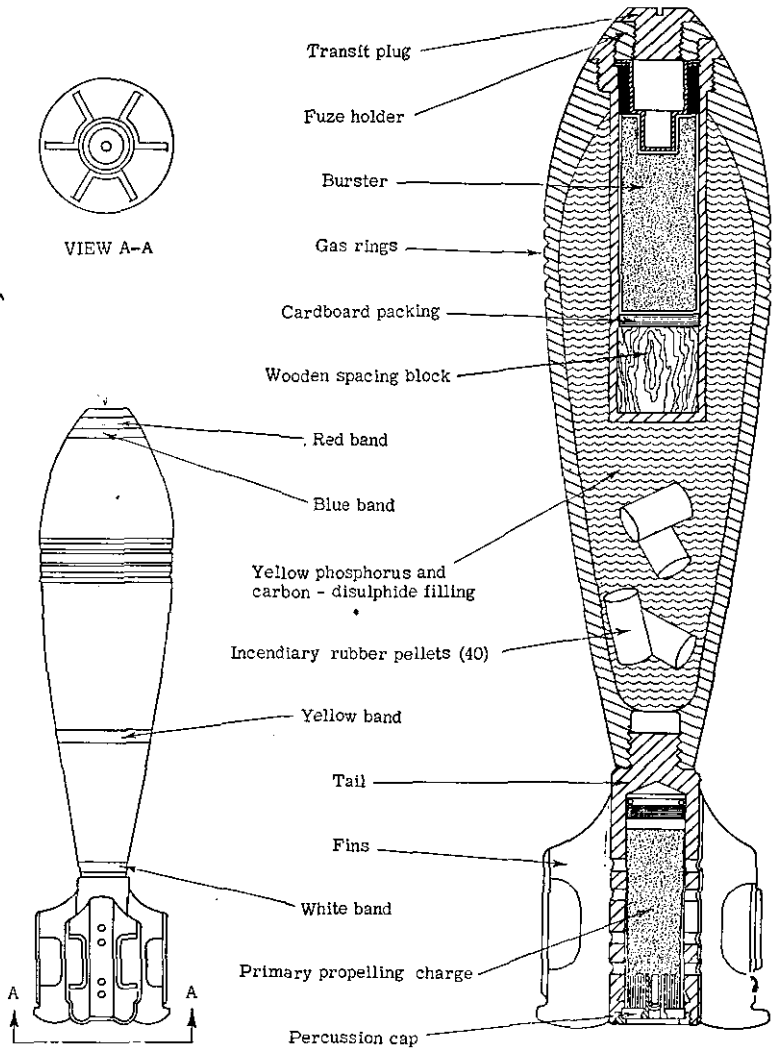

Figure 102.—Incendiary shell for Model 94 (1934) 90-mm mortar.

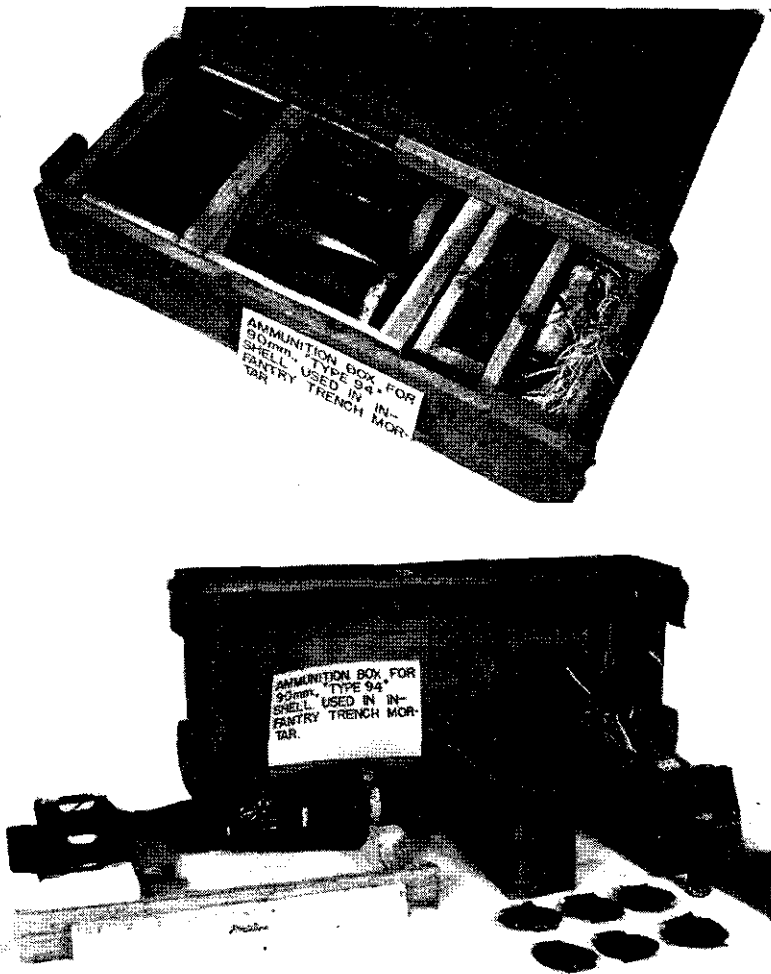

Figure 103.—Model 94 (1934) 90-mm mortar shell with two views of its packing box (two complete rounds).

f. Maintenance

(1) *Oiling and cleaning.*—The same care as is given to U. S. mortars may be given to the Model 94 (1934) 90-mm mortar. Likewise, the same materials may be used.

(2) *Stripping.*—The Model 94 (1934) 90-mm mortar can be disassembled into four parts (fig. 104): the

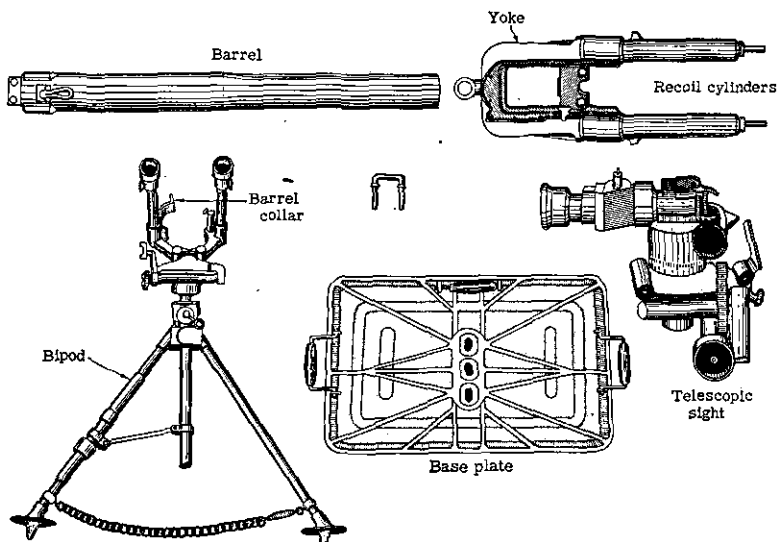

Figure 104.—Model 94 (1934) 90-mm mortar disassembled.

barrel assembly, the recoil assembly, the bipod assembly, and the baseplate.

(a) The barrel assembly consists of the barrel, the breech ring, and the breech mechanism. It is removed from the yoke by removing the U-shaped pin which locks it at the extension from the breech end. The pin also releases it from the recoil mechanism.

(b) The frame, or yoke, can be removed from the baseplate by rotating the whole frame 90 degrees around its longitudinal axis in order to disengage the ball from the socket in the base plate.

(c) Next, the bipod is removed by unlocking the barrel collar.

(d) This procedure leaves the baseplate clear.

(3) *Assembly*.—To assemble the weapon, proceed in the reverse order to that followed in stripping.

Section VIII. ANTITANK AND INFANTRY GUNS

32. MODEL 97 (1937) 20-MM ANTITANK RIFLE

a. General

The Model 97 (1937) 20-mm antitank rifle (figs. 105 and 106), sometimes referred to as an antitank machine cannon, is a single-purpose, full-automatic antitank weapon. Infantry troops can maneuver it in any sort of terrain. Two men can carry it, since it weighs only 150 pounds complete. However, the usual method of transportation, with carrying handles in the brackets provided in the front and rear of the cradle, requires three or four men.

b. How to Identify

The Model 97 (1937) 20-mm antitank rifle may be identified by—

- (1) The rear monopod and front bipod.
- (2) The nonadjustable inverted **V** front sight, and the peep sight to the rear.
- (3) The low silhouette.
- (4) The marking ^九_七 which is on top of the receiver.

(This marking, which is read *Kyunana Shiki* from top to bottom,¹ means "97 Model.")

¹ See p. 7, note 1.

c. Characteristics

(1) *General.*—The Model 97 (1937) 20-mm antitank rifle is easy to conceal because of its low silhouette—16½ inches high, excluding the shield. It can be quickly moved from place to place by employing the two sets of removable carrying handles which fit into the brackets in the front and rear part of the weapon (figs. 107 and 108). Straps, which fit in between the handles and can be looped over a man's shoulder when the gun is carried, are also provided.

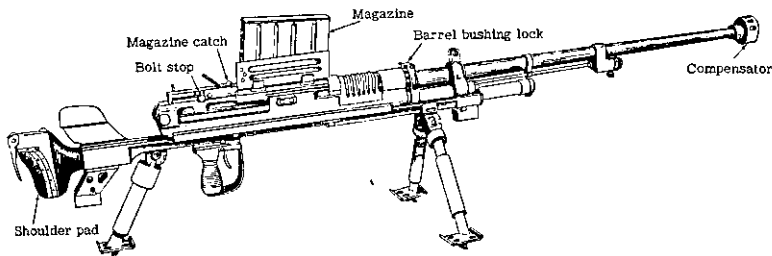

Figure 105.—Model 97 (1937) 20-mm antitank rifle (right side).

The weapon is gas-operated, air-cooled, and magazine-fed. Its operation is divided into six phases, occurring in the following order:

- | | |
|-----------------------------|-----------------|
| (a) Loading. | (d) Unlocking. |
| (b) Locking (bolt forward). | (e) Extracting. |
| (c) Firing. | (f) Ejecting. |

The first three phases occur in counterrecoil, and the last three in recoil. The spent cartridge case is ejected through an opening in the bottom of the receiver.

(2) *Table of characteristics.*—

Principle of operation-----	Gas-operated, full-automatic only.
Ammunition-----	High-explosive and armor-piercing.
Type of feed-----	7-round box magazine.
Length of barrel:	
With compensator-----	48 $\frac{7}{8}$ inches.
Without compensator-----	47 $\frac{1}{8}$ inches.
Over-all length:	
With carrying handles-----	89 $\frac{1}{2}$ inches.
Without carrying handles--	82 $\frac{1}{2}$ inches.
Weight:	
In action-----	140 pounds.
Complete with carrying handles-----	150 pounds.
Thickness of shield armor-----	$\frac{5}{16}$ inch.
Traverse-----	1,600 mils (90 degrees).
Elevation:	
Maximum-----	89 mils (5 degrees).
Minimum-----	-89 mils (-5 degrees).
Effective range-----	1,100 yards.
Rate of fire-----	Unknown.

d. How to Operate

(1) *Safety.*—There are two safety features. One is a trigger block, located on the left side of the trigger housing above the pistol grip; this, when rotated, prevents the trigger from being pulled. The other is a bolt stop on the right rear side near the top of the receiver; when it is turned, the bolt is held to the rear.

(2) *To elevate.*—The two front legs of the tripod are telescopic. Each of these two legs is provided with

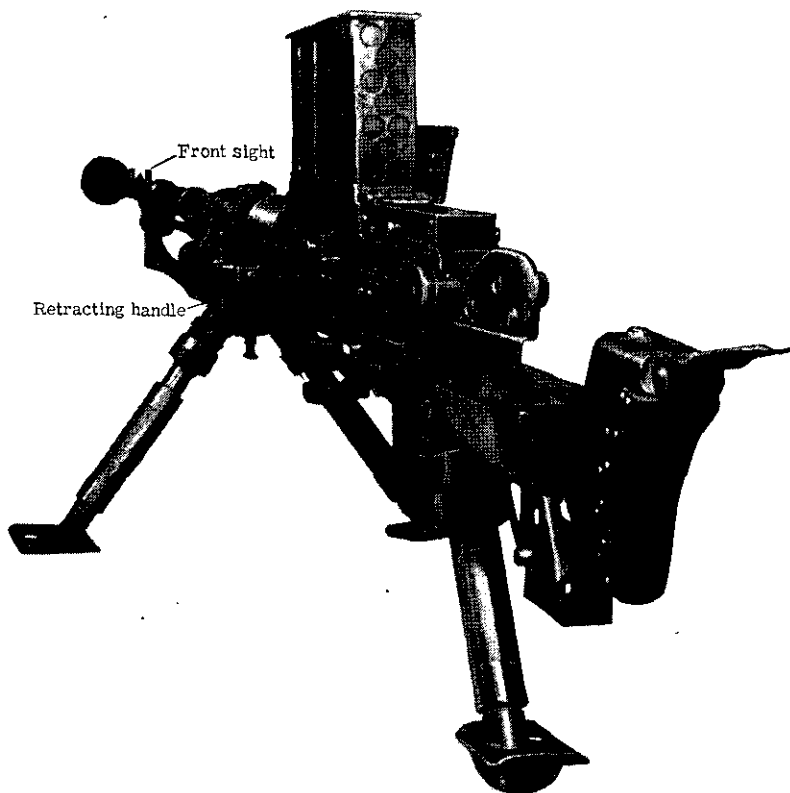

Figure 106.—Model 97 (1937) 20-mm antitank rifle (left rear view).

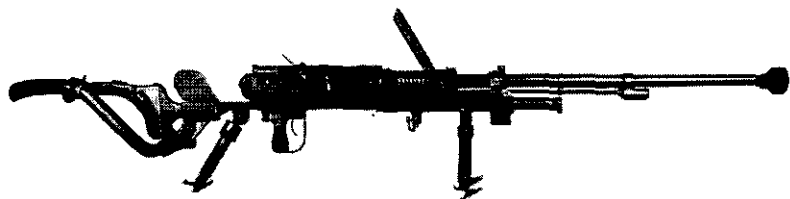

Figure 107.—Model 97 (1937) 20-mm antitank rifle with shield and rear carrying handles in place.

a knurled collar. Elevating is accomplished by turning the collars.

(3) *To traverse.*—Traversing to 45 degrees is done by shoulder control against the shoulder stock at the rear of the gun; the front bipod can swivel up that amount without being moved, but the rear leg must be pulled from the ground and reset each time.

(4) *To sight.*—The sighting equipment consists of a nonadjustable inverted V front sight, and a peep

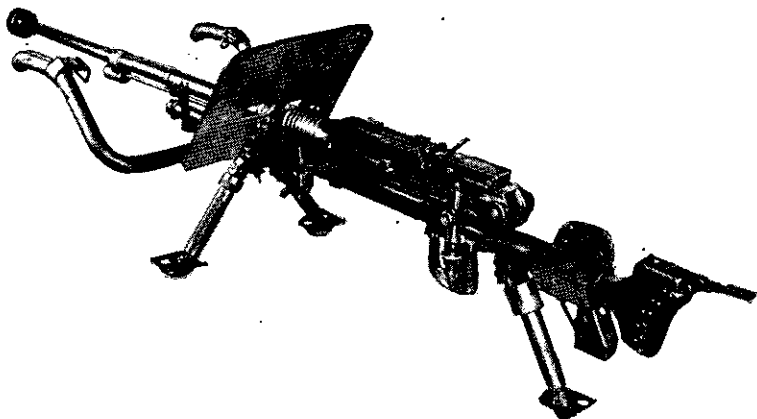

Figure 108.—Model 97 (1937) 20-mm antitank rifle with shield and front carrying handles in place.

rear sight which can be adjusted up to 1,000 meters (1,094 yards) range, and 10 mils (0.562 degree) wind-age right and left.

(5) *To load and fire.*—To cock the gun, the retracting handle on the left side of the receiver is pulled to the rear. Make sure that the rear monopod is well sunk, for this weapon has considerable recoil.

With the bolt stop used to engage and hold the bolt to the rear, the vertical box-type magazine is inserted and locked in the top of the receiver.

Release the bolt stop and the trigger block. Push the retracting handle forward. Pull the trigger. The gun will fire full-automatic only; if the trigger is released, the sear is forced up into the receiver and holds the operating parts to the rear.

When the last round has been fired, hold the bolt to the rear before inserting a new magazine.

(6) *To unload.*—If there is a misfired round in the chamber, place the trigger block in the safe position, and pull the retracting handle to the rear in order to extract and eject the round.

e. Ammunition

Two types of ammunition, similar in shape and size, are fired in the Model 97 (1937) 20-mm antitank rifle: high-explosive with point-detonating fuze, and armor-piercing shot. The complete round is $7\frac{3}{4}$ inches long; it must not be confused with the 20-mm ammunition made for the Model 98 (1938) AA/AT machine gun, which is in a larger shell case (see part. **33e**, p. 183).

f. Maintenance

(1) *Oiling and cleaning.*—The bore requires careful swabbing and cleaning for firing. The bolt parts should be oiled lightly, except in dry, dusty, or sandy country, then not at all. Where lubrication oils and greases are required, use the same lubricants as would be used for similar moving parts on U. S. weapons.

(2) *Stripping.*—(a) *Barrel.*—Pull the retracting handle to the rear. Put the gun on “safe.” Release the barrel-bushing lock. Turn the barrel bushing approximately one-sixth of a turn to the right. Then pull the barrel straight out to the front. (For disassembly, see fig. 109.)

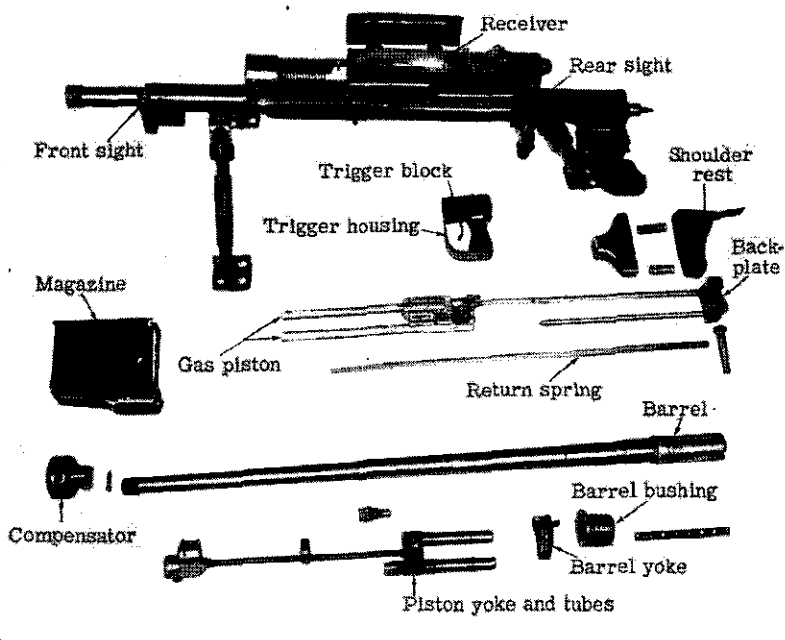

Figure 109.—Model 97 (1937) 20-mm antitank rifle disassembled.

(b) *Bolt group.*—Release the safeties and allow the bolt to travel forward by pulling the trigger. Push forward on the backplate to release the tension imparted to it by the return springs, and remove the backplate pin from the right side of the receiver. Be cautious in removing the backplate so that the com-

pressed springs will not cause the plate to fly from the gun.

Pull the retracting handle to the rear and remove the gas piston, bolt lock, and bolt.

(3) *Assembly*.—To assemble the weapon, proceed in the reverse order to that followed in stripping.

33. MODEL 98 (1938) 20-MM ANTI-AIRCRAFT-ANTITANK MACHINE CANNON²

a. General

The Model 98 (1938) 20-mm AA/AT machine cannon (fig. 110) is an all-purpose weapon. It is a fine weapon for defense against low-flying aircraft (fig. 111), because it is light in weight and very maneuver-

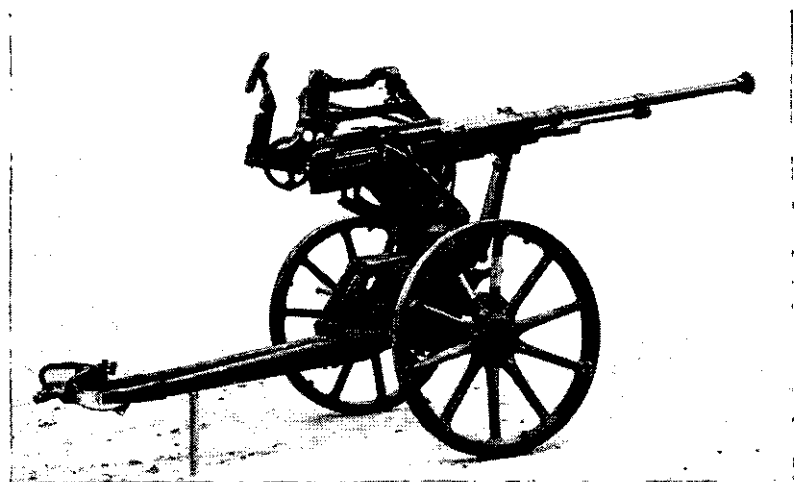

Figure 110.—Model 98 (1938) 20-mm anti-aircraft-antitank machine cannon in traveling position.

²The Japanese tactical symbol for the antitank-anti-aircraft machine cannon is ↑.



Figure 111.—Model 98 (1938) 20-mm anti-aircraft-antitank machine cannon in action.

able. It is estimated that an experienced gun crew can place the piece in battery, ready for anti-aircraft fire, in less than 3 minutes. In an emergency, the weapon could be fired as a straight artillery piece, for it has a split trail and wheels.

b. How to Identify

The Model 98 (1938) 20-mm AA/A'T machine cannon may be identified by—

(1) Its general appearance, which is different from any other Japanese field piece (see fig. 112).

(2) The front outrigger.

(3) The barrel traveling lock.

(4) The marking ^九八 _式 which is on the top of the receiver. (This marking, which is read *Kyuhachi Shiki* from top to bottom, means "98 model.")

c. Characteristics

(1) *General.*—The mechanism of the Model 98 (1938) 20-mm AA/AT machine cannon is patterned after the Model 97 (1937) 20-mm antitank rifle (par. 32, p. 170). It is semi- or full-automatic, gas-operated,

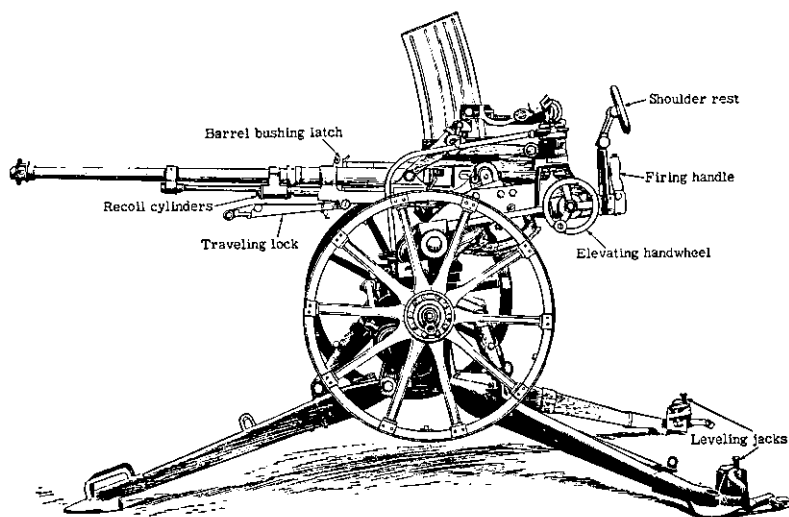

Figure 112.—Model 98 (1938) 20-mm antiaircraft-antitank machine cannon (left side).

and magazine-fed. The cycle of operation is carried out in the following order:

- | | |
|-----------------------------|-----------------|
| (a) Loading. | (d) Unlocking. |
| (b) Locking (bolt forward). | (e) Extracting. |
| (c) Firing. | (f) Ejecting. |

Unlocking, extracting, and ejecting are done during recoil; loading, locking, and firing, during counter-recoil.

The recoil mechanism consists of two spring-loaded cylinders that lie one on each side of the barrel. Air valves, located in the forward ends of the cylinders, allow air to be drawn into the cylinders during recoil; as the air cannot readily escape, it acts as a cushion during counterrecoil.

The vertical box-type magazine—with a capacity of 20 rounds—fits into a slot in the top of the receiver and is held in place by a spring catch.

For traveling, towing shafts are inserted in slots at the end of the trails, and a traveling lock, which connects the forward part of the barrel to the bottom carriage, holds the gun steady in transit.

(2) *Table of characteristics.*—

Principle of operation.....	Gas-operated, semi- or full-automatic.
Ammunition.....	High-explosive, tracer, and armor-piercing.
Type of feed.....	20-round box magazine.
Length of barrel:	
With muzzle brake.....	57½ inches.
Without muzzle brake.....	55⅛ inches.
Over-all length with trails folded.....	108 inches.

Total weight without wheels.....	836 pounds.
Traverse without wheels.....	6,400 mils (360 degrees).
Elevation:	
Maximum.....	1,511 mils (85.7 degrees).
Minimum.....	-178 mils (-10 degrees).
Maximum range:	
Horizontal.....	5,450 yards.
Vertical.....	12,000 feet.
Muzzle velocity.....	2,720 feet per second.
Rate of fire.....	120 rounds per minute.
Length of recoil.....	Adjustable from 2 inches to 2.5 inches.

d. How to Operate

(1) *Safety*.—There are two safety features on the Model 98 (1938) AA/AT 20-mm machine cannon: (a) the lock on the firing handle, to the left and rear of the gun, which must be depressed before the handle can be moved forward; and (b) the manual safety mechanism, to the rear and upper right side of the receiver, which must be turned counterclockwise before the weapon can be fired.

(2) *To place in firing position*.—The trails and outrigger are set in the ground. The eccentric—crank-shaped—axle is swung so that the weapon is resting on the trails and outrigger, and the wheels are clear of the ground. Then the wheels can be removed by releasing the spring catches, which lock them to the axle.

(3) *To elevate*.—The elevating handwheel is to the left rear.

(4) *To traverse*.—Swing the gun by pressing on the shoulder rest at the left rear of the weapon.

(5) *To load.*—Place a loaded magazine into the slot on top of the receiver. The first round can be pushed into the chamber by pulling the operating handle to the rear and then pushing it forward. (The operating handle is at the right of the receiver.)

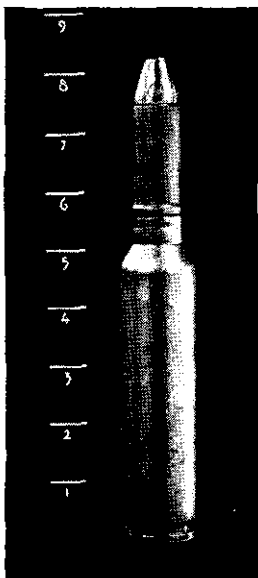

Figure 113.—20-mm high-explosive round for the Model 98 (1938) antiaircraft-antitank machine cannon.

(6) *To fire.*—Press the lock on the firing handle and move the firing handle forward. Automatic or semi-automatic fire may be chosen by moving the change lever at the right rear of the sleigh.

(7) *To unload.*—If there is a misfired round in the chamber, pull back the operating handle in order to extract and eject the round.

e. Ammunition

There are two types of ammunition fired from the Model 98 (1938) 20-mm AA/AT machine cannon: high-explosive and armor-piercing.

(1) The high-explosive ammunition has an abnormally large brass shell case, and a black projectile body (figs. 113 and 114). On the shell body are painted a green and yellow band together around its middle, and a red band just below the bourrelet.

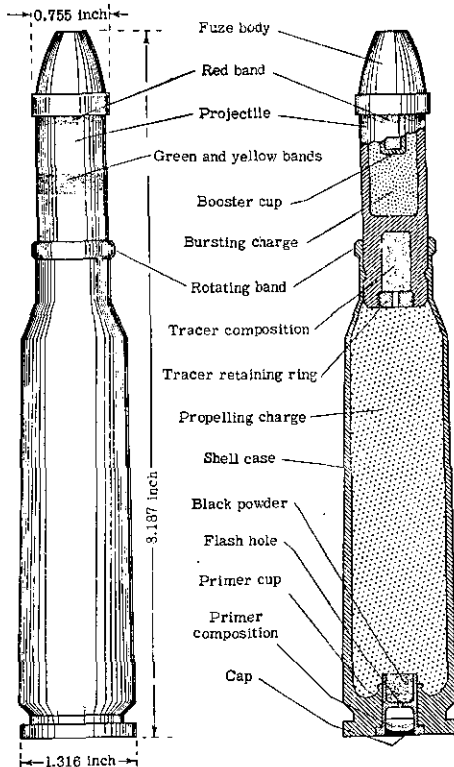

Figure 114.—20-mm high-explosive tracer shell.

The complete round weighs 14.5 ounces, and is 8.187 inches long. The brass nose fuze is point-detonating, bore-safe, and supersensitive (fig. 115). There is a tracer compound in the base of the shell.

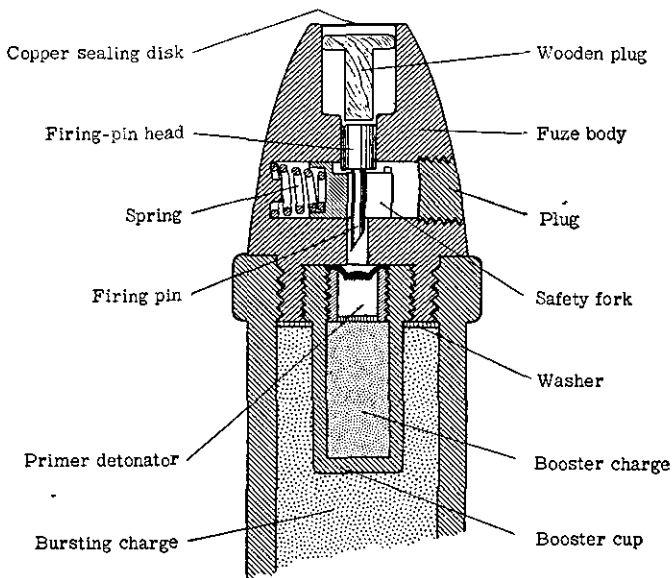

Figure 115.—Cross section of point-detonating fuze used in 20-mm high-explosive tracer shell.

(2) The difference between the high-explosive ammunition and the armor-piercing ammunition is in the projectile, for both use the same shell case. The complete armor-piercing round is 8.183 inches long.

Both the high-explosive and the armor-piercing rounds are wrapped individually in cardboard containers (fig. 116). The armor-piercing ammunition is packed 70 rounds to a wooden box (fig. 117).

The fuzes for the high-explosive rounds are wax-dipped, covered with a metal cap, and paper-wrapped. The wrapped fuzes are packed between holes in boards mounted in an unlined crate, and shipped separately from the rest of the round.



Figure 116.—20-mm armor-piercing round with cardboard container.

f. Maintenance

(1) *Oiling and cleaning.*—The Model 98 (1938) 20-mm AA/AT machine cannon may be given the same care as is given to U. S. machine guns and automatic cannons. The bolt parts may be oiled lightly, except in dusty or sandy countries, then not at all.

(2) *Stripping.*—(a) *Barrel.*—The barrel on the Model 98 (1938) 20-mm AA/AT machine cannon is

keyed to the receiver by a set screw. When this set screw is loosened, the barrel may be freed by releasing a latch on the rim of the barrel bushing, and turning the barrel about one-sixth of a turn. With the barrel will come the gas-cylinder yokes as one assembly.

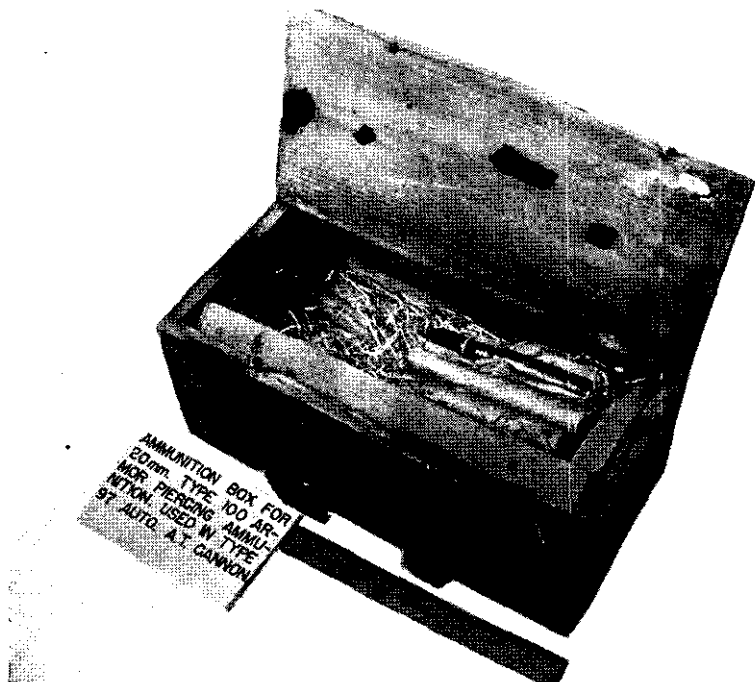

Figure 117.—Packing box for Model 100 (1940) 20-mm armor-piercing ammunition (70 complete rounds).

(b) *Bolt*.—Place the bolt in the forward position with the operating handle. Remove the receiver rear-plate assembly and slide the bolt out to the rear.

(c) *Magazine*.—The principal parts of the magazine may be stripped as shown in figure 118.

(3) *Assembly*.—To assemble the weapon, proceed in the reverse order to that followed in stripping.

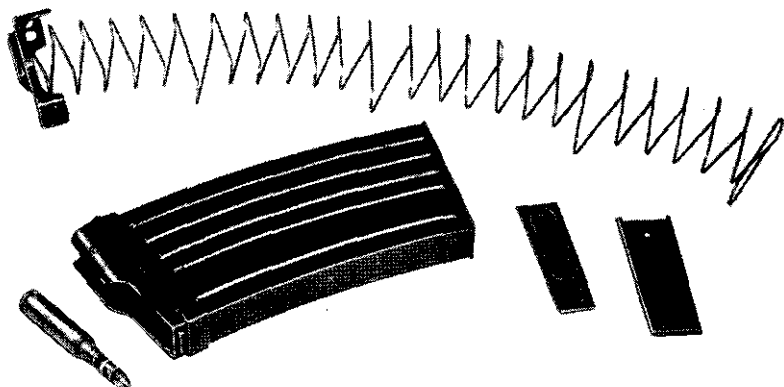

Figure 118.—Magazine of Model 98 (1938) 20-mm antiaircraft-antitank machine cannon.

g. Accessories

A carrying case for the sight comes with the Model 98 (1938) 20-mm AA/AT machine cannon. There is also a small box containing a quantity of headspace washers. The ammunition is carried in a caisson which may be horse-drawn.

The sight-mount carrying case has in it the following items:

<i>Amount</i>	<i>Article</i>
1.....	Complete sight.
1.....	Pair of glasses.
1.....	Pair of colored glasses.
1.....	Lighting apparatus.
1.....	Rain cover.
1.....	Small camel's-hair cleaning brush
1.....	Towel.
1.....	Oil can.
3.....	Brushes.

34. MODEL 11 (1922) 37-MM GUN³

a. General

The Model 11 (1922) 37-mm gun (figs. 119 and 120) is now obsolete, but is still used in some areas. It is

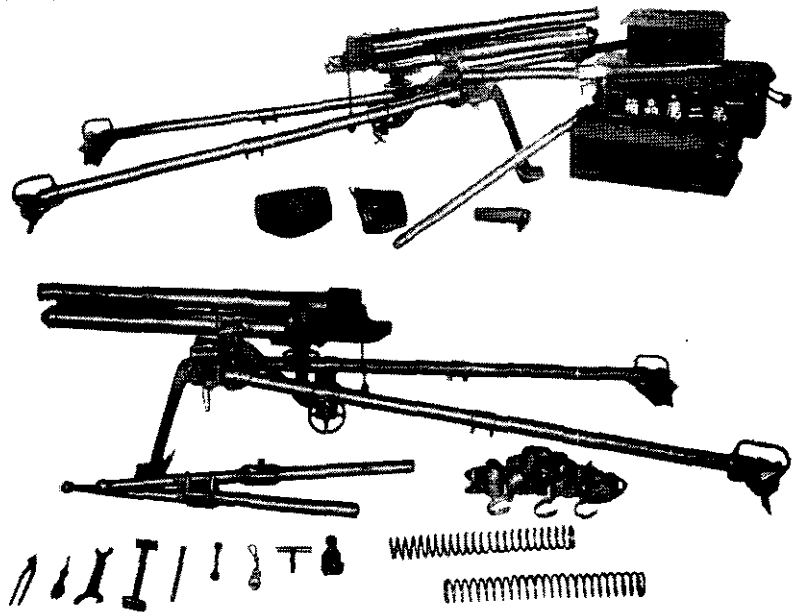

Figure 119.—Two views of Model 11 (1922) 37-mm gun, showing accessories.

similar to the U. S. 37-mm gun, M1916. It can be carried by its normal crew of four men (fig. 121).

³ This weapon is listed by the Japanese as 十一年式平射歩兵砲, which is read (from left to right) *Juichinen Shiki Heisha Hoheiho*, meaning "11th year model low-trajectory infantry gun." (See p. 7, note 1.) The

Japanese tactical symbol for the 37-mm gun is 六.



Figure 120.—Model 11 (1922) 37-mm gun in action.

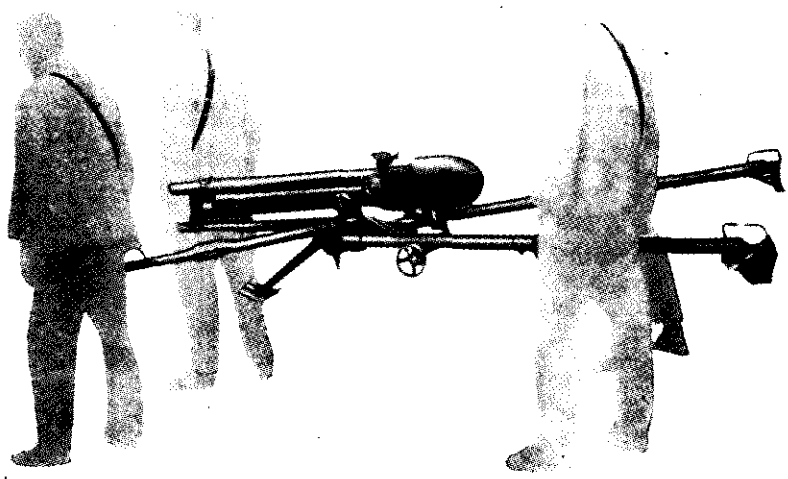

Figure 121.—Method of carrying Model 11 (1922) 37-mm gun by hand.

b. How to Identify

The Model 11 (1922) 37-mm gun is easily identified by its very short barrel, tubular steel trails, and a front leg and a front-leg float.

c. Characteristics

(1) *General.*—The barrel and breech of the Model 11 (1922) 37-mm gun form one integral part (fig. 122). The breech has a vertical sliding-wedge breechblock which can be operated either manually or automatically. The standard sighting device on this weapon is a simple telescopic sight (fig. 123).

(2) *Table of characteristics.*—

Length (with trails folded).....	90 inches.
Over-all width (firing position).....	49.25 inches.
Weight in action.....	205.75 pounds.
Traverse.....	584 mils (33 degrees).
Elevation:	
Maximum.....	248 mils (14 degrees).
Minimum.....	-85 mils (-4.8 degrees).

d. How to Operate

(1) *Safety.*—The safety feature of the Model 11 (1922) 37-mm gun is the locking mechanism, which fits into a cavity in the rear face of the breechblock and holds it closed regardless of the motion of the barrel. When this lock is pushed in, the breechblock is locked.

(2) *To set-in.*—By inserting two handspikes in recesses found in front of the front leg, two men can move the gun about in its firing position. One man lifts the front end of the weapon while the other lifts the trails by means of the handgrips on the trails. This procedure is very useful in combat, be-

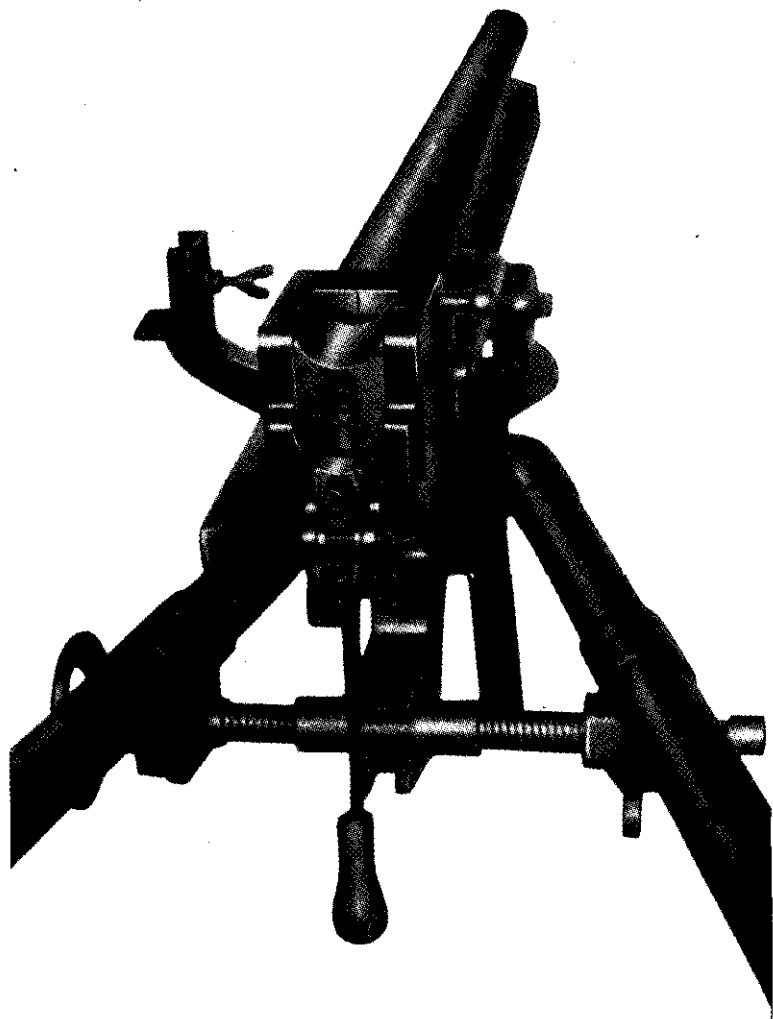

Figure 122.—Close-up of breech of Model 11 (1922) 37-mm gun.

cause the position of the gun can thus be changed without loss of time.

(3) *To elevate.*—The elevating handwheel is directly beneath the cradle of the gun. It may be locked with a locking nut over the frame which the elevating screw rides.

(4) *To traverse.*—The traversing handwheel is to the left of the left trail.

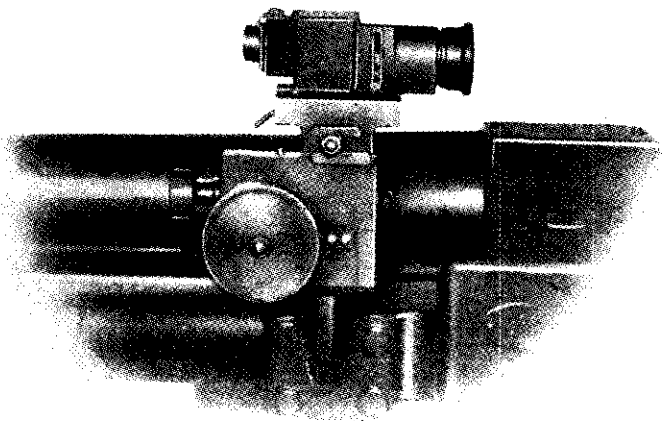

Figure 123.—Telescopic sight mounted on Model 11 (1922) 37-mm gun.

(5) *To load and fire.*—Insert a round in the chamber; the base of the cartridge case trips the extractors and the breech is automatically closed. Attach and pull a lanyard on the firing mechanism.

In order to have automatic operation of the breechblock, pull the locking mechanism out and pivot the breechblock operating cam to its upper position. (The breechblock operating cam is to the left of the lower

face of the breechblock.) Then as the shell case is ejected, the breech opens and stays open, locked by the extractors.

To operate the breechblock by hand, push in the locking mechanism and pivot the operating cam to its lower position (fig. 124). The breech stays closed and cannot be opened again until the locking mechanism is pulled out and the breechblock opened manually with the operating handle.

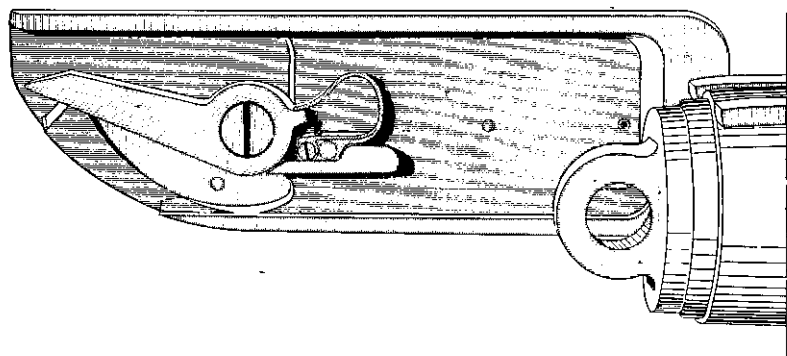

Figure 124.—Breechblock operating cam of Model 11 (1922) 37-mm gun in lower, or nonautomatic, position.

(6) *To unload.*—If a misfire occurs, wait a few minutes before attempting to unload. Then slowly open the breech and catch the round as it is forced out of the chamber.

e. Ammunition

Adequate information is not available on the ammunition used in this weapon.

f. Maintenance

(1) *Oiling and cleaning.*—The Model 11 (1922) 37-mm gun may be given the same general care as is given to U. S. guns.

(2) *Stripping.*—(a) *Barrel.*—Uncouple the barrel from the recoil mechanism, and slide the barrel to the rear.

(b) *Breech.*—Push the barrel to the rear so that the breech recess is behind the shoulder guard. Remove the operating handle, and withdraw the closing-spring rod from the closing-spring cylinder, which is to the right of the breech. Move the extractors forward in order to be able to lift the breechblock up and out of the breech recess.

(3) *Recoil mechanism.*—The recoil piston rod is attached to the barrel. When the gun recoils, the recoil cylinder remains stationary and the piston moves with the barrel. The recoil piston rod is hollow. For filling the system with recoil fluid, a hole is provided on the piston head.

(4) *Assembly.*—To assemble the weapon, proceed in the reverse order to that followed in stripping.

35. MODEL 94 (1934) 37-MM GUN⁴

a. General

The Model 94 (1934) 37-mm gun (fig. 125) is an infantry close-support gun and can be used both as

⁴This weapon, commonly called *Sanjunana Miri Ho*, is listed by the Japanese as 九四式三十七耗砲, which is read (from left to right) *Kyūyon Shiki Sanjunana Miri Ho*, meaning "94 model 37-mm gun." (See p. 7, note 1.) The Japanese tactical symbol for the 37-mm gun is .

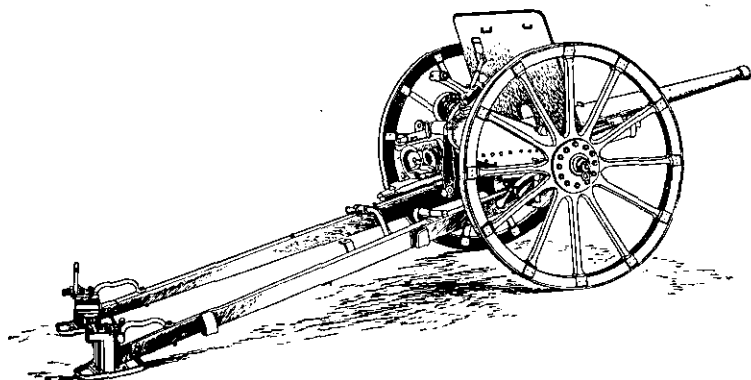

Figure 125.—Model 94 (1934) 37-mm gun (right side).

an antitank and as an antipersonnel weapon. The ammunition used in the gun is armor-piercing, high-explosive, and shrapnel.

b. How to Identify

The Model 94 (1934) 37-mm gun may be identified by—

- (1) The long, slender barrel.
- (2) The low mount.
- (3) The spade brackets on the trails (fig. 126).

(4) The marking 砲九四式三七七九 which is on the barrel. (This marking, which is read *Kyuyon Shiki Sanjunana Miri Ho* from right to left, means “94 model 37-mm gun.”)

c. Characteristics

(1) *General.*—The barrel and breech of the Model 94 (1934) 37-mm gun form one integral part, like that of the Model 11 (1922) 37-mm gun (par. 34, p. 188).

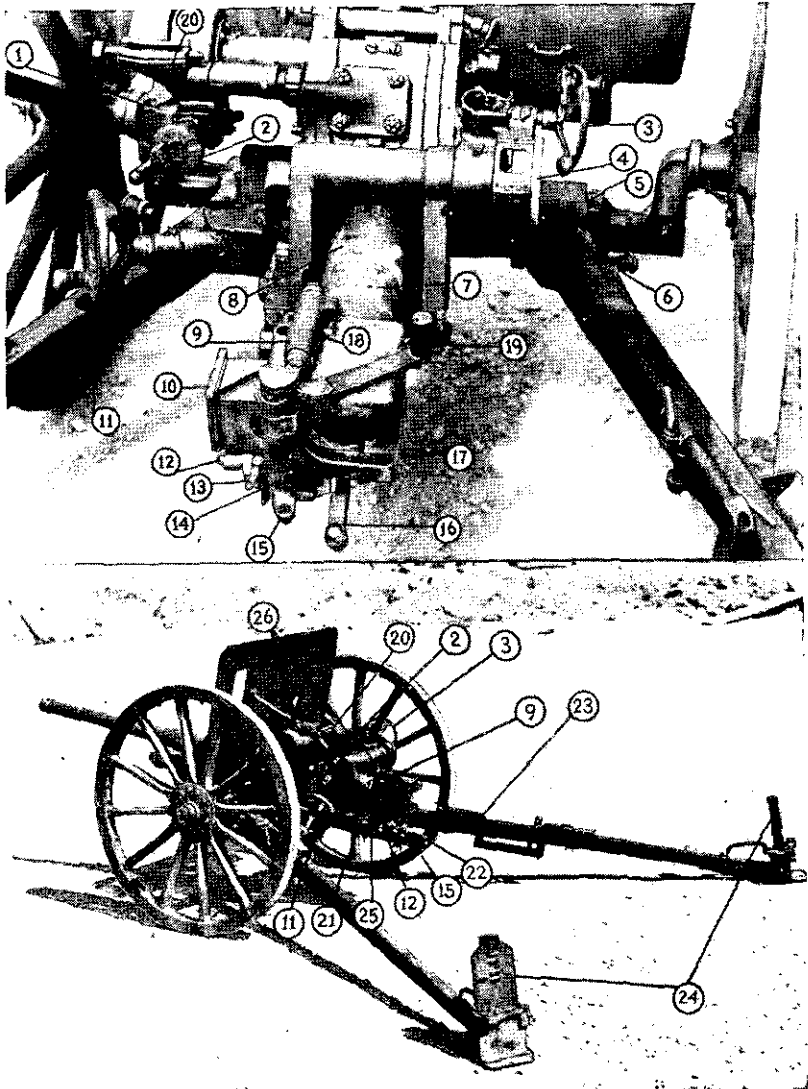

Figure 126.—Two views of Model 94 (1934) 37-mm gun, showing parts.

(Key on opposite page)

The breechblock is a horizontal sliding wedge. When a round is fired, the breech is cammed open and the cartridge case extracted automatically. The breech, however, remains open when the gun returns to battery, that is, moves forward again. When another round is inserted in the chamber, the breech closes automatically. It slams shut when the rim of the cartridge case trips the lips of two extractors which lie in a recess next to the chamber.

The gun may be transported with its trails closed, locked with a yoke. Extensions are attached to the trail connecting it to the pack saddle of the animal drawing the gun.

The ends of the trails are provided with handgrips for manhandling. Steel disk wheels with steel rims are usually provided. In difficult terrain, larger wooden-spoke wheels with steel rims are used to give additional ground clearance.

(Key to fig. 126)

- | | |
|--|---|
| 1. Left-wheel positioning latch. | 14. Hammer safety. |
| 2. Angle-of-site handwheel and trigger actuator. | 15. Breechblock-opening cam. |
| 3. Elevating handwheel. | 16. Hammer. |
| 4. Range drum. | 17. Breech ring. |
| 5. Equalizer bar. | 18. Breech-opening-mechanism spring lock. |
| 6. Trail detaching handle. | 19. Operating handle. |
| 7. Markings on tube. | 20. Sight base and rack. |
| 8. Tube. | 21. Firing knob. |
| 9. Breech-closing mechanism housing. | 22. Breechblock-opening cam guide. |
| 10. Breechblock. | 23. Trail traveling locking bar. |
| 11. Traversing handwheel. | 24. Spades. |
| 12. Trigger arm. | 25. Firing-knob lock. |
| 13. Trigger-arm safety. | 26. Shield-brace-attachment latches. |

The left wheel may be pivoted outward vertically to allow more operating space for the gunner.

(2) *Table of characteristics.*—

Length:

Barrel.....	66.5 inches.
Over-all in traveling position.....	114 inches.
Over-all with trail extension.....	174 inches.

Width:

Over-all.....	47 inches.
Over-all with trails open.....	96 inches.

Total weight in action..... 714 pounds.

Thickness of shield armor..... 0.2 mm (.787 inch).

Traverse..... 1,062 mils (60 degrees).

Elevation:

Maximum..... 480 mils (27 degrees).

Minimum..... -124 mils (-7 degrees).

Range:

Effective..... 2,500 yards.

Maximum..... 5,000 yards.

Muzzle velocity (armor-piercing round)... 2,300 feet per second

Rate of fire..... 10 to 20 rounds per minute.

Length of recoil..... 6 to 8 inches.

d. How to Operate

(1) *Safety.*—There are three safety features on the Model 94 (1934) 37-mm gun. They are—

(a) The safety lock located on the lower left portion of the breech face. When this lock is turned to a horizontal position, the firing mechanism will lock and the breechblock cannot be opened. When the lock is in the vertical position, the weapon can be fired.

(b) The breechblock operating-handle latch, which engages in a recess on the top of the breech and locks the operating handle to keep it from obstructing the semiautomatic operation of the breech during firing. The operating handle must be forced down in order to disengage the latch.

(c) The safety lock, which is located to the right of the firing knob, obstructing the front-to-rear movement of the firing knob. The weapon cannot be fired by pulling the knob to the rear.

(2) *To sight.*—The gun is laid-in by two distinct and independent elevating mechanisms. One is the handwheel, which contains the firing knob—this is to the left above and forward of the breech. It moves the telescope and the barrel. The other is the elevating handwheel, which moves the barrel only—this is to the right and forward of the breech.

The movement of the elevating handwheel operates the range drum. The range drum has three scales. The left scale is graduated from 0 to 30, and is marked for armor-piercing shells. The center scale is graduated from 0 to 40, and is marked for high-explosive shells. The right scale is graduated from 0 to 50, and is marked for shrapnel ammunition.

(3) *To traverse.*—Traversing is accomplished by the traversing handwheel at the left of the breech. Traverse to the right is accomplished by rotating the handwheel clockwise; to the left, counterclockwise.

(4) *To load and fire.*—Insert a round in the chamber. The breech is automatically closed when the shell case forces in against the extractors. In order

to fire the weapon, pull the firing knob outward to the rear.

(5) *To set-in the trails.*—At the end of the trails are spade brackets which enable the spades to be locked in three positions; two for firing (hard or soft ground), and one for traveling.

(6) *Gun crew.*—The Model 94 (1934) 37-mm gun can be handled by a five-man crew. This is set up as follows:

- (a) Chief of section.
- (b) Gunner.
- (c) No. 1 (gunner's assistant).
- (d) No. 2 (ammunition carrier).
- (e) No. 3 (ammunition carrier).

For direct firing, only one man is required to control the aiming, elevating, and traversing mechanisms, assisted by a loader. But for indirect firing, a second man is needed to operate the range drum.

(7) *To unload.*—If a misfire occurs, wait a few minutes before attempting to unload. The gun may be unloaded by slowly opening the breech and catching the round as it is forced out by the extractors.

e. Ammunition

The Model 94 (1934) 37-mm gun has three types of ammunition—armor-piercing, high-explosive, and shrapnel (fig. 127).

Specifications for the high-explosive round (fig. 128) are as follows:

Length of complete round.....	11.28 inches.
Weight of complete round.....	2.70 pounds.

Diameter of round at base of cartridge case.....	21.36 inches.
Length of projectile.....	4.98 inches.
Weight of projectile.....	25.05 ounces.
Weight of propellant.....	4.32 ounces.

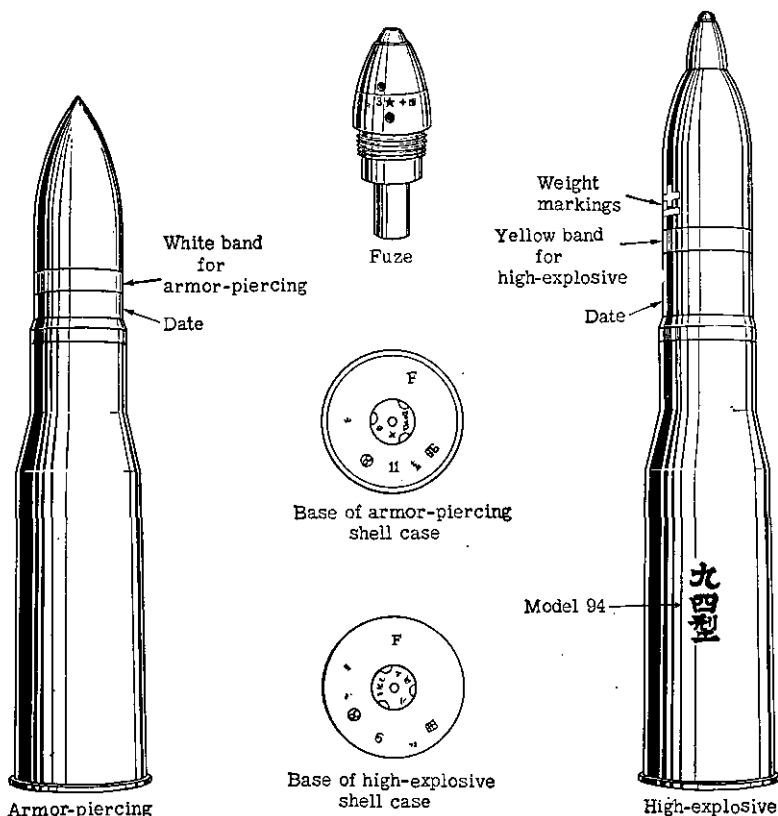

Figure 127.—Armor-piercing (left) and high-explosive (right) shells for Model 94 (1934) 37-mm gun.

The HE round is provided with a small, short-delay nose fuze (fig. 129). The radius of burst of the high-explosive shell is not large and, consequently, not con-

sidered dangerous except at the point of impact or in a small enclosure directly penetrated.

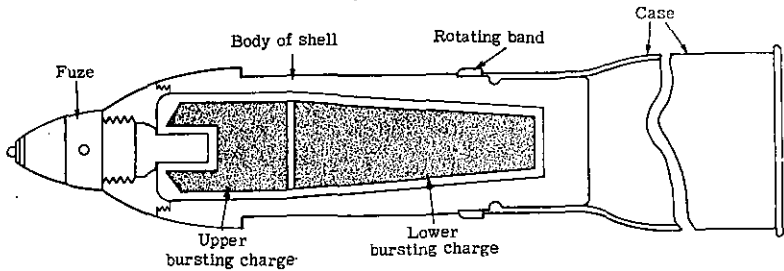

Figure 128.—Cross section of Model 94 (1934) high-explosive shell.

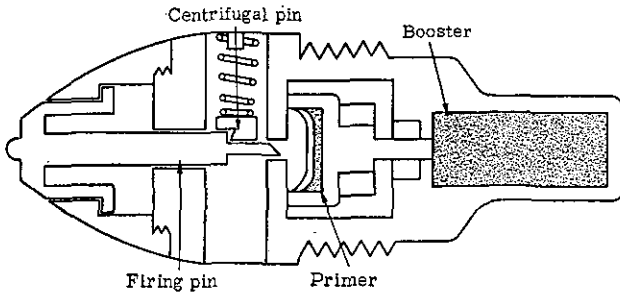

Figure 129.—Cross section of small instantaneous nose fuze used in Model 94 (1934) high-explosive shell.

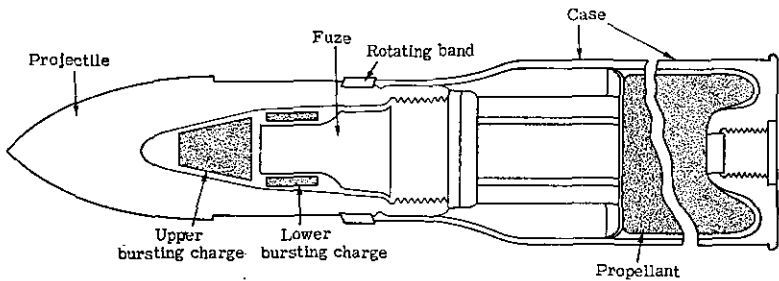

Figure 130.—Cross section of Model 94 (1934) armor-piercing shell.

The armor-piercing projectile (fig. 130) can penetrate 1.32 inches of armor plate in a direct hit at 1,000

yards, or 0.96 inch if the shot hits at a 30-degree angle. A base fuze (fig. 131) is used with the armor-piercing projectile.

f. Maintenance

(1) *Oiling and cleaning.*—The Model 94 (1934) 37-mm gun may be given the same general care as U. S. guns. Where lubricating oils and greases are required, use the same lubricants as would be used for similar moving parts on U. S. weapons.

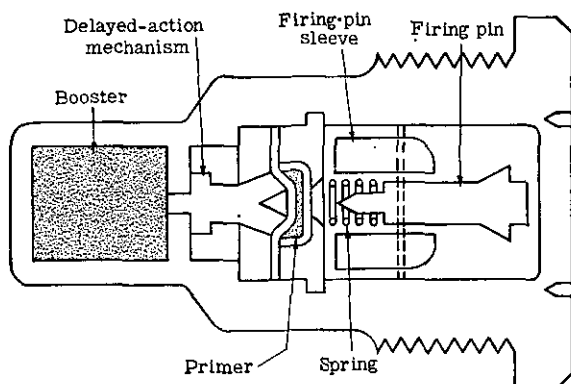

Figure 131.—Cross section of base fuze used in Model 94 (1934) armor-piercing shell.

(2) *Stripping.*—(a) *Barrel.*—In order to remove the barrel from the gun, uncouple it from the recoil mechanism by releasing a coupler pin located on the lower right of the breech ring; this pin can be unlocked with a quarter turn to the right. Then slide the barrel to the rear.

(b) *Breech.*—Close the breech to release the tension on the breechblock operating plunger (a small cylinder

on top of the breech). Then the spring and plunger can be removed.

When the breech ring and the breechblock operating shaft are lined up, the operating shaft can be disengaged from the slots of the breech ring and lifted out.

The removal of the extractor shaft (on the left side of the breech ring) permits the removal of the breechblock to the left.

(c) *Firing mechanism.*—Compress and rotate the firing-pin housing, located in the center of the breech, and remove it from the breech. Then unscrew the firing-pin housing and its integral parts.

(d) *Recoil mechanism.*—The recoil system of the gun is hydrospring. The fluid content of the cylinders is about $1\frac{1}{8}$ pints. When the gun goes into recoil, the braking at the end of that phase is accomplished by a compression of two coil springs, which then restore the energy to bring the gun back to battery again. Buffering action, which eases the gun into battery at the end of the recoil cycle, is effected by throttling the recoil fluid past a valve on the buffer rod. In firing, the recoil cylinder and buffer rod remain stationary, while the piston rod, which is coupled to the barrel, moves to the rear.

After a period of firing, the recoil fluid, a glycerine-water solution, may heat and expand, causing the gun to hang out of battery. In such a case, enough liquid should be drained from the cylinders to allow the gun to return to battery. Insufficient liquid in the recoil mechanism will cause the gun to slam into battery.

In order to get access to the filling hole of the recoil mechanism, first remove the barrel of the gun, and then the recoil mechanism from the cradle. Remove the buffer-cap nut on the forward end of the

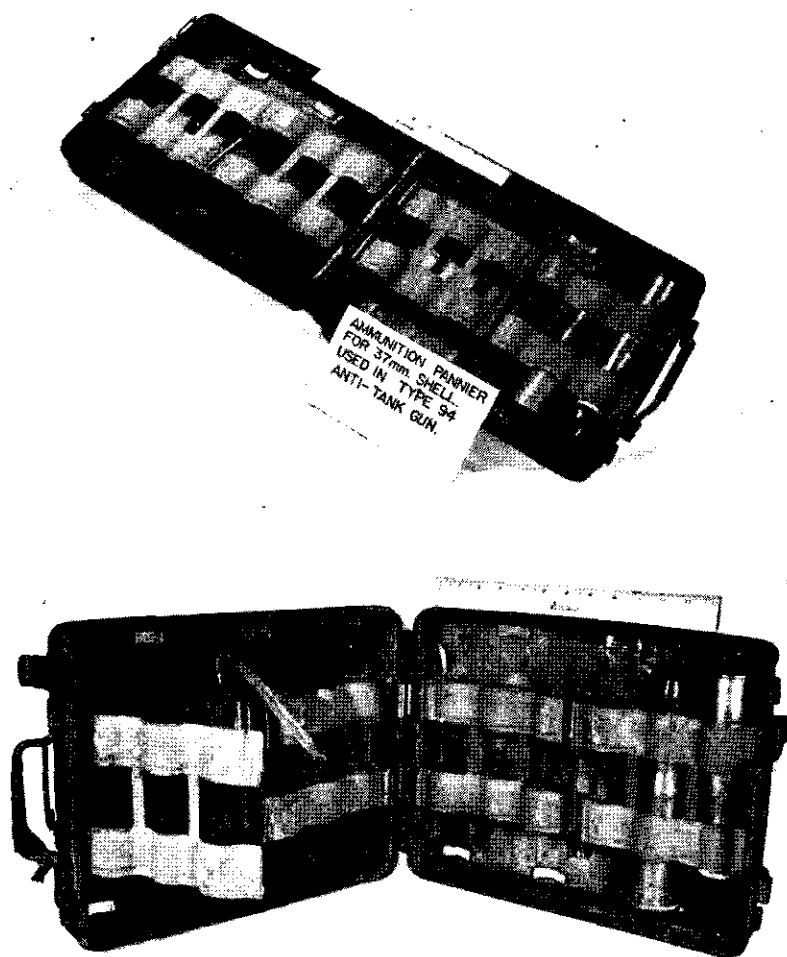

Figure 132.—Two views of metal carrying case for 37-mm shells used in Model 94 (1934) 37-mm gun (12 complete rounds).

recoil mechanism, and the front cap on the recoil-cylinder head. The filling plug of the piston will protrude past the forward end of the cylinder, if the coupler is unscrewed.

If the cylinder is to be replenished with fluid, the front end of the recoil mechanism should be elevated before the filling plug is removed.

(3) *Assembly*.—To assemble the weapon, proceed in the reverse order to that followed in stripping.

g. Accessories

The ammunition for the Model 94 (1934) 37-mm gun is carried in a horse-drawn caisson containing 6 to 8 cases of ammunition, 12 rounds to a case (fig. 132).

The gun is also equipped with trail extensions for transportation by horse.

36. MODEL 1 (1941) 47-MM GUN⁵

a. General

The Model 1 (1941) 47-mm gun (figs. 133 and 134) is a new gun of modern design. It is an antitank and antipersonnel weapon.⁶

b. How to Identify

The Model 1 (1941) 47-mm gun may be identified by—

- (1) The long barrel, reinforced at the muzzle.

⁵This weapon is listed by the Japanese as 一式四十七糎携動砲, which is read (from left to right) *Ichī Shiki Yonjuana Miri Kidōhō*, meaning "1 model 47-mm mobile gun." (See p. 7, note 1.)

⁶In general, this piece resembles the later models of the ZIK 45-mm Russian antitank gun; both are developments of the original German *Rheinmetall* designs.

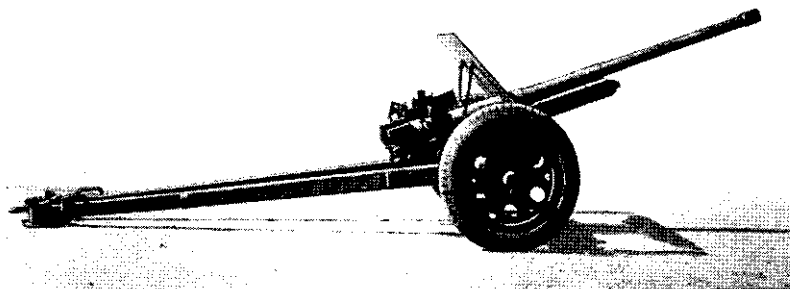

Figure 133.—Model 1 (1941) 47-mm gun (right side).



Figure 134.—Model 1 (1941) 47-mm gun (front view).

- (2) The exceptionally long trails.
- (3) The rubber tires.
- (4) The marking 砲七十四動機式一 which is above the breech. (This marking, which is read *Ichi Shiki Kido Yonjunana Miri Ho* from right to left,⁷ means "1 model mobile 47-mm gun.")

c. Characteristics

The Model 1 (1941) 47-mm gun has a long barrel with a jacket and a hoop, and is heavily reinforced at the muzzle. The breechlock is a horizontal sliding wedge, hand or semiautomatic in operation (fig. 135).

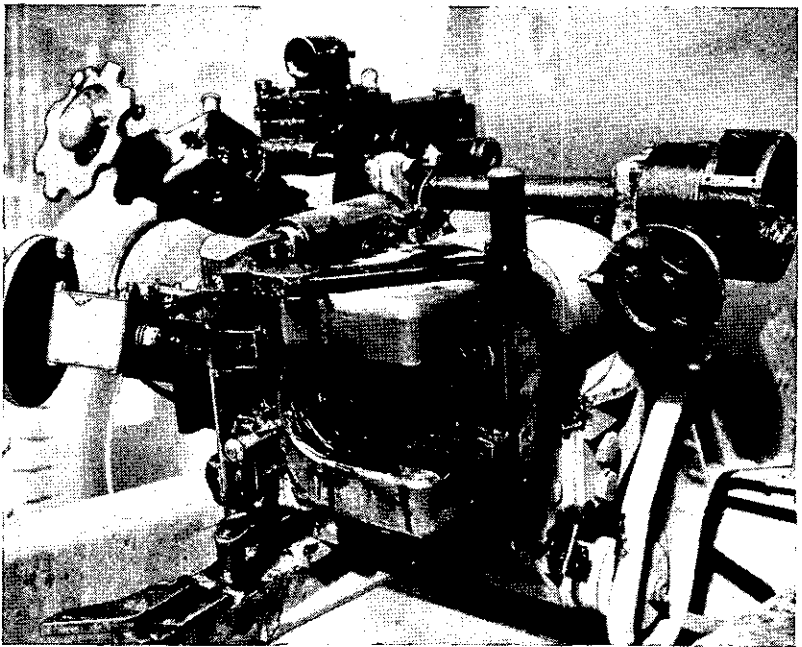

Figure 135.—Close-up of breech of Model 1 (1941) 47-mm gun.

⁷ See p. 7, note 1.

The gun is transported with the trails closed, locked with a yoke. This gun is adapted for motor transport only. Its great length and low clearance make it difficult to manhandle except on exceptionally favorable terrain. A wide shield, cut away at the bottom, is provided. Perforated steel disk wheels are fitted with rubber tires. The tread is wide, but ground clearance is low.

The low silhouette, wide tread, and long trails should give this gun excellent stability. Preliminary tests indicate a muzzle velocity of 2,700 feet per second.

d. How to Operate

All of the details on the operation of this gun are not known. It is believed, however, that it may be operated in the same manner as the Model 94 (1934) 37-mm gun (par. 35, p. 194).

e. Ammunition

The rimmed armor-piercing-high-explosive round has a brass case. It is of comparatively large diameter, necked down to take the 47-mm projectile. The projectile has a red tip, a black body, and a white band just in front of the copper rotating band. Specifications for the round are as follows:

Length of complete round.....	15.54 inches.
Weight of complete round.....	6 pounds 6.4 ounces.
Maximum diameter of case.....	2.55 inches.
Length of case.....	11.09 inches
Length of projectile.....	4.45 inches.
Weight of projectile.....	3 pounds 6.4 ounces.
Weight of propellant.....	13.94 ounces.

A simple high-explosive round is also reported to be available for use in this weapon.

37. MODEL 92 (1932) 70-MM HOWITZER (BATTALION GUN)⁸

a. General

The Model 92 (1932) 70-mm howitzer (battalion gun) (fig. 136) is an infantry-support howitzer. It is

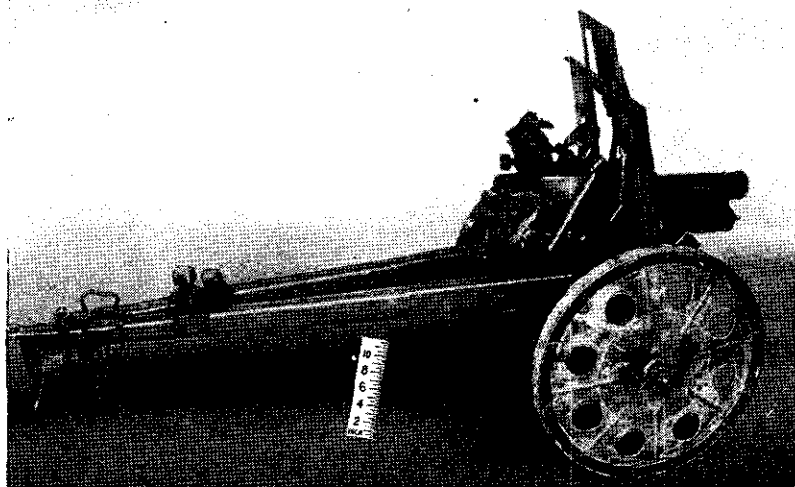

Figure 136.—Model 92 (1932) 70-mm howitzer with trails closed.

a horse-drawn piece, but can be handled by a 10-man section according to Japanese requirements. Despite its clumsy appearance, it has proved to be an effective weapon.

⁸This weapon is listed by the Japanese as 九二式歩兵砲, which is read (from left to right) *Kyuni Shiki Hoheiho*, meaning "92 model infantry gun." * The Japanese tactical symbol for the 70-mm howitzer is 火.

b. How to Identify

The Model 92 (1932) 70-mm howitzer may be identified by—

- (1) The low mount.
- (2) The extremely short barrel.
- (3) A sliding plate on the shield.

(4) The marking 砲兵歩式二九 which is on the rear end of the barrel. (This marking, which is read *Kyuni Shiki Hoheiho* (from right to left), means "92 model infantry gun.")

c. Characteristics

(1) *General.*—The Model 92 (1932) 70-mm howitzer has a rifled barrel approximately 9 calibers long. The

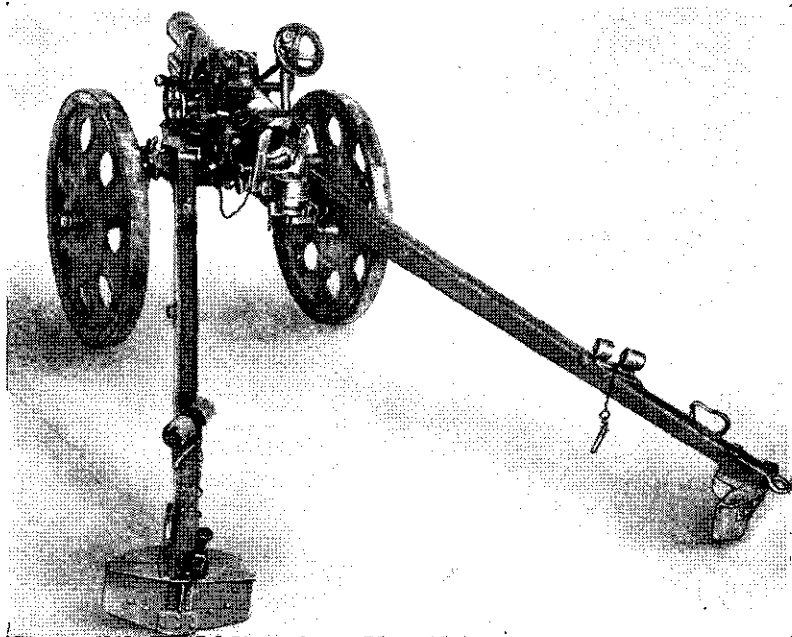

Figure 137.—Model 92 (1932) 70-mm howitzer with breech and trails open.

barrel, breech ring, and top sleigh are all of one forging. The breechblock is the interrupted-thread, swing-down type (fig. 137). Extraction is accomplished when the breech is opened after firing.

The carriage has a split trail (fig. 138) and is of welded construction, except where the spades are riveted on. The trails lock together for traveling and

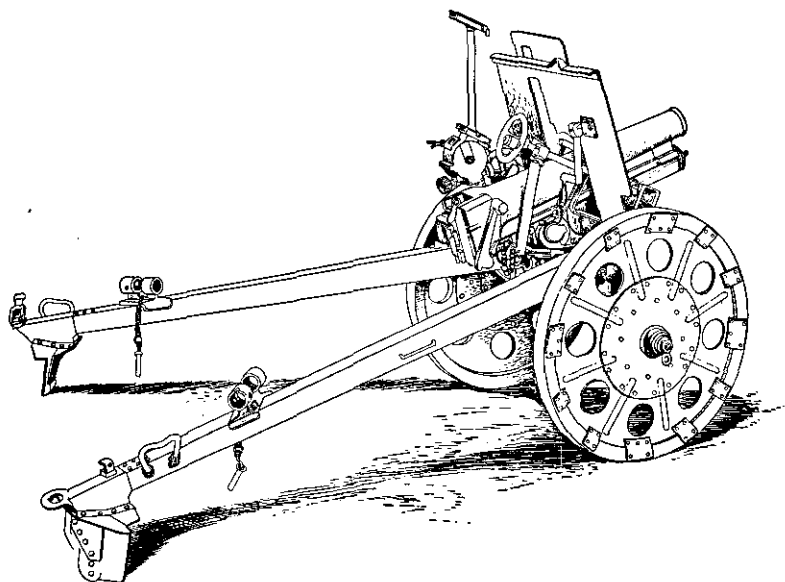

Figure 138.—Model 92 (1932) 70-mm howitzer with trails open.

have two extension attachments for horse transportation. The wheels are steel disks with steel rims. There is a shield plate which rests on top of the barrel and slides up and down with the movement of the barrel.

(2) *Table of characteristics.*—

Over-all length with trails folded..	87 inches.
Over-all width.....	36 inches.

Total weight in action.....	468 pounds.
Thickness of shield armor.....	0.156 inch.
Traverse	1,600 mils (90 degrees).
Elevation:	
Maximum.....	889 mils (50 degrees).
Minimum.....	-178 mils (-10 degrees).
Range:	
Effective	1,500 yards.
Maximum.....	3,000 yards.
Rate of fire.....	10 rounds per minute.
Length of recoil.....	4 to 6 inches.

d. How to Operate

(1) *Safety*.—There are two important safety features on the Model 92 (1932) 70-mm howitzer:

(a) The safety lock, which is found to the right of the firing mechanism on the breech carrier, when in the “up” position prevents the weapon from being fired and the breechblock from being opened.

(b) The breechblock operating-handle latch, which prevents the breechblock from coming open during firing, and must be depressed when operating the breech by hand. (A third safety feature should also be noted: the piece cannot be fired unless the breech is fully closed.)

(2) *Sight*.—The Model 92 (1932) 70-mm howitzer uses the same panoramic sight (fig. 139) as the field-artillery weapons. The mount of the sight is on the left side of the piece. The sight bracket includes a range drum, an elevating bubble, and a cross-leveling bubble for correcting for differences in level of the wheels. There are four strips on the range drum, numbered I, II, III, and IV, corresponding to powder charges 1, 2, 3, and 4. When the strip which is selected ac-

ording to the number of the charge is pulled back, it will reveal the proper range scale for that charge.

(3) *Gun crew*.—It is possible that a smaller crew than the 10 men called for by the Japanese table of

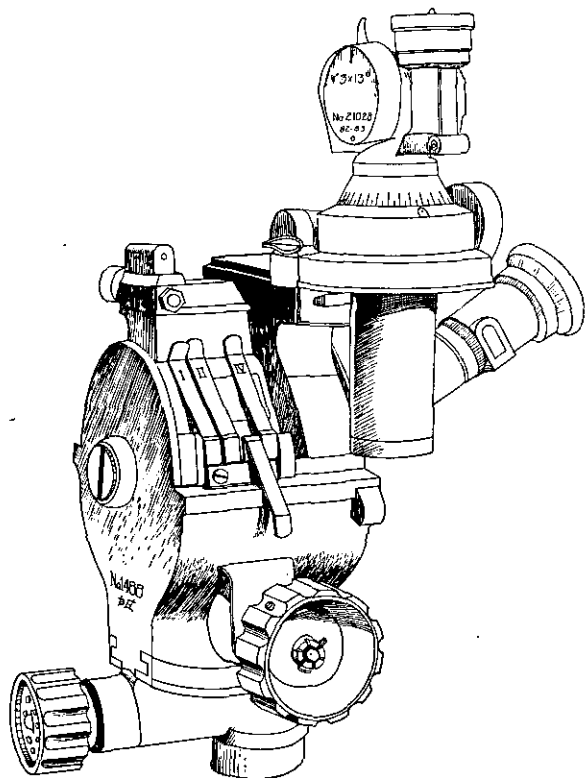

Figure 139.—Panoramic artillery sight.

organization could handle the Model 92 (1932) 70-mm howitzer (fig. 140). Five men could be assigned as follows:

- (a) Chief of section.
- (b) Gunner.



Figure 140.—Model 92 (1932) 70-mm howitzer (battalion gun) in action.

(c) No. 1 (gunner's assistant).

(d) No. 2 (ammunition carrier).

(e) No. 3 (ammunition carrier).

(4) *To elevate.*—Elevation of the Model 92 (1932) 70-mm howitzer is accomplished by turning the elevating handwheel on the right of the carriage clockwise; depression, by turning it counterclockwise.

(5) *To traverse.*—The traversing handwheel is located on the left side of the upper carriage. Turn the handwheel clockwise to traverse to the right, and counterclockwise to traverse to the left.

(6) *To load and fire.*—To fire the Model 92 (1932) 70-mm howitzer, open the breechblock with force and

insert a round of ammunition in the chamber. Then close the breech, adjust the safety lock to the "up," or "safe," position, and attach a lanyard. When ready to fire, release the safety lock and pull the lanyard.

(7) *To unload.*—If a misfire occurs, wait a few minutes before attempting to unload. Then slowly open the breech and catch the round as it is forced out of the chamber.

e. Ammunition

The ammunition used in the Model 92 (1932) 70-mm howitzer is semifixed with a brass, or brass-plated steel, case (fig. 141). High-explosive, shrapnel, and smoke shells are used. The weight of the high-explosive shell is 8.36 pounds, and the danger area of its burst is 40 yards radially.

The propelling charge is made up of an igniter pad, a base charge, and three increments. The maximum and minimum ranges for each of these charges are as follows:

Charge	Maximum range	Minimum range (0 elevation)
Complete.....	3,075 yards.....	1,100 yards.
Remove No. 1 only (19 grams) ...	1,975 yards.....	660 yards.
Remove Nos. 1 and 2 (9 grams)...	1,300 yards.....	225 yards.
Remove Nos. 1,2, and 3 (5 grams) ¹ ..	985 yards.....	110 yards.

¹ This leaves the igniter pad and base charge in place.

Instantaneous or delay fuzes are used. Both are designated Model 88 and are used also in the ammunition for the Model 41 (1908) 75-mm mountain gun. (See par. 38e (4), p. 227, and fig. 149, p. 228.)



Figure 141.—70-mm high-explosive shell for Model 92 (1932)
70-mm howitzer.

The high-explosive shell is approximately $9\frac{1}{4}$ inches long and is filled with an ammonium-nitrate explosive. The body of the shell is painted black, with a yellow band above the rotating band and a red band around the fuze adaptor.

f. Maintenance

(1) *Oiling and cleaning.*—The Model 92 (1932) 70-mm howitzer may be given the same general care as is given to U. S. weapons.

(2) *Stripping.*—(a) *Barrel.*—Uncouple the barrel from the recoil mechanism, set the elevation at zero, and slide the barrel to the rear.

(b) *Breech.*—Line up the assembly marks of the breechblock operating arm and remove the operating arm by pulling it outward. In order to remove the extractor from the breech recess, pull out the extractor shaft and spring. Rotate the breechblock out of its carrier.

(3) *Recoil mechanism.*—The recoil mechanism is housed in a cylinder in the cradle. It contains about three-fourths of a pint of a glycerine-water-solution recoil fluid. In firing, the recoil cylinder remains stationary while the piston rod moves with the barrel, for the barrel is attached to the piston rod by a coupler pin.

Too much fluid in the recoil mechanism will cause the piece to hang out of battery, while an insufficient amount of fluid will cause it to slam into battery. In order to remedy these two conditions, fluid must be added or drained according to the circumstance.

To get access to the filling hole, the shield must be removed, along with the barrel, and the sleigh and

recoil mechanism elevated about 40 degrees. After the cap nut on the end of the cylinder is removed along with the cylinder head, turn the piston-rod coupler in a counterclockwise direction until the recoil piston head protrudes slightly from the recoil cylinder. (The filling hole and plug are at the side of the recoil piston head.)

(4) *Assembly*.—To assemble the weapon, proceed in the reverse order to that followed in stripping.

g. Accessories

There is an ammunition caisson which accompanies the Model (1932) 70-mm howitzer. It carries three boxes of ammunition (fig. 142), as well as sights, tools

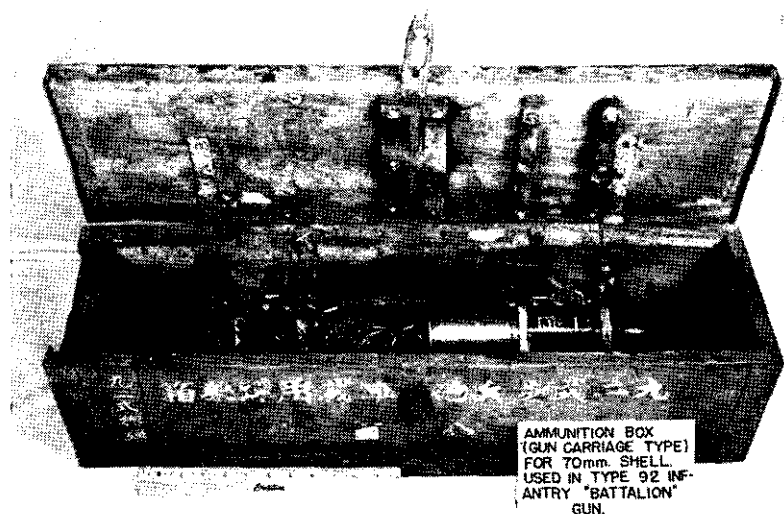

Figure 142.—Gun-carriage type of packing box for 70-mm high-explosive shells (eight complete rounds).

and other accessories (fig. 143); it is transported behind a horse in tandem with the howitzer.

There is also a 1-man steel ammunition case for carrying 5 complete rounds and 10 fuzes—5 instan-

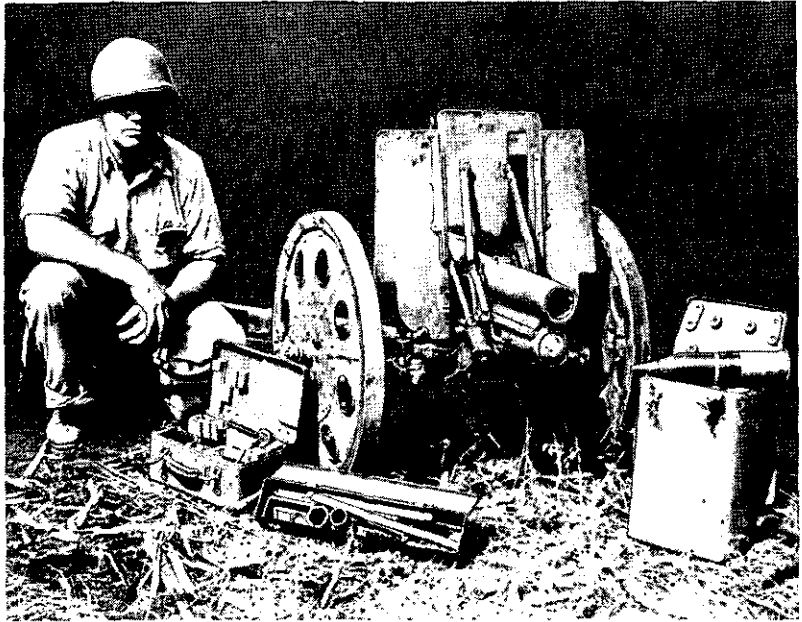

Figure 143.—Model 92 (1932) 70-mm howitzer captured on Guadalcanal. (The weapon is shown complete with accessories.)

taneous and 5 delayed-action (fig. 144)—and boxes holding 3 complete rounds (fig. 145).

A sight-mount carrying case and a box of tools, which contains brushes and cleaning equipment, accompany the weapon.



Figure 144.—Metal carrying case for 70-mm high-explosive shells (five complete rounds).



Figure 145.—Manner of packing 70-mm high-explosive shells (three complete rounds).

38. MODEL 41 (1908) 75-MM MOUNTAIN (INFANTRY) GUN⁹

a. General

The Model 41 (1908) 75-mm mountain (infantry) gun (fig. 146) was originally used as a field-artillery pack gun, but when it was largely superseded by the Model 94 (1934) 75-mm mountain (pack) gun, it was issued for use as an infantry regimental gun. This gun is widely distributed throughout the Japanese Army.

⁹This weapon is listed by the Japanese as 四一式山砲, which is read (from left to right) *Yonichi Shiki Sampo*, meaning "41 model mountain gun." The Japanese tactical symbol for the 75-mm mountain (infantry) gun is .

b. How to Identify

The Model 41 (1908) 75-mm mountain (infantry) gun may be identified by—

- (1) The modified box trail of tubular steel.
- (2) The short barrel (fig. 147).
- (3) The large, single-piece shield with sighting door.

c. Characteristics

(1) *General.*—The Model 41 (1908) 75-mm mountain (infantry) gun has an interrupted-thread, swing-type breechblock. The recoil mechanism is hydro-spring. There are no equalizers or equilibrators. The gun is mounted on a field carriage with steel-rimmed wooden wheels. The trail is of modified box type, of tubular steel—two parallel trails connected to a large,

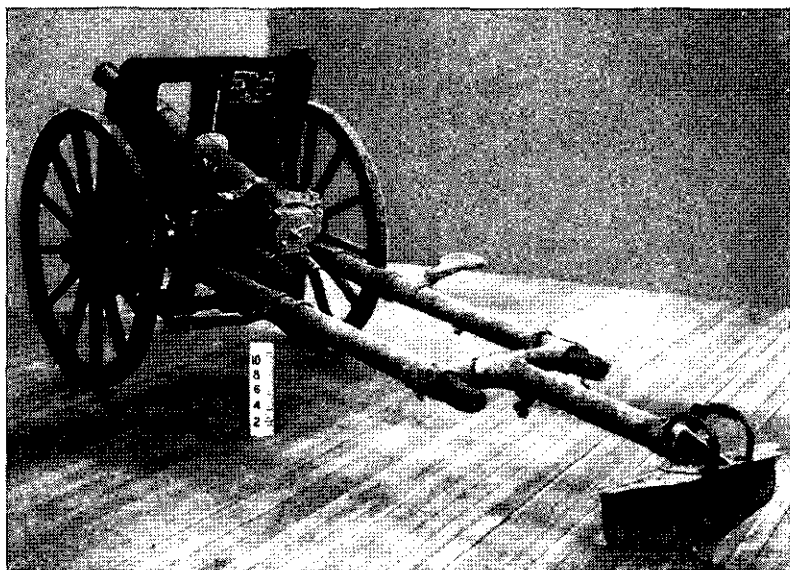

Figure 146.—Model 41 (1908) 75-mm mountain (infantry) gun.



Figure 147.—Gun crew of Model 41 (1908) 75-mm mountain (infantry) gun in action. (Note the method of moving the trail.)

single detachable spade. For transporting, the spade is removed and two shafts are attached so that the gun can be horse-drawn.

(2) *Table of characteristics.*—

Length of barrel.....	54½ inches.
Over-all length (with spade).....	170 inches.
Over-all width.....	48 inches.
Total weight.....	1,200 pounds.
Thickness of shield armor.....	0.167 inch.
Traverse	106 mils (6 degrees).
Elevation :	
Maximum.....	354 mils (20 degrees).
Minimum	-319 mils (-18 degrees).

Range:

Effective ----- 2,100 yards.

Maximum:

With long-pointed shell--- 7,675 yards.

With ordinary shell----- 6,575 yards.

Rate of fire----- 10 rounds per minute.

Length of recoil----- 17 to 20 inches.

d. How to Operate

(1) *Safety*.—There are three safety features on the Model 41 (1908) 75-mm mountain (infantry) gun:

(a) *Safety lock*.—The safety lock is found on the left of the rear plate of the breechblock. Push the safety-lock handle upward to lock the firing mechanism. An accidental pull on the lanyard will not fire the piece, nor will the breech be opened.

(b) *Breechblock operating-handle latch*.—When the breech is fully closed, the latch of the breechblock operating handle engages with a catch on the breechblock and locks the breech in the closed position for firing.

(c) *Rack lock*.—There is a rack lock which automatically prevents the breechblock from rotating during the hinged movement of opening and closing the breech.

(2) *To elevate*.—Elevation and depression are accomplished by operating the handwheel on the left side of the carriage. A clockwise turn will depress the gun, and a counterclockwise turn will elevate it.

(3) *To traverse*.—The traversing handwheel is to the right rear of the carriage. Turning it clockwise moves the gun to the right; counterclockwise, to the left.

(4) *To load and fire.*—Open the breechblock, insert a round in the chamber, and swing the breech closed. Then turn the handle of the safety lock upward. When ready to fire, release the safety lock and pull the lanyard.

When the breech is opened again by hand, the extractors will force out the empty shell case.

(5) *To unload.*—If a misfire occurs, wait a few minutes before attempting to unload. Then slowly open the breech and catch the round as it is forced out of the chamber by the extractors.

e. Ammunition

(1) *General.*—This gun fires two types of ammunition—high-explosive and armor-piercing.

(2) *High-explosive.*—The high-explosive ammunition is of the fixed type. The cartridge case is of brass, or brass-plated steel, 6.5 inches long. The propellant powder is nitrocellulose contained in a silk bag. The projectile is of standard construction except that picric acid is used in the booster. Cast TNT is used as the explosive. The projectile is painted black and may have either a single yellow band in the center of the projectile or a yellow band below the bourrelet and a white band above the rotating band. The difference in marking is not understood, but it is believed that the white band may indicate a spotting charge incorporated with the explosive.

(3) *Armor-piercing.*—The armor-piercing round (fig. 148) is shorter than the high-explosive round and is painted black with a white band below the bourrelet.

The round has a small explosive filling which is detonated (presumably after penetration of the target) by a base-detonating fuze.

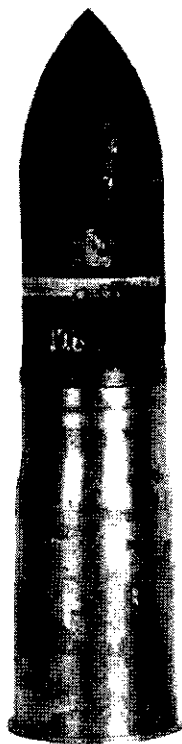

Figure 148.—75-mm armor-piercing round.

(4) *Fuzes*.—The fuzes used are the Model 88 instantaneous and Model 88 delayed-action (estimated delay, 0.05 second) (fig. 149). These same fuzes are used in the ammunition for the Model 92 (1932) 70-mm infantry howitzer (battalion gun) (par. 37e,

p. 216). The fuzes are packed separately from the rounds in sealed, rectangular tin boxes, 10 to a box. The tin boxes are packed in wooden boxes (26 by 12 by 5 inches), 10 to a box.

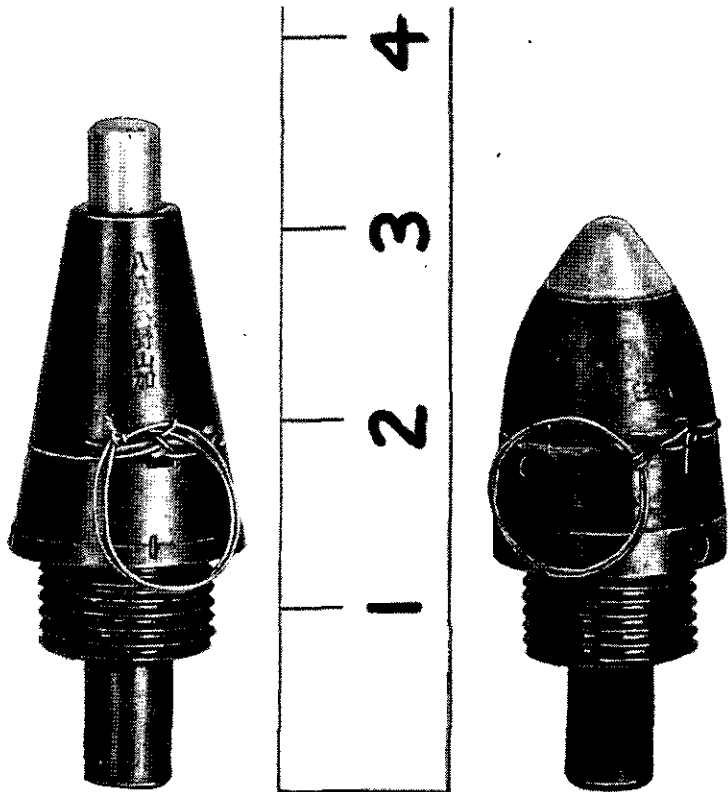

Figure 149.—Fuzes for 70- and 75-mm shells: instantaneous type (left) and delayed-action type (right).

The fuzes carry safety wires which must be removed before firing. So long as the wires are in place, the fuzes are safe for handling. When fired, they become armed

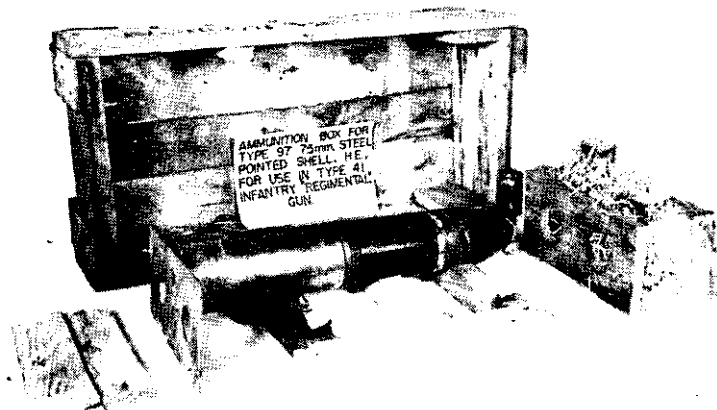

Figure 150.—Packing box for Model 97 (1937) 75-mm high-explosive shells (two complete rounds).

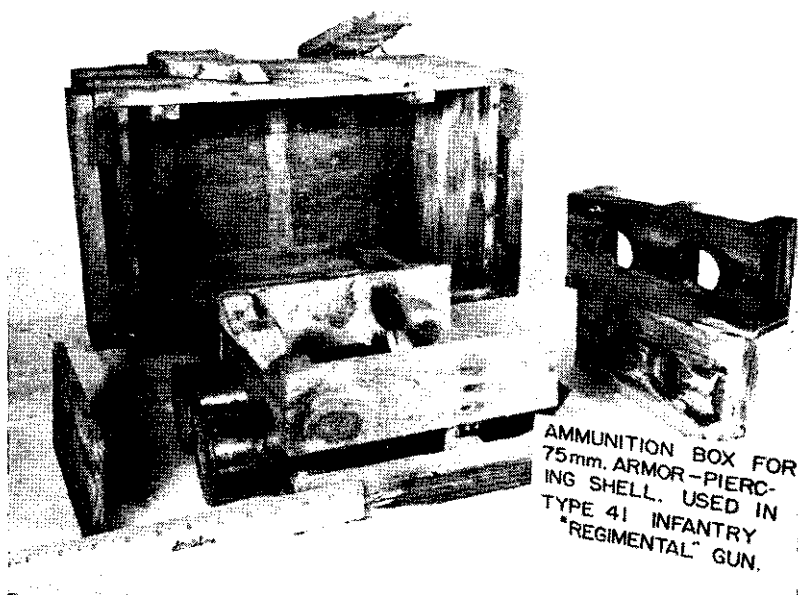

Figure 151.—Packing box for 75-mm armor-piercing shells (four complete rounds)

by setback and centrifugal force, and are actuated by impact. They have no bore-safe features.

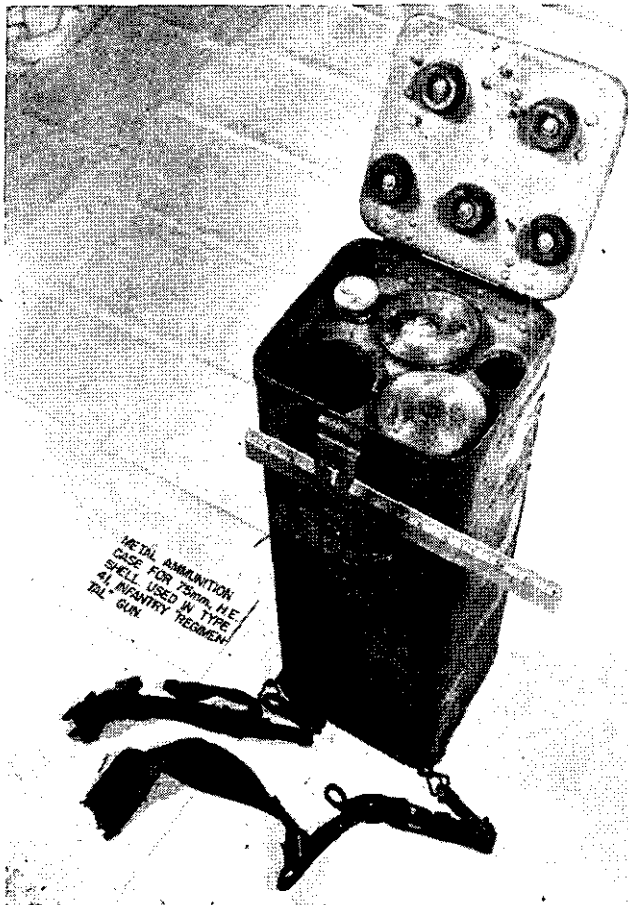

Figure 152.—Metal carrying case for 75-mm high-explosive shells (three complete rounds).

(5) *Packing.*—Ammunition is packed in 2- and 4-round wooden boxes (figs. 150 and 151) and in 3-

and 6-round heavy sheet-metal carrying cases (figs. 152 and 153).

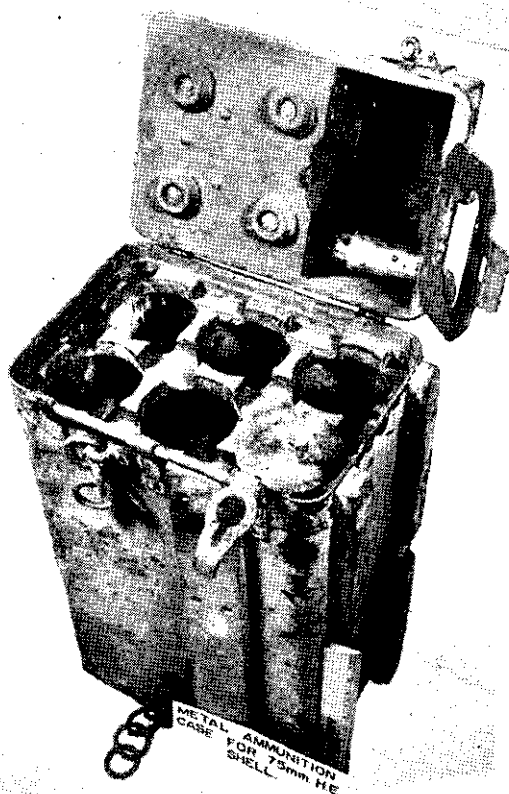

Figure 153.—Metal carrying case for 75-mm high-explosive shells (six complete rounds).

In the 2-round wooden boxes, fuzes for high-explosive rounds are provided. They are kept in metal cans cushioned in wood shavings. Fuzes for the

rounds in the 3-round metal carrying cases are in metal tubes fitted into the cases. The 6-round metal carrying case has a rectangular recess formed in the cover. Fuzes in individual metal tubes fit into this recess.

f. Maintenance

(1) *Oiling and cleaning.*—The gun may be given the same care as U. S. guns. Where lubricating oils and greases are needed, U. S. requirements for similar moving parts may be used.

(2) *Stripping.*—(a) *Barrel.*—Unlock the barrel locking band, and swing it open to the left. Then grasp the handle of the barrel locking band, and rotate the barrel one-eighth of a turn. Two men can then easily lift the barrel off the sleigh.

(b) *Breech.*—The operating-handle shaft may be removed by tapping it and pulling it out. Rotate the breechblock until the firing-mechanism safety lock is in line with the left-hand slot of the breechblock carrier (the part in which the breechblock is screwed). The safety lock can be slid out. Rotate the breechblock until it is in the closed position, and force the sear against its spring to release the trigger. Then remove the firing mechanism.

(3) *Recoil mechanism.*—The recoil mechanism is housed in the cradle. In recoil, the recoil cylinder remains stationary, while the piston rod moves to the rear with the barrel.

After the gun has been fired, the recoil fluid, a glycerine-water solution, may heat and expand, causing the gun to hang out of battery. In such a case, the liquid may be drained to allow the gun to return

to battery. Insufficient fluid causes the gun to slam back into battery too fast.

In order to get access to the filling holes—of which there are two, one in the front of the recoil mechanism, and one in the rear—first depress the weapon to -10 degrees. Then remove the front cover of the cradle. Remove the buffer-rod nut on one cylinder to get to the front filling hole, and remove the nut on the other to get to the rear filling hole.

Both the front and the rear filling holes should be used in refilling the recoil cylinders. Force the liquid into the front hole until it runs out the rear hole free of bubbles, indicating that there is no air present.

(4) *Assembly*.—To assemble the weapon, proceed in the reverse order to that followed in stripping.

Section IX. SMALL-ARMS AMMUNITION

39. INTRODUCTION

The primary purpose of this section is to describe the ammunition used in Japanese small arms (see the chart, fig. 156, p. 238. Since the employment of unidentified ammunition may be a danger to the user, all available information is included concerning the system by which the Japanese label and mark their ammunition. The Japanese do not mark individual rounds. The band color on the bullet, the shape of the round, and the composition of the bullet jacket are the only visual means of identifying the various types of rounds.

40. COLOR OF BANDS

It appears that the following significance may be attached to the colors of the bands used on Japanese small-arms ammunition:

Pink	-----	Ball.
Green	-----	Tracer.
Black	-----	Armor-piercing.

41. MODEL 38 (1905) 6.5-MM AMMUNITION

a. How to Identify

Model 38 (1905) 6.5-mm (.256 inch) ammunition may be identified by its size, by its semirimmed case, and by the label on the container in which it is found. These rounds are packed in wooden boxes; three 5-round clips are packed in separate pasteboard

containers. A colored band around the circumference of the bullet where it enters the neck of the cartridge case and a similarly colored circle on the upper left corner of box labels serve to indicate the character of the round (see par. 40).

b. Where to Use

This ammunition functions in the following weapons:

Model 38 (1905) 6.5-mm rifle.

Model 38 (1905) 6.5-mm carbine.

Model 44 (1911) 6.5-mm cavalry carbine.

It also functions in the following obsolescent weapons which are not described in this study:

Model 38 (1905) 6.5-mm heavy machine gun.

Model 3 (1914) 6.5-mm heavy machine gun.

42. MODEL 38 (1905) 6.5-MM REDUCED-CHARGE AMMUNITION

a. How to Identify

Model 38 (1905) 6.5-mm reduced-charge ammunition may be identified by its size, by its semirimmed case, and by the label on its container. This ammunition is difficult to distinguish from the standard Model 38 (1905) 6.5-mm ammunition. The Japanese appear to distinguish the reduced-charge round solely by means of the marking on the containers. The labels for the reduced-charge ammunition have a capital **G** in a circle in the lower left corner. A colored band around the circumference of the bullet where it enters the neck of the cartridge (see par. 40) and a similarly colored circle on the upper left corner of box labels

(see fig. 154) serve to indicate the character of the round.

b. Where to Use

This ammunition is designed to function in the following weapons:

Model 11 (1922) 6.5-mm light machine gun.

Model 96 (1936) 6.5-mm light machine gun.

It will also function in the following weapons:

Model 38 (1905) 6.5-mm rifle.

Model 38 (1905) 6.5-mm carbine.

Model 44 (1911) 6.5-mm cavalry carbine.

43. 7.7-MM AMMUNITION

a. How to Identify

Japanese 7.7-mm. (.303-inch) ammunition may be identified primarily by its size and the labels on the

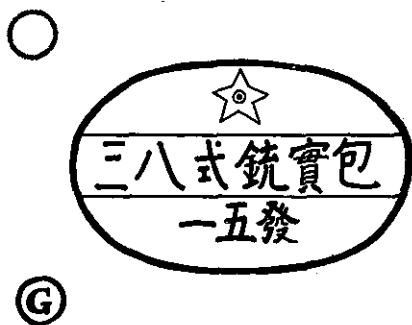

Figure 154.—Label and markings used on box of Model 38 (1905) 6.5-mm semirimmed, reduced-charge ball ammunition. (The markings on the label are read, from left to right, *Sampachi Shiki Ju Jippo—Jugo Hatsu*, meaning "38 model rifle ball ammunition—15 rounds." Ⓒ in the lower left corner indicates reduced-charge ammunition. The circle in the upper left corner (which is colored pink) indicates ball ammunition.)

boxes (fig. 155). There are three types of 7.7-mm ammunition: rimmed, semirimmed, and rimless.

b. Where to Use

(1) *Rimmed*.—Japanese 7.7-mm rimmed ammunition is interchangeable with British caliber .303 ammunition, but may be used only in the Vickers-type (fixed) and Lewis-type (flexible) aircraft machine guns and in the Lewis-type ground machine guns.

(2) *Semirimmed*.—Model 92 (1932) 7.7-mm semirimmed ammunition (fig. 155) is used only in the Model

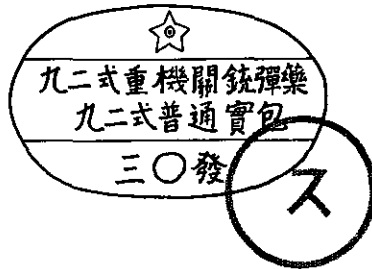

Figure 155.—Label and markings used on box of Model 92 (1932) 7.7-mm ammunition. (The markings on the label are read, from left to right, *Kyuni Shiki Jukikanju Danyaku—Kyuni Shiki Futsu Jippo—Sanju Hatsu*, meaning “92 model heavy-machine-gun ammunition—92 model ordinary ball ammunition—30 rounds.”)

92 (1932) 7.7-mm heavy machine gun and in certain types of aircraft machine guns other than the Vickers and Lewis types mentioned above. (See (3), below.)

(3) *Rimless*.—Model 99 (1939) 7.7-mm rimless ammunition is used in the Model 99 (1939) 7.7-mm rifle and the Model 99 (1939) 7.7-mm light machine gun. It will function also in the Model 92 (1932) 7.7-mm heavy machine gun, although the Model 92 (1932) semirimmed

ammunition will not, in turn, function in the Model 99 rifle or light machine gun.

44. 8-MM PISTOL AMMUNITION

Japanese 8-mm (.315-inch) pistol ball ammunition may be identified by its semirimmed, bottlenecked case and roundnosed bullet. At present no information is available as to the nomenclature or packing of this cartridge, which is used in all three of the Japanese automatic pistols: the *Nambu*, the Model 14 (1925), and the Model 94 (1934). There are no color markings on the rounds that have been examined.

Caliber	Model	Type of round	Color of band	Color of bullet	Shape of bullet
6.5-mm...	Model 38 (1905), semirimmed.	Ball	Pink....	Silver or copper.	Pointed nose.
6.5-mm...	Model 38 (1905), semirimmed.	Tracer	Green..	Silver....	Pointed nose.
6.5-mm...	Model 38 (1905), semirimmed special.	Special reduced charge for light machine guns Models 11 (1922) and 96 (1936).	Pink....	Silver....	Pointed nose. (Can be identified only by  on ammunition containers.)
7.7-mm...	Model 92 (1932), semirimmed.	Ball for Model 92 (1932) heavy machine gun only.	Pink...	Silver...	Pointed nose. (Packed 300 rounds in 30-round clips in unlined wooden case.)
7.7-mm...	Model 92 (1932), semirimmed.	Armor-piercing for Model 92 (1932) heavy machine gun only.	Black..	Brass....	Pointed nose.
7.7-mm....	Model 92 (1932), semirimmed.	Tracer for Model 92 (1932) heavy machine gun only.	Green..	Silver...	Pointed nose.
7.7-mm....	Model 99 (1939), rimless.	Ball for Model 99 (1939) rifle and Model 99 (1939) light machine gun; also functions in Model 92 (1932) heavy machine gun.	Pink	Copper....	Pointed nose.
8-mm.....		Ball for <i>Nambu</i> , Model 14 (1925), and Model 94 (1934) automatic pistols.	None..	Silver....	Round nose.

Figure 156.—Infantry small-arms ammunition chart.

APPENDIX

45. GENERAL

Detailed information and photographs obtained from enemy sources indicate the existence of several modifications of Japanese standard small arms not yet encountered in combat areas. The model numbers of most of these are not yet known.

46. SNIPER'S 6.5-MM RIFLE

This 6.5-mm rifle (probably the Model 91 (1931)) is the same size as the Model 38 (1905) 6.5-mm rifle (par. 8, p. 25), and many parts are obviously the same (fig. 157). It has a folding monopod attached to the upper band. A telescopic sight is mounted very low on the left side of the receiver. Otherwise it does not appear to differ from the Model 38. Its chief characteristics are reported to be as follows:

Caliber.....	6.5 mm (.256 inch).
Telescopic sight:	
Magnifying power.....	2.5 times.
Field of view.....	10 degrees.
Weight.....	1.1 pounds.
Over-all length.....	50.2 inches.

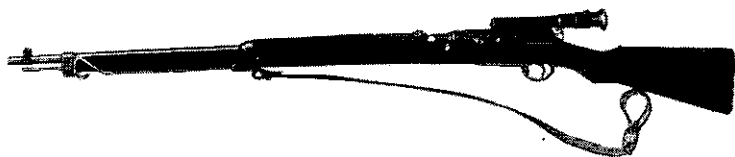

Figure 157.—Sniper's 6.5-mm rifle.

Weight.....	9.8 pounds.
Maximum range.....	2,600 yards.

47. LONG 7.7-MM RIFLE

This 7.7-mm rifle (fig. 158) is 5.5 inches longer than the Model 99 (1939) 7.7-mm rifle (par. 9, p. 39), the extra length being entirely in the barrel. It is a fraction of an inch shorter than the Model 38 (1905) 6.5-mm rifle. Like the Model 99 rifle, it has a folding monopod attached to the upper band, but the sling swivels are on the bottom of the rifle, not on the side as in the Model 99. The rear sight is the same as that used on the Model 99, including the folding arms to be used when firing at aircraft. This rifle does not appear to differ essentially from the usual Arisaka pattern. Its chief characteristics are reported to be as follows:

Caliber.....	7.7 mm (.303 inch).
Capacity of magazine.....	5 rounds.
Rear sight.....	Graduated from 100 to 1,500 meters (109.4 to 1,640 yards).
Length of barrel.....	31.4 inches.
Length:	
Without bayonet.....	50.1 inches.
With bayonet.....	65.2 inches.
Height of monopod.....	12.4 inches.
Weight:	
Without bayonet.....	9.02 pounds.
With bayonet.....	10 pounds.
Maximum range.....	3,829 yards.
Muzzle velocity.....	2,560 feet per second.

48. MODEL 97 (1937) 7.7-MM TANK MACHINE GUN (GROUND MOUNT)

By the addition of a bipod and the removal of the armor cover over the forepart of the weapon, the Model

97 (1937) 7.7-mm tank machine gun may be adapted for use by ground troops (fig. 159). This machine gun is similar in construction to various types of Bren guns,

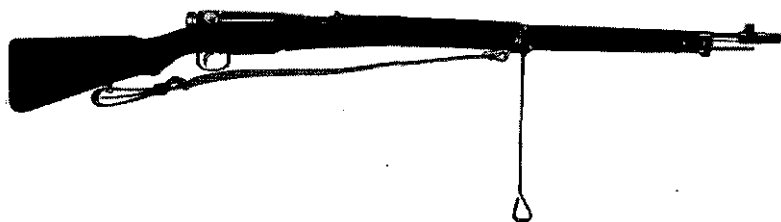

Figure 158.—Long 7.7-mm rifle with muzzle cover attached.

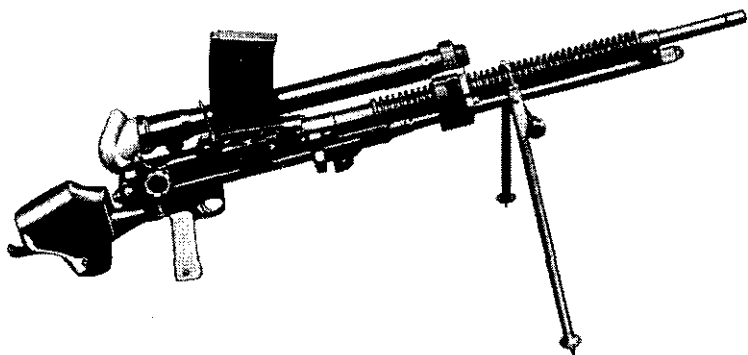

Figure 159.—Model 97 (1937) 7.7-mm tank machine gun on ground mount.

but it has a modified stock and several other features typical of machine guns designed for use in tanks. It fires the Model 99 (1939) 7.7-mm rimless ammunition. (See par. 43b (3), p. 237.)

	Weight (pounds)	Action	Maximum range (yards)	Effective range (yards)	Rate of fire (rounds per minute)
1 Model 14 (1928) 8-mm pistol	2	Semiautomatic	547	17	
2 Model 99 (1939) 7.7-mm light machine gun	21.36	Automatic	3,800	1,600	800 (cyclic)
3 Model 99 (1939) 7.7-mm rifle	8.8	Manual	3,000	600	
4 Model 38 (1905) 6.5-mm rifle	9.4	Manual	2,600	400	
5 Model 89 (1929) 50-mm grenade discharger	10.26	Manual	176 to 770		
6 Model 92 (1932) 7.7-mm heavy machine gun	122	Automatic	4,597	1,800	450 (cyclic)
7 Model 97 (1937) 20-mm antitank rifle	140	Automatic		1,100	
8 Model 94 (1934) 37-mm gun	714	Manual	5,000	2,500	10 to 20
9 Model 1 (1941) 47-mm gun	1,660	Manual			
10 Model 99 (1939) 81-mm mortar	52	Manual	1,312 to 3,280		15
11 Model 64 (1924) 90-mm mortar	340	Manual	4,180		
12 Model 92 (1932) 70-mm howitzer (battalion gun)	468	Manual	3,000	1,600	10
13 Model 41 (1908) 75-mm mountain (infantry) gun	1,300	Manual	7,676	2,100	
14 Model 93 (1933) 13-mm twin heavy machine gun		Automatic			
15 Model 98 (1938) 20-mm AA/AC gun	856	Automatic or semiautomatic	12,000 feet (vertical)		



Figure 160.—Schematic drawing, indicating ranges of principal Japanese infantry weapons.