

# THE ORDNANCE SOLDIER'S GUIDE



R E S T R I C T E D

THE ORDNANCE REPLACEMENT TRAINING CENTER • ABERDEEN PROVING GROUND • MD

# TO THE NEW ORDNANCE SOLDIER

An American soldier can, if necessary, fight without food or shelter or medical care -- but an army without weapons is lost. The supply and maintenance of fighting tools for the U. S. Army is your responsibility, as an Ordnance Soldier -- and that makes yours a most important mission in the military service.

Learning how to fulfill this mission is a never-ending process. It is to help you learn your job that the ORDNANCE SOLDIER'S GUIDE has been prepared. It contains practical tips drawn from actual battle

experience and technical data from the latest Army publications.

This copy is yours. Take it to all your training periods. Take notes in it and study them in your spare time.

**INSTRUCTORS NOTE:** THE ORDNANCE SOLDIER'S GUIDE is a note taking aid intended for use by Ordnance Soldiers during their basic training period. The content of the GUIDE is extracted from pertinent military publications. Consult FM 21-6 and current Training Circulars for the latest available information. In any case where information in the GUIDE is superseded, advise the Soldier to enter the correction.

## TABLE OF CONTENTS

THIRD EDITION

SOLDIER'S HANDBOOK

THE ORDNANCE SOLDIER'S GUIDE

Page Number	Subject	Page Number
3, 5	Ammunition . . . . .	66
	Articles of War . . . . .	6
	Artillery . . . . .	58
	Automotive Materiel . . . . .	70
	Camouflage . . . . .	28
26; 30, 49	Care of Clothing & Equipment . . . . .	4
	Certificate of Marksmanship . . . . .	24
	Commando Combat . . . . .	46
164	Defense Against Air & Paratroop Attack . . . . .	41
45, 217	Defense Against Booby Traps . . . . .	48
	Defense Against Chemical Attack . . . . .	30
	Defense Against Mechanized Attack . . . . .	38
78	Display of Field Equipment . . . . .	4
	Elementary Principles of Ordnance . . . . .	56
	Extended Order Drill . . . . .	25
206	First Aid . . . . .	15
	Field Rigging . . . . .	75
	Glossary . . . . .	78
	Hasty Field Fortifications . . . . .	27
	Incendiary Bombs . . . . .	34
135	Interior Guard Duty . . . . .	18
	Know Your Enemy . . . . .	44
153	Map Reading . . . . .	35
10	Military Courtesy . . . . .	2
202	Military Sanitation . . . . .	13
22	Organization of the Army . . . . .	8
	Organization of the Ordnance Department . . . . .	52
	Rifle Marksmanship . . . . .	20
	Safeguarding Military Information . . . . .	1
31-44	Small Arms . . . . .	62
	Tips from an Old Top Kick . . . . .	49

WHEN TO SALUTE

AT RETREAT

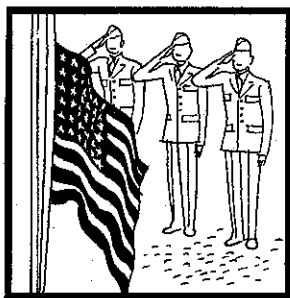

At Retreat Parade and not in formation, at the first note of music, face toward the colors, stand at attention, and salute.

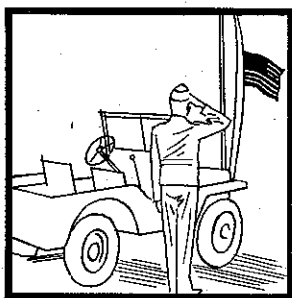

When driving a vehicle, you are required to stop, dismount, face the flag, and salute.

AT PAY TABLE



At Pay Table, enter when your name is called, salute, give your name to the Officer.

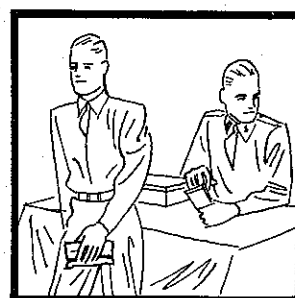

When you receive your pay, do not salute again, but take the shortest route out of the office.

REPORTING TO AN OFFICER OUT OF DOORS

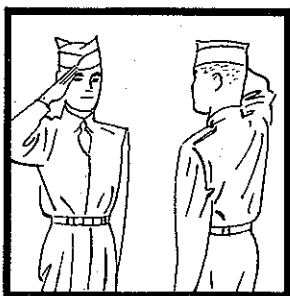

Halt at least 2 paces from the officer, salute, and state: "Sir, Pvt. \_\_\_\_\_ reports as directed."

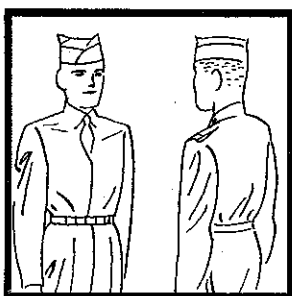

While talking stand at attention. When conversation is over, salute, about face, depart.



When reporting to or passing an officer while you are carrying a rifle, give the rifle salute.

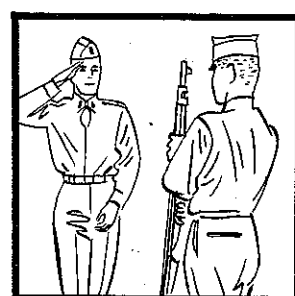

In garrison, if posted as a sentinel with a rifle, you will salute by presenting arms.

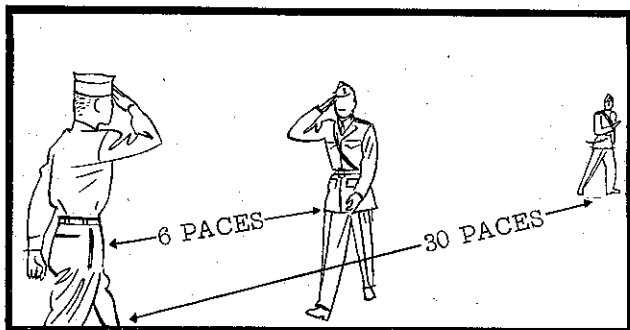

PASSING AN OFFICER

When passing an officer, salute him at a distance of not less than six paces or when recognition is easy. Turn your head toward the officer and hold the salute until it is returned.

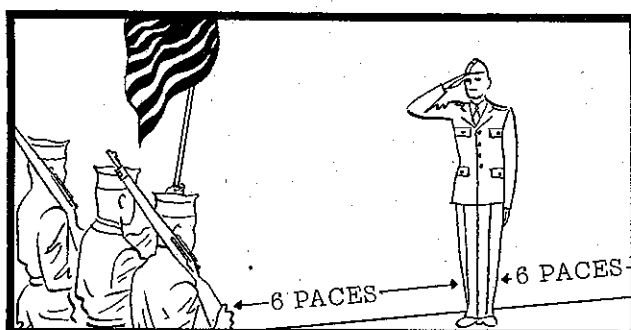

COURTESIES TO THE FLAG

If you are passing, or being passed, by an uncased national color, start your salute six paces from the color and hold it until it is six paces beyond you.

800  
JC

# CARE OF CLOTHING AND EQUIPMENT

**RESPONSIBILITY FOR PROPERTY:** Clothing and equipment issued to you are government property. If any articles are lost or damaged through your fault or negligence you will be required to pay for them. If you were responsible for the loss or damage, through fault or negligence, then you should admit that fact by signing a "Statement of Charges." If, however, you believe that you were not respon-

sible, do not sign this statement. In the latter case a "Report of Survey" will be made out and a Surveying Officer will determine whether or not you are to be held responsible. When articles of clothing or equipment have become worn out through ordinary wear and tear, no one is held responsible for the value and the worn articles may be exchanged for new ones.

## HOW TO FOLD A TOWEL

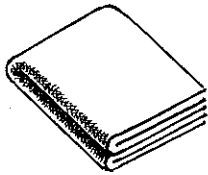

## ARRANGEMENT OF CLOTHES ON A HANGER

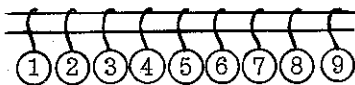

When not in use, clothing should be buttoned and arranged as follows:

1. Raincoat
2. Overcoat
3. Fatigues
4. Blouse
5. Field Jacket
6. Cotton Shirts
7. O. D. Shirts
8. Trousers, (Cotton)
9. Trousers, (O. D.)

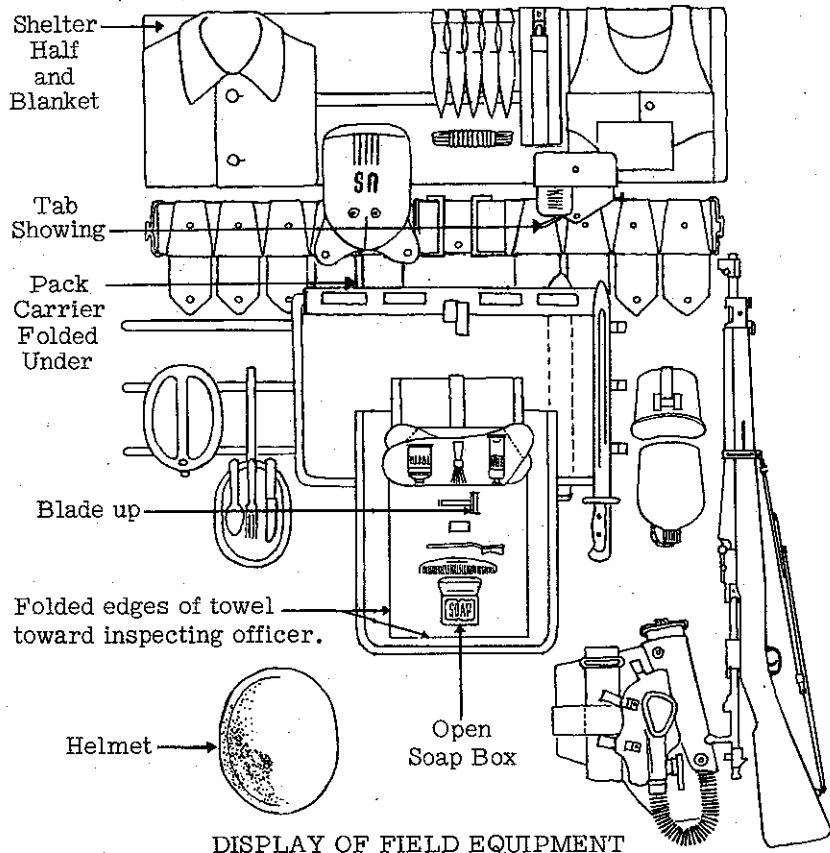

DISPLAY OF FIELD EQUIPMENT

### Leather

Use mild soap and warm water to clean shoes. Apply saddle soap and dry slowly. Use wax polish sparingly.

### Web

Wash with a mild soap and warm water. Dry thoroughly in a place away from the sun.

### Brass

Clean with polishing cloth, soap and water. Shine with soft rag.

### Clothing

Have clothing altered if necessary. Have available a small sewing kit, a can of cleaning solvent, and equipment for pressing clothes.

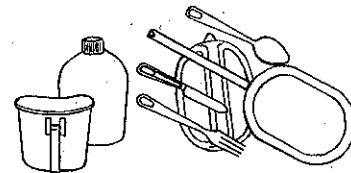

### Mess Gear

Wash with soap and hot water. Clean occasionally with sand.

## CARE AND CLEANING OF SHOULDER WEAPONS

Rifle and Carbine — Clean metal parts with sperm oil. Clean bore with rifle bore cleaner or G.I. soap and hot water. Treat stock and hand guards with linseed oil. Treat sling with neatsfoot oil.

### U. S. RIFLE, CALIBER .30, M1903-A1

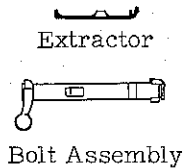
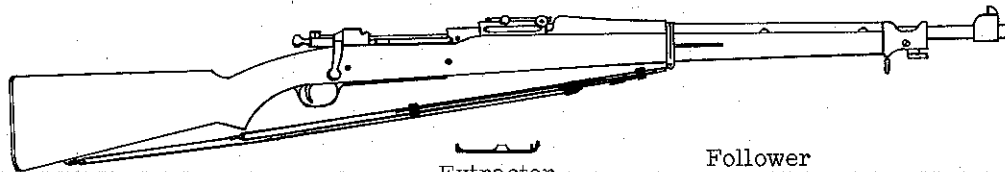

### U. S. CARBINE, CALIBER .30, M1

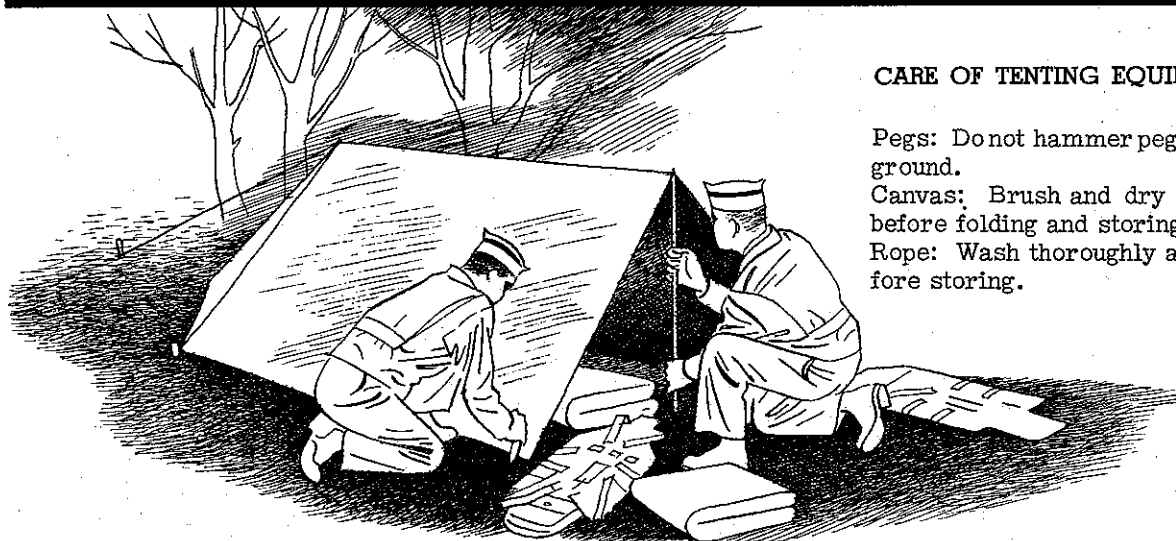
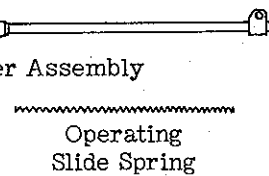
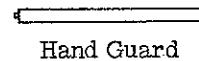
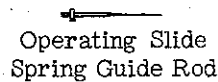
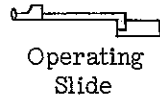
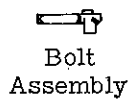
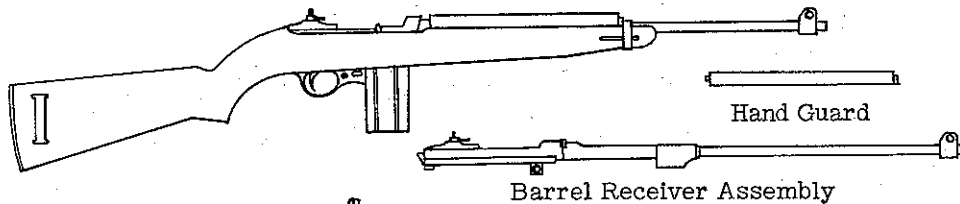

## CARE OF TENTING EQUIPMENT

Pegs: Do not hammer pegs into hard ground.

Canvas: Brush and dry thoroughly before folding and storing.

Rope: Wash thoroughly and dry before storing.

# ARTICLES OF WAR

As long as our country is at WAR, the following crimes are capital crimes -- that is, PUNISHABLE BY DEATH, or such other punishment as a court martial may decide. The number of the Article of War applying to each crime is also given.

A. W. 58 - Desertion -- Going AWOL with the intent not to return. According to Federal Laws, all persons who desert the service of the United States are deemed to have voluntarily relinquished and forfeited their rights of citizenship, as well as their right to become citizens, and such deserters are forever incapable of holding office of trust or profit under the United States, or of exercising any rights of citizens thereof.

Certain Acts Constitute desertion (A.W. 28)  
Going AWOL to avoid dangerous duty.  
Going AWOL to avoid important service.  
Joining another branch of the Military Service before being released from first connection.

A. W. 59 - Advising or Aiding Another to Desert.

A. W. 64 - Assaulting or Wilfully disobeying a Superior Officer.

A. W. 66 - Mutiny or Sedition.

A. W. 67 - Failure to Suppress Mutiny or Sedition.

A. W. 75 - Misbehavior Before the Enemy --  
Running away from fighting scene.  
Giving False Alarms.  
Ceasing to Fight the Enemy.  
Trying to get another to do any of these things.

A. W. 76 - Subordinates Trying to get their Commander to Surrender.

A. W. 77 - Improper use of Countersign or Pass Word.  
Telling pass word to those not supposed to know it.  
Deliberately telling another soldier a wrong pass word.

A. W. 78 - Forcing a Safeguard.

A. W. 81 - Relieving, Corresponding With, or Aiding the Enemy.

A. W. 82 - Spying for an Enemy. (Penalty Must be Death)

A. W. 86 - Misbehavior of a Sentinel --  
Found asleep on a Guard Post.  
Found drunk on a Guard Post.  
Leaving a Guard Post before properly relieved.

A. W. 92 - Murder or Rape. (Penalty--Death or Life Imprisonment)

Following are other Articles of War which especially apply to soldiers of the Army, arranged to show the maximum possible punishment for each of the offenses	Dishonorable Discharge & Forfeiture all pay due & to become due	<u>ALSO</u>	Confined At Hard Labor not to exceed	Forfeiture of 2/3 pay not to exceed

- A.W. 54 Fraudulent Enlistment . . . . Yes . . . . 1 yr.
- A.W. 61 Absence Without Leave . . . Yes . . . Left to the jurisdiction of court.
- A.W. 62 Disrespect Towards High Government Officials . . . . Yes . . . . 1 yr.
- A.W. 63 Disrespect Towards a Superior Officer . . . . . 6 mo. . . . 6 mo.
- A.W. 65 Insubordinate Conduct Towards Noncommissioned Officer . . . . . Yes . . . . 1 yr.
- A.W. 68 Refusal to Cease Disorder or Brawling . . . . . Yes . . . . 3 yr.
- A.W. 69 Breaking Arrest . . . . . 3 mo. . . . 3 mo.  
Breaking Confinement . . . Yes . . . . 1 yr.
- A.W. 73 Releasing Prisoner Without Authority . . . . . Yes . . . . 1 yr.
- A. W. 83 Military Property — Improper Loss, Damage or Disposition . . . . . Yes . . . . 2 yr.
- A.W. 84 Waste or Unlawful Disposition of Military Property issued to soldiers . . . Yes . . . 5 yr.
- A.W. 85 Drunk on Duty . . . . . 6 mo. . . . 6 mo.
- A.W. 90 Provoking Speeches or Gestures . . . . . 3 mo. . . . 3 mo.
- A.W. 93 Various Crimes — Murder, Slaughtering, Arson, Burglary, Housebreaking, Robbery, Larceny, perjury, Forgery, Embezzlement, Sodomy and Assault . . . . . Yes . . . . 5-20 yr.
- A.W. 94 Frauds Against the Government . . . . . Yes . . . 5 yr.

# ORGANIZATION OF THE ARMY

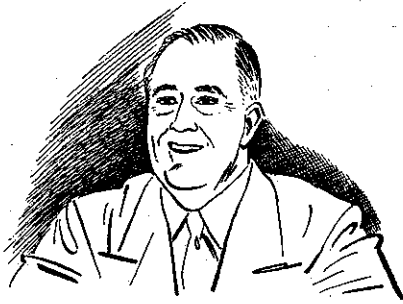

**P R E S I D E N T**  
Franklin D. Roosevelt  
Commander-in-Chief



**S E C . O F W A R**  
Henry L. Stimson

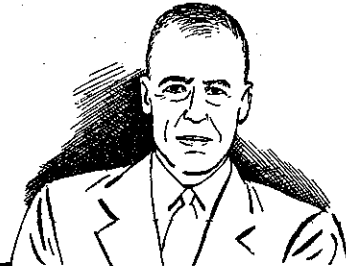

**U N D E R S E C . O F W A R**  
Robert P. Patterson



**C H I E F O F S T A F F**  
General George C. Marshall

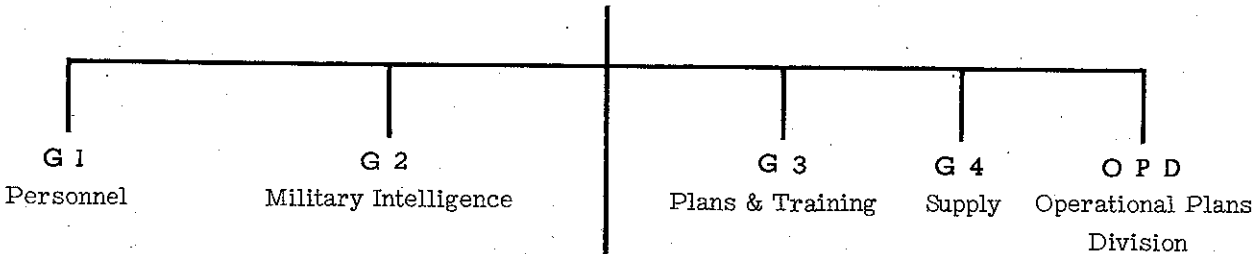

**GROUND FORCES**  
To provide ground force units properly organized, trained and equipped for combat operation.

**SERVICES OF SUPPLY**  
To provide units properly organized, trained, and equipped for development, procurement, storage and distribution of supplies.

**AIR FORCES**  
To provide air force units properly organized, trained and equipped for combat operation.



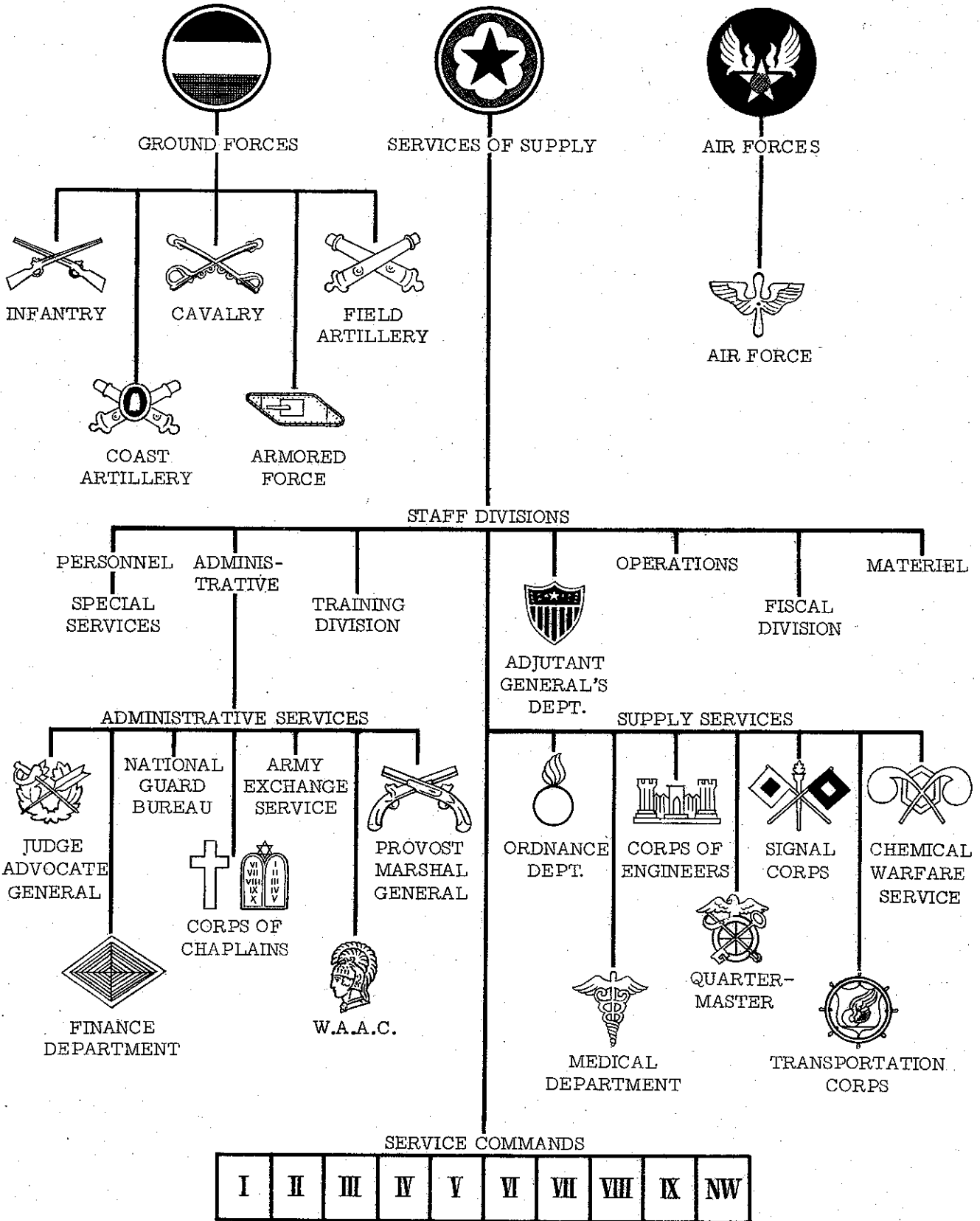

# MISSIONS OF VARIOUS BRANCHES



**GENERAL STAFF:**  
Aids Secretary of War in forming and executing plans and policies for the entire army.

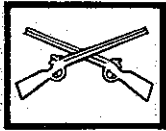

**INFANTRY:**  
A fighting arm — supported by other arms. Chief weapons: mortars, rifles and machine guns.

**ORDNANCE DEPARTMENT:**  
Designs, procures, issues and maintains weapons, motor vehicles, and ammunition.

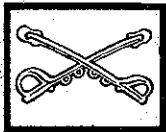

**CAVALRY:**  
Horse and mechanized. Used for attack, reconnaissance, security. Weapons like Infantry.

**QUARTERMASTER CORPS:**  
Feeds, clothes, and houses the Army. Procures all material of standard manufacture.

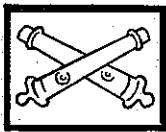

**FIELD ARTILLERY:**  
Supports Infantry and Cavalry with guns, howitzers. Firing unit is battery of four guns.

**CHEMICAL WARFARE SERVICE:**  
Protects against enemy chemicals; may support fighting arms in retaliatory gas warfare.

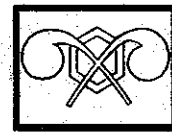

**COAST ARTILLERY:**  
Operates coast guns, mines ports, charged with all antiaircraft defense.

**TRANSPORTATION CORPS:**  
Embraces rail, water, highway shipments; ports of embarkation, regulating stations.

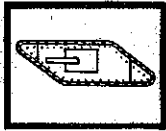

**ARMORED FORCE:**  
Tanks furnish greatest striking power of attack. Have greatest mobility and fire power.

**MEDICAL DEPARTMENT:**  
Maintains health of Army. Services: medical, dental, sanitary, nursing, veterinary.



**ARMY AIR FORCES:**  
Missions: bombardment, pursuit, observation, air defense, ground support, and transport.

**FINANCE DEPARTMENT:**  
Pays Army salaries and amounts due for Army purchases. Audits accounts of Army property.



**CORPS OF ENGINEERS:**  
Builds roads, bridges. Charged with laying mines, camouflage, demolitions, operation of utilities.

**ADJUTANT GENERAL'S DEPT:**  
Communicates orders. Arranges and preserves military records. Conducts recruiting service.



**SIGNAL CORPS:**  
Handles all signal communications at headquarters of divisions and larger units.

**CORPS OF CHAPLAINS:**  
Is specially charged with religious, and moral welfare of members of all arms and services.



**SPECIAL SERVICE:**  
Supervises Army recreation; theaters, service clubs, libraries, etc.

**ARMY EXCHANGE SERVICE:**  
Supervises and operates the army post exchanges.

## THE DIVISION

THE SMALLEST STANDARD UNIT COMPOSING A COMPLETE AND INDEPENDENT FIGHTING TEAM.

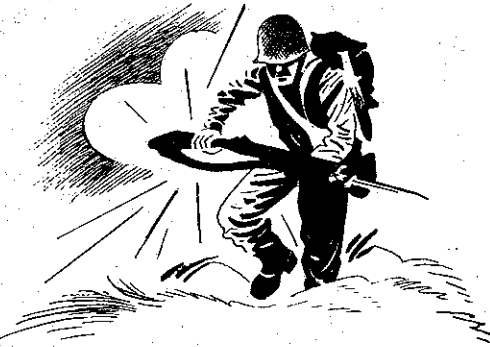

**INFANTRY DIVISION**

3 Infantry Regiments	Signal Company
Divisional Artillery	Quartermaster Bn
Reconnaissance Troop	Ordnance Company
Engineer Battalion	

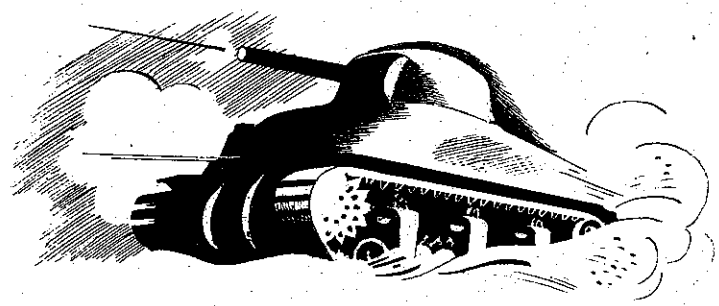

**ARMORED DIVISION**

2 Armored Regiments	Engineer Battalion
Infantry Regiment	Signal Company
Field Artillery Regiment	Quartermaster Bn
Reconnaissance Battalion	Ordnance Battalion

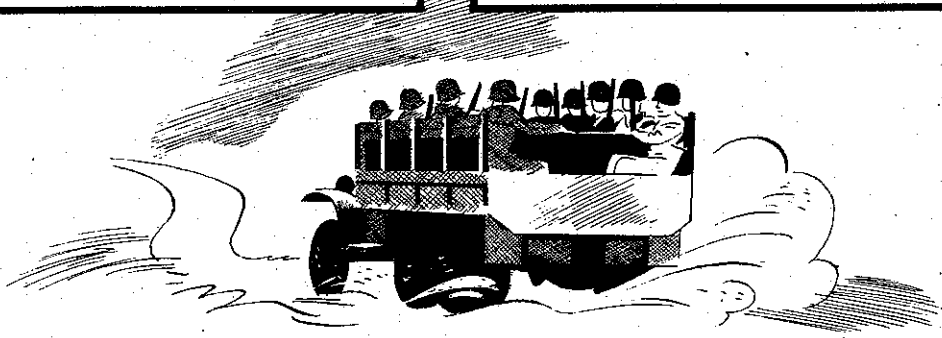

**MOTORIZED DIVISION**

3 Infantry Regiments	Medical Battalion	Engineer Bn	} Attached
Division Artillery	Ordnance Company	Signal Company	
Reconnaissance Bn	Quartermaster Bn	Tank Battalion	
		Antiaircraft Bn	

### TASK FORCE

In modern warfare specific forms of military organization are seldom used intact. Troops sent to Egypt and the desert should not have the same organizational form as troops sent to the Aleutian Islands. Each force must be tailor-made for its

specific job. Such a force is a task force. To take an island and hold it against enemy attack the task force might consist of a regiment of infantry, a battalion of 105 mm howitzers, a light tank company, and an antiaircraft regiment, and accompanying service units.

# INSIGNIA OF RANK AND GRADE

## COMMISSIONED OFFICERS



General



Lieutenant General



Major General



Brig. General



(Silver)  
Colonel



(Silver)  
Lt. Colonel



(Gold)  
Major



(Silver)  
Captain



(Silver)  
1st Lt.



(Gold)  
2nd Lt.

## NON-COMMISSIONED OFFICERS



Master Sergeant



First Sergeant



Technical Sergeant



Staff Sergeant



Technician  
3rd Grade



Sergeant



Technician  
4th Grade



Corporal



Technician  
5th Grade



Private  
First Class

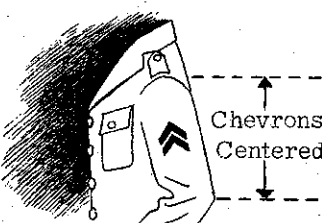
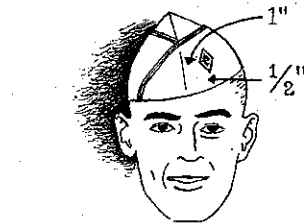
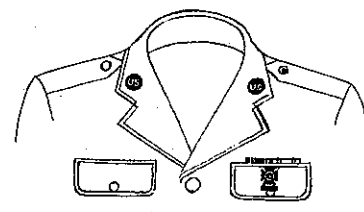
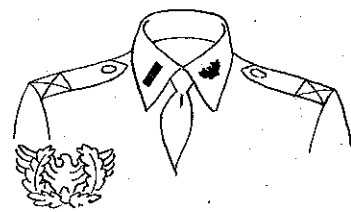
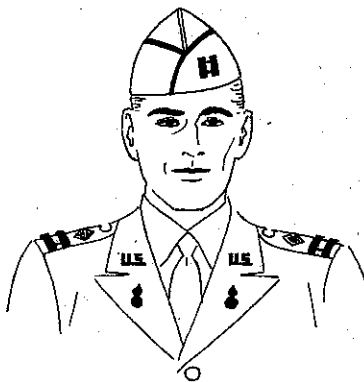
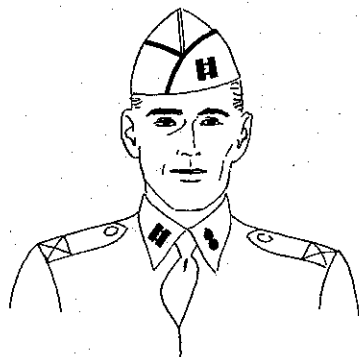

CHAIN OF COMMAND extends from the corporal who leads a squad, through the sergeants and officers in command of the larger units, to the President of the United States, the commander-in-chief of our armed forces.

TACTICAL UNIT	APPROX. NO. OF MEN	COMMANDER
Squad	12	Corporal
Platoon	50	Lieutenant
Company	200	Captain
Battalion (Inf.)	900	Major
Regiment (Inf.)	3,200	Colonel
Division	15,000	Major General
Corps	75,000	Lt. General
Army	300,000	General

## WARRANT OFFICERS



Chief Warrant Officer  
(Brown with Gold Band)



Warrant Officer  
(Junior Grade)  
(Brown with Gold Band)

# MILITARY SANITATION

PERSONAL HYGIENE deals with your efforts to keep in good physical condition, and with the precautions you must take to protect yourself from disease. Before you were allowed to enter the Army, you were given a thorough physical examination to determine the absence of disease. It then became your duty to keep yourself in the best possible physical condition. In so doing, attention to personal hygiene is of great importance.

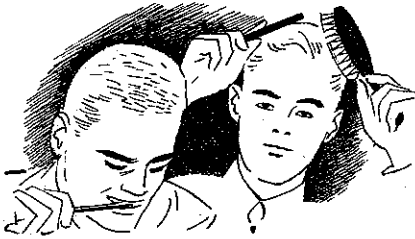

---

---

---

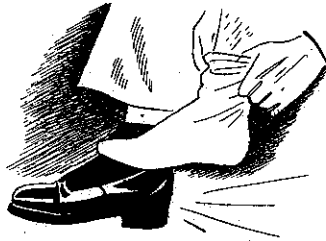

---

---

---

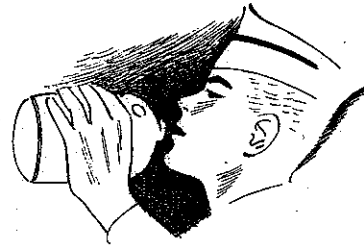

---

---

---

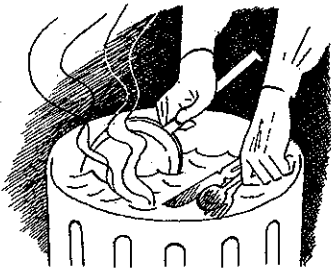

---

---

---

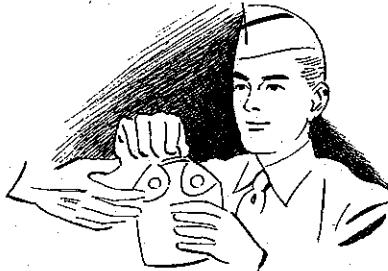

---

---

---

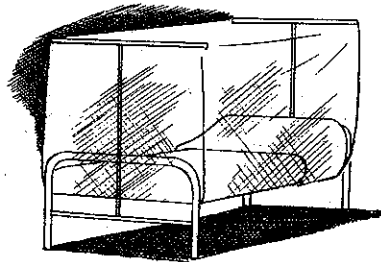



---

---

---

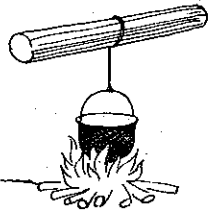
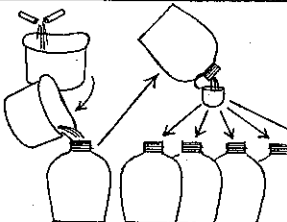
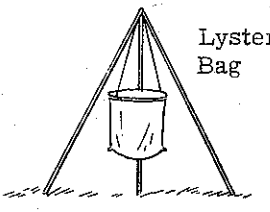
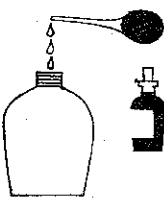
## WATER PURIFICATION—METHODS

BOILING	CALCIUM HYPOCHLORITE		IODINE
 <hr/> <hr/> <hr/> <hr/>	 <p data-bbox="548 1696 646 1726">Capsule</p> <hr/> <hr/> <hr/> <hr/>	 <p data-bbox="971 1501 1052 1564">Lyster Bag</p> <p data-bbox="868 1696 966 1726">Ampule</p> <hr/> <hr/> <hr/> <hr/>	 <hr/> <hr/> <hr/> <hr/>

# DANGER!

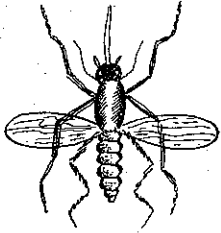

MOSQUITO

Disease \_\_\_\_\_  
 \_\_\_\_\_  
 \_\_\_\_\_

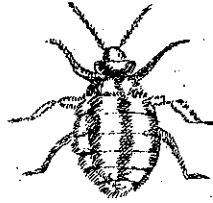

BED BUG

Disease \_\_\_\_\_  
 \_\_\_\_\_  
 \_\_\_\_\_



HOUSE FLY

Disease \_\_\_\_\_  
 \_\_\_\_\_  
 \_\_\_\_\_



WOOD TICK

Disease \_\_\_\_\_  
 \_\_\_\_\_  
 \_\_\_\_\_



CRAB LOUSE

Disease \_\_\_\_\_  
 \_\_\_\_\_  
 \_\_\_\_\_



BODY LOUSE

Disease \_\_\_\_\_  
 \_\_\_\_\_  
 \_\_\_\_\_

## DELOUSING OF CLOTHING AND EQUIPMENT

Mobile Disinfestor: \_\_\_\_\_

Hot Air Disinfestor: \_\_\_\_\_

Serbian Barrel Type: \_\_\_\_\_

Storage: \_\_\_\_\_

Hot Irons: \_\_\_\_\_

Chemicals: \_\_\_\_\_

Hot Water: \_\_\_\_\_

\_\_\_\_\_



POISON OAK

Characteristics: \_\_\_\_\_  
 \_\_\_\_\_  
 \_\_\_\_\_



POISON IVY

Characteristics: \_\_\_\_\_  
 \_\_\_\_\_  
 \_\_\_\_\_

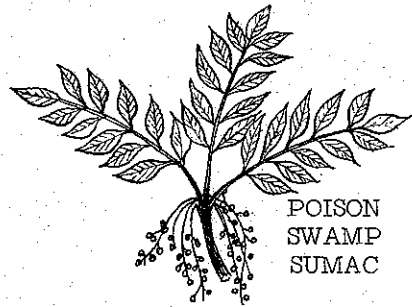

POISON SWAMP SUMAC

Characteristics: \_\_\_\_\_  
 \_\_\_\_\_  
 \_\_\_\_\_

# + FIRST AID +

**SHOCK** — Complete physical and mental depression caused by injury and fear.

**SYMPTOMS OF SHOCK:**

- A. \_\_\_\_\_
- B. \_\_\_\_\_
- C. \_\_\_\_\_
- D. \_\_\_\_\_
- E. \_\_\_\_\_

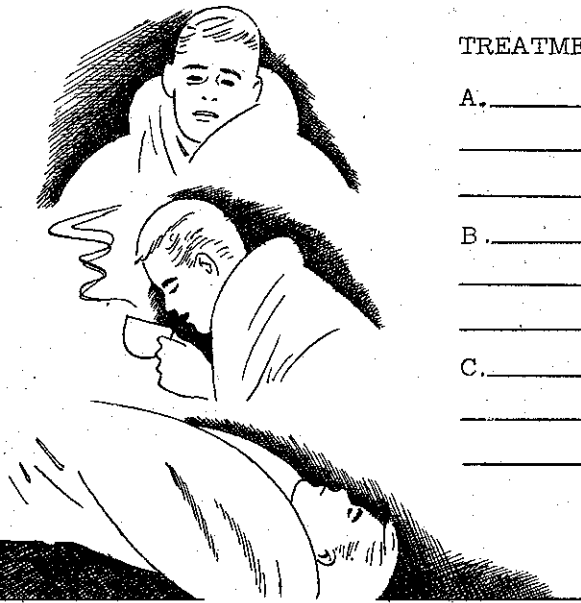

**TREATMENT OF SHOCK:**

- A. \_\_\_\_\_
- \_\_\_\_\_
- \_\_\_\_\_
- B. \_\_\_\_\_
- \_\_\_\_\_
- \_\_\_\_\_
- C. \_\_\_\_\_
- \_\_\_\_\_
- \_\_\_\_\_

**TYPES OF WOUNDS**



**ABRASION:**

- \_\_\_\_\_
- \_\_\_\_\_
- \_\_\_\_\_

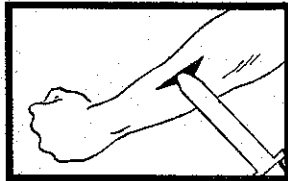

**INCISION:**

- \_\_\_\_\_
- \_\_\_\_\_
- \_\_\_\_\_



**LACERATION:**

- \_\_\_\_\_
- \_\_\_\_\_
- \_\_\_\_\_

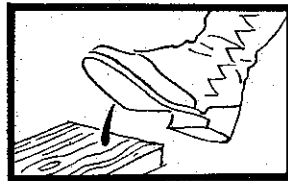

**PUNCTURE:**

- \_\_\_\_\_
- \_\_\_\_\_
- \_\_\_\_\_

**TYPES OF BLEEDING**

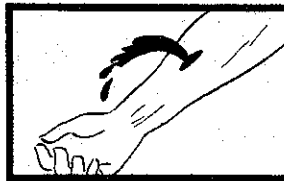

**ARTERIAL - Spurting**

- \_\_\_\_\_
- \_\_\_\_\_
- \_\_\_\_\_



**VENOUS - Rapid - Smooth**

- \_\_\_\_\_
- \_\_\_\_\_
- \_\_\_\_\_

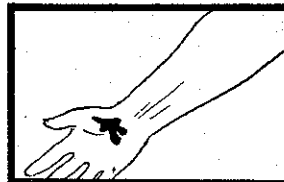

**CAPILLARY - Oozing**

- \_\_\_\_\_
- \_\_\_\_\_
- \_\_\_\_\_

**INFECTION:**

- \_\_\_\_\_
- \_\_\_\_\_
- \_\_\_\_\_

**CONTROL OF BLEEDING**



ELEVATION:  
 \_\_\_\_\_  
 \_\_\_\_\_  
 \_\_\_\_\_

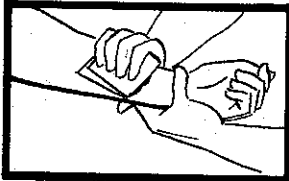

DIRECT PRESSURE:  
 \_\_\_\_\_  
 \_\_\_\_\_  
 \_\_\_\_\_

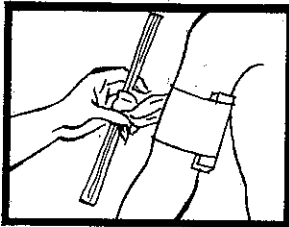

TOURNIQUET:  
 \_\_\_\_\_  
 \_\_\_\_\_  
 \_\_\_\_\_

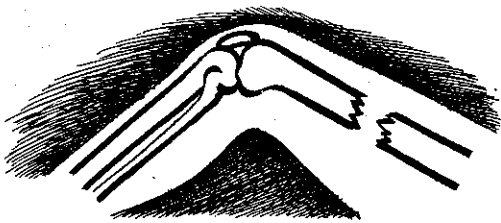
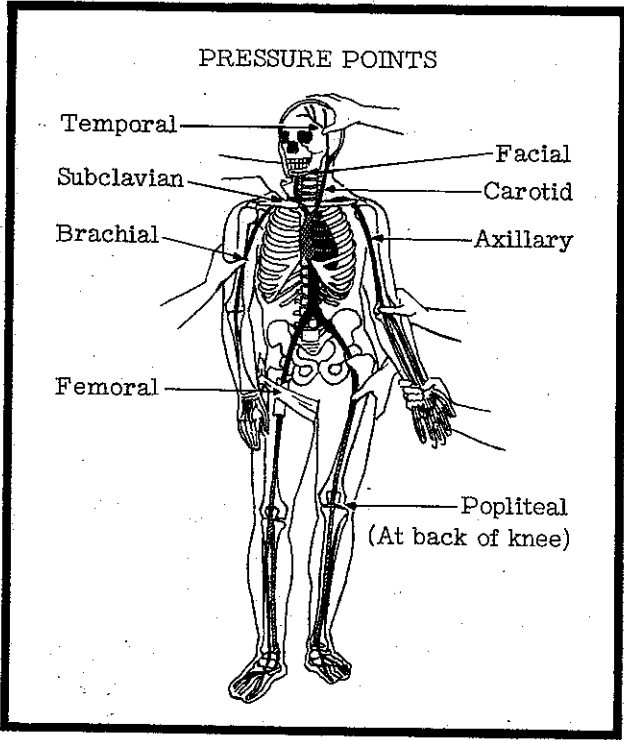

**SYMPTOMS OF SIMPLE FRACTURE:**

- A. \_\_\_\_\_
- B. \_\_\_\_\_
- C. \_\_\_\_\_

**FRACTURES**

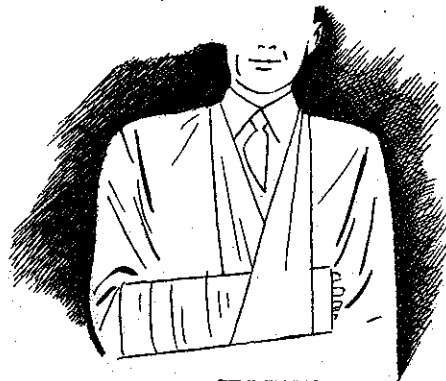

**SPLINTS:**

- A. \_\_\_\_\_
- B. \_\_\_\_\_
- C. \_\_\_\_\_
- D. \_\_\_\_\_
- E. \_\_\_\_\_

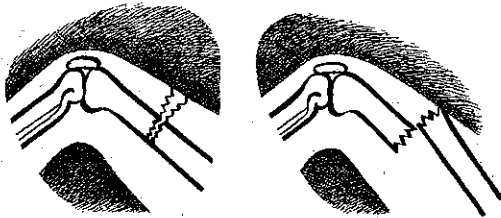

**SYMPTOMS OF COMPOUND FRACTURE:**

- A. \_\_\_\_\_
- B. \_\_\_\_\_

**PRECAUTIONS:**

- A. \_\_\_\_\_
- B. \_\_\_\_\_



**TRANSPORTATION  
OF WOUNDED**

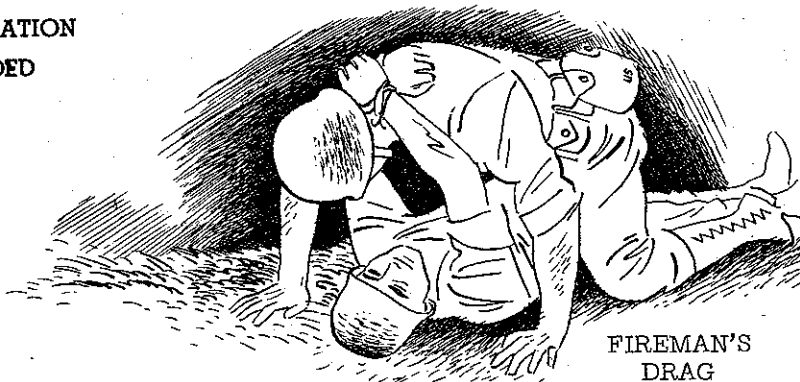

**FIREMAN'S  
DRAG**

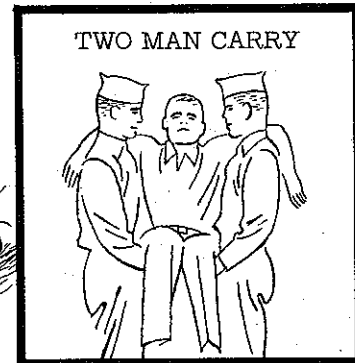

**TWO MAN CARRY**

**GENERAL RULES:**

---

---

---

---

---

---

---

---

---

---



**BLANKET STRETCHER**

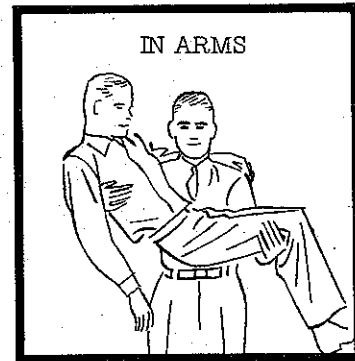

**IN ARMS**

**ARTIFICIAL RESPIRATION—PRONE PRESSURE METHOD**

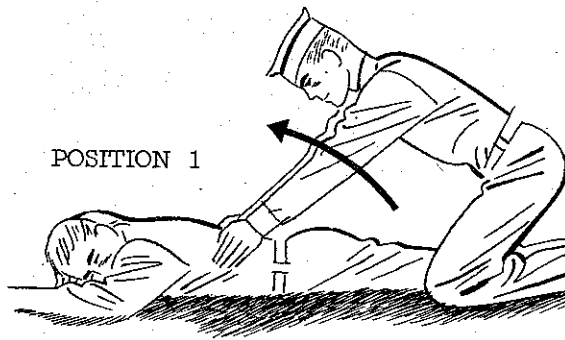

**POSITION 1**

**USED IN CASES OF:**

A. \_\_\_\_\_  
B. \_\_\_\_\_  
C. \_\_\_\_\_

**HOW PERFORMED:**

---

---

---

---

---

---

---

---

---

---

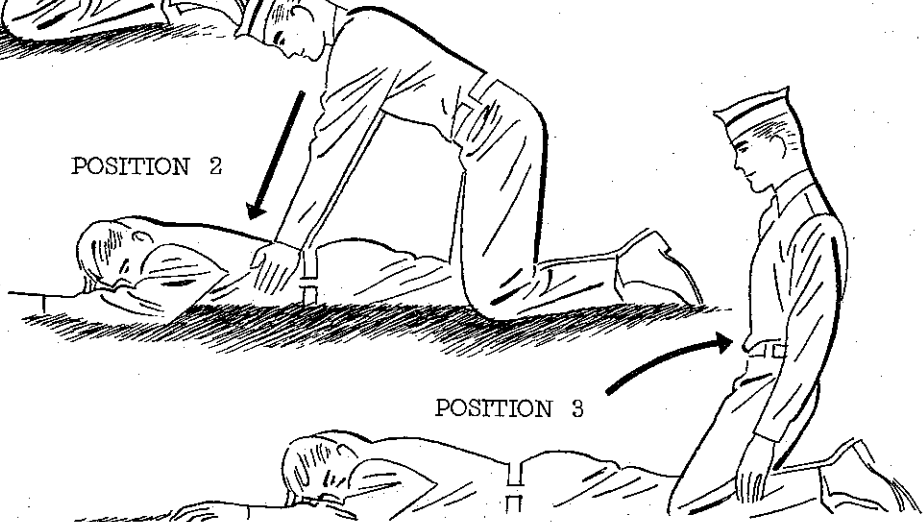

**POSITION 2**

**POSITION 3**

# INTERIOR GUARD

PURPOSES: 1. \_\_\_\_\_ 2. \_\_\_\_\_ 3. \_\_\_\_\_

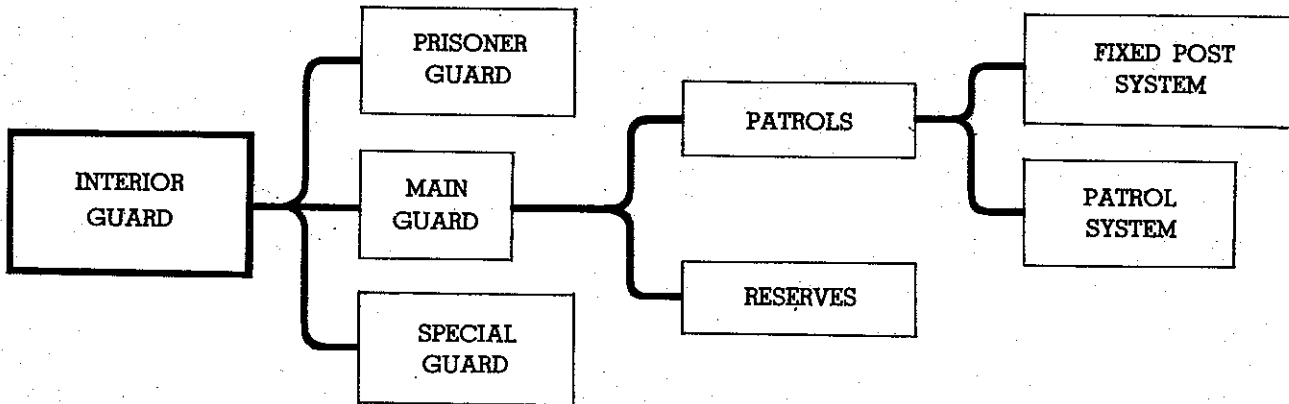

## CHAIN OF COMMAND

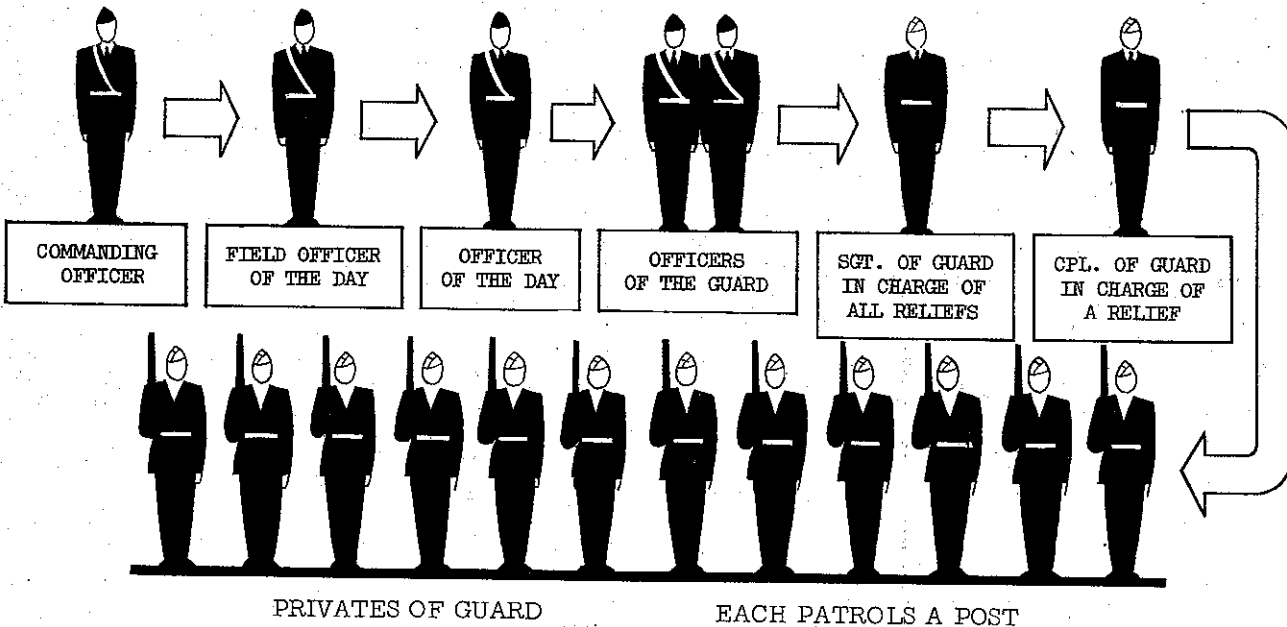

### CHALLENGING PROCEDURE

<p>SENTRY: (At 30 Paces) "Halt! Who is there?"</p> <p>PARTY: "Soldier of the post."</p> <p>SENTRY: "Advance, soldier of the post, to be recognized."</p>	<p>(Soldier advances)</p> <p>SENTRY: (At 6 paces) "Halt!" (Recognizes soldier)</p> <p>SENTRY: "Advance, soldier of the post." (Soldier goes on his way)</p>
--	---

## GENERAL ORDERS

1. To take charge of this post and all government property in view.
2. To walk my post in a military manner, keeping always on the alert and observing everything that takes place within sight or hearing.
3. To report all violations of orders I am instructed to enforce.
4. To repeat all calls from posts more distant from the guardhouse than my own.
5. To quit my post only when properly relieved.
6. To receive, obey, and pass on to the sentinel who relieves me all orders from the commanding officer, officer of the day, and officers and non-commissioned officers of the guard only.
7. To talk to no one except in line of duty.
8. To give the alarm in case of fire or disorder.
9. To call the Corporal of the Guard in any case not covered by instructions.
10. To salute all officers and all colors and standards not cased.
11. To be especially watchful at night and during the time for challenging, to challenge all persons on or near my post, and to allow no one to pass without proper authority.

## EMERGENCY CALLS

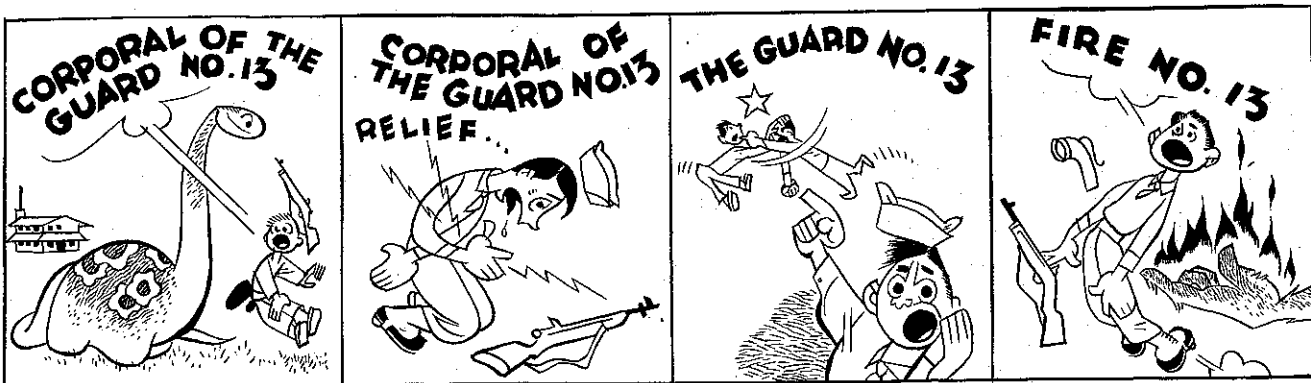

★ ★ ★

Wherever an American soldier walks guard under the Stars and Stripes, whether it be in the United States or in some far-flung combat zone, his actions

are prescribed by the General Orders. Special Orders, on the other hand, apply to only one guard post at some particular camp.

# RIFLE MARKSMANSHIP

## SIGHTING AND AIMING

Aligning of sights



FRONT SIGHT

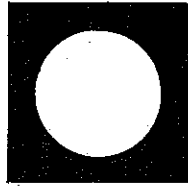

PEEP SIGHT

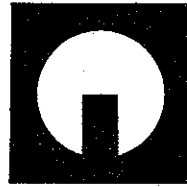

PROPER ALIGNING



POSITION OF BULLS-EYE

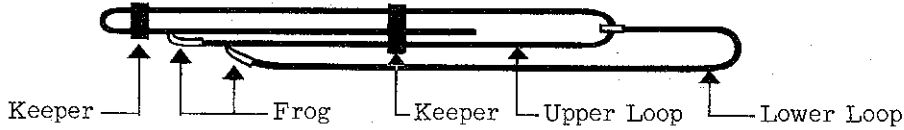

## SLING ADJUSTMENTS

### LOOP SLING

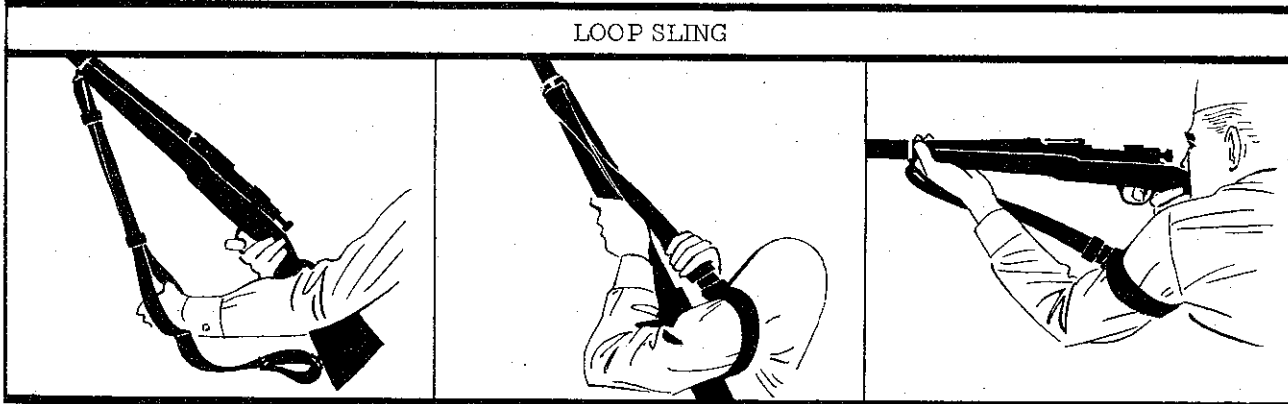

1. Loosen lower frog and fasten near butt swivel.
2. Give sling 1/2 turn to left.
3. Insert arm through upper loop.
4. Upper loop is near the shoulder and well above the biceps muscle.
5. Pull keepers and frog close to arm.
6. Move left hand over top of sling.
7. Sling lies smoothly along hand and wrist.
8. Bring rifle into firing position.

### HASTY SLING



1. Loosen lower loop.
2. Throw sling to left 1/2 turn and catch it above the elbow and high on the arm.
3. Bring rifle into firing position.

## FIRING POSITIONS



SITTING POSITION

1. Sit half-face to right of aim of fire.
2. Feet apart — heels dug in ground.
3. Body leaning forward from hips — back straight.
4. Both arms resting inside legs.

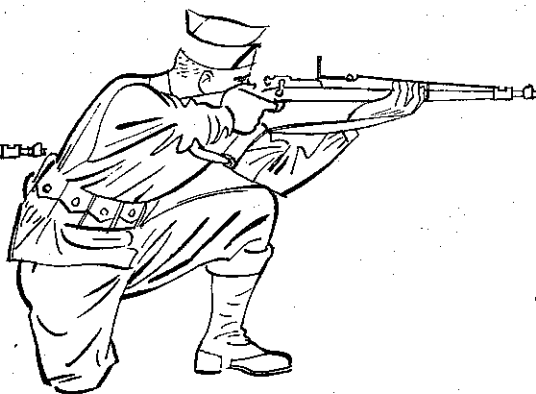

KNEELING POSITION

1. Half-face to line of fire.
2. Sit on right heel.
3. Left leg bent — left lower leg vertical.
4. Left arm well under the rifle — resting on left knee cap — point of elbow beyond the knee cap.
5. Right elbow above or at the height of the shoulder.

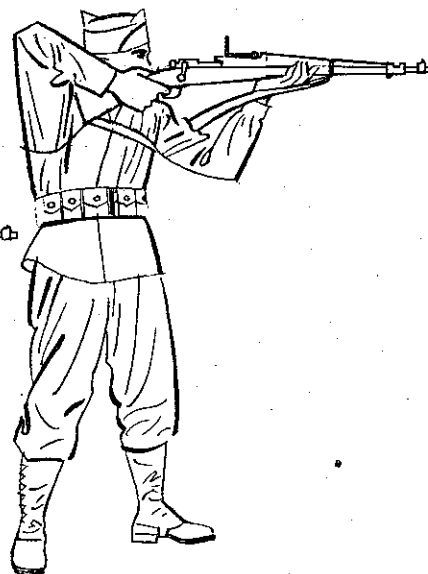

STANDING POSITION

1. Feet one to two feet apart — well balanced.
2. Left elbow well under rifle.
3. Right elbow at height of shoulder or higher.
4. Butt of piece high on shoulder and firmly held.
5. Cheek pressed against stock.

### PRONE POSITION

1. Body should lie at an angle of 45° to line of aim.
2. Legs apart — inside of feet flat on ground.
3. Elbows well under the body so as to raise chest.
4. Cheek pressed against stock — eye close to rear sight.

Those of you who aim and squeeze will get yourselves a Japanese.

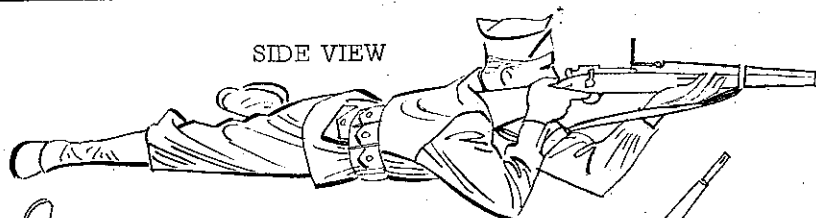

SIDE VIEW

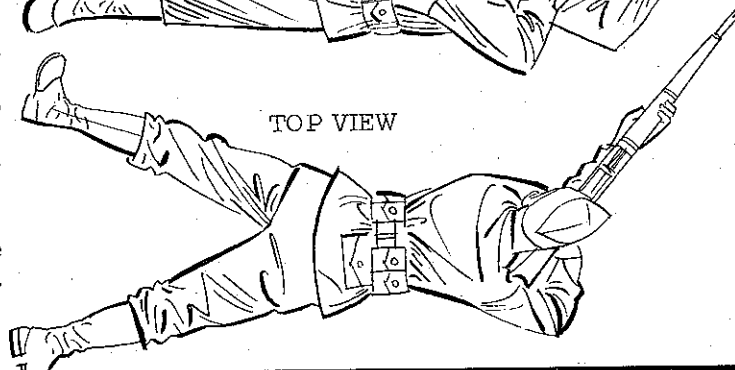

TOP VIEW

### IMPORTANT POINTS IN FIRING A RIFLE

1. Keep sling properly adjusted — tight enough to give support — high up on arm.
2. Assume proper position.
3. Take up slack in trigger promptly.
4. Sight and aim correctly, keeping eye on target.
5. Hold breath while aiming and SQUEEZE the trigger so that you do not know when the piece will be discharged.

## INDIVIDUAL SAFETY PRECAUTIONS

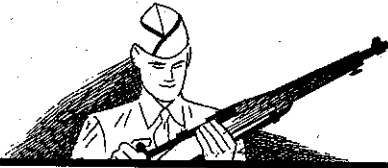

1. Consider every rifle to be loaded until you have examined it and proved it to be unloaded.

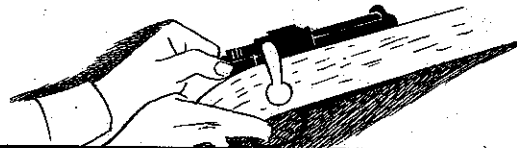

6. Do not let the firing pin down by hand on a cartridge in the chamber.

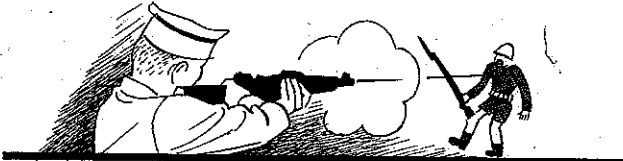

2. Never point the rifle at anyone you do not intend to kill, nor in a direction where an accidental discharge may do harm.

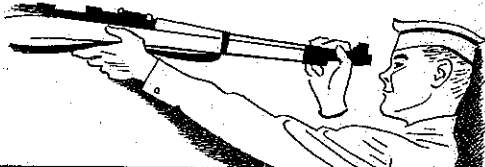

7. Be sure that the rifle is clean and dry before firing. Remove all traces of oil or dust.

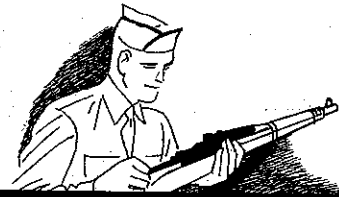

3. Always unload the rifle if it is to be left where someone else may handle it.



8. Never grease or oil the ammunition or the walls of the rifle chamber --- clean rifle before firing.



4. Always point the rifle up when snapping the trigger after inspection.



9. See that the ammunition is clean and dry --- examine all live and dummy ammunition.

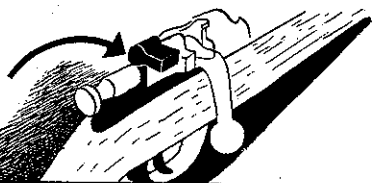

5. Keep safety lock on when there is a cartridge in the chamber.



10. Keep ammunition from direct rays of the sun.

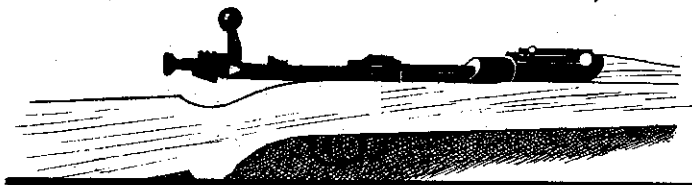

11. Keep the bolt open when not using rifle on the firing line.

## DUTIES OF THE COACH

SAFETY FIRST!

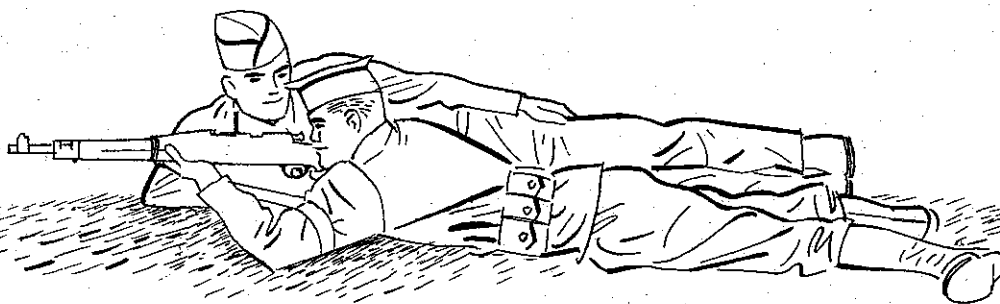
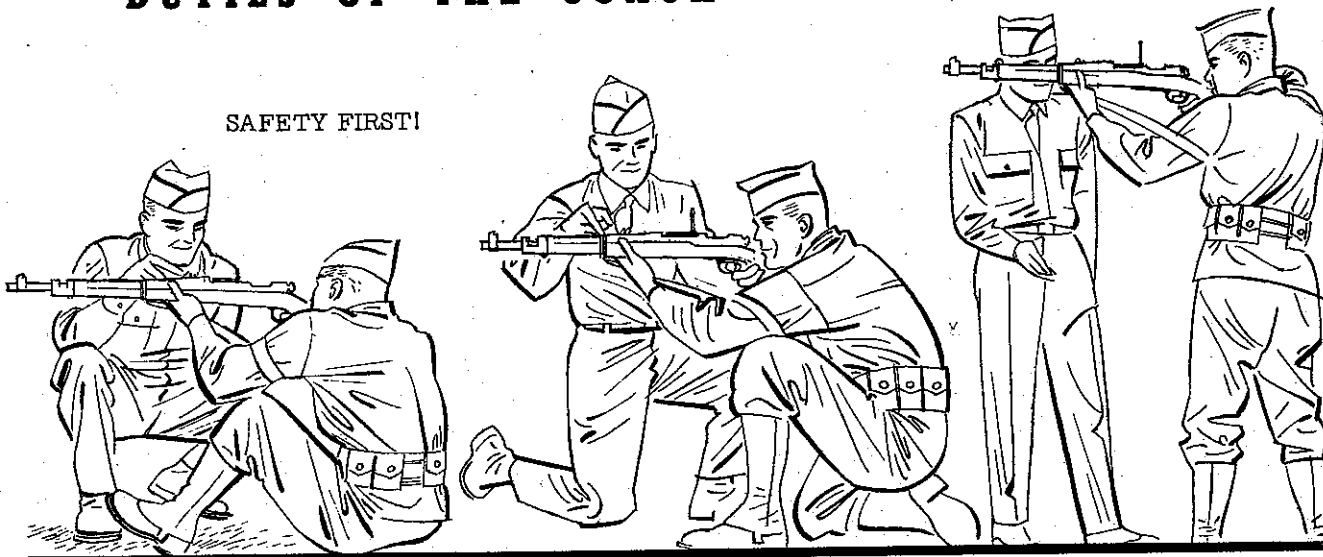

On the firing line the coach will take a position similar to that of the man who is firing — prone, sitting, kneeling, standing — so as to be able to watch his trigger finger and his eye. The coach observes the pupil carefully and corrects all errors. He pays particular attention to see that —

1. The sights are blackened and that they are set at the correct range.
2. The ammunition is free from dirt.
3. The pupil has the correct position, gun sling properly adjusted, body at proper angle, elbows correctly placed and the cheek pressed firmly against the stock.
4. The slack is taken up promptly.
5. The trigger is squeezed properly.
6. The pupil fires without flinching (watch his eye).
7. The pupil calls his shot each time he fires.

8. The pupil keeps his score book correctly.
9. The pupil is holding his breath properly (by watching his back occasionally). If the pupil spends more than six or eight seconds in aiming and holding his breath, have him start again.
10. The pupil shoots well. If not, have him fire a few "dry shots", checking his eye and follow through.

In addition to the above the coach will pay attention during rapid fire to see that —

1. The bolt is working rapidly.
2. While working the bolt the pupil keeps his eye on the target, the rifle to his shoulder, and his elbows in place. Watch the man's eye, not the target. If you detect the pupil closing his eye, he is doing it before the explosion. Caution him to follow through, relax, keep looking, and not to force it.
3. The magazine is reloaded from a clip properly and quickly.

# CERTIFICATE OF QUALIFICATION



THIS IS TO CERTIFY THAT

\_\_\_\_\_ *with diligent application and conscientious effort*

*did on \_\_\_\_\_ complete the prescribed Course  
in Rifle Marksmanship with the United States Rifle Cal. 30,  
and did qualify as \_\_\_\_\_ as prescribed by the  
provisions of Army Regulations 775-10. He is thereby entitled to  
wear the appropriate badge in accordance with that qualification.*

\_\_\_\_\_  
\_\_\_\_\_



# EXTENDED ORDER DRILL

## GENERAL RULES

1. Purpose — to provide for the orderly deployment of small units for battle.
2. Straight lines are avoided except when halted behind linear cover.
3. Platoon, section, and squad leaders deploy, assemble, and maneuver their units as far as practicable by ARM SIGNALS.

## WHISTLE SIGNALS

1. One (1) short blast — ATTENTION TO ORDERS
2. One (1) long blast (Accompanied by hand signal) — CEASE FIRING
3. Three (3) long blasts — AIR OR TANK WARNING

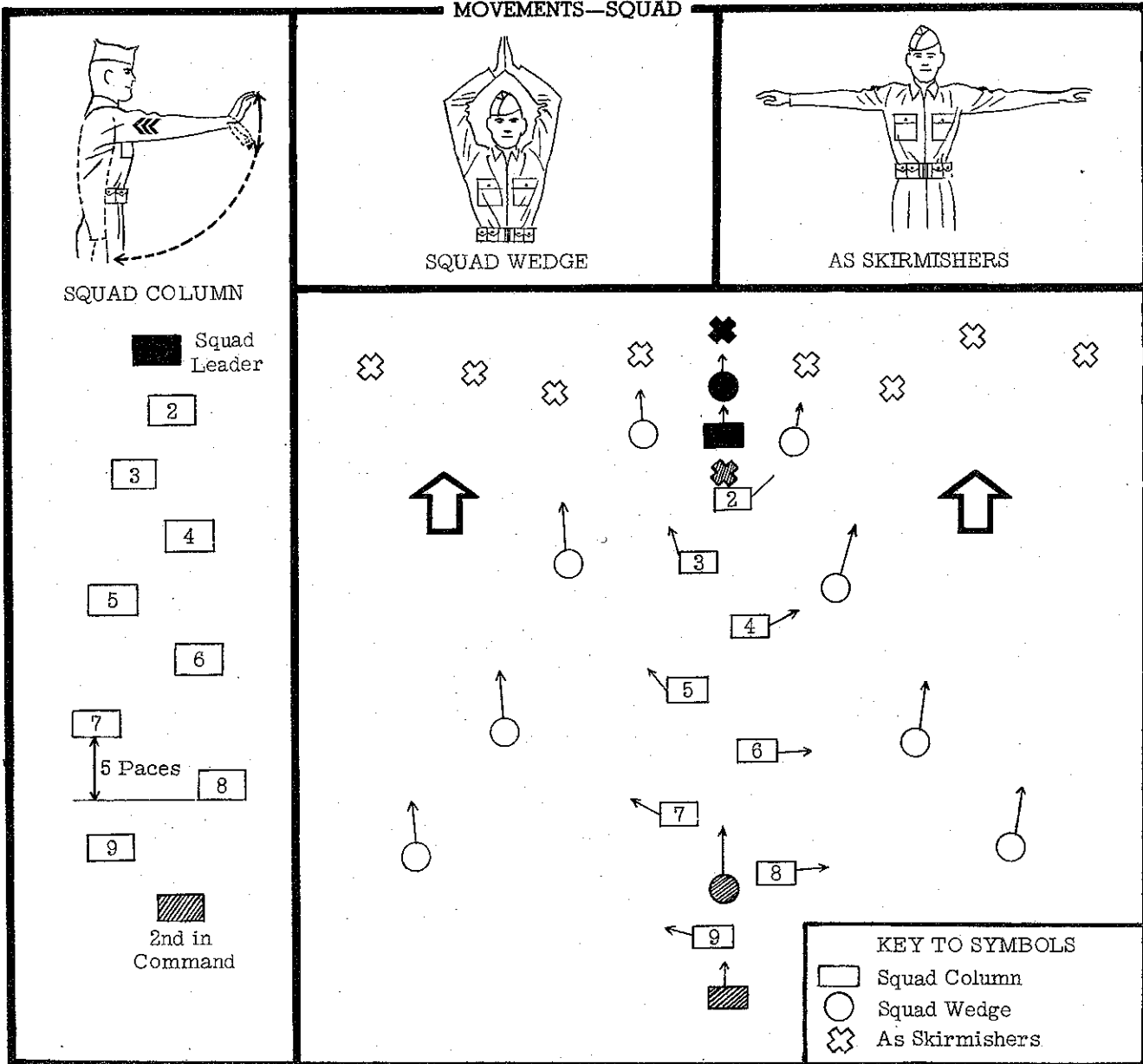

## ARM AND HAND SIGNALS

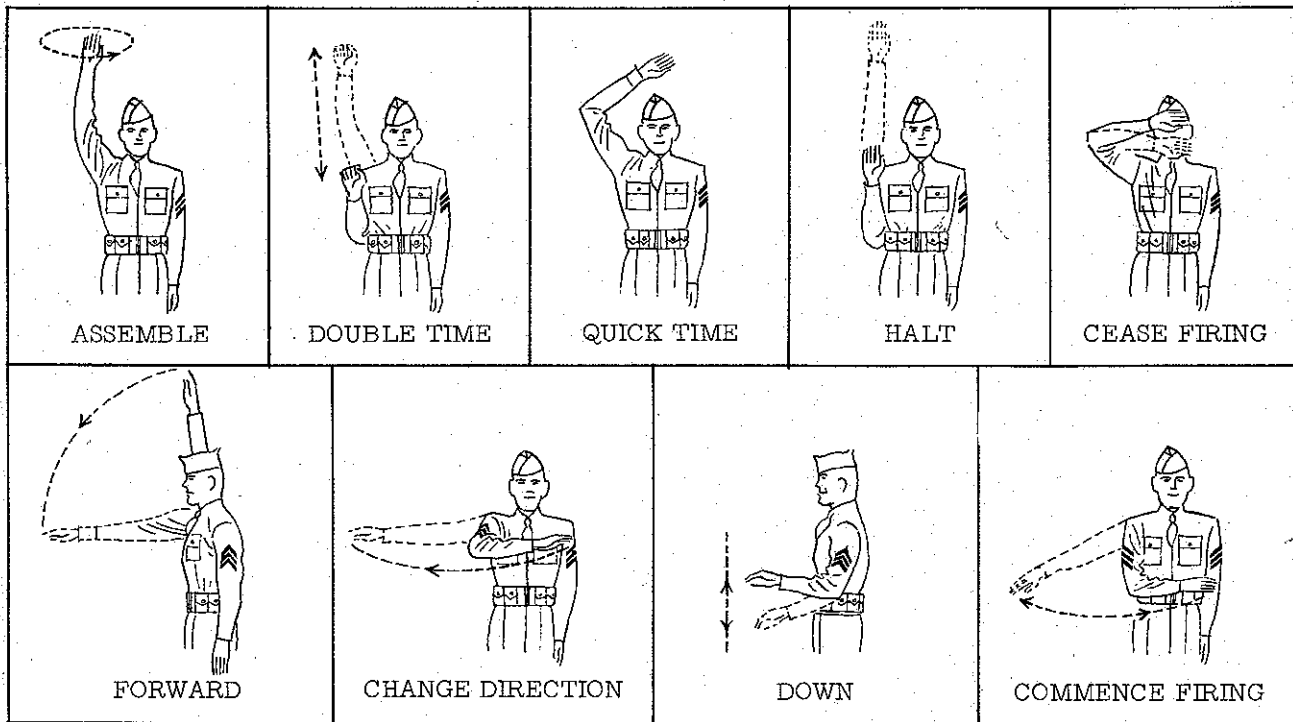

### DROPPING TO THE GROUND FROM A RUN

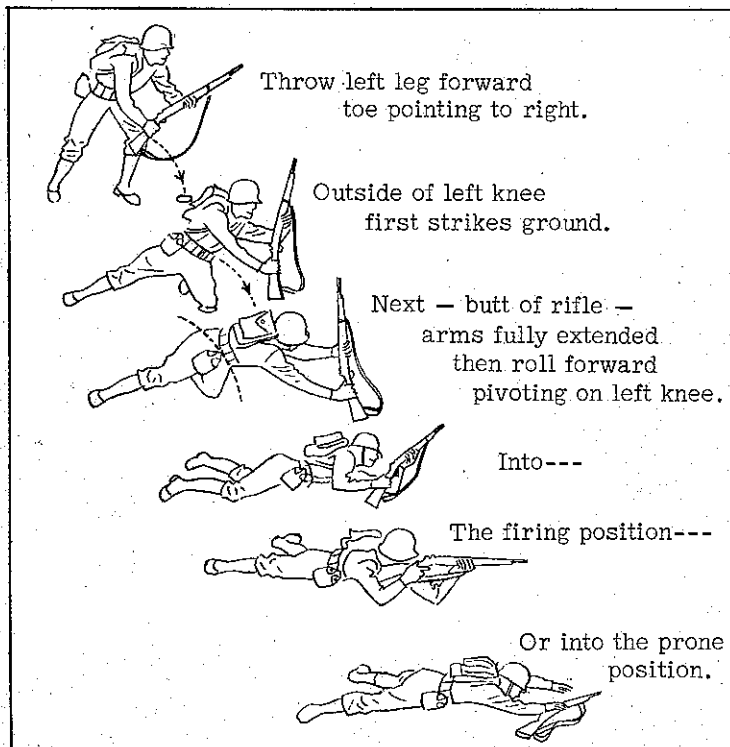

#### CREEPING POSITION

1. Rest body on lower legs, elbows, and forearms.
2. Lift chest and stomach slightly off ground.
3. Body low, head and buttocks down.
4. Keep knees always behind buttocks — drag body forward by alternately pulling with either arm.



#### CRAWLING POSITION

1. Chest and stomach remain on ground.
2. Draw hands slowly back beside your head, keeping elbows down.
3. Draw up either leg and push body forward.

# HASTY FIELD FORTIFICATIONS

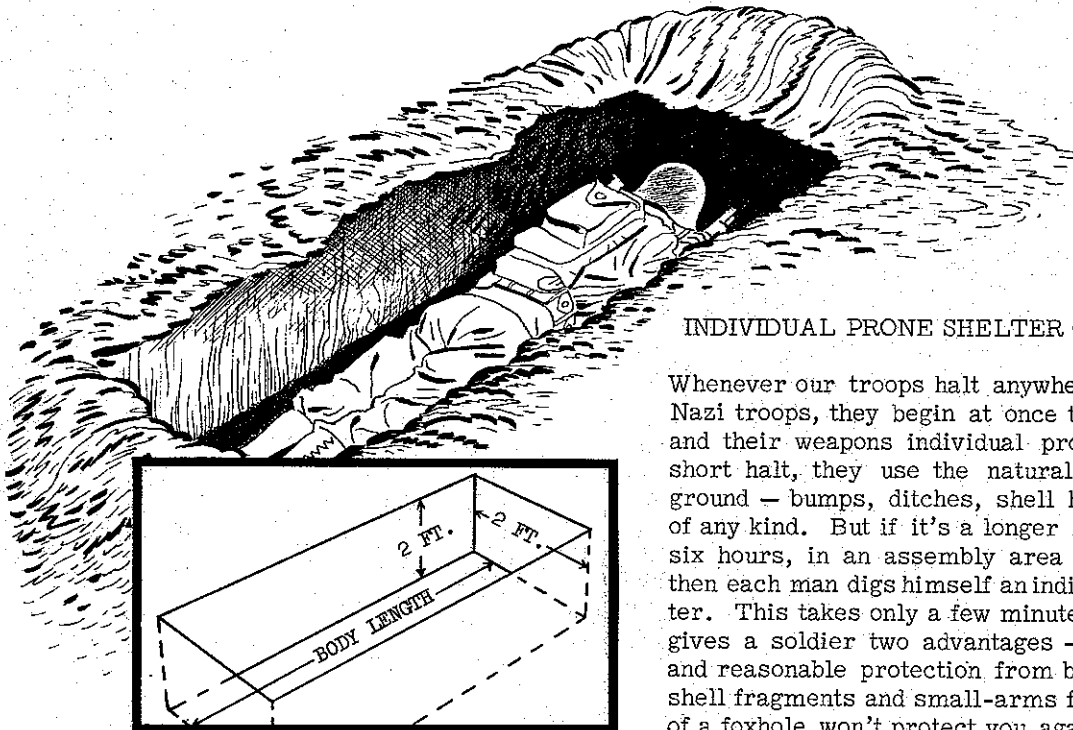

INDIVIDUAL PRONE SHELTER OR SLIT TRENCH

Whenever our troops halt anywhere near the Jap or Nazi troops, they begin at once to give themselves and their weapons individual protection. If it's a short halt, they use the natural protection of the ground — bumps, ditches, shell holes, depressions of any kind. But if it's a longer halt (but less than six hours, in an assembly area before an attack), then each man digs himself an individual prone shelter. This takes only a few minutes. Such a shelter gives a soldier two advantages — a chance to rest and reasonable protection from bomb, mortar, and shell fragments and small-arms fire. But this kind of a foxhole won't protect you against a tank attack.

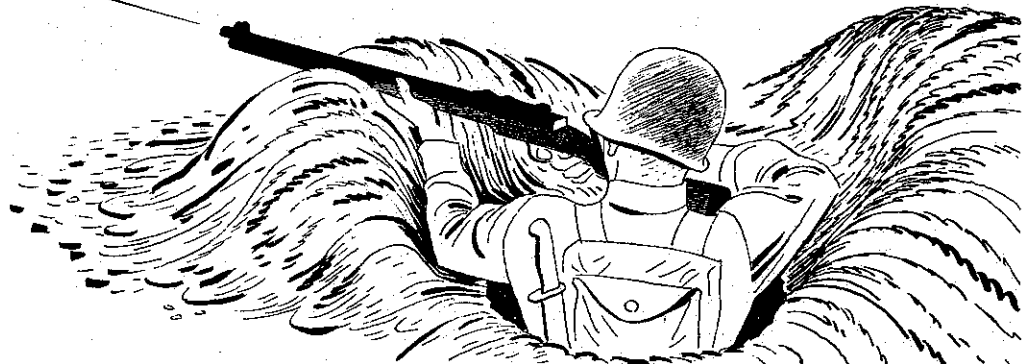

STANDING TYPE FOXHOLE

If an outfit is to halt for more than five or six hours, it goes to work at once on standing-type one-man foxholes. These will protect you against all bombs and shells (except direct hits), bomb and shell fragments, and small-arm fire. And if you dig your foxhole deep enough to leave a clearance of two feet or more between you and the ground surface, when you're crouched down in the bottom, you'll have protection against the average Nazi or Jap tank. When you start to dig this foxhole, you put the sod to one side. The rest of the dirt you pile irregularly around the edges of the hole. And then, when you're through digging, you use the sod to cover the rest of the dirt.

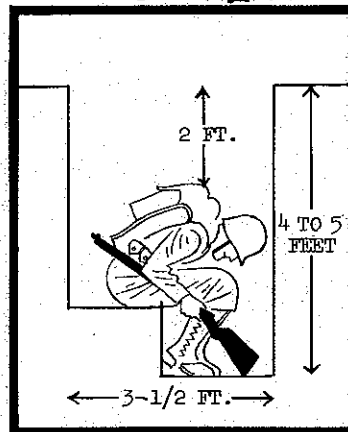

# CAMOUFLAGE

THE PURPOSE OF CAMOUFLAGE is to prevent the enemy from finding our positions. Even if it fails in this, it is valuable in preventing accurate bombing. Ordnance troops should know camouflage because they have the responsibility of maintaining important supply points. In the field, advice and material for camouflage construction will come from the Engineers.

The enemy uses two main methods of detecting camouflage: observation and aerial photography. Aerial photography will be the most difficult to overcome.

RULES OF CAMOUFLAGE: (Know and understand them well)

1. Assume that area has already been photographed and make no change visible from the air.
2. Use natural materials wherever possible.
3. Avoid regularity, straight lines, and square corners.
4. Break up shadows.
5. Choose a proper location.
6. Observe camouflage discipline.

## IN TAKING UP A NEW POSITION WHERE CONCEALMENT IS NECESSARY:

1. Decide how to best make use of the existing pattern.
2. Plan how to reach your position without leaving tracks for the enemy to follow.
3. Avoid or hide the mess due to digging, building, etc.
4. Hide or disguise the shadows. Cover the shiny surfaces.
5. Match the color of surroundings as well as you can. But remember that it is more important to have the correct texture than the correct color.
6. See that all men in the unit understand the camouflage plans. Avoid tracks. Reduce movement to a minimum. Maintain and preserve the camouflage.



WRONG-Shadow cast when sun is low helps an enemy locate you

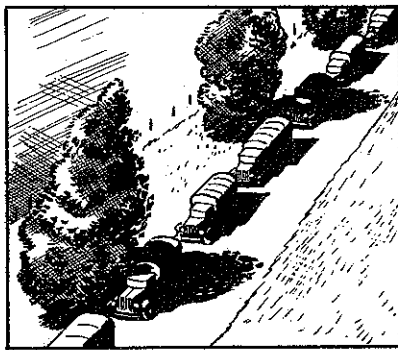

WRONG-Partial concealment affords protection to none

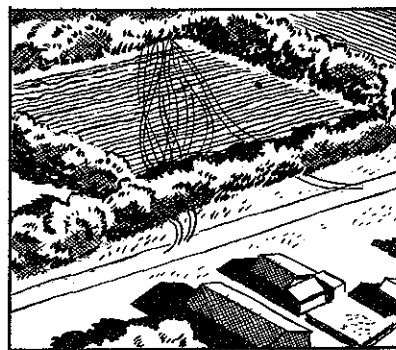

WRONG-Excellent concealment is ruined by numerous tracks



RIGHT-Avoid casting shadow by keeping close to the ground

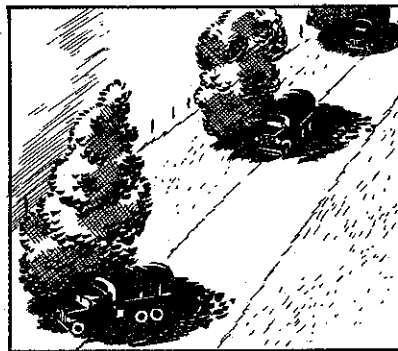

RIGHT-Concealment of each vehicle increases protection for all

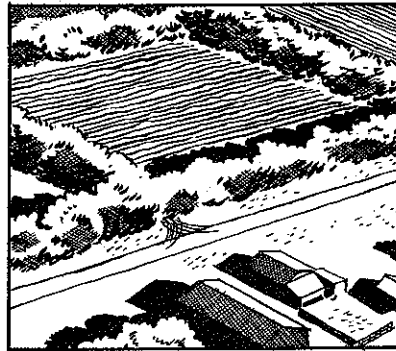

RIGHT-Restrict tracks to the cover of trees and bushes

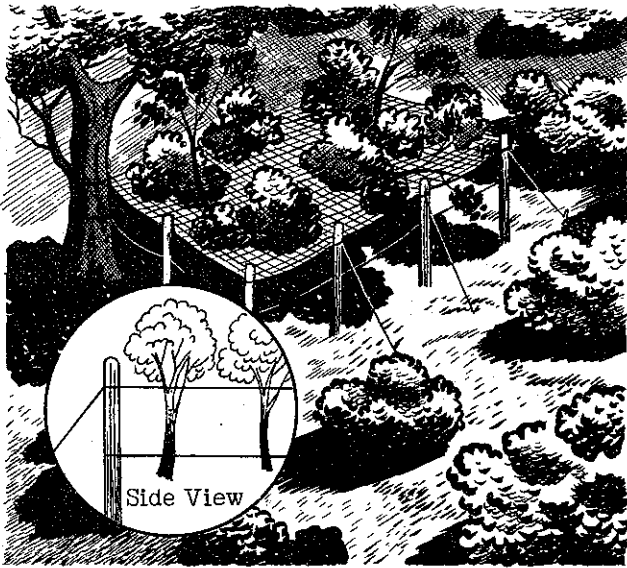

FLAT TOP (NATURAL MATERIALS)

Keep top flat. Place trees and shrubs vertically, tying to supporting wire. Make outline of complete installation irregular. Change natural material periodically.

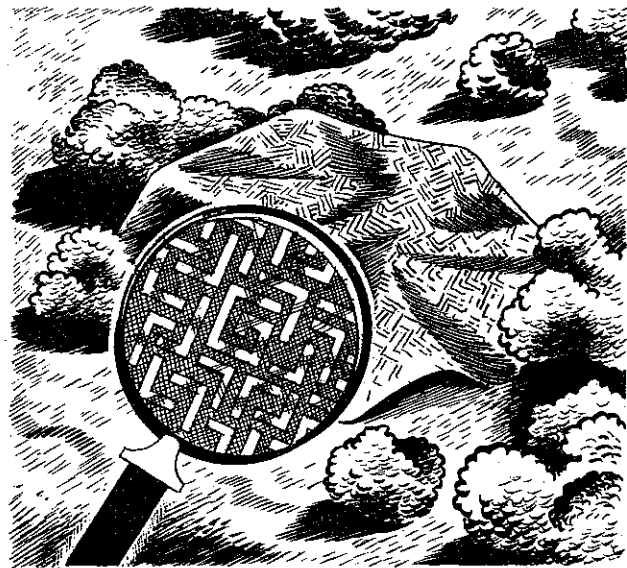

GARNISHING (ARTIFICIAL MATERIALS)

Use burlap or oznaburg strips, 2 inches wide and 5 feet long, painted with cold water paint. Weave strips into net, 90% in center, thinning out to 10% at sides.

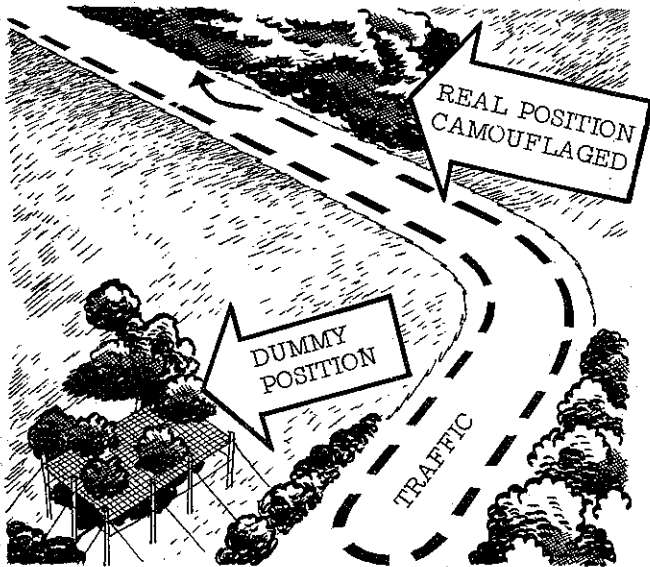

DECEPTION

Install dummy position, sparsely camouflaged at least one-half mile from real supply point. Make traffic pass real position and move to dummy position before turning around.

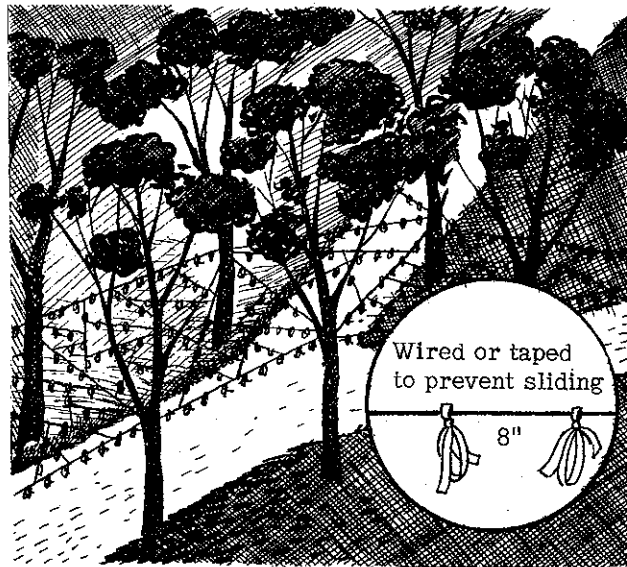

GARLANDS

Double 40 inch strips of painted burlap or oznaburg, and knot doubled strip in center, fastening to long wire. This is used to thicken insufficient natural cover about installations or along supply routes.

# DEFENSE AGAINST CHEMICAL ATTACK

CHEMICAL AGENTS					
COMMON NAMES	CW SYMBOL	PHYSICAL STATE	PERSISTENCY	TACTICAL USE	PHYSICAL EFFECT
Chlorine	C1	Gas	Non-persistent	Casualty	Lung Irritant
Phosgene					
Chlorpicrin					
Mustard					
Lewisite					
Adamsite					
Chlor-acetophenone					
Hexa-chlorethane					
White Phosphorus					
Thermit			X		
Magnesium			X		

**INDIVIDUAL PROTECTION IS OBTAINED BY:**

1. \_\_\_\_\_
2. \_\_\_\_\_
3. \_\_\_\_\_

**DECONTAMINATION**

1. Purpose \_\_\_\_\_  
\_\_\_\_\_
2. Agents used \_\_\_\_\_  
(a) \_\_\_\_\_  
\_\_\_\_\_  
(b) \_\_\_\_\_  
\_\_\_\_\_

**FIRST AID**

1. Lung irritant casualties:  
(a) \_\_\_\_\_  
(b) \_\_\_\_\_  
(c) \_\_\_\_\_
2. Vesicant casualties:  
(a) \_\_\_\_\_  
(b) \_\_\_\_\_  
\_\_\_\_\_

**IDENTIFICATION**

of chemical agents is obtained by recognizing their  
\_\_\_\_\_  
\_\_\_\_\_

**PRINCIPAL CHEMICAL AGENTS**

PROPERTIES	COMMON NAME	CW SYMBOL	ODOR IN AIR	EFFECT ON BODY	CASUALTY DEVELOPS	FIRST AID
VESICANT	Mustard	HS	Garlic, Horseradish	Burns skin and lung tissue, temporary blindness	4 to 24 Hours.	Wash; apply weak bleach solution; wash eyes with boric acid.
	Lewisite	M1	Geraniums	Burns skin and lung tissue; arsenic poisoning	30 min.	Wash; apply 5% solution of caustic soda, followed by alcohol.
LUNG IRRITANT	Chlorine	C1	Pungent	Burns upper respiratory tract	At Once	Keep quiet and warm; DO NOT EXERCISE
	Phosgene	CG	Fresh cut hay	Burns eyes, respiratory tract lung edema	At Once or Delayed	Keep quiet and warm; give heart stimulants, NO ALCOHOL DO NOT EXERCISE.
	Chlorpicrin	PS	Sweet; Flypaper	Lacrimates; nausea; lung irritation	At Once to 4 hours	Keep quiet and warm; Wash; give light stimulants; DO NOT EXERCISE
IRRITANT SMOKE	Adamsite	DM	No odor Yellow cloud	sneezing; vomiting; headache; mentally depressing	5 to 10 minutes	Breathe chlorine from weak solution of bleaching powder.
LACRIMATOR	Chloracetophenone (Tear Gas)	CN	Apple blossoms	Eye and skin irritation	At Once	Face wind in pure air; Wash eyes with boric acid.
SCREENING SMOKE	White Phosphorus	WP	Wet matches	Smoke - none. Particles cause flesh burns	At Once	Apply 5% copper sulfate solution; moist earth; wash with hot water. Keep wet.
	Hexachlorethane	HC	Sweet, Astringent	None	None	Not necessary
INCENDIARY	White Phosphorus	WP	X	Flesh burns	At Once	Treat as ordinary heat or fire burns; WP as above.
	Thermit	Th				
	Magnesium	Mg				

LEARN this chart, KNOW how to protect yourself, KEEP your head, and you are SAFE.

## GAS MASK DRILL

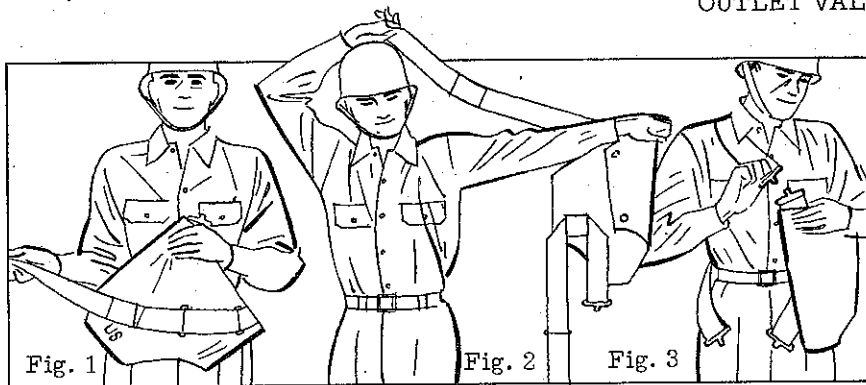

### TO SLING THE MASK

1. At the command SLING MASK- hold carrier with left hand, at shoulder strap clasp, waist high, in front of body with U. S. marking away from body. Move the right hand to the front of the carrier, take hold of shoulder strap, straighten strap, and extend to the right. (Fig. 1.)

2. Extend left arm to the left following with right arm. Pass shoulder strap over left hand and elbow, over the head, over right shoulder, and engage the clasp. Fasten the body strap. (Figs. 2 and 3.)

### TO UNSLING THE MASK

1. At the command UNSLING MASK--unfasten body strap. Grasp carrier with left hand at shoulder strap clasp. Using both hands, unfasten the clasp. Hold carrier with left hand, waist high. (Fig. 1.)

NOTE: To sling carrier with full field equipment, sling the mask. Sling the pack. Unfasten the left front pack suspender strap and pass it under the carrier shoulder strap. Resnap suspender strap to its proper hole and fasten cartridge belt.

### TO ADJUST THE MASK

1. At the command GAS--dispose of arms, etc. between legs. If wearing a soft cloth headdress, remove with the right hand and at the same time open the carrier flap with the left hand. Place headpiece under belt, between legs, or between carrier and body. If wearing headdress with chin strap, place left hand at chin, lift headdress to front, slide onto left arm and suspend from elbow. Grasp lower part of facepiece with the right hand. Bring the facepiece smartly out of the carrier to a

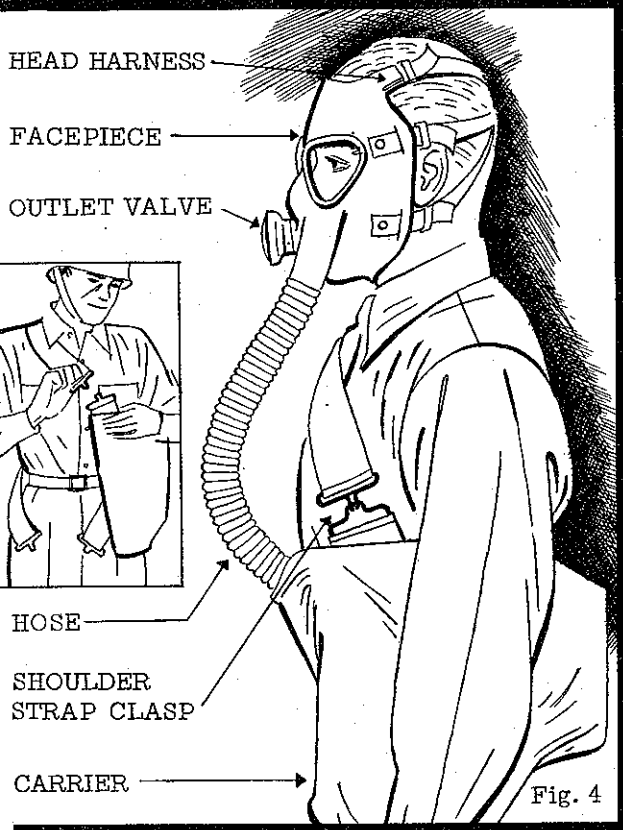

point in front of the face, chin high. Slide thumbs inside and under the lower head harness straps to top of facepiece, fingers extended and joined outside the facepiece. Thrust out the chin. (Fig. 5.)

2. Hook mask under chin. Sweep head harness over the head. Center harness pad well down on the back of the head. (Fig. 6.)

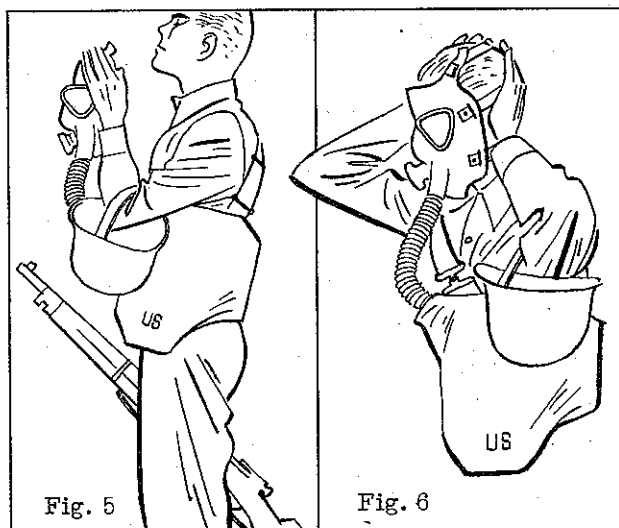



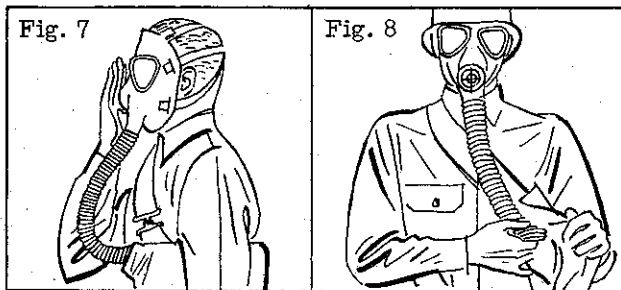

3. Close outlet valve with the right hand and exhale vigorously to clear the facepiece (Fig. 7). Seat edges of the facepiece to the face, beginning with palms of both hands at the chin and with an upward and backward sweeping motion press out all irregularities and channels.

4. Check the mask by squeezing together the walls of the hose near the canister. Exhale fully. Inhale. (Fig. 8.) The facepiece should collapse against the face if there are no leaks. Replace headpiece. Fasten carrier flap around the hose after removing as much hose as possible. Resume original position.

NOTE: Without the numbers, at the command GAS, STOP BREATHING. Ability to hold the breath for 20 seconds or more under conditions of excitement should be developed. Resume breathing after the facepiece is cleared.

#### TO REMOVE AND REPLACE MASK

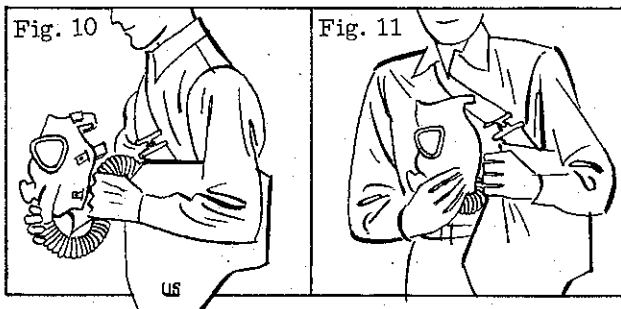

1. At the command REMOVE AND REPLACE MASK. Test for gas -- take a full breath, exhale a small portion, and stop breathing. Stoop so as to bring the face as close to the ground as possible without touching the ground with anything other than the soles of the shoes. Break the seal of the mask by inserting two fingers between the facepiece and the cheek. (Fig. 9.) Sniff. Remove the fingers and clear the facepiece. Stand up.

2. Remove the headpiece with the left hand. Grasp the mask by taking hold of the hose at the base of the facepiece with the right hand. Pull the mask down, away, and over the head. Place the mask over left arm or shoulder. Replace headpiece. Take facepiece in the right hand, chest high, with edges of facepiece to the left.

3. With the left hand, open the carrier flap, tuck head harness inside the facepiece, take hold of the hose near the canister. Move the facepiece toward

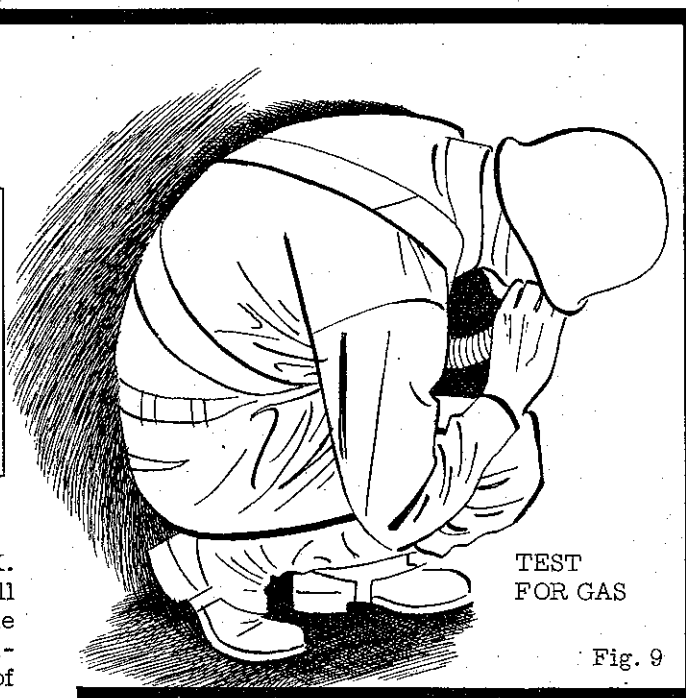

TEST  
FOR GAS

Fig. 9

the left hand. Insert the hose in the facepiece. (Fig. 10). Regrasp with the right hand just below the eyepieces. Hold carrier flap open with the left hand. (Fig. 11.)

4. Insert facepiece, loop of hose first, in the carrier. Bring the hose into the circular pocket in the bottom of the carrier. Pull the facepiece up so that it is opposite the carrier opening. Check with both hands to see that the hose and mask are fitted in the carrier without distortion or kinking. Fasten the carrier using the rear snap.

# GERMAN MAGNESIUM BOMBS

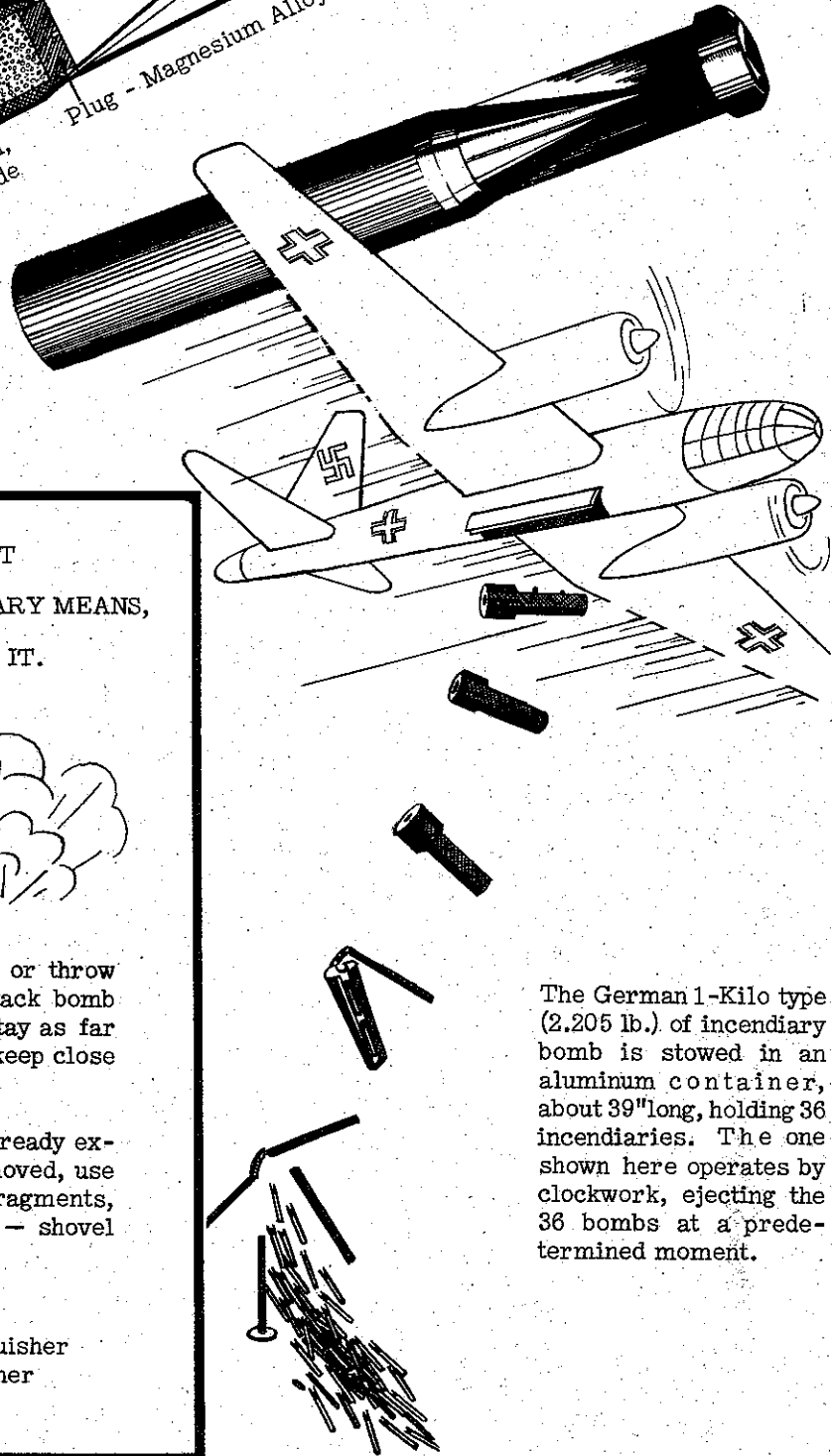
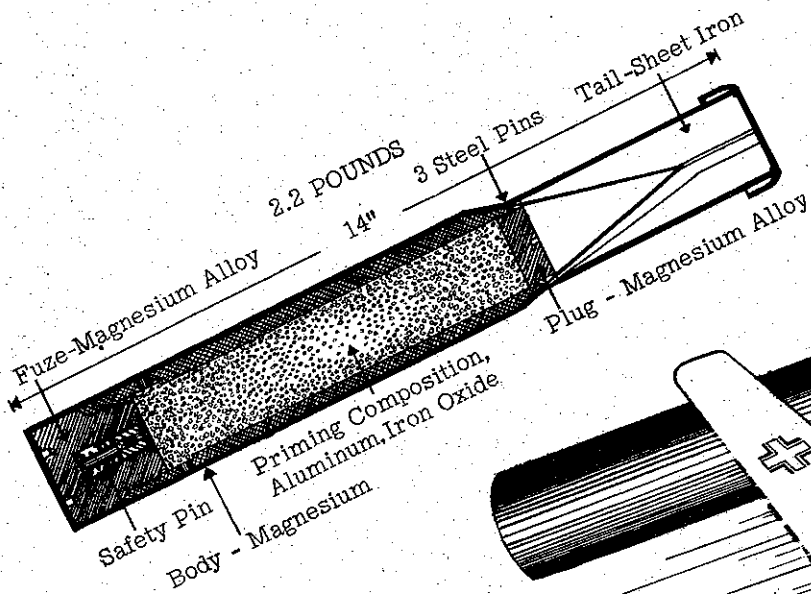

YOU CANNOT PUT OUT  
AN INCENDIARY BOMB BY ORDINARY MEANS,  
BUT YOU CAN CONTROL IT.

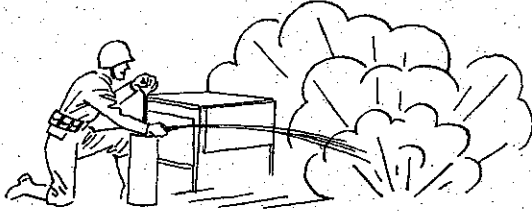

Use a strong stream of water or throw dippers of water on bomb. Attack bomb first, other fires afterward. Stay as far away from bomb as possible, keep close to the floor.

Water is best, but if bomb has already exploded and fragments must be moved, use sand. Place sand alongside fragments, move them on sand, and cover - shovel into bucket lined with sand.

### DO NOT USE

Carbon Tetrachloride Extinguisher  
Carbon Dioxide Extinguisher  
(forms poison gas)

The German 1-Kilo type (2.205 lb.) of incendiary bomb is stowed in an aluminum container, about 39" long, holding 36 incendiaries. The one shown here operates by clockwork, ejecting the 36 bombs at a pre-determined moment.

# MAP READING

A map is a scale drawing of a portion of the earth's surface as seen from directly above. A map is also a source of information, but to get information from it, we must know how to read it.

INFORMATION AS TO THE NATURE OF THE TERRAIN IS GIVEN BY A SYSTEM OF:

1. COLORS	2. STANDARD SYMBOLS	3. MILITARY SYMBOLS
_____ Man-made objects	_____ Building	_____ Squad _____ Regiment
_____ Vegetation	_____ Church	_____ Section _____ Brigade
_____ Water	_____ School	_____ Platoon _____ Division
_____ Danger Areas	_____ Swamp	_____ Company _____ Corps
_____ Elevation	_____ Railroad	_____ Battalion _____ Army
_____ (Contour Lines)	_____ Road	

To use a map, we must be able to recognize distances it represents on the ground.

Distance may be determined by the use of scales.

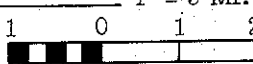
SCALE	EXAMPLE
a. _____	$\frac{1}{62500}$
b. _____	1" = 3 MI.
c. _____	

To use a map we must also be able to determine direction.

1. Direction is always measured from some type of North.

2. Direction of a line is indicated by AZIMUTH...angle measured clockwise from some type of north. Maximum Azimuth is 360 degrees.

TYPE	FOUND BY	SYMBOL
A. _____	_____	_____
B. _____	_____	_____
C. _____	_____	_____

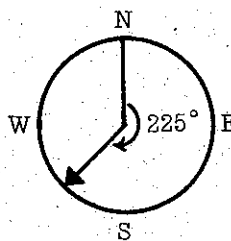

To locate a point on a map we use the military grid system.

The rule for using the military grid system is: \_\_\_\_\_



BEARING...angle from the north or south measured as so many degrees east or west of north or south. Maximum bearing is 90 degrees.

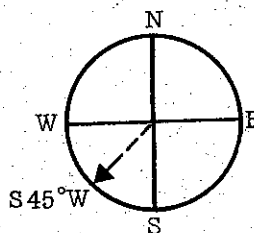

Before we can use a map we must orient it. We have two methods for orienting:

1. By pointing the North on the map toward North on the ground.
2. By placing the map so that landmarks on the map are in the same relative position as the visible landmarks on the ground.

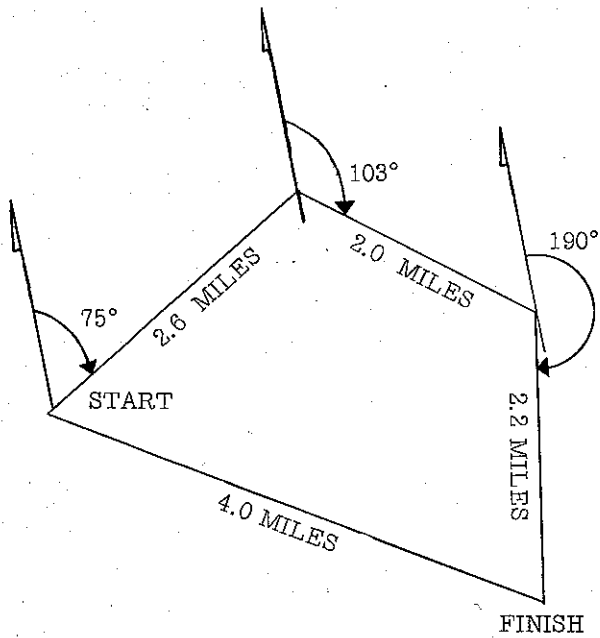

HOW TO NAVIGATE IN THE DESERT  
(Dead Reckoning)

Navigating by magnetic azimuth and distance travelled, soldier plots his route at each step of his journey in order to know his location at all times.

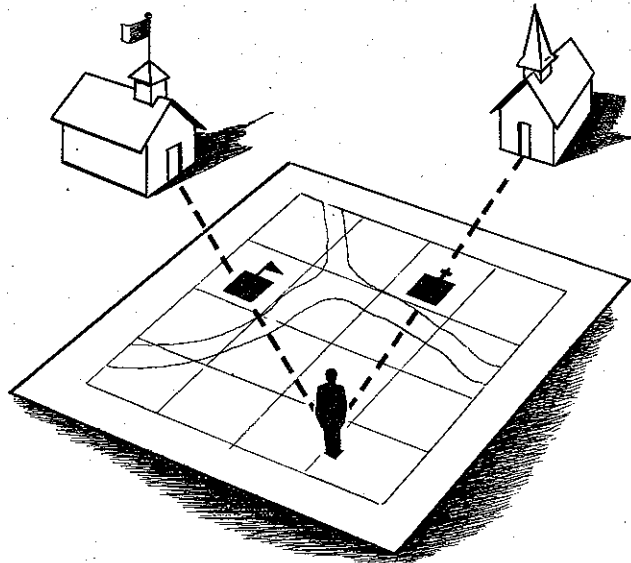

HOW A MAP AND VISIBLE LANDMARKS TELL  
YOU WHERE YOU ARE  
(Two point resection)

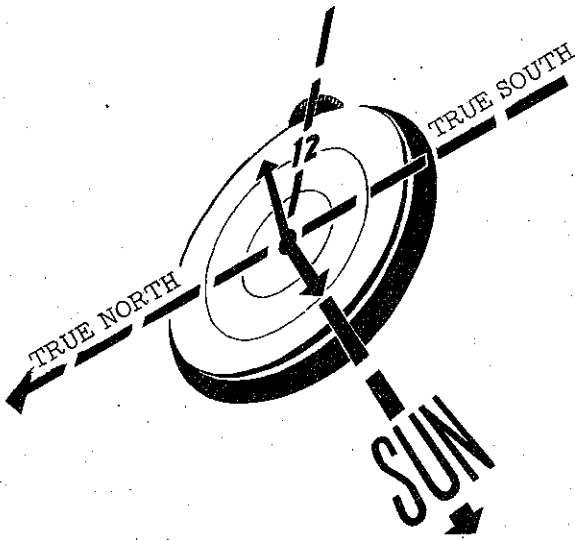

HOW TO FIND TRUE NORTH

BY DAY

Point the hour hand toward the sun. Halfway between 12 and the hour hand is south. The opposite direction points north.

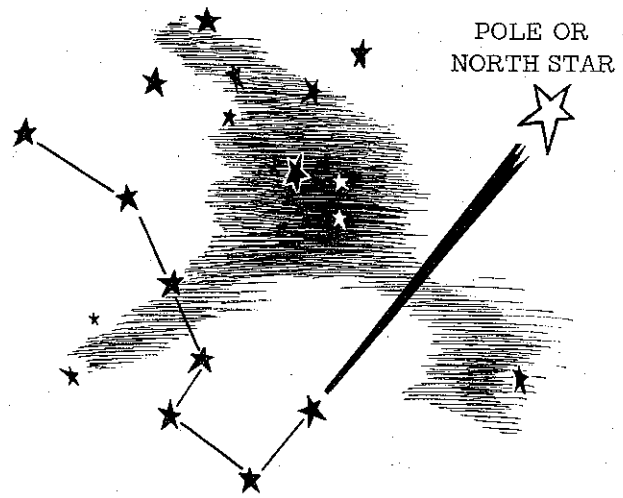





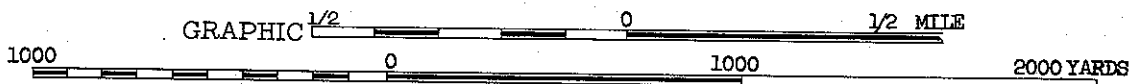
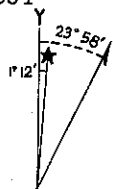
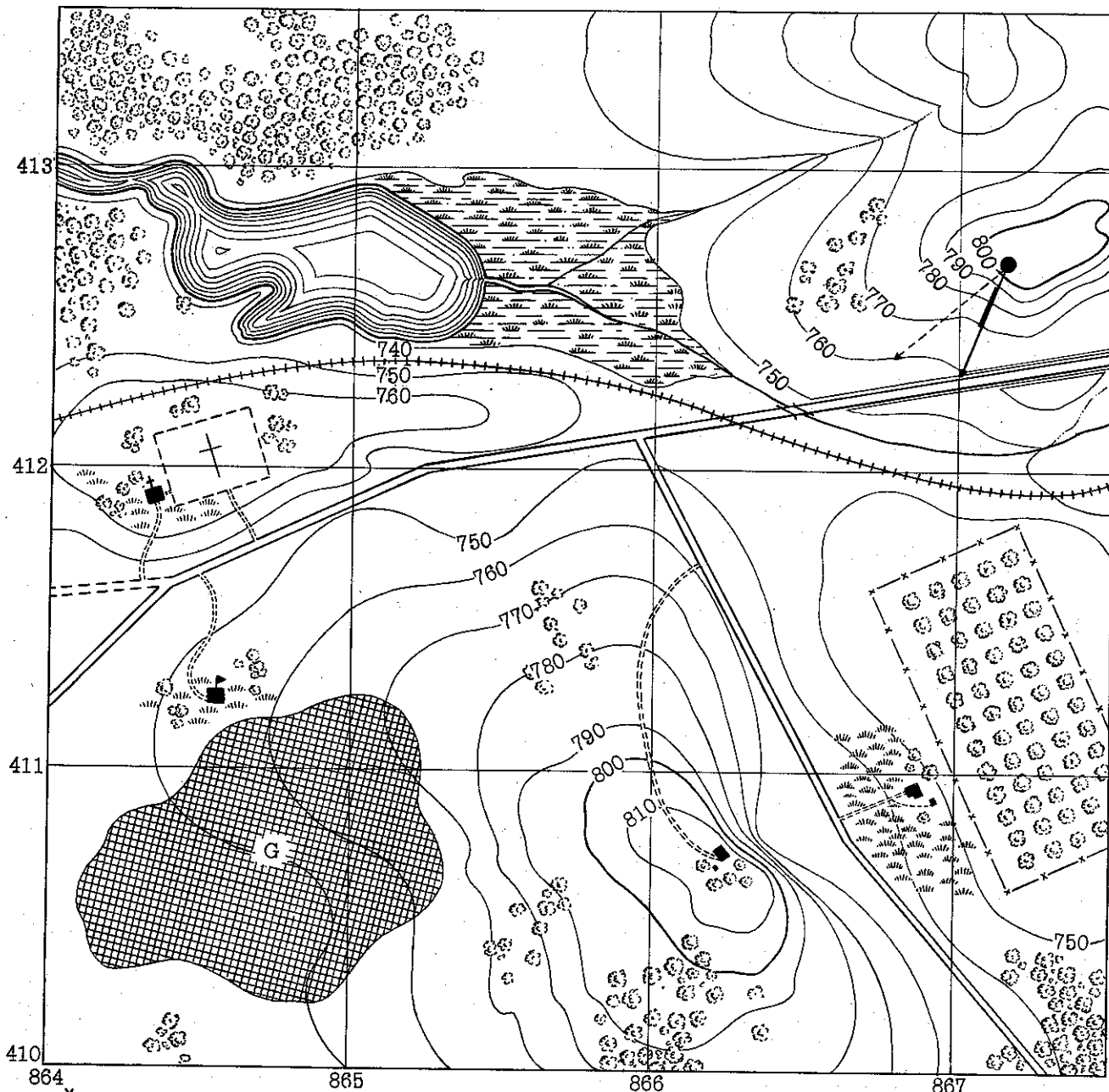

BY NIGHT

The North Star lies very close to the straight line formed by the two front stars of the Big Dipper.

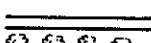
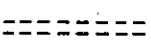

R. F.  $\frac{1}{20000} = \frac{1 \text{ unit on the map}}{20000 \text{ units on the ground}}$

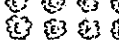
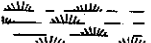
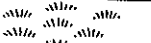
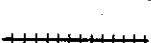
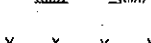
**LEGEND**

# DEFENSE AGAINST MECHANIZED ATTACK

Most important means of defense for Ordnance troops is proper utilization of terrain features which provide natural obstacles. Examples are:

A. \_\_\_\_\_  
 B. \_\_\_\_\_  
 C. \_\_\_\_\_

D. \_\_\_\_\_  
 E. \_\_\_\_\_  
 F. \_\_\_\_\_

Artificial barriers are constructed mainly to strengthen natural obstacles, and are classified according to the time required for erection.  
 EXAMPLES: Quick or semi-quick — a matter of several minutes to several hours.

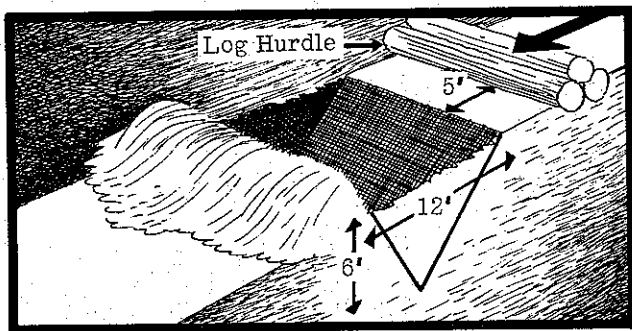

ANTITANK DITCH

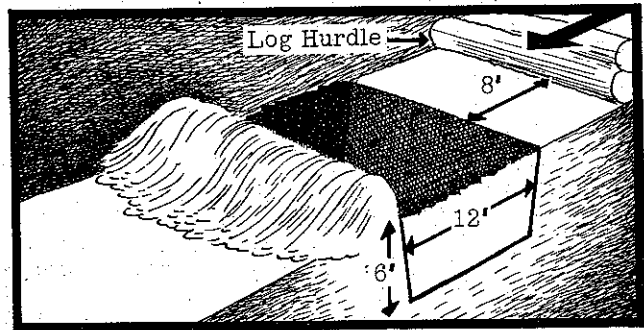

ANTITANK DITCH

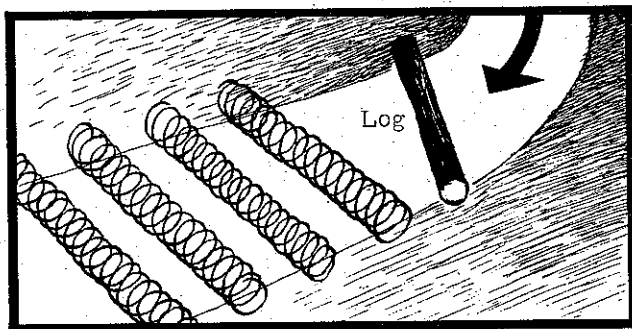

WIRE ROLLS

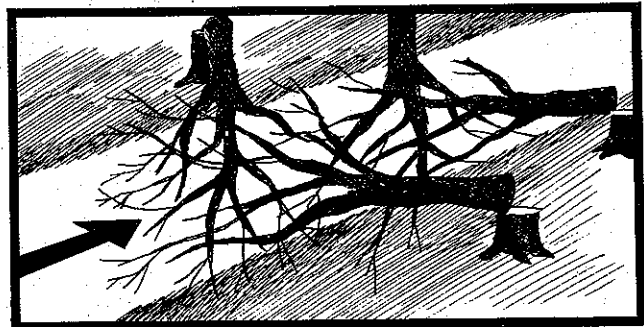

ABATIS

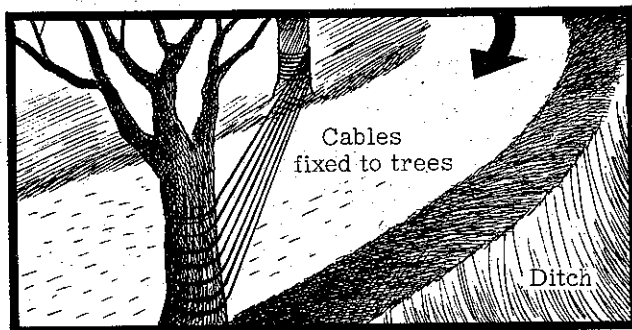

WIRE CABLES

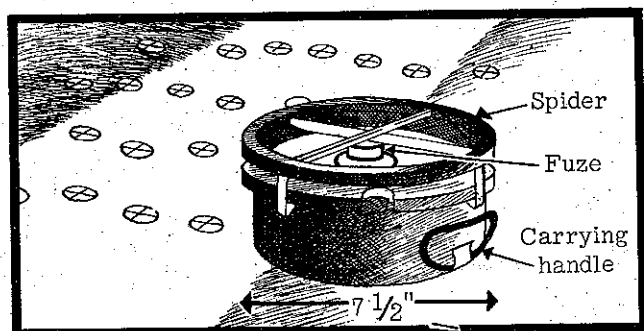

ANTITANK MINE

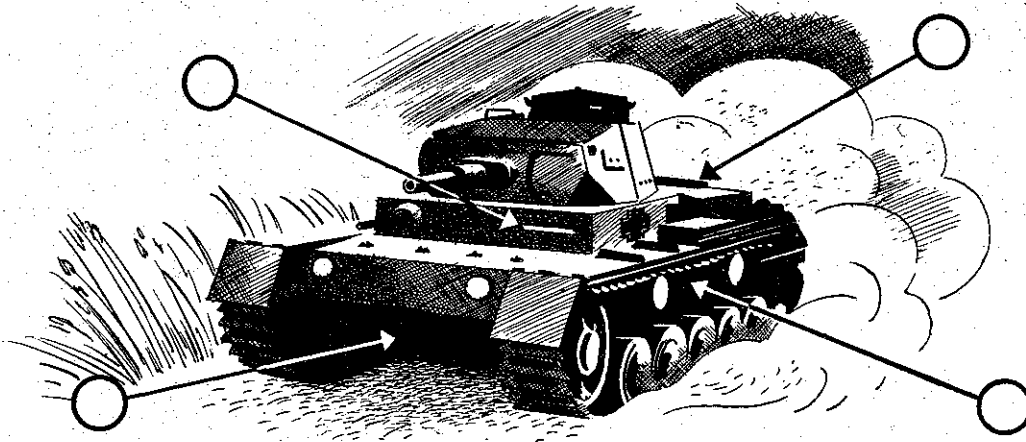

**VULNERABLE POINTS IN TANKS ARE:**

- a. Vision slits
- b. Ventilation slits
- c. Belly
- d. Line above bogie wheels and below tracks.

The fighting branches depend mainly on fire power for defense against tanks. Two standard U. S. anti-tank guns are 37 mm. and 75 mm. Small arms .30 and .50 cal. are effective only at close range.

Ordinarily Ordnance troops will use available means of defense merely for delaying action or obstruction. Their best protection is by moving quickly to a new position where work can be resumed.

**METHODS OF FIGHTING TANKS WHERE WEAPONS ARE LACKING:**

- A. \_\_\_\_\_
- B. \_\_\_\_\_
- C. \_\_\_\_\_
- D. \_\_\_\_\_

- E. \_\_\_\_\_
- F. \_\_\_\_\_
- G. \_\_\_\_\_
- H. \_\_\_\_\_

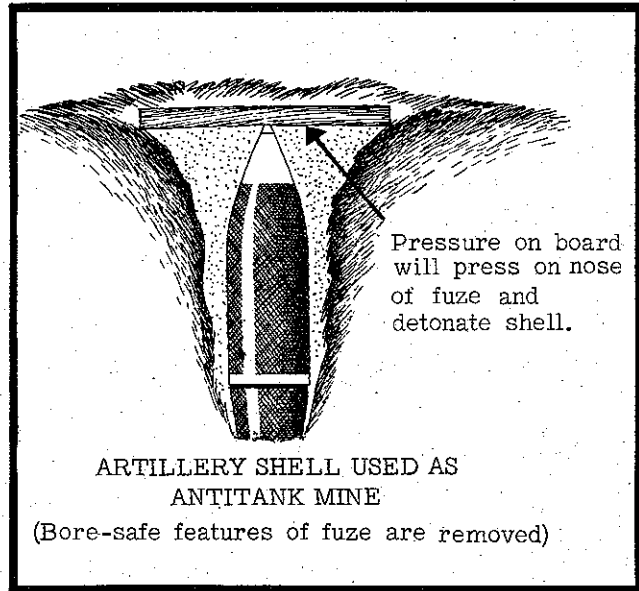
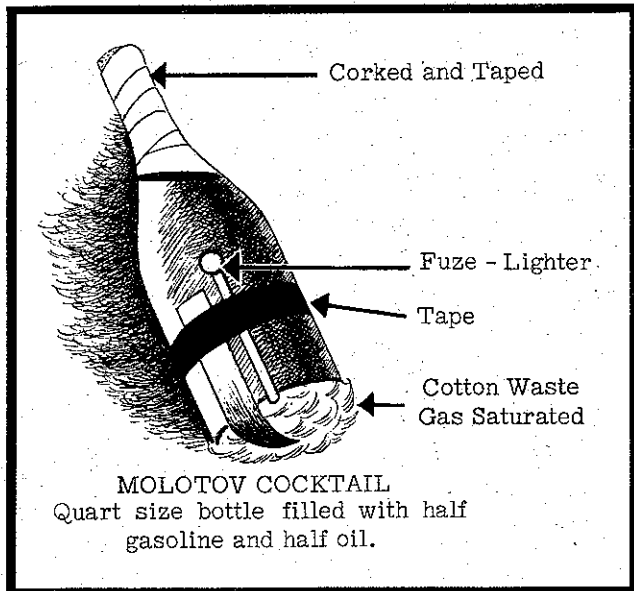

## IDENTIFICATION OF ARMORED VEHICLES

The ability to quickly and accurately identify hostile and friendly armored vehicles is of vital importance in modern warfare. Ready identification can be ac-

complished only by thorough study of the different types and by constant practice in observing all types of vehicles in the field.

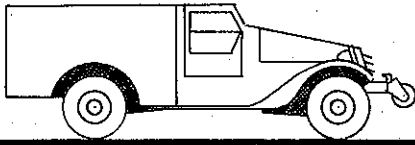

SCOUT CAR, M3A1

Four wheels and roller. Body protected by 1/4" armor plate and windshield by 1/2" armor plate. Armed with 2 MG's, cal..30, 1 MG, cal..50.

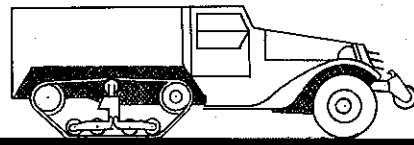

HALF TRACK CAR, M2

Two wheels and half track with one set of four bogie wheels. May have mounted a 37-mm Gun or 75-mm Gun, in addition to several MG's.

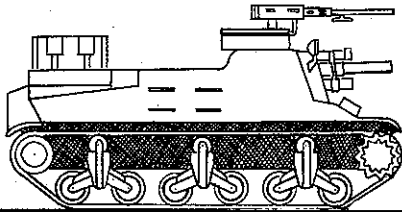

105-MM HOW. MOTOR CARRIAGE, M7

Three sets of two bogie wheels, 105-mm How. mounted on hull; 1 MG, cal..50.

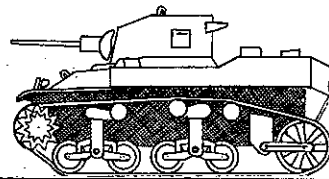

LIGHT TANK, M5

Two sets of two bogie wheels; 1 Gun, 37-mm, and 1 MG, cal..30 in turret; 1 MG, cal..30 in the hull.

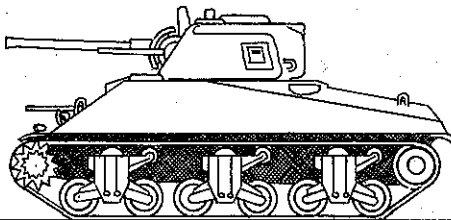

MEDIUM TANK, M4A2

Three sets of two bogie wheels; 1 Gun, 75 mm, and 1 MG, cal..30 in the turret; 1 MG, cal..30 in the hull.

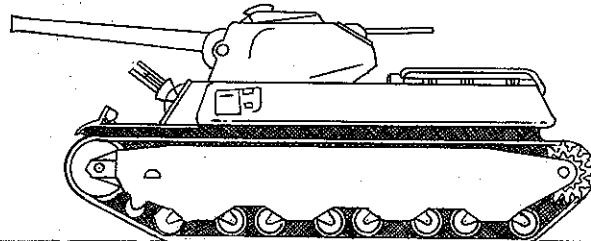

HEAVY TANK, M6

Four sets of two bogie wheels; 37-mm Gun mounted in cupola; 3-inch Gun mounted in turret; 3 MG's, cal..50 and 1 MG, cal..30 in hull.

AMERICAN MEDIUM TANK, M3

Three sets of two bogie wheels. Turret with 37-mm Gun and 2 MG's, cal..30.

Cupola with 1 MG, cal..30. 75-mm Gun.

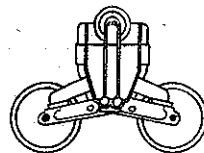
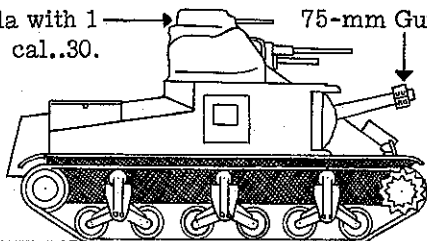

American Bogie Wheel Assembly

FOREIGN DESIGN

Squat hull. Row of even sized bogie wheels. Not mounted in pairs.

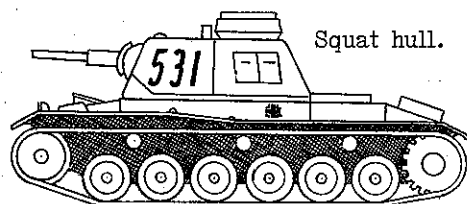

Squat hull.

United States armored vehicles always have bogie wheels in sets of two. It can be safe to assume that

any vehicle seen with separate bogie wheels is of foreign design, but not necessarily an enemy vehicle.



# DEFENSE AGAINST AIR AND PARATROOP ATTACK

ON THE MARCH, you may get only a few seconds warning. Don't make for distant cover (more than 10-15 yards away) or you'll give yourself and your buddies away. Flop down just off the road and don't look up. You are safest in a depression, but remember that ditches are systematically strafed.

IN A VEHICLE drive truck to side of road, set brakes and run for cover. Don't get under the vehicle, the principal target. Take cover as on march. IN BIVOUAC dig a slit trench at the first opportunity. When attacked, get in it and remain motionless. (See Hasty Field Fortifications, page 27.)

## POINTS TO REMEMBER—AIR ATTACK



1. WRONG - If you look up or move in the light of a flare, you will be seen.







2. RIGHT - In the light of a flare, freeze in position.

- A. \_\_\_\_\_
- B. \_\_\_\_\_
- C. \_\_\_\_\_
- D. \_\_\_\_\_
- E. \_\_\_\_\_
- F. \_\_\_\_\_
- G. \_\_\_\_\_

## POINTS TO REMEMBER—PARATROOP ATTACK

- A. \_\_\_\_\_
- B. \_\_\_\_\_
- C. \_\_\_\_\_

AIRCRAFT INSIGNIA				
U. S. A.	RUSSIA	BRITAIN	GERMANY	JAPAN
				
White and Blue	Red	Red, White and Blue	Black	Red

# IDENTIFICATION OF AIRCRAFT

It is essential that all army personnel be able to identify hostile and friendly aircraft. Due to the rapid movement and varying angles in flight, positive identification is extremely difficult. Identifica-

tion is aided by classifying all United States Army planes as either PURSUIT or INTERCEPTOR, LIGHT or MEDIUM BOMBARDMENT, and HEAVY BOMBARDMENT.

## BASIC WING SHAPES ARE IMPORTANT IN IDENTIFICATION

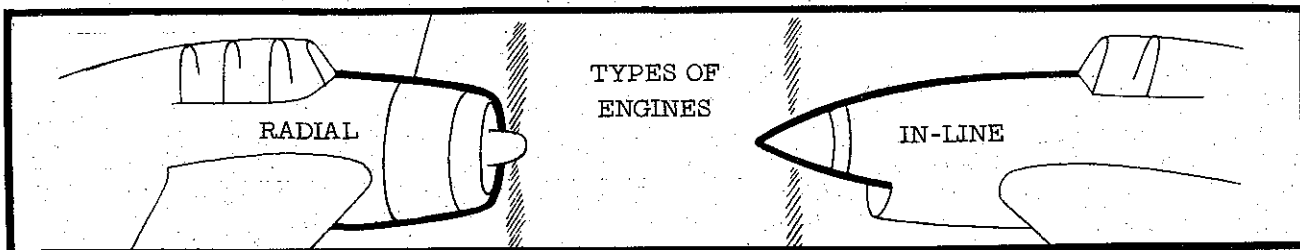
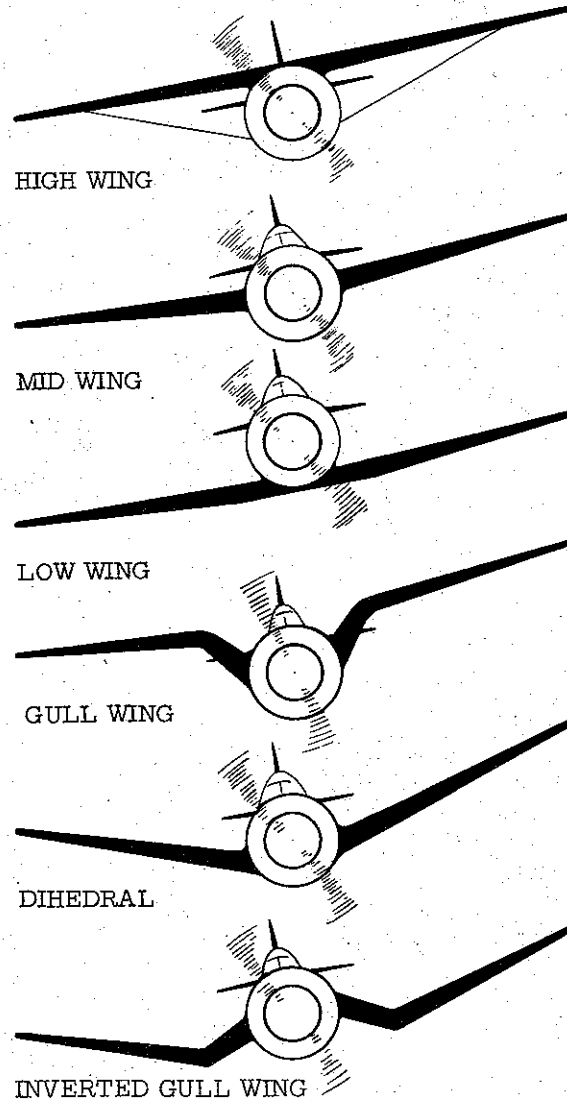
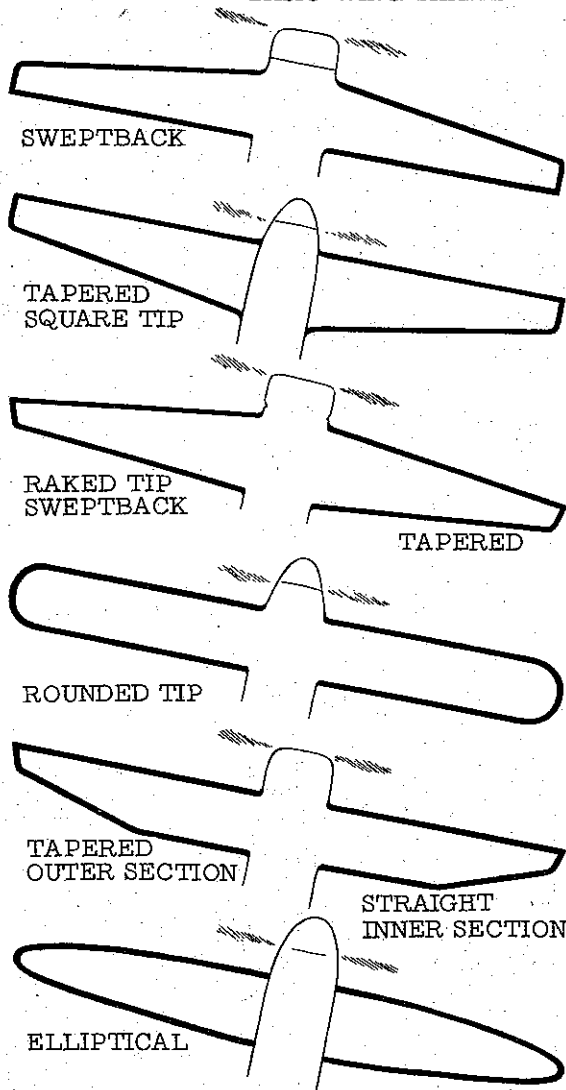

# IDENTIFICATION OF U. S. ARMY AIRCRAFT

## PURSUIT AND INTERCEPTORS

LOOK FOR: Single engine (Radial or In-Line) small size, single tail assembly

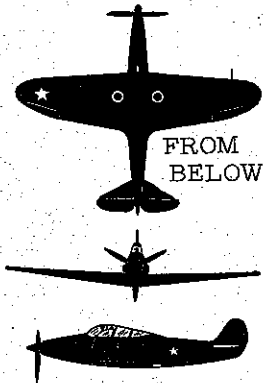

PURSUIT BELL P-39

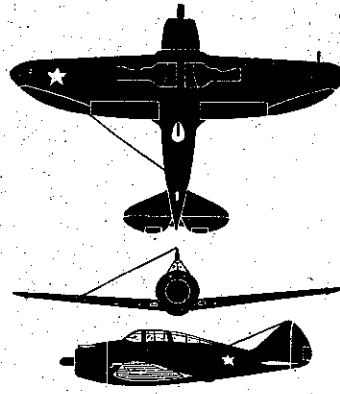

PURSUIT REPUBLIC P-43

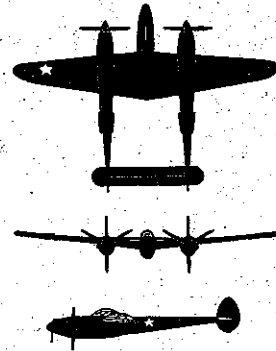

PURSUIT LOCKHEED P-38  
(EXCEPTION TO RULE)

## LIGHT AND MEDIUM BOMBARDMENT

LOOK FOR: Two engines (Radial) medium size, single or twin tail assembly.

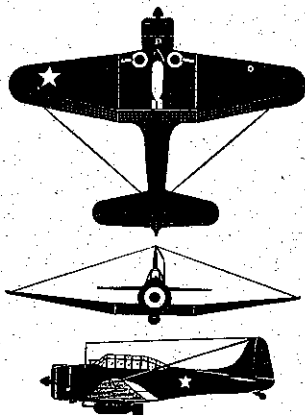

LIGHT BOMBARDMENT  
DOUGLAS A-24  
(EXCEPTION TO RULE)

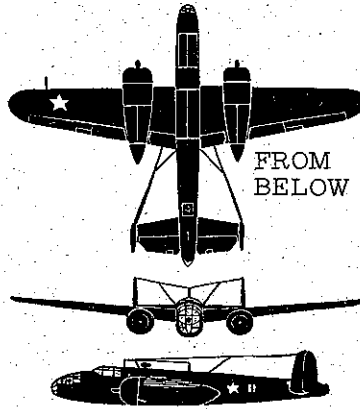

MEDIUM BOMBARDMENT  
NORTH AMERICAN B-25,  
B-25A, B-25B, AND B-25C.

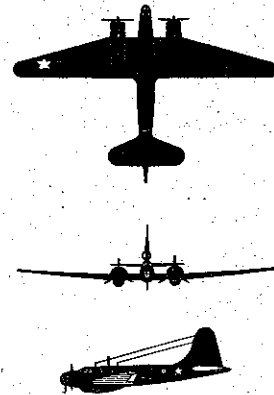

MEDIUM BOMBARDMENT  
DOUGLAS B-23

## HEAVY BOMBARDMENT

LOOK FOR: Four engines (Radial) large size, single or twin tail assembly.

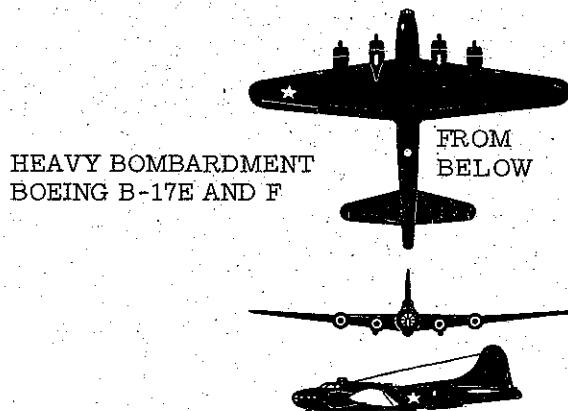

HEAVY BOMBARDMENT  
BOEING B-17E AND F

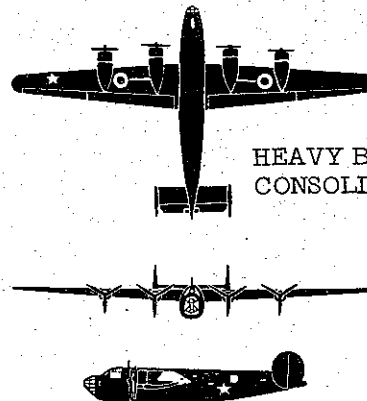

HEAVY BOMBARDMENT  
CONSOLIDATED B-24

# KNOW YOUR ENEMY



HERE'S THE GERMAN....his helmet is easy to spot. Notice the strong lip on the side. His blouse is of greenish-gray cloth, with a darker collar. His trousers are of gray cloth, and are worn tucked into half-length boots.

With him, he carries only his shelter half, canteen, mess kit, respirator, gas cape, entrenching tool and weapon. The rest of his equipment is carried by unit transportation.

Like the Jap, he's tough....if anything, better trained. He is superbly equipped. When you meet up with him in the field, you think of him more as a cog in a big machine than as an individual. So learn to recognize his machines.... especially tanks, armored cars and planes.

The German will continue to believe in the fight he is fighting as long as he's winning, but if disastrous defeats come, his spirit may be crushed. He will cease to believe in the things he thought infallible.

The Germans use one machine gun extensively. Known as the MG 34, it is 7.9 mm in caliber, fires at the cyclic rate of 900 rounds per minute and can be used as a light or heavy weapon by means of interchangeable mounts. When used as a light machine gun, the MG 34 is the basis of German infantry fire power. German tactics subordinate rifle marksmanship to this weapon, and as a result, the German rifleman is armed with a bolt-action Mauser type rifle (Gewehr '98 or Karabiner 98k). This is in sharp contrast to American practice of using the high fire power, semi-automatic Garand rifle, plus Browning automatic rifles and machine guns.

MG 34 ON TRIPOD MOUNT

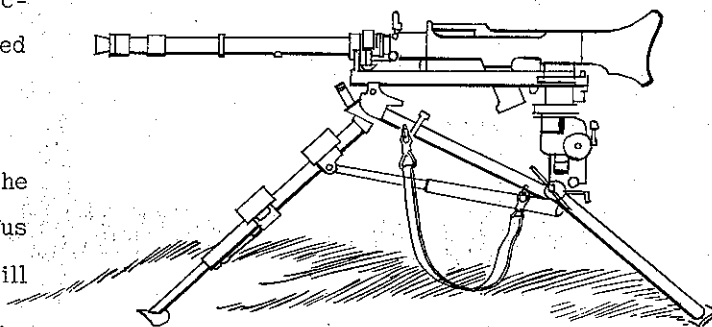

# KNOW YOUR ENEMY

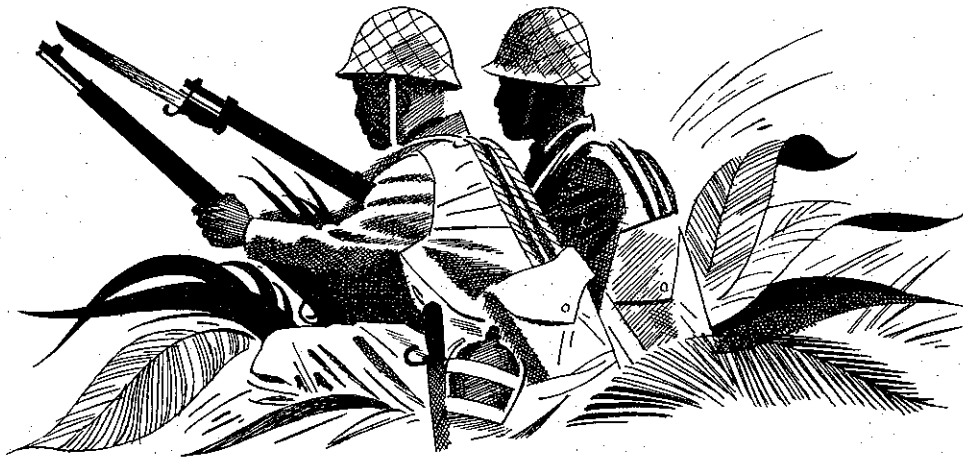

HERE'S THE JAP...his uniform is often improvised.

Regular dress is khaki or khaki-green. In jungle warfare he wears only shirts, shorts and sneakers.

To deceive you he may wear anything — native clothing, British uniforms, etc. To blend himself with his surroundings, he puts leaves in his helmet and branches in his belt. In the field he carries a five day food supply. He is plenty tough, can hike 35 miles every day for a week, knows how to fight dirty, will give you no quarter and is ready to die for the glory of Japan. He can hardly wait to get in a lick at you.

He is good at sneaking through jungles, and likes to flank your position or lines and fire on you from your rear, especially with automatic weapons. Don't lose your nerve if he does. Don't fire at a Jap you can't see. Your defense of any point should be all around. Attack may come from any direction. If the Jap should overrun your position, drive him out. If you must retire, blow up or burn the equipment that you can't take, or he will certainly use it against you.

If you should get cut off from the main body of our

troops, use every trick in your bag to worry his flank and rear: take advantage of the small amount of ammunition the Jap carries. Exploit his aggressiveness by ambushes. He tends to bunch on roads, and is then vulnerable. His rifle fire may be fairly accurate, but it is weak (.25 cal.). There is a story of a sergeant in Bataan who was shot through the neck with such a bullet, plugged both holes with Bandaid, and continued with his work. Jap mortar fire is accurate and deadly. Mortar and automatic arms are his favorite weapons for jungle fighting. His artillery standards do not come up to ours.

He generally leaves his bivouac areas and supply establishments poorly guarded.

JAPANESE LIGHT MACHINE GUN  
6.5 mm, .256 Cal.

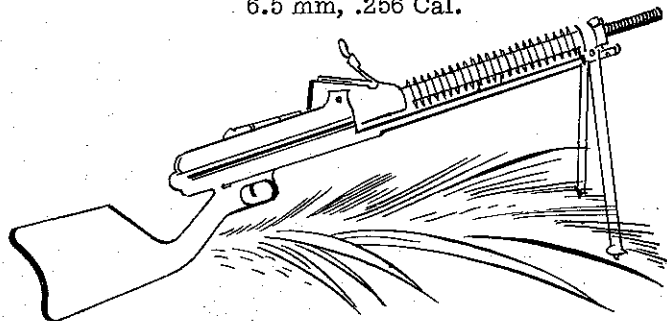



## COMMANDO COMBAT

Although this is a war of machines, it is also a war of men. Hand-to-hand combat is an ever-present possibility. To help you take care of yourself in an emergency, we have condensed some excerpts from "Get Tough"\*—a book written by Major W. E. Fairbairn of the British Army and published by D. Appleton-Century Company of New York.

The methods of fighting shown here aren't pretty, but they're efficient. Just remember that you'll have to use the same tactics that your enemy uses — only you'll have to be better.

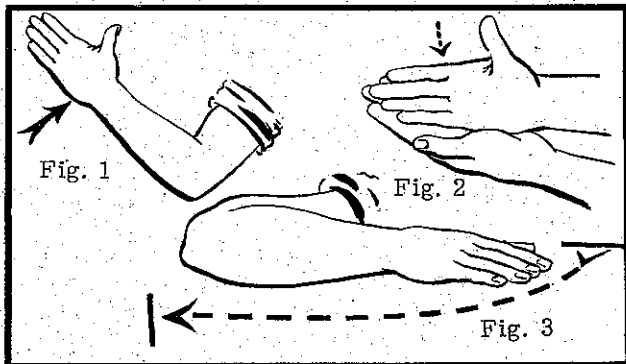

First, you should learn that a blow struck with the edge of the hand is much more deadly than a blow from a clenched fist. Always strike with the little-finger edge of the hand, using a chopping action from the elbow (Fig. 1). You may swing vertically or sideways, aiming for such points as the sides or back of the wrist; the midpoint of the forearm; the biceps; the sides or back of the neck; the point just below the Adam's Apple, or the kidneys. Practice this blow by striking your own hand. (Fig. 2.)

In this fighting style, the counterpart of an uppercut is a jab to the chin, delivered with the heel of the



hand (Fig. 4). Wait until you're close to your opponent, and then drive your hand to his chin, with your fingers extended so as to reach his eyes (Fig. 5). Again, you can practice on your own hand.

The chin jab is most effective when combined with the dirtiest trick of fighting — a knee to the groin. Put the weight of your body on one leg, bend the knee of the other leg slightly, and drive your knee into your opponent's crotch. (Fig. 7.)

To overcome an enemy sentry, approach your opponent from behind and swing your left forearm against his throat, bearing on the Adam's Apple. At the same time, place your right elbow on his right shoulder, and place your right palm on the back of

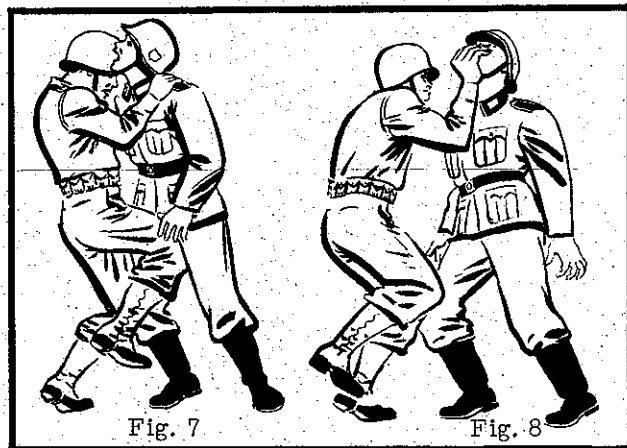

\* Copyright, 1942 by W. E. Fairbairn

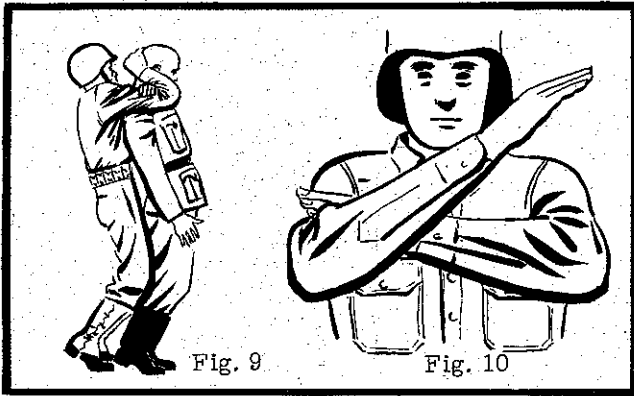

his head. Grasp your right biceps with your left hand and apply pressure. This will strangle him. (Fig. 9.)

Should he attempt resistance, change the position of your right hand so that the edge of your hand bears on the back of his head. A sharp pressure will then break his neck. (Fig. 10.)

In case you should become a prisoner, here's one way you can escape, using an ordinary penny match box as a weapon. Assume that you're sitting beside

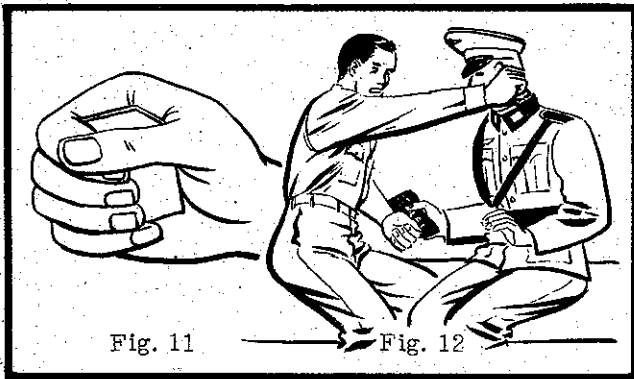

your captor, with a gun in your ribs. Grasp the box in your far hand, holding it as shown. (Fig. 11.) Quickly turn toward your opponent, sweeping the gun away with the near arm. Swing the clenched fist holding the match box so that it strikes your opponent behind the ear. Keep the arm straight, and make the movement as quickly as possible. (Fig. 12.) This usually results in a knockout blow.

To break a front strangle hold, (Fig. 13), grasp your

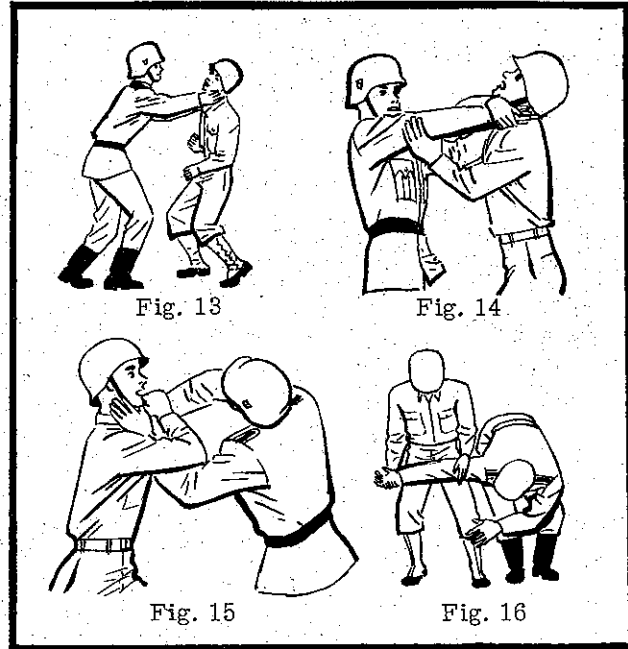

opponent's right elbow with your left hand. With your right hand, reach across his arms and seize his right wrist. (Fig. 14.) Bear down on his left arm and swing his other arm toward your right side. (Fig. 15.) At the same time turn your body rapidly to the right. Finish up with an edge-of-the-hand blow to his right elbow. (Fig. 16.)

If he still shows signs of a fight, finish him off with the "Bronco Kick." This consists of a flying jump at

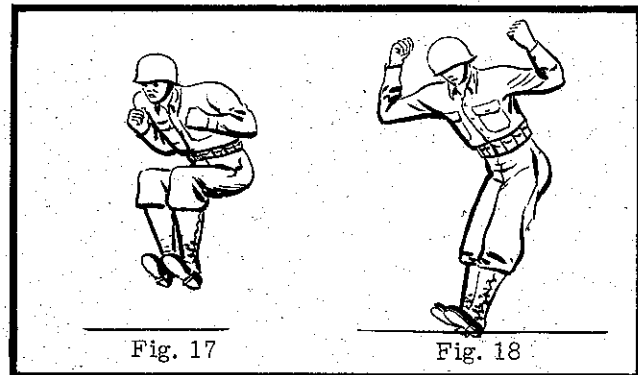

your opponent. When jumping, bend your knees, (Fig. 17), then when your feet are approximately eight inches above your opponent's body, straighten your legs, drive your heels into him and kill him. (Fig. 18.)



## WATCH YOUR STEP - BOOBY TRAPS

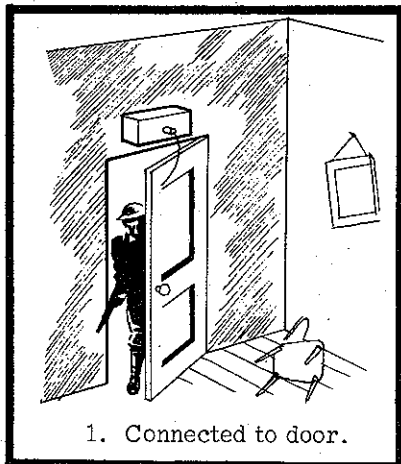

1. Connected to door.



2. Connected to window.

"Booby traps" is the name given to devices used by an enemy to wound or kill careless opponents. As the name indicates, only a "booby" will be injured by such a trap. Traps may be connected to doors, windows, furniture, and souvenirs, such as helmets, or they may be attached to weapons or vehicles that have had to be abandoned. The elementary booby trap usually consists of a small charge of explosive and an igniter, worked by either the push or pull method or both.

Don't let the enemy fool you. You must always be watchful for traps in areas which have been in the possession of the enemy. You should examine outdoor areas for trip wires or disturbed surfaces of the ground. In buildings, nothing should be moved until it has been thoroughly examined. When any wire or cord is found, you should follow it to the igniter, without touching it. The igniter must be neutralized before any movement is made. If you cannot easily neutralize a trap, mark it to protect others until it can be dealt with by specially trained men. Remember, do not attempt to disarm a trap unless your mission demands it.

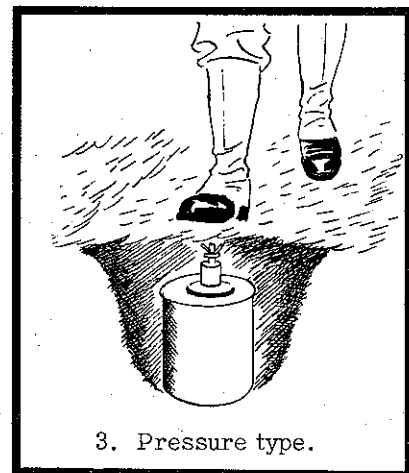

3. Pressure type.

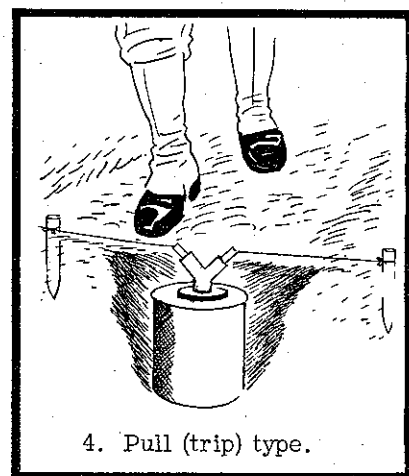

4. Pull (trip) type.



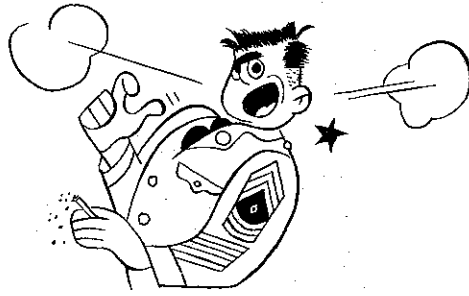

## TIPS FROM AN OLD TOP KICK

Perhaps your duty will carry you to England. If so, you'll be given a book when you get on the boat — a book designed to help you get along with our Allies. We can give you a few tips now, though.

Remember that when you're in England, you'll be a guest. Don't be impolite.

Don't tell the English we won the last war for them. We didn't. We helped to win it, and so did they — but they lost 16 times as many men as we did.

You'll probably find England a bit different than what you expected. You'll find many of the houses unpainted, because the British have things to make which are more important than paint. You'll find many buildings grimy — because Englishmen have been a little too busy to wash them.

And speaking of Englishmen, they'll seem a bit reserved, judging by American standards. A typical Briton won't speak to you unless you speak to him first. That doesn't mean he isn't interested; it's a British custom of respecting the other fellow's privacy.

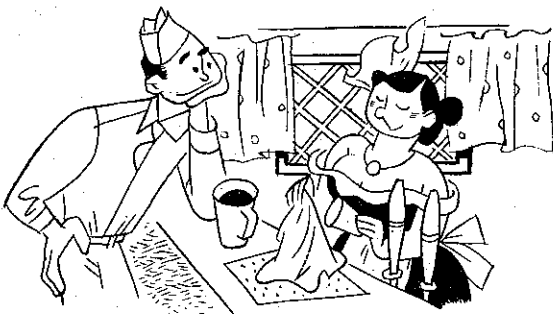

You're in the best-paid Army in the world, but don't flaunt your roll. The British Tommies don't like to be constantly reminded that they're not as well paid as we are.

Don't make a play for a Tommy's girl. She may like it but he won't. You may become involved in a physical discussion and get thrown in the pokey. Of course, if you can find a single, unattached girl, more power to you. You'll probably acquire some English slang, too. Just remember when and where to use it. "Bloody", for example, should never be used in front of a girl — it's a low-down cussword. In Brooklyn, a "bum" is a Dodger. In England, it means somebody's back side.

You'll learn as you go along. Just remember, it's impolite to criticize your hosts. It's militarily stupid to criticize your Allies.

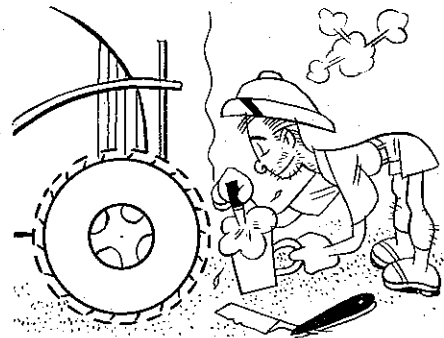

Guardsman Patrick Tivey of the British Coldstream Guards passes a word to the wise from his station in Libya. Writing for the American Magazine, he says that water's scarce in the desert, so if you want hot water for shaving, drain some from a truck radiator. It's a little rusty, but you're not going to drink it. And when you've finished, pour it back into the radiator again.

You can heat your canned emergency rations with a truck. Just wire the can around the exhaust manifold. Then, when you stop for chow, dinner's hot. Don't make a cooking fire unless you have to — but if you must, take a 5-gallon gasoline can, shovel in 6 or 8 inches of sand and about a quart of gasoline, and light it. The sand acts like a wick.

Plenty of men in Libya died because they were too lazy to dig a slit trench. Look at page 27 to see how it's done. Remember, not too deep, or it might cave in. Just get below ground level.

In addition to what Guardsman Tivey says, here are a few extra tips. In the desert, you must discipline yourself in the use of water. Get the habit of drinking very little during the day. It's especially tough to do this if you smoke a great deal, so you'd better cut down on cigarettes, too.

At all times you should wear a woolen "belly band" to prevent stomach chills. This is necessary even on the hottest days. If your girl likes to knit sweaters, there's your answer.

★ ★ ★

If you wind up in jungle country, get yourself a pocket knife before you go into the interior. It's apt to be your most valued possession. Carry your matches in a special waterproof container. Otherwise, perspiration alone will ruin them. Always sleep under a mosquito net. In the rainy season, and at other times if possible, sleep off the ground. You and your buddy, if using a pup tent, can build a little platform of forked twigs and branches, at least a foot off the ground, lashing the parts together with vines. Pitch shelter tent and mosquito netting on the platform.

Avoid brushing against trees and bushes wherever possible, since many are poisonous.

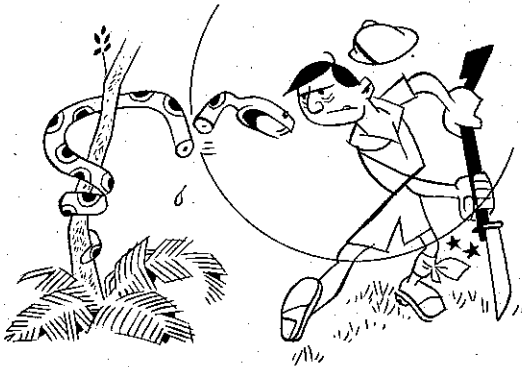

If you're unlucky enough to be bitten by a jungle snake, don't run. Kill the snake if possible, as identification is an aid to medical treatment. Apply a tourniquet, if you're bitten on an arm or leg, and send your buddy for a medical officer immediately.

If you should get lost, remember these points. Streams and water courses are usually found if you go down hill, and these sooner or later will lead to inhabited regions. A light improvised spear with barbed points will enable you to kill fish. Edible fruits can usually be identified by signs of animals

having eaten them. Avoid eating unknown fruits except in an extreme emergency.

Remember that if you keep relaxed and use your head, you can live and travel alone for weeks in the jungle.

★ ★ ★

When you're on duty in cold climates, one of the dangers you'll face will be freezing and frostbite. Freezing is not always accompanied by pain. It is indicated by a grayish or whitish appearance of the skin. It's a good idea to wrinkle the face from time to time to discover any stiffness caused by freezing. If a part of your face seems stiff, you can thaw it by placing your bare hand over the area until circulation is restored.

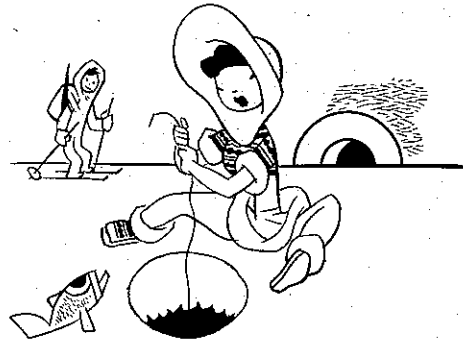

Don't wear a beard. Frost from the breath accumulates on the whiskers, and you'll wind up with a frozen pan. Either shave frequently, using an oily shaving cream, or keep the beard closely trimmed with clippers.

You'll have to wear snow glasses during the daytime to prevent snow-blindness. In an emergency, you can blacken the skin around your eyes, just like an outfielder on a ball club.

If you have to wade across shallow streams or overflows in regions of extreme cold with shoes that are not waterproof, try this: Dip the shoes into the water and withdraw them quickly. A thin coating of ice will form. Then you can wade quickly across, and after a few minutes, the ice will crack off your shoes. It's an old Eskimo trick.

Speaking of shoes, it's a good idea to stuff dried grass around your feet, inside the shoes. The grass absorbs moisture and should be changed daily. Also, dried grass held in the hands will help retain heat.

No matter where you go in the service of your country, you're a part of the best-clothed, best-equipped and best-paid army in the world. That doesn't make it the best army in the world — because only you can do that. From now on it's up to you.



**THE ORDNANCE DEPARTMENT**

**PROVIDES AND REPAIRS**

**FIGHTING TOOLS FOR THE ARMY**

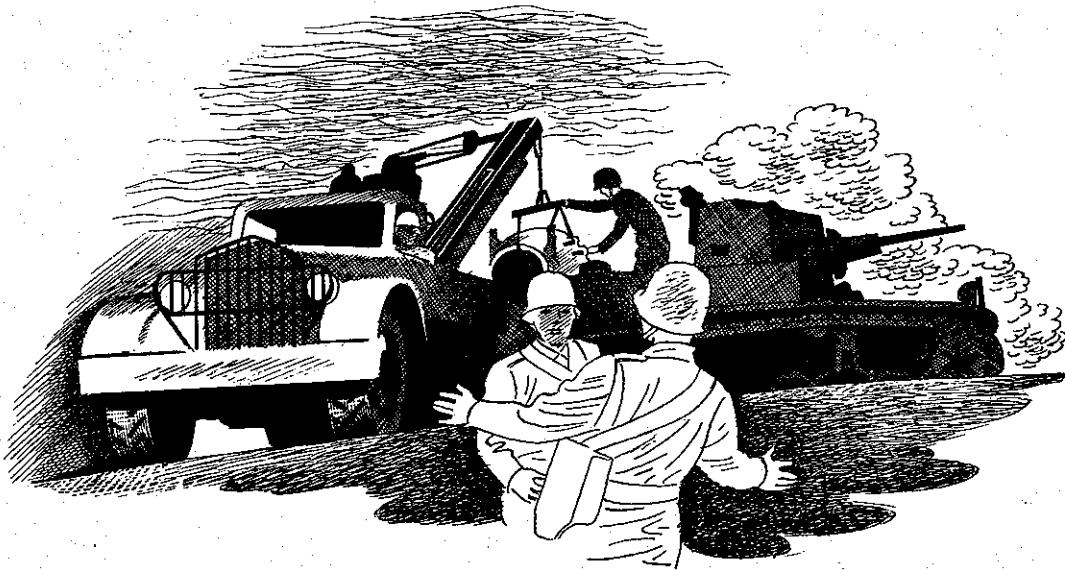





# THE ORGANIZATION OF THE ORDNANCE DEPARTMENT

Mission: Design, develop, procure, store, supply, and train the personnel necessary to maintain the fighting equipment for the Army. This equipment is known as Ordnance Materiel.

ORDNANCE MATERIEL IS CLASSIFIED AS FOLLOWS:

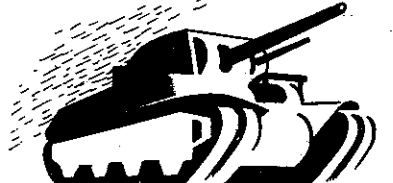
## GENERAL MATERIEL

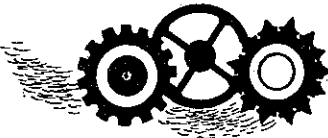
 <p>COMBAT WEAPONS</p>	<p>TRACK LAYING VEHICLES</p> 
 <p>COMBAT VEHICLES</p>	<p>FIRE CONTROL EQUIPMENT</p> 
 <p>SPECIAL PURPOSE AND ORDNANCE VEHICLES</p>	<p>SPARE PARTS</p> 

## AMMUNITION

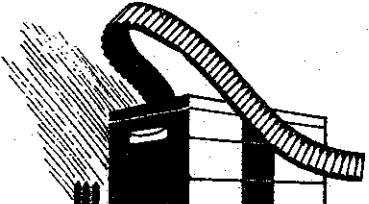
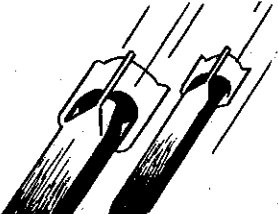
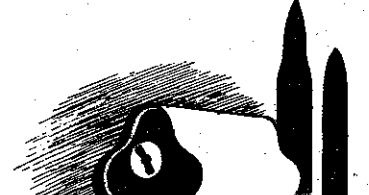
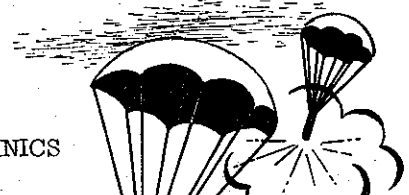
 <p>SMALL ARMS</p>	<p>AIRCRAFT</p> 
 <p>ARTILLERY</p>	<p>PYROTECHNICS</p> 

**THE ORDNANCE DEPARTMENT IS ORGANIZED INTO FIVE DIVISIONS UNDER THE CHIEF OF ORDNANCE**

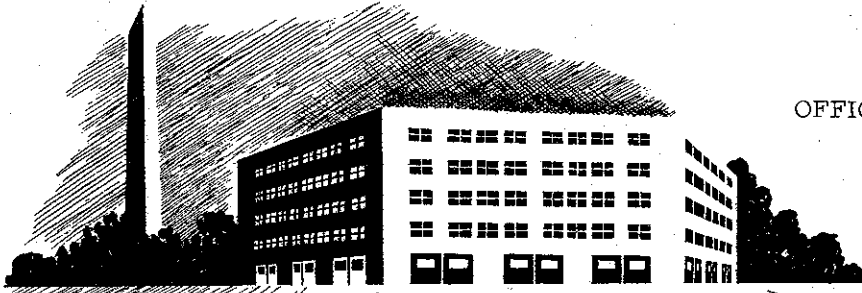

OFFICE OF THE CHIEF OF ORDNANCE

---

---

---

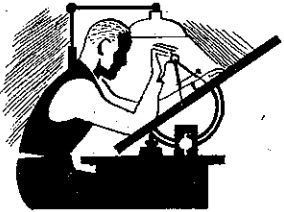

TECHNICAL DIVISION

---

---

---



TANK AUTOMOTIVE CENTER

---

---

---

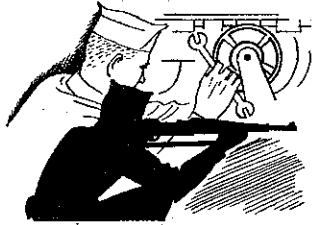

MILITARY TRAINING DIVISION

---

---

---



INDUSTRIAL DIVISION

---

---

---

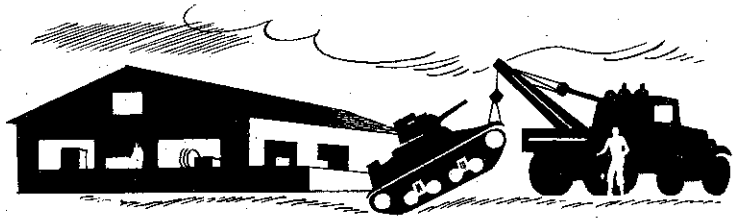

FIELD SERVICE DIVISION

---

---



---



## FIELD SERVICE DIVISION

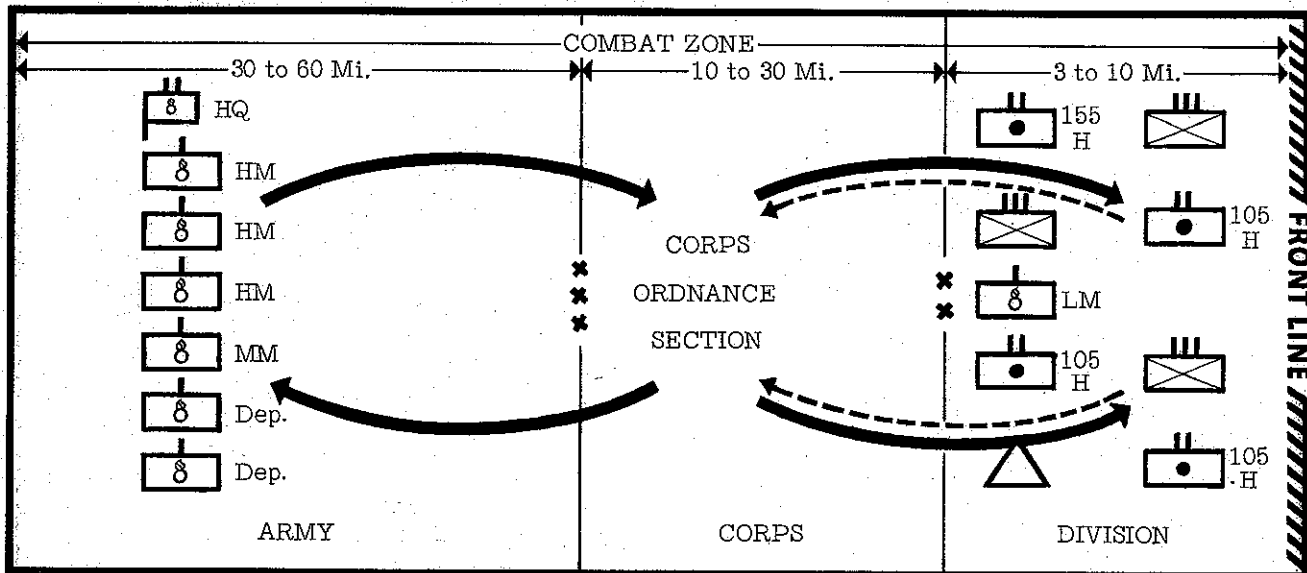

To perform field service in the combat zone, ordnance organizations are assigned to the division, corps, army or air force units.

### SUPPLY AND MAINTENANCE OF GENERAL MATERIEL



 HQ. HQ. & HQ. Det.  
 HM Ordnance Heavy Maintenance Co.  
 MM Ordnance Medium Maintenance Co.

 Dep. Ordnance Depot Co.  
 LM Light Maintenance Co.  
 Infantry Regiment

 105 M - 105 MM How. Bn.  
 155 H - 1 Bn. 155 MM How  
 Division Ordnance Section

#### CORPS ORD. SEC.

4 - Officers 1 - W.O. 9 E.M.

#### DIVISION ORD. SEC.

3 Officers 22 E.M.

Div. Ordnance Office: Coordinating and planning agency for Division Ordnance Officer.

Maintenance Office: Prepare plans for maintenance. Schedule contact parties. Estimate supplies required.

Contact Parties: Carry maintenance service to combat troops. Conduct inspections. Repair and issue general supplies within capabilities.

Ammunition Office; (See next page)

#### LIGHT MAINTENANCE CO.

6 - Officers 1 W.O. 145 E.M.

Headquarters Section: Administra-

tion, mess, Co. supply.

Shop Supply Section: Store and issue parts.

Automotive Platoon: Repair of automotive vehicles.

Armament Platoon: Repair of small arms and artillery weapons.

#### MEDIUM MAINTENANCE CO.

6 - Officers 1 W.O. 184 E.M.

Headquarters: Administration, mess, Co. supply.

Service Platoon: Store and issue parts. Operate shop and welding trucks. Perform electrical and carpentry work.

Armament Platoon: Repair small arms, artillery weapons and fire control equipment.

Automotive Platoon: Repair and

recovery of automotive vehicles.

#### HEAVY MAINTENANCE CO.

7 - Officers 1 W.O. 215 E.M.

Headquarters Section - Service and Supply Section - Artillery Section - Automotive Section - Armory Section - Instrument Section.

Depot Company:

6 - Officers 180 E.M.

Headquarters: Administration, mess,

Storehouse Platoon: Prepare, organize and operate storage areas.

Service Platoon: Receive, check, pack, crate and issue. Transport materiel within depot.

Guard & Labor Platoon: Heavy labor tasks, assist service platoon and storehouse platoon and furnish necessary guard.

# AMMUNITION SUPPLY

TWO AMMUNITION BATTALIONS (12 COMPANIES) PER ARMY

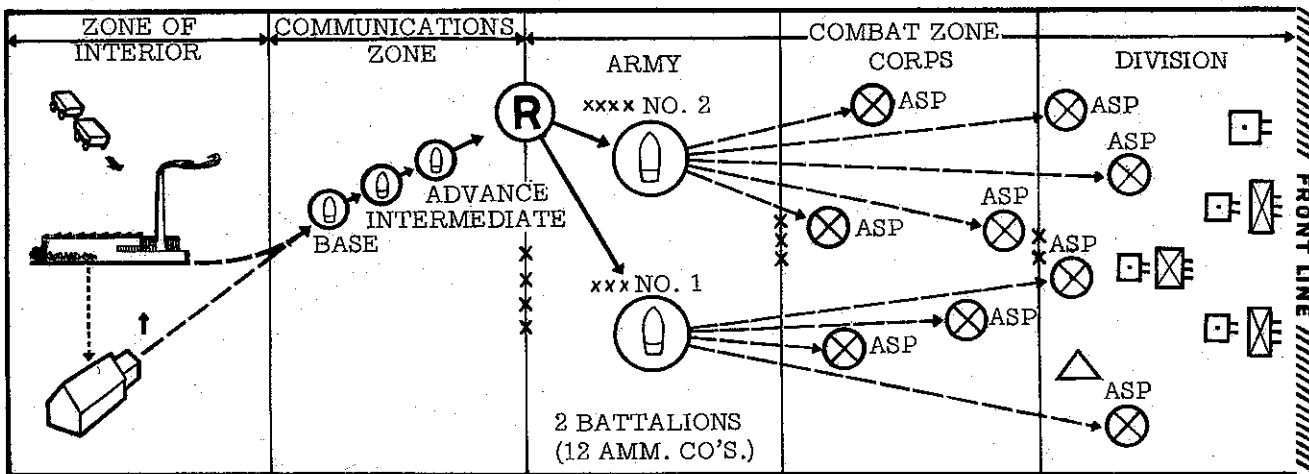

## AMMUNITION COMPANY

6 - Officers 180 E.M.

6 Co's. per Amm. Bn.

Headquarters: Administration, Company records, mess and supply.

A.S.P. Section and Office: Prepare plans for operation of A.S.P.'s. Supervise and coordinate work of magazine and service platoons.

- 1 Regiment Infantry
- 1 Battalion Artillery
- Regulating Station

Magazine Platoon: Receipt, storage, issue and inspection. Preparation of sites.

Service Platoon: Supervise and administer shipping and receiving. Guard, guide and traffic control. Packing for shipment. Other miscellaneous duties.

- Depot
- Supply Point
- Div. Ord. Sect., Amm. Office

## AMMUNITION OFFICE (Div. Ord. Section)

1 - Officer 7 E.M.

Assist Div. Amm. Officer in Administration of ammunition supply to the division. Receive and prepare reports.

## ORDNANCE SERVICE WITH THE AIR FORCES

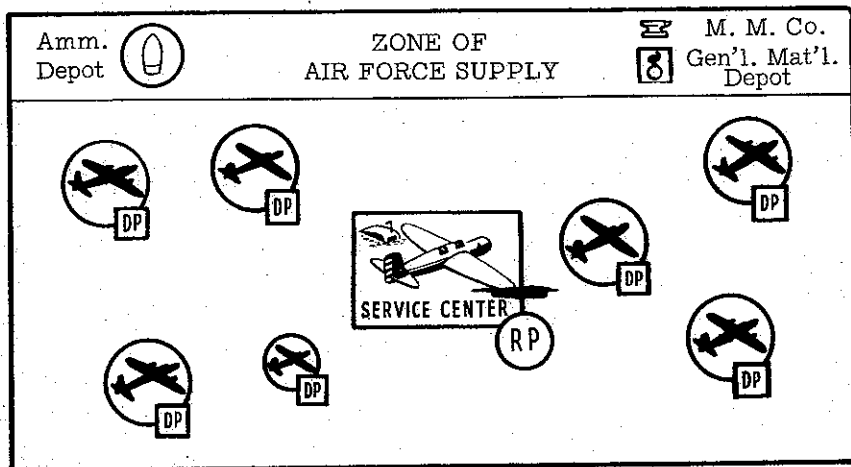

## AIR BASE ORDNANCE COMPANY

4 - Officers 60 E.M.

One or more per Service Center. Ordnance service to planes at center. Operates refilling point for ammunition. Supply and maintenance of General Materiel.

## ORDNANCE SECTION

1 - Officer 20 E.M.

One section assigned to each squadron of planes. Located at advanced airdrome. Supply of ammunition, maintenance and supply of general materiel.

- Bombing Squadron - Advanced Airdrome
- Pursuit Squadron - Advanced Airdrome
- Amm. Distributing Pt.
- Amm. Refilling Pt.

# ELEMENTARY PRINCIPLES OF ORDNANCE

## INTRODUCTORY STUDY OF BALLISTICS

PAPER burns giving off heat and gas. But it needs plenty of oxygen from the air.

BLACK POWDER contains its own oxygen and burns faster. It does not need air.

In the open  \_\_\_\_\_

Partly confined  \_\_\_\_\_

Confined  \_\_\_\_\_

Black powder has a pushing effect.

It is a \_\_\_\_\_ explosion.

TNT or DYNAMITE has a shattering effect.

It is a \_\_\_\_\_ explosion.

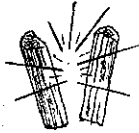

### INERTIA

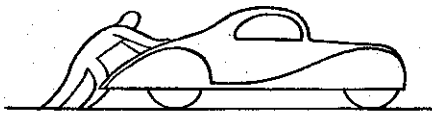

Tends to stay at rest



Tends to stay in motion

### RECOIL

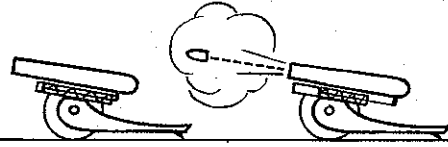

1. Reason for recoil \_\_\_\_\_
2. Recoil device \_\_\_\_\_
3. Counter-recoil device \_\_\_\_\_

### GRAVITY

Attraction of the earth

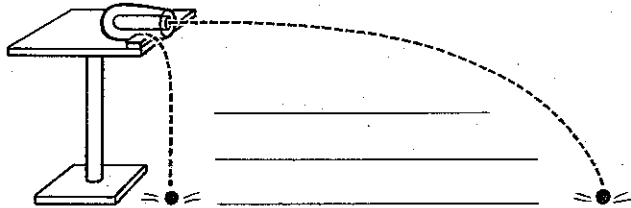

### WIND RESISTANCE

1. Turbulence: but easy to manufacture \_\_\_\_\_
2. Shape for least wind resistance \_\_\_\_\_
3. Compromise (boat-tailing) \_\_\_\_\_

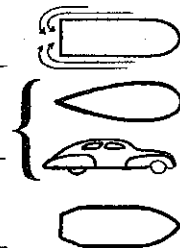

### FORCES ACTING ON A PROJECTILE

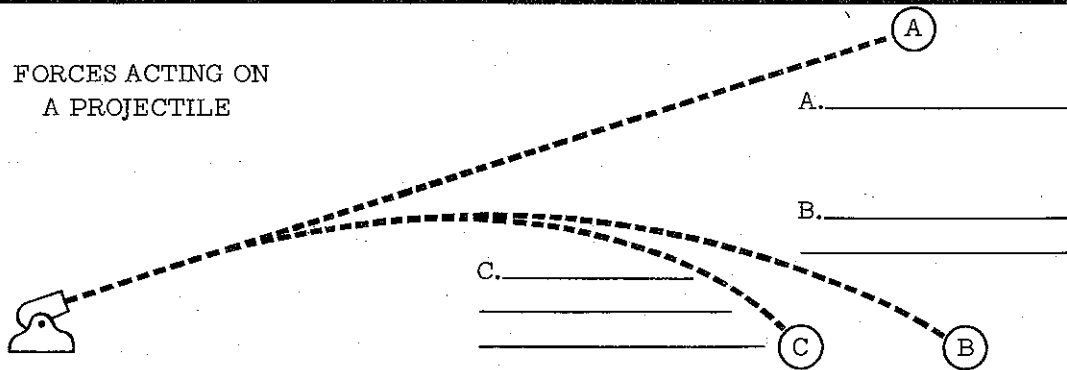



GYRO-DYNAMIC FORCE

1. Prevents tumbling

(a) \_\_\_\_\_

(b) \_\_\_\_\_

2. Allows placing of fuze

3. Example \_\_\_\_\_

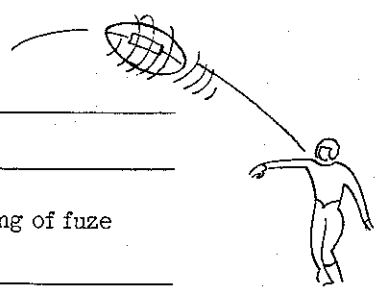

MEASUREMENT

1. Caliber

Diameter of bore measured between opposite lands

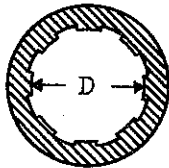

In small arms the diameter is the caliber of the weapon. In artillery a gun tube having a caliber of 3 inches, for instance, may be said to be 50 calibers long, which means that its length is 50 times its caliber, or 150 inches.

Metric and English Systems

One inch is about 25 mm (millimeters)

2 Degree 360° (degrees) in complete circle

3. Mil - Definition

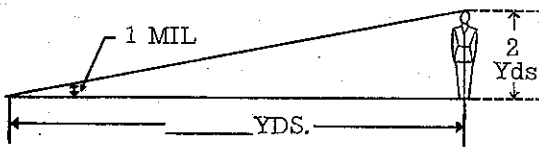
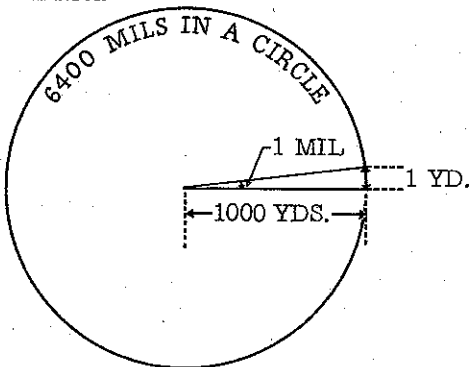

APPLICATION OF FORCE

PULLEYS

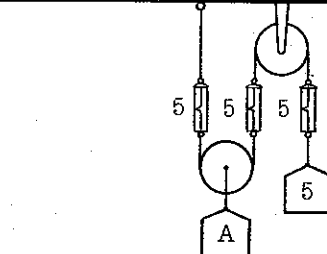

A \_\_\_\_\_ lbs.

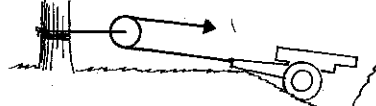

Ratio \_\_\_\_\_

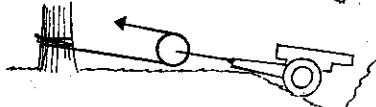

Ratio \_\_\_\_\_

LEVERS

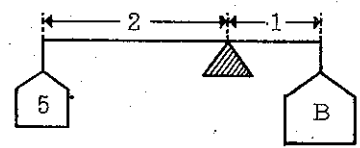

B \_\_\_\_\_ lbs.

GEARS

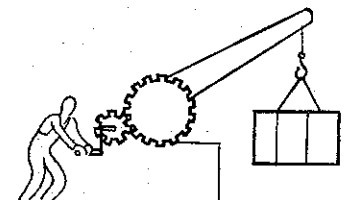

CAM ACTION

1. Rotary Cam \_\_\_\_\_

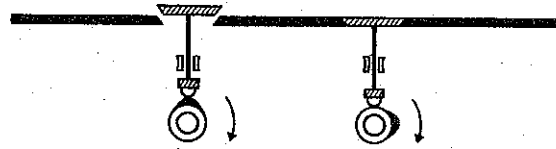

2. Sliding Cam \_\_\_\_\_

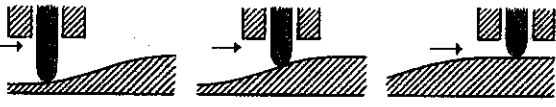

# ARTILLERY

The development of modern artillery is a gradual process, which began about 800 B.C., when the catapult and ballista were first used. These machines, designed to throw heavy weights, were supplanted by the "wall gun" after gunpowder came into use. The "wall gun" came into prominence in 1250 A.D.

Artillery became highly mobile with the first use of horse drawn carriages in 1759. The advent of TNT and smokeless powder gave impetus to the development of artillery materiel. The first modern artillery piece was developed in 1897 when a Frenchman devised the first satisfactory recoil mechanism.

## CLASSIFICATION OF MODERN WEAPONS

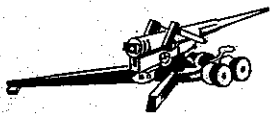

TYPE \_\_\_\_\_  
 TRAJECTORY \_\_\_\_\_  
 LENGTH OF TUBE \_\_\_\_\_

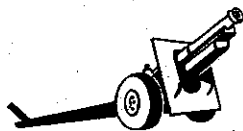

TYPE \_\_\_\_\_  
 TRAJECTORY \_\_\_\_\_  
 LENGTH OF TUBE \_\_\_\_\_



TYPE \_\_\_\_\_  
 TRAJECTORY \_\_\_\_\_  
 LENGTH OF TUBE \_\_\_\_\_

All artillery pieces are made up of three main parts: 1. Tube, including breech mechanism. 2. Recoil mechanism. 3. Carriage, including elevating and traversing mechanisms, and equilibrator.

Fill in the correct name for each numbered part.

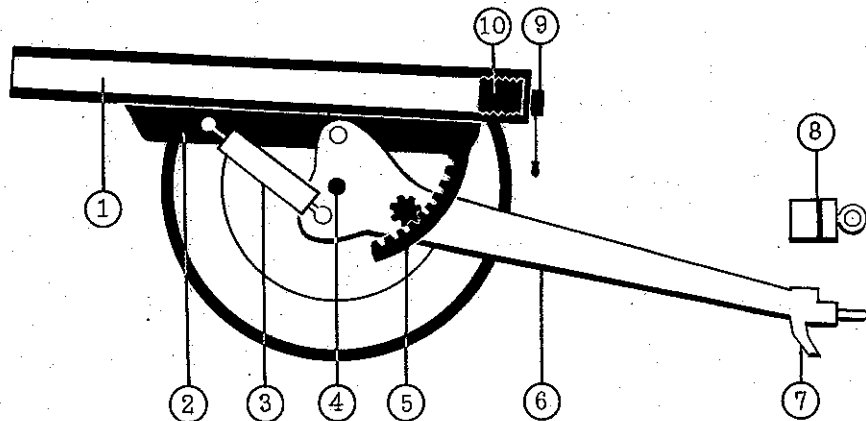

- 1. \_\_\_\_\_
- 2. \_\_\_\_\_
- 3. \_\_\_\_\_
- 4. \_\_\_\_\_

- 5. \_\_\_\_\_
- 6. \_\_\_\_\_
- 7. \_\_\_\_\_
- 8. \_\_\_\_\_
- 9. \_\_\_\_\_
- 10. \_\_\_\_\_

TUBES	CANNON	DESCRIPTION
1. _____	_____	_____
2. _____	_____	_____
3. _____	_____	_____

BREECH MECHANISMS

**BREECH BLOCKS**  
Advantages

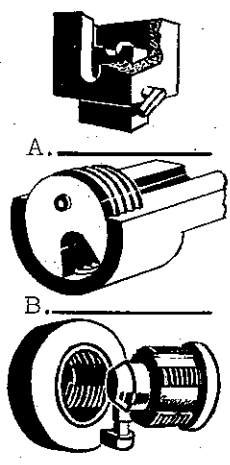

A. \_\_\_\_\_  
 \_\_\_\_\_  
 \_\_\_\_\_

B. \_\_\_\_\_  
 \_\_\_\_\_  
 \_\_\_\_\_

C. \_\_\_\_\_  
 \_\_\_\_\_  
 \_\_\_\_\_



**THREE FIRING MECHANISMS ARE:**  
Advantages

A. \_\_\_\_\_  
 \_\_\_\_\_  
 \_\_\_\_\_

B. \_\_\_\_\_  
 \_\_\_\_\_  
 \_\_\_\_\_

C. \_\_\_\_\_  
 \_\_\_\_\_  
 \_\_\_\_\_

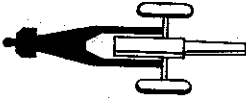
**CARRIAGES ... TRAILS**

	TYPE OF TRAVERSE	ADVANTAGES	DISADVANTAGES
	_____	_____	_____
A. _____	_____	_____	_____
	_____	_____	_____
B. _____	_____	_____	_____
	_____	_____	_____
C. _____	_____	_____	_____

EVERY RECOIL SYSTEM CONSISTS OF THREE PARTS:

1. \_\_\_\_\_ 2. \_\_\_\_\_ 3. \_\_\_\_\_

TWO MAIN TYPES OF RECOIL MECHANISMS ARE:

1. \_\_\_\_\_  
 2. \_\_\_\_\_

SEVEN IMPORTANT CHARACTERISTICS OF AN ARTILLERY PIECE ARE:

1. \_\_\_\_\_ 5. \_\_\_\_\_  
 2. \_\_\_\_\_ 6. \_\_\_\_\_  
 3. \_\_\_\_\_ 7. \_\_\_\_\_  
 4. \_\_\_\_\_

In the following sketch, label the arrows pointing to various parts of a recoil mechanism.

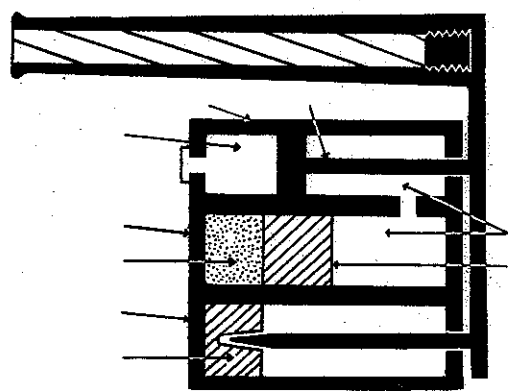

FIELD ARTILLERY IS DIVIDED INTO THREE CLASSES ACCORDING TO WEIGHT

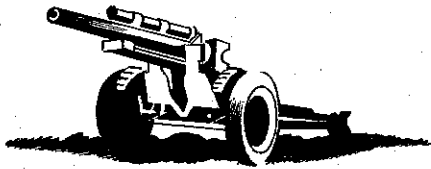

LIGHT (105 MM. HOW.)

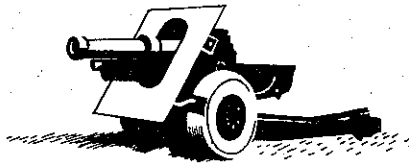

MEDIUM (155 MM. HOW.)

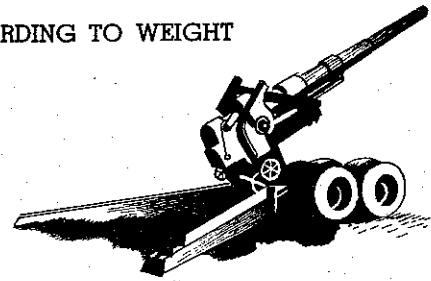

HEAVY (155 MM. GUN)

A. _____	A. _____	A. _____
B. _____	B. _____	B. _____
C. _____	C. _____	C. _____
D. _____		

THE METHODS OF TRANSPORTING ARTILLERY WEAPONS ARE:

1. Mountain Artillery \_\_\_\_\_
2. Light Artillery \_\_\_\_\_
3. Medium Artillery \_\_\_\_\_
4. Heavy Artillery \_\_\_\_\_

EQUILIBRATOR - TO MAKE POSSIBLE REAR TRUNNIONS.

SPRING



A. \_\_\_\_\_  
 \_\_\_\_\_

PNEUMATIC

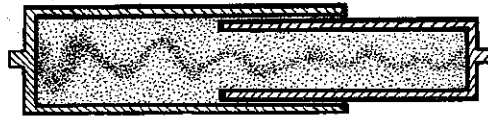

B. \_\_\_\_\_  
 \_\_\_\_\_



Pneumatic-spring. . . combination of both

COAST ARTILLERY includes fixed and mobile coastal weapons as well as antiaircraft guns, barrage balloons, and certain forms of water mines. The two main types of fixed mounts are shown at right.

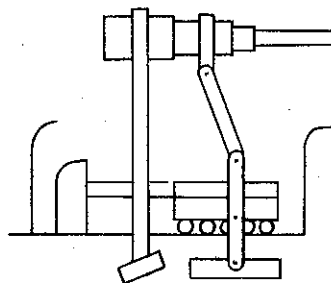

TYPE \_\_\_\_\_  
 \_\_\_\_\_

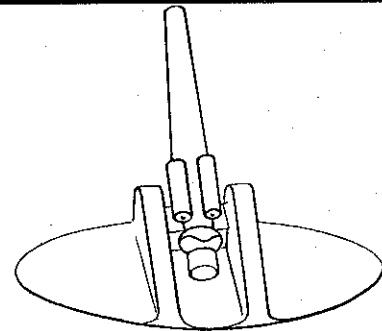

TYPE \_\_\_\_\_  
 \_\_\_\_\_

ADVANTAGES OF EACH TYPE \_\_\_\_\_  
 \_\_\_\_\_  
 \_\_\_\_\_

RAILWAY TRAVERSES

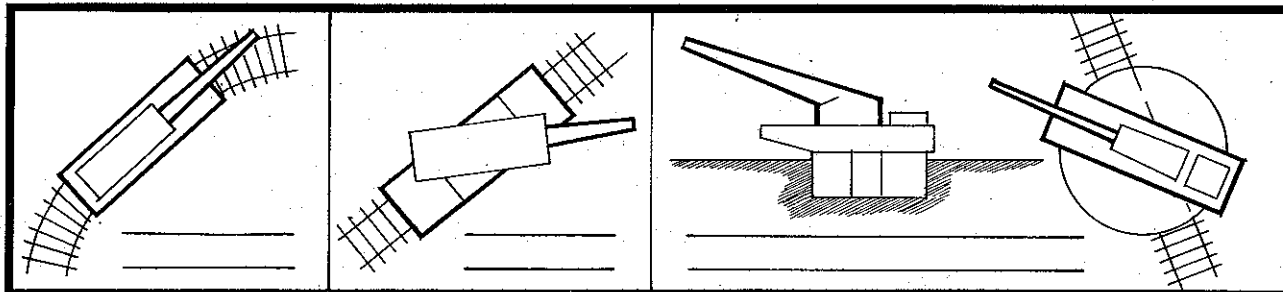

ANTI AIRCRAFT ARTILLERY

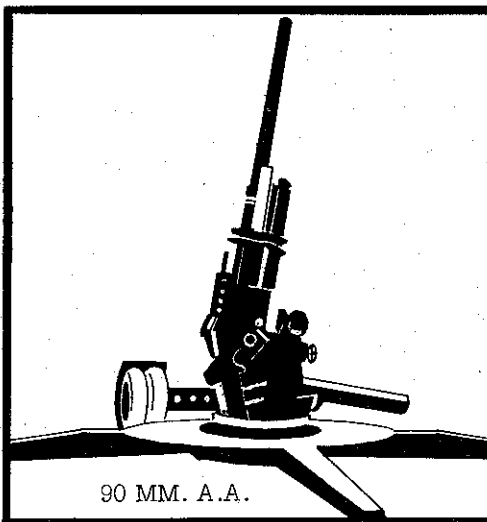

Antiaircraft guns on both fixed and mobile mounts. Projectiles vary in weight from 1.34 pounds to 50 pounds. Ranges vary from 4,139 yards to 11,500 yards.

GUN	TYPE OF MOUNT	CHARACTERISTICS

Name and uses of the fire control instruments used in antiaircraft firing. Fill in the lines below indicating the correct name and use for each instrument shown.

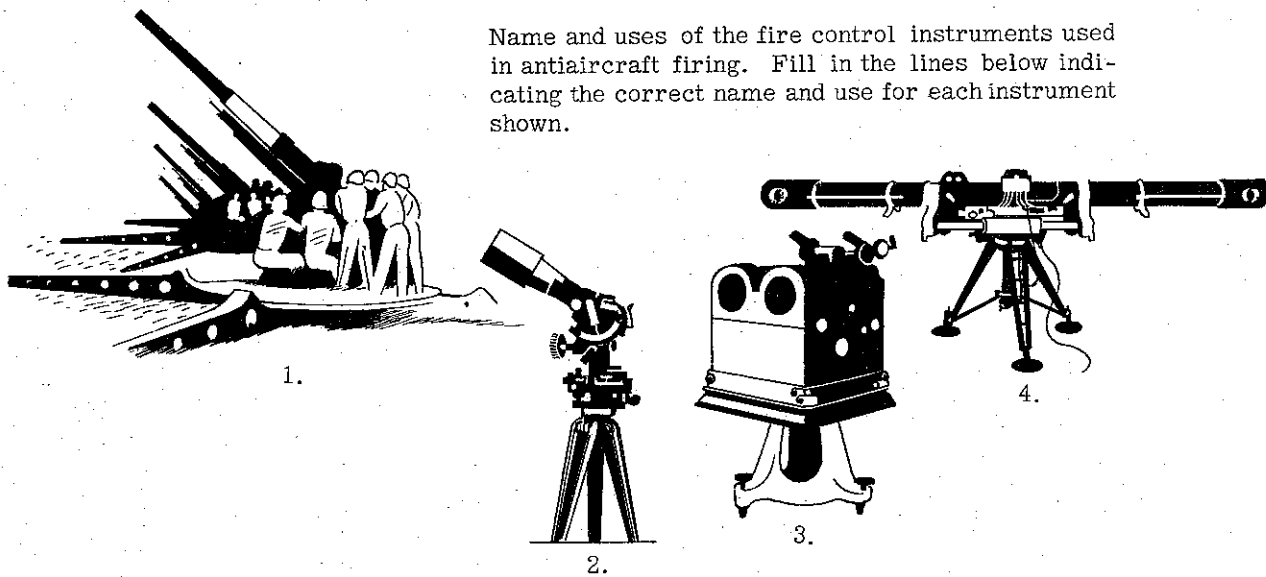

1. \_\_\_\_\_

2. \_\_\_\_\_

3. \_\_\_\_\_

4. \_\_\_\_\_

# SMALL ARMS

## GENERAL

### DEFINITIONS

- a. Fire Power — number of aimed shots that can be fired effectively in given time.
- b. Muzzle — front end of barrel.
- c. Breech — rear end of barrel.
- d. Bore — inside of barrel.
- e. Rifling — (lands and grooves) — threading on bore to spin projectile.

### EIGHT STEPS OF OPERATION:

- 1. Firing \_\_\_\_\_
- 2. Unlocking \_\_\_\_\_
- 3. Extracting \_\_\_\_\_
- 4. Ejecting \_\_\_\_\_
- 5. Cocking \_\_\_\_\_
- 6. Feeding \_\_\_\_\_
- 7. Loading \_\_\_\_\_
- 8. Locking \_\_\_\_\_

### MANUALLY OPERATED WEAPONS

ALL STEPS OF OPERATION PERFORMED BY HAND.

#### U. S. RIFLE, CAL..30, M1903A1 (SPRINGFIELD)

LOCATE BY MEANS OF THE NUMBERS ON THE DIAGRAMS THE PARTS LISTED BELOW:

- a. Bolt Locking Lugs. \_\_\_\_\_
  - b. Extractor \_\_\_\_\_
  - c. Striker \_\_\_\_\_
  - d. Magazine follower \_\_\_\_\_
  - e. Mainspring \_\_\_\_\_
  - f. Cocking piece \_\_\_\_\_
  - g. Safety \_\_\_\_\_
  - h. Chamber \_\_\_\_\_
  - i. Magazine spring \_\_\_\_\_
  - j. Bolt handle \_\_\_\_\_
- (Distinguishing feature of manually operated army rifles)

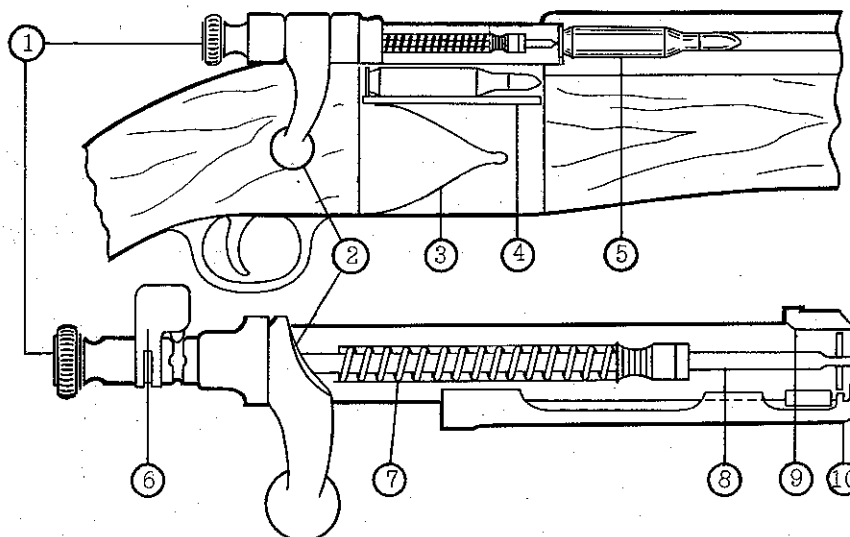

Two methods of cocking:

- a. Ordinary method \_\_\_\_\_
  - b. In case of misfire \_\_\_\_\_
- Positions of cut-off: \_\_\_\_\_
- a. On \_\_\_\_\_
  - b. Off \_\_\_\_\_
  - c. Middle \_\_\_\_\_
- Positions of safety: \_\_\_\_\_
- a. Ready \_\_\_\_\_
  - b. Safe \_\_\_\_\_
  - c. Middle \_\_\_\_\_

#### U. S. RIFLE, CAL..30, M1917 (ENFIELD)

Differs from 1903 Rifle in following respects:

- (1) Longer, heavier, no cut-off, only safe and ready positions for safety, rear sight farther back and without windage knob, cocking performed as bolt is closed and locked.

**GAS AND BLOWBACK OPERATED WEAPONS**  
Automatic, semiautomatic.

U. S. Rifle, cal..30, M1 (Garand):  
Gas operated, semiautomatic. Locate the following parts on the diagram:

- a. Hammer \_\_\_\_\_
- b. Bolt \_\_\_\_\_
- c. Operating Rod spring \_\_\_\_\_
- d. Piston \_\_\_\_\_
- e. Gas cylinder \_\_\_\_\_  
(Distinguishing feature of gas weapons)

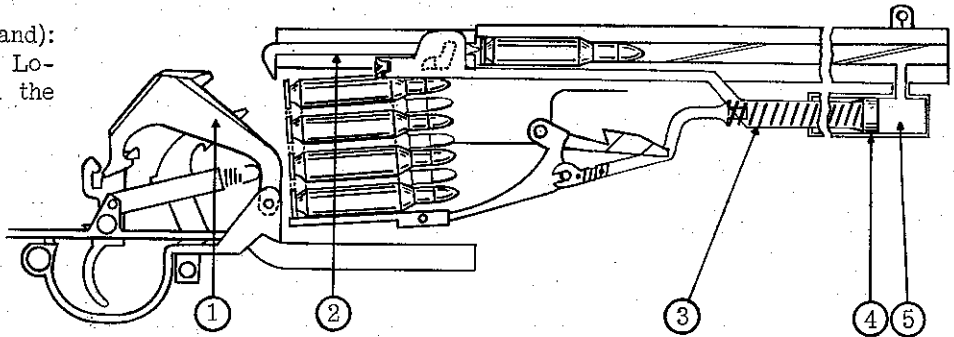

Two methods of cocking: a. Ordinary method \_\_\_\_\_  
b. In case of misfire \_\_\_\_\_

U. S. CARBINE, CAL..30, M1: GAS OPERATED, SEMIAUTOMATIC.

A carbine is a short, light rifle. The M1 Carbine resembles the M1 Rifle in its functioning, but differs from it in the following respects:

- a. Gas cylinder farther back and hidden by stock;
- b. Detachable box magazine; c. shorter range;
- d. Lighter; e. shorter.

The cartridge for the carbine has a lighter bullet and smaller powder charge than the rifle cartridge.

BROWNING AUTOMATIC RIFLE, CAL..30, M1918A2: GAS OPERATED, AUTOMATIC.

- a. Like M1 rifle in ammunition used and type of operation.
- b. Like Thompson Submachine Gun in that it fires from open bolt.
- c. Flash hider: Attachment on muzzle to hide flash of burning powder.

THOMPSON SUBMACHINE GUN, CAL..45, M1928A1: BLOWBACK, AUTOMATIC AND SEMIAUTOMATIC.

Principle of blow-back operation \_\_\_\_\_

The compensator on the muzzle helps hold the muzzle down in automatic fire.

Reasons why the weapon fires from an open bolt:

- a. \_\_\_\_\_
- b. \_\_\_\_\_

20-MM AUTOMATIC GUN, M2:  
GAS AND BLOWBACK, AUTOMATIC,  
MOUNTED ON AIRCRAFT.

Locate on the diagram the parts listed:

- Gas cylinder sleeve \_\_\_\_\_
- Gas cylinder pushrod \_\_\_\_\_
- Buffer \_\_\_\_\_
- Recoil Spring \_\_\_\_\_
- Gas cylinder \_\_\_\_\_
- Breechblock slide \_\_\_\_\_
- Breechblock lock \_\_\_\_\_
- Sear \_\_\_\_\_
- Muzzle brake \_\_\_\_\_

Recoil is absorbed by:

- a. \_\_\_\_\_
- \_\_\_\_\_
- b. \_\_\_\_\_
- \_\_\_\_\_

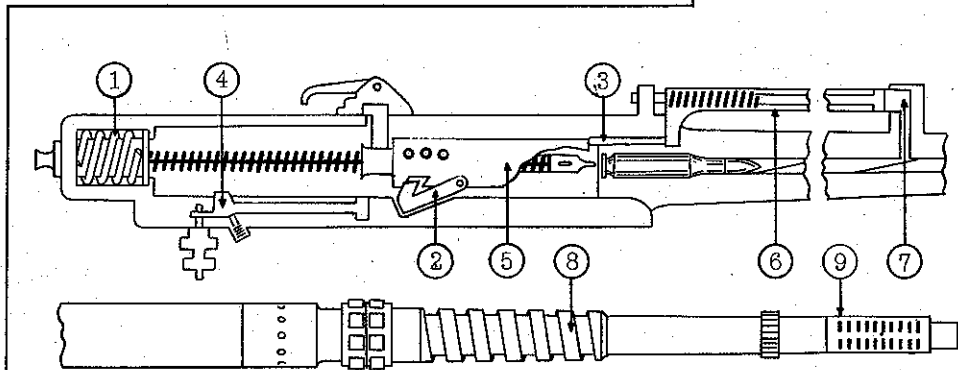

The gun fires from an open bolt.

## RECOIL OPERATED WEAPONS

Automatic, semiautomatic. (Barrel Moves)

**AUTOMATIC PISTOL, cal..45, M1911A1:**  
Semi-automatic.

**SAFETIES** (Numbers in parentheses after the names of parts refer to numbers on the diagram in The Soldier's Handbook, FM 21-100, page 41).

**HALF COCK NOTCH** — The first notch on the hammer (23) is so deep the sear (30) cannot be withdrawn from it by squeeze of the trigger (34).

**SAFETY LOCK** — With the hammer (23) cocked, the safety lock holds the sear (30) in the second sear notch on the hammer.

**GRIP SAFETY** — The arm on the grip safety (35) blocks the trigger (34) until the grip safety is depressed, when the arm rises above the trigger.

**DISCONNECTOR (33)** — Makes connection between the trigger (34) and sear (30) only when the slide (3) is closed and locked to the barrel (2), allowing the disconnector to be pushed up by the sear spring (31) into the notch in the bottom of the slide. Reason for pistol not firing automatically: \_\_\_\_\_

Reason for automatic operation of slide stop when magazine is empty: \_\_\_\_\_

The Colt Revolver, cal..45, M1917, and the Smith and Wesson Revolver, cal..45, M1917, are substitute weapons for the pistol. They are manually operated, have a revolving cylinder with six chambers, and may be fired either:

- a. Single action \_\_\_\_\_
- b. Double action \_\_\_\_\_

### BROWNING MACHINE GUNS: AUTOMATIC. (WATERCOOLED)

**BROWNING MACHINE GUN, CAL..30, M1917A1**

Locate the following parts on the diagram:

- a. Cocking lever \_\_\_\_\_
- b. Extractor \_\_\_\_\_
- c. Waterjacket \_\_\_\_\_
- d. Breech lock \_\_\_\_\_
- e. Bolt \_\_\_\_\_
- f. Firing pin \_\_\_\_\_
- g. Barrel extension \_\_\_\_\_

All standard machine guns now used by the Army are Brownings. Although there are various models, grouped generally as water-cooled, heavy barreled air-cooled, and aircraft guns, they work substantially alike.

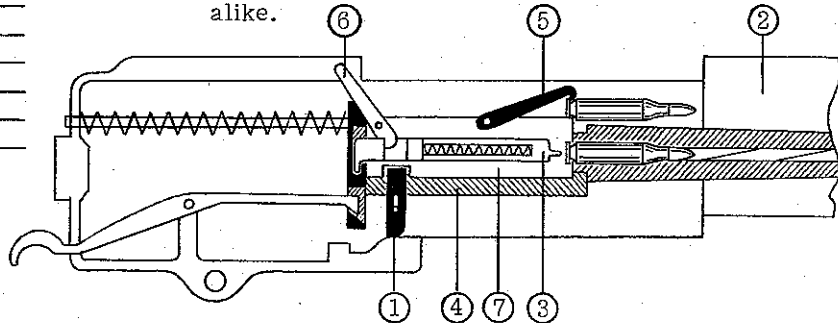

The extractor on machine gun extracts new cartridge from belt.

CLASSIFICATION OF MACHINE GUNS		
	TYPE	USE
Caliber	.30	
	.50	
Cooling	Water	
	Air	
Barrel	Heavy	
	Light	
Belt	Web	
	Metallic link	
Mounting	Fixed	
	Flexible	

#### 37-MM AUTOMATIC GUN, M4

In functioning, it resembles a Browning Machine Gun. Like an artillery piece, it has a breechblock (sliding wedge) and a recoil mechanism (hydro-

spring) to absorb the shock of recoil. It and the 20-mm gun are studied in small arms because there are no artillery repairmen in an Aviation Ordnance Company to maintain them.



**SMALL ARMS  
REFERENCE DATA**



1903 RIFLE

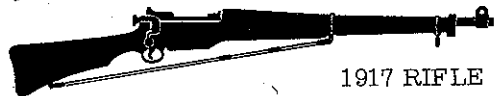

1917 RIFLE



M1 RIFLE



B. A. R.



BR. MACH. GUN, 30 CAL.



CARBINE .30 CAL.



PISTOL



REVOLVER



T. SUBM. GUN



BR. MACH. GUN 50 CAL.

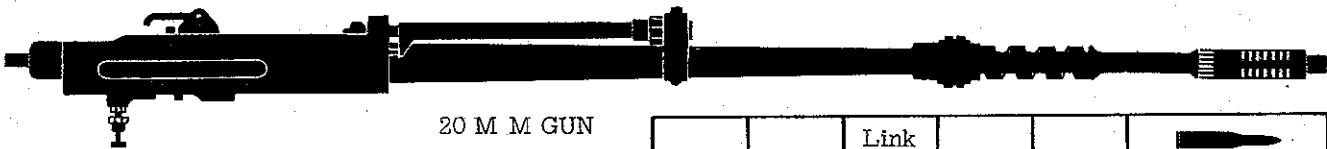

20 M M GUN

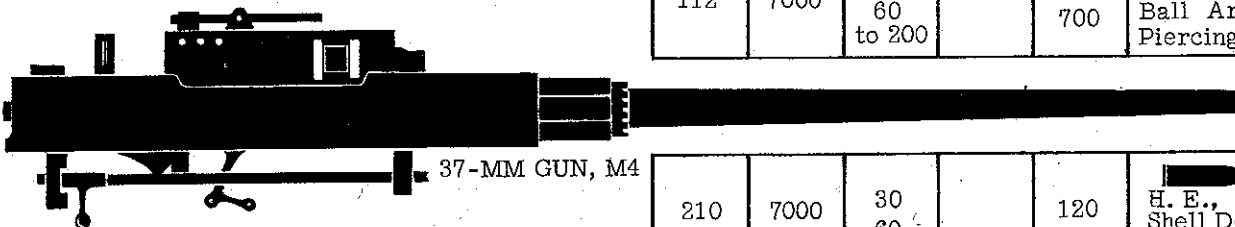

37-MM GUN, M4

DATA TABLE					
WEIGHT LBS.	RANGE YARDS	CAPACITY	FIRE POWER (PER MIN.)	CYCLIC RATE (PER MIN.)	AMMUNITION
9	3450	5	10-15		.30 Cal. Rifle Cartridge Ball Tracer Armor-Piercing
9	3450	6	8-12		
9	3450	8	40		
21	3450	20	50 (S.A.)	350-550	
19-33	3450	Web Belt or Link Belt		400-1200	
5	2000	15	45		Ball-smaller than for rifle
2-1/2	1600	7	35		.45 Cal. Pistol Cartridge (tracer for Sub-Machine Gun)
2-1/4	1600	6	25		
2-1/2	1600	20-50	50 (S.A.)		
64-100	7500	Link Belt		400-650	Ball, Tracer Armor-Piercing

112	7000	Link Belt 60 to 200		500-700	High Explosive Ball Armor-Piercing
-----	------	---------------------	--	---------	------------------------------------

210	7000	30 60		120	H. E., with Shell Destroying Tracer
-----	------	-------	--	-----	-------------------------------------

# AMMUNITION

## MILITARY EXPLOSIVES

LOW EXPLOSIVE	SENSITIVITY	USE
Black Powder _____	_____	_____
Smokeless Powder _____	_____	_____
E. C. Blank _____	_____	_____
Ballistite _____	_____	_____
<b>HIGH EXPLOSIVE</b>		
T.N.T. _____	_____	_____
Amatol _____	_____	_____
Explosive 'D' _____	_____	_____
Tetryl _____	_____	_____
Mercury Fulminate _____	_____	_____
Lead Azide _____	_____	_____

## ARTILLERY AMMUNITION

A Complete round of ammunition

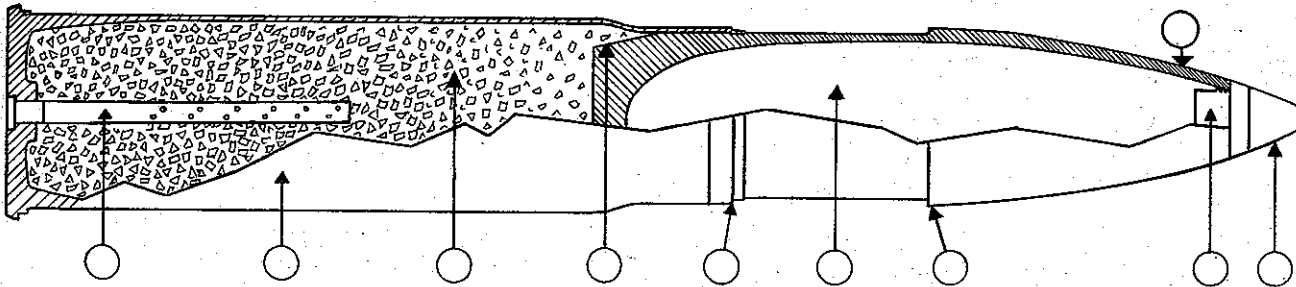

LOCATE AND GIVE PURPOSES OF THE FOLLOWING :

1. Cartridge Case \_\_\_\_\_
2. Primer \_\_\_\_\_
3. Propelling Charge \_\_\_\_\_
4. Boat Tailed Base \_\_\_\_\_
5. Rotating Band \_\_\_\_\_
6. Bursting Charge \_\_\_\_\_
7. Booster \_\_\_\_\_
8. Fuze \_\_\_\_\_
9. Ogive \_\_\_\_\_
10. Bourrelet \_\_\_\_\_

THE THREE TYPES OF ARTILLERY AMMUNITION

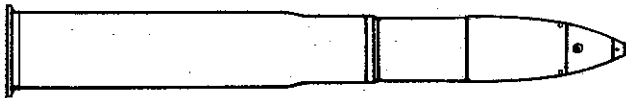

Cartridge case crimped to projectile



Free fit between projectile and cartridge case

A. \_\_\_\_\_ B. \_\_\_\_\_

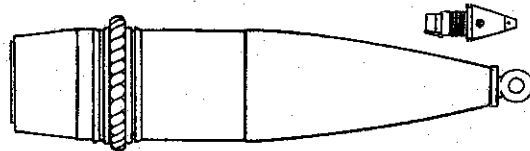
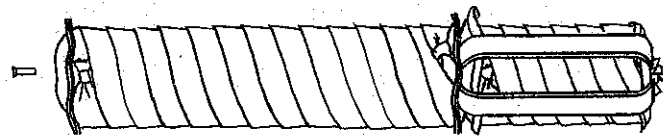

C. \_\_\_\_\_

FUZES

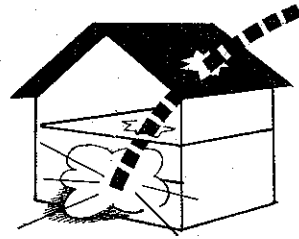
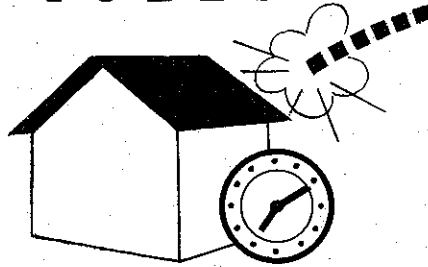
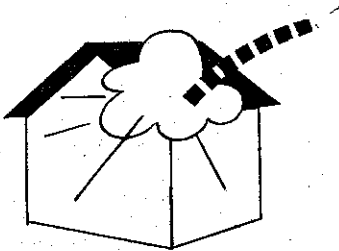

THE THREE TYPES OF FUZES

A. \_\_\_\_\_ B. \_\_\_\_\_ C. \_\_\_\_\_

POINT DETONATING FUZE, M48  
DELAY FUNCTIONING

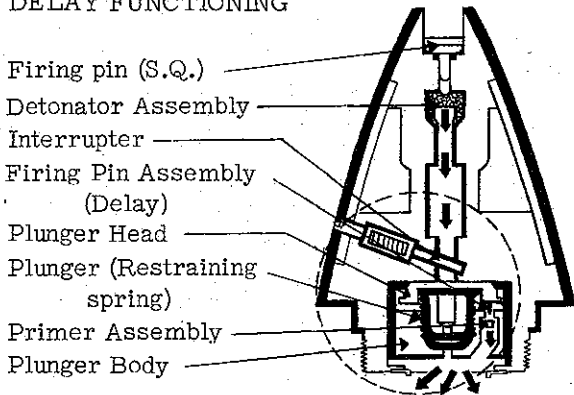

SUPERQUICK  
FUNCTIONING

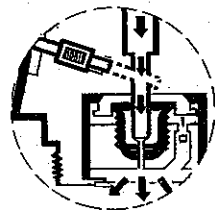

BASE DETONATING FUZE, M38

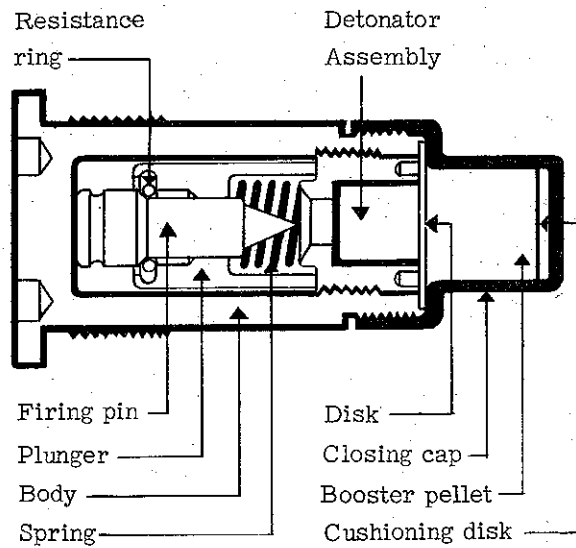

(Drawings not to scale)

# AMMUNITION

## COLOR MARKINGS

- |                               |   |
|-------------------------------|---|
| 1. High explosive _____       | 6. Chemical (Smoke) _____                         |
| 2. Armor piercing shell _____ | 7. Chemical (Non-Persistent gas...casualty) _____ |
| 3. Armor piercing shot _____  | 8. Chemical (Persistent gas...casualty) _____     |
| 4. Shrapnel _____             | 9. Chemical (Harassing agent) _____               |
| 5. Practice _____             | 10. Chemical (Incendiary) _____                   |

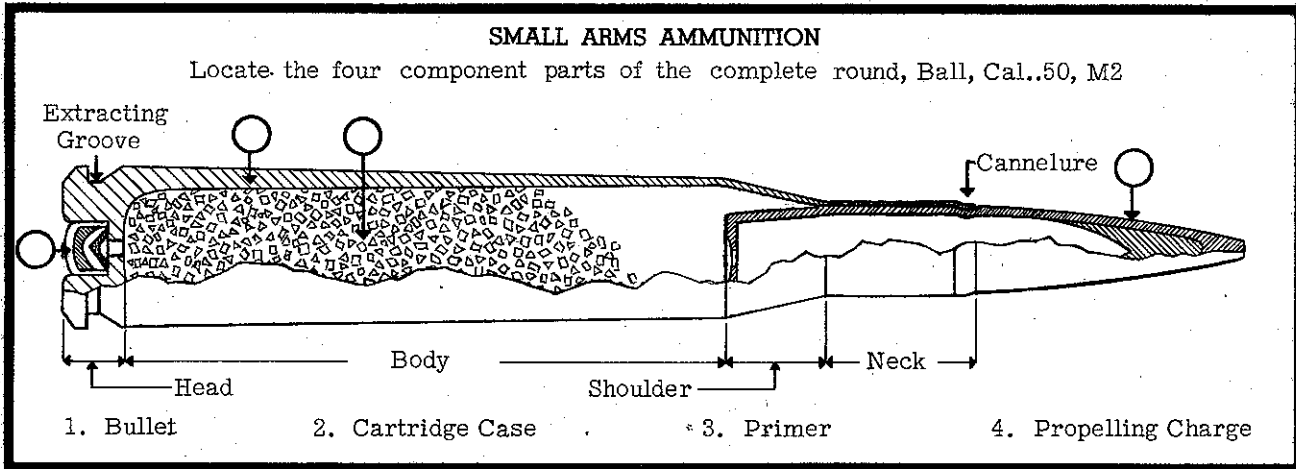

## DESCRIBE THE FOLLOWING SMALL-ARMS CARTRIDGES

1. Ball \_\_\_\_\_
2. Armor-piercing \_\_\_\_\_
3. Tracer \_\_\_\_\_

## IDENTIFY THE AMMUNITION PACKED IN THE FOLLOWING BOXES

- A. \_\_\_\_\_ B. \_\_\_\_\_ C. \_\_\_\_\_

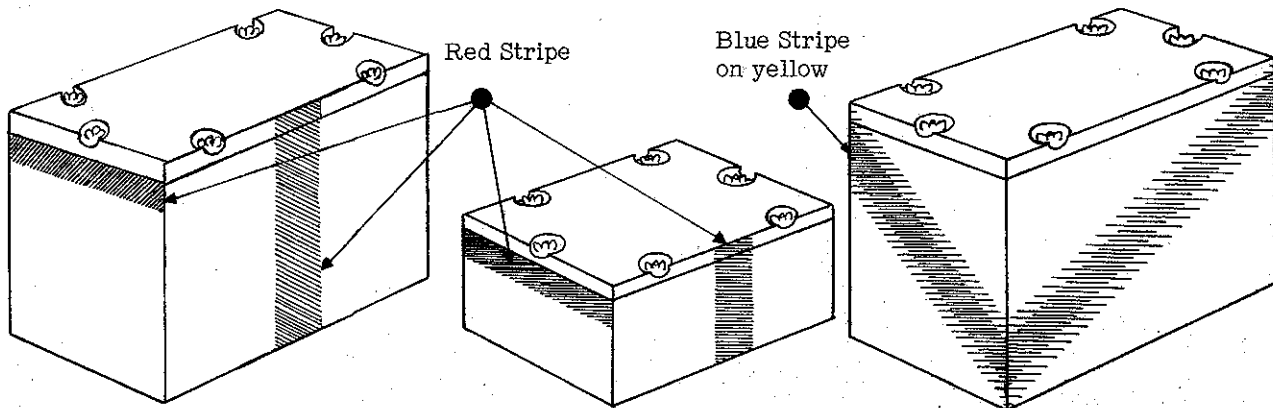

**GRENADES**

State which grenade is Chemical and which is Fragmentation.

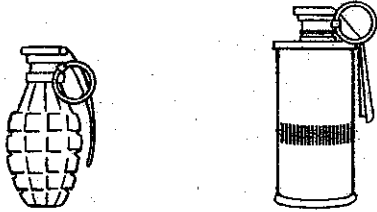

1. \_\_\_\_\_ 2. \_\_\_\_\_

**IDENTIFY THE FOLLOWING PARTS:**

1. Fuze Body
2. Grenade Body
3. Lever
4. Primer
5. Detonator
6. Bursting Charge

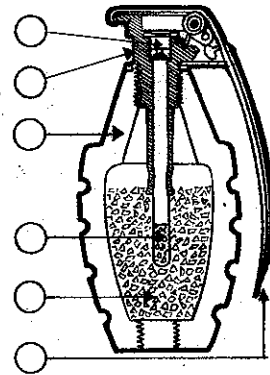

**TRENCH MORTAR AMMUNITION**

Locate the following and give its purpose:

1. Fuze \_\_\_\_\_
2. Safety Pin \_\_\_\_\_
3. Cotter Pin and Ring \_\_\_\_\_
4. Fin Assembly \_\_\_\_\_
5. Primer \_\_\_\_\_
6. Propelling Charge \_\_\_\_\_

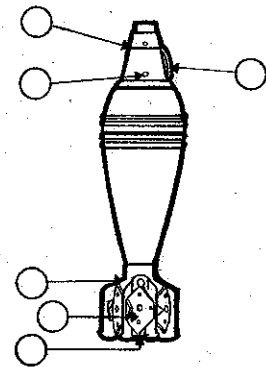

**TYPES OF BOMBS**

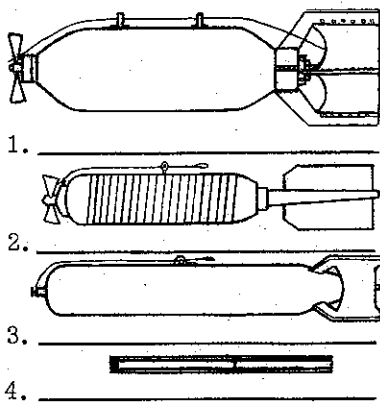

4. \_\_\_\_\_

**BOMBS**

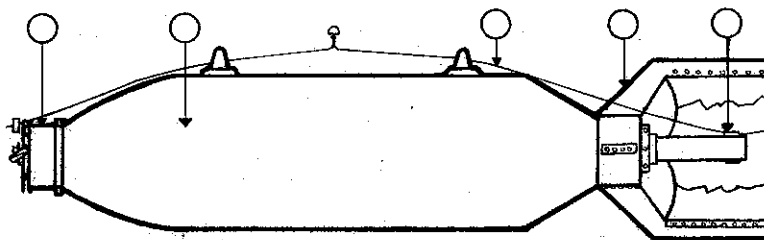

**IDENTIFY THE FOLLOWING:**

1. Nose Fuze
2. Tail Fuze
3. Fin Assembly
4. Arming Wire
5. Bomb Body

**ANTITANK MINES**

Locate the following and give its purpose

1. Spider \_\_\_\_\_
2. Safety fork \_\_\_\_\_
3. Fuze \_\_\_\_\_
4. Body \_\_\_\_\_

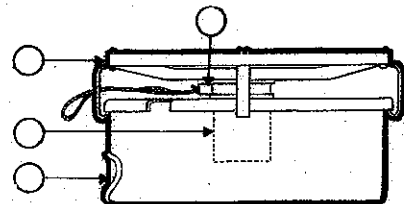

# AUTOMOTIVE MATERIEL

## COMPONENTS OF AN AUTOMOBILE

(BODY NOT SHOWN)

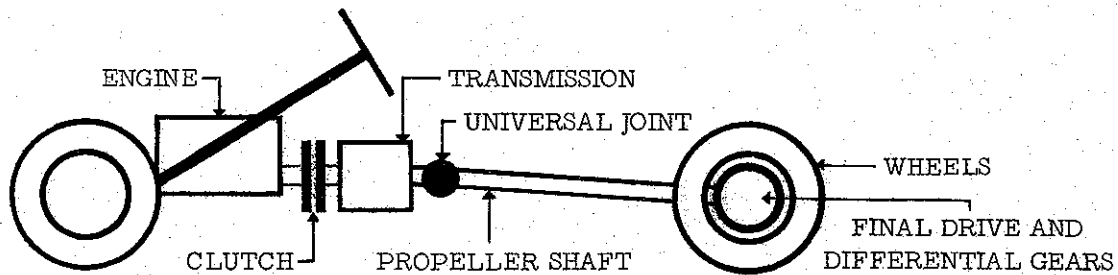
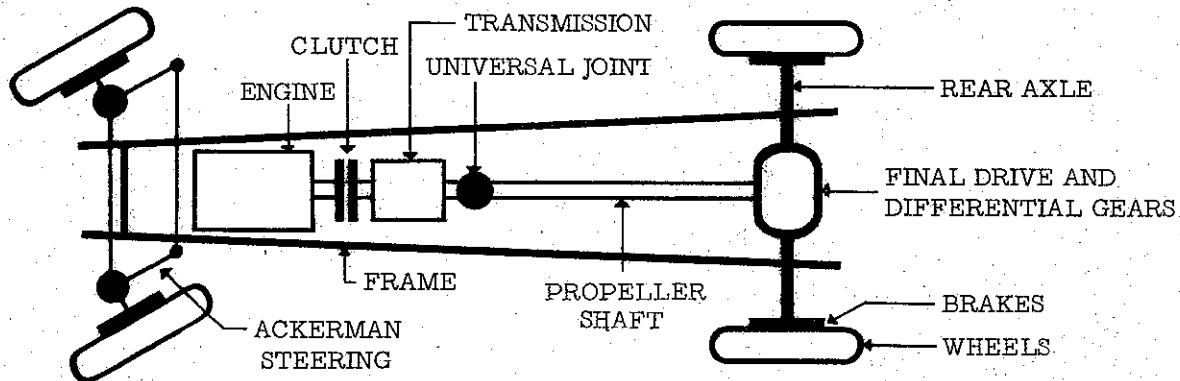

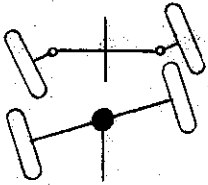
1. FRAME — supports power plant, transmission system, running gear and body.
2. STEERING — developed by Dr. Ackerman, causes each wheel to turn on its own pivot — instead of having the entire front axle pivot.
 
3. WHEELS — disc type used today.
4. BRAKES — must be about 5 times as powerful as engine.
5. ENGINE — 85 H.P. motor gives 85 H.P. only when it is turning over at 3200 R.P.M.
6. CLUTCH — engages and disengages motor from rest of transmission system.

7. TRANSMISSION
  - a. Provides high turning effort from engine with low speed of rear wheels.
  - b. Provides low turning effort from engine with high speed of rear wheels.
  - c. Provides for reversing direction.
8. UNIVERSAL JOINT — makes a flexible connection in the propeller shaft so that the propeller shaft can move up and down with the rear wheels as the shaft rotates.
9. PROPPELLER SHAFT — transmits power to rear axle.
10. DIFFERENTIAL (spider gear) — allows outside rear wheel to turn faster than inside when automobile goes around curves.
11. FINAL DRIVE (ring and pinion gear) — allows propeller shaft to turn rear axle, at right angles.

FOUR-STROKE GASOLINE ENGINE

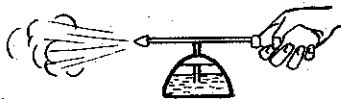
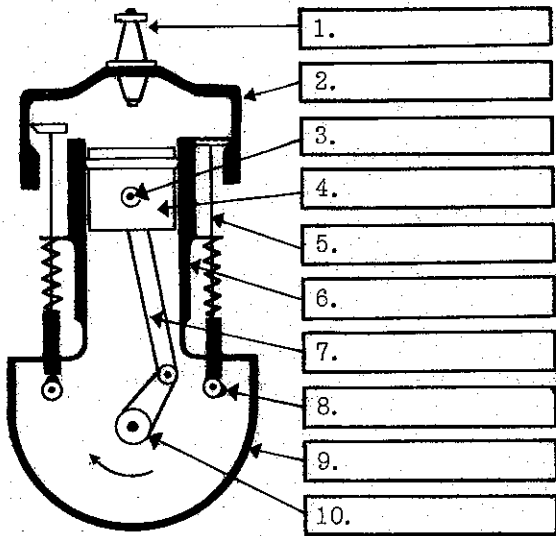

CARBURETOR

Purpose \_\_\_\_\_

Proportions by weight: { \_\_\_\_\_ parts air  
 \_\_\_\_\_ parts gasoline



FUEL SYSTEM

Mechanical Fuel Pump

Operated \_\_\_\_\_  
 \_\_\_\_\_



COOLING SYSTEMS

Types \_\_\_\_\_

Thermostats \_\_\_\_\_

STROKE CYCLE

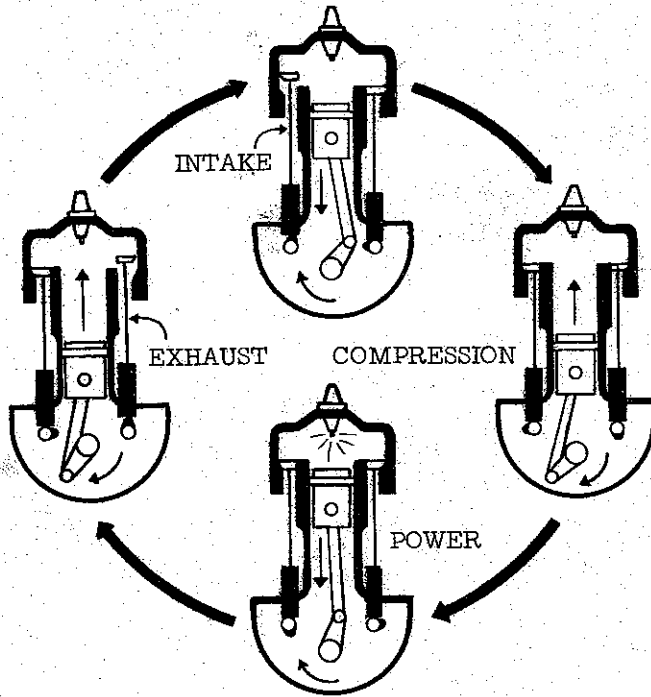

IGNITION SYSTEM

- (a) Battery \_\_\_\_\_
- \_\_\_\_\_
- (b) Switch \_\_\_\_\_
- \_\_\_\_\_
- (c) Coil \_\_\_\_\_
- \_\_\_\_\_
- (d) Breaker points \_\_\_\_\_
- \_\_\_\_\_
- (e) Condenser \_\_\_\_\_
- \_\_\_\_\_
- (f) Distributor \_\_\_\_\_
- \_\_\_\_\_
- (g) Spark plugs \_\_\_\_\_
- \_\_\_\_\_
- (h) Starter \_\_\_\_\_
- \_\_\_\_\_
- (i) Generator \_\_\_\_\_
- \_\_\_\_\_

# LUBRICATION

## PURPOSES

1. \_\_\_\_\_
2. \_\_\_\_\_
3. \_\_\_\_\_

## WAYS OF CHECKING OIL

1. \_\_\_\_\_
2. \_\_\_\_\_
3. \_\_\_\_\_
4. \_\_\_\_\_

## CONTAMINATION

1. Cause \_\_\_\_\_

- DILUTION
1. Gasoline — cause \_\_\_\_\_
  2. Water — cause \_\_\_\_\_

# BRAKES

1. Types — service \_\_\_\_\_  
parking \_\_\_\_\_

## PARTS OF HYDRAULIC SYSTEM

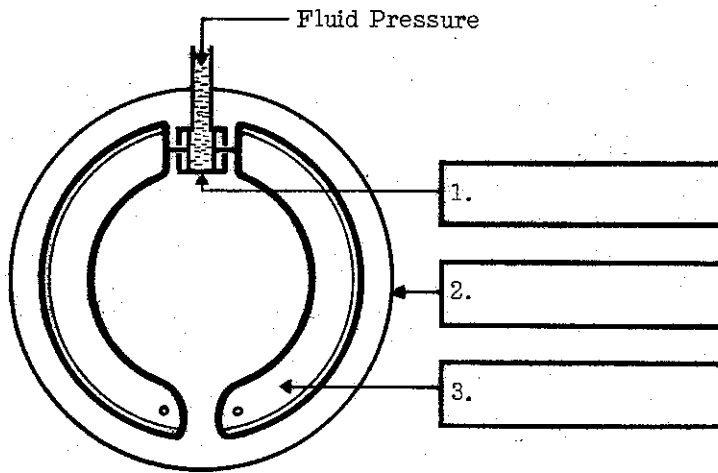

## OPERATION

- Hydraulic \_\_\_\_\_
- Air \_\_\_\_\_
- Vacuum \_\_\_\_\_
- Electric \_\_\_\_\_



# CLASSIFICATION OF VEHICLES

## GENERAL PURPOSE VEHICLES

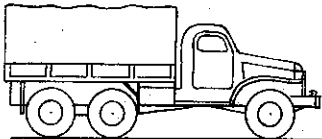
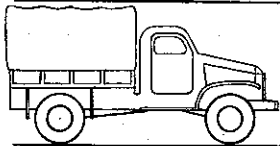
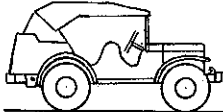
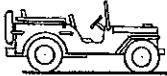

## COMBAT VEHICLES

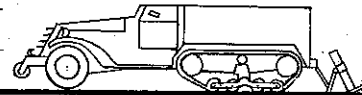
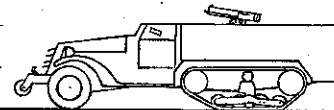
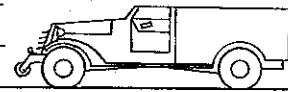
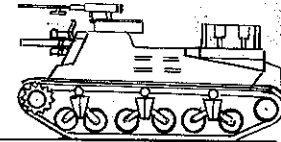
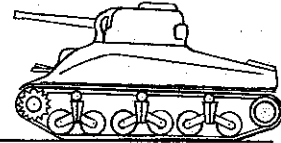

## COMBAT VEHICLES

Important characteristics of a combat vehicle are:

1. PROTECTION FOR THE CREW--determined by the thickness of the armor. The armor may vary from 1/4 inch to 3 inches in thickness depending on the type of vehicle.
2. FIRE POWER--determined by the armament of the combat vehicle; that is, the number and caliber of the guns carried. Combat vehicles carry both small arms and artillery pieces.
3. MOBILITY--determined by the power plant and suspension system.

## TANK SUSPENSION SYSTEMS USE

1. \_\_\_\_\_ axles
2. \_\_\_\_\_ wheels
3. \_\_\_\_\_ springs

## POWER PLANTS IN TANKS CONSIST OF

1. \_\_\_\_\_ engines
2. \_\_\_\_\_ engines
3. \_\_\_\_\_ engines, inline and radial

## SPECIAL PURPOSE VEHICLES

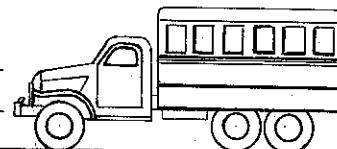
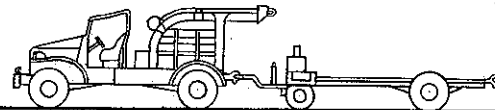
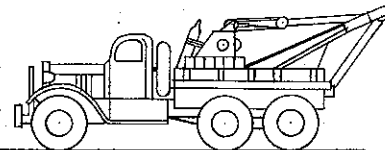
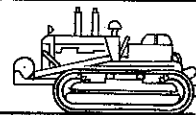

### RADIAL ENGINES

Advantages of radial engines over in - line engines:

- A. \_\_\_\_\_  
 \_\_\_\_\_  
 B. \_\_\_\_\_  
 \_\_\_\_\_

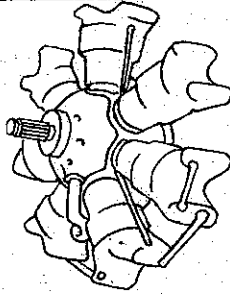

Difference between radial and in - line engines:

- A. \_\_\_\_\_  
 \_\_\_\_\_  
 B. \_\_\_\_\_  
 \_\_\_\_\_  
 C. \_\_\_\_\_

### DIESEL ENGINES



Advantages of Diesel power over Gasoline power:

- A. \_\_\_\_\_  
 \_\_\_\_\_  
 B. \_\_\_\_\_  
 \_\_\_\_\_  
 C. \_\_\_\_\_  
 \_\_\_\_\_

Differences between 4 - stroke Diesel cycle and 4 - stroke Gasoline cycle: A. \_\_\_\_\_

- B. \_\_\_\_\_  
 \_\_\_\_\_  
 C. \_\_\_\_\_  
 \_\_\_\_\_

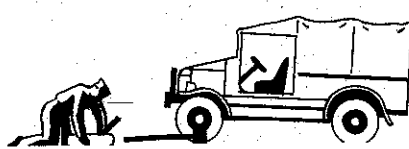
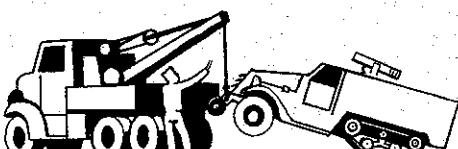
### ECHELONS OF MAINTENANCE

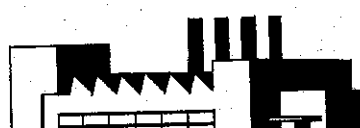
	PERSONNEL	DUTIES
<p>1. Driver - Assistant Driver</p> 	<p>_____</p> <p>_____</p> <p>_____</p> <p>_____</p>	<p>_____</p> <p>_____</p> <p>_____</p> <p>_____</p>
<p>2. Maintenance Crew Using Arm</p> 	<p>_____</p> <p>_____</p> <p>_____</p> <p>_____</p>	<p>_____</p> <p>_____</p> <p>_____</p> <p>_____</p>
<p>3. Automotive Unit Medium Maintenance Co.</p> 	<p>_____</p> <p>_____</p> <p>_____</p> <p>_____</p>	<p>_____</p> <p>_____</p> <p>_____</p> <p>_____</p>
<p>4. Base Shop or Arsenal</p> 	<p>_____</p> <p>_____</p> <p>_____</p> <p>_____</p>	<p>_____</p> <p>_____</p> <p>_____</p> <p>_____</p>

# FIELD RIGGING

## KNOTS, BENDS AND HITCHES

Rigging is the construction of devices to aid in lifting and hoisting operations. It is especially useful to automotive and artillery mechanics.

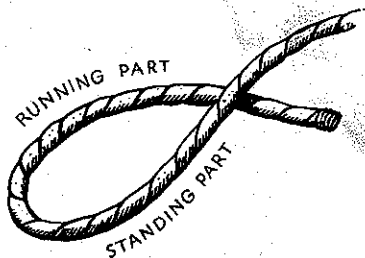

1. BIGHT



2. OVERHAND KNOT

USE: \_\_\_\_\_  
 \_\_\_\_\_  
 \_\_\_\_\_



3. SQUARE KNOT

USE: \_\_\_\_\_  
 \_\_\_\_\_  
 \_\_\_\_\_



4. GRANNY

FAULT: \_\_\_\_\_  
 \_\_\_\_\_  
 \_\_\_\_\_



5. THIEF

FAULT: \_\_\_\_\_  
 \_\_\_\_\_  
 \_\_\_\_\_



6. SINGLE SHEET BEND

USE: \_\_\_\_\_  
 \_\_\_\_\_  
 \_\_\_\_\_  
 \_\_\_\_\_



7. DOUBLE SHEET BEND

USE: \_\_\_\_\_  
 \_\_\_\_\_  
 \_\_\_\_\_  
 \_\_\_\_\_



8. SHEEPSHANK

USE: \_\_\_\_\_  
 \_\_\_\_\_  
 \_\_\_\_\_

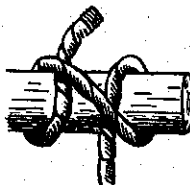
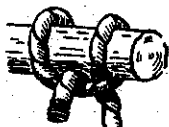

9. CLOVE HITCH

USE: \_\_\_\_\_  
 \_\_\_\_\_  
 \_\_\_\_\_



10. HALF HITCH

USE: \_\_\_\_\_  
 \_\_\_\_\_  
 \_\_\_\_\_  
 \_\_\_\_\_

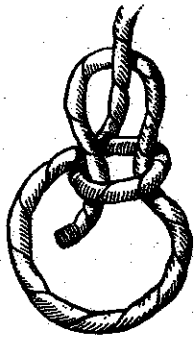

11. BOWLINE

USE : \_\_\_\_\_  
 \_\_\_\_\_  
 \_\_\_\_\_  
 \_\_\_\_\_



12. RUNNING BOWLINE

USE : \_\_\_\_\_  
 \_\_\_\_\_  
 \_\_\_\_\_  
 \_\_\_\_\_



13. BOWLINE ON BIGHT

USE : \_\_\_\_\_  
 \_\_\_\_\_  
 \_\_\_\_\_  
 \_\_\_\_\_

Tackle consists of rope used with blocks so as to provide a mechanical advantage. The mechanical advantage of any tackle may be roughly figured by counting the number of ropes actually supporting the weight.

1. BLOCK

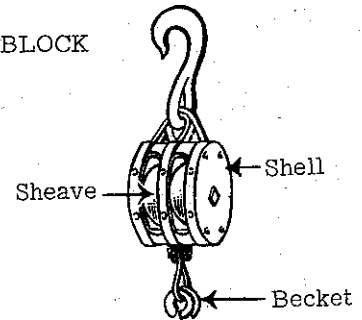

2. FIXED BLOCK

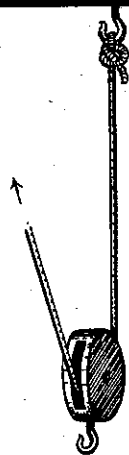

3. WHIP



4. GUN

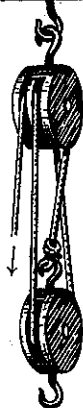

5. LUFF



6. DOUBLE LUFF

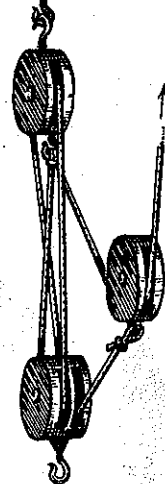

7. DOUBLE BURTON

# HOISTING DEVICES

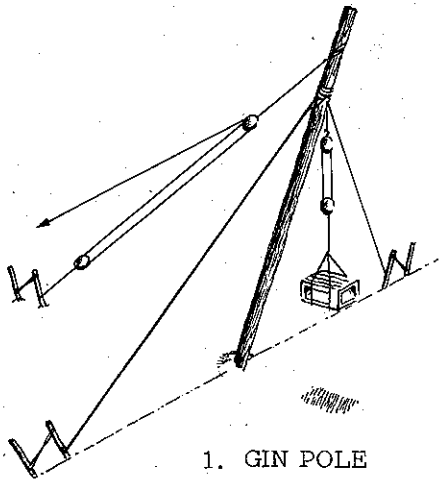

1. GIN POLE

PURPOSE: \_\_\_\_\_  
\_\_\_\_\_  
\_\_\_\_\_

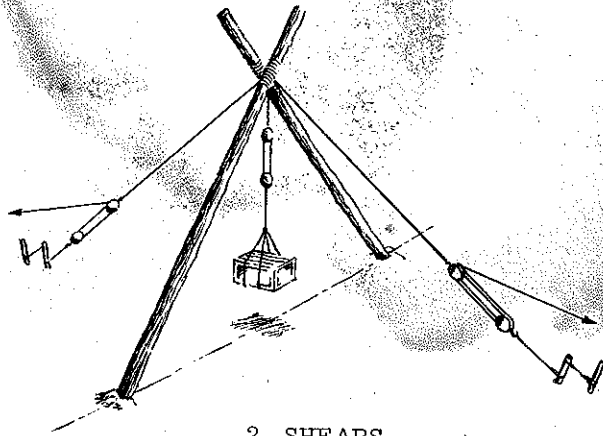

2. SHEARS

PURPOSE: \_\_\_\_\_  
\_\_\_\_\_  
\_\_\_\_\_

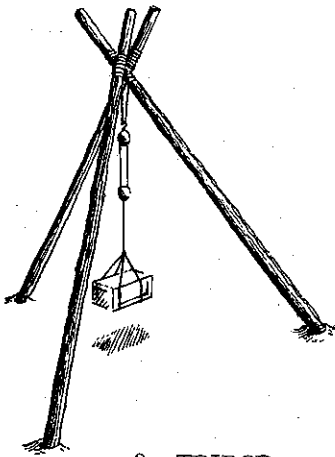

3. TRIPOD

PURPOSE: \_\_\_\_\_  
\_\_\_\_\_  
\_\_\_\_\_

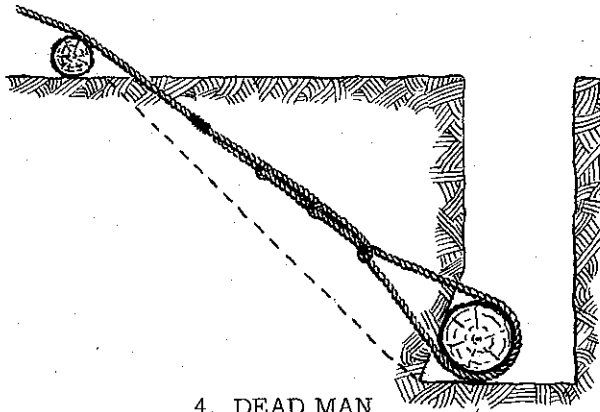

4. DEAD MAN

PURPOSE: \_\_\_\_\_  
\_\_\_\_\_  
\_\_\_\_\_

NOTES \_\_\_\_\_  
\_\_\_\_\_  
\_\_\_\_\_  
\_\_\_\_\_  
\_\_\_\_\_

# GLOSSARY

## SIMPLE EXPLANATION OF ORDNANCE TERMS

**ARMAMENT** The weapons carried or mounted in a vehicle, plane or vessel.

**ARMOR** The covering or shield of steel plate to furnish protection against bombs or gunfire.

**ARSENAL** A plant where Ordnance materiel is manufactured and repaired.

**ASSEMBLY** A unit made up of a number of parts fitted together, not easily disassembled, e.g.: Barrel and receiver assembly for 1903 Rifle; the barrel is ordinarily disassembled from the receiver only at an arsenal.

**AZIMUTH** The angle measured clockwise from the north. The angle to which a cannon is traversed. For use of the term in map reading, see page 35.

**BALLISTICS** The science that deals with the motion of a projectile, both in the bore of the weapon and after leaving the muzzle, e.g.: The science of ballistics would determine the amount of powder which, for a particular gun and projectile, is necessary to give a certain muzzle velocity.

**BREECH** The rear end of the tube or barrel of a weapon. See Muzzle, next page.

**CALIBER** See Elem. Prin. of Ord., page 56.

**CAM** A moving part whose surface either imparts motion to, or receives motion from, another part by sliding contact. See page 57.

**CARRIAGE** The mount which furnishes support for a cannon in firing and, in the case of mobile artillery, enables the weapon to be moved readily from one position to another. See page 59.

**CONTACT PARTY** See Organization of the Ordnance Department, page 54.

**DEPOT** A place organized for receiving, storing, inspecting and issuing military supplies.

**ECHELON** (1) Echelons of Command: Steps in the organization of command, e.g.:

- Platoon
- Company
- Battalion
- Regiment
- etc.

(2) Echelons of maintenance: Steps in the organization of maintenance units. See page 74.

(3) Echelons of formations:

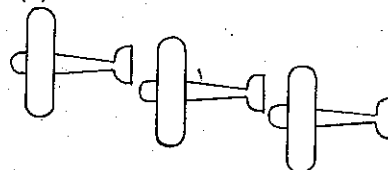

**ELEVATION** (1) Height above sea level. See Mag Reading, page 35.

(2) The vertical angle to which the muzzle of a cannon is raised.

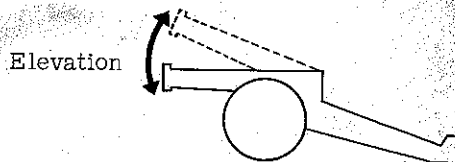

**FIRE CONTROL EQUIPMENT** Equipment used to direct artillery fire — not attached to the weapon. See page 61.

**GROUP** A unit made up of a number of parts fitted together, easily disassembled, e.g.: bolt group for 1903 rifle, includes firing pin, extractor, mainspring, etc.

**GUN** See Artillery, page 58.

**HOWITZER** See Artillery, page 58.

**MAGAZINE** (1) That part of a small arm into which cartridges are placed preparatory to being loaded into the chamber.  
(2) A storehouse for ammunition.

**MAINTENANCE** The tasks performed to keep materiel in good working order.

**MORTAR** See Artillery, page 58.

**MIL** See Elementary Principles of Ordnance, page 57.

**MUZZLE** The front end of the tube or barrel of a weapon.

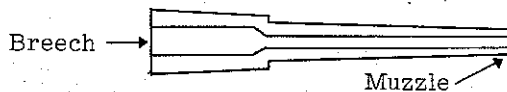

**MUZZLE VELOCITY** The speed (usually expressed as feet per second) with which a projectile leaves the muzzle of a weapon.

**NOMENCLATURE** A system of names. The Ordnance Department publishes a catalogue including Standard Nomenclature Lists which give the names of major items, such as guns, ammunition and vehicles and their component parts.

**ORDNANCE MATERIEL** The general name for equipment supplied by the Ordnance Department. See page 52.

**PIECE** A weapon, such as a pistol, rifle or cannon.

**RAILHEAD** That point along a railroad where supplies are unloaded for transfer to other means of transportation. Supplies may move both to the front and to the rear thru railheads.

**RANGE, EFFECTIVE** The maximum distance at which a weapon may be aimed and fired with damaging effect.

**RECOIL** The backward movement of a weapon caused by the forces of discharge. See page 56.

**RIFLING** A number of machined spiral grooves in the bore of a weapon for imparting rotation to a projectile. The surfaces of the bore between grooves are called lands. See Small Arms, page 62.

**ROUND** A round of ammunition consists of all the component parts necessary to fire a weapon once. See Ammunition, page 66.

**SIGHTING EQUIPMENT** Equipment used in aiming — attached to the weapon.

**TRAJECTORY** The path of a projectile in flight. See Elem. Prin. of Ord., page 56.

**TRAVERSE** The lateral change of direction in which a cannon points

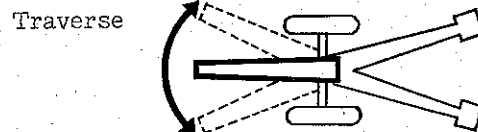

**TRYTON BLOCK** A block of compressed TNT

