

*no distribution* *superior's copy*  
~~TOP SECRET~~  
*43 a.m.*  
*TC 57, 44*

FM 23-6

WAR DEPARTMENT

BASIC FIELD MANUAL

U. S. RIFLE, CALIBER .30,  
M1917

28 October, 1943

REGRABED UNCLASSIFIED BY  
AUTHORITY OF DOD DIR. 5200.1 R  
BY RKWS ON 12/20/03

*Dissemination of restricted matter.*—The information contained in restricted documents and the essential characteristics of restricted material may be given to any person known to be in the service of the United States and to persons of undoubted loyalty and discretion who are cooperating in Government work, but will not be communicated to the public or to the press except by authorized military public relations agencies. (See also par. 185, AR 380-5, 28 Sep 1942.)

~~RESTRICTED~~

FM 23-6

BASIC FIELD MANUAL



U. S. RIFLE, CALIBER .30,  
M1917



*Dissemination of restricted matter.*—The information contained in restricted documents and the essential characteristics of restricted material may be given to any person known to be in the service of the United States and to persons of undoubted loyalty and discretion who are cooperating in Government work, but will not be communicated to the public or to the press except by authorized military public relations agencies. (See also par. 18b, AR 380-5, 28 Sep 1942.)

UNITED STATES  
GOVERNMENT PRINTING OFFICE  
WASHINGTON : 1943

WAR DEPARTMENT,  
WASHINGTON 25, D. C., 28 October 1943.

FM 23-6, Basic Field Manual, U. S. Rifle, Caliber .30, M1917,  
is published for the information and guidance of all con-  
cerned.

[A. G. 300.7 (15 Sep 43).]

BY ORDER OF THE SECRETARY OF WAR:

G. C. MARSHALL,  
*Chief of Staff.*

OFFICIAL:

J. A. ULIO,  
*Major General,*  
*The Adjutant General.*

DISTRIBUTION:

Bn and H, 2-7, 9, 10, 17-19 (2); C, 2-7, 9, 10, 17-18 (1),  
19 (3).

(For explanation of symbols, see FM 21-6.)

## TABLE OF CONTENTS

	Paragraphs
CHAPTER 1. Mechanical training.	
SECTION I. General.....	1-3
II. Disassembly and assembly.....	4-7
III. Care and cleaning.....	8-17
IV. Functioning.....	18
V. Spare parts, appendages, and accessories....	19-21
VI. Instruments.....	22
VII. Ammunition.....	23-29
CHAPTER 2. Marksmanship—known-distance targets and transition firing.	
SECTION I. General.....	30-38
II. Preparatory marksmanship training.....	39-46
III. Qualification courses.....	47-51
IV. Range practice.....	52-55
V. Equipment, targets, and range precautions..	56-58
VI. Small-bore practice.....	59-62
CHAPTER 3. Marksmanship, moving ground targets.	
SECTION I. General.....	63-64
II. Moving vehicles.....	65-67
III. Moving personnel.....	68-69
IV. Moving-target ranges.....	70
CHAPTER 4. Marksmanship, aerial targets.	
SECTION I. Nature of aerial targets for rifle.....	71-72
II. Technique of fire.....	73-77
III. Marksmanship training.....	78-82
IV. Miniature range practice.....	83-85
V. Towed-target and radio-controlled-airplane-target firing.....	86-89
VI. Ranges, targets, and equipment.....	90-95
CHAPTER 5. Technique of fire of rifle squad.	
SECTION I. General.....	96-98
II. Range estimation.....	99-103
III. Target designation.....	104-107
IV. Rifle fire and its effect.....	108-114
V. Application of fire.....	115-122
VI. Landscape-target firing.....	123-130
VII. Field-target firing.....	131-134
VIII. Destruction of ordnance matériel.....	135
CHAPTER 6. Advice to instructors.	
SECTION I. General.....	136
II. Mechanical training.....	137
III. Marksmanship, known-distance targets....	138-154
IV. Marksmanship, aerial targets.....	155-159
V. Technique of fire.....	160-167
VI. Safety precautions.....	168-169
INDEX .....	Page 313

~~RESTRICTED~~

## BASIC FIELD MANUAL

## U. S. RIFLE, CALIBER .30, M1917 (ENFIELD)

(This manual supersedes FM 23-6, 3 August 1942; including C 1, 5 November 1942, and C 2, 22 April 1943.)

Attention is directed to FM 21-7 for details as to how appropriate training films and film strips are intended to be used and how they are made available for use during training with the U. S. rifle, caliber .30, M1917.

## CHAPTER 1

## MECHANICAL TRAINING

	Paragraphs
SECTION I. General.....	1-3
II. Disassembly and assembly.....	4-7
III. Care and cleaning.....	8-17
IV. Functioning.....	18
V. Spare parts, appendages, and accessories.....	19-21
VI. Instruments.....	22
VII. Ammunition.....	23-29

## SECTION I

## GENERAL

■ 1. OBJECT.—This chapter is designed to give the soldier training that will insure his ability to take care of the rifle and keep it in operation.

■ 2. DESCRIPTION OF RIFLE.—*a.* The U. S. rifle, caliber .30, M1917 (fig. 1) is a breech-loading magazine rifle of the bolt type. It is popularly referred to as the "Enfield rifle." The ammunition is loaded in clips of five rounds. Ammunition bandoleers for this rifle have six pockets with a total capacity of 60 rounds.

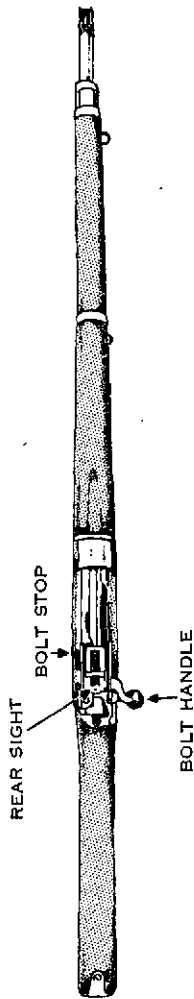
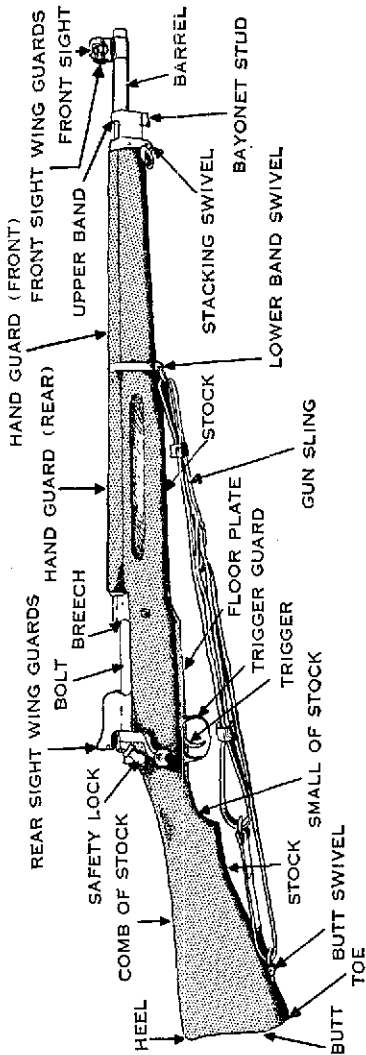

FIGURE 1.—U. S. rifle, caliber .30, M1917.

*b. Miscellaneous data:*

Weight, without bayonet.....	pounds--	9.187
Weight, with bayonet.....	do....	10.312
Length, without bayonet.....	inches--	46.3
Length, with bayonet.....	do....	62.3
Diameter of bore.....	do....	.30
Trigger pull:		
Minimum.....	pounds--	3.0
Maximum.....	do....	7.0
Rifling:		
Number of grooves.....		5
Twist, uniform, left hand, one turn		
in.....	inches--	10
Sight radius (distance from top of front sight		
to rear side of leaf, leaf raised)....	do....	31.76
Sight radius (battle sight).....	do....	31.69
Magazine capacity.....	rounds--	6

*c. Rear sight.*—The rear sight of this rifle has no windage gage. The leaf contains a peep sight which moves vertically on a slide and hence makes no correction for the drift of the bullet. The battle sight is of the peep type and is attached to the lower end of the leaf. It is raised to position for aiming when the leaf is laid and is adjusted for a range of 400 yards. The leaf is graduated from 200 to 1,600 yards. It is graduated in multiples of 100 yards from 200 to 900 yards and in multiples of 50 yards from 900 to 1,600 yards (fig. 2).

*d. Front sight.*—The front sight is protected by wing guards and is adjusted laterally during assembly at the arsenal. It is locked in position, after adjustment, by upsetting part of the metal base into the lock seat with a punch.

■ **3. ORGANIZATION FOR INSTRUCTION.**—Instruction is conducted by officers and selected noncommissioned officers. Squad leaders supervise the work of their squads, and the remaining noncommissioned officers assist as directed. Teaching is facilitated if the unit is divided into small groups.

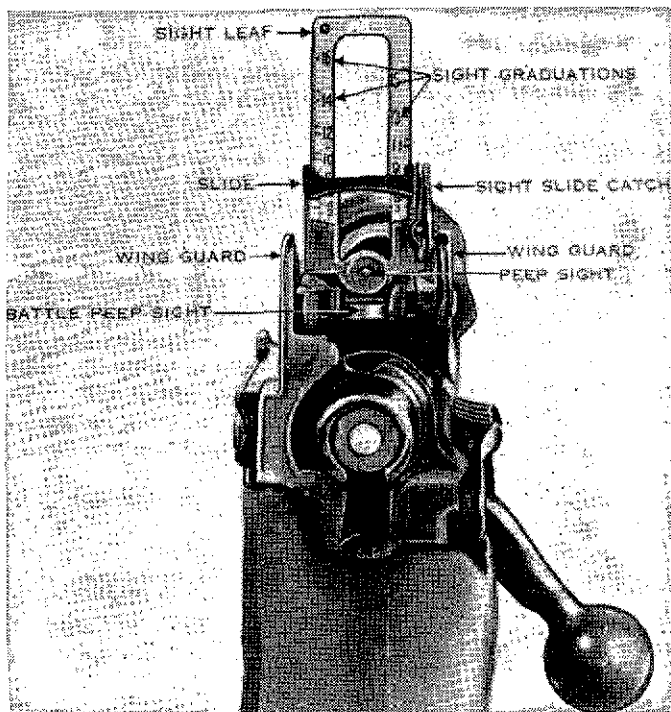

FIGURE 2.—Rear sight, U.S. rifle, caliber .30, M1917.

## SECTION II

### DISASSEMBLY AND ASSEMBLY

■ 4. BEGINNING OF TRAINING.—This training will begin as soon as practicable after the soldier receives his rifle. In any case it will be completed before any firing is done with the rifle by the individual. Concurrently, instruction in the care and cleaning of the rifle will also be covered.

■ 5. NOMENCLATURE (figs. 1, 2, and 3).—The names of the principal parts to which reference is made in mechanical



training are readily learned as this training progresses. Instructors will therefore take care to name the parts clearly and correctly. A sufficient knowledge of nomenclature is gained by the soldier during instruction in mechanical training.

■ 6. **DISASSEMBLY WHICH SOLDIER MAY PERFORM.**—For cleaning, only the following parts of the rifle may be removed by the individual soldier:

Floor plate.

Follower.

Magazine spring.

Gun sling.

Bolt (including striker, mainspring, sleeve, cocking piece, and extractor).

*a. To remove and disassemble floor plate and follower.*—Insert the bullet end of a cartridge through the hole in the floor plate and press down on the floor plate catch. At the same time press the floor plate to the rear with the left thumb. This releases the floor plate, which may then be removed together with the magazine spring and follower. Raise the rear end of the magazine spring until it clears the spring stops on the floor plate and draw it out of its mortise; in the same manner separate the magazine spring from the follower.

*b. To remove and disassemble bolt.*—Place the butt of the rifle under the right armpit and hold the stock firmly against the body with the right arm. With the left thumb, pull the bolt stop to the left and at the same time raise the bolt handle and draw out the bolt to the rear (figs. 4 and 5). Hook a loop of strong string on the dismounting hook on the cocking piece lug and holding the bolt in the left hand and the string in the right, draw the cocking piece out until the lug clears the end of the bolt (fig. 6). Then by moving the right hand in a circular path counterclockwise, unscrew the sleeve and withdraw the sleeve, cocking piece, mainspring, and striker from the bolt.

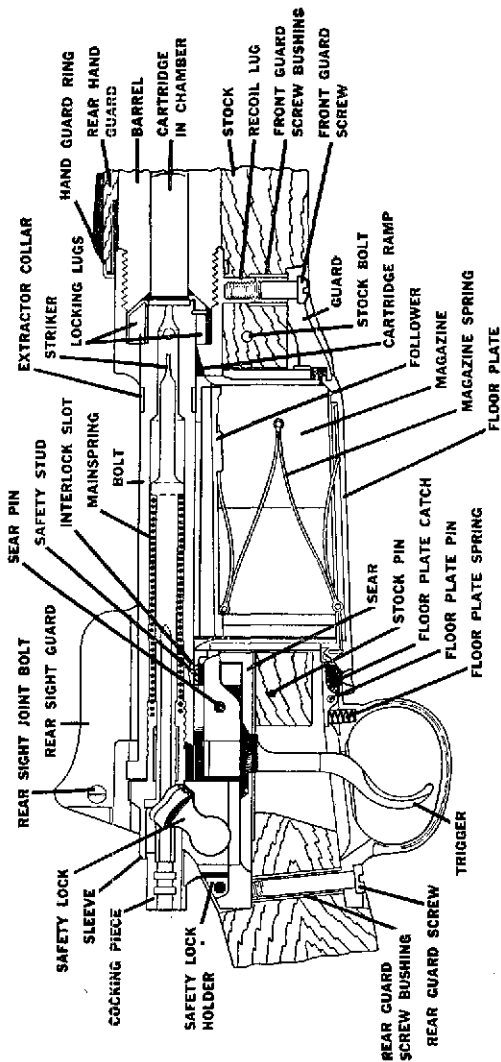

FIGURE 3.—Cross section of mechanism, U. S. rifle, caliber .30, M1917.

Grasp the sleeve with the thumb and forefinger of the left hand; place the point of the striker against a hard surface and force the sleeve downward, compressing the mainspring until the lug on the cocking piece clears the lug slot in the sleeve as shown in figure 7.

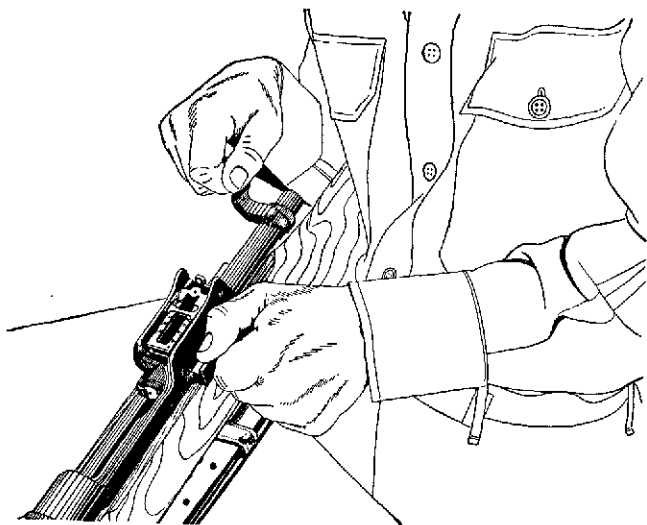
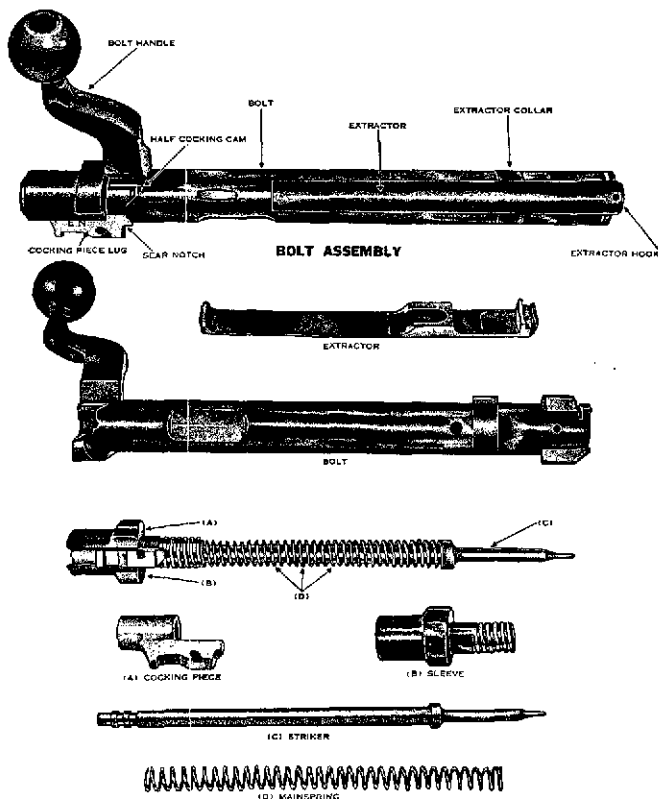

FIGURE 4.—Removing bolt. (Note left thumb on bolt stop.)

Then with the right hand, rotate the cocking piece a quarter turn in either direction to disengage it from the striker and draw it off to the rear. Relieve the spring from the stress slowly and remove it and the sleeve from the striker, being careful that the parts do not fly from the hand. Turn the extractor to the right so that it covers the gas-escape holes in the bolt. Place the right thumb about midway between the extractor collar and the lower end of the extractor and push downward and forward to force the extractor off the bolt (fig. 8).

■ 7. ASSEMBLY.—*a. To assemble and replace bolt assembly.*—(1) Turn the extractor collar until its lug is on line with the

gas-escape holes. Insert the lug on the collar in the undercuts in the extractor by pushing the extractor to the rear until its tongue comes in contact with the face of the bolt;



**FIGURE 5.**—Bolt assembly and parts, U. S. rifle, caliber .30, M1917. press the hook of the extractor against some rigid object until the tongue will slide over the end of the bolt. Turn the extractor so that it lies over the unslotted or solid locking lug (fig. 5).

(2) Slide the mainspring over the striker. Hold the point of the striker against a hard surface; place the sleeve against

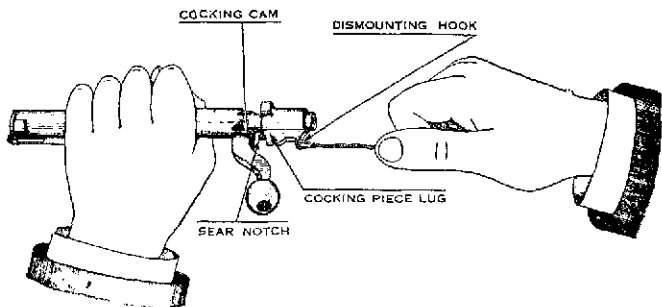

FIGURE 6.—Withdrawing cocking piece.

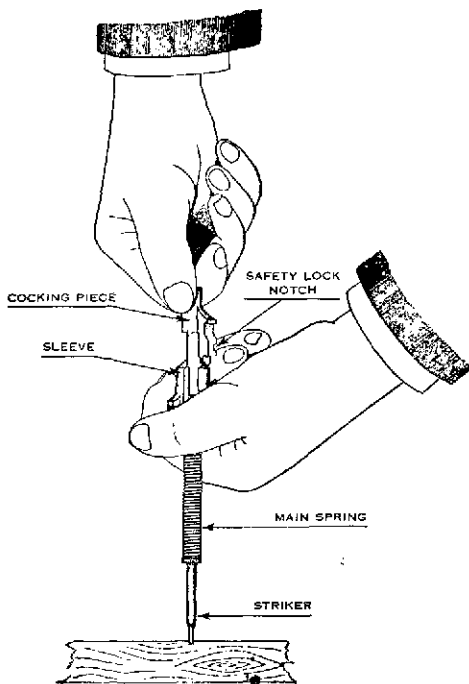

FIGURE 7.—Compressing mainspring.

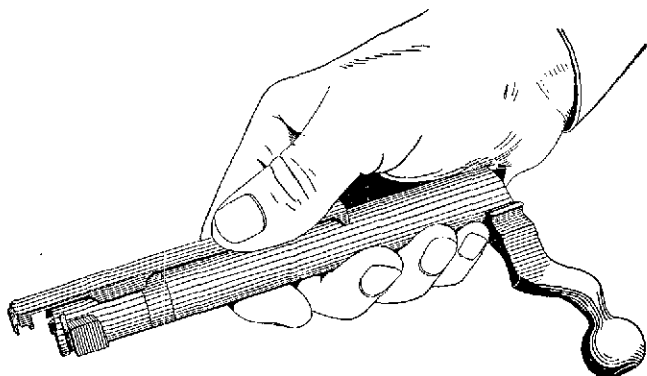

FIGURE 8.—Removing extractor.

the end of the spring with the flat sides in its bore coincident with the flat sides on the striker; force the sleeve down on the striker, compressing the mainspring. Holding the sleeve with the mainspring fully compressed, replace the cocking piece on the end of the striker and lock it by a quarter turn so that its lug is aligned with the lug slot in the sleeve. Then let the sleeve return to its position slowly under the action of the spring. Grasp the bolt in the left hand and start the threads on the barrel of the sleeve into the threads in the end of the bolt (fig. 7). Hook the loop of string on the dismantling hook and, holding the ends of the string in the right hand, pull the cocking piece out and screw the sleeve home in the bolt by turning it clockwise.

**NOTE.**—It is possible to assemble the cocking piece improperly by placing the lugs on the striker in the incorrect lug slot of the cocking piece. This improper assembly allows the striker to protrude through the face of the bolt when the bolt handle is raised to unload the rifle. To avoid injury when firing the rifle, the following precaution should be taken: when assembling the cocking piece, make certain that both lugs on the striker are engaged with the lug slot in the cocking piece. If correctly assembled, the rear end of the striker will be flush with the rear end of the cocking piece.

(3) Hold the rifle under the floor plate in the fingers of the left hand, the thumb extending over the left side of the receiver. Take the bolt in the right hand with the cocking piece lug down; press the rear end of the follower down with the left thumb; push the bolt into the receiver and lower the bolt handle.

b. *To replace floor plate.*—To assemble and replace floor plate, proceed in reverse order to that prescribed in paragraph 6a.

### SECTION III

#### CARE AND CLEANING

■ 8. **IMPORTANCE.**—Care and cleaning of the rifle is an important duty to be performed by all soldiers armed with this weapon and merits the serious consideration of all officers. Experience has shown that the majority of the rifles that become unserviceable do so through lack of intelligent care and not from firing.

■ 9. **LUBRICANTS, CLEANING MATERIALS, AND RUST PREVENTATIVES.**—The use of unauthorized cleaning materials, such as abrasives, is prohibited. The following are the only materials authorized for use in cleaning, lubricating, and preserving the rifle:

Soap.

Water.

Cleaner, rifle-bore.

Oil, lubricating, preservative, light.

Oil, lubricating, preservative, medium.

Oil, lubricating, preservative, special.

Compound, rust-preventive, light.

Solvent, dry-cleaning.

Oil, linseed, raw.

Oil, neat's-foot.

Standard decontaminating agents.

a. *Rifle-bore cleaner.*—(1) Rifle-bore cleaner is issued for cleaning the bore of the rifle after firing. This material possesses rust-preventive properties and will provide temporary protection against rust. It may be used for this purpose in an emergency when preservative oils are not avail-

able. It is desirable, however, to dry the bore immediately after using rifle-bore cleaner and to apply a thin coat of light preservative lubricating oil to the metal.

(2) Rifle-bore cleaner will freeze at temperatures below 32° F. If frozen, it must be thawed and shaken well before using. Closed containers should not be more than three-fourths full in freezing weather because full containers will burst if the contents freeze.

*b. Light preservative lubricating oil.*—This oil has rust-preventive as well as lubricating properties but cannot be depended upon to provide protection from rust for long periods. It is used for lubricating all moving parts and affords short-term protection against rust for all metal parts of the rifle. Its preservative action results partly from the oily film on the metal parts and partly from chemical combination of inhibitors in the oil with the metal. It will therefore protect the metal surfaces from rust even though no appreciable film of oil is present on the metal parts. When used on moving parts, however, it is necessary to maintain a thin film of oil to provide the necessary lubrication.

*c. Medium preservative lubricating oil.*—This oil is superior to light preservative lubricating oil, for small arms exposed to salt water atmospheres. It is heavier and possesses better preservative characteristics for such conditions. It contains rust inhibitors and forms a relatively heavy film which resists the direct washing action of spray. These characteristics make it useful for coating all parts of the weapons prior to landing operations and it should be used in preference to light preservative lubricating oil under such conditions. Use medium preservative lubricating oil only where the rifle is to be exposed to the conditions described in this paragraph. Under other conditions, use the lubricant prescribed in *b* above.

*d. Special preservative lubricating oil.*—This is a thin oil chosen for lubricating at low temperatures and providing temporary protection against corrosion. Special preservative lubricating oil should always be used for preserving the bore between times when the rifle is fired. It is applied after the barrel has been cleaned. Frequent inspections should



be made to assure maintenance of an adequate protective film of oil.

*e. Light rust-preventive compound.*—This compound is issued for protecting metal parts for long periods of time while rifles are boxed and in storage. It should be warmed before application. However, when heating facilities are not available, it can be effectively brushed onto the parts provided the temperature is above 80° F. Below 80° F., light rust-preventive compound becomes sluggish, and its use without preheating is uneconomical.

*f. Dry-cleaning solvent.*—This is a noncorrosive petroleum solvent used for removing grease, oil, or light rust-preventive compound from rifles. Dry-cleaning solvent is highly inflammable and should not be used near an open flame. *Smoking is prohibited where it is employed.* It is generally applied with rag swabs to large parts and used as a bath for small parts. The surfaces must immediately be dried thoroughly with clean rags. To avoid leaving finger marks, which are ordinarily acid and induce corrosion, gloves should be worn by persons handling parts after cleaning. Dry-cleaning solvent will attack and discolor rubber.

*g. Raw linseed oil.*—This oil is used to prevent drying and to preserve the stock and hand guards.

*h. Neat's-foot oil.*—This is a pale yellow animal oil. It is used for preserving leather equipment such as gun slings.

■ 10. CARE AND CLEANING WHEN NO FIRING IS DONE.—*a.* This includes the care of the rifle necessary to preserve its condition and appearance during the periods when no firing is being done. Rifles in the hands of troops should be inspected daily to insure proper condition and cleanliness. Training schedules should allow proper time for cleaning rifles on each day when rifles are used in training.

*b.* The bore of the rifle should be cleaned with the cleaning rod. The use of the thong and brush will be confined to occasions when the cleaning rod is not available. To avoid possible damage to the rifling at the muzzle, Enfield rifles will be cleaned from the breech, the bolt being removed for this purpose. To clean the bore, assemble a cloth patch to the cleaning rod and insert the rod into the bore at the breech

end. Move the cleaning rod and patch forward and backward several times through the bore and replace with a clean patch. Be sure the patch goes all the way through the bore before the direction is reversed. This will prevent the patch and rod from getting stuck in the bore. Repeat until the patch comes out clean. This cleaning removes accumulations of dust, dirt, and thickened oil in the bore. After the bore has been thoroughly cleaned, saturate a patch with light preservative lubricating oil and push it through the bore to apply a light film of oil. When issue patches are not available, patches should be cut approximately 2½ inches square to permit passage through bore without bending cleaning rod.

c. To clean screw heads and crevices, use a small cleaning brush or small stick. To clean metal parts of rifle, rub with a dry cloth to remove moisture, perspiration, and dirt, then wipe with a cloth dampened with a small quantity of light preservative lubricating oil. The protective film of oil will be maintained at all times. To clean stock and hand guard of rifle, wipe off dirt with a clean cloth and oil with raw linseed oil.

d. After cleaning and protecting the rifle as described above, place it in the rack without covering and without a plug in the muzzle end of the bore. Muzzle covers, gun covers, rack covers, and plugs must not be used since they cause sweating and promote rust. However, when barracks are being swept, racks may be covered to protect the rifles from dust. Covers must be removed immediately after the rooms have been swept.

■ 11. PREPARATORY TO FIRING.—Before firing, take the following steps to insure efficient functioning of the rifle:

a. Disassemble the rifle (par. 6).

b. Clean the bore and chamber. *Do not oil the chamber.*

c. Clean all metal parts and apply a light coat of oil to the parts which do *not* come in contact with the ammunition. Use light preservative lubricating oil. *Do not use grease.* Be sure to apply a thin coat of oil to all cams, working surfaces, and the bolt mechanism.

■ 12. AFTER FIRING.—The bore and chamber of the rifle must be cleaned thoroughly not later than the evening of the day on which it is fired—preferably immediately after cessation of firing. In no circumstance will metal fouling solution be used.

*a. Cleaning procedure after firing.*—Hold rifle with muzzle down. Run several patches saturated with rifle-bore cleaner entirely through bore. If rifle-bore cleaner is not available, water may be used. Plain warm water is good, but hot soapy water is better. The hotter the water, the more efficient will be the cleaning. (If hot water in a container is available, muzzle can be inserted directly into vessel containing the water. The water can be pumped in and out of the bore as the cleaning rod is moved back and forth.) Remove slotted tip from cleaning rod and substitute cleaning brush; run cleaning rod with cleaning brush assembled back and forth through bore several times. Care should be used to insure that brush goes all the way through bore before the direction is reversed. Remove brush and replace with slotted tip and patch. Again run several patches saturated with cleaner or with water through the bore, removing them from muzzle end. Follow this by dry patches until they come out clean and dry. Then examine bore carefully for cleanliness. If it is not free of all residue, repeat cleaning process; if it is clean, saturate a patch in light preservative lubricating oil and push it through the bore so that a light film of oil will be deposited on the bore.

*b. Complete cleaning.*—Complete cleaning should be accomplished as soon as possible after the cleaning described in *a* above. If the rifle is to be fired the next day, proceed as in paragraph 11. If the rifle is not to be fired in the next few days, repeat the procedure outlined in *a* above, for 3 days. In addition, the following instructions will be observed:

(1) *Chamber.*—Deposits of primer salts attract water and thereby cause rusting. They can be removed only by using rifle-bore cleaner or water. Saturate a cleaning patch with rifle-bore cleaner or with water and assemble to a small stick. Clean by twisting the patch-covered stick in the chamber. Dry the chamber, using successive dry patches on a stick as described above. Inspect the chamber first visually and then

by inserting and twisting the little finger. If no discoloration shows on the finger, oil the chamber lightly with light preservative lubricating oil. This oil should be removed with a dry patch before firing.

(2) Wipe off the exterior of the rifle with a dry cloth to remove dampness, dirt, and perspiration. Wipe all metal surfaces with light preservative lubricating oil. Oil the stock and hand guards with raw linseed oil, and oil the sling with neat's-foot oil.

(3) The face of the bolt should first be cleaned with a wet patch. It should then be dried and given a coat of light preservative lubricating oil.

■ 13. ON RANGE, DURING FIELD FIRING OR MILITARY OPERATIONS.—The rifle must be kept clean, free from dirt, and properly lubricated. To obtain its maximum efficiency, the following points must be observed:

*a. Clean bore.*—Never fire a rifle with any dust, dirt, mud, or snow in the bore.

*b. Clean chamber.*—Keep the chamber free from oil and dirt.

*c. Obstructions.*—Never leave a patch, plug, or other obstruction in the chamber or bore. Such articles collect moisture and are also a hazard if the rifle is fired [see pars. 10*d* and 169*b* (15)].

*d. Excessive friction.*—Keep a thin coat of light preservative lubricating oil on all metal parts. If the rifleman notes signs of excessive friction due to lack of lubrication, he should apply additional oil to the cams and working surfaces. Friction is indicated if the bolt becomes difficult to operate.

*e. Emergency cleaning.*—In emergencies when the prescribed lubricants are not available, any clean light mineral oil, such as engine oil, may be used. For cleaning the bore and chamber, clean water may be used in place of rifle-bore cleaner.

*f. Range firing.*—During range firing, a qualified man should supervise the cleaning of rifles at the cleaning racks or tables.

*g. Oiler and thong case.*—The oiler should be kept filled with light preservative lubricating oil. When the cleaning

rod is not available, the contents of the oiler and thong case carried in the butt may be used to clean the rifle. In cleaning the bore with the thong, the brush or rag should be drawn from the breech toward the muzzle. The oiler should always be inserted into the stock with the leather-tipped cap next to the butt plate cap. This eliminates noise when the rifle is carried.

■ 14. PREPARATION FOR STORAGE.—*a.* Light preservative lubricating oil is the most suitable oil for short-term protection of the rifle mechanism. It is effective for storage over periods of two to six weeks, depending on climatic conditions. However, rifles in short-term storage must be inspected every 4 or 5 days and the preservative film renewed if necessary. For longer periods of time, rifles will be protected with light rust-preventive compound.

*b.* Light rust-preventive compound is a semisolid material. It is efficient for preserving the surfaces, the bore, and the chamber for a period of approximately 1 year, depending on climatic and storage conditions.

*c.* The rifles should be cleaned and prepared for storage with particular care. The bore, all parts of the mechanism, and the exterior of the rifles should be thoroughly cleaned and then dried completely with rags. In damp climates, particular care must be taken to see that the rags are dry. After drying a metal part, the bare hands should not touch that part. All metal parts should then be coated with either light preservative lubricating oil or light rust-preventive compound, depending on the length of storage required (*a* and *b* above). Application of the rust-preventive compound to the bore of the rifle is best done by dipping the cleaning brush into the compound and then running it through the bore two or three times. The brush must be clean before it is used. Before placing the rifle in the packing chest, see that the bolt is in its forward position and that the striker is released. Then, handling the rifle by the stock and hand guards only, it should be placed in the packing chest, the wooden supports for the butt and muzzle having been painted previously with rust-preventive compound. *In no circumstance will a rifle contained in a cloth or other cover or with*

*a plug in the bore be placed in storage.* Such articles collect moisture, which causes the weapon to rust.

■ 15. **CLEANING OF WEAPONS AS RECEIVED FROM STORAGE.**—Weapons which have been stored in accordance with paragraph 14 will be coated with either light preservative lubricating oil or with light rust-preventive compound. Weapons received from ordnance storage will usually be coated with rust-preventive compound. Use dry-cleaning solvent to remove all traces of the compound or oil. Take particular care that all recesses in which springs or plungers operate are cleaned thoroughly—especially those of the bolt. After using the cleaning solvent, be sure it is completely removed from all parts by wiping with a dry cloth. Then follow the instructions in paragraph 10.

■ 16. **CARE WHEN SUBJECT TO GAS ATTACK.**—*a. General.*—(1) It is important to prevent chemicals used in a gas attack from coming into contact with the rifle, ammunition, and accessories. When a gas attack is anticipated, the following action will be taken: apply oil to all outer metal surfaces of the rifle and accessories. If the rifle is not to be used, cover rifle, accessories, and ammunition. Do not apply oil to ammunition.

(2) After the attack, determine by means of detector crayon or paper whether or not the matériel is contaminated. If uncontaminated, clean matériel with dry-cleaning solvent. Prepare for use as required in paragraph 10 or 11.

*b. Decontamination.*—If contaminated, the following action will be taken:

(1) A suit of permeable or impermeable clothing and a service gas mask must be worn for decontamination.

(2) Matériel contaminated with chemicals other than mustard or lewisite must be cleaned as soon as possible with dry-cleaning solvent or denatured alcohol.

(3) Do not allow the chemical agents to come into contact with the skin. Burn or bury all rags or wiping materials used for decontamination. *Extreme caution should be taken to protect men against fumes created by burning.*

(4) If the surface of the matériel is coated with grease or oil and has been in a mustard or lewisite attack, remove the

grease or oil by wiping with rags wet with dry-cleaning solvent.

(5) Decontaminate the rifle with a solution of noncorrosive decontaminating agent. Prepare this by mixing one part of noncorrosive decontaminating agent with fifteen parts of solvent (acetylene tetrachloride) by weight, or by mixing one part of noncorrosive decontaminating agent with six parts of solvent by volume.

(6) After decontaminating, clean the matériel thoroughly and prepare for use as required in paragraph 10 or 11.

c. *References.*—Detailed information on decontamination is contained in FM 21-40, TM 9-850 and 3-220.

■ 17. CARE AND CLEANING UNDER UNUSUAL CLIMATIC CONDITIONS.—*a. In cold climates.*—(1) In temperatures below freezing, it is necessary that the moving parts of the weapon be kept absolutely free from moisture. It has also been found that excess oil on the working parts will solidify to such an extent as to cause malfunctioning or complete failure.

(2) The bolt should be taken apart and completely cleaned with dry-cleaning solvent before use in temperatures below 0° F. The working surfaces of parts which show signs of wear may be lubricated by rubbing with a cloth which has been wet with special preservative lubricating oil; other parts are left dry. At temperatures above 0° F. all metal surfaces of the weapon may be oiled lightly after cleaning by wiping with a slightly oiled cloth, using light preservative lubricating oil.

(3) When brought indoors, the weapon should first be allowed to come to room temperature. It should then be disassembled, wiped completely dry of the moisture which will have condensed on the cold metal surfaces, and thoroughly oiled with light preservative lubricating oil. If possible, such condensation should be avoided by providing a cold place in which to keep rifles when not in use. For example, a separate cold room with appropriate racks may be used, or, when in the field, racks under proper cover may be set up outdoors.

(4) If the rifle has been fired, it should be cleaned thor-

oroughly and oiled. The bore should be swabbed out with an oily patch, and when the weapon reaches room temperature, it should be cleaned thoroughly and oiled as prescribed in paragraph 12.

(5) Before firing, the weapon should be cleaned and oil should be removed as prescribed in *a* (2), above. The bore and chamber should be entirely free of oil before firing.

*b. In hot climates.*—(1) *Tropical climates.*—(a) In tropical climates where temperature and humidity are high, or where salt air is present, and during rainy seasons, the weapon should be thoroughly inspected daily. It should be kept lightly oiled when not in use. The parts should be disassembled at regular intervals and inspected. If necessary, parts should be dried and oiled.

(b) Care should be exercised to see that unexposed parts and surfaces are kept clean and oiled.

(c) Light preservative lubricating oil should be used.

(d) A light coat of raw linseed oil applied at intervals and well rubbed in with the heel of the hand will help to keep moisture out and prevent swelling of wood parts. Allow the oil to soak in for a few hours and then wipe and polish the wood with a dry, clean rag. (Care should be taken that linseed oil does not get into the mechanism or in metal parts, because linseed oil thickens when dry.)

(2) *Hot, dry climates.*—(a) In hot, dry climates where sand and dust are likely to get into the mechanism and bore, the rifle should be wiped clean daily, or oftener if necessary. The rifle should be disassembled sufficiently for thorough cleaning.

(b) When the rifle is being used under sandy conditions, all lubricants should be wiped from the weapon. This will prevent sand carried by the wind from sticking to the lubricant and forming an abrasive which will ruin the mechanism. Immediately upon leaving sandy terrain, the rifle must be relubricated with light preservative lubricating oil.

(c) In such climates, wood parts are likely to dry out and shrink. A light application of raw linseed oil, applied as in (1) (d) above, will help to keep the wood in condition.

(d) Perspiration from the hands is a contributing factor to rust because it contains acid. Metal parts should be wiped dry frequently.



(e) During sand or dust storms, the breech and muzzle should be kept covered if possible.

#### SECTION IV

#### FUNCTIONING

■ 18. OPERATION.—*a. To load (fig. 9).*—(1) *To load from clip into magazine.*—To load from a clip into magazine, draw bolt fully to rear; place clip of cartridges in its slot in receiver; with fingers of right hand under rifle against floor plate and ball of thumb on powder space of top cartridge near clip, press cartridges straight down with thumb into magazine with a firm, steady push until top cartridge is caught by right edge of receiver. Remove empty clip with the right hand. When cartridges have been started into magazine, do not remove pressure on top cartridge until process of seating has been completed. If pressure of thumb is removed, expansion of magazine spring may force clip from clip slot

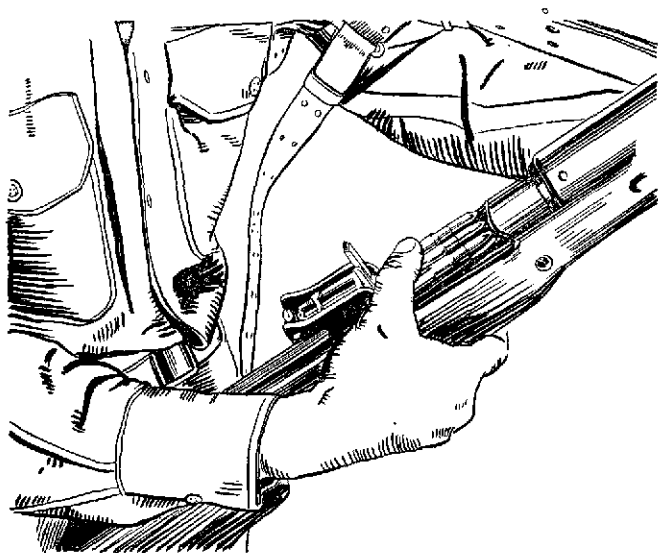

FIGURE 9.—Loading from a full clip.

and cause clip to break when pressure is reapplied. After loading magazine, to feed a round into chamber, close bolt. As bolt is closed, top cartridge in magazine is pushed forward into chamber.

(2) *To load magazine without use of clip.*—The magazine may be loaded without use of clip by merely inserting six cartridges one at a time.

(3) *To load with seven rounds.*—To load with seven rounds, place one round in chamber and six in magazine. Press down on top cartridge in the magazine as bolt is closed in order that bolt will ride over top of round.

(4) *To operate as single loader.*—When rifle is used as a

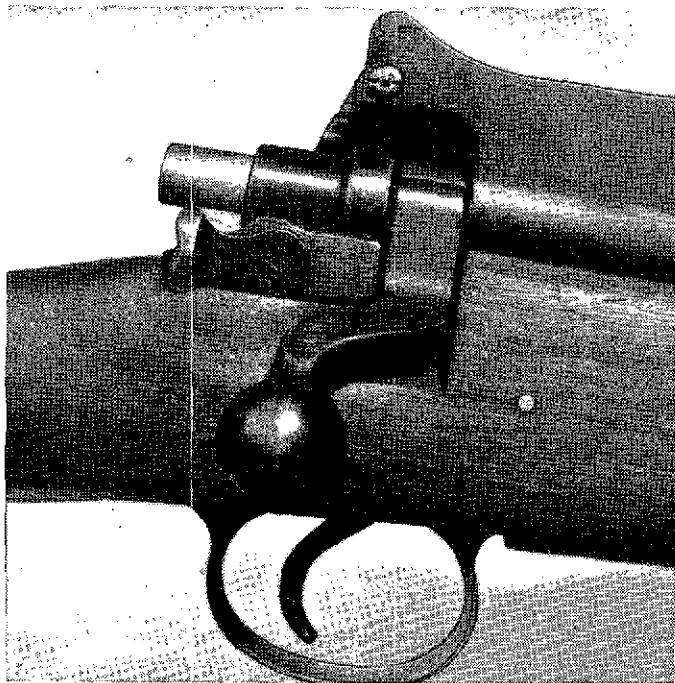

① Safe.

FIGURE 10.—Positions of safety lock.

single loader, cartridges are inserted directly into chamber with the hand.

*b. Extraction.*—Extraction of the empty case from chamber by extractor is begun during the rotation of the bolt and is completed as bolt is drawn to rear.

*c. Ejection.*—When bolt is drawn fully to rear, head of empty cartridge case strikes against ejector point, and case is ejected from receiver.

*d. Follower.*—When cartridges are fed into chamber from magazine and after last cartridge has been fired and bolt has been drawn fully to rear, follower rises and blocks path

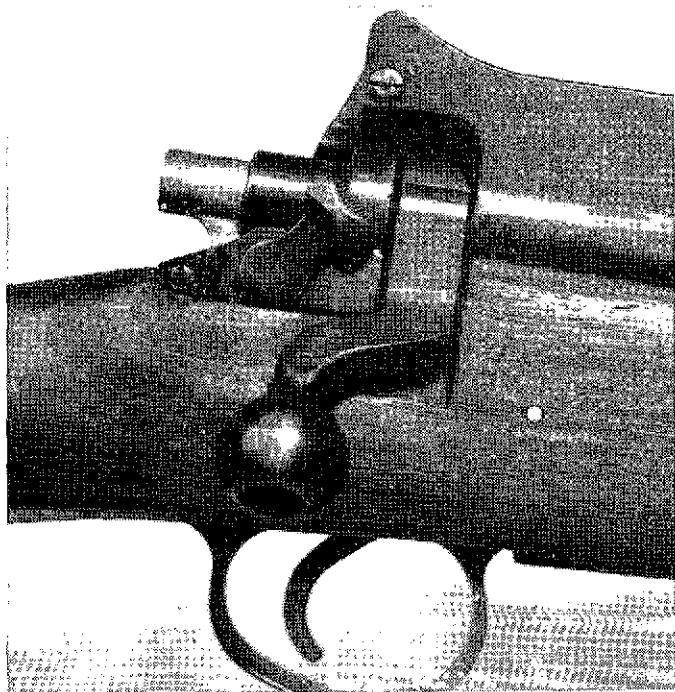

⊙ Fire.

FIGURE 10.—Positions of safety lock—Continued.

of bolt, thus showing magazine is empty. The magazine may be refilled, or bolt may be closed without reloading by forcing follower down until it is below path of bolt.

*e. To unload.*—Move bolt forward and back until no cartridges remain in magazine or chamber.

*f. Safety device* (fig. 10.)—To set at safe, turn the safety lock to the rear as far as it will go. This locks bolt handle in position, and lifts the sear notch off the sear nose. To unlock, turn safety lock to the front.

*g. To clear rifle.*—(1) To clear rifle, open bolt and draw it fully to rear, extracting and ejecting the cartridge from the chamber. Remove the cartridges from the magazine as described in *e* above, and *leave the bolt open*. Inspect the magazine and chamber to insure that they are empty.

(2) In range firing, whenever firing ceases and the command to clear rifles is given, execute clear rifle as prescribed above. (See also par. 169*b* (9).)

*h. Cocking.*—The rifle cannot be cocked except by actuation of the bolt. It is cocked by raising the bolt handle until it strikes the left side of the receiver, pulling the bolt backward until the sear notch engages the sear nose, and then pushing it forward and turning the bolt handle fully down.

*i. Use of dummy cartridges.*—The corrugated dummy cartridge may be used for instruction in functioning and operation. The use of the slotted, range dummy cartridge for this purpose is prohibited. Special care must be exercised in the use of dummy cartridges so that they do not introduce dirt or grit into the chamber.

## SECTION V

### SPARE PARTS, APPENDAGES, AND ACCESSORIES

■ 19. SPARE PARTS.—*a.* The parts of any rifle will in time become unserviceable through breakage or wear resulting from continuous use; hence, spare parts are supplied. These are extra parts provided with the rifle for replacement of the parts most likely to fail. They should be kept clean and lightly oiled to prevent rust. Sets of spare parts should be kept complete at all times. Whenever a spare part is used to replace a defective part in the rifle, the defective part

should be repaired or a new part should be substituted in the spare parts set as soon as possible. Parts that are carried complete should at all times be correctly assembled and ready for immediate insertion in the rifle. The allowance of spare parts is prescribed in SNL B-4.

b. The breaking off of the integral spring on the ejector results in the ejector becoming unserviceable. The ejector body can be reused if it has not been mutilated to such an extent as to render it inoperative in its normal functioning under spring pressure. The proper method of reassembling the ejector with a new spring is as follows:

(1) Use side cutting pliers and snap off the remaining portion of the spring as close to the position indicated in figure 11① as possible.

(2) Reassemble bolt stop, bolt stop spring, ejector and ejector spring (new type). The slot in the ejector spring should be rearward, toward bolt stop spring rest as indicated in figure 11②.

c. Except for replacements with the parts mentioned in a and b above, repairs or alterations to the rifle by using organizations are prohibited.

■ 20. APPENDAGES.—Appendages for the rifle are the bayonet M1917, bayonet scabbard M1917, and grenade launcher.

a. *Bayonet*.—The bayonet is a blade sharpened along the entire lower edge. The bayonet guard is constructed so as to fasten the bayonet securely to the rifle or its scabbard. Grips on both sides of the tang provide a handle when the bayonet is used as a hand weapon.

b. *Bayonet scabbard*.—The scabbard, shaped to receive the bayonet, consists of a leather body with a leather reinforcement at its tip which contains a drain hole. The scabbard is held to the belt of the soldier by two hooks.

c. *Grenade launcher*.—(1) *Firing antitank grenades, anti-personnel grenades, and ground signals*.—Antitank and anti-personnel grenades, and also ground signals, can be fired from the rifle with the aid of a launcher which the soldier attaches to the muzzle of his rifle. A special cartridge, AT grenade, caliber .30, M3, which is issued with the grenade, is used.

(2) *Firing service ammunition with the launcher at-*

*tached.*—Service ammunition may be fired with the grenade launcher attached, but it should be noted that a shift in the zero of the rifle can be expected (see par. 53b (3)). To fire

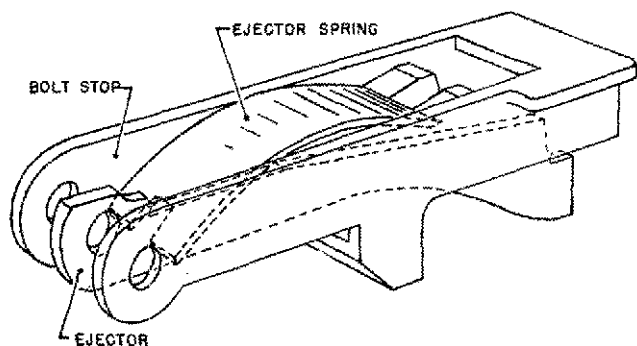
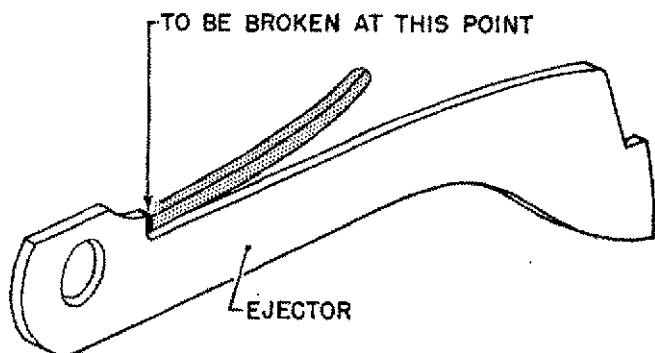

service ammunition with the launcher attached, proceed as follows:

- (a) Make certain that a grenade is *not* in place on the launcher. *Never in any circumstance use service ammunition when a grenade is in place on the grenade launcher.*
- (b) Load and fire the rifle in the normal manner.

(3) *Technique of firing and safety precautions.*—For information concerning attachment of launcher, technique of firing, and safety precautions to be taken, see FM 23-30.

■ 21. ACCESSORIES.—*a. General.*—Accessories include the tools required for assembling, disassembling, and cleaning the rifle, the gun sling, spare parts containers, covers, arm locker, and similar items. Accessories should not be used for purposes other than those for which they are intended, and, when not in use, they should be stored in the places or receptacles provided for them. The names or general characteristics of several accessories indicate their uses or application. Detailed descriptions or methods for the use of such items are not outlined herein. However, accessories of a special nature or those which have special uses are described in *b* to *h* below.

*b. Arm locker and rack.*—The arm locker and the arm rack are used to store or stack rifles and pistols to prevent mishandling or pilfering.

*c. Brush and thong.*—The brush and thong are used for cleaning the bore of the rifle (see par. 13*g*). The oiler and thong case is partitioned so that one end contains the oil and oil dropper and the other holds the tip, weight, thong, and brush.

*d. Cleaning rod M1 and cleaning brush M2.*—The cleaning rod has a handle at one end and is threaded at the other end to receive the patch or brush sections. The patch section is slotted to permit the insertion of a cleaning patch; the brush section is used to clean the bore of the rifle after firing (see par. 12*a*).

*e. Gun slings.*—(1) Methods for attaching the three types of gun slings are indicated below:

(*a*) *Gun sling M1907 (leather)* (fig. 12①).

1. Place rifle on a flat surface, sights down and muzzle pointing right.
2. Place short strap on a flat surface, hook on left and loop (D-ring) on right, smooth side of leather down.
3. Place long strap on flat surface, hook on left, feed end on right, and smooth side of leather down.

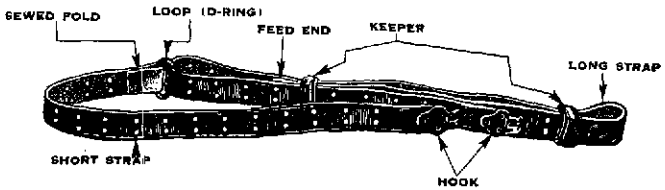

① M1907—Leather.

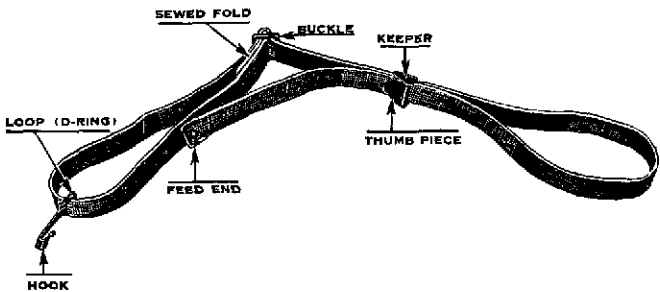

② M1—Improved web.

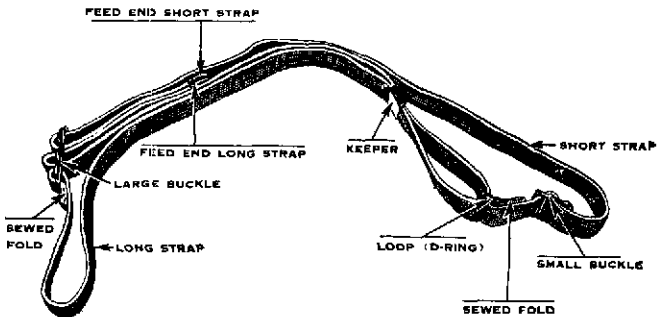

③ M1923—Web.

FIGURE 12.—Gun slings.



4. Clench sewed fold of short strap in left fist. With right hand, pick up hook of long strap and work loop (D-ring) down over hook of long strap.
5. Take one of keepers in left hand, sewed side up, and thrust it over hook of long strap.
6. With right hand, pick up feed end of long strap. Push feed end through keeper and pull entire length of long strap through.
7. Place long strap on table with smooth surface of leather down. Pick up second keeper in right hand, sewed side down. Insert feed end of long strap through keeper.
8. Pick up feed end of long strap (smooth side of leather down) in left hand. Raise lower band swivel with right hand. Insert feed end through lower band swivel and pull strap through in direction of muzzle.
9. Pick up feed end of long strap in right hand. Take hold of second keeper in left hand. Insert feed end through keeper and pull strap in direction of butt.
10. Pick up hook of long strap with left hand. Beginning with pair of holes nearest feed end of long strap, count off nine pairs of holes. Insert prongs of hook. (A sling which has been in use for some time may have stretched, in which case the ninth pair of holes will not always give correct adjustment.)
11. Pick up hook of short strap in right hand. Insert hook through butt swivel. Take hook in left hand and pull short strap through swivel.
12. Take hook of short strap in left hand. Locate pair of holes nearest hook of long strap. Insert prongs of hook.
13. To tighten sling, grasp inside strap with right hand and force it firmly toward butt of rifle, at the same time with left hand forcing outside strap toward muzzle. To hold sling in taut position, force upper keeper against lower band swivel

and slide lower keeper toward muzzle until feed end of long strap has been passed.

(b) *Gun sling M1 (improved web)* (fig. 12②).

1. Place rifle on a flat surface, sights down and muzzle pointing to left.
2. Snap hook into butt swivel with hook opening out.
3. Pick up strap, holding buckle end in left hand with sewed fold down. With right hand insert feed end of strap down through loop (D-ring) on hook and pull feed end toward muzzle of rifle.
4. Holding buckle in left hand, insert feed end of sling through buckle slot nearest sewed fold. Work buckle toward butt until it is 6 or 7 inches from butt swivel. Insert feed end of sling through remaining slot of buckle, which is outermost from sewed fold.
5. With left hand pick up keeper. With right hand retake feed end of sling and insert it through keeper so that thumbpiece of keeper is uppermost and closes toward butt.
6. Insert feed end of sling through lower band swivel and pull it toward muzzle.
7. Take feed end of sling in left hand and insert it through keeper. Work keeper and feed end of sling in direction of butt and as close to buckle as possible. Tighten sling by pulling on feed end. Close the keeper.

(c) *Gun sling M1923 (web)* (fig. 12③).

1. Place rifle on a flat surface, sights down and muzzle pointing left.
2. Turn butt swivel and lower band swivel toward butt.
3. Pick up long strap, holding buckle end in right hand with sewed fold uppermost. With left hand insert feed end of strap down through lower band swivel and pull feed end toward butt of rifle.
4. Pick up short strap, holding loop (D-ring) in left hand with sewed fold down. With right hand, insert feed end of short strap down through butt swivel and pull feed end toward butt.

5. With right hand, pick up keeper. With left hand, retake feed end of long strap and insert it through keeper so that thumbpiece of keeper is uppermost and closes toward muzzle of rifle.
6. With left hand, pick up small buckle, holding it so that cross bars are uppermost and thumbpiece is toward butt of rifle. Taking feed end of short strap in right hand, bring end up through small buckle at slot nearest thumbpiece and back down through slot farthest from thumbpiece, allowing about 8 inches of strap to come through buckle.
7. Regrasp feed end of long strap with left hand and bring it up through loop (D-ring) on lower end of short strap. Fold long strap back over top of loop (D-ring) and insert end through keeper.
8. Still holding feed end of long strap, bring it up through slot of large buckle nearest sewed fold of long strap and continue it back down through second slot from sewed fold, allowing 3 or 4 inches of strap to come through.
9. Again pick up feed end of short strap and bring it up through large buckle at slot nearest thumbpiece and back down through one remaining open slot. Continue end of strap back to small buckle and insert it up through slot farthest from thumbpiece and down through middle slot of small buckle.
10. To tighten sling, grasp inside strap with right hand and force it firmly toward butt of rifle, at same time with left hand forcing outside strap toward muzzle. Close keeper to hold sling in its taut position.
11. When sling is properly adjusted and tightened, large buckle is located at a position just below lower band swivel and just above small buckle. The keeper is well down toward loop (D-ring) of short strap. This leaves sling free of obstruction for a considerable distance above and below trigger guard of rifle, which allows the soldier

the maximum comfort while carrying rifle at the shoulder. The small buckle should be in a position above balance of rifle to prevent interference with left hand while performing the manual of arms.

(2) Methods of adjusting three types of gun slings for sling arms are indicated below:

(a) *Gun sling M1907 (leather)*.—By reversing the procedure prescribed in (1) (a) 13 above, loosen sling until there is sufficient slack to sling rifle comfortably on shoulder.

(b) *Gun sling M1 (improved web)*.

1. With right hand firmly grasping small of stock, brace butt of rifle against right hip, at the same time canting rifle to right so that trigger guard is to left.
2. With left hand, open keeper and loosen sling by sliding keeper and feed end of sling toward muzzle. In this manner loosen sling until there is sufficient slack to sling rifle comfortably on shoulder. Close keeper.

(c) *Gun sling, M1923 (web)*.

1. With right hand firmly grasping small of stock, brace butt of rifle against right hip, at the same time canting rifle to right so that trigger guard is to left.
2. With left hand open keeper.
3. Again with left hand, grasp outside strap of sling and force it toward butt. In this manner loosen sling until there is sufficient slack to sling rifle comfortably on shoulder. Close keeper.

*f. Ruptured cartridge extractor*.—The ruptured cartridge extractor has the general form of a caliber .30 cartridge and consists of three parts—the spindle, the head, and the sleeve. The ruptured cartridge extractor is inserted through the opening of the ruptured case and pushed forward into the chamber. The bolt is closed so that the extractor engages the head of the ruptured cartridge extractor. As the bolt is drawn to the rear, the ruptured cartridge extractor, holding the cartridge on its sleeve, is extracted.

*g. Aiming device, M1923, modified.*—This is an aid to the coach in determining the difficulties experienced by pupils undergoing marksmanship training. Any deviation from the correct sight alinement can be observed immediately by the coach as he looks at the image which appears on the glass in the aiming device. This device serves as a check on those who do not hold the breath properly, and it enables the coach to assist the inexperienced rifleman to obtain the correct sight picture. The device is fitted over the stock of the rifle.

## SECTION VI

### INSTRUMENTS

■ 22. BINOCULARS.—*a. General.*—There are two types of binoculars in use in the service: the M3 or M13 (the M13 is the M3 waterproofed) (fig. 13①) and the type EE (fig. 13②).

The M3 and M13 binocular will eventually replace the type EE. The subparagraphs below apply to both models. Each model consists of the binocular with its carrying case.

*b. Description.*—(1) The binocular consists of two compact prismatic telescopes pivoted about a common hinge which permits adjustment for interpupillary distances. A scale graduated every 2 millimeters from 56 to 74 permits the observer to set the telescopes rapidly to suit his interpupillary distance, provided the spacing of his eyes is known. By screwing the eyepiece in or out, they can be focused independently for each eye. Each eyepiece is provided with a diopter scale for rapid setting when the observer knows the correction for his eye. The zero graduations indicate the settings for normal eyes.

(2) The left telescope is fitted with a glass reticle (fig. 14) upon which are etched a vertical mil scale, a horizontal mil scale, and a stadia graduated similarly to the sight leaf graduation on the rifle M1917, but inverted.

*c. Use.*—The binocular is used for observations and the measurement of small horizontal and vertical angles in mils. The vertical stadia scale is used to pick up auxiliary aiming

points in direct laying and to determine troop safety for overhead fire.

*d. Preliminary adjustments.*—(1) *Interpupillary distances.*—To adjust the binocular so that the eyepieces are the same distance apart as the pupils of the eyes, point it at the

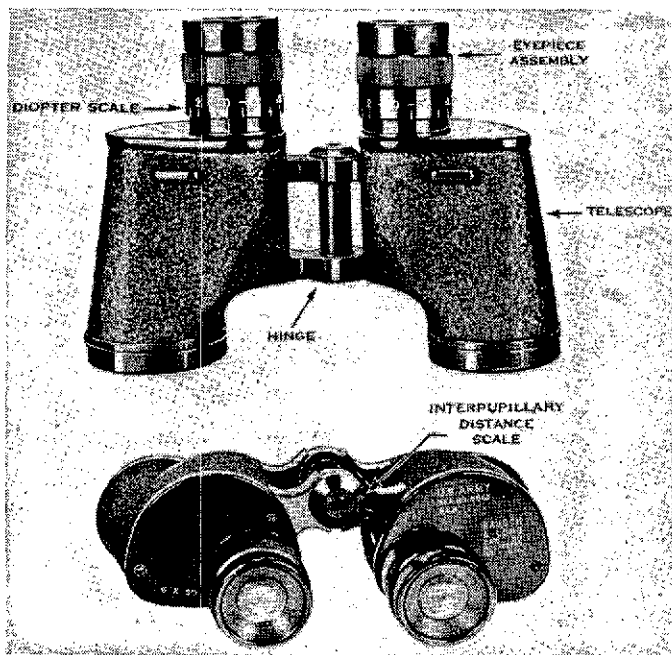

① Binocular M3 or M13.

FIGURE 13.—Binoculars.

sky and open or close the hinged joint until the field of view ceases to be two overlapping circles and appears as one sharply defined circle. Note the reading on the scale which indicates the spacing of the eyes.

(2) *Focus of eyepiece.*—Screw the eyepieces all the way out. With both eyes open, look through the binocular at an object

several hundred yards away. Place the hand over the front of one telescope and screw the eyepiece of the other in until the object is sharply defined. Repeat this operation for the other eye and note the diopter scale.

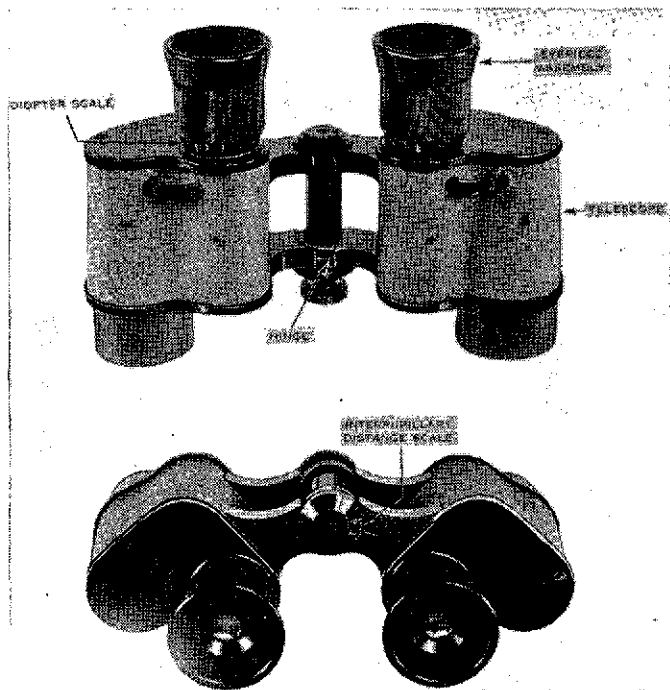

© Type EE.

FIGURE 13.—Binoculars—Continued.

*e. Operation.*—(1) In using the binocular, it should be held in both hands and pressed snugly to the eyes so as to keep the relation with the eyes constant without transmitting tremors from the body. The bent thumbs should fit into the outer edges of the eye sockets in such a manner as to prevent

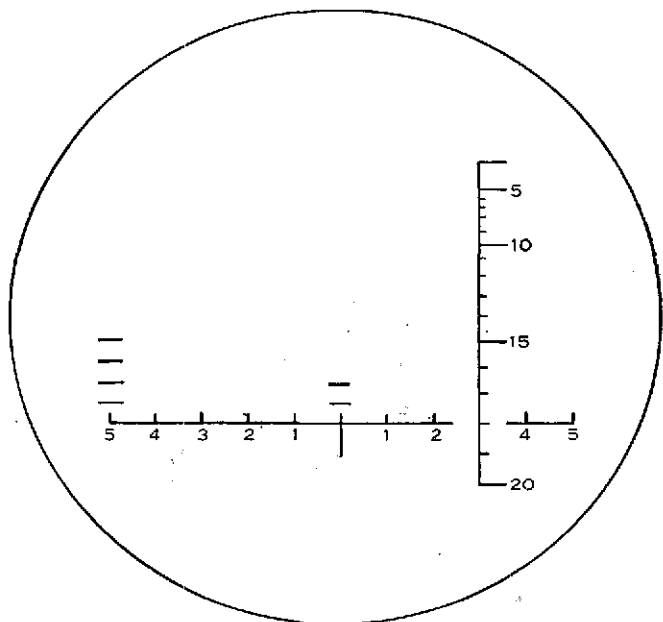

① Binoculars M3 or M13.

FIGURE 14.—Reticle patterns.

light from entering in rear of the eyepieces. When possible, it is best to use a rest for the binocular or for the elbows.

(2) The horizontal and vertical angles between objects may be read by superimposing the mil scale upon these objects when looking through the binocular.

*f. Care.*—The binocular is a rugged, serviceable instrument, but it should not be abused or roughly handled. The lenses should be wiped only with clean soft tissue paper and never with any substitute or with the fingers. The use of polishing liquids or pastes for polishing lenses is forbidden.



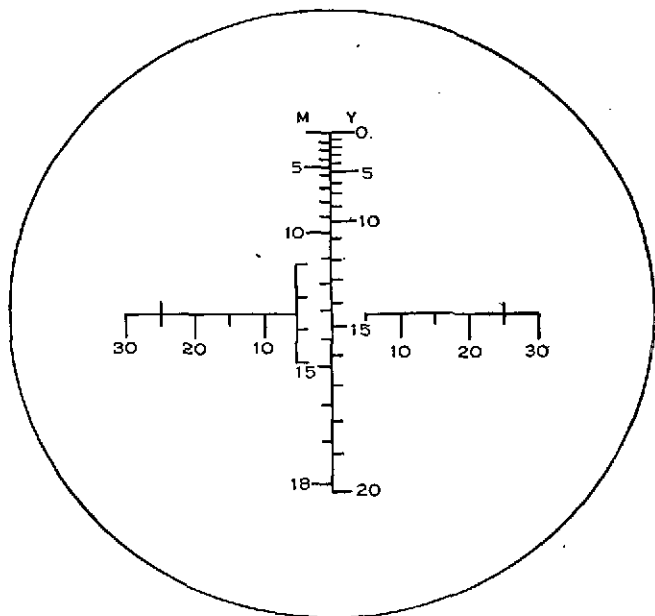

② Binocular type EE.

FIGURE 14.—Reticle patterns—Continued.

## SECTION VII

### AMMUNITION

■ 23. GENERAL.—The information in this section pertaining to the several types of cartridges authorized for use in the U. S. rifle, caliber .30, M1917, includes description, means of identification, care, use, and ballistic data.

■ 24. CLASSIFICATION.—*a.* (1) Based upon use, the principal classifications of the several types of ammunition (fig. 15) used with this rifle are—

(*a*) *Ball*—for use in marksmanship training and against personnel.

(*b*) *Tracer*—for observation of fire and incendiary purposes.

(c) *Incendiary*—for incendiary purposes.

(d) *Armor-piercing*—for use in marksmanship training and against armored vehicles, concrete shelters, similar bullet-resisting targets; and personnel.

(e) *Cartridge, AT grenade, M3*—for use in firing the anti-tank grenade against armored targets; for use in firing the antitank practice grenade; for use in firing the impact fragmentation (antipersonnel) grenade M17; and for use in firing the Mk. II antipersonnel grenade with the grenade projection-adaptor, M1 (see par. 20c).

(2) Other types of ammunition provided for special purposes are—

(a) *Guard*—for guard purposes (gallery practice cartridge also used for this purpose).

(b) *Blank*—for simulated fire, signaling, and salute.

(c) *Dummy*—for training and range practice.

b. The following three types of ammunition are similar to ball ammunition in outward appearance, except as indicated below.

(1) *Armor-piercing* is painted black for  $\frac{1}{4}$  inch from the point.

(2) *Tracer* is painted red for  $\frac{1}{4}$  inch from the point.

(3) *Incendiary* is painted light blue for  $\frac{1}{4}$  inch from the point.

■ 25. **LOT NUMBER.**—When ammunition is manufactured, an ammunition lot number is assigned which becomes an essential part of its marking in conformity with ordnance specifications. This lot number is marked on all packing containers and on the identification card inclosed in each packing box. The lot number is required for all purposes of record, including grading and use, reports on condition, functioning, and accidents in which the ammunition might be involved. Only those lots or grades appropriate for the weapon will be fired. Since it is impracticable to mark the ammunition lot number on each individual cartridge, every effort should be made to keep the ammunition lot number with the cartridges once the cartridges are removed from their original packing. During marksmanship and combat training, cartridges which have been removed from the original packing and for which the ammunition lot number

INCENDIARY—LIGHT BLUE  
 ARMOR PIERCING—BLACK  
 TRACER—RED



INCENDIARY, ARMOR PIERCING,  
 AND TRACER



BALL



GUARD

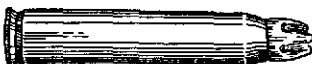

CARTRIDGE, AT GRENADE, M3

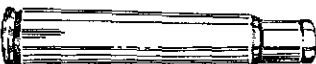

BLANK, M1909



DUMMY (Corrugated) M1906



DUMMY, RANGE, M1 (Slotted)

FIGURE 15.—Cartridges, caliber .30.

has been lost are placed in grade 3. It is therefore obvious that when cartridges are removed from their original packings they should be so marked that their ammunition lot number is retained.

■ 26. GRADE.—Current grades of all existing lots of small-arms ammunition are established by the Chief of Ordnance and are published in Ordnance Field Service Bulletin No. 3-5. No lot other than that appropriate to the weapon will be fired. Color bands are painted on the sides and ends of the packing boxes to identify the various types of ammunition. The following color bands are used:

Armor-piercing.....	Blue on yellow.
Ball.....	Red.
Blank.....	Blue.
Dummy.....	Green.
Gallery practice.....	Brown.
Guard.....	Orange.
Tracer.....	Green on yellow.
Incendiary.....	Red on yellow.
Cartridge, AT grenade, M3.....	Two blue.

■ 27. CARE, HANDLING, AND PRESERVATION.—*a.* Small-arms ammunition is not dangerous to handle. Care, however, must be observed to keep the boxes from becoming broken or damaged. All broken boxes must be immediately repaired, and care should be taken that all markings are transferred to the new parts of the box. The metal liner should be air tested and sealed if equipment for such work is available.

*b.* Ammunition boxes should not be opened until the ammunition is required for use. Ammunition removed from the airtight container, particularly in damp climates, is apt to corrode and thereby become unserviceable.

*c.* The ammunition should be protected from mud, sand, dirt, water, and chemical agents. If the ammunition gets wet or dirty, wipe it off at once. If light corrosion forms on cartridges, it should be wiped off. However, cartridges should neither be polished nor oiled to make them look brighter.

*d.* During marksmanship and combat training, no caliber .30 ammunition will be fired until it has been positively identified by ammunition lot number and grade.

e. Small-arms ammunition of all classes should never be stored near radiators, hot water pipes, and other sources of heat, since heat not only deteriorates ammunition but also creates a fire hazard.

■ 28. BALLISTIC DATA.—The approximate maximum ranges and average velocities for the several types and models of caliber .30 ammunition are shown below:

Type and model of caliber .30 cartridge	Average velocity 78 feet from muzzle (feet per second)	Approximate maximum range (yards)
Ball, M2.....	2,800	3,500
Ball, M1.....	2,600	5,500
Ball, M1906.....	2,640	3,450
Tracer, M1.....	2,700	3,500
Armor-piercing, M2.....	2,800	3,500
Guard.....	1,100	2,000
Blank, M1909.....		20

■ 29. PRECAUTIONS IN FIRING BLANK AMMUNITION.—a. It is dangerous to fire blank cartridges at personnel at less than 20 yards, as the wad or paper cup may fail to break up within this distance.

b. Misfires in which the primer explodes but fails to ignite the powder charge may prove dangerous when blank ammunition is being fired. In this type of misfire, some of the powder may be blown into the bore of the weapon. A series of such rounds in which the powder fails to ignite (because of moisture or other causes) will result in serious damage when the accumulated powder is ignited by a subsequent cartridge. When misfires are encountered in blank ammunition in excess of 5 percent, the lot will be withdrawn and reported to the proper ordnance officer.

## CHAPTER 2

### MARKSMANSHIP—KNOWN-DISTANCE TARGETS AND TRANSITION FIRING

SECTION	Paragraphs
I. General .....	30-38
II. Preparatory marksmanship training.....	39-46
III. Qualification courses.....	47-51
IV. Range practice.....	52-55
V. Equipment, targets, and range precautions.....	56-58
VI. Small-bore practice.....	59-62

#### SECTION I

#### GENERAL

■ 30. **PURPOSE.**—The purpose of this chapter is to provide a thorough and uniform method of training individuals to be good rifle shots and of testing their proficiency.

■ 31. **NECESSITY FOR TRAINING.**—*a.* Without proper training, a man instinctively does the wrong thing in firing the rifle. He gives the trigger a sudden jerk, which causes flinching. However, if he has been thoroughly instructed and drilled in the mechanics of correct shooting and is carefully and properly coached when he begins firing, he will rapidly acquire correct shooting habits. It is much easier to develop into an excellent shot a man who has never fired a rifle than it is to correct the errors of a man who has done a great deal of shooting under improper supervision.

*b.* Anyone who is physically and mentally fit to be a soldier can learn to fire the rifle well if properly instructed. The methods of instruction are the same as those used in teaching any mechanical operation. The training is divided into steps which must be taught in proper sequence. The soldier is carefully coached and is corrected whenever he starts to make a mistake.

■ 32. **FUNDAMENTALS.**—To become a good rifle shot, the soldier must be thoroughly trained in the following essentials of good shooting:

- a.* Correct sighting and aiming.
- b.* Correct positions.

- c. Correct trigger squeeze.
- d. Correct application of sustained-fire principles.
- e. Knowledge of proper sight adjustments.

■ 33. PHASES OF TRAINING.—*a.* Marksmanship training is divided into two phases—

- (1) Preparatory marksmanship training.
- (2) Range practice.

*b.* No soldier will be given range practice until he has completed the entire course in preparatory marksmanship training (see par. 39*b*). Prior to taking up this training, each soldier should demonstrate his proficiency in mechanical training (ch. 1). Whenever practicable, selected officers and all noncommissioned officers of the unit should be required to complete a thorough course and pass a rigid test in preparatory marksmanship training immediately prior to the preparatory marksmanship training for the unit. Regardless of former qualification, no distinction will be made between those who have previously completed range practice and those who have not.

■ 34. PRACTICE SEASONS.—*a. Regular.*—In ordinary circumstances the regular practice season will cover a period of about 3 weeks for each organization. Not more than 1 week will be devoted to preparatory exercises, leaving 2 weeks for range practice. However, due to limited range facilities and the exigencies of the service, this time may be reduced to approximately 1 week. When unforeseen circumstances cause a delay during the period allotted for instruction, the time may be extended by the appropriate commander.

*b. Supplementary.*—Supplementary practice is not necessary when the regular practice season has been efficiently conducted, except in cases where a large number of unqualified men join the organization after the regular practice season. The supplementary practice season is usually placed as late in the fall as is consistent with efficient instruction. However, this practice may be held at any time when circumstances make it advisable.

■ 35. CONTINUOUS PRACTICE.—Rifle practice is not limited to a particular season. Subject to ammunition allowances, commanding officers will adopt such measures as may be neces-

sary to maintain a high state of excellence in rifle firing throughout the year. The particular measures adopted will depend upon the facilities near the post or station. Measures taken may include competition between individuals or organizations and the encouragement of small-bore rifle teams.

■ **36. INDIVIDUAL TRAINING.**—As part of individual training, all men armed with the rifle will be instructed in the fundamental elements of rifle marksmanship (par. 32) and in mechanical training as described in chapter 1. They will be given a final examination and should fire one of the small-bore qualification courses outlined in paragraph 62. Instruction in rifle marksmanship will commence with the initial instruction of the soldier and will continue throughout the period of individual training.

■ **37. DUTIES OF LEADERS AND COMMANDERS.**—*a. Squad leader.*—The squad leader—

(1) Organizes the work in his squad so that during the preparatory period each man is occupied in the prescribed form of training for target practice.

(2) Examines each man in his squad at the end of the training in each preparatory step and grades him on the Progress Chart (see par. 39*f*) showing state of training.

(3) Sees that each man takes proper care of his rifle and that he cleans it at the end of each day's firing.

(4) Enforces correct aiming, position, and trigger squeeze when firing is simulated in drills and maneuvers.

*b. Platoon leader.*—The platoon leader supervises and directs the squad leader in training his squad; personally checks each man in his platoon on the points enumerated in the Progress Chart; and examines each man along the lines outlined in paragraph 46.

*c. Company commander.*—The company commander requires the prescribed methods of instruction and coaching to be carried out carefully and in detail; supervises and directs the squad and platoon leaders; in companies of fewer than 60 men, performs the duties prescribed in *b* above for platoon leaders.

*d. Battalion commander.*—The battalion commander requires the officers and noncommissioned officers to be familiar



with the prescribed methods of instruction and coaching; supervises the instruction within his battalion and requires the companies to follow out carefully and in detail the preparatory exercises and methods of coaching.

*e. Instructors.*—All instructors should become familiar with sections I, II, and III, chapter 6, before beginning the instruction of their units.

■ 38. **PREPARATORY MARKSMANSHIP EQUIPMENT.**—All equipment used in preparatory exercises must be accurately and carefully made. One of the objects of these exercises is to cultivate a sense of exactness and carefulness in the minds of the men undergoing instruction. They cannot be exact with inexact instruments, and they will not be careful when working with equipment that is carelessly made (pars. 56 and 140).

## SECTION II

### PREPARATORY MARKSMANSHIP TRAINING

■ 39. **GENERAL.**—*a.* The purpose of preparatory marksmanship training is to teach the soldier the essentials of good shooting and to develop fixed and correct shooting habits before he undertakes range practice.

*b.* Preparatory marksmanship training is divided into six steps, as follows, and should be concentrated in the period of time allotted:

(1) Sighting and aiming exercises.

(2) Position exercises.

(3) Trigger-squeeze exercises.

(4) Sustained-fire exercises.

(5) Instruction in the effect of wind, sight changes, and use of the score book.

(6) Examination of men before starting range practice.

*c.* The first four steps are given in the sequence listed above, since each succeeding step involves the use of technique learned in preceding steps. Instruction in the effect of wind, sight changes, and the use of the score book is a training step that may be given without adhering to any particular sequence. However, this instruction should pref-

erably be given after sighting and aiming exercises. In any event, it will be given before the examination, which is the final step prior to range practice. This subject matter may be taught indoors during inclement weather.

*d.* Each of the first four steps starts with a lecture by the instructor to the assembled group. This lecture includes a demonstration by a previously rehearsed squad which the instructor puts through the exercises that are to constitute the day's work. He shows exactly how to do the exercises that are to be taken up and explains their application to rifle shooting. He shows how the squad leader organizes the work so that no men are idle and how men coach each other when they are not under instruction by an officer or noncommissioned officer. These lectures and demonstrations are an essential part of the training. If properly given, they awaken the interest and enthusiasm of the whole command for the work and give an exact knowledge of how each step is to be carried on—something that men cannot get from merely reading a description. The instructor who gives these lectures and demonstrations may be the platoon leader, unit commander, or a specially qualified officer who has been placed in charge of rifle instruction. The officers and non-commissioned officers of the units undergoing training supervise and instruct the men in the performance of the exercises that have been demonstrated to them.

*e.* The instruction must be thorough, and it must be given individually. Each man must understand every point and must be able to explain each one in his own words. Each man must be brought to as high a state of proficiency on all of the enumerated points as the time allotted for preparatory work will permit. The unit commander will carefully supervise the work. From time to time, he should pick out men at random from the platoons and put them through a test to see whether the instruction is thorough and whether it is progressing satisfactorily.

*f.* The Progress Chart below will be kept by each squad leader. It will also be kept by each platoon leader independently of the squad leader. The form shows at a glance how much each man knows about each subject.

				NAME	
				Care and cleaning of the rifle	
				Sighting bar	
				Sighting and aiming with rifle	
				Shot group exercises—50 feet	
				Shot group exercises—200 yards	
				Blackening sights	
				Use of gun sling	
				Holding the breath	
				Prone position	
				Prone position with sandbag	
				Sitting position	
				Kneeling position	
				Squatting position	
				Standing position	
				Assuming positions rapidly	
				Trigger squeeze (including taking up slack)	
				Calling the shot	
				Bolt manipulation	
				Sustained fire	
				Sight changes	
				Effect of light and wind	
				Use of score book	
				Ability to couch	
				Final examination	
				Gallery practice	
				Pads	
METHOD OF MARKING					
Unsatisfactory:	X	Satisfactory:	X X	Has instructional ability:	X X X

PROGRESS CHART

POSITIONS

*g.* Enthusiasm must be sustained, and everything possible should be done to stimulate interest. As soon as the work deteriorates into a perfunctory performance of physical exercise, it does more harm than good.

*h.* Careful attention will be paid to the essential points brought out in the list of questions and answers in paragraph 46. This paragraph will be consulted by the instructor during each step of the preparatory work. Each man should be tested thoroughly before he is allowed to fire.

*i.* During preparatory exercises, the coach-and-pupil method is used. The men are grouped in pairs and take turns in coaching each other. The man undergoing instruction is called the pupil.

*j.* Correct shooting habits should be acquired during the preparatory training period. All errors must be noted, brought to the attention of the pupil, and corrective action taken. Each soldier must be impressed with the importance of exactness in every detail. For example, there is no such thing as a trigger squeeze that is "about right"; it is either perfect or it is incorrect.

*k.* Equipment used in the preparatory marksmanship training is listed in paragraph 56.

*l.* During preparatory training, only practice dummy cartridges (corrugated type) will be used. Either the corrugated type or the range (slotted type) dummy cartridges may be used on the firing line.

■ 40. BLACKENING THE SIGHTS.—In all preparatory exercises involving aiming and in all range firing, both sights of the rifle, if not already sufficiently black, should be blackened. Before blackening, the sights should be cleaned and all traces of oil removed. The blackening is done by holding each sight for a few seconds in the point of a small flame which will deposit a uniform coating of lampblack on the metal. A carbide lamp, kerosene lamp, candle, or small pine stick can be used for this purpose. Carbide gas from a lamp is the most satisfactory of the materials named.

■ 41. FIRST STEP: SIGHTING AND AIMING.—*a. Sight picture.*—The instructor shows the group the correct sight alignment (relationship of front sight blade and peep sight) and the

*FRONT SIGHT*

*PEEP SIGHT*

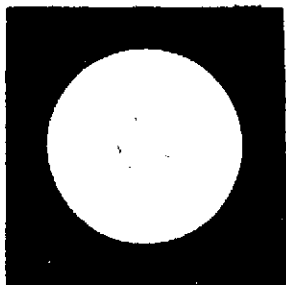

①



②



③

FIGURE 16.--Sight alinement.

correct aim on the bull's-eye (sight picture) (fig. 16). He does this by the use of a model sight picture device or by using the blackboard (fig. 17). He explains that although the wings of the front sight are visible when the rifleman is looking through the peep sight, they play no part in the sight alinement and that as the rifleman progresses in his training he quickly learns to ignore them (fig. 18).

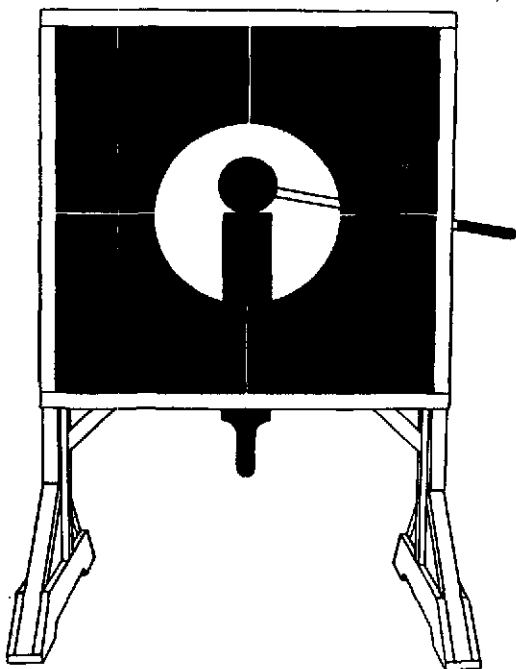

FIGURE 17.—Model sight picture device.

*b. First exercise.*—(1) The instructor shows a sighting bar (fig. 19) to his group and explains its use as follows:

(a) The front and rear sights on the sighting bar represent enlarged rifle sights.

(b) The sighting bar is used in the first sighting and aiming exercise because it shows the sights on a large scale and

because with it small errors can be seen easily and explained to the pupil.

(c) The eyepiece requires the pupil to place his eye in such position that he sees the sights in exactly the same alinement seen by the coach.



FIGURE 18.—Sight picture, U. S. rifle, caliber .30 M1917.

(d) There is no eyepiece on the rifle, but the pupil learns by use of the sighting bar how to aline the sights properly when using the rifle.

(e) The removable target attached to the end of the sighting bar provides a simple method of readily alining the sights on a bull's-eye.

(2) The instructor explains that the removable rear sight on the sighting bar can be adjusted so as to give a correct

sight alinement. He demonstrates a correct sight alinement by means of a chart or the model sight picture device (fig. 17). He explains that in the correct alinement the top of the front sight falls on the horizontal diameter of the peep sight and is "exactly centered." Thus, equal portions of the front sight are to the right and left of the vertical diameter of the peep sight. As soon as the pupils are shown the correct position of the front sight within the rear sight, they will demonstrate their ability to set the correct sight alinement with the sighting device (fig. 20). In this exercise, the bull's-eye of the sighting device is drawn up out of sight. The in-

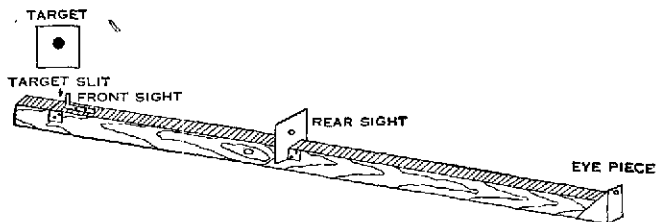

FIGURE 19.—Sighting bar.

structor will check each pupil's sight setting for accuracy and will correct all errors.

(3) The instructor adjusts the sights of the sighting bar, with the target removed, to illustrate a correct alinement of the sights. Each man of the assembled group looks through the eyepiece at the correct sight alinement.

(4) The instructor adjusts the sights of the sighting bar with various small errors in sight alinement and has each man of the assembled group endeavor to detect and correct the errors.

(5) Using a chart or model sight picture device, the instructor describes and demonstrates a correct aim. He explains that the relation of the front sight to the peep sight is the same as previously explained but in addition the middle point of the top of the front sight just touches (is tangent to) the bottom of the bull's-eye, so that all of the bull's-eye can be clearly seen (fig. 18).



(6) The instructor explains that, in aiming, the rifleman's eye should first be focused on the target in order to ascertain that he is firing on his own target. His eye is then focused on the top of the front sight in order to insure that the line of sight established is a line through the center of the peep sight and over the top of the front sight. He also demonstrates how a slight error in centering the front sight in the peep sight will cause the line of sight, when it reaches the target, to diverge greatly from the center of the bull's-eye.

(7) The instructor adjusts the sights of the sighting bar and the removable target so as to illustrate a correct aim and then requires each man to observe through the eyepiece the correct alinement of the sights and the target (fig. 21).

(8) The instructor adjusts the sights and the removable target of the sighting bar so as to illustrate various small errors and then requires each man in the group to attempt to detect and correct the errors.

(9) The exercises described above having been completed by the squad leader or some other instructor, the men are placed in pairs and repeat the exercise by the coach-and-pupil method.

(10) As soon as the pupil is considered proficient in the first sighting and aiming exercise, he is put through the second and third sighting and aiming exercises by the instructor. The pupils are placed in pairs to instruct each other in these two exercises by the coach-and-pupil method.

*c. Second exercise.*—(1) A rifle with sights blackened and set at 200 yards elevation is placed in a rifle rest and pointed at a blank sheet of paper mounted on a box. Being careful not to move the rifle or rifle rest, the instructor takes a position (fig. 22) so that his body is at an angle of from 45° to 60° to the line of the rifle extended to the rear. Both elbows are on the ground. The chin rests in the palm of the left hand. The right hand is free for signaling to the marker. The cheek rests lightly on the stock and at such a point that the eye is approximately the same distance from the peep sight as it will be in actual firing. The instructor then directs the marker by improvised arm-and-hand signals to move the small disk until the bottom of the bull's-eye is

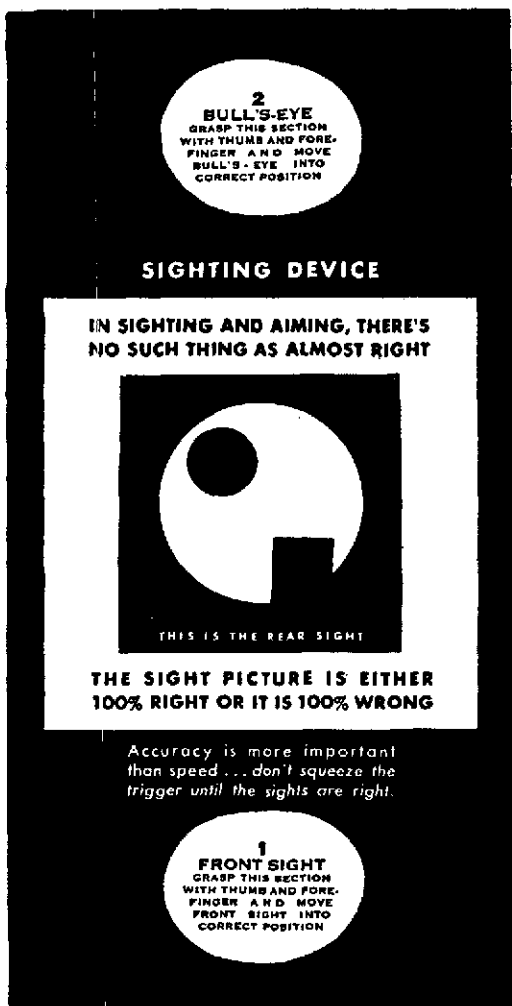

①

FIGURE 20.—Sighting device.

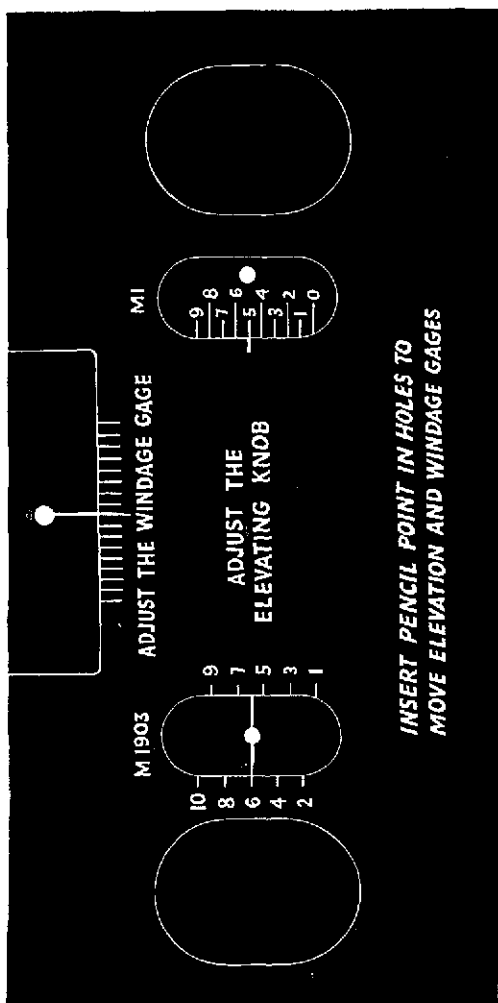

FIGURE 20.—Sighting device—Continued.

in correct alinement with the sights. The breath should be held when checking the final sight alinement with the bull's-eye. The instructor commands: **HOLD**, to the marker. The instructor moves away from the rifle and directs the pupils to look through the sights in order to observe the correct aim.

(2) After pupils have seen the correct position of the rear sight, front sight, and bull's-eye, they will demonstrate their

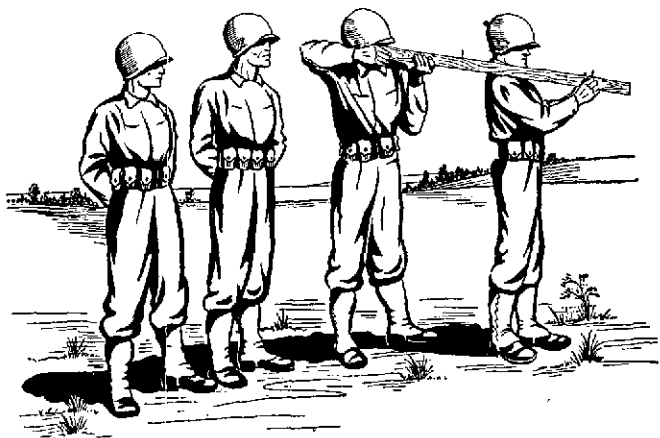

FIGURE 21.—Instructor adjusting sighting bar to show correct sight picture.

ability to create the correct sight picture with the sighting device. Instructors will check accuracy of the sight picture and will correct errors (fig. 20).

(3) The marker moves the disk out of alinement. Each pupil in turn takes position and directs the marker to move the disk until the bottom of the bull's-eye is in correct alinement with the sights. The instructor looks through the sights after each pupil to see if the alinement is correct.

(4) The instructor makes a series of slightly incorrect sight alinements on the bull's-eye and then requires the pupil to detect, describe, and correct the faulty alinements.

(5) The men are now placed in pairs and are required to repeat the exercise by the coach-and-pupil method.

*d. Third exercise.*—(1) The object of this exercise is to show the importance of uniform and correct aiming and to instill into the mind of the pupil a sense of exactness. At

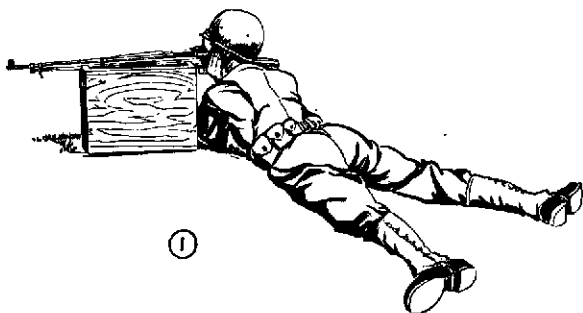

FIGURE 22.—Position for second and third sighting and aiming exercises.

50 feet and with a small bull's-eye ( $\frac{7}{8}$ -inch in diameter), a good group of three marks can be covered by the unsharpened end of a lead pencil.

(2) The exercise is conducted as follows: The rifle, with the sights blackened and set at 200 yards elevation, is placed

in a rifle rest and pointed at a blank sheet of paper mounted on a box. The rifle rest and the aiming box on which the marker sits should each be weighted with a sandbag or rocks. Taking a prone position (fig. 22) and looking through the sights without moving the rifle or rifle rest, the pupil directs the marker by improvised arm-and-hand signals to move the disk until the bottom of the bull's-eye is in correct alinement with the sights. He then commands: **HOLD**, to the marker. The breath should be held when the final sight alinement with the bull's-eye is checked. The coach looks through the sights to see if the alinement is correct and makes a mental note of any errors. Then without comment to the pupil, he commands: **MARK**. The marker, without moving the disk, makes a dot on the paper with a sharp-pointed pencil inserted through the hole in the center of the bull's-eye. The marker then moves the disk to change the alinement. The marker should hold the disk by pressing the handle against the box with the fingers of one hand, the thumb of the hand resting on top of the box. The other hand is used to move the disk. The pupil and coach, without moving the rifle or rifle rest, repeat this operation until three dots, numbered, one, two, and three, respectively, have been made. These dots form the shot group. The pupil's name is written under the shot group so that when the paper is removed from the box the triangle can be discussed with correct reference to dots as "high," "low," "right," and "left." The size and shape of the shot group will be discussed and the errors pointed out (fig. 23).

(a) A triangle the longer axis of which is vertical is the result of one or both of the following errors:

1. Top of front sight not exactly on the horizontal diameter of the peep sight.
2. Bull's-eye not tangent to front sight (taking line of white or raising front sight into the bull's-eye).

(b) If the longer axis of the triangle is horizontal, one or both of the following errors have been made:

1. Front sight not centered from right to left in the peep sight.
2. Bull's-eye tangent to front sight but not at the midpoint.

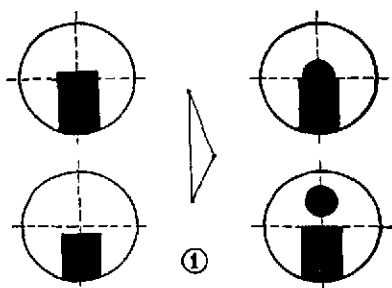

A.  
TOP OF FRONT SIGHT NOT  
EXACTLY ON THE HORIZONTAL  
DIAMETER OF PEEP SIGHT.

B.  
BULL'S-EYE NOT TANGENT  
TO FRONT SIGHT.

EITHER KIND OF ERROR (A OR B) WILL PRODUCE A  
TRIANGLE SIMILAR TO 1 ABOVE.

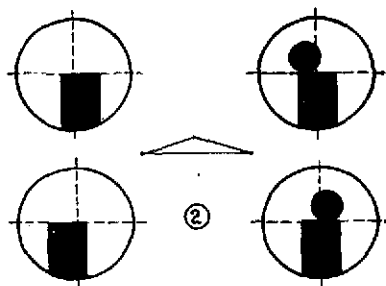

C.  
FRONT SIGHT NOT CENTERED  
FROM RIGHT TO LEFT IN  
PEEP SIGHT.

D.  
BULL'S-EYE TANGENT TO  
FRONT SIGHT BUT NOT AT  
THE MIDPOINT.

EITHER KIND OF ERROR (C OR D) WILL PRODUCE A  
TRIANGLE SIMILAR TO 2 ABOVE.

FIGURE 23.—Errors causing unsatisfactory triangles.

(3) This exercise will be repeated until a satisfactory triangle is made. It should also be conducted over a range of 200 yards (using a 10-inch movable bull's-eye) (fig. 24). The long-range exercise teaches the men to aim accurately at a distant bull's-eye and, if properly conducted, helps greatly to sustain interest. At 200 yards, a man should be able to make a shot group that can be covered with a silver dollar (a circle about  $1\frac{1}{2}$  inches in diameter).

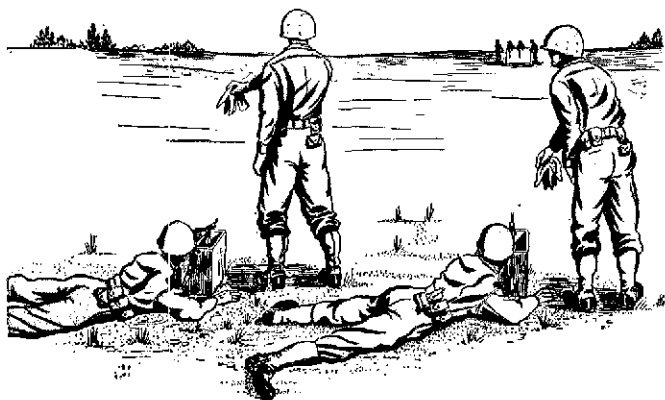

FIGURE 24.—Making 200-yard triangles.

(4) For making triangles at 200 yards, a blank screen which corresponds in size (about 5 feet by 3 feet) to a 1,000-inch machine-gun target may be used instead of the paper on the aiming box in the 50-foot exercise (see (2) above). One screen can be used by two groups simultaneously. Two men for each group are stationed at the screen, one to hold the disk and one to mark the point when the signal is given. Tissue paper may be used to make tracings of each pupil's long-range shot group. The name of the pupil is written on the tissue paper under the shot group he has made. These tracings are sent back to the firing line in order that the pupil can see what he has done.

(5) The third sighting and aiming exercise, especially the



long-range shot group work, may be carried on concurrently with the second and third preparatory steps. The purpose of continuing these exercises is to bring backward men up to the proper state of proficiency and to assist in keeping the men interested.

(6) Competition between the individuals of a squad to see which can make the smallest shot group is of value in creating interest in this exercise.

(7) Posting of the best triangles on the company bulletin board stimulates interest and helps to develop a competitive spirit.

■ 42. SECOND STEP: POSITIONS.—*a. General.*—Instruction in positions includes the use of the gun sling, holding the breath while aiming, and aiming.

*b. Gun sling.*—A properly adjusted gun sling is of great assistance in shooting. It helps to steady the rifle and should be adjusted to give firm support without discomfort to the soldier. The instructor will assist each man to obtain the correct adjustment for his sling. This adjustment should be marked or remembered for each position. The hasty sling and the loop sling are the two authorized adjustments used in firing the rifle. The hasty sling is more rapidly adjusted than the loop sling, but it gives less support in any but the standing position.

(1) *Loop sling.*—Methods for adjusting the three types of gun slings are indicated below:

(a) *Gun sling M1907 (leather)* (fig. 12①).

1. Place the rifle butt on the right thigh, extend the right arm around the rifle so that the latter rests on the inside of the right forearm. Both hands are now free to adjust the sling. Disengage the hook of the short strap. Taking the loop (D-ring) of the short strap in the right hand, pull toward the muzzle of the rifle until the hook of the short strap is 2 or 3 inches from the butt swivel and then insert the prongs of the hook into a pair of holes in the short strap (fig. 25).
2. The loop to be used in firing is formed by that part of the long strap between the metal loop (D-ring)

of the short strap and the lower keeper. If the proper length of the loop is not known, begin with a loop which extends 1 or 2 inches below the small of the stock. The length of the loop can be increased by placing the hook of the long strap in pairs of holes which are nearer the feed end of the long strap.

3. Rotate the sling one-half turn to the left, insert the left arm through the loop so that the loop comes on or above the biceps.
4. Pull both keepers and the hook of the long strap as close to the upper arm as possible so as to hold the loop in place. The feed end of the long strap may be threaded through the top keeper or may be left hanging loose.
5. Move the left hand around the left side of the sling and place it between the sling and the stock of the rifle. Move the left hand forward to the lower band swivel so that the rifle is in the crotch of the hand and the sling lies flat along the back of the hand and wrist. The short strap, not used in this adjustment, should be loose enough to eliminate any pull on it. Neither end of the sling is to be removed from either swivel. The location of the loop on the upper arm should be such that when the rifleman is in position some light may be seen between the sling and the crook of the elbow.

(b) *Gun sling M1 (improved web)* (fig. 12②).

1. Place the rifle on a flat surface, sights down, barrel pointing to the left.
2. Open the keeper, loosen the sling, unsnap the hook from the butt swivel. Loosen strap through buckle until the loop formed by the strap as it passes through the two slots in the buckle is large enough for the rifleman's arm.
3. Take the feed end of the sling in the left hand and the hook in the right hand. With the left hand, pull the feed end of the sling in the direction of the butt. If the correct sling length is not known, this adjustment (pulling the feed end toward the

butt) should be discontinued when the hook reaches a point 10 or 11 inches from the butt swivel. Pull the keeper as close to the buckle as possible and close it. Now, with the right hand firmly grasping the small of the stock, brace the butt of the rifle against the right hip. With the left hand, rotate the loop one-half turn to the left and insert the left arm through the loop so that the loop comes on or above the biceps.

4. Move the left hand over the top of the sling and grasp the rifle near the lower band swivel so as to cause the sling to lie smoothly along the back of the hand and wrist.

NOTE.—By experimentation, each rifleman can decide the exact size of the loop required for his use. He can leave the loop in this adjustment permanently. No adjustments for size will have to be made thereafter. The precise length required for the loop sling can also be determined by experimentation. Once this has been done, the rifleman should note the distance between the butt swivel and the hook when the sling is in the correct adjustment. This distance may subsequently be used as a gage for setting the same length on the loop sling.

(c) *Gun sling M1923 (web) (fig. 12③).*

1. Loosen the sling in the manner described for carrying the rifle in the sling arms position (see par. 21e (2) (c)).
2. Next, detach the feed end of the short strap from the large buckle. To prevent loss of the small buckle and to prevent the feed end of the short strap from sliding back through the butt swivel, bring the feed end of the short strap up through the middle slot of the small buckle and then down through the slot farthest from the thumbpiece of the small buckle.
3. Now, with the right hand firmly grasping the small of the stock, brace the butt of the rifle against the right hip. With the left hand rotate the sling

one-half turn to the left, insert the left arm through the loop formed between the keeper and the metal loop (D-ring) end of the short strap so

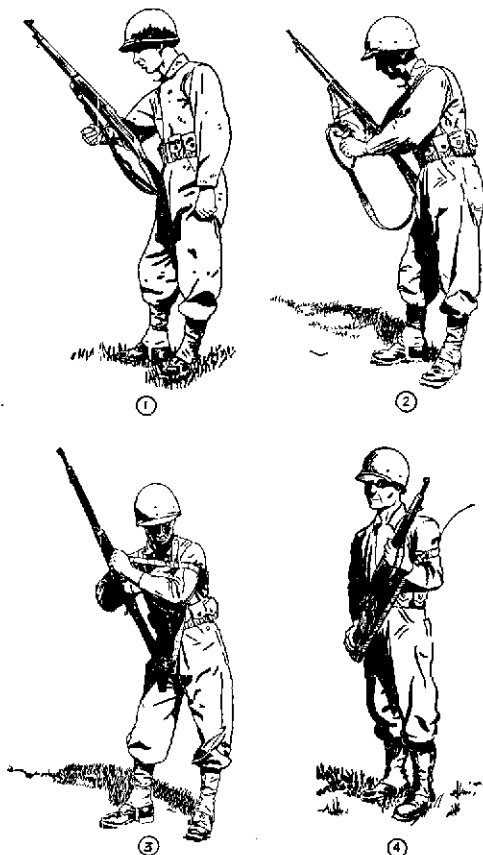

FIGURE 25.—Adjustment of loop sling.

that the loop to be used in firing comes on or above the biceps. Bring the keeper close to the arm and close it to keep the loop in place.

4. Move the left hand over the top of the sling and grasp the rifle near the lower band swivel so as to cause the sling to lie smoothly along the back of the hand and wrist.

(2) *Hasty sling*.—Methods for adjusting the three types of gun slings are indicated below.

(a) Gun sling M1907 (*leather*) (fig. 12①).

1. Hold the rifle on the thigh and right forearm as explained above for the loop sling adjustment. Disengage the hook of the short strap. Beginning with the pair of holes nearest the hook of the long strap, count off 10 or 11 pairs and insert the claws of the hook of the short strap. (This adjustment will vary. If the correct sling length is not known, start with a length in which the lower end of the sling extends 2 or 3 inches beyond the rifle butt.)
2. Twist the sling one-half turn to the left.
3. Grasp the rifle just in rear of the lower band swivel with the left hand. Grasp the small of the stock with the right hand. Throw the sling to the left and catch it above the elbow, high on the left arm.
4. Remove the left hand from the rifle. Pass the left hand to the left under the sling and then to the right and over the sling. Regrasp the rifle with the left hand. If the sling has been given the one-half turn properly, it will lie smooth and flat along the back of the left hand and wrist (fig. 26).

(b) Gun sling M1 (*improved web*) (fig. 12②).

1. Loosen the sling in the manner described for carrying the rifle in the sling arms position (see par. 21e (2) (b)).
2. With left hand, grasp the rifle just in rear of the lower band swivel. With the right hand give the sling a half turn to the left. Move the sling to the left and place it above the elbow and high on the arm. Regrasp the rifle at the small of the stock with the right hand.

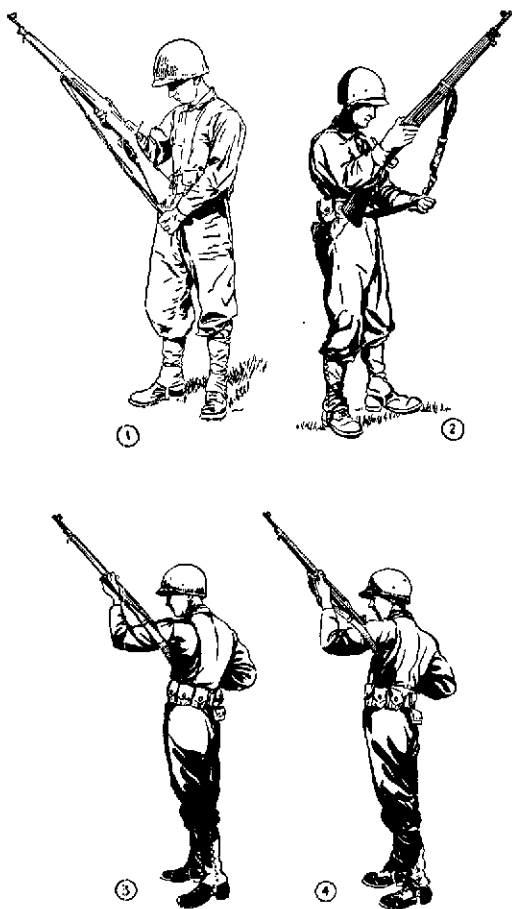

FIGURE 26.—Adjustment of hasty sling.

3. Remove the left hand from the rifle, pass it under the sling, then over the sling, and regrasp the rifle with the left hand so as to cause the sling to lie smooth and flat along the hand and wrist.

(c) *Gun sling M1923 (web)* (fig. 12③).

1. Loosen the sling in the manner described for carrying the rifle in the sling arms position (see par. 21e(2)(c)).
2. With the left hand grasp the rifle just in rear of the lower band swivel. With the right hand, give the sling a half turn to the left. Move the sling to the left and place it above the elbow and high on the arm. Regrasp the rifle at the small of the stock with the right hand.
3. Remove the left hand from the rifle, pass it under the sling, then over the sling, and regrasp the rifle with the left hand so as to cause the sling to lie smooth and flat along the hand and wrist.

c. *Holding breath.*—If a man breathes while aiming, the body motions caused by breathing are transmitted to the rifle, and an exact aim cannot be held. To eliminate this movement of the rifle, the breath must be held while aiming. To hold the breath properly, draw in an ordinary breath, let out a little, and hold the rest by closing the throat—not by muscular action of the diaphragm. The rifleman should be comfortable, relaxed, and steady while aiming and while squeezing the trigger. He should not attempt to hold the breath so long as to become unsteady. In firing a sustained-fire score, the rifleman should breathe *after each shot—never while he is squeezing the trigger*. The important point is to hold the breath throughout the time the trigger is being squeezed.

d. *General characteristics for all positions.*—The following characteristics apply to all firing positions. The exact details of a position for any particular individual will depend on the conformation of his body.

(1) Each position must be steady and must require a minimum of muscular effort for its maintenance during prolonged firing. To accomplish this, the rifleman's frame

supports the rifle; that is, the bones and not the muscles support the rifle.

(2) When the rifleman assumes a position, there is some point at which the rifle aims naturally and without effort. If this point is not the center of the target, *the whole body must be shifted* so as to bring the rifle into proper alinement. Otherwise the rifleman will be under a strain because for each shot he will be pulling the rifle toward the target by muscular effort.

(3) The right hand grasps the small of the stock. The right thumb may be either around the small of the stock or on top of the stock; it should not be placed alongside the stock.

(4) The left hand is against or near the lower band swivel, wrist straight, rifle placed in the crotch formed by the thumb and index finger and resting on the heel of the hand.

(5) The elbow is directly under the rifle or as nearly in that position as it can be placed without appreciable effort. For untrained men, this will initially require strenuous effort.

(6) The trigger finger is in contact with the trigger at the most comfortable point between the tip and the second joint, the remainder of the forefinger being out of contact with the stock. The exact part used depends on the size of the rifleman's hand and the length of his arm. It is desirable that there be no contact between the trigger finger and the stock. This insures that trigger pressure will be straight to the rear and that all pressure will be applied on the trigger and not partly on the stock.

(7) The cheek rests firmly against the stock, and if possible, on top of the thumb. This is best accomplished by relaxing the neck muscles and allowing the head to drop forward and downward.

(8) The butt of the rifle is held firmly against the shoulder.

(9) When firing at short ranges (up to 500 yards), a slight cant of the rifle may be disregarded. Men who cant the rifle usually do so uniformly for each shot.

(10) Left-handed men who have difficulty with the right-hand position will be allowed to use the left-hand position.



(11) In all positions, the pupil should strive for complete relaxation. This goal is reached only by continued application and training. Perfection should be the ultimate aim.

(12) Different positions for slow and sustained fire should not be taught. Slow fire is used to lay the foundation for sustained fire. It is therefore obvious that a slow-fire position which is unsound for sustained fire is a waste of time and effort and should not be permitted.

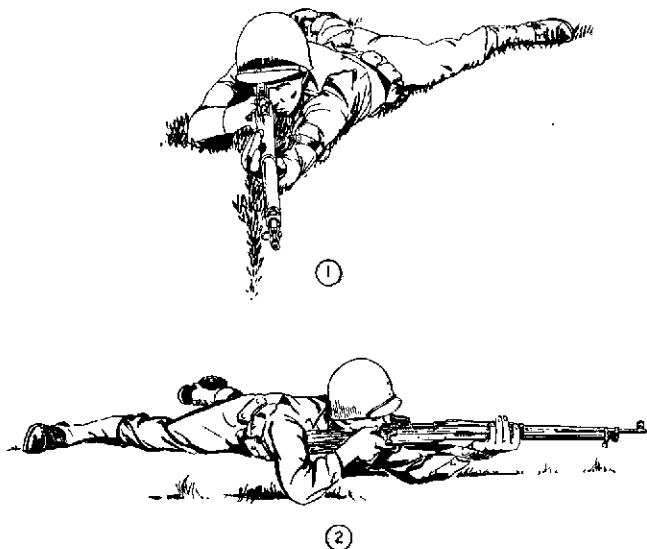

FIGURE 27.—Prone position.

*e. Prone position (fig. 27).*—(1) In the prone position, the angle made by the body with the line of aim extended to the rear should be about  $30^{\circ}$ , or a little less. This position behind the rifle is essential in order that the recoil may be taken up by the entire body of the rifleman rather than by the shoulder alone. The feet are spread comfortably apart, toes out, heels as nearly on the ground as can be accomplished without strain. The left elbow is under the rifle. The left hand is against or near the lower band swivel, the rifle resting in the

V formed by the thumb and forefinger and on the heel of the hand, with the wrist straight and the fingers relaxed. Inability to get the left elbow under the rifle or the left hand against or near the lower band swivel is usually caused by a stiff or musclebound shoulder. Relaxation of the left shoulder should make it possible to assume the correct position. The shoulders are approximately level. The right upper arm makes an angle of about  $45^{\circ}$  with the ground; the right elbow is forward of the line of the shoulders in order to create a hollow at the shoulder in which to secure the rifle butt. Full contact of the right palm and the small of the stock is desirable. The thumb is on top of or across the stock; the eyes are level and the line of vision is straight ahead—not sideways over the bridge of the nose. The sling is tightened, and the rifle butt is fixed firmly against the shoulder by the forward pressure of the relaxed body weight.

(2) If the prone position has been taken correctly, the right hand may be removed from the small of the stock while the rifle remains snugly in place, requiring some effort on the part of the coach to dislodge it. Another method for checking the prone position is to tap down lightly on the barrel just in rear of the front sight. With a good position, the muzzle should rise straight up (not up to the right or left) and then return to the original point of aim. The pupil should make the following final check: after he believes himself to be in a correct position, he closes his eyes and relaxes completely for several seconds. He then opens his eyes and checks his sight alinement. If his position is correct, the rifle sights will still be alined under the bull's-eye. If they are not alined on the target, his position is faulty, and he should shift his whole body in the direction and to the extent indicated by the error and repeat the process just described.

(3) Errors most frequently found in taking the prone position and the methods of correcting them are discussed below:

(a) *Body placed at too great an angle with rifle.*—This fault can frequently be detected by observing that the upper part of the body is held too high off the ground and that the eye is held too close to the cocking piece. This very common fault causes most of the recoil to be taken up by the

shoulder instead of being absorbed by the entire body. The error is usually caused by too short an adjustment of the sling. The remedy is to loosen the sling by several holes and move the body into position more directly behind the rifle.

(b) *Right elbow too close to body.*—The right shoulder will be observed to be much higher than the left. The back may appear twisted. To remedy this fault, the right elbow is moved out to the right and slightly forward.

(c) *Left elbow not under rifle.*—This is obvious. As a result of this error, the rifle is supported by the muscles of the

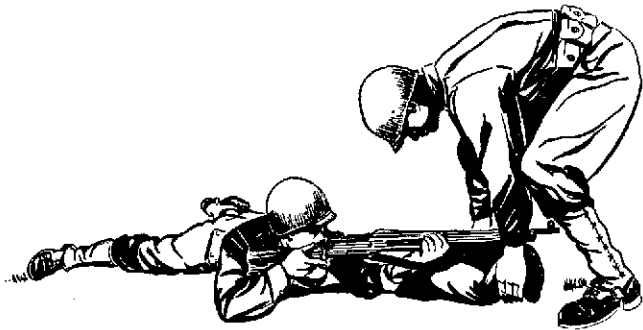

FIGURE 28.—Prone position with sandbag.

arm rather than by the bones. The remedy is to move the left elbow farther to the right. This is best accomplished with the rifle butt removed from the shoulder. Relaxation of the left shoulder and continuous practice will assist in placing the left elbow under the rifle where it should be.

(d) *Left hand not against or near the lower band swivel.*—To remedy this error, the left shoulder should be relaxed and the hand should be moved forward. Tightening the sling one or two holes may assist in correcting this fault. This error can occur in the other positions and should be guarded against.

f. *Sandbag rest position (fig. 28).*—(1) The sandbag rest position is identical in every detail to the prone position described above, except that a sandbag support is provided for the left forearm, wrist, and hand. The sandbag should

not support nor should it be in contact with the rifle, as this rigid support will affect the zero of the rifle.

(2) The sandbag should be little more than half filled with sand and should be tied near the top so as to leave considerable free space within the bag for adjustment.

(3) It is important that the sandbag be high enough to allow the pupil to take the prescribed prone position. The tendency is to have the sandbag rest too low and flat on the ground, causing the elbows to be widely spread. This is a faulty position that may cause lower scores to be fired than if no rest at all were used. An improperly adjusted sandbag is a handicap.

(4) Only those who have difficulty in applying the correct trigger squeeze during the first stages of training should use the sandbag rest. Its purpose is not so much to teach steadiness in holding as to assist the pupil in learning the correct trigger squeeze. Consequently, the principal use of the sandbag on the rifle range will be to assist riflemen who have a tendency to flinch because of an unsteady position which induces snap shooting. By using the sandbag, the slight inherent unsteadiness is eliminated, and the rifleman will not be tempted to snap the trigger at the instant he establishes a sight alinement with the bull's-eye. In this way, he will be assisted in overcoming the tendency to flinch.

(5) The coach adjusts the sandbag in the following manner:

(a) Has the pupil assume the prone position and aim at the target.

(b) Sets the sandbag top up and arranges it so that it is slightly higher than the back of the pupil's left hand.

(c) Faces the pupil, straddles the rifle barrel, and slides the sandbag against the pupil's left forearm so that the narrow side of the bag supports his forearm and wrist, with the back of the hand resting on the top of the bag.

(d) Lowers the sandbag to the required height by pressing down on the rifle at a point just over the pupil's left hand.

*g. Sitting position* (fig. 29).—(1) In the sitting position, the rifleman sits approximately half-faced to the right. The

feet are spread apart from 20 to 30 inches, depending on the conformation of the rifleman. The knees are raised about 8 inches off the ground and are closer together than the feet; the heels are dug *slightly* into the ground; and the legs and ankles are relaxed so that the toes point forward or inward—they should never point outward or sharply upward. Heel holes which slope sideways from the outside in will assist in keeping the toes pointed in. If the rifleman is supple enough to place both feet flat on the ground without raising his knees too high, he has an advantage. The left upper arm rests along the left shin so that there is contact between the two for a distance of several inches, the weight being placed *straight down* on the left leg. The left elbow is under the rifle. The body is bent forward from the hips; the back is approximately straight. The right upper arm rests along the right shin in a position similar to that of the left arm and leg but slightly on the inside of the right leg so that the shin will act as a support for the right arm when the rifle recoils. The sling is adjusted as previously explained. For most men, the sling adjustment will be shorter in this position than it is for the prone position. The relative positions of the rifle and the hands and the method of holding the face to the stock correspond to those explained for the prone position (see *e* above).

(2) The sitting position is second only to the prone position for steadiness because the rifleman has a rest for each elbow. The sitting position is suitable for use in the field when high grass or vegetation would obscure the rifleman's vision in the prone position. When concealment is available, the sitting position is also especially suitable for firing downhill.

(3) Because of unusual conformation, some men cannot take the sitting position described above. The vast majority of such exceptions are men with unusually long legs and relatively short arms and body. These men are physically unable to place their elbows in the prescribed position. In such cases the instructor may authorize the soldier to modify the prescribed position, using either the "cross-legged" or the "crossed-ankle" positions. Each case is decided by the instructor on its merit; in no circumstance will these modified positions be adopted at random by the riflemen.

(4) In the cross-legged position (fig. 29③) the rifleman sits with his left leg crossed over his right leg, his feet drawn up under him so that the outer part of the calf of each leg

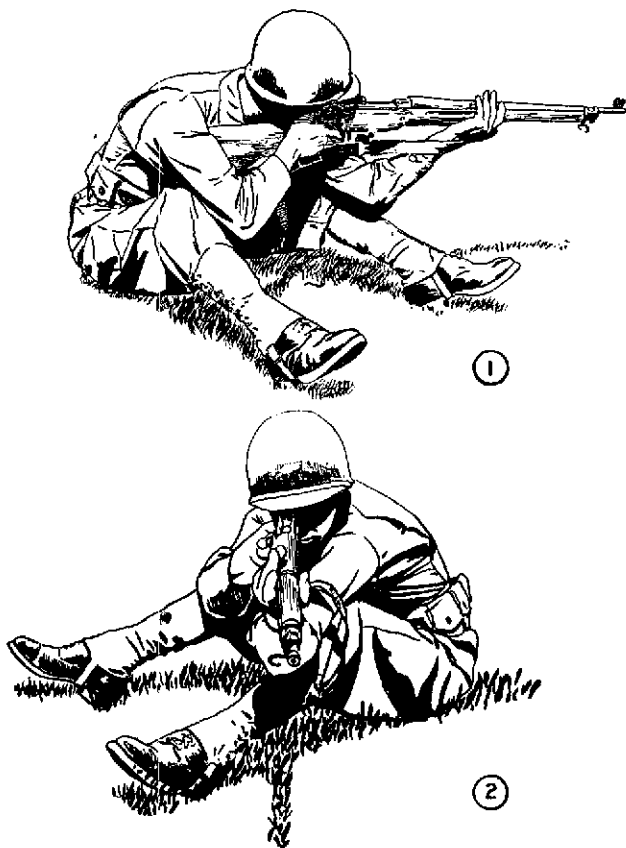

FIGURE 29.—Sitting positions.

rests on the inside of the opposite foot. The backs of the upper arms are supported against the shin bones and are very nearly at right angles to them. The remaining elements

of the position correspond to those of the normal sitting position.

(5) In the crossed-ankle position (fig. 29④) the pupil sits with the left ankle crossed over the right ankle, the legs well extended. In this position, as in the cross-legged position,

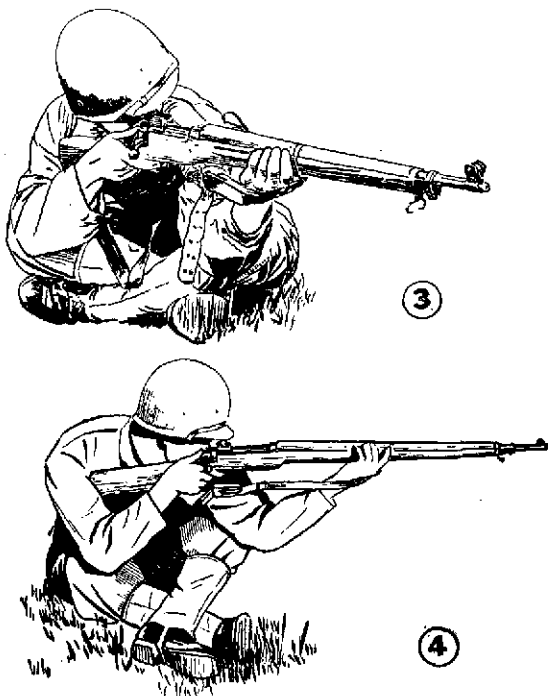

FIGURE 29.—Sitting positions—Continued.

the upper arms are supported by the shins, but in this position more contact is afforded than when the rifleman sits cross-legged. However, the crossed-ankle position provides only a two-point base of support and is therefore less stable than the cross-legged position, which has a three-point base. For this reason, the crossed-ankle position should be avoided, if pos-

sible, by men whose weight is less than about 170 pounds. The amount of leg extension will depend upon leg conformation of the individual. At the same time, constant care must be exercised to insure that the legs are relaxed and that the knees are not held up by sheer muscular effort.

(6) Errors most frequently found in taking the normal sitting position and the methods for correcting them are discussed below.

(a) *Elbows and knees placed so as to make point to point contact.*—Not only does this error result in an unstable support for the rifle but it puts the body in a position which is too erect and which is therefore faulty when used in sustained fire. To remedy this fault, have the pupil lower his knees, bend his body well forward at the hips, and establish contact between the upper arm and the shin bones. When the left upper arm and the left lower leg both slope at exactly the same angle, the rifleman is in a correct sitting position.

(b) *Knees farther apart than feet.*—This causes the vertical support for the rifle to be obtained through unnecessary muscular effort. It may be caused by—

1. Placing the feet too close together.
2. Turning the toes outward (which throws the knees outward).
3. Pushing out against, instead of down upon, the shins.

To correct this position, have the pupil stretch both legs out flat on the ground with the feet separated from 20 to 30 inches, depending on the conformation of the man; raise the left knee about 8 inches off the ground; rest the left upper arm along the top of the left shin; place the rifle butt to the right shoulder; regrasp the rifle at the small of the stock; and lower the right elbow and raise the right knee until good contact is made between the right upper arm and right shin. After taking this corrected position, if the pupil's rifle does not point naturally at the target, the coach should require him to shift his feet to the right or left, without otherwise disturbing his position, until the rifle does point naturally at the target.



(c) *Left elbow not under rifle.*—Move the pupil's feet 5 or 6 inches to the right, taking care not to disturb the aim on the target.

*h. Squatting position (fig. 30).*—(1) To take the squatting position, the rifleman stands half-faced to the right with his

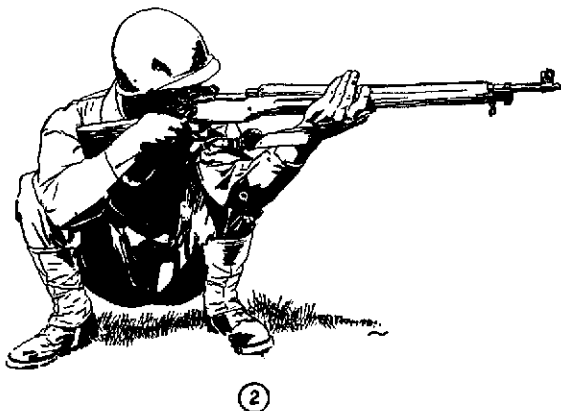

FIGURE 30.—Squatting position.

feet placed 12 inches or more apart. He then squats as low as possible, keeping both feet flat on the ground. The backs of the upper and lower legs should be in the fullest possible contact from the knees downward. The back of the left upper arm rests on the left knee, the elbow being directly under the rifle. The right elbow is braced against the inner part of the right knee. The body should be relaxed, and its weight should be well forward over the left leg. The rifle rests in the crotch of the left hand and is grasped at the small of the stock with the right hand. The face rests against the stock in a manner corresponding to that described for the prone position (e above).

(2) The squatting position is an excellent firing position. It has several features which are advantageous in combat. This position can be assumed quickly; it is inherently steady; and it is particularly desirable when firing in mud, shallow water, snow, or an area contaminated with gas.

(3) Errors most frequently found in taking the squatting position and methods for correcting them are discussed below.

(a) *Contact with ground made only with balls of feet.*—As a result of this error, the rifleman is in an unstable position and will be thrown off balance in firing. The remedy is to force the heels down to the ground and to relax the body and shift the weight well forward over the left leg. Separating the feet more widely helps in setting the heels on the ground.

(b) *Body not relaxed and weight not shifted well forward over left leg.*—This position is unstable. It will cause the rifleman to be thrown off balance as soon as he begins to fire. The rifleman must make a conscious effort to relax—especially in the legs—and shift the weight well forward over the left leg.

i. *Kneeling position (fig. 31).*—(1) The rifleman kneels on the right knee. The right thigh is at a 90° angle with the line of aim. Continuous contact with the ground from the toe to the knee is desirable and can be achieved after a few days of practice. At first, the lack of suppleness may place a strain on the instep. This may be eased by digging a small toe hole in the ground. The rifleman sits so that the center of the right buttock rests directly on the right heel. He then

rotates the right leg about the line knee-toe, so that the heel inclines in the direction of the target. About 60 percent of the body weight is thus shifted forward to the left leg. The right foot and leg are then in a position to provide added support in taking up the recoil of the rifle. The left leg should be vertical when viewed from the front. It need not appear vertical as viewed from the side. Many expert riflemen prefer to draw the left foot back, relaxing the body weight forward so that solid contact is made between the calf and thigh. The left toe may be pointed in the direction which provides maximum comfort for the rifleman. The left upper arm rests on the left knee, the left elbow being in front of and below the knee. The left elbow and left knee should be directly under the rifle. The rifle rests in the crotch of the left hand, as explained for the prone position (e above). The grasp of the rifle by the right hand and the position of the face against the rifle stock and hand are also as described for the prone position. The right elbow is raised to the height of, or slightly below, the shoulder, thus forming a pocket or recess in which to seat the butt of the rifle. If the elbow is held too low, too shallow a pocket is formed. This is a serious disadvantage in sustained fire. The sling adjustment may be the same as that prescribed for the sitting position or it may be shorter, depending on the conformation of the rifleman.

(2) Sitting on the inside of the right foot throws the weight of the body too much to the rear. For this reason, it is not a suitable position for sustained fire. In exceptional cases where the physical conformation of the man indicates unusual difficulty in assuming the prescribed position, and after the instructor has required the pupil to attempt to adapt himself to the normal position, the instructor may authorize the pupil to use this modified position.

(3) The kneeling position is used when brush or high grass would obstruct the view if firing from the sitting, squatting, or prone positions.

(4) Errors most frequently found in taking the kneeling position and the methods for correcting them are listed below.



①

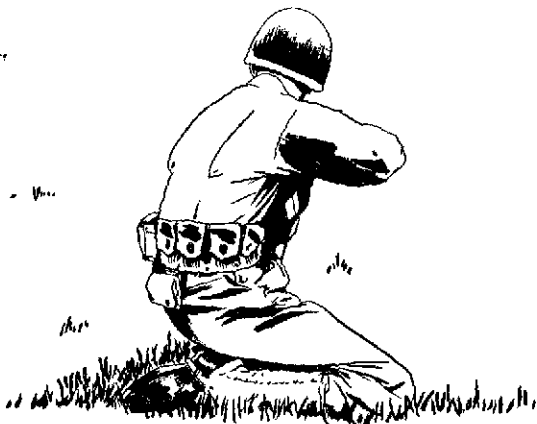

②

FIGURE 31.—Kneeling position.

(a) *Left elbow and knee not under rifle.*—Move left foot to the right.

(b) *Right thigh not at right angle to line of aim.*—Draw the right knee to the rear.

(c) *Point to point contact between left elbow and knee.*—Move the body weight forward, forcing the elbow forward of and below the knee.

j. *Standing position* (fig. 32).—(1) The rifleman stands faced about  $85^\circ$  to the right of the line of aim; feet are placed from 14 to 20 inches apart; body is erect; weight is evenly



FIGURE 31.—Kneeling position—Continued.

distributed on both hips and both feet; head is turned to the left; cheek rests firmly against the stock. Grasp the small of the stock with the right hand, placing the right thumb well around (over) the stock; raise the rifle on the shoulder so that about half of the butt is visible over the shoulder when seen from the rear; raise the right elbow until it makes an angle of  $45^\circ$  or greater above the horizontal and pull back hard with the right hand to keep the butt tightly pressed into the pocket of the shoulder. Without touching the rifle with the left hand, it should now be possible to hold the rifle in an approximate firing position, using only the right arm



①



②

FIGURE 32.—Standing position.

and hand. This method of placing and holding the rifle against the shoulder should be practiced as an exercise before and during the standing position exercise. While the right hand and arm keep the rifle in position, the left hand grasps the rifle well forward of the balance and acts as a slight additional vertical support. The left elbow is approximately under the rifle, the weapon resting in the crotch of the hand, between the thumb and the forefinger, and on the heel of the hand. The hasty sling is used.

(2) An alternate, though less desirable, standing position is called the "body rest" position. The left elbow is placed firmly against the body with the left hand drawn back, even as far as the trigger guard. This position requires more training in order to attain adeptness in firing. It should be used rarely and then only by those riflemen expressly authorized by the instructor.

(3) Errors most frequently found in taking the standing position and the methods for correcting them are listed below.

(a) *Feet placed too far apart.*—Place the feet only as far apart as you would if required to stand for an hour without moving them.

(b) *Weight not evenly placed on both hips.*—Relax the body weight straight down "into the belt."

(c) *Neck craned forward or bent sideward to get cheek on stock.*—Hold the head and neck erect and raise the rifle up to the face. A sling which is too short may be pulling the rifle down. Lengthen the sling enough to permit placing the rifle butt high on the shoulder.

k. *Procedure in conducting position exercises.*—(1) For aiming points, 1,000-inch A targets (rifle) are normally used. These bull's-eyes are placed at a range of 1,000 inches and at different heights so that in aiming from various positions the rifle will be nearly horizontal. Standard known-distance targets may also be used. They are placed at distances used on the known-distance range.

(2) Before taking up position exercises, the instructor assembles his squad or group and—

(a) Shows the proper method of blackening the front and rear sights of the rifle and has each pupil blacken his sights if they are shiny.

(b) Explains and demonstrates the hasty sling adjustment and assists each pupil to adjust his sling. He explains the loop sling adjustment and assists each pupil to adjust his sling.

(c) Explains and demonstrates the proper manner of holding the breath and has each pupil practice it.

(d) Explains the general rules which apply to all positions.

(e) Explains and demonstrates the position which the pupils are to practice next.

(3) Following the explanation and demonstration for each position, the instruction is conducted by the coach-and-pupil method. Each pupil, after seeing that his sights are blackened, adjusts his sling, takes position, holds his breath, and aims carefully. As soon as his aim becomes unsteady, the exercise ceases. After a short rest, the pupil repeats the exercise without further command. The trigger is not squeezed in the position exercises. Exercises are conducted in all positions.

1. *Duties of coach.*—In the position exercises, the coach sees that the—

- (1) Sights are blackened.
- (2) Gun sling is properly adjusted.
- (3) Proper position is taken.
- (4) Breath is held while aiming. (He checks the breathing by watching the back of the pupil.)
- (5) Pupil aims correctly.

■ 43. **THIRD STEP: TRIGGER SQUEEZE.**—*a. Importance.*—(1) The most important item in rifle shooting is to squeeze the trigger in such a way as to fire the rifle without affecting the aim. Misses and poor shots result because the aim is spoiled just before the discharge takes place. This is done by jerking the trigger and flinching. It is important to understand that disalignment of the sights is caused but very slightly by the physical act of jerking the trigger finger. The bigger movement—the one which spoils the aim—is a body movement which occurs before the bullet leaves the barrel. This movement, made in anticipation of the recoil of the rifle, will occur if the rifleman knows in advance when the recoil will come. It is called “flinching.” The trigger



must be squeezed so steadily that the rifleman does not know the instant the rifle will fire. If a man squeezes the trigger so steadily that he does not know when the discharge will take place, he will not spoil his aim by flinching, because he does not know when to flinch.

(2) No good shot attempts to discharge the rifle instantly upon alining his sights on the target. He holds his aim alined as accurately as possible on the target and maintains a steadily increasing pressure upon the trigger until the shot is fired. This method of squeezing the trigger must be carried out in all simulated firing or the value of the practice is lost.

(3) The correct method of squeezing the trigger may be defined as the independent action of the forefinger straight to the rear, with a uniformly increasing pressure (after the slack has been taken up) so that the rifleman does not know the instant the striker will be released.

(4) A mechanical means whereby the rifleman may help himself in squeezing the trigger correctly—in order that he may not know when the striker will be released—is described as “taking up the slack with a heavy initial pressure.” The loose play in the trigger prior to meeting actual resistance is called “slack.” The rifleman takes up the slack with one decisive motion, applying more pressure than just that needed to take up the slack itself. In other words, the rifleman takes up all the loose play and part of the trigger resistance with a heavy initial pressure. Each time the slack is taken up, a slightly different amount of pressure will be applied. The pupil cannot know, nor should he try to know, how much additional pressure is required to release the striker. Therefore, if he continue to squeeze steadily after the slack has been taken up, he will be surprised when the striker is released. Since this process may occasionally cause a shot to be fired almost at once, the rifleman should follow the sequence—

- (a) Hold the breath.
- (b) Complete the sight alinement.
- (c) Take up the slack with a heavy initial pressure.
- (d) Apply the correct squeeze to the remaining resistance.

Then, even if the shot is fired before the rifleman is ready, it will be a good shot because the sight alinement is correct and the rifleman has been surprised in the firing of the round.

(5) The important points in trigger squeeze are:

(a) Pressure is applied with the forefinger only.

(b) After the slack has been taken up, pressure is steady (uniformly increasing) and continuous—once started it is never stopped. However, if the rifleman does not get off the shot within a maximum of 8 or 9 seconds after the slack has been taken up, the pressure should be released. Then the rifleman draws breath and starts all over. In other words, although the squeeze is continuous, it should not be continued indefinitely. The only exception to this rule is in firing from the standing position during a heavy wind which may blow the line of sight off the target. In that case, hold the pressure until the sights are again in the vicinity of the bull's-eye and then apply additional steady pressure.

(c) Pressure must be applied straight to the rear to avoid pulling the sights out of alinement.

(d) The mind must be divorced from the trigger finger. The latter works independently, almost subconsciously, when well trained. Concentrate on maintaining the correct sight picture.

(e) Every shot must be a surprise to the rifleman. If he knows when the striker will be released, he will anticipate the recoil and flinch, no matter how experienced a shot he may be.

(6) The difference between poor marksmen and good marksmen is measured in their ability to squeeze the trigger properly. Any man with fair eyesight and strength can aline the sights on the target and hold them there for an appreciable length of time. When he has acquired sufficient will power and self-control to forget that there is to be an explosion and a shock and squeezes the trigger with a steady increase of pressure until the rifle is fired, he has become a good shot, but not until then. This squeeze of the trigger applies to sustained fire as well as to slow fire. The increase of pressure is faster in sustained fire, but the process is the same.

(7) The impulse to "snap shoot," or to apply sudden, spasmodic pressure to the trigger in order to get off a shot is most evident in the kneeling and standing positions. The natural desire to hit the bull's-eye tempts the riflemen to fire the shot at the instant the sights come into correct alignment. The result is always a bad shot. Men should be taught to accept as natural the unsteadiness (wobble) in these positions. The amount of wobble may be reduced by position exercises but may never be entirely eliminated. Therefore, riflemen should never try to "beat the wobble" by snap shooting. They should squeeze the trigger in the prescribed manner—with a continuous pressure.

*b. Calling the shot.*—(1) The pupil must always notice where the sights are pointed at the instant the rifle is fired and must call out at once where he thinks the bullet will hit. Shots are called even when simulating fire at a target in order to fix the habit and to develop a steady hold. No man can become a good shot until he is able to call his shot before it is marked. Inability to call a shot indicates the rifleman did not know where the sights were pointing at the time the rifle was fired; in other words, he shut his eyes first and fired afterward. Shots are called by assuming the bull's-eye to be a clock face with 12 o'clock at the top of the bull's-eye. Examples of calls are "Center bull," "Bull's-eye at four o'clock," "Just out at nine o'clock" or "A close four at nine o'clock," "Well out at one o'clock" or "A three at one o'clock."

(2) The procedure which will most effectively enable a rifleman to call the shot is known as the "follow-through." Follow-through is continuing to do for a few seconds after the striker has been released exactly what was being done before it was released. In preparatory marksmanship training, a proper follow-through enables a man to detect his position error(s). If he remains in position, continues to hold his breath, continues to look through the sights, and continues to apply pressure to the trigger, he may observe that the sights come to rest somewhere else than directly under the bull's-eye. This is an indication of a muscular relaxation following the release of the striker. This in turn indicates a faulty position which the alert pupil can then correct by shift-

ing his position until the natural aim is under the bull's-eye.

(3) On the range, correct follow-through will help to eliminate such bad habits as a hurried removal of the rifle from the shoulder, drawing the head away from the stock, and similar faults.

*c. Procedure in conducting trigger-squeeze exercises.*—(1) The instructor explains to the assembled squad or group the importance of correct trigger squeeze. He assures himself by questions that each pupil understands what is meant by a "steady increase of pressure." The instructor should require each pupil to squeeze the trigger at least once with the instructor's finger on the trigger and the pupil pressing on the instructor's finger. In this way the instructor can feel whether or not the pupil understands the mechanics of correct trigger squeeze. The instructor explains the necessity for calling the shot.

(2) The pupil is first taught correct trigger squeeze in the prone position. In this position he can hold steadily and is not tempted to *snap* the shot the instant the front sight touches the bull's-eye. After he has learned the principles of correct trigger squeeze in the prone position, he is instructed in the other positions, but during the first half of this period, he is not allowed to squeeze the trigger except in the prone position.

(3) During trigger-squeeze exercise, the pupil must not be allowed to take too long to squeeze off any one shot. The coach should watch for this point and if the pupil does not get off his shot within 8 or 9 seconds of the time the slack has been taken up, the coach should cause the pupil to release his pressure on the trigger, lower his rifle momentarily, then start over.

(4) A great deal of carefully coached trigger-squeeze practice is required. Faulty trigger-squeeze practice is worse than none.

(5) Soldiers should not be allowed to simulate fire until they have been thoroughly instructed in trigger squeeze. In all drills and field exercises where fire is simulated, they should be cautioned to aim at definite objects and to carry out the correct principles of aiming, squeezing the trigger, and calling the shot.

(6) The instruction is conducted by the coach-and-pupil method under the supervision of the instructor. Aiming targets like those mentioned for the position exercises are used, and the exercise is conducted at will in the manner outlined for the position exercises.

*d. Duties of coach.*—In the trigger-squeeze exercises, the coach insures that the—

- (1) Sights are blackened.
- (2) Sling is properly adjusted.
- (3) Proper position is taken.
- (4) Breath is held while aiming. (He checks the breathing by watching the back of the pupil.)
- (5) Pupil aims correctly.
- (6) Slack is taken up decisively in one motion with a heavy initial pressure.
- (7) Trigger is squeezed properly.
- (8) Pupil follows through and calls the shot.
- (9) Pupil is required to stop his squeeze, bring the rifle down and then start over if he fails to get off a shot in 8 or 9 seconds after taking up the slack.

■ 44. **FOURTH STEP: SUSTAINED FIRE.**—*a. General.*—(1) All principles learned in slow fire are applied in sustained fire. It is especially important that the men understand that the method of breathing and the aim and trigger squeeze are the same as in slow fire. Time is gained by taking position rapidly, by working the bolt rapidly and smoothly, and by reloading quickly and without fumbling. Accuracy must never be sacrificed for speed. Sustained fire should be considered as an uninterrupted sequence of slow fire shots delivered without loss of time.

(2) Careful coaching is essential to prevent acquiring the habit of looking into the chamber while working the bolt. The man who looks into the chamber works the bolt slowly. He loses time in finding his own target again and often fires on the wrong target. The application in combat is apparent—the soldier who takes his eye off an indistinct target to look into the chamber while working the bolt may be unable to locate his target again.

*b. Bolt-manipulation exercise.*—(1) *General.*—(a) This exercise is for the purpose of acquiring a smooth and rapid

bolt operation. The magazine floor plate, magazine spring, and follower must be removed from the rifle or the follower must be depressed to prevent it from blocking the bolt. A convenient method of doing the latter is to place an empty cartridge clip edgewise between the follower and the right side of the receiver. Cam surfaces on the bolt should be lubricated to avoid undue wear during the exercise.

(b) Practice in the bolt-manipulation exercise should be held in all positions, and no pupil will be considered proficient until he can operate the bolt at least 20 times in 20 seconds while in the prone position. The first hour of sustained-fire training should be devoted to bolt-manipulation exercises. Thereafter each pupil should be given additional practice from time to time until he is considered proficient.

(2) *Procedure.*—The exercise is conducted by the coach-and-pupil method. The instructor explains and demonstrates that the follower is removed or depressed; that the bolt is jerked fully back and forced home with practically one motion instead of by four distinct motions as men are inclined to do at first; that the elbows and the butt of the rifle remain in place; that the muzzle is allowed to drop down and to the right as the bolt is opened and is returned to the horizontal as the bolt is closed. Emphasis is placed upon the detailed duties of the coach as listed in (3) below. Exercises should not be continued longer than about 20 seconds at a time. Frequent changes of coach and pupil are necessary to prevent undue fatigue. After requiring the pupils to assume a firing position, the instructor commands: 1. BOLT-MANIPULATION EXERCISE, READY. 2. EXERCISE; 3. CEASE FIRING; 4. REST.

(3) *Duties of coach.*—In the bolt-manipulation exercise, the coach insures that—

(a) The bolt is operated properly and rapidly.

(b) The eye is kept on the target.

(c) The right hand is brought to the small of the stock, the rifle to a horizontal position, and the cheek is placed against the stock each time the bolt is closed.

(d) The butt of the rifle is kept against the shoulder.

(e) The elbows are kept in the proper place for the position in which he is performing the exercise.

(f) No attempt is made to aim or press the trigger.

c. *Sustained-fire exercises.*—(1) *First sustained-fire exercise (cadence exercise).*—(a) The most important principle in sustained fire is the development of correct timing in firing. Correct timing in firing will vary from about 10 seconds per shot for the beginner to about 4 seconds per shot for the experienced man. The development of proper timing in firing depends on the correct position of the rifleman. The rifleman's position is not correct unless the sights return automatically to the aiming point after each shot is fired. With the follower depressed or removed, the rifleman then manipulates the bolt, re-aims, concentrating on the sight picture, and instantly begins to squeeze the trigger. This procedure is repeated for each shot.

(b) Before conducting timing (cadence) exercises, the instructor assembles his group and explains and demonstrates—

1. The correct position.
2. The correct method of aiming.
3. The correct bolt operation.
4. The correct trigger squeeze.
5. What is meant by correct timing.
6. How speed in timing is gradually increased, as skill is acquired, until an approximate rate of 6 seconds per shot is attained.

(c) *Procedure.*—Following the above explanation and demonstration by the instructor, cadence exercises, using the coach-and-pupil method, will be given in all positions except standing. The purpose of these exercises is to familiarize the rifleman with the time interval at which sustained fire is delivered.

1. The pupil takes position and aims at a target.
2. The coach takes a position where he can observe the pupil's eye and trigger finger (fig. 33).
3. The instructor (one for each platoon or similar group), with watch in hand, commands: **BOLT** (or **TIME** or uses a whistle signal). Upon the command or signal, each rifleman operates the bolt and then takes up the slack with a heavy initial pressure, continuing the pressure until the firing pin is released. The instructor repeats the

command or signal at 10-second intervals for 1 minute, with approximately 1 minute between exercises. The exercise is conducted in all posi-

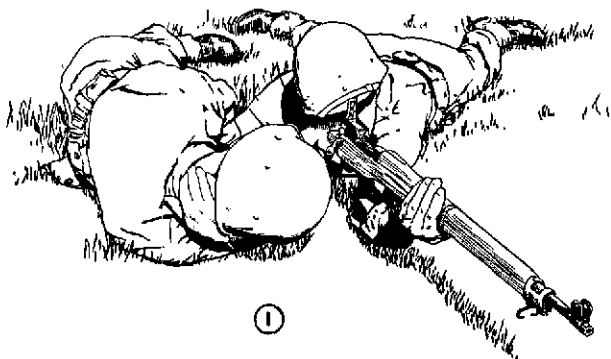

FIGURE 33.—Position of coach.

tions except standing until each pupil is familiar with the 10-second interval. The pupil must be taught not to hurry the trigger squeeze but to squeeze the trigger smoothly.

(d) After proficiency in all positions has been attained with the 10-second time limit, subsequent exercises should



be conducted with a time allowance of 8 seconds. The time should ultimately be reduced to 6 seconds. Cadence exercises should never be given at a faster rate than 6 seconds per shot because of the time required for manipulating the bolt.

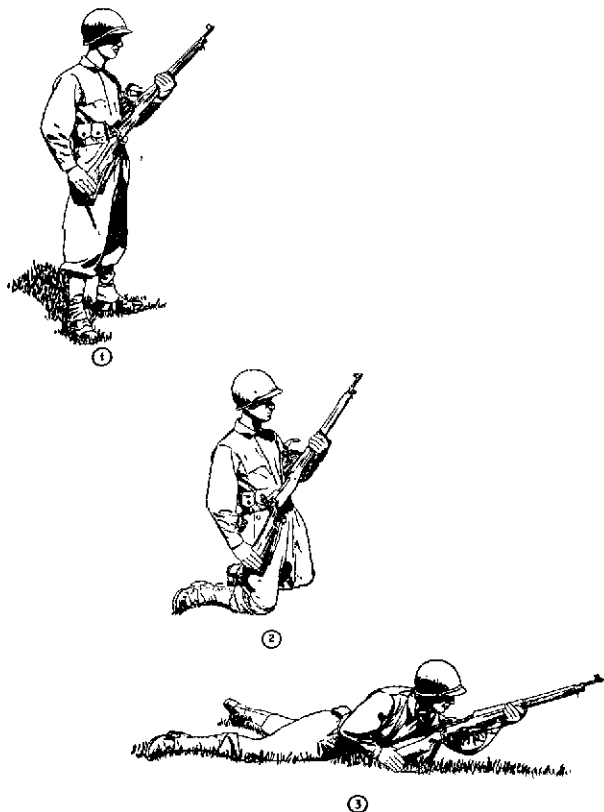

FIGURE 34.—Assuming prone position rapidly.

(e) In order that the pupil will get a precise idea of the time interval, he will manipulate the bolt only upon signal.

(2) *Taking positions rapidly.*—(a) *General.*—At first, the sequence of movements for each position is practiced slowly.

The coach-and-pupil method is used. As proficiency is acquired, speed and accuracy in assuming the positions are obtained. The time required from the beginning of the exercise to the firing of the first round in sustained fire is shown in (4) below.

(b) *Prone position.*—The movement is described by the numbers for the purpose of instruction in the sequence of the

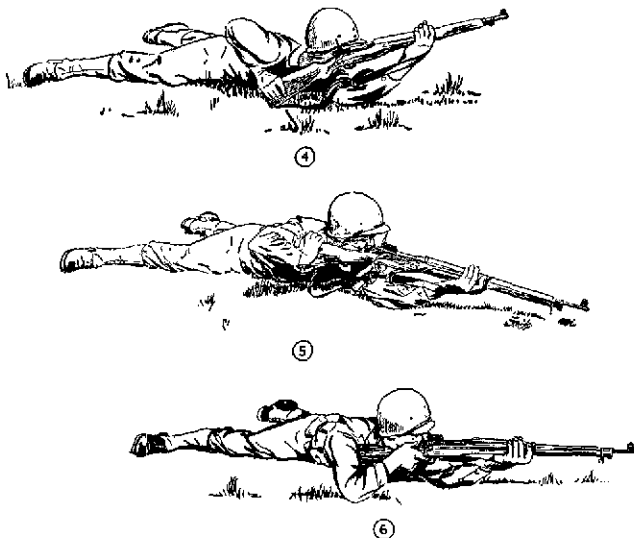

FIGURE 34.—Assuming prone position rapidly—Continued.

movement. After the sequence is learned, the position will be assumed in one continuous motion upon the command **TARGETS UP (COMMENCE FIRING)** or as the target appears. First assume the correct prone position and aim at the target. Mark the places for the elbows and the point on the ground just below the butt of the rifle in the firing position. The pupil rises, first to his knees, then to his feet, keeping his feet in place. The position is then assumed by the numbers in five counts as follows:

1. Being at the READY, with sling adjusted, the left hand just below the lower band swivel and the right hand at the heel of the butt, bend both knees to the ground (fig. 34① and ②).
2. Place the toe of the butt of the rifle on the ground at the point previously marked (fig. 34③).
3. Place the left elbow on the ground in the place previously marked (fig. 34④).
4. Place the butt of the rifle against the right shoulder with the heel of the hand against the butt plate (fig. 34⑤).
5. Grasp the small of the stock with the right hand, place the right elbow on the ground in the place previously marked, and assume the aiming position (fig. 34⑥).

(In the field, a soldier can very quickly, easily, and smoothly assume the prone position after a rush by taking a short jump, landing with feet apart and proceeding in a manner similar to that described above.)

(c) *Sitting position.*

1. To assume the sitting position rapidly, break the fall by placing the right hand on the ground to the rear of the spot upon which the buttocks are to rest.
2. Assume the correct sitting position and aim at the target. Mark and prepare the position for the heels. Mark the spot upon which the buttocks are to rest and then rise, keeping the feet in place. At the command TARGETS UP (COMMENCE FIRING) or as the target appears, sit down on the marked spot, breaking the fall with the right hand; place the left arm in position; with the heel of the right hand on the butt plate, place the butt against the right shoulder; grasp the small of the stock with the right hand and assume the aiming position (fig. 34). The eye is kept on the target throughout the exercise.
3. An alternate method of taking the sitting position rapidly is to take the prescribed sitting position, mark and prepare the places for the heels, then

cross the left leg over the right. Rise, and stand with the legs crossed. Upon command, or when



FIGURE 35.—Assuming sitting position rapidly.

the target appears, bend the knees and sink to the ground, uncross the legs, and place the heels

in the marked places. Place the left arm in position. With the heel of the right hand on the butt plate, place the rifle butt against the right



③



④

FIGURE 35.—Assuming sitting position rapidly—Continued.

shoulder and grasp the small of the stock with the right hand. Assume the aiming position.

(d) *Squatting position.*—Assume the correct position and aim at the target. Rise without moving the feet. Upon

command, or when the target appears, squat into the position; place the left arm in position; with the heel of the right hand on the butt plate, place the rifle butt to the shoulder; grasp the rifle at the small of the stock and aim correctly.

(e) *Kneeling position.*—Assume the correct kneeling position. Mark the position of the left foot and the right knee; prepare the toe hole for the right foot, if required. Rise with the right toe at its marked place and the left foot in its marked place. Upon command, or when the target appears, kneel with the right knee on its marked spot; place the left arm in position; with the heel of the right hand on the butt plate, place the butt to the shoulder; grasp the small of the stock with the right hand and assume the aiming position.

(3) *Duties of coach.*—The coach insures that—

(a) The sights are blackened.

(b) The sling is properly adjusted.

(c) The correct position is taken.

(d) A breath is taken after each shot.

(e) The slack is taken up promptly.

(f) The trigger is squeezed properly.

(g) The bolt is worked rapidly and smoothly.

(h) The eye is kept on the target. The elbows are kept in place, and the butt of the rifle is kept to shoulder while pupil is working bolt.

(4) *Second sustained-fire exercise.*—This exercise combines the cadence exercise ((1) above) with taking positions rapidly. When the rifleman has acquired proficiency in the trigger-squeeze cadence and in taking the positions rapidly, timing exercises are given in all positions. These exercises are conducted with the follower depressed or removed. The exercises are begun with the pupil in the standing position after he has had an opportunity to check his firing position and mark places for his elbows, feet, or knees, depending upon the position to be assumed. The instructor commands: 1. FOUR ROUNDS, SIMULATE LOAD; 2. LOCK; 3. READY ON THE RIGHT; 4. READY ON THE LEFT; 5. READY ON THE FIRING LINE; 6. TARGETS UP (or COMMENCE FIRING). At the announcement, READY ON THE FIRING LINE, rifles are unlocked. At the sixth command (or when the targets are exposed), all rifle-

men take position and simulate firing four rounds. Reloading is simulated, and five more "shots" are squeezed off. The instructor keeps the group informed of the passage of time by announcing "First shot," "Reload," "Fifth shot," "Ninth shot," and "Cease firing." In all sustained-fire positions, 11 seconds are allowed for assuming position and squeezing off the first shot, 11 seconds for reloading and squeezing off the fifth shot, and 6 seconds for each other shot.

### SUSTAINED-FIRE CADENCE

Standing to prone, sitting, or kneeling (nine rounds on preparatory field and range).

No. of shot.....	1	2	3	4	5	6	7	8	9	Time
No. of seconds...	11	17	23	29	40	46	52	58	64	68

(5) *Reloading rifle.*—(a) During reloading in the prone, sitting, and squatting positions, the rifle is held firmly with the left hand, the toe of the butt being placed on the ground. In the sitting and squatting positions, the butt *may* be, and in the kneeling position it *should* be placed on the thigh. The clip is taken from the belt and placed in the slot in the receiver. Loading is completed in accordance with the directions prescribed in paragraph 18. Before the reloading practice is begun, the follower is either replaced or is no longer depressed.

(b) Reloading the rifle without hurried movements and consequent fumbling should be practiced in the prone, sitting, squatting, and kneeling positions, using corrugated dummy cartridges, until the required skill is obtained.

(6) *Third sustained-fire exercise.*—(a) After the pupil is properly trained in timing, taking positions rapidly, and reloading, he is given additional practice in all of these points in the third sustained-fire exercise. The group under instruction is paired off as coach and pupil and is placed on the firing line. Full-sized targets are placed at 200 and 300 yards from the men under instruction, with some simple arrangement permitting the target to be exposed to view for

the prescribed length of time. The exercise may be conducted at shorter ranges, using targets proportionately reduced in size. Sights are set to correspond to the range being used. The commands and procedure are the same as those prescribed for sustained fire on the rifle range except that practice dummy cartridges are used. For example, the pupil stands with sights properly set and blackened, sling adjusted on his arm, clip containing four practice dummy cartridges in his hand, and one full clip of practice dummy cartridges in his belt. When using continuously exposed targets, the instructor, after announcing the range and the position to be used, commands: 1. FOUR ROUNDS, LOAD; 2. LOCK; 3. READY ON THE RIGHT; 4. READY ON THE LEFT; 5. READY ON THE FIRING LINE; 6. TARGETS UP (or COMMENCE FIRING); 7. CEASE FIRING. 8. UNLOAD. 9. CLEAR RIFLES (par. 18*g*). (When using targets which are raised and lowered from pits, the sixth and seventh commands are omitted.) At the fifth command, the rifle is unlocked. At the sixth command (or when the target is exposed), the pupil takes position rapidly and squeezes off four shots. The pupil reloads from the belt with a clip of dummy cartridges and fires five shots. Accuracy must not be sacrificed for speed. Eleven seconds are allowed for assuming the position and squeezing off the first shot, and 11 seconds are allowed to reload and squeeze off the first shot after reloading. For the remaining rounds in any position, 6 seconds are allowed for each shot. Upon completion of the exercise, any dummy cartridges remaining in the rifle are removed, and the bolt is left open. During simulated firing, the pupil should never take his eye from the target except to reload. He should count his shots as he fires in order that he will know when the receiver is empty. The exercise is conducted from the standing position to the prone, sitting, and kneeling positions.

(b) *Duties of coach.*—The duties of the coach in this exercise are the same as those prescribed in (3) above, and in addition he insures that the magazine is reloaded quickly and without fumbling.

■ 45. FIFTH STEP: EFFECT OF WIND; SIGHT CHANGES; USE OF SCORE BOOK.—*a. Wind.*—(1) In firing at 500 yards or under,



the effect of the weather conditions (except that of the wind) on the bullet can be disregarded. The influence of wind must be carefully studied.

(2) The horizontal clock system is used in describing the direction of the wind. The firing point is considered the center of the clock, and the target is at 12 o'clock. A 3 o'clock wind comes directly from the right. A 6 o'clock wind comes straight from the rear. A 9 o'clock wind comes directly from the left.

(3) The velocity of the wind is described in miles per hour. The velocity of the wind may be estimated by throwing up light dry grass, dust, or light paper and watching how fast it travels, or by observing the danger flags. A rule of thumb which will give the approximate wind velocity is: drop some light grass or leaves from the height of the shoulder, then point to the place on the ground where it settles. Divide the number of degrees in the angle between the arm and body by four. The result is the approximate wind velocity in miles per hour. The same rule can be applied, using the smaller angle between the danger flag and flag staff. In general, a light breeze is a 5- to 8-mile wind; a fairly strong breeze is a 10- to 12-mile wind. Wind blowing 20 miles an hour is very strong.

(4) Wind from either side blows the bullet out of its path. For example, if the wind is coming from the right of the rifleman (that is, blowing against the right side of the bullet), the bullet will be blown to the left. The amount the bullet will be blown from its path depends on the force and direction of the wind and on the distance to the target. Correction for this is made by moving the aiming point toward the wind. This process is called "taking the windage." It is accomplished by shifting the body so that the sights of the rifle, instead of pointing at the normal point of aim, are pointed to the right or left of the normal aiming point, depending upon the direction of the wind. The point of impact of the bullet will move in the same direction that the aim is moved. For example, if it is desired to move the hits to the left, the aim must be moved to the left; if it is desired to make the hits strike further to the right, the aim must be moved to the right.

(5) The amount of windage to allow for the first shot can be determined by one of the methods described in (a) and (b) below.

(a) Refer to the windage diagram for the M1903 rifle in the score book and note the value of the wind in points; then extend the vertical mark on the bottom or top edge of the recording target in the score book, corresponding to the value of the wind; draw a light line tangent to the bottom of the bull's-eye across the target; the intersection of these lines is the point of aim for the first shot and for successive shots if the point proves correct.

(b) By the windage rule method (approximately only), the range (expressed in hundreds of yards) multiplied by the velocity of the wind and divided by 10 equals the number of quarter points to allow for a 3 o'clock or 9 o'clock wind.

*Example:* At 500 yards the wind is blowing at 8 miles an hour from 3 o'clock;  $\frac{5 \times 8}{10}$  equals 4 quarter points or 1 point of windage. Refer to the corresponding windage mark on the bottom or top edge of the recording target in the score book for 500 yards; extend this mark up or down the recording sheet; draw a light line tangent to the bottom of the bull's-eye across the sheet; the intersection of these lines is the point of aim on the target for the first shot, and successive shots if the first one is found correct.

(6) If a further correction is necessary after the first shot is fired, it is determined as follows: the shot is plotted on the recording target; from the vertical center line through the bull's-eye the proper correction is noted; and the aiming point for the following shot is shifted in the proper direction by this amount.

(7) As the direction of the wind gets nearer and nearer to 12 or 6 o'clock, the required windage becomes less and less. Winds 1 hour away from 3 and 9 o'clock (2, 4, 8, and 10 o'clock) require only slightly less windage (about  $\frac{9}{10}$ ) than 3 and 9 o'clock winds of equal velocity. For all practical purposes, the same windage can be used. Winds 1 hour away from 12 and 6 o'clock (11, 1, 5, and 7 o'clock) require half as much windage as 3 or 9 o'clock winds of equal velocity.

(8) Winds at either 6 or 12 o'clock require no windage. Strong winds from 12 o'clock tend to retard the bullet a little, and winds from 6 o'clock tend to accelerate it, but the amount is so slight that a correction in elevation is never used at ranges up to 500 yards and is rarely used at greater ranges.

*b. Elevation rule.*—(1) Changing the elevation 100 yards at any range will give a change on the target, in inches, equal to the square of the range (expressed in hundreds of yards). The strike of the bullet will move in the same direction that the peep sight is moved, provided the same aiming point is used.

*Example:* At 200 yards, changing the elevation 100 yards makes a change of 4 inches on the target; at 300 yards, 9 inches; at 500 yards, 25 inches. This rule is not exact but is near enough for all practical purposes.

(2) The horizontal lines in the model targets in the score book also show how much change to make in the elevation at each range. When a change in elevation is necessary, it is best to consult the model target in the score book before deciding how much of a change to make.

*c. Light.*—(1) Light has no effect on the flight of the bullet but does affect the aim. Changes in light have very slight effect on most riflemen. The correction for variations in light does not exceed 25 yards in elevation at any range. Changes in light do not affect uniformly the aim of all riflemen.

(2) Usually men unconsciously aim a little lower in a poor light than in good light and consequently need more elevation when the light is poor. This lowering of the aim results from the fact that the outline of the bull's-eye is not distinct in a poor light. As a rule, poor light exists on dark days when there is a haze in the air; on very bright, warm days when there is a decided mirage; and when the sun is behind the target. The best conditions for shooting prevail when the sky is uniformly overcast and there is sufficient light to see the target clearly.

(3) Sunlight from one side has the same effect with most men as wind from that side. This is because the side of the front sight toward the sun is more clearly defined and is unconsciously held under the center of the bull's-eye. Such

holding places the bullet toward the opposite side of the bull's-eye from the sun. When it is necessary to make allowance for this, the aiming point is moved toward the sun.

*d. Zero of a rifle.*—(1) The zero of a rifle for each range is the elevation to be set on the rear sight, and the point on the target on which the sights must be alined in order to hit the center of the bull's-eye on a normal day when there is no wind. This zero may not conform to the marks on the scale of the sight leaf and the alinement of the sights on the rifle. The zero of any rifle may differ with different men, due to the difference in their hold or manner of aim.

(2) Each man must determine the zero of his own rifle for each range (par. 53*b*). He does this by studying the data which he has written in his score book concerning elevation settings on the rear sight, aiming points, changes in sight settings and aiming points, light, and the direction and velocity of the wind. The zero of a rifle is best determined on a day when the sky is overcast and there is no wind. Having learned the zero of his rifle, the rifleman computes his elevation for the first shot from this zero and not from the zero marked on the rifle sight unless the two correspond. Likewise, he determines his aiming point from the zero aiming point and not from the normal six o'clock aiming point, unless the two correspond.

(3) Where rifles are not available and where it is desired to conduct exercises in zeroing the rifle, the reverse side of the sighting device (fig. 20②) can be used.

*e. Shooting up or down hill.*—In shooting either up or down hill, less elevation is required than when shooting on level ground. The steeper the hill, the less elevation is required, so that when firing vertically up or down no elevation at all is required, no matter how distant the target. Slight slopes that may be found on target ranges have no appreciable effect upon the elevation used and require no correction.

*f. Sight-setting and sight-changing exercises.*—In these exercises, the instructor uses the full-sized A, B, and D targets with spotters to indicate the position of the hits.

(1) *Procedure.*—The instructor assembles his squad or group (each pupil having his rifle, score book, and pencil) and conducts the exercise as follows:

(a) Points out the graduations on the sight leaf and explains that the line directly opposite the number represents the range; points out the index lines on the slide and explains that in setting the sight for any range these lines must coincide with the graduations for that range on the sight leaf, and that to retain the slide in adjustment the slide catch must be engaged with the proper notch on the edge of the sight leaf.

(b) Explains the effect of wind and cautions the class to disregard all atmospheric influences except wind.

(c) Explains the windage diagram in the score book.

(d) Reads and explains the windage rule and elevation rule. By asking questions, he assures himself that these rules are understood.

(e) Explains the purpose of the vertical lines on the model targets in the score book and assures himself that each man understands the use of this diagram.

(f) Shows the pupils how to draw the windage lines for each range on the blank targets of the score book.

(g) The above points having been explained to the assembled group, the pupils are placed in pairs. The instructor tests their ability to set the sights for the first shot by using the windage rule (or diagram). Every time the sights are set, each pupil examines the sight of the man paired with him. If called upon, the pupil tells the instructor the sight setting that was used.

(h) The instructor tests the ability of his pupils to change sights intelligently after the first shot by referring to the model target.

(i) Where rifles are not available and where a quick review of the pupil's knowledge of sight setting is desired, the reverse side of the sighting device (fig. 20②) may be used.

(2) *Sight-setting exercises.*—Examples of sight-setting exercises as given by the instructor will be as follows:

(a) "You are at 500 yards and estimate the wind to be 8 miles an hour from 3 o'clock. Plot on the recording target in your score book the aiming point for the first shot. Jones, where has Smith placed his aiming point? Each man whose teammate did not place his aiming point to the right of the bull's-eye at the intersection of a horizontal line drawn tangent to the bottom of the bull's-eye and the verti-

cal line indicating 1 point windage, hold up his hand." The instructor, by questions, explanations, and illustrations assists the men who have made mistakes.

(b) "You are at 300 yards and estimate the wind to be 7 miles an hour from 9 o'clock. Plot your aiming point on the recording target in your score book for the first shot. Suppose you fired and the spotter marked the hit here (placing a spotter in the 4 space near the bull's-eye at 3 o'clock) and you were sure your hold and trigger squeeze were good; plot your aiming point to bring the next shot in the vertical center line of the bull's-eye. Johnson, where has Williams plotted his aiming point? Each man whose teammate has not changed his aiming point for the next shot to the left on the 1 point line, hold up his hand." The instructor assists those men who have decided errors by further explanation and illustrations.

(3) *Windage and elevation.*—(a) The instructor gives a number of examples, with the wind at different angles and velocities and at various ranges, until the class thoroughly understands the methods of determining the amount of windage to take for the first shot and corrections, if necessary, in aiming points for subsequent shots.

(b) Following the instruction in taking windage, the instructor puts the class through similar exercises which require changes in elevation.

(c) The instructor gives a number of examples which require changes in both windage and elevation until the principles of sight changing are well understood by the class.

(d) Then the instructor assumes the zero of the rifles to be different from the normal both as to windage and elevation and repeats the exercises.

(4) *Additional sight-setting exercises.*—Additional examples of sight-setting exercises as given by the instructor are as follows:

(a) "Set your sight at 550 yards and place your aiming point on the 1 point left windage line. Suppose you fire four shots hitting here (placing four spotters in the bull's-eye), and your fifth shot goes here (placing spotter on 3 space at 11 o'clock). Edwards, what are you going to do now? Phippen, what are you going to do? You should not

do anything to the sight. It is practically certain that in firing the fifth shot you squeezed the trigger improperly and flinched. Not even a very sudden and violent change in the weather or light could cause that much difference. Don't try to correct your own faults by changing the sights.

(b) "For your first score in sustained fire at 200 yards you have set your sight at the same elevation and have taken the same windage that you used in slow fire. Suppose this to be 200 yards in elevation and your group goes here (putting nine spotters low and to the left). Set your sight to bring the next score into the figure. Miller, what does Wright's sight read? Where is his aiming point?"

(5) *Variations in sight setting.*—A shot group in sustained fire should strike in the same place as a shot group in slow fire. A sustained-fire shot group that varies in position from a slow-fire shot group is the result of faulty position or aim. If there is a constant variation in the two sight settings, the rifleman should note it in his score book and, using an aiming point, set his sight in sustained fire so as to make the group count as much as possible. Shots scattered all over the target cannot be corrected by changing the sight or aiming point.

*g. Use of score book.*—(1) Each man must keep a score book in which he records not only the value of the hits but the location of each hit, the sight setting and sight changes, the force and direction of wind, the kind of light, the hour, the date, and such other data as may be of use in the future. Spaces for these notes are provided on the score sheets of the score book.

(2) The use of the score book on the range is important for the following reasons:

(a) The plotting of the shots shows the rifleman the location of his group.

(b) The windage diagram indicates the windage for the first shot. The model target shows by means of vertical lines the change in aiming point (windage) necessary to place the group in the center of the target. By referring to "Model Dimensions to Scale of A, B, and D Targets" on page 13, W. D., A. G. O. Form No. 82 (1942) (Combination Score Book) and applying the elevation rule, the change

in elevation necessary to place the group in the center of the target may be computed.

(c) Plotting the shots and recording the data as to light and wind help the soldier to learn the zero of his rifle.

(d) The data respecting sight settings and aiming points used for various ranges and weather conditions are of great assistance in setting the sight correctly and determining the aiming point for subsequent firing. Where a number of scores have been fired and recorded, the rifleman should get his sight setting and aiming point from previous scores fired on days that were similar as to light and wind.

(3) The score book will be kept personally by the man firing. The coach assists him when necessary to decide what to write down, but the coach will not plot the shots or enter any data.

*h. Score-book exercises.*—The squad or larger group is assembled in front of a full-sized B target, each man with score book, pencil, and rifle. The class is divided into pairs. Each man acts as coach for the other man of his pair.

(1) The instructor states the light and weather conditions and the range. He then indicates eight successive shots on the target by means of a spotter and requires each man to plot each shot as it is indicated, to write down the data given from time to time, to make the actual sight settings and corrections on his rifle, and to plot the aiming point on the recording target. Where rifles are not available, the reverse side of the sighting device (fig. 20②) may be used. Weather and light conditions assumed by the instructor and changes announced during the exercise should be such as are likely to occur on the rifle range.

(2) The pupils are told by the instructor to open their score books at the first blank page and plot the shots and write in the data as given to them. They are instructed to write lightly so that erasures may be made, allowing the same page to be used repeatedly. The example as given by the instructor will be substantially as follows:

(a) "You are at 500 yards on the rifle range. You are getting ready to fire a slow-fire score. There is bright sunlight. The wind varies from 8 to 12 miles an hour in velocity and from 1 to 3 o'clock in direction. When you are in posi-



tion ready to fire the first shot, the wind seems steady at 3 o'clock and is blowing about 8 miles an hour. Write in your data, set your sight, and plot your aiming point. Jones, where has Robinson set his sight and where has he plotted his aiming point? Anderson, where has Farrell set his sight? The windage called for is 1 point right, therefore, the aiming point should be to the right of the bottom of the bull's-eye at the 1 point windage line.

(b) "You fire your first shot, and the spotter marks it here (putting spotter a close 4 at 7 o'clock). Decide what you are going to do; then set your sight and plot your aiming point. Dodd, what does McLean's sight read? You should not change your sight nor your aiming point until you get two shots near each other, both fired with the same sight setting and aiming point. Using the same setting and aiming point, you fire a second shot.

(c) "Your second shot goes here (spotter a close 4 at 7 o'clock). Now, Anderson, what change will you make? Since the strike of the bullet was about 5 inches to the left and 11 inches below the center of the bull's-eye, corrections should be made in elevation and aiming point for the next shot. The elevation on the sights should be raised to 600 yards, and the aiming point should be shifted to the right  $\frac{1}{4}$  point and lowered 10 inches. Hence the new aiming point will be at the intersection of the  $1\frac{1}{4}$  point right windage line and the lower 75-yard elevation (horizontal) line." The instructor explains the reason for raising the sights 100 yards and lowering the aiming point approximately 10 inches, to the 75-yard elevation line. He points out that this procedure is better than not raising the elevation on the sight and raising the aiming point the required 10 inches, because raising the aiming point would partially obscure the bull's-eye, and since the bull's-eye is used as the main reference object in aiming, corrections in elevation should be made by using a combination change in the sight setting and the aiming point so that all of the bull's-eye is always visible.

(d) "Your third shot hit here (spotter in bull's-eye near the top); your fourth shot hit here (spotter in bull's-eye near the bottom); your fifth shot hit here (close 4 at 9 o'clock). The wind seems to be a little stronger, but you are not sure. Your

aim was correct. Havens, what are you going to do? Half the correction indicated by the windage lines on the recording target of the score book is correct. Plot your hit and change your aiming point accordingly. The recording target indicates full correction requires  $\frac{1}{2}$  point right. Half correction would be  $\frac{1}{4}$  point right. Therefore, the aiming point for the next shot should be moved to the right to the  $1\frac{1}{2}$  point windage line, that is, you are now using  $1\frac{1}{2}$  point right windage. Your sixth shot hits here (a bull's-eye near the edge at 3 o'clock). Dillon, what are you going to do now? It appears that the fourth and fifth shots were caused by faulty trigger squeeze, so change your aiming point back to where it was before (the intersection of the  $1\frac{1}{4}$  point right line and the lower 75-yard elevation line).

(e) "Before you fire your seventh shot you notice that the wind has shifted to about 1 o'clock but is still blowing at the same velocity (8 miles an hour). Dorsett, where is Miller's aiming point now? Huntley, what does the book say about a 1 o'clock wind? You need only about half as much windage as for a 3 o'clock wind. Your aiming point should therefore be moved to the left on the  $\frac{3}{4}$  point right windage line. Place it there.

(f) "Your next shot goes here (a low 4 at 6 o'clock). Fell-din, what correction has West made for his eight shot? You should have made no change in your sight. Your windage is apparently correct, and there has been no change in conditions. Your low shot was the result of a poor aim or poor trigger squeeze. Do not try to correct your personal errors by moving the sight around. Your eighth and last shot goes here (bull's-eye). Write in your notes and exchange books with your teammate. Allard, has Kirton plotted all the shots correctly? Read the notes he has written in his book. What does he have as his zero aiming point (windage)? The zero aiming point (windage) should be to the right of the bull's-eye on the  $\frac{1}{4}$  point vertical line. Everyone should note carefully how this was obtained. The aiming point (windage) for the final shots which hit the center of the bull's-eye was on the  $\frac{3}{4}$  point vertical line to the right of the bull's-eye. However, there was a wind of 8 miles an hour from 1 o'clock, or a wind equal to  $\frac{1}{2}$  point of right windage. Since the zero

aiming point (windage) is that setting used when there is no wind blowing, you should deduct the value of the wind. Therefore,  $\frac{1}{2}$  from  $\frac{3}{4}$  equal  $\frac{1}{4}$  point right windage. Since no further changes in elevation were required after the sight was set at 600 yards, the zero aiming point (elevation) is on the lower 75-yard elevation (horizontal) line. Hence, the zero aiming point is at the intersection of this line with the  $\frac{1}{4}$  point right windage line."

■ 46. SIXTH STEP: EXAMINATION OF MEN BEFORE STARTING RANGE PRACTICE.—*a.* (1) *Time required.*—These examinations should not require an excessive amount of time. If each step of the instruction in the preparatory marksmanship training has been presented carefully and thoroughly, all men should be well qualified by the time the examination is held. Progress charts based on preliminary examinations should have been kept on each man as prescribed in paragraph 39*f*.

(2) *Time of holding examination.*—The examination should be held sufficiently in advance of range practice to permit additional instruction to be given to those men who are found unsatisfactory in any phase of training.

(3) *Preparation.*—The questions and answers covering the preparatory training (*b* below) should serve as a guide to instructors while conducting this examination. The examination outlined by these questions and answers should supplement rather than take the place of practical tests in the various phases of instruction. All required equipment should be assembled and set up prior to the time of examination.

(4) *Plan of conducting examination.*—The following is an efficient plan for conducting the examination covering each step of preparatory marksmanship training (fig. 36).

(*a*) Designate eight to twelve qualified noncommissioned officers to act as examiners. (Personnel of several platoons may be combined in this selection.)

(*b*) Lay out stations to cover examinations in—

1. Sighting and aiming.
2. Positions (one station for each type of firing position).

3. Trigger squeeze.
4. Sustained fire.
5. Sight changes.
6. Wind estimation and windage correction.
7. Use of score book.

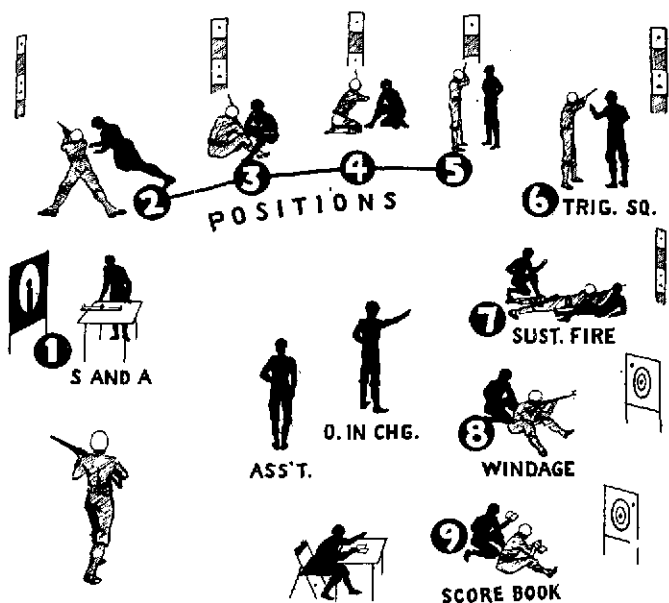

FIGURE 36.—Schematic lay-out for examination prior to range practice (squatting position not shown).

(c) Assign examiners to each station to insure prompt and thorough examinations.

(5) *Supervision.*—The platoon leaders move from station to station and by pertinent questioning assure themselves that examinations are conducted as prescribed. Names of men who are found to be deficient in any phase of instruction are noted by the examiners on a slip of paper. The names are turned over to the platoon leader, who arranges for the necessary additional training.

b. *Questions and answers.*—The answers given to questions are merely examples. Men should be required to explain in their own words.

(1) *Care and cleaning.*

Q. What three things do you do in cleaning the bore of a rifle after it has been fired? A. I first remove the primer fouling from the bore. I then dry the bore thoroughly. After this is done, I protect the bore from rust with a thin coating of light preservative lubricating oil.

Q. How do you remove the primer fouling from the bore? A. By swabbing the bore thoroughly with rifle-bore cleaner. If this is not available, I use hot soapy water or plain hot water.

Q. How do you dry the bore? A. By running clean patches through the bore until it is thoroughly dry.

Q. How do you protect the bore from rust? A. By swabbing it thoroughly with a cleaning patch saturated with light preservative lubricating oil issued for this purpose.

(2) *Sighting and aiming.*

Q. What is this (drawing a circle on the ground or on paper)? A. A circle.

Q. Where is the center of it? A. Here (pointing to the center).

Q. Suppose that circle represents a peep sight through which you are looking and that you are told to bring the top of the front sight to the center of it; where would the top of the front sight be? A. Here (pointing to the center of the circle).

Q. Make a mark in the circle to represent the front sight. Make a small circle to represent the bull's-eye. Is the bull's-eye in the center of the peep sight? A. No, the bottom edge of it is in the center.

Q. Why? A. Because the top of the front sight is in the center and just touches the bottom edge of the bull's-eye.

Q. Should the front sight be held up into the bottom of the bull's-eye? A. No, it just touches the bottom edge of the bull's-eye so that all of the bull's-eye can still be clearly seen.

Q. What is this (indicating sighting bar)? A. Sighting bar.

Q. What is it for? A. To teach me how to aim.

Q. Why is it better than a rifle for this purpose? A. Because the sights on it are much larger and because slight errors can be more easily seen and pointed out.

Q. What does this represent? A. The front sight.

Q. And this? A. The rear sight.

Q. What is this? A. The eyepiece.

Q. What is the eyepiece for? A. To cause me to place my eye in such a position as to see the sights in the same alignment as that seen by the coach.

Q. Is there any eyepiece on the rifle? A. No, I learn by the sighting bar how the sights look when properly aligned, and I must hold my head so as to see the sights the same way when aiming a rifle.

Q. How do you hold your head steadily in this position when aiming a rifle? A. By resting my cheek firmly against the side of the stock and on top of the thumb.

Q. Where do you focus your eye when aiming a rifle? A. First focus on the target and then on top of the front sight to be sure that I see the front sight sharply defined and properly centered in the peep sight.

Q. Tell me what is wrong with these sights. (The instructor now adjusts the sights of the bar, making various slight errors. He requires the men to point out any errors. Then with the sights properly aligned on the small bull's-eye, he demonstrates the correct adjustment.)

Q. Now take this sighting bar and adjust the sights properly. (Verified by the instructor.)

Q. Now that the sights are properly adjusted, move the small bull's-eye until the sights are properly aimed. (Verified by the instructor.)

Q. How do you hold your breath while aiming? A. I draw in an ordinary breath, let out a little of it, and hold the rest by closing my throat. I do not tighten the muscles of my diaphragm. I hold this breath throughout the time during which I am squeezing the trigger. During sustained fire, I breathe *after* each shot.

### (3) Positions.

Q. Take the prone position, aim, and simulate firing a shot at that mark. (The instructor must assure himself that the

man knows how to hold his breath properly while aiming. Many men have great difficulty in learning to do this correctly.)

Q. Take this rifle and show me your standing, kneeling, squatting, sitting, and prone positions.

Q. Now show me how you take the sitting and prone positions rapidly from standing position.

(4) *Trigger squeeze.*

Q. How do you squeeze the trigger? A. I take up the slack with a heavy initial pressure. Then I squeeze the trigger with such a steady increase of pressure that I do not know just when the rifle will go off.

Q. What do you concentrate on while you are squeezing the trigger? A. I concentrate on keeping a perfect sight alinement.

Q. Is it necessary to take a long time to press the trigger in this way? A. No. The method of squeezing the trigger is slow at first but rapidity is developed by practice.

Q. How do you squeeze the trigger in sustained fire? A. I squeeze it the same way as in slow fire, with such a steady increase of pressure as not to know when the rifle will fire.

(5) *Sustained fire.*

Q. In sustained fire how do you gain time so as not to be compelled to hurry in aiming and squeezing the trigger? A. I gain time by taking position rapidly and by keeping my eye on the target.

Q. How does keeping your eye on the target help you to gain time? A. A man who looks away from his target loses time in finding his own target again.

Q. Now, show me how you load a clip of ammunition into the receiver.

Q. Is it important to get into the correct position before beginning to shoot in sustained fire? A. Yes, even though it takes more time, I should always get into the correct position before beginning to fire.

Q. Which is more important in sustained fire, speed or accuracy? Explain. A. Accuracy. A few accurate shots are better than many scattered ones.

(6) *Calling the shot.*

Q. What is meant by "calling the shot"? A. To say where you think the bullet hit as soon as you shoot, and before the shot is marked.

Q. How can you do this? A. By noticing exactly where the sights point when the rifle is fired.

Q. If a man cannot call his shot properly, what does it usually indicate? A. That he did not squeeze the trigger properly and did not know where the sights pointed at the time the rifle was fired.

(7) *Score book.*

Q. What is this? A. A score book.

Q. What is the purpose of these lines (indicating the vertical lines on the model target)? A. To show the amount of change in windage necessary to bring the shot to the middle line.

Q. If a shot hits here (indicating), what change in your sight would you make to bring the next shot to the center of the bull's-eye?

Q. What effect does changing your aiming point to the right or left have on the shot? A. It moves the shot in the same direction in which the aiming point is moved.

Q. If you want to make a shot hit higher, what do you do? A. I increase my elevation.

Q. If you want to make your shots hit more to the right, what do you do? A. I move my aiming point to the right.

Q. I will place this spotter on this target (full-size 500-yard target) to represent a shot properly fired by you at 500 yards with zero windage and sight set at 500 yards. Move your sight and aiming point to bring the next shot to the center of the bull's-eye. (Instructor now tests in various ways the man's ability to make proper sight corrections.)

Q. What are the three principal uses of the score book? A. To show me where my shot group is located, to indicate how much change in elevation and windage (aiming point) is necessary to move a shot or group of shots to the center of the target, and to make a record of the sight settings and aiming points of my rifle for the different ranges under various weather conditions so that I will know where to set my



sight when starting to shoot at each range under different weather conditions.

Q. Tell me what effect different light and weather conditions have on a man's shooting.

Q. In firing at ranges up to and including 500 yards, what is the most important weather condition for which you make sight corrections? A. Wind.

### SECTION III

#### QUALIFICATION COURSES

■ 47. GENERAL.—*a.* See AR 775-10 for information pertaining to who will fire the several courses, individual qualification, ammunition allowances, and similar matters.

*b.* The amount of instruction practice is not limited to that prescribed in the tables below. Such additional practice as time and ammunition allowance permit may be given. No rifleman shall be permitted to fire instruction practice sustained fire until he has demonstrated proficiency in slow fire.

*c.* Although the 1,000-inch range does not appear in the tables of courses A, B, or C, it can be used to great advantage during instruction practice. When time or personnel are limited, the 1,000-inch range should be used for the initial phase of instruction practice. At this range, the soldier becomes accustomed to the noise and recoil of the rifle as he perfects his positions. The necessity for correct trigger squeeze is made obvious. Having zeroed his rifle at 1,000 inches, he can use this zero as a basis for zeroing his rifle at the longer ranges. Many men find no difference between the 1,000-inch zero and the 200-yard zero. In short, the rifleman can learn all basic elements of marksmanship by firing at 1,000 inches. Pit details and telephone operators are eliminated, and because each hit is visible, the time usually spent in target operation is saved.

*d.* Ammunition should be reserved to permit every man to zero his rifle, preferably at 300 yards, with bayonet or grenade launcher attached. (See par. 53b(3).) This zeroing should follow record practice and precede transition firing.

■ 48. COURSE A.—*a. Instruction practice.*—The instruction practice outlined in tables I, II, and III below is designed to serve as a guide only. Under reduced ammunition allowances, the number of shots shown in parentheses may be fired.

TABLE I.—*Slow fire*

Range (yards)	Time	Shots	Target	Position	Sling
200	No limit	4 (4)	A	Prone (sandbag optional)	Loop.
200	do	8 (4)	A	Prone	Do.
300	do	4 (4)	A	Prone (sandbag optional)	Do.
300	do	8 (4)	A	Prone	Do.
500	do	4 (4)	B	Prone (sandbag optional)	Do.
500	do	8 (4)	B	Prone	Do.

TABLE II.—*Slow fire*

Range (yards)	Time	Shots	Target	Position	Sling
200	No limit	8 (0)	A	Sitting	Loop.
200	do	8 (0)	A	Squatting	Do.
200	do	8 (8)	A	Kneeling	Do.
200	do	8 (8)	A	Standing	Hasty.
300	do	8 (4)	A	Sitting	Loop.
300	do	8 (4)	A	Squatting	Do.
300	do	8 (0)	A	Kneeling	Do.

TABLE III.—*Sustained fire*

Range (yards)	Time (seconds)	Shots	Target	Position	Sling
200 <sup>1</sup>	36	3 (2 3)	D	Kneeling or sitting from standing.	Loop.
200	68	3 (2 3)	D	do	Do.
300 <sup>1</sup>	36	3 (2 3)	D	Prone from standing.	Do.
300	68	3 (2 3)	D	do	Do.

<sup>1</sup> Fire twice.

<sup>2</sup> The rifle is to be loaded with one round initially and reloaded from a full clip, only two rounds of which are to be fired.

<sup>3</sup> The rifle is to be loaded with four rounds initially and reloaded from a full clip.

## b. Record practice.

TABLE IV.—*Slow fire*

Range (yards)	Time	Shots	Target	Position	Sling
200	No limit	4	A	Kneeling	Loop.
200	do.	4	A	Standing	Hasty.
300	do.	4	A	Prone	Loop.
300	do.	4	A	Sitting or squatting	Do.
500	do.	8	B	Prone	Do.

TABLE V.—*Sustained fire*

Range (yards)	Time (seconds)	Shots	Target	Position	Sling
200	68	19	D	Kneeling or sitting from standing.	Loop.
300	68	19	D	Prone from standing	Do.

<sup>1</sup> The rifle is to be loaded with four rounds initially and reloaded from a full clip.

c. *Classification and minimum aggregate scores.*—Individual classification and minimum aggregate scores required for qualification in marksmanship for each individual authorized or required to complete record practice, course A, are as follows:

Expert rifleman	180
Sharpshooter	165
Marksman	140

d. *Transition firing.*—This practice is conducted on a field-firing range according to the procedure explained below. (For additional details concerning scope and method of conducting this training, see paragraph 167.) Tables VI and VII will be fired after record practice and prior to firing combat exercises. The exercises should be preceded by instruction in range estimation (see sec. II, ch. 5). To develop speed and facility in sight setting and other movements required by this firing, preparatory exercises should be devised to precede actual firing.

TABLE VI

Range (yards)	Time (seconds)	Shots	Target <sup>1</sup>	Position	Sling
200	60	5	3 E.....	Kneeling or sitting from standing.	Loop.
300	60	5	do.....	Prone from standing.....	Do.
500	60	5	do.....	do.....	Do.

<sup>1</sup> Targets should be approximately 5 yards apart and as near the prescribed range as the terrain permits.

TABLE VII

Range <sup>1</sup> (yards)	Time (seconds)	Shots	Target	Position	Sling
	120	10	6 E.....	Prone from standing.....	Loop.

<sup>1</sup> Two targets between ranges of 200 and 300 yards, 2 targets between 300 and 400 yards, and 2 between 400 and 500 yards. Each pair of targets will be staggered and separated in depth from 25 to 50 yards.

(1) Targets are fastened to staves and are operated by men protected in individual pits.

(2) Targets are exposed on signal of the officer in charge of firing and are withdrawn individually when hit. No marking of targets is required, since a hit is scored when the target is withdrawn. Ricochets are counted as hits.

e. The following method of scoring will be used:

(1) *Table VI.*

For each target hit..... 1 point.

For each unexpended round, if all targets are hit..... 1 point.

(2) *Table VII.*

For each target hit:

Between 200 and 300 yards..... 1 point.

Between 300 and 400 yards..... 2 points.

Between 400 and 500 yards..... 3 points.

For each unexpended round, if all targets are hit..... 3 points.

f. Only one person will be assigned to a group of targets in each order. Prior to the start of the exercise, the rifleman may adjust the sling on his arm. The coach will set the rifleman's sights off in elevation sufficient to require an adjustment of sights. When all is ready, the officer in charge of firing commands: **LOAD**. When targets appear, the rifleman will assume the prescribed position and adjust his sights before opening fire.

g. Each rifleman will fire tables VI and VII. Within prescribed ammunition allowances for qualification in arms, each rifleman will re-fire table VII until he fires a satisfactory score. The satisfactory score is eight.

■ 49. **COURSE B.**—*a. Instruction practice.*—The instruction practice outlined in tables I, II, and III below is designed to serve as a guide only. Under reduced ammunition allowances, the number of shots shown in parentheses may be fired.

TABLE I.—*Slow fire*

Range (yards)	Time	Shots	Target	Position	Sling
200.....	No limit..	4 (4)	A.....	Prone (sandbag optional).....	Loop.
200.....	do.....	12 (8)	A.....	Prone.....	Do.
300.....	do.....	4 (4)	A.....	Prone (sandbag optional).....	Do.
300.....	do.....	16 (8)	A.....	Prone.....	Do.

TABLE II.—*Slow fire*

Same as table II, course A (par. 48).

TABLE III.—*Sustained fire*

Same as table III, course A (par. 48).

*b. Record practice.*

TABLE IV.—*Slow fire*

Range (yards)	Time	Shots	Target	Position	Sling
200.....	No limit..	6	A.....	Kneeling.....	Loop.
200.....	do.....	6	A.....	Standing.....	Hasty.
300.....	do.....	6	A.....	Prone.....	Loop.
300.....	do.....	6	A.....	Sitting or squatting.....	Do.

TABLE V.—*Sustained fire*

Same as table V, course A (par. 48).

c. *Classification and minimum aggregate scores.*—Individual classification and minimum aggregate scores required for qualification in marksmanship for each rifleman authorized or required to complete record practice, course B, are as follows:

Expert rifleman.....	180
Sharpshooter.....	165
Marksman.....	140

d. *Transition firing.*—Same as for course A (par. 48).

■ 50. COURSE C.—a. *Instruction practice.*

TABLE I.—*Slow fire (fired twice)*

Range (yards)	Time	Shots	Target	Position	Sling
200.....	No limit.....	4	A.....	Prone (sandbag optional).....	Loop.
200.....	do.....	4	A.....	Prone.....	Do.
200.....	do.....	4	A.....	Sitting.....	Do.
200.....	do.....	4	A.....	Squatting.....	Do.
200.....	do.....	4	A.....	Kneeling.....	Do.
200.....	do.....	4	A.....	Standing.....	Hasty.

TABLE II.—*Sustained fire (fired twice)*

Range (yards)	Time (seconds)	Shots	Target	Position	Sling
200.....	36	3	D.....	Prone from standing.....	Loop.
200.....	36	3	D.....	Sitting from standing.....	Do.
200.....	36	3	D.....	Kneeling or squatting from standing.	Do.

<sup>1</sup> Rifle is loaded with one round. After the first round is fired, the rifle is to be reloaded from a full clip, only two rounds of which are to be fired.

TABLE III.—*Sustained fire*

Range (yards)	Time (seconds)	Shots	Target	Position	Sling
200 .....	68	19	D.....	Sitting from standing.....	Loop.
200 .....	68	19	D.....	Kneeling or squatting from standing.	Do.
200 .....	68	19	D.....	Prone from standing.....	Do.

<sup>1</sup> The rifle is to be loaded with four rounds initially and reloaded from a full clip.

*b. Record practice.*

TABLE IV.—*Slow fire*

Range (yards)	Time	Shots	Target	Position	Sling
200 .....	No limit..	4	A.....	Sitting or squatting <sup>1</sup> .....	Loop.
200 .....	do.....	4	A.....	Kneeling or squatting <sup>1</sup> .....	Do.
200 .....	do.....	4	A.....	Standing.....	Hasty.

<sup>1</sup> The squatting position may be substituted for either the sitting or kneeling position but not for both.

TABLE V.—*Sustained fire*

Range (yards)	Time (seconds)	Shots	Target	Position	Sling
200 .....	68	19	D.....	Kneeling or squatting from standing.	Loop.
200 .....	68	19	D.....	Sitting from standing.....	Do.
200 .....	68	19	D.....	Prone from standing.....	Do.

<sup>1</sup> The rifle is to be loaded with four rounds initially and reloaded from a full clip.

*c. Classification and minimum aggregate scores.*—Individual classification and minimum aggregate scores required

for qualification in marksmanship for each individual authorized to complete record practice, course C, are as follows:

Expert rifleman.....	172
Sharpshooter.....	160
Marksman .....	130

*d. Transition firing.*—Fire such portions of transition firing prescribed for course A (par. 48) as are practicable with the available range facilities.

■ 51. COURSE D.—*a. Instruction practice.*

TABLE I.—*Slow fire*

Range (inches)	Time (seconds)	Shots	Target	Position	Sling
1,000....	No limit..	5	A 1,000 inch.	Prone (sandbag optional).	Loop.
1,000....	do.....	10	do.....	Prone.....	Do.
1,000....	do.....	5	do.....	Sitting.....	Do.
1,000....	do.....	5	do.....	Squatting.....	Do.
1,000....	do.....	5	do.....	Kneeling.....	Do.
1,000....	do.....	5	do.....	Standing.....	Hasty.

TABLE II.—*Sustained fire*

Range (inches)	Time (seconds)	Shots	Target	Position	Sling
1,000....	68	19	D 1,000-inch....	Prone from standing....	Loop.
1,000....	68	19	do.....	Sitting or squatting from standing.	Do.
1,000....	68	19	do.....	Kneeling or squatting from standing.	Do.

<sup>1</sup> The rifle is to be loaded with four rounds initially and reloaded from a full clip.



*b. Record practice.*TABLE III.—*Slow fire*

Range (inches)	Time	Shots	Target	Position	Sling
1,000	No limit	5	A 1,000-inch.	Sitting	Loop.
1,000	do.	5	do.	Squatting	Do.
1,000	do.	5	do.	Kneeling	Do.
1,000	do.	5	do.	Standing	Hasty.

TABLE IV.—*Sustained fire*

Range (inches)	Time (seconds)	Shots	Target	Position	Sling
1,000	68	19	D 1,000-inch.	Prone from standing	Loop.
1,000	68	19	do.	Sitting or squatting from standing. <sup>2</sup>	Do.
1,000	68	19	do.	Kneeling or squatting from standing. <sup>2</sup>	Do.

<sup>1</sup> The rifle is to be loaded with four rounds initially and reloaded from a full clip.

<sup>2</sup> The squatting position may be substituted for either the sitting or kneeling position but not for both.

*c. Classification and minimum aggregate scores.*—Individual classification and minimum aggregate scores required for qualification in marksmanship for each individual authorized to complete record practice, course D, are as follows:

Expert rifleman	210
Sharpshooter	190
Marksman	160

*d. Transition firing.*—Fire such portions of transition firing prescribed for course A (par. 48) as are practicable with the available range facilities.

## SECTION IV

## RANGE PRACTICE

■ 52. GENERAL.—*a. Phases.*—Range practice is initiated immediately after completion of the preparatory marksmanship

training. Range practice is divided into two parts—instruction practice and record practice.

*b. Sequence of practice.*—The practice season opens with instruction practice. Each rifleman will complete instruction practice before he proceeds with record practice. When record practice is once begun by an individual, it must be completed before he is permitted to undertake any other practice. As a rule, record practice will not be fired by any rifleman on the same day that he fires any part of instruction practice. However, when the time allotted to range practice is very limited, the officer in charge of firing may authorize record firing on the same day. Instruction practice and record practice will not be conducted simultaneously except on ranges where the firing points are in echelon or where the two types of practice are conducted on different parts of the same range.

*c. Range personnel.*—(1) *Officer in charge of firing.*—An officer in charge of firing will be designated by the responsible commander. It is desirable that he be the senior officer of the largest organization occupying the range. The officer in charge of firing or his assistant will be present during all firing and will be in charge of the firing and safety precautions on the range.

(2) *Range officer.*—The range officer is appointed by the appropriate commander and is responsible to the latter for maintaining and assigning ranges, designating danger zones, and closing roads leading into danger zones. The range officer makes timely arrangements for material and labor to place the ranges in proper condition for range practice. He directs and supervises all necessary repairs to shelters, butts, targets, firing points, and telephone lines. He provides for the safety of the markers, and when necessary, he provides range guards and instructs them in the methods to be used for the protection of life and property within the danger area. He assists the officer in charge of firing by using the means necessary to provide efficient service for the maintenance personnel of the ranges.

(3) *Range noncommissioned officer.*—A noncommissioned officer and such assistants as the appropriate commander may deem necessary will be detailed permanently during the

range practice season to assist the range officer. He is responsible to the range officer that the target and pit equipment are kept in a serviceable condition, that the desired targets are ready for use at the appointed time, and that all target and pit details are provided with the proper flags, marking disks, pasters, and spotters.

(4) *Pit details.*—Commanders of organizations firing will provide such detail of officers, noncommissioned officers, and privates as may be necessary to supervise, operate, and mark the targets used by their respective organizations.

*d. Uniform.*—The uniform to be worn during instruction practice and record practice will be prescribed by the commanding officer.

*e. Pads.*—Men should be required to wear pads on the shoulder and, if the ground is hard, on the elbows for the first 3 or 4 days at least. After a few days of firing, the muscles become hardened so that the pads are not essential (par. 55j). Pads may be sewed to the outer garment. Improvised pads, such as a pair of socks or a towel, can be placed under the shirt so as to protect the shoulder and the upper muscles of the arm. Similar pads may be provided for the elbows.

*f. Cartridge belt.*—The cartridge belt will be worn during instruction practice and record firing.

■ 53. INSTRUCTION PRACTICE.—Instruction practice represents the application with live ammunition of the principles taught in the preparatory training. The instruction practice outlined for each course described in paragraphs 48 to 51, inclusive, is designed to serve as a guide only. Within authorized ammunition allowances, the number of shots to be fired at each range is discretionary with the organization commander.

*a. Sighting device* (fig. 19).—On the rifle range, prior to actual firing, each order will be rehearsed in the correct sight picture, and every individual will demonstrate his ability to create it with the sighting device.

*b. Zeroing the rifle.*—When 1,000-inch firing is conducted, each rifle will be zeroed for the 1,000-inch range. Each rifle will also be zeroed for 200, 300, and 500 yards during the in-

struction practice provided for these ranges. Each rifleman will keep a record of these zeroes in his score book (par. 45d(2)).

(1) *For 1,000-inch range.*—(a) The target for the 1,000-inch range is so devised that when the sight is correctly set and the aiming point is accurately used, the center of a shot group should be in the center of the bull's-eye.

(b) To zero the rifle for this target, take a steady aim in the prone position at 6 o'clock on the bull's-eye. The first shot is fired with a sight setting of 200 yards elevation and normal 6 o'clock aiming point. Corrections in elevation and aiming point to bring subsequent shots into the center of the bull's-eye are made by adjusting the sight leaf slide and shifting the aiming point. Such corrections are applied after every two or more shots under the direction of an instructor. If the visibility of the shot groups is limited, binoculars may be used, or the instructor, after taking necessary safety precautions, may move along the line of targets and announce the corrections to the coaches. At a distance of 1,000 inches, changes of 100 yards in elevation and 1 point of windage move the strike of the bullet about 1 inch in each direction.

(2) *For known-distance ranges.*—The position of the spotters on the target will permit the necessary corrections in elevation and windage to be computed. They are then applied to the sight and the aiming point is shifted. These sight settings and the shift of aiming point should be made under the supervision of an instructor or experienced coach after groups of two or more shots with the same sight setting and aiming point have been obtained. If the rifleman cannot perform similarly on two successive shots, there is no point in making sight changes. He should be given more practice in trigger squeeze.

(a) *At 200 yards.*—Set the elevation at 200 yards and use the normal 6 o'clock aiming point: (If the rifle has been zeroed at 1,000 inches, the same elevation and aiming point can be used at 200 yards and should usually be within 50 yards elevation and  $\frac{1}{2}$  point windage of being correct.) Fire a group of two or more shots and apply corrections in ele-

vation and move the aiming point to bring the center of the next shot group or groups into the center of the bull's-eye.

(b) *At other ranges.*—When the rifle has been zeroed for 200 yards as described above, it is easily zeroed for the other ranges as follows: Set the elevation at the desired range and use the 200-yard windage aiming point. Fire a group of two or more shots. Then apply corrections in elevation and move the aiming point to bring the center of the shot group into the center of the target. Record the corrected setting and aiming point minus any allowance for existing wind in the score book as the zero for that range.

(3) *With bayonet or grenade launcher attached.*—When the rifle is fired with the bayonet or grenade launcher attached, the zero may differ considerably from the zero obtained in firing without one of these appendages attached. Consequently, rifles must be zeroed both with and without the bayonet and with and without the launcher. The soldier should record each zero for future reference (a piece of adhesive tape attached to the butt is a suitable means of recording this information). The notation would read, for example:

*Zero at 300 yards*

	<i>Elevation</i>	<i>Windage</i>
Rifle-----	300	½R
With bayonet-----	425	¾R
With grenade launcher-----	375	½R

c. *Use of dummy cartridges.*—Either the corrugated or slotted type of dummy cartridges may be used in range practice. Instruction practice in sustained fire should include firing clips of live and dummy rounds mixed, thus doubling the amount of practice. This training is essential to the development of correct trigger squeeze. The importance of this use of dummy rounds cannot be overemphasized.

d. *Slow fire.*—The first few shots fired on the range by beginners should be slow fire from the prone position. Initially, emphasis should be placed on the ability to fire a compact group, little attention being paid to the score. Following this, slow fire from other positions is conducted. No rifleman

should be allowed to fire sustained fire until he has fired a satisfactory group at slow fire.

*e. Coaching.*—(1) *General.*—During instruction practice, the soldier works under the supervision of a coach. This does not mean that each pupil must have an experienced marksman beside him. Any man of intelligence who has been properly instructed in preparatory marksmanship training and who has been given instruction in coaching methods can be used with good results and should be used when more experienced shots are not available. It is good practice to have expert coaches in charge of one or more targets, usually on a flank, to which particularly difficult pupils are sent for special coaching. Great patience should be exercised by the coach so as not to excite or confuse the rifleman.

(2) *Position of coach.*—On the firing line the coach should take a position similar to that of the man who is firing—prone, sitting, kneeling, squatting, or standing—so as to be able to watch his trigger finger and his eye.

(3) *Watching the eye.*—Errors in trigger squeeze are the most serious errors and are the hardest ones to correct. They can be detected by watching the pupil's eye. If his eye is seen to close as the rifle fires, it is because he was not squeezing the trigger properly and knew when the round would discharge. The explosion and the shock will cause a man to wink, but the wink cannot be seen because of the sudden movement of the head that takes place at the same time. If the rifleman can be seen to wink, it is because he winked first and jerked the trigger afterward.

(4) *Preventing flinching.*—Flinching can usually be prevented by efficient coaching. Indications that his pupil is about to flinch may be detected by watching the pupil's head and eye at the time he is squeezing the trigger. If, during the application of the trigger squeeze, the pupil's eye begins to twitch and his head is gradually drawn away from the thumb or stock, the coach has positive indications that his pupil will flinch. As soon as the coach notices this tendency to flinch, he requires the pupil to bring his rifle down from the firing position and relax for a few moments. While the pupil is resting, the coach points out the rifleman's errors to him. These will usually be not taking up the slack with an

initial heavy pressure, applying the trigger squeeze by means of a number of jerks of the finger instead of with a continuous pressure, and concentration on the discharge of the rifle instead of on the sight picture. After his mistakes have been pointed out, the pupil is permitted to fire again. If the pupil continues to flinch, the coach has him turn his head aside while he, the coach, puts a cartridge in the chamber and closes the bolt. The coach frequently loads a dummy cartridge into the chamber or merely simulates loading without allowing the pupil to know whether the rifle is actually loaded or not. In this manner, the flinch will become evident to the pupil as well as to the coach. Indications of flinching are hunching the right shoulder at the instant the trigger is jerked; winking the right eye; and pulling the head away from the rifle. The coach then proceeds to show the pupil that this difficulty may be readily overcome by applying the correct trigger squeeze. He does this by squeezing the trigger a few times as explained in (5) below.

(5) *Coach squeezing trigger.*—(a) Shots which the coach fires by squeezing the trigger are nearly always good and prove to the rifleman that he is able to aim correctly and that his inaccurate shooting results from incorrect trigger squeeze. To squeeze the trigger for the rifleman, the coach lies with his right elbow on the ground to steady his hand, places his forefinger against the trigger and his thumb against the back of the trigger guard. In this way, he can apply pressure to the trigger by a pinching action of his thumb and forefinger (fig. 37). The coach must be especially careful that his application of force against the trigger is in a line parallel to the line of the sights, otherwise he will pull the sights out of alinement. A few shots by the rifleman using the same pinching action will often assist in overcoming flinching.

(b) The coach then watches the rifleman's back, and between 5 and 10 seconds after the rifleman begins to hold his breath, he applies enough pressure to discharge the rifle. After discharging the rifle a few times, the coach lets the rifleman try a few shots alone to see if he can press the trigger without knowing just when the rifle will fire. Sometimes it is necessary to repeat this exercise, but the majority

of beginners can be permanently cured of the tendency to flinch by a few minutes of this kind of coaching. Old shots who are flinchers require more time and patience.

(6) The sand bag rest is used at the beginning of the course not to teach steadiness of position but to facilitate instruction in the proper method of squeezing the trigger. The



FIGURE 37.—Coach squeezing trigger.

sandbag assures such a steady position that the beginner is not tempted to snap off his shot at the instant the sight touches or drifts past the bull's-eye. This eliminates the cause of nearly all trigger jerking. Using the sandbag rest, the sights can be held fixed at the bottom of the bull's-eye while the rifleman squeezes the trigger with such a steady



pressure as not to know exactly when the rifle will fire. This is the basis of all good shooting. The habit of the correct trigger squeeze acquired by firing with a sandbag rest will usually be retained (par. 42f).

(7) *Duties of coach in slow fire.*—(a) The coach observes the pupil carefully, corrects all errors, and requires that:

1. The sights be blackened and set at the correct range and windage.
2. The ammunition be free from dirt.
3. The pupil adjust the sling properly and take the correct position.
4. The pupil turn his head away while the coach loads.
5. The pupil hold his breath properly. (He checks by watching the pupil's back occasionally.)
6. The pupil take up the slack promptly and decisively with one motion.
7. The pupil does not flinch. (He checks by watching the pupil's eye.)
8. The pupil release his pressure on the trigger and lower his rifle for a moment when his shot has not been fired in 8 or 9 seconds after the slack has been taken up.
9. The pupil call his shot each time he fires.
10. The pupil keep his score book correctly.

(b) When necessary, the coach applies the coaching methods described in (4) and e(5) above.

*f. Sustained fire.*—(1) *General.*—During sustained fire, the tendency to jerk the trigger is increased. This tendency must be corrected before it becomes a fixed habit. Before firing live ammunition it is advisable to have each order simulate a score of sustained fire, using dummy cartridges (par. 53c). Following this, the firing of mixed clips (live and dummy) is an important step in teaching correct trigger squeeze during sustained fire.

(2) *Duties of coach in sustained fire.*—(a) The coach observes the pupil carefully, corrects all errors, and requires that the—

1. Sights be blackened and set at the correct range and windage.
2. Ammunition be free from dirt.

3. Pupil adjust his sling properly and take the correct position.
4. Pupil take up the slack promptly and decisively in one motion.
5. Pupil does not flinch. (He checks by watching the pupil's eye.)
6. Pupil keep his eye on the target, the rifle to his shoulder, and his elbows in place while working the bolt rapidly and smoothly.
7. Pupil count his shots aloud (to insure breathing after each shot).
8. Pupil reload properly.

(b) These operations follow each other in the above sequence, and the coach checks each in turn. The coach will also watch the pupil's back from time to time to see whether he holds his breath while firing each shot. The coach notes improper timing, and, in appropriate cases, recommends to the officer in charge of firing that additional preparatory sustained-fire practice be given. As the pupil's target is marked, the coach verifies that he plots his shot group and records his score in the score book correctly. If score cards are used, they may be kept by the coach (*g* below).

*g. Procedure.*—The procedure prescribed in paragraph 54 for conducting record practice is applicable to instruction practice. Note, however, that whether or not score cards will be used and the manner of use on the firing line during instruction practice is discretionary with the organization commander.

■ 54. RECORD PRACTICE.—*a. General.*—(1) *Purpose.* — The purpose of record practice is to test the soldier's skill as a rifleman and to determine his qualification. The qualification courses are prescribed in paragraphs 48 to 51, inclusive. Provided ammunition allowances for qualification in arms are not exceeded, an individual may be permitted to refire a qualification course until he has qualified.

(2) *Sequence.*—The sequence in which the scores are fired in record practice is discretionary with the officer in charge of firing.

*b. Organization of firing line.*—(1) The firing line will be organized to insure the safe and orderly conduct of the firing and to facilitate supervision by the officer in charge of firing. At the discretion of that officer, the distances specified below may be modified to meet local conditions. The following listed distances will be used as a guide for firing:

(a) *Line of scorers.*—Stationed in rear of the firing line and close to the rifleman being scored.

(b) *Line of telephone operators.*—Posted 10 yards in rear of the firing line.

(c) *Ready line.*—Line upon which the next order for each target is awaiting turn to fire—10 yards in rear of the line of telephone operators.

(d) *Line of rifle rests and cleaning racks.*—Five yards in rear of the ready line.

(e) *Line of ammunition tables or boxes.*—Located in conformity with company commander's desire or local safety rules. A good location is between the ready line and the line of telephones.

(2) Individuals who are to fire will be assigned targets and the order in which they will take turn in firing the several scores—for example, first order, second order, and third order.

*c. Pit details.*—Only the minimum number of officers and noncommissioned officers necessary to preserve order and insure efficient pit service will be placed on duty in the pit. Pit score cards will not be kept. Officers required for duty in the pit will, whenever practicable, be detailed from troops not firing.

*d. Score cards and scoring.*—Coaching is permitted in record practice in order to provide competent instruction. The score may be kept at each firing point by selected privates or privates first class. The cards will bear the date, the rifleman's name, the number of the target, and the order of firing. As soon as a score is completed, the score card will be signed by the scorer. The officer supervising the scoring will collect the score cards, sign them, and turn them over to the organization commander at the end of the day's firing. Except when required for entering new scores on the range, score cards will be retained by the organization commander. Upon completion of record firing and after the qualifica-

tion order is issued, the organization commander will destroy all score cards in his possession.

*e. Marking targets.*—(1) *Known-distance ranges.*—(a) *Slow fire (A and B targets).*—In slow fire on the known-distance range, the value of the shot is indicated as follows:

1. A bull's-eye (five), with a white disk.
2. A four, with a red disk.
3. A three, with a black and white disk.
4. A two, with a black disk.
5. A miss, by waving a red flag once across the front of the target.

The exact location of the hit is indicated by placing in the shot hole a spotter of size appropriate to the distance from the firing point. The center of the marking disk is placed over the spotter in signaling hits.

(b) *Sustained fire (D target).*

1. The same disks used to indicate the value of hits in slow fire are used in marking the D target in sustained fire.
2. Spotters are placed in the shot holes before the target is run up for marking.
3. The marking begins with the hits of highest value, the center of the disk being placed over the spotter, then swung off the target and back again to the next spotter, care being taken each time to show only the face of the disk indicating the value of the shot being marked. The marking will be slow enough to avoid confusing the scorer at the firing point. When one spotter covers more than one shot hole, the disk is placed over it the required number of times. Misses are indicated by slowly waving the red flag across the face of the target one time for each miss.

(2) *1,000-inch ranges (1,000-inch A and D targets (rifle)).*—No marking is necessary on the 1,000-inch range, and no spotters are required.

(a) *Slow fire.*—After firing on 1,000-inch A targets (rifle), riflemen are given the opportunity to examine their targets for the purpose of recording scores.

(b) *Sustained fire*.—After firing on 1,000-inch D targets (rifle), riflemen are given the opportunity to examine their targets for the purpose of recording scores.

*f. Method of conducting known-distance firing*.—(1) *Slow fire (A and B targets)*.—(a) *On the firing line*.

1. One rifleman only will be assigned to a target in each order.
2. When all riflemen are ready to fire, the officer in charge of firing commands: **SLOW FIRE, COMMENCE FIRING**. At the conclusion of firing he commands: **CEASE FIRING, UNLOAD, CLEAR RIFLES**.
3. As the value of each shot is signaled, the scorer announces, in a tone sufficiently loud to be heard by the rifleman, the name of the rifleman, the number of the shot, and the value of the hit. He then records the value of the hit on the score card.
4. Whenever a target is marked and the rifleman assigned to that target has not fired, the scorer will notify the officer in charge of firing.
5. When a rifleman fires on the wrong target, he will not be scored a miss until the target to which he is assigned has been withdrawn and the miss has been signaled from the pit.

(b) *In the pit*.

1. When a shot is fired on a target, it is withdrawn. A spotter is then placed in the shot hole. The previous shot hole, if any, is pasted, and the target is run up and marked.
2. When a target frame is used as a counterweight for a double sliding target, the blank side of the frame will be toward the firing line.

(2) *Sustained fire (D target)*.—(a) *On the firing line*.

1. One rifleman only will be assigned to a target in each order. The loop or hasty sling, as required, should be adjusted on the arm before the rifleman takes his position on the firing line.
2. When all is ready in the pit, a red flag is displayed at the center target. At that signal the officer in charge of the firing line commands: **LOAD, LOCK**.

3. The officer in charge of the firing line then commands: **READY ON THE RIGHT, READY ON THE LEFT.** Anyone who is not ready calls out, "Not ready on No. ———."
4. All being ready on the firing line, the officer in charge commands: **READY ON THE FIRING LINE.** Rifles are unlocked, and each rifleman stands relaxed and prepared to assume the prescribed position when his target appears. The telephone orderly at the control telephone notifies the pit, "Ready on the firing line."
5. The flag at the center target is waved and then withdrawn. Five seconds after the flag is withdrawn the targets appear, remain fully exposed for the prescribed period of time, and are then withdrawn. The rifleman takes the prescribed position as soon as the targets appear and fires or attempts to fire the prescribed number of shots, reloading with a full clip taken from the belt. If a rifleman fails to fire at all, he will be given another opportunity to fire, but if he fires any shots, the score must stand as his record. He will not be permitted to repeat his score on the claim that he was not ready. (See also par. 55*u* and *w*.)
6. As soon as the targets are withdrawn, the officer in charge commands: **UNLOAD, CLEAR RIFLES.** All unfired cartridges are removed from the rifle, and the bolts are left open. The men remain in position on the firing line until they are ordered off by the officer in charge of firing.
7. As each shot is signaled from the pits, it is announced by the scorer at the firing line. For example, a score of 10 shots is announced as follows as each shot is marked: "Target 22—1 five, 2 fives, 3 fives, 4 fives; 1 four, 2 fours, 3 fours; 1 two, 2 twos; 1 miss." The scorer notes these values on a pad and watches the target as he calls the shot. After marking is finished, he counts the number of shots marked, and if there are more than the prescribed number of shots, he calls,

"Redisk No. ——." If the correct number of shots have been marked, he enters the individual value of each hit and the total value of all hits on the rifleman's score card.

(b) *In the pit.*

1. The time is regulated by the officer in charge of the pit.
2. When all is ready in the pit, the targets are fully withdrawn, and a red flag is displayed at the center target.
3. When the message is received that the firing line is ready, the red flag at the center target is waved and withdrawn, and the command READY is given to the pit details.
4. Five seconds after the red flag is withdrawn, the targets are run up by command or signal, left fully exposed for the prescribed period of time, and then withdrawn.
5. The men in the pit detail examine the targets and put spotters in the shot holes. The targets are then raised and marked.
6. The targets are left up for about 1 minute after being marked and are then withdrawn, pasted, and made ready for another score. They may be left up until ordered pasted by the officer in charge of the firing line.
7. If more than the maximum number of prescribed hits are found on any target, it will not be marked unless all of the hits have the same value. The officer in charge of the firing line will be notified of the fact by telephone.

*g. Method of conducting 1,000-inch-range firing.*—(1) *Slow fire (1,000-inch A target (rifle)).*—Slow fire is conducted on the 1,000-inch range in accordance with the procedure prescribed for known-distance firing (*f*(1) above) except that upon completion of slow fire the riflemen are given the opportunity to examine their targets for the purpose of recording the scores.

(2) *Sustained fire (1,000-inch D target (rifle)).*—Sustained fire is conducted on the 1,000-inch range in accordance with

the procedure prescribed for known-distance firing (pars. 44c and 54f (2)) except as follows: The officer in charge of firing gives the commands to COMMENCE FIRING and CEASE FIRING. Time is taken from the first command. At the command COMMENCE FIRING, all riflemen assume the firing position and commence firing. When firing has been completed and after all rifles have been cleared (par. 18g), the officer in charge of firing will direct the riflemen to examine their targets for the purpose of recording the scores.

*h. Use of telephones.*—(1) Telephones will be used for official communication only.

(2) No one will ask over the telephone for information as to the name or organization of any person firing on any particular target, and no information of this nature will be transmitted.

(3) The following expressions will be used over the telephone in the cases enumerated:

(a) When a shot has been fired and the target has not been withdrawn from the firing position, "Mark No. \_\_\_\_\_."

(b) When a shot has been fired and the target has been withdrawn from the firing position but has not been marked, "Disk No. \_\_\_\_\_."

(c) When the target has been withdrawn from the firing position and has been marked but the value of the shot has not been understood, "Redisk No. \_\_\_\_\_."

(d) When the firing line is ready to fire, "Ready on the firing line."

■ 55. RULES GOVERNING RECORD PRACTICE.—*a. Identity of riflemen to be unknown to personnel in pit.*—Officers and men in the pit should not know who is firing on any particular target and will not attempt to obtain this information; likewise, other officers and men will not transmit such information to personnel in the pit.

*b. Coaching.*—Riflemen may be coached during record practice, but the coach may not touch the person or the rifle of the rifleman. Each rifleman must observe the location of his own hits as indicated by the marking disk or spotters.



*c. Use of instruments.*—(1) The use of binoculars and spotting scopes is authorized and encouraged.

(2) The use of instruments or devices for determining the force and direction of the wind is prohibited during record practice.

*d. Shelter for riflemen.*—Sheds or shelter for the riflemen will not be permitted on any range.

*e. Restrictions as to rifle.*—Troops will use the rifle with which they are armed. The rifle will be used as issued by the Ordnance Department. The use of additional appliances such as temporary shades for the sights, spirit levels, and orthoptic eyepieces is prohibited. The sights may be blackened. Small arms and appliances issued by the Ordnance Department for test and report will not be used for determining classification.

*f. Trigger pull.*—The trigger pull will be at least 3 pounds and before record firing will be tested (with the barrel vertical) by an officer.

*g. Ammunition.*—The ammunition used will be the service cartridge as issued by the Ordnance Department unless the use of other ammunition is authorized. No man will be issued more than the prescribed number of rounds.

*h. Cleaning.*—Cleaning will be permitted only between scores.

*i. Use of sling.*—The sling will be used in connection with one arm only. The ends of the sling will not be removed from the lower band swivel or the butt swivel for the purpose of making adjustments. No knot will be tied in the sling, and the sling itself will neither be added to nor modified in any manner. The sling should be adjusted on the arm before taking position on the firing line.

*j. Pads and gloves.*—(1) Pads of moderate size and thickness may be worn on either shoulder, on both elbows, and on either upper arm. Pads of such size, thickness, or construction as to form artificial support for the rifle are prohibited. Shoulder pads designed (by means of excessive size or thickness, quilting, rolls, ridges, or other devices) to aid materially in retaining the rifle butt in the firing position against the shoulder are prohibited. The use of a hook, small roll, or

ridge on the sleeve of the shooting coat or shirt to keep the sling in place on the arm is prohibited (par. 52e).

(2) A glove may be worn on either hand, provided it is not used to form an artificial support for the rifle.

*k. Loading rifles.*—Initially rifles will be loaded only on command; thereafter they will be loaded at will as long as the rifleman is in the firing position and until the command to cease fire is given.

*l. Warming shots.*—No warming shots will be allowed.

*m. Action in case of damaged rifle.*—Should a breakage occur, the rifle will be repaired or a different rifle will be substituted. If the repair involves the sights of the rifle, or if a different rifle is substituted, the rifleman will be allowed to zero the substituted rifle or to rezero the repaired rifle and then refire the exercise.

*n. Shots cutting edge of bull's-eye or line.*—Any shot cutting the edge of the figure or bull's-eye will be signaled and recorded as a hit in the figure or the bull's-eye. Because the limiting line of each division of the target is the outer edge of the line separating it from the exterior division, a shot touching this line will be signaled and recorded as a hit in the higher division.

*o. Slow-fire score interrupted.*—If a slow-fire score is interrupted through no fault of the person firing, the unfired shots necessary to complete the score will be fired at the first opportunity thereafter. (See also *m* above.)

*p. Misses.*—(1) *Slow fire.*—In marking targets during slow fire, before any miss is signaled, the target will be withdrawn from the firing position and carefully examined, preferably by an officer. Whenever the target is run up and a miss is signaled, it will be presumed that this examination has been thoroughly made. No challenge of the value signaled will be entertained nor will resignaling of the miss be allowed.

(2) *Sustained fire.*—After the target has been marked in sustained fire, it will not be withdrawn and reexamined for the purpose of determining possible corrections in the original marking. This does not prohibit having the target re-disked (par. 54h). The examination of a sustained-fire target for misses will be conducted as in *p*(1) above, before the target is run up to be marked.

*q. Accidental discharge.*—All shots fired by the rifleman after he has taken his place at the firing point will be considered in his score, even if his rifle was not directed toward the target or if it was accidentally discharged.

*r. Firing on wrong targets.*—Shots fired upon the wrong target will be entered as a miss upon the score of the man firing, no matter what the value of the hit upon the wrong target may be. In sustained fire, the rifleman at fault is credited with only such hits as he may have made on his own target.

*s. Two shots on same target.*—In slow fire, if two shots strike a target at the same time or nearly the same time, both will be signaled. If one of these shots was fired from the firing point assigned to that target, the hit having the higher of the two values signaled will be entered on the rifleman's score, and no record will be made of the other hit.

*t. Withdrawing targets prematurely.*—In slow fire, if the target is withdrawn just as the shot is fired, the scorer at that firing point will at once report the fact to the officer in charge of scoring on the firing line. That officer will investigate to see if the case is as represented. Being satisfied that such is the case, he will direct that the shot be disregarded and that the man fire another shot.

*u. Misfires in sustained fire.*—(1) *General.*—In the event of a misfire during sustained fire, the officer in charge of firing or one of his assistants will investigate the cause and will render all decisions on misfires.

(2) *Through fault of rifleman.*—If the misfire is manifestly caused through fault on the part of the rifleman, he will not be allowed to complete the exercise. In such case, only the number of rounds fired will be scored.

(3) *Through no fault of rifleman.*—When a misfire occurs which was not the fault of the rifleman, time and ammunition permitting, the complete score will be refired. If sufficient time and ammunition are not available, the incompleting record target may be reexposed on a time basis of 6 seconds for each shot that remains to be fired. Six seconds for reloading a clip will be given. In no case will the rifleman be given any information regarding his previous hits on the incompleting target until the score is completed.

(4) *Damaged rifle.*—If during the firing of a sustained-fire score the rifle becomes damaged from a cause not the fault of the rifleman, the pit detail is directed to disregard the score, the target is not marked, and the rifleman refires the score.

*v. Unfired cartridges in sustained fire.*—Each unfired cartridge will be recorded as a miss. In case the number of hits marked exceeds the number of rounds fired, the rifleman firing on that target will be credited with the hits of highest value corresponding to the number of rounds fired. The breaking of a clip in reloading will not entitle the rifleman to another score.

*w. More than nine hits in sustained fire.*—When a target has more than the prescribed number of hits, the target will not be marked, nor will the rifleman be permitted to obtain any information as to the score or location of hits. The rifleman firing on that target will be given an opportunity to refire the score unless all the hits have the same value, in which case the target will be marked and he will be given that value for each shot fired by him.

*x.* For course D, 1,000-inch range, see paragraph 54g.

## SECTION V

### EQUIPMENT, TARGETS, AND RANGE PRECAUTIONS

■ 56. EQUIPMENT.—*a. Preparatory marksmanship training.*—

(1) The simple apparatus described below is ample for preparatory marksmanship training. For information pertaining to equipment required for transition firing, see paragraphs 48 and 167.

(a) *For each four men.*

1 sighting bar, complete.

1 rifle rest.

4 sighting devices (one for each man).

1 small sighting disk.

4 small aiming targets (three 1,000-inch A targets (rifle) to be placed at heights to correspond to standing, sitting, and prone positions and one 1,000-inch D target (rifle) are suitable).

1 10-inch sighting disk.

- 1 small box, approximately the size of an ammunition box.
  - 1 frame covered with blank paper for long-range shot groups (for two groups of four men).
  - 2 sandbags.
  - 1 pencil.
  - 20 rounds corrugated-type practice dummy cartridges.
  - 4 score books (one for each man).
  - 4 Progress Charts showing state of training (one for each man) (par. 39f).
  - Material for blackening sights.
- (b) *For general use.*
- 1 rapid-fire target for each three squads.
  - 1 each A, B, and D targets on frames for score-book exercises.
  - 1 large spotter.
  - 3 small spotters.
  - Cleaning and preserving materials.
- (2) *Preparation.*—(a) *Sighting bar.*
1. Provide a bar of wood about 1 by 2 inches and 4½ feet long. Cut two thin slots 1 inch deep across the edge. Place one slot 5½ inches from the end and the other 26 inches from the same end of the bar (fig. 38③).
  2. Make a front sight of thin metal ½ by 3 inches bent in the shape of an L and tack it to the edge of the bar between the two slots and ½ inch from the slot nearest the end (fig. 38④, (d) and (g)). Have the leg of the L project above the bar ½ to ¾ of an inch (fig. 38③).
  3. Make an eyepiece from a piece of tin or zinc 3 by 7 inches (fig. 38④, (c), (f), and (h)). Cut along the dotted lines to form the shape shown in the figure. Tack this eyepiece to the end of the bar farthest from the slots so that the top of the eyepiece extends 1 inch above the top of the bar (fig. 38③). Make a round hole ½ of an inch in diameter in the middle of the eyepiece ½ inch above the bar.

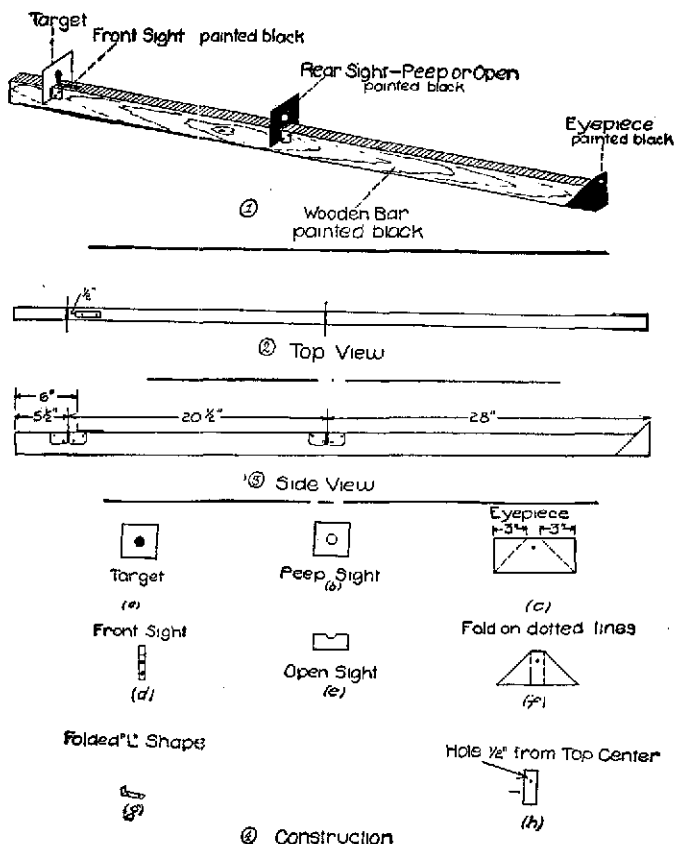

FIGURE 38.—Construction of sighting bar.

Wooden bar—1 by 2 inches by 4 feet 6 inches (approximate).  
 Eyepiece—thin metal, 3 by 7 inches; hole, 0.03-inch diameter.  
 Rear sight—thin metal or cardboard, 3 by 3 inches; hole in center,  $\frac{3}{4}$ -inch diameter.  
 Front sight—thin metal,  $\frac{1}{2}$  by 3 inches, bent L-shape.  
 Target—thin metal or cardboard, 3 by 3 inches, painted white—black bull's-eye,  $\frac{1}{2}$ -inch diameter in center.  
 Slits—1 inch deep, may be lined with thin metal strips.

4. Make a rear sight of thin metal or cardboard 3 by 3 inches and cut a round hole  $\frac{3}{4}$  inch in diameter in its center (fig. 38④, (b)).
5. Cut a piece of thin metal or cardboard 3 by 3 inches, painted white, and have a black bull's-eye  $\frac{1}{2}$  inch in diameter painted or pasted on the center (fig. 38④, (a)).
6. Place two pieces of tin 1 inch wide and 3 inches long in each slot. Fold the loose ends away from each other and tack them to the sides of the bar (fig. 38③).
7. Paint the eyepiece, the front sight, the rear sight, and the top of the bar black.

(b) *Rifle rest.*—An empty ammunition box or any other well-made box of suitable size, with notches cut in the ends to fit the rifle closely, makes a good rifle rest. The rifle is placed in these notches with the trigger guard close to and outside of one end. The sling is loosened and pulled to one side. The box is half-filled with earth or sand to make it more stable.

(c) *Sighting disks.*—Sighting disks are of two sizes. The disk to be used at a distance of 50 feet is about 3 inches in diameter. The disk is made of tin or cardboard and is mounted on a handle as shown in figure 39. The bull's-eye will be mounted on a background of clean white paper. The disk to be used at 200 yards is 10 inches in diameter. These disks are painted black and are mounted on white handles which are 4 or 5 feet long. All bull's-eyes will be black and circular and will have a hole in the center large enough to admit the point of a pencil.

b. *Range equipment.*—(1) *At firing point.*

Cleaning racks.

Scorers' tables.

Binoculars (one for each target).

Score cards.

Score boards.

Cleaning and preserving materials.

Material for blackening sights.

Score books.

Indelible pencils.

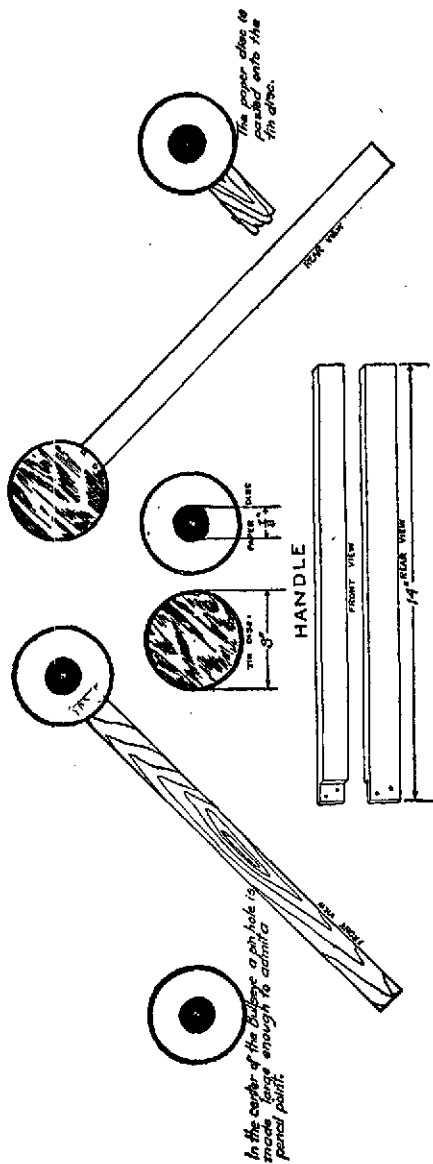

FIGURE 39.—Sighting disk.



Containers for empty cartridge cases.

Telephones.

(2) *In pit.*

Telephones.

Nine 3-inch spotters for each target.

One 5-inch spotter for each target.

One red flag per target.

Marking disks (minimum of one per target).

Pasters.

Paste.

■ 57. TARGETS.—*a.* Target A is used for 200 and 300 yards and is a rectangle 6 feet high and 4 feet wide. It has a black circular bull's-eye 10 inches in diameter (value of hit, 5), an inner ring 26 inches in diameter (value of hit, 4) an outer ring 46 inches in diameter (value of hit, 3), and a border (value of hit, 2).

*b.* Target B is used for 500 yards and is a square 6 feet in height. It has a black circular bull's-eye 20 inches in diameter, an inner ring 37 inches in diameter, an outer ring 53 inches in diameter, and a border. The value of hits on target B is the same as the value of hits on target A.

*c.* Target D, the sustained-fire target, is a square 6 feet in height and has in its middle a black silhouette 26 inches wide and 19 inches high representing a soldier in the prone position (for additional dimensions see the score book.) The value of hits is as follows: in the figure, 5; in the space immediately outside the figure, 4; in the space immediately outside the four-space, 3; remainder of target, 2.

*d.* The 1,000-inch A target (rifle) and the 1,000-inch D target (rifle) are reductions of targets A and D, respectively from 200 yards to 1,000 inches. The value of hits on the reduced targets is the same as the value of hits on targets A and D.

*e.* Targets E and F are used for unknown-distance firing and represent a figure about the height of a soldier in the kneeling and prone positions, respectively. They are constructed by tacking a pasteboard target E or F to a stick.

*f.* For additional details, see W. D., A. G. O. Form No. 82 (1942) and TM 9-855.

■ 58. RANGE PRECAUTIONS.—See AR 750-10.

## SECTION VI

### SMALL-BORE PRACTICE

■ 59. OBJECT.—The object of small-bore practice is to provide a form of marksmanship training with the caliber .22 rifle and ammunition which represents the application of the principles taught in the preparatory exercises. Small-bore practice provides an excellent means of improving the shooting of organizations and of sustaining interest in marksmanship throughout the year. The firing of this course enables the company commander to visualize the state of training of his command and to concentrate his efforts on the training of those who are most deficient.

■ 60. VALUE.—The chief value of small-bore practice lies in the fact that it is convenient, interest sustaining, and economical. It does not have the full value of caliber .30 practice because of the absence of recoil, but on account of its convenience and the saving in the cost of ammunition, organization commanders will find that small-bore practice is a valuable step in marksmanship training.

■ 61. CONTINUOUS SMALL-BORE PRACTICE.—Small-bore practice may be carried on throughout the year, subject to such limitations as may be imposed by the allowance of ammunition. All persons who have never been properly instructed in shooting methods prescribed herein will be given a thorough course of preparatory instruction before being permitted to fire on the small-bore range. All small-bore practice will be properly organized and supervised in accordance with the methods of instruction prescribed in this manual.

■ 62. COURSES.—*a.* When ammunition allowances, time, and available facilities permit, organizations may fire one of the small-bore courses outlined below:

(1) *Course E.—(a) Instruction practice.*1. *Short range.*TABLE I.—*Slow fire (to zero rifle)*

Range (feet)	Time	Shots	Targets	Position	Sling
50.....	No limit	5	SB-A-2.....	Prone (sandbag optional).	Loop.
50.....	do.....	5	SB-A-2.....	Sitting.....	Do.
50.....	do.....	5	SB-A-2.....	Squatting.....	Do.
50.....	do.....	5	SB-A-2.....	Kneeling.....	Do.
50.....	do.....	5	SB-A-2.....	Standing.....	Hasty.

TABLE II.—*Slow fire*

Range (feet)	Time	Shots	Targets	Position	Sling
50.....	No limit	10	SB-A-2.....	Standing.....	Hasty.
50.....	do.....	15	SB-A-3.....	5 kneeling, 5 sitting, 5 squatting.	Loop.
50.....	do.....	10	SB-B-5.....	Prone.....	Do.

TABLE III.—*Sustained fire*

Range (feet)	Time (seconds)	Shots	Targets	Position	Sling
50.....	60	10	SB-D-2.....	Standing to kneeling or squatting.	Loop.
50.....	70	10	SB-D-3.....	Standing to prone.....	Do.

NOTE.—When desired, tables I, II, and III may be fired at 1,000 inches by substituting the 1,000-inch A target (rifle) for targets SB-A-2 and A-3; the 1,000-inch B target (rifle) for target SB-B-5; and the 1,000-inch D target (rifle) for targets SB-D-2 and D-3.

2. *Intermediate range.*TABLE VI.—*Slow fire*

Range (yards)	Time	Shots	Targets	Position	Sling
50.....	No limit	10	SB-A, 50-yard..	Prone.....	Loop.
50.....	do.....	15	do.....	5 kneeling, 5 sitting, 5 squatting.	Do.
50.....	do.....	10	SB-D, 50-yard..	Standing.....	Do.

TABLE V.—Sustained fire

Range (yards)	Time (seconds)	Shots	Targets	Position	Sling
50	65	10	SB-D, 50-yard	Standing to prone	Loop.
50	70	10	do	Standing to sitting	Do.
50	70	10	do	Standing to kneeling	Do.
50	70	10	do	Standing to squatting	Do.

NOTE.—The firing included in tables IV and V is optional. If no 50-yard range is available, tables IV and V will be fired at 100 yards on the SB-D, 100-yard target. This note applies only to the E course.

## 3. Long range.

TABLE VI. Slow fire

Range (yards)	Time	Shots	Targets	Position	Sling
100	No limit	10	SB-A, 100-yard	Prone	Loop.
100	do	15	do	5 kneeling, 5 sitting, 5 squatting.	Do.
100	do	10	SB-D, 100-yard	Prone	Do.

TABLE VII.—Sustained fire

Range (yards)	Time (seconds)	Shots	Targets	Position	Sling
100	75	10	SB-D, 100-yard	Standing to prone	Loop.
100	80	10	do	Standing to sitting	Do.
100	80	10	do	Standing to squatting	Do.

## (b) Record practice.

TABLE VIII.—Slow fire

Range (yards)	Time	Shots	Targets	Position	Sling
100	No limit	10	SB-A, 100-yard	Prone	Loop.
100	do	10	do	5 sitting or squatting, 5 kneeling or squatting. <sup>1</sup>	Do.

<sup>1</sup> Only 5 shots are permitted in the squatting position.

TABLE IX.—Sustained fire

Range (yards)	Time (seconds)	Shots	Targets	Position	Sling
100.....	75	10	SB-D, 100-yard.	Standing to prone.....	Loop.
100.....	80	10	do.....	Standing to sitting or squatting.	Do.

(2) *Course F.*—(a) *Instruction practice—Short range.*—Fire tables I, II, and III of course E.

TABLE X.—Sustained fire

Range (feet)	Time (seconds)	Shots	Targets	Position	Sling
50.....	65	10	SB-D-3.....	Standing to prone.....	Loop.
50.....	70	10	do.....	Standing to sitting.....	Do.
50.....	70	10	do.....	Standing to squatting.	Do.

(b) *Record practice.*

TABLE XI.—Slow fire

Range (feet)	Time	Shots	Targets	Position	Sling
50.....	No limit	10	SB-A-3.....	Kneeling or squatting.	Loop.
50.....	do.....	10	SB-B-5.....	Prone.....	Do.

TABLE XII.—Sustained fire

Range (feet)	Time (seconds)	Shots	Targets	Position	Sling
50.....	65	10	SB-D-3.....	Standing to prone.....	Loop.
50.....	70	10	do.....	Standing to sitting or squatting.	Do.

b. *Qualification scores for these courses, which are indicative of the proficiency attained, are as follows:*

Course	Possible score	Expert	Sharp-shooter	Marksman	Unqualified
E.....	200	180	160	130	Less than 130.
F.....	200	180	160	130	Do.

## CHAPTER 3

### MARKSMANSHIP, MOVING GROUND TARGETS

	Paragraphs
Section I. General .....	63-64
II. Moving vehicles .....	65-67
III. Moving personnel .....	68-69
IV. Moving-target ranges .....	70

#### SECTION I

##### GENERAL

■ **63. TRAINING.**—Rifle units will be trained to fire at moving targets such as tanks, armored vehicles, trucks, and personnel at appropriate ranges. Rifle fire may be employed to repulse or harass unarmored vehicles and motorized troops. Rifle units will be trained to meet a tank attack by taking cover, standing their ground, and delivering the maximum possible aimed fire at the enemy tanks and hostile foot troops who may accompany them. (For information pertaining to the use of antitank and antipersonnel grenades, see paragraph 20c and FM 23-30.)

■ **64. FUNDAMENTALS.**—The fundamentals of shooting as presented in this chapter apply to firing at moving targets. In applying these fundamentals, the rifleman must adjust his aim and trigger squeeze to conform to the movement of the target.

a. *Effective range.*—While under ideal conditions moving targets may be engaged at ranges above 600 yards, effective results beyond that range are considered to be exceptional. For this reason, training in the technique of fire is normally limited to ranges of 600 yards or less. In defense, rifle fire is withheld until the attacker approaches within effective range (500 yards). (See FM 7-10.)

b. *Sights to be used.*—Moving targets are seldom exposed for long periods and can be expected to move at maximum speed during periods of exposure. Accurate correction of sight setting is often impracticable; therefore instruction in technique should favor the use of the battle sight. Corrections for range are made by adjustment of the aiming point

on the target. The peep sight is habitually set at 300 yards and is immediately available for use against moving targets at close range when appropriate.

*c. Leads.*—Targets which cross the line of sight at any angle are classified as crossing targets. In firing at such targets, the rifleman must aim ahead of the target so that the target and bullet will meet. The distance which the rifleman aims ahead of the target is called the lead. Targets which approach directly toward the rifleman or recede directly from the rifleman will for all practical purposes require no lead.

## SECTION II

### MOVING VEHICLES

■ 65. DETERMINATION AND APPLICATION OF LEADS.—*a.* The lead necessary to hit a moving vehicle is dependent upon the speed of the target, the range to the target, and the direction of movement with respect to the line of sight. A vehicle moving at 15 miles an hour will traverse approximately 7 yards in 1 second. A rifle bullet moves 300 yards in about  $\frac{4}{10}$  of a second and 500 yards in about  $\frac{7}{10}$  of a second. Therefore, to hit a vehicle moving at 15 miles an hour at ranges of 300 yards and 500 yards, the leads should be 3 yards and 5 yards, respectively.

*b.* Leads are applied by using the length of the target (as it appears to the rifleman) as the unit of measure. This eliminates the necessity for corrections due to the angle at which the target crosses the line of sight, because the more acute the angle the smaller the target will appear and the less speed it will attain in its movement across the front.

*c.* The following information is furnished as a guide:

#### TARGET LENGTHS (LEADS)

Miles per hour	300 yards	500 yards
15	$\frac{3}{2}$	1

NOTE.—For a speed of  $7\frac{1}{2}$  miles an hour, divide the indicated lead by 2. For a speed of 30 miles an hour, multiply the indicated lead by 2.

■ 66. **TECHNIQUE OF FIRE.**—The following technique is suggested for firing at rapidly moving targets, using the battle sight.

a. *Approaching or receding targets.*—The rifleman holds his aim on the center of such target and squeezes off his shot.

b. *Crossing targets.*—(1) At ranges of 400 yards or less, the rifleman alines his sights on the bottom of the target, swings the point of aim laterally in the direction the target is moving, and takes the estimated lead. The rifle is moved with the required lead, and the shot is squeezed off while the rifle is carried on with a follow-through swing.

(2) At ranges of more than 400 yards, the rifleman proceeds as in (1) above, except that he swings his point of aim across the top of the target.

c. Fire is executed as rapidly as proper aiming and squeezing will permit.

d. When no other facilities are available, practice in aiming and leading may be obtained by tracking vehicles engaged in normal traffic along roads near the training area.

■ 67. **PLACE IN TRAINING.**—Training in the technique of firing at moving vehicles with live ammunition properly follows individual training in known-distance firing. It should be preceded by instruction in range estimation (sec. II, ch. 5). When time and ammunition allowance permit, caliber .22, followed by caliber .30, firing on the 1,000-inch range may be added as preliminary instruction.

### SECTION III

#### MOVING PERSONNEL

■ 68. **TECHNIQUE.**—a. *Sight to be used.*—Under field conditions, moving personnel present a fleeting target which is more difficult to hit than a moving vehicle. This fact increases the importance of an accurate sight setting. However, when targets appear suddenly, allowing no time for sight adjustment, the use of the battle sight may be required. It is therefore desirable that the individual rifleman be trained in the employment of both types of firing.



b. *Method of aiming.*—(1) *Hold-off.*—The hold-off method is used in aiming the rifle for elevations with the battle sight when firing at a man at ranges indicated below (fig. 40).

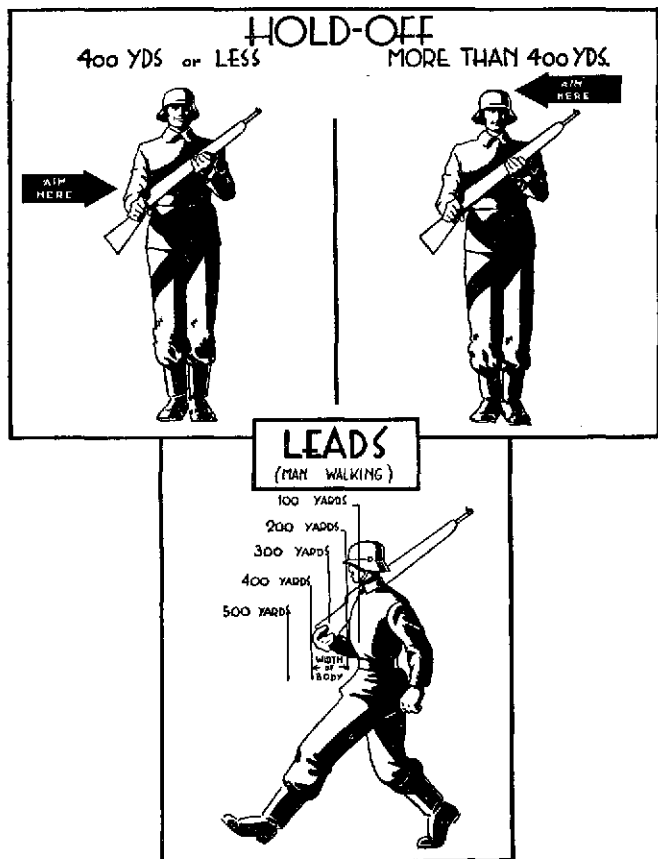

FIGURE 40.—Hold-off and leads for use against enemy personnel.

- (a) At 400 yards or less, aim at the middle of the body.  
 (b) At more than 400 yards, aim at the top of the head.

(2) *Leading.*—(a) The leading method is used to determine the required lead for firing at a man moving across or at right angles to the line of fire. In order to avoid using an elaborate system of calculating required leads, the following general rule may be used as a basis for estimating the proper leads. For the various ranges, the rifle should be aimed as follows (fig. 40) at a walking man. If the man is running, the lead should be doubled.

1. At 100 yards, aim forward half of the body.
2. At 200 yards, aim at the forward edge of the body.
3. At 300 yards, lead equals one-half the width of the body.
4. At 400 yards, lead equals the width of the body.
5. At 500 yards, lead equals  $1\frac{1}{2}$  widths of the body.

(b) Proficiency in this type of firing depends largely upon the amount of time devoted by the individual to the practice of aiming, leading with appropriate speed, squeezing the trigger, and following through.

■ 69. WHEN TO CONDUCT TRAINING.—Like practice in firing at moving vehicles, training in firing on moving personnel should follow instruction in known-distance firing and range estimation. When practicable, it should immediately precede squad training in technique of fire.

#### SECTION IV

#### MOVING-TARGET RANGES

■ 70. MOVING-TARGET RANGES.—a. *Target.*—(1) A sled of the type shown in figure 41 has proved to be the most satisfactory kind of target to represent a moving vehicle. It has the advantage of a low center of gravity, which prevents the target from upsetting when traversing rough ground or making changes of direction. The sled shown in the figure is 5 feet long, 30 inches wide, 4 feet high, and weighs only 45 pounds. Figure 42 shows a similar sled covered with target cloth.

(2) *Towing.*—For towing the target, a  $\frac{1}{2}$ -inch rope has been found satisfactory, the power being furnished by a  $1\frac{1}{2}$ -ton truck. The pulley shown in figure 42 is simply a channel wheel bolted to a short length of 2-inch board. This

board is staked to the ground at the point where a change of direction of the target is desired. The knot shown in

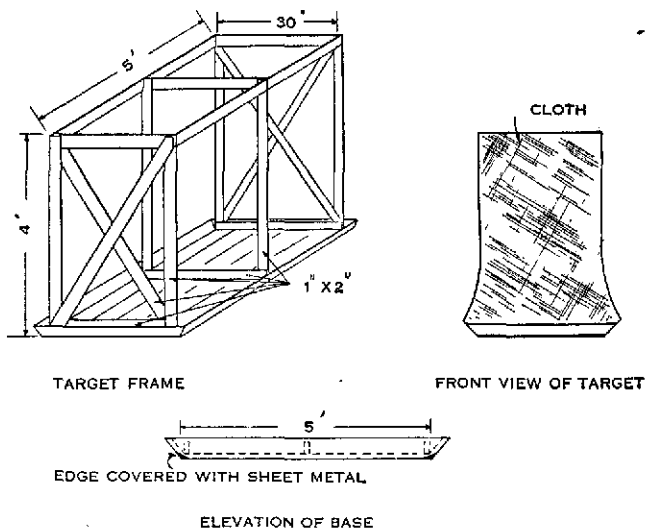

FIGURE 41.—Target frame for moving-target range.

the figure should be 10 or 12 feet from the sled, depending on the speed at which the target is to be run. At faster

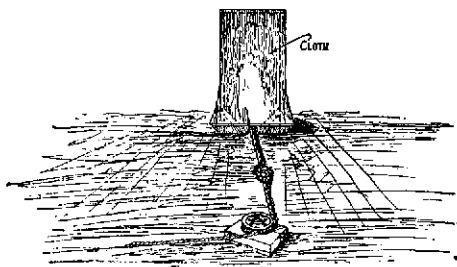
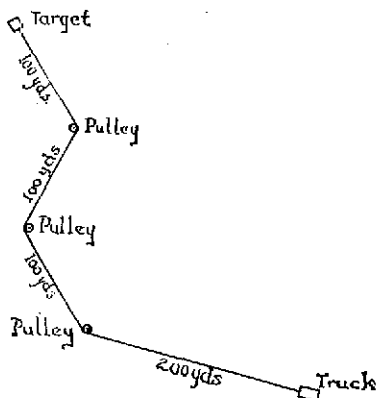

FIGURE 42.—Sled target covered with target cloth; pulley and trip knot for effecting changes of direction.

speeds, the knot must be at a greater distance from the sled to prevent the latter from overrunning the pulley.

(3) *Setup*.—With 500 yards of rope, a set-up as shown in figure 43 can be made. This arrangement is only one of many which can be made with 500 yards of rope.



\* GUN.

FIGURE 43.—Set-up for towing moving-ground target.

*b. Moving personnel*.—Moving personnel may be represented on any class A range. E targets mounted on sticks carried by men walking or running in the pits are sufficient.

## CHAPTER 4

### MARKSMANSHIP, AERIAL TARGETS

	Paragraphs
SECTION I. Nature of aerial targets for rifle.....	71-72
II. Technique of fire.....	73-77
III. Marksmanship training.....	78-82
IV. Miniature range practice.....	83-85
V. Towed-target and radio-controlled-airplane-target firing.....	86-89
VI. Ranges, targets, and equipment.....	90-95

#### SECTION I

##### NATURE OF AERIAL TARGETS FOR RIFLE

■ 71. **AERIAL TARGETS SUITABLE FOR RIFLE FIRE.**—Combat arms take the necessary measures for their own immediate protection against low-flying hostile aircraft and descending parachutists. Troops must be fully trained to protect themselves against hostile aerial attacks, without reliance upon other arms. All low-flying hostile aircraft and descending parachutists are suitable targets for rifle fire, and the soldier must be imbued with the determination to defend himself against this type of adversary.

■ 72. **CLASSIFICATION OF AERIAL TARGETS.**—From the point of view of the rifleman, aerial targets may be classified as—

a. *Overhead.*—Overhead targets are those which pass directly over, or nearly over, the rifleman.

b. *Nonoverhead.*—Nonoverhead targets are those which do not pass directly over or nearly over the rifleman.

**NOTE.**—Overhead and nonoverhead targets may be flying at a constant altitude or may be either gaining or losing altitude.

c. *Direct-diving.*—Direct-diving targets are those which dive directly toward a rifleman.

d. *Direct-climbing.*—Direct-climbing targets are those which climb directly away from the rifleman.

#### SECTION II

##### TECHNIQUE OF FIRE

■ 73. **GENERAL.**—When concealment is essential and is believed to have been achieved, no fire is opened on hostile aircraft. When concealment is not essential, or obviously does not exist, all men armed with rifles open fire as soon as

attacking aircraft are within effective range. Such targets usually remain in view only for short periods of time; consequently, they must be engaged promptly. Riflemen must be taught a simple method of firing on hostile low-flying aircraft. This section on the technique of fire deals entirely with actual fire on hostile planes and gliders. Details of antiaircraft marksmanship training are contained in sections III, IV, and V.

■ 74. LEADS.—*a. General.*—In order to hit a target such as an airplane in flight, it is necessary to aim an appropriate distance ahead of it and on its projected path of flight, so that the target and the bullet will meet. This distance ahead of the airplane is called "lead." A lead must be applied in all firing except when the target is at extremely close range (less than 100 yards), when it is diving directly at the soldier, or when it is flying directly away from him. The process of leading a target is called "tracking."

*b. Determination of leads.*—(1) The lead necessary to engage any target depends upon—

(a) The speed of the target.

(b) The range to the target.

(c) The time required for the bullet to hit the target (time of flight).

(d) The direction in which the target is moving with respect to the line of fire.

(2) When a target appears, it is impossible for riflemen or leaders of rifle units to consider all of the factors contained in *b*(1) above and compute accurately the lead required for firing. Therefore, leads are computed and placed in lead tables for use in training rifle units (par. 159c).

*c. Application of leads.*—Although leads are originally computed in feet or yards, they are given in lead tables as target lengths. It is very difficult for a rifleman to estimate accurately a lead such as 40 or 50 yards at ranges from 600 to 100 yards. Therefore, the length of the target as it appears to the rifleman is used as the unit of measure for applying leads. This eliminates the necessity of making corrections for angular crossings of the target with the line of sight; that is, the more acute the angle of target approach is to the line of sight, the shorter the target will appear and the less speed

it will attain in its movement across the front. For this reason, the rifleman applies the length of the target, as it appears to him, along the projected path of the target to determine the aiming point for each shot. The number of times he applies this unit of measure will be announced in a fire order, or as explained in paragraph 76.

■ 75. TARGET DESIGNATION.—*a.* Aerial target designation may be given as routine instruction in training areas long before the area of probable hostile air attack is reached. Aerial targets for a single unit will be clearly visible.

*b.* The tactics of attacking aircraft vary considerably and frequently. Often attacking aircraft engaging ground troops will fly in V-shaped formations of three (or more) airplanes each, or will operate individually. When the fire of a rifle squad is directed at one airplane of a V-shaped formation, normal dispersion of this fire will partly cover the remaining airplanes. Therefore, a satisfactory method of designating targets is to assign each of the three airplanes to an element of the rifle platoon during the training period. In case less than three airplanes attack, the units not having an assigned target fire on the leading airplane. The assignment is not changed except in unusual circumstances. The basic requirement is that of placing the maximum possible volume of fire in the direct path of attacking aircraft. Sighting on the airplane must be rapid and rough, and the rate of fire must be high. Troops must be drilled in this type of defense so that all actions become automatic and so that very little thinking or calculation is required.

*c.* The normal assignment of a target extends from its initial appearance until it passes beyond range. If there is a succession of groups of hostile airplanes or gliders, the unit will be instructed to bring fire on the successive groups as they approach within effective range.

■ 76. FIRE DISTRIBUTION.—*a.* The fire of rifle units must be distributed along the path of flight of the target as long as the target is within effective range. This is done as follows:

(1) For all targets, except parachutists and direct-diving or direct-climbing aircraft, aim and fire each shot with a six-

target-length lead. Battle experience shows that the general tendency is to take too little lead. Soldiers should be forewarned to combat this tendency and to take *at least* six leads. If the soldier is to make a mistake in his leads, it is better that he should make it as too much lead rather than too little.

(2) For all direct-diving or direct-climbing targets, aim and fire each shot at the target. Soldiers should be taught that the dive bomber is most vulnerable to ground fire at the instant it pulls out of its dive, and that maximum fire is most desirable at that moment.

(3) Against parachute targets, aim and fire each shot with one-target-length lead.

*b.* This method of fire distribution is based upon the fact that, as the target is approaching or receding, the range and the leads are constantly changing. The lead used for aircraft is the average of all leads necessary to engage a target between the extreme effective range of 600 yards and a minimum range of 100 yards. The lead for parachute targets is based on an average of all leads necessary to engage such targets at ranges from 500 to 100 yards.

*c.* The target considered in determining the lead of six target lengths is a 35-foot airplane flying at 300 miles an hour. In towed-target firing, the same number of leads is applicable, since the towed-sleeve target is 15 feet long and its average speed is 140 miles an hour (par. 159c).

*d.* It is difficult for men to estimate airplane speeds accurately. Therefore, the average speed (approximately 300 miles an hour) is used for training purposes. For speeds considerably greater or less than 300 miles an hour, the lead should be changed proportionately. The speed of the target may be slightly more or less than 300 miles an hour. However, the lead is computed on approximate data, and the lead estimates of all riflemen are approximations at best. Experience has shown that this method of distribution is a better expedient than the more precise and more complicated methods of engaging aerial targets.

*e.* Other methods of fire distribution may be used by unit commanders in training their units. Examples are given in section IV, chapter 6.



■ 77. DELIVERY OF FIRE.—*a. Range.*—(1) The maximum effective range of rifle fire at airplanes (or gliders) is approximately 600 yards. For parachutists the range is 500 yards. This is the actual distance gun-target or “slant range.” It is not the horizontal range to a point on the ground directly below the target. However, riflemen should take the firing position as soon as possible after receiving warning of the approach of hostile aircraft and should track the target until it comes within range.

(2) Training in estimating ranges of aerial targets is given by having an airplane fly at known ranges until the men undergoing instruction are familiar with the appearance of the plane at key ranges. The following details can usually be recognized at the identical ranges:

<i>Details seen</i>	<i>Range (yards)</i>
General outline of the plane-----	1, 000
Rudder, cockpit-----	700
Guns and small projections from fuselage-----	500
Symbols, numbers, letters on plane (easily read) -----	200

*b. Rate of fire.*—The rate of fire at aerial targets is about the same as the sustained-fire rate at ground targets. Everything must be done to increase the rate of fire without affecting its accuracy. Repeated tests have proved that rifle fire delivered faster than is consistent with proper aim and trigger squeeze results in waste of ammunition. Each shot must be aimed and squeezed. A well-trained rifleman can fire one shot in about 4 seconds.

*c. Sight used.*—No attempt should be made to use the peep sight when firing at airplanes. Instead, sighting is done over the top of the front sight and battle peep sight. For firing at parachutists, use the battle peep sight. When firing on miniature ranges with caliber .22 rifles equipped with Lyman sights, the sight may be replaced by the Ordnance Department with an open sight, or the peep sight disk may be unscrewed and removed so that the large opening which remains can be used.

*d. Accuracy of fire.*—Antiaircraft fire delivered against low-flying airplanes by trained riflemen has proved effective.

This fire will cause substantial losses to hostile aircraft and drive them to higher altitudes, thus decreasing the effectiveness of air attack and observation.

*e. Effect of caliber .30 fire on airplane.*—(1) There are various degrees of possible damage to an airplane from rifle fire. Hits upon the cylinder walls and other important working parts are likely to stop an engine immediately. A hit through the metal propeller is also serious, since it throws the engine out of balance. Unless the bombs carried by the airplane are bulletproof, hits by armor-piercing small-arms bullet will detonate them. The pilot is especially vulnerable. When bullets of any type penetrate nonsealing gasoline tanks, they will cause a leakage of gasoline, which frequently will be ignited by engine exhaust or tracer bullets.

(2) There are also many lesser ways in which rifle fire can damage an airplane. Holes through the crankcase may cause the oil to drain out, which will cause the engine to "freeze" before the airplane returns to friendly territory. Hits of any kind necessitate varying degrees of repair, even if they do not result in the destruction of the airplane.

### SECTION III

#### MARKSMANSHIP TRAINING

■ 78. INSTRUCTION.—*a. Object.*—The object of antiaircraft marksmanship instruction is to train the rifleman in the technique of firing at rapidly moving aerial targets.

*b. Basis.*—(1) Prior to instruction in antiaircraft marksmanship, the soldier should be trained in the fundamentals of good shooting (par. 32) by means of a course in rifle marksmanship. To become a good antiaircraft marksman, he must be able to apply these fundamentals to firing at rapidly moving targets and must be able to perform the following operations with accuracy and precision:

(a) Determine the required lead by applying the length of the target as a unit of measure.

(b) Aline the sights of the rifle rapidly on the required lead.

(c) Swing the rifle with a smooth, uniform motion so as to maintain the aim on the required lead while getting off the shot.

(d) Apply correct trigger squeeze so as to fire in a minimum of time and without disturbing the aim.

(e) Follow through smoothly after the shot is fired.

(2) The correct performance of the foregoing operations, combined in one continuous, smooth motion when firing in any direction at rapidly moving aerial targets, is the basis for the course of training outlined herein.

*c. Sequence of training.*—Antiaircraft rifle-marksmanship training is conducted in the following sequence: preparatory exercises; miniature range practice; and firing at towed-flag, towed-sleeve, and radio-controlled-airplane targets, when available.

*d. Personnel to receive training.*—Consistent with the time available and ammunition allowances, all personnel of units whose primary weapon is the rifle should receive antiaircraft marksmanship training.

■ 79. PREPARATORY EXERCISES.—*a. General.*—(1) *Description.*—The preparatory exercises are designed to teach the soldier the correct method of performing each of the operations listed in paragraph 78 *b*(1), and to drill him in these operations until the correct procedure becomes a fixed habit. In addition to a brief explanation of the technique of antiaircraft rifle fire, the preparatory exercises consist of the following three distinct steps, which should be completed for each of the targets described in *c* below, prior to firing:

(a) Position exercise.

(b) Aiming-and-leading exercise.

(c) Trigger-squeeze exercise.

(2) *Methods.*—A conference by the instructor should precede each exercise. This conference should include an explanation of the necessity of the exercise and demonstrations by a qualified squad. In order to awaken interest and to stimulate the soldier's enthusiasm, the preliminary instruction should be conducted individually. Every soldier should be able to explain each point.

(3) *Coaching.*—During all preparatory exercises and miniature range firing, the coach-and-pupil method will be used (fig. 44). Unit leaders are the instructors and should supervise and prompt the coaches.

*b. Organization.*—With targets as described in *c* below and the target range as described in section VI of this chapter, a group of 32 men (fig. 44①) for each target is the most economical training unit. For the preparatory exercises, this will permit 16 men to perform the exercises on a target while the remaining 16 men act as coaches (fig. 44②). Each group should complete all preparatory exercises and

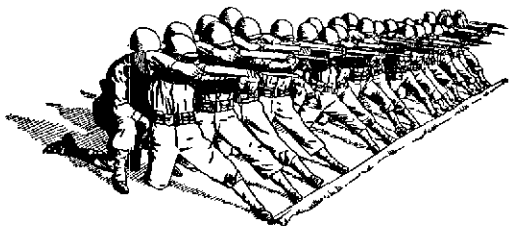

① Nonoverhead and parachute target.

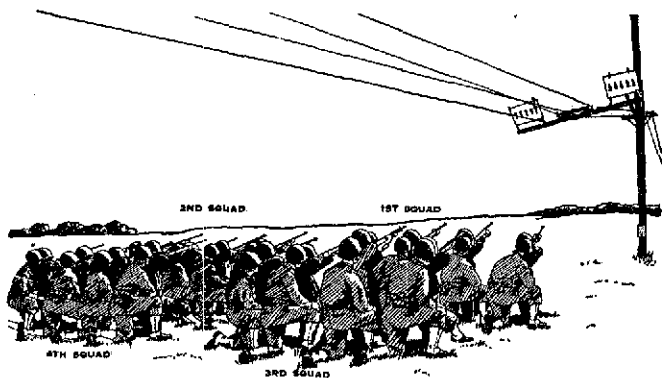

② Overhead target.

FIGURE 44.—Organization for training.

instruction firing on one type of target on the miniature range before preparatory training and instruction firing are undertaken on the next type of target (par. 85). Groups change places as they complete the exercises on the targets assigned them. This procedure should be followed until each man of each group has completed instruction on the

horizontal, climbing and diving, overhead, and parachute targets.

c. *Targets used on 500-inch miniature range in preparatory exercises and during firing with caliber .22 and caliber .30 rifles (sec. VI).—(1) Nonoverhead aiming and leading targets (fig. 45).—Nonoverhead aiming and leading targets represent two towed-sleeve targets (silhouettes). When moved at a rate of approximately 15 feet a second horizontally on the nonoverhead carrier, they represent targets being towed directly across the front; when moved diagonally upward or downward on the climbing-and-diving target carrier, they represent targets which are climbing or diving in front of the riflemen.*

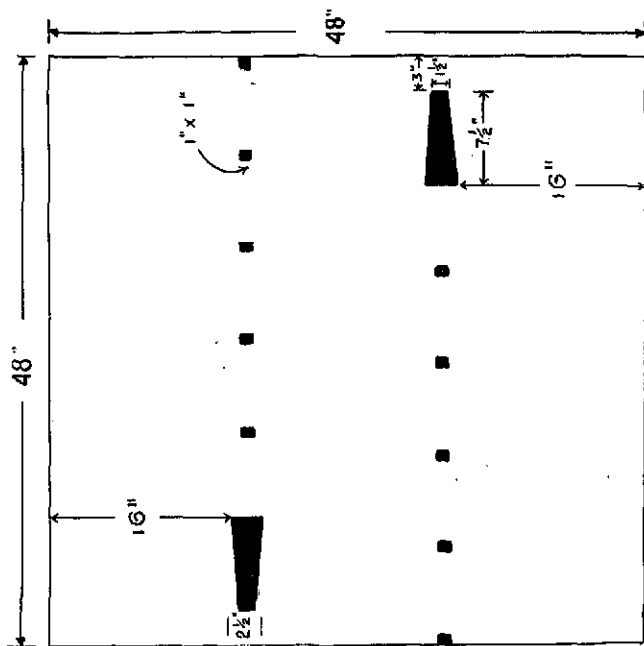

FIGURE 45.—Nonoverhead aiming and leading targets.

(2) *Overhead aiming and leading targets.*—Overhead aiming and leading targets represent four towed-sleeve targets (silhouettes) approaching or moving away from the rifleman

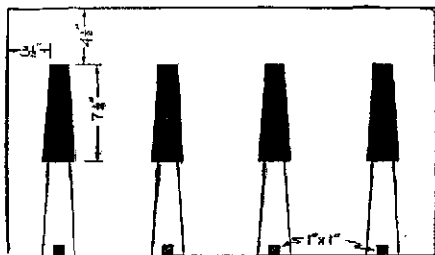

FIGURE 46.—Overhead aiming and leading targets.

at a constant elevation (altitude); these targets are also moved at a rate of approximately 15 feet a second (fig. 46).

(3) *Parachute aiming and leading target.*—Parachute aiming and leading targets (fig. 47) represent four descending parachute targets (silhouettes), which should be operated at

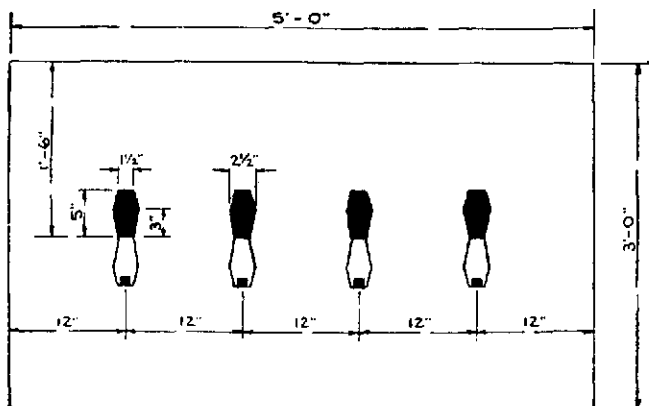

FIGURE 47.—Parachute aiming and leading targets.

NOTE.—Nonoverhead aiming and leading targets are provided with several black squares (pasters) which are used as aiming points for announced leads. Each silhouette on the overhead and parachute targets is also provided with one black square (paster) used for the same purpose.

a rate of 1 foot a second. Under this condition, these targets represent actual parachutists at a distance of 300 yards descending at a rate of 17 feet a second.

(4) *Trigger-squeeze targets*.—Trigger-squeeze targets are those which are used subsequently in instruction firing (see (5) below and figs. 48, 49, and 50).

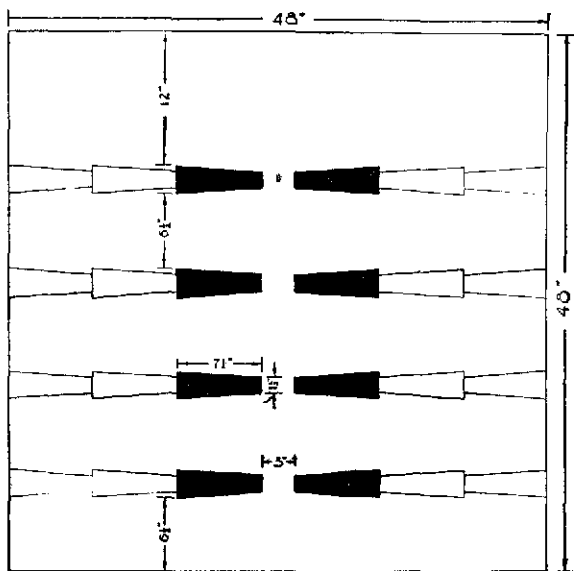

FIGURE 48.—Nonoverhead instruction firing targets.

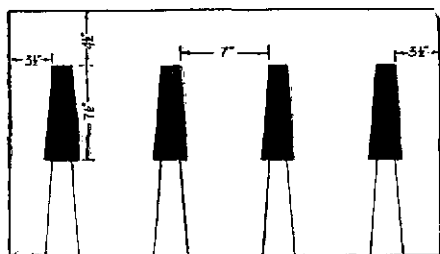
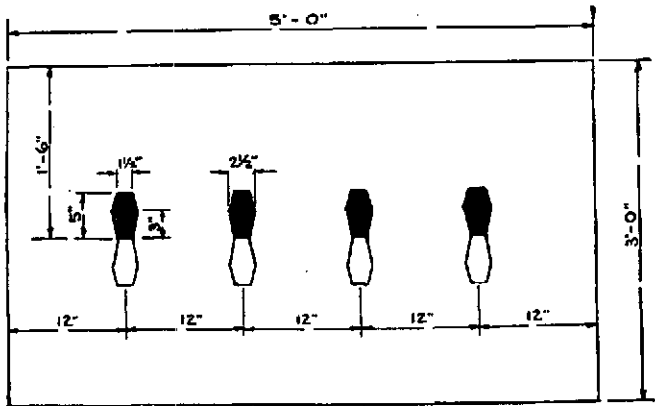
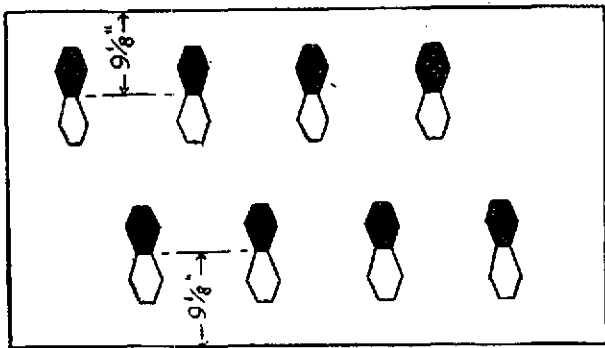

FIGURE 49.—Overhead instruction firing targets.



①



②

FIGURE 50.—Parachute instruction firing targets.

(5) *Instruction firing targets.*—(a) *The nonoverhead type* (fig. 48) consists of eight silhouettes for each of which there are two scoring spaces. Four silhouettes are used for pupils leading from left to right, while the remaining four silhouettes are used for pupils leading from right to left (see (4) above).



(b) *The overhead type* (fig. 49) consists of four silhouettes for each of which there is one scoring space.

(c) *The parachute type* (fig. 50①) consists of four silhouettes for each of which there is one scoring space. By doubling the number of silhouettes (fig. 50②), the capacity of the range is doubled for this type of target (figs. 57④ and 58). Such a target (fig. 50②) will allow two squads to fire simultaneously as one target descends.

(d) Aiming pasters are not used on the firing targets. This eliminates a tendency of the rifleman to jerk the trigger the instant the sights become aligned at the announced lead.

(6) *Group firing targets.*—Group firing targets (fig. 51) consist of two stakes suspended vertically from the moving cable on the horizontal nonoverhead target carrier. Four black silhouettes are mounted on each stake. The right stake is used for firing when tracking from left to right; the left stake is used for firing when tracking from right to left.

■ 80. FIRST STEP: POSITION EXERCISES.—*a. General.*—The positions used in antiaircraft firing are those which can be assumed rapidly, which afford maximum flexibility of the body for manipulation of the rifle, and which do not require undue exposure of the rifleman. These positions will usually be either kneeling, sitting, reclining, or standing. The kneeling, sitting, and reclining positions are less vulnerable than the standing position (fig. 52①).

*b. Firing positions.*—(1) The following are particular characteristics of antiaircraft firing positions:

(a) The sling is not used.

(b) The arms are not supported, but move freely in any direction with the body.

(c) The hands grasp the rifle firmly; the left hand is placed at or near the lower band swivel.

(d) The butt of the rifle is held firmly against the shoulder with both hands, and the cheek rests against the stock.

(e) In the sitting position the legs are not raised but are fully extended and well separated to preserve balance (fig. 52②).

(f) In the kneeling position the buttock does not rest on the heel, and the left foot is well advanced to the left front,

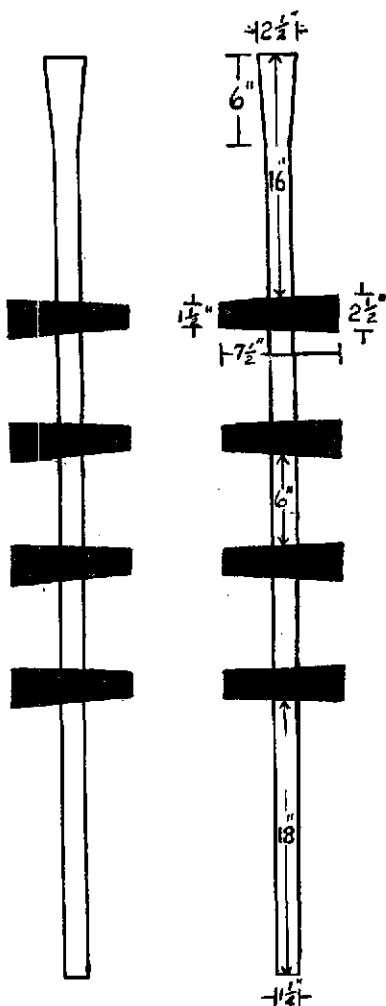

FIGURE 51.—Group firing targets.

left knee slightly bent, toe pointing to the right. The weight is slightly forward (fig. 52③).

(g) In the reclining position the rifleman lies on his back. His legs are extended along the ground in the direction of the target and are well separated. The body is twisted toward the right side, allowing the left shoulder to clear the ground and the left hand to grasp the rifle well forward as in the other anti-aircraft positions. The head is raised so that it is in its normal position in relation to the stock and sights. Though not required in table I (par. 84b(13)), the reclining position may be used as a desirable field expedient (fig. 52④).

(2) The positions must be such that the rifle, the body from the waist up, the arms, and the head move as one fixed unit. When leading a target, the rifle must be swung with a smooth, uniform motion. This is accomplished by pivoting the body at the waist. Except for the reclining position, there should be no independent movement of the arms, shoulders, head, or the rifle.

(3) The instructor explains and demonstrates the positions. He also explains that if the rifle is pulled or pushed in the desired direction by means of the left hand and arm, the rifle will move with a jerky motion. This increases the possibility of jerking the trigger or of pulling or pushing the front sight out of alinement with the rear sight and the eye.

(4) Using the coach-and-pupil method of instruction, the instructor requires his group to practice taking each anti-aircraft position correctly. Through repetition and practice, each soldier is required to become proficient in assuming each position rapidly for firing at hostile aircraft moving in any direction.

■ 81. SECOND STEP: AIMING AND LEADING EXERCISES.—*a. Purpose.*—The purpose of the aiming and leading exercises is to teach the correct method of aiming and to develop skill in swinging the rifle with a smooth, uniform motion. Initially, students aim at a small black paster, in order to practice taking an announced lead. To vary the number of leads, the instructor has the pupils aim at pasters which have a position corresponding to the leads announced. Stress should be laid on keeping the top of the front sight centered in the peep

sight. More misses occur on the miniature range because of improper aim than because of improper lead.

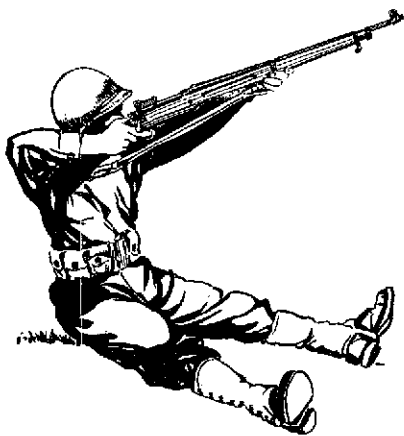
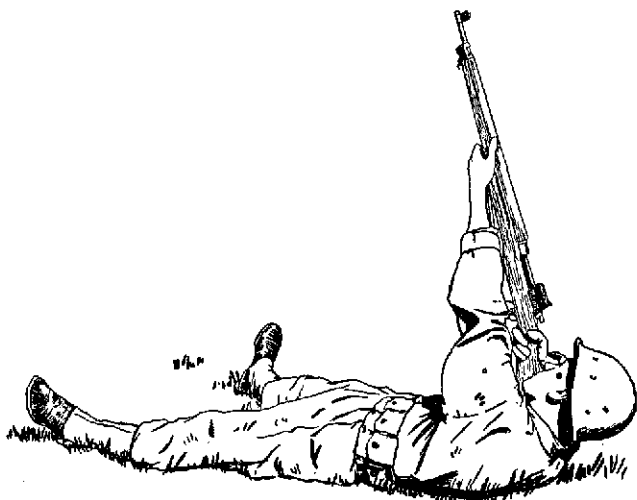

FIGURE 52.—Rifleman in antiaircraft firing positions.

*b. Method.*—(1) Pupils are placed in one line, at intervals of about  $1\frac{1}{2}$  yards, 500 inches from and facing the assigned



③



④

FIGURE 52.—Rifleman in antiaircraft firing positions—Continued.

target (fig. 44①). In the nonoverhead target exercises, the pupils stand relaxed, with their rifles pointing upward and in the general direction of the targets, elbows at the sides, and hands grasping the rifle at the small of the stock and at the lower band swivel, ready to assume the designated position promptly. The coaches take positions that enable them to observe their pupils. The commands for the exercise are: 1. AIMING AND LEADING EXERCISE; 2. ONE (TWO, THREE, etc.) LEAD (S); 3. TARGETS. At the command TARGETS, the targets are operated at a speed of approximately 15 feet a second. The pupils assume the designated firing position rapidly and align the sights on the silhouette or black paster, representing the announced lead, on the aiming and leading target. Then they swing their rifles with a smooth, uniform motion by pivoting their bodies at their waists, maintaining the aim on the announced lead during the travel of the target. The operation is repeated as the target is moved in the opposite direction. The exercise is continued until the target has been moved five times in each direction. The coaches and pupils then change places, and the exercise is continued until all men have acquired skill in aiming and leading with various leads, both from right to left and from left to right on the horizontal and the climbing and diving targets.

(2) A group assigned to the two overhead aiming and leading targets is divided into two equal groups of coaches and pupils. These groups are then formed generally into four parallel lines facing the targets and perpendicular to the line of travel for the target (fig. 44②). Pupils are arranged in the first and third lines. The coaches, close behind their pupils, are placed in the second and fourth lines. Half of the pupils in each line aim and lead on the approaching target; the remaining pupils aim and lead on the receding target. All pupils continue to aim and lead their silhouettes as they change direction until each target has made five complete approaching and returning trips. Then pupils and coaches change places and repeat this procedure until all men have acquired skill in aiming and leading on the overhead target. Either one lead or no lead is used.

(3) A group assigned to practice on the parachute aiming and leading targets (fig. 57④) is divided equally as coaches

and pupils (fig. 44①). All pupils aim and lead on the descending target, tracking until the target reaches its lowest point. Either one lead or no lead is used. After two or more runs of the target, coaches and pupils change places, and the exercise is repeated.

*c. Duties of coach.*—In the aiming and leading exercise, the coach insures that the—

- (1) Proper position is taken.
- (2) Rifle is swung with a smooth motion.
- (3) Rifle is swung by pivoting the body at the waist.
- (4) Arms, shoulders, rifle, and head move as a unit.

■ 82. THIRD STEP: TRIGGER-SQUEEZE EXERCISES.—*a. Importance.*—(1) The rifleman should be trained to squeeze the trigger exactly as when firing sustained fire at stationary ground targets, except that *the rifle is kept in motion during the trigger squeeze, the firing of the shot, and after the firing of the shot (follow-through).*

(2) In firing at a rapidly moving target, the untrained man has a tendency to permit the rifle to come to rest momentarily while applying the final squeeze. As a result, the shot passes behind the target. Another fault of the untrained man is that of jerking the trigger quickly the instant the aim is on the required lead. This causes the rifleman to flinch because he knows when the cartridge will be discharged.

(3) Because of the short period of time during which the usual aerial target will be within effective range, fire should be opened as soon as possible and should be delivered at as rapid a rate as is consistent with accuracy. The trigger should be squeezed promptly and decisively. Once started, the squeeze should be continued until the cartridge is fired.

(4) Skill in squeezing the trigger properly when firing at rapidly moving targets is difficult to acquire. Although men will have had training in trigger squeeze during their course in stationary ground-target marksmanship, firing at rapidly moving targets introduces certain additional elements which must be overcome before skill is acquired. Since practice in taking correct positions rapidly, in aiming, and in leading is included in trigger-squeeze exercises, the greater part of

the time allotted to preparatory exercises should be devoted to trigger-squeeze exercises.

*b. Object.*—The primary object of trigger-squeeze exercises is to train the rifleman to apply pressure on the trigger while keeping the rifle in motion, to develop a decisive trigger squeeze so that fire can be opened in a minimum of time without loss of accuracy, and to train him to follow through after the shot. In this training, the necessity of a smooth swing and follow-through is second in importance only to the trigger squeeze itself.

*c. Method.*—(1) Except as noted below, the procedure for conducting trigger-squeeze exercises on nonoverhead targets corresponds to that prescribed for conducting the aiming and leading exercises.

(2) The commands for the exercise are: 1. TRIGGER-SQUEEZE EXERCISE; 2. SIMULATE LOAD; 3. SQUADS ONE AND THREE FROM RIGHT TO LEFT; (OR LEFT TO RIGHT); 4. SQUADS TWO AND FOUR FROM LEFT TO RIGHT (OR RIGHT TO LEFT); 5. ONE (TWO, OR MORE) LEAD(S); 6. TARGETS.

(NOTE.—“SQUADS ONE, TWO, THREE, and FOUR” refers to organization for training (fig. 44).

At the command TARGETS, the targets are operated at the prescribed speed. Pupils rapidly assume the designated firing position, mentally apply the target length as the unit of measure in taking the lead announced in the order, and direct the aim on that point. By swinging the rifle in the manner taught in the aiming and leading exercise, pupils maintain the aim at the announced lead, at the same time applying a constantly increasing pressure on the trigger until the striker is released. *The aim and pressure on the trigger are maintained during the entire length of travel of the target, regardless of the time of release of the striker.* The importance of following through after the shot cannot be too strongly emphasized. It is only by this means that men will develop the habit of keeping their rifles in motion during the entire process of firing. All of these steps are performed as one continuous operation. The exercise consists of squeezing the trigger each time the target moves across the front in the direction designated in the fire order. The target having reached the end of its movement across the



rifleman's front, he quickly swings his rifle back to the beginning of the target run, operates the bolt while keeping the rifle at his shoulder, and anticipates the return of the target to that end of the run. The exercise consists of five passages of the target in each direction. The coach and pupil then change places, and the work is continued until all men have become proficient in squeezing the trigger correctly while using various leads. It is essential that training be provided for targets moving in both directions. For most riflemen, leading from left to right is more difficult than leading from right to left.

(3) A group receiving instruction in trigger-squeeze exercises on overhead targets is formed in the same manner as that used in aiming and leading exercises (fig. 44②). The instruction in trigger squeeze is conducted in the same manner as the instruction prescribed for the aiming and leading exercises, with the exception that when the target reaches the end of its run, the rifleman does not track the movement in the opposite direction. He swings his point of aim quickly back to the starting point and continues the trigger-squeeze exercise as described above for nonoverhead targets. The commands for this exercise are: 1. TRIGGER-SQUEEZE EXERCISE; 2. SIMULATE LOAD; 3. SQUADS ONE AND THREE, APPROACHING (OR RECEDING) TARGETS; 4. SQUADS TWO AND FOUR, RECEDING (OR APPROACHING) TARGETS; 5. ZERO (ONE) LEAD; 6. TARGETS.

(4) A group receiving instruction in trigger-squeeze exercises on parachute targets is formed in the same manner as that prescribed for aiming and leading exercises (fig. 44①). The commands for the exercise are: 1. TRIGGER-SQUEEZE EXERCISE; 2. SIMULATE LOAD; 3. SQUADS ONE AND TWO, RIGHT TARGET; SQUADS THREE AND FOUR, LEFT TARGET; 4. ZERO (ONE) LEAD; 5. TARGETS. At the command TARGETS, the targets are operated at the prescribed speed. Squads one and two simulate firing four rounds at the right descending target. When the left target reaches the top of the carrier and starts down, squads three and four simulate firing four rounds on it.

*d. Duties of coach.*—In the trigger-squeeze exercise, the coach sees that—

- (1) Proper position is taken.
- (2) Rifle is swung with a smooth, uniform motion.

(3) Rifle is swung by pivoting the body at the waist.

(4) Arms, shoulders, rifle, and head move as a unit as the rifle is moved.

(5) Pressure on the trigger is applied promptly, decisively, and continuously.

(6) Eye is kept open and does not blink at the instant the striker is released.

(7) Muzzle does not jerk simultaneously with the release of the striker.

(8) Pupil continues the aim and trigger pressure during the entire length of travel of the target.

(9) Rifle butt is kept on the shoulder while he simulates reloading.

#### SECTION IV

##### MINIATURE RANGE PRACTICE

■ 83. GENERAL.—*a.* Miniature range practice is divided into two parts: instruction firing and group firing. There is no record firing.

*b.* All firing is on moving targets on the 500-inch range. A suggested plan for organization of the range is given in paragraph 91. Provision is made for simultaneous firing by separate groups on the horizontal, the climbing and diving, the overhead, and the parachute targets.

*c.* The course should first be fired with the caliber .22 rifle, after which, if the supply of ammunition and the danger area permit, the caliber .30, M1917 rifle may be used.

*d.* All rifles should be zeroed before range practice starts.

■ 84. INSTRUCTION FIRING.—*a. General.*—(1) The purpose of instruction firing is to provide a means of applying the principles taught in the preparatory exercises.

(2) During instruction firing, the soldier works under the supervision of a coach.

(3) As a group completes the preparatory training on a target, instruction firing should be begun on that target and completed before the group moves to another target.

(4) Instruction firing consists of the exercises indicated in table I (see *b*(13) below).

*b. Procedure.*—(1) The organization of the training unit for firing should be the same as that given in paragraph 79.

(2) The front rank of each group is formed on the firing line in the designated firing position. The men in the rear rank act as coaches.

(3) One-half of the front-rank pupils of the group fire while the remaining front-rank men simulate firing (fig. 44①). In this way, men are kept busy and receive additional preparatory instruction while waiting for their turn to fire. This organization is, in effect, a double coaching system for squads, similar to the one described for individuals in paragraph 143b(3).

(4) A silhouette is assigned to each rifleman. For example, the four silhouettes on the right of the targets are assigned the first four men on the right of the line, and the four silhouettes on the left of the targets are assigned the next four men. Silhouettes for the men simulating firing are assigned in the same manner (par. 79c(5)).

(5) When the men are in the desired firing position on the nonoverhead firing points, the officer in charge of firing commands: 1. SQUADS ONE AND TWO, LOAD; 2. SQUADS THREE AND FOUR, SIMULATE LOAD; 3. SQUADS ONE AND THREE, FROM RIGHT TO LEFT; 4. SQUADS TWO AND FOUR, FROM LEFT TO RIGHT; 5. ONE (TWO OR THREE) LEADS; 6. TARGETS. At the command TARGETS, the targets are operated at the prescribed speed. Half of the pupils (two squads—one and three) on the nonoverhead firing point mentally apply the target length in measuring the announced lead. They direct their aim on that point, and, while maintaining the aim, squeeze the trigger until the shot is fired. *They continue to aim during the entire length of travel of the target, regardless of the time at which the shot was fired.* When the target reaches the end of its run, riflemen quickly swing their point of aim back to the starting point, reload without taking the rifle from the shoulder, and promptly begin to aim when the target appears. They fire one shot each time the target crosses from their left to right. Pupils of the other two squads (two and four) aim and fire one shot in the manner prescribed above each time the target crosses from their right to left. The exercise is then repeated, having squads three and four LOAD, and squads one and two SIMULATE LOAD. Squads one and two next fire in the direction opposite to the

one in which they just fired. Finally, squads three and four fire in the direction of travel opposite to that at which they previously fired. Coaches and pupils then change places and the entire process is repeated.

(6) Pupils on the overhead target fire one round each time the target is operated—those assigned to an approaching target fire only as that target approaches the firing point and those assigned to a receding target fire only as that target recedes from the firing point. Applying the announced lead, all pupils aim, squeeze the trigger, follow through, and then swing back to the starting point, as described above for the pupils firing on the nonoverhead targets. The commands illustrated in b(5) above are made applicable to overhead target firing by substituting the words "approaching targets," and "receding targets," for "right to left" and "left to right," respectively.

(7) When firing on parachute targets, the men on the firing point being in the designated firing position, the officer in charge of firing commands: 1. SQUADS ONE (TWO) AND THREE (FOUR), LOAD; 2. SQUADS TWO (ONE) AND FOUR (THREE), SIMULATE LOAD; 3. ZERO (ONE) LEAD; 4. TARGETS. At the command TARGETS, squad one fires four rounds while squad two simulates firing four rounds at the right descending target. When the left target reaches the top of the carrier and starts down, squad three fires four rounds on that target during its descent while squad four simulates firing thereon. After all pupils have fired, coaches and pupils change places, and the exercises are repeated in the same manner until all men have fired.

(8) Four rounds constitute a score. However, nonoverhead and overhead targets are usually operated for five complete round trips. Thus, men whose rifles have malfunctioned (jammed) are allowed an opportunity to fire remaining shots. After each string of four rounds has been fired, targets are scored, and the shot holes are marked. One method for such marking is to place a piece of white chalk on the shot hole and give the chalk a quick twist.

(9) One point is awarded for each hit in the silhouette when using one lead, or for each hit in the proper scoring space when using more than one lead.

(10) Half groups alternate firing and simulating firing.

(11) When front-rank men have fired two scores, one score in each direction, they change places with the men in the rear rank.

(12) This procedure is followed until all men of the group have performed the required firing at that target.

(13) Upon completion of the firing prescribed in table I below, for any one type of target, the group moves to another type of target and continues until all have completed the instruction firing.

TABLE I.—*Instruction firing (range 500 inches)*

Target	Sitting	Kneeling	Standing	Total
Horizontal	1 lead	2 leads	3 leads	24
	{ 4 rounds L to R..... 4 rounds R to L.....	{ 4 rounds L to R..... 4 rounds R to L.....	{ 4 rounds L to R..... 4 rounds R to L.....	
Climbing or diving	1 lead	2 leads	3 leads	24
	{ 4 rounds L to R..... 4 rounds R to L.....	{ 4 rounds L to R..... 4 rounds R to L.....	{ 4 rounds L to R..... 4 rounds R to L.....	
Overhead	0 lead	0 lead	1 lead	24
	{ 4 rounds approach- ing..... 4 rounds receding..	{ 4 rounds approach- ing..... 4 rounds receding..	{ 4 rounds approach- ing..... 4 rounds receding..	
Parachute	0 lead 4 rounds.....	0 lead 4 rounds.....	1 lead 4 rounds.....	12

Speed of all targets except the parachute target, 15 feet a second.  
Speed of the parachute target, 1 foot a second.

(14) Modifications of the above method of firing to meet local conditions are authorized.

■ 85. GROUP FIRING.—*a. General.*—(1) Group firing is the final phase of antiaircraft marksmanship training on the miniature range and follows preparatory marksmanship training and instruction firing.

(2) It provides for competitions and illustrates the effectiveness of the combined fire of a number of riflemen.

*b. Procedure.*—(1) Two silhouettes, one to be fired upon as the target moves from left to right and one to be fired upon as the target moves in the opposite direction, are assigned to each squad or similar group (fig. 51).

(2) All men are arranged as shown in figure 44①. All pupils fire four rounds on assigned silhouettes as the target

moves from right to left and then repeat the exercise from left to right. Coaches and pupils change places, and the exercise is repeated.

(3) A lead of one target length must be used.

(4) Targets are not scored until completion of the firing of the entire squad or group.

c. *Scoring.*—A value of one is given each hit on the silhouette. The total number of hits on the two silhouettes assigned to any squad constitute the squad score.

## SECTION V

### TOWED-TARGET AND RADIO-CONTROLLED-AIRPLANE-TARGET FIRING

¶ 86. GENERAL.—a. The types of targets employed in towed-target and radio-controlled-airplane-target firing, using armor-piercing, ball, or tracer, or a combination of tracer and one of the other types of ammunition are—

(1) *Towed-sleeve targets*, 15 feet long, with a diameter of 3 feet at the forward end and 1 foot at the rear end.

(2) *Towed-flag targets*, 40 feet by 9 feet, equipped with weights so that the width (9 feet) is displayed to the rifleman as width when the target is moving directly toward (or directly away from) the man, and as height, when the target is moving across his front.

(3) *Radio-controlled-airplane targets*, approximately 10 feet long, with a 12-foot wing spread and a height of approximately 2 feet.

NOTE.—Prior to actual firing, practice in aiming and leading and trigger-squeeze exercises should be conducted, using airplanes as targets.

b. Towed-target or radio-controlled-airplane-target firing will follow miniature range instruction firing. If a unit is unable to conduct miniature range firing because of lack of facilities, it may nevertheless conduct towed-target and radio-controlled-airplane-target firing, if antiaircraft marksmanship preparatory training has been completed.

c. A hit on the engine or radio of the radio-controlled-airplane target will cause the parachute to open. The command to cease firing will be given as soon as the parachute is released.

■ 87. COURSES TO BE FIRED.—Units authorized to fire will fire one or more of the courses enumerated in tables II and/or III below.

TABLE II.—Towed-target courses to be fired

Course	Type of flight	Altitude of target	Horizontal range of course (yards) <sup>1</sup>	Speed (mph)	Remarks
1	Nonoverhead — horizontal (parallel to firing line from left to right).	Minimum consistent with safety.	Minimum, 100; maximum depends on width of danger area of range.	15-foot sleeve — 140. 40-foot flag—165.	See fig. 53.
2	Nonoverhead — horizontal (parallel to firing line from right to left).	do	do	Maximum possible	Do.
3	Overhead (perpendicular to firing line).	do	Minimum, maximum: in accordance with safety precautions.	do	See fig. 54.
4	Combined courses 1, 2, and 3.	do	Same as for courses 1, 2, and 3.	do	See fig. 55.

<sup>1</sup> The horizontal distance from the firing point directly under the target.

TABLE III.—Radio-controlled airplane target courses to be fired (fig. 56)

Course	Type of flight	Ground range to nearest 25 yards	Altitude to nearest 25 feet	Slant range in yards (approx.)	Speed (mph)	Number of runs
1	Nonoverhead.....	300	200	300	95	{ 1 L to R. 1 R to L.
2	Nonoverhead.....	300	800	400	95	{ 1 L to R. 1 R to L.
3	Nonoverhead.....	300	1,200	500	95	{ 1 L to R. 1 R to L.
4	Overhead.....	550-150	750	600-300	95	1 Approaching.
5	Overhead.....	150-550	750	300-600	95	1 Receding.
6	Overhead diving...	550-150	750-250	600-175	Max.	1 Approaching.
7	Overhead climbing.	150-550	250-500	175-600	Max.	1 Receding.
8	Oblique diving....	500-225	1,000-600	600-300	Max.	1 Incoming.
9	Oblique climbing..	225-500	600-750	300-600	Max.	1 Outgoing.

NOTE.—Courses 1, 2, and 3 will be flown on an arc of constant range, elevation, and speed. The maximum slant range for all courses should not exceed 600 yards.

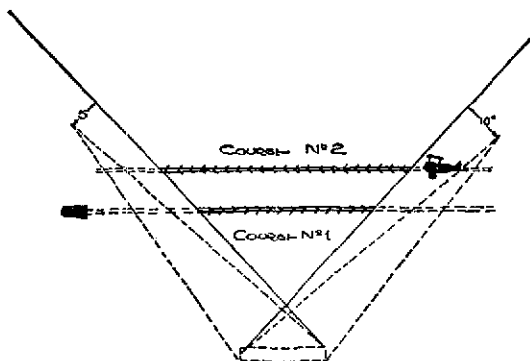

FIGURE 53.—Towed-target courses Nos. 1 and 2.

■ 88. PROCEDURE OF FIRING.—*a.* The riflemen to fire take their places on the firing line with an interval of at least  $1\frac{1}{2}$  yards between each man. They then assume the anti-aircraft firing position designated by the officer in charge



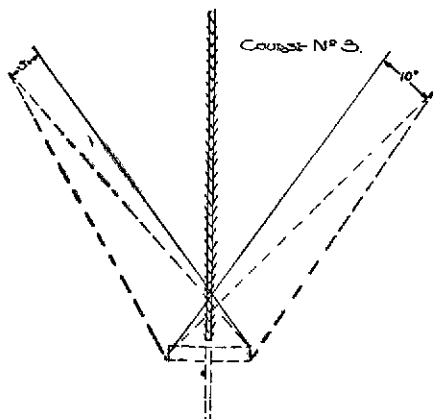

FIGURE 54.—Towed-target course No. 3.

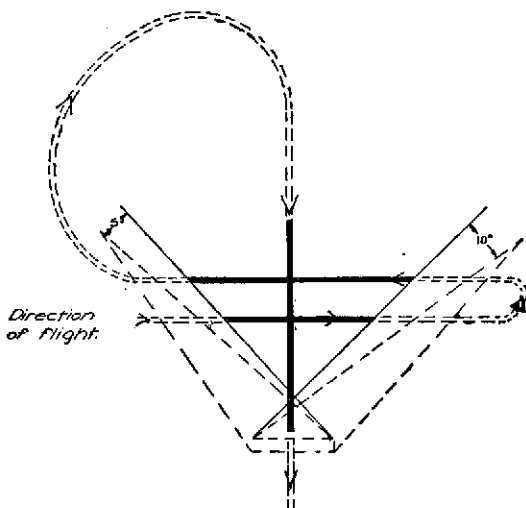

FIGURE 55.—Towed-target course No. 4.

of firing. (For safety reasons, the reclining position will not be used in firing at the radio-controlled-airplane target.)

b. The officer in charge of firing takes position in rear of the center of the firing line.

c. A safety officer will be stationed on each flank of the firing line.

d. As the target approaches the left (right) side of the danger area, the officer in charge of firing gives the com-

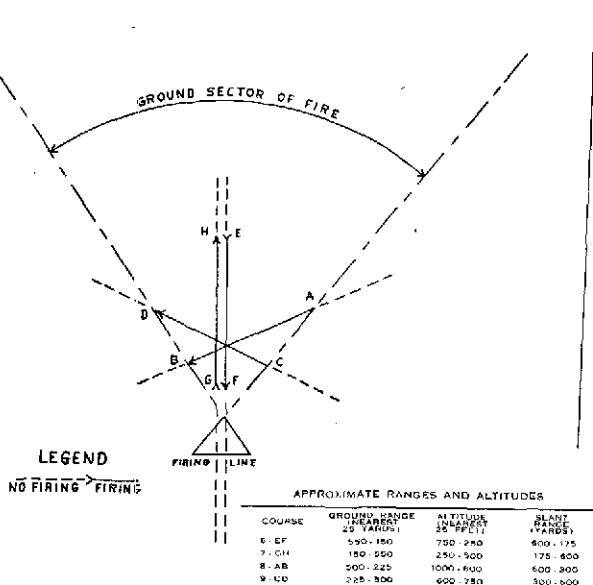

FIGURE 56.—Radio-controlled-airplane-target course.

mand: 1. (SO MANY) ROUNDS, LOAD; 2. TARGET FROM THE LEFT (RIGHT). Each rifleman loads and locks his rifle.

e. As the target approaches the danger area, the officer in charge of firing commands: 3. SIX (OR SO MANY) LEADS (par. 159c). At this preparatory command, each rifleman unlocks his rifle, aims by swinging to the announced lead, pivoting at the waist, and maintains the estimated lead.

*f.* In firing at crossing targets, the safety officer stationed at the end of the firing line opposite to the target's approach will, by prearranged signal, indicate to the officer in charge of firing that the target is within the danger area. The latter will then signal or command: **COMMENCE FIRING**. The safety officer at the end of the firing point opposite the target's departure will observe the flight of the target, and when it is about to leave the danger area he will so indicate by prearranged signal to the officer in charge of firing, who will at once signal or command: **CEASE FIRING**. Assistants and coaches will repeat this command to insure that all riflemen hear it.

*g.* (1) In firing at overhead targets (towed sleeve or flag), the same procedure is followed except that the officer in charge of firing (from his position behind the center of the firing line) determines when firing commences and ceases. He gives the command or signal **COMMENCE FIRING** when the towing plane is 50 yards or less in front of the firing line. He gives **CEASE FIRING** before the sleeve is 100 yards in front of the firing line (par. 169*d*).

(2) In firing at diving and overhead radio-controlled-airplane targets, the officer in charge of firing will, by prearranged signal, determine from the safety officers that the target is within the safety limits. As the target crosses the 550-yard limit of the firing area, the officer in charge of firing signals or commands: **COMMENCE FIRING**. At this command, riflemen open fire, and, maintaining the proper lead, continue firing until the signal or command **CEASE FIRING** is given by the officer in charge of firing. This command is given when the target is 150 yards in front of the firing line (see table III of par. 87 and par. 169*d*). Assistants and coaches will repeat this command to insure that all riflemen hear it.

■ 89. **SCORING.**—*a.* Previous to firing, all shot holes in the target must be painted over or pasted.

*b.* (1) On the towed sleeve, the number of hits is found by dividing the number of holes in the target by two. An odd hole is counted as a hit.

(2) On the flag or radio-controlled-airplane target, the number of hits found in the target is counted.

c. A record is kept of the number of seconds elapsed in each run of the target between the commands **COMMENCE FIRING** and **CEASE FIRING**.

d. The total number of hits on the target, divided by the number of seconds fired, will give the number of hits a second.

## SECTION VI

### RANGES, TARGETS, AND EQUIPMENT

■ **90. RANGE OFFICER.**—A range officer is appointed well in advance of range practice. His chief duties are—

a. To make timely estimates for material and labor necessary to place the range in proper condition for firing.

b. To supervise and direct the repairs and alterations to installations.

c. Where safety demands, to instruct and supervise range guards.

■ **91. MINIATURE RANGE.**—a. The miniature range consists of—

(1) One horizontal target (fig. 57 ①).

(2) One double climbing-and-diving target (fig. 57 ②).

(3) One overhead target (fig. 57 ③).

(4) One parachute target (fig. 57 ④).

b. A suggested arrangement of the targets is shown in figure 58.

c. For details of targets when firing is being conducted at the miniature range firing points, see figures 45 to 51, inclusive, and paragraphs 79 and 85.

d. For details of range apparatus, see figures 56 to 61, inclusive, and TM 9-855.

e. (1) The danger area required is dependent upon the type of ammunition. (See AR 750-10 for size and shape.)

(2) The miniature range may be laid out in the manner described in *a* and *b*, above. Care must be taken to insure that the firing line and targets are placed so that no fire will fall outside of the danger area.

f. If the organization for training is as suggested in paragraph 79b, the following equipment is necessary:

80 caliber .22 rifles (if available).

7 aiming and leading targets (figs. 45, 46, and 47).

(Each of these targets consists of a piece of beaver-

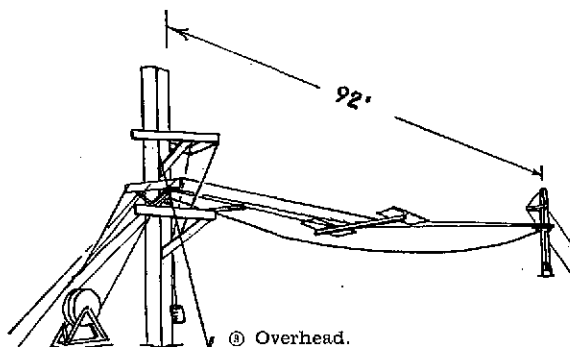
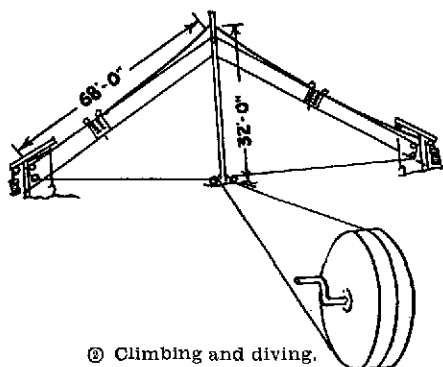
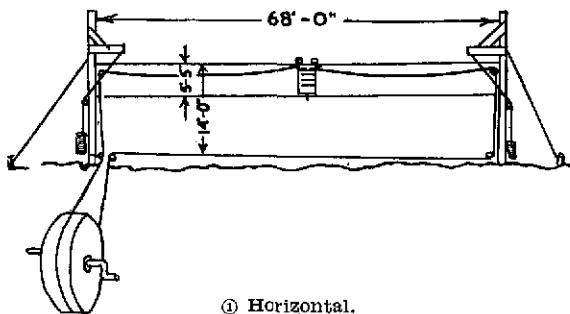
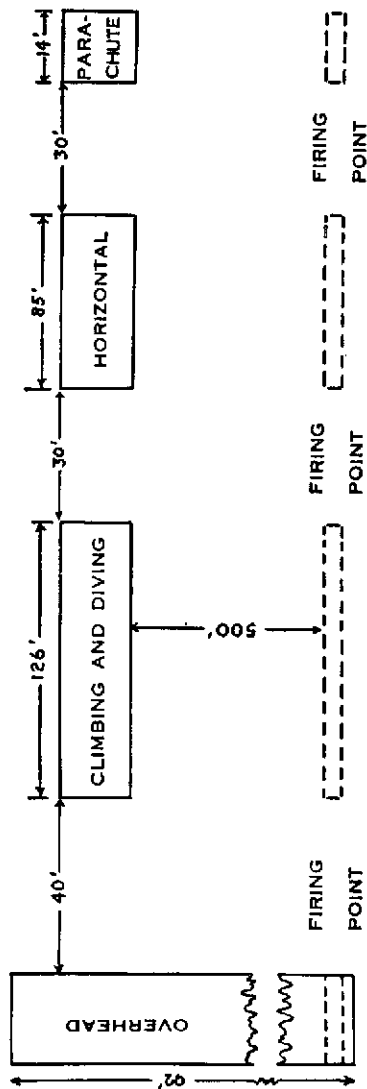

FIGURE 57.—Types of miniature range targets.





(32)

(64)

(32)

(32)

FIGURE 58.—Arrangement of targets.

NOTE.—The figures shown below each firing point indicate the number of men who can be satisfactorily trained on such a range. If an increased capacity is desired, appropriate increase in available facilities should be made.

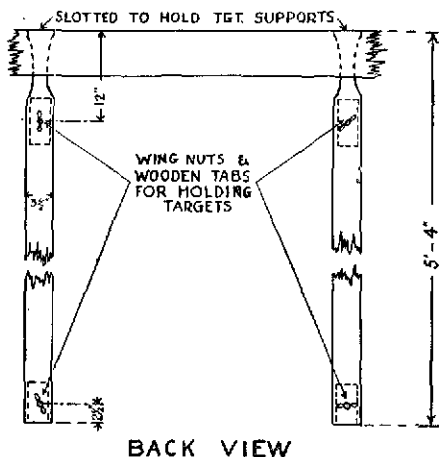
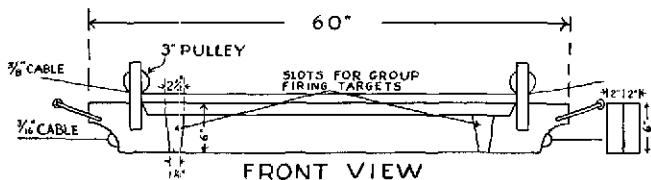

SUPPORTS FOR INDIVIDUAL FIRING TARGETS  
 FIGURE 59.—Nonoverhead target carrier.

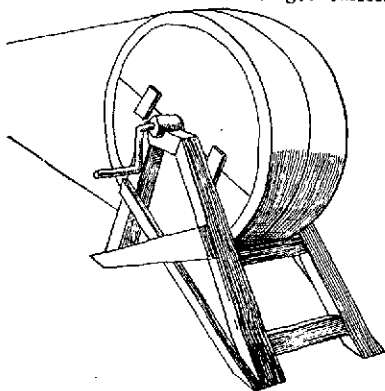

FIGURE 60.—Cable drum.



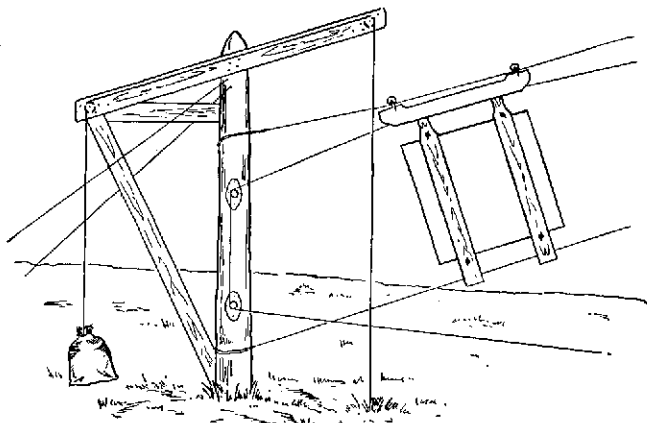

FIGURE 61.—Details of climbing and diving target—rear view.

board on which the silhouettes are pasted or stenciled.)

6 instruction firing targets for each range (figs. 48, 49, and 50.) (The overhead and parachute targets

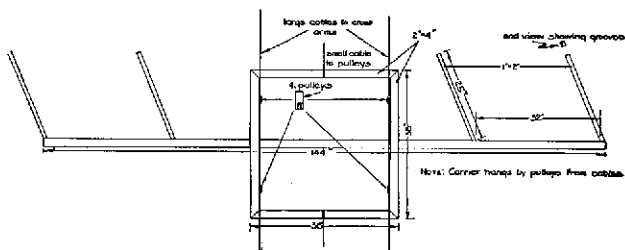

FIGURE 62.—Overhead target carrier.

are the same as the aiming and leading overhead and parachute targets with the exception that the pasters are eliminated.)

1 score card for each man.

**INDIVIDUAL SCORE CARD**  
**ANTI-AIRCRAFT RIFLE MARKSMANSHIP**

Name \_\_\_\_\_ Date \_\_\_\_\_, 19\_\_\_\_

Target	0 lead			1 lead			2 leads			3 leads		
	Rounds fired	Hits	Percent	Rounds fired	Hits	Percent	Rounds fired	Hits	Percent	Rounds fired	Hits	Percent
Horizontal												
Climbing												
Diving												
Overhead												
Parachute												
Total												

■ 92. FIELD FIRING.—*a.* In selecting the location of a range for field firing at aerial targets, the danger area is the chief consideration. (See AR 750-10.)

*b.* The firing point should accommodate at least 50 men in line with a  $1\frac{1}{2}$ -yard interval between men. A level strip of ground 75 yards long and 2 yards wide, preferably on a hill, is suitable. A firing point similar to the firing point of a known-distance rifle range may be built.

*c.* (1) After the range has been selected, the firing point, limits of fire, and danger area should be plotted on a map or sketch of the area.

(2) From this map or sketch, the range is then laid out on the ground. First, each end of the firing point is marked

by a large stake. The right and left limits of fire are then marked by a post. The posts are located in azimuth by the following method: To locate the post marking the left limit of fire, an aiming circle or other angle-measuring instrument is set up at the stake on the right end of the firing point. It is then oriented and laid on an azimuth which, by reference to the map or sketch, is known to be the farthest to the left that the rifle at the right end of the firing point can safely be fired. The post marking the right limit of fire is similarly located with the instrument set up at the stake on the left end of the firing point. Each post is placed at the maximum distance at which it will be plainly visible from the firing point (fig. 63).

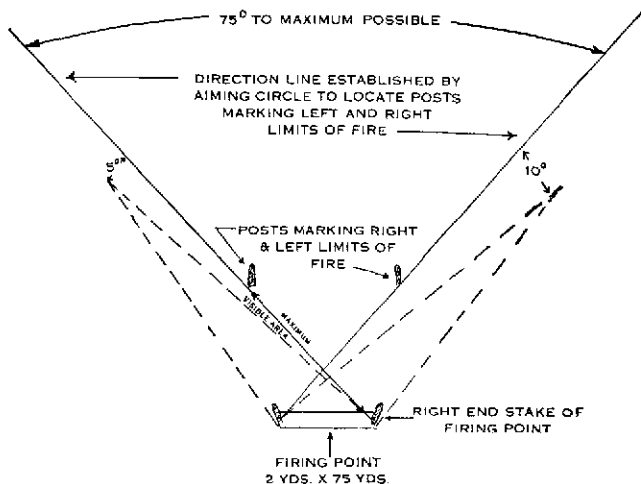

FIGURE 63.—Towed-target range showing firing point and limits of fire. (Dotted lines show danger area.)

(3) Direction guides for the towing airplane to follow should, within the limits of fire, be distinctly marked on the ground for each course. White targets of the machine-gun type, or strips of target cloth placed flat on the ground about 30 feet apart, are suitable. A terrain feature such as a beach line may also be used.

■ 93. TARGETS.—The targets used in towed-target firing are sleeve or flag targets furnished by the Army Air Forces unit assigned the towing mission (par. 86). They are returned to the Army Air Forces unit after they have been scored. Radio-controlled-airplane targets will be obtained through the division commander.

■ 94. INSTRUCTIONS TO PILOTS FOR TOWING MISSIONS.—*a.* Towed-target firing requires the closest cooperation between the pilot of the towing airplane and the officer in charge of firing. Decisions affecting the safety of the airplane tests with Army Air Forces personnel.

*b.* The air mission for towed-target firing should be specifically stated. The commanding officer requesting airplanes for towed-target firing should furnish, in writing, to the Army Air Forces unit commander concerned the following information:

- (1) Place of firing.
- (2) Date and hour of firing.
- (3) Number of missions to be flown; altitude, course, speed, and number of runs for each mission.
- (4) Ground signals to be used, including marking of course.
- (5) Map of the area with the firing line, angle of fire, danger area, course of each mission, and location of the grounds for dropping targets and messages plotted thereon. An alternate dropping ground should be designated when practicable, with either or both dropping grounds subject to approval by the pilot.
- (6) Length of the towline, within limits established by the Army Air Forces and subject to approval of the pilot.
- (7) Number of targets required.

*c.* Whenever practicable, the officer in charge of firing will discuss with the pilot the detailed arrangements mentioned in *b* above. This discussion should take place where the various range features can be pointed out to the pilot.

■ 95. SIGNALS.—*a.* Direct radio communication is the most effective means by which the officer in charge of firing and the pilot of the towing airplane maintain contact with each other. Even though radio is being used, panels should be available for use in case radio communication fails.

b. For signaling from the ground to the pilot, any method agreed upon by the officer in charge of firing and the pilot of the towing airplane may be used. The panel signals generally used are as follows:

Stand by.....	0 0 2.
Ready fire.....	0 0 0.
Repeat run No. 1.....	0 9 1.
Repeat run No. 2.....	0 9 2.
Repeat run No. 3.....	0 9 3.
Repeat course.....	0 9 4.
Mission complete.....	Pick up panels.

c. The pilot may also communicate with the officer in charge of firing by dropping messages or by rocking his wings.

## CHAPTER 5

### TECHNIQUE OF FIRE OF RIFLE SQUAD

	Paragraphs
SECTION I. General.....	96-98
II. Range estimation.....	99-103
III. Target designation.....	104-107
IV. Rifle fire and its effect.....	108-114
V. Application of fire.....	115-122
VI. Landscape-target firing.....	123-130
VII. Field-target firing.....	131-134
VIII. Destruction of ordnance matériel.....	135

#### SECTION I

#### GENERAL

■ 96. **DEFINITIONS.**—*a.* The training of riflemen for combat is progressive. It includes three phases. The *first phase* is individual training and comprises such allied subjects as rifle marksmanship, extended order, drill and combat signals, and certain elements of scouting and patrolling. The *second phase* covers the technique of fire. This is team training in the application and control of the collective fire of rifle fire units. In the *third phase* the individual and team training of the first and second phases are combined with tactical training. This phase is called combat firing. This chapter deals with the second phase of training.

*b.* *Collective fire* is the combined fire of a group of individuals.

*c.* A *fire unit* is a unit whose fire in battle is under the immediate and effective control of its leader. The usual rifle fire unit is the rifle squad.

■ 97. **IMPORTANCE OF RIFLE FIRE.**—Effective rifle fire is a characteristic of successful infantry. It is an element which may determine the issue of battle. Collective fire is most effective when it is the product of teamwork. Training in the technique of fire, as set forth in this chapter, is designed to

train rifle squads to act as efficient and dependable teams in the application and control of collective fire.

■ 98. SCOPE.—*a.* Although training in the technique of fire does not involve the solution of tactical situations, a tactical situation is presented in each exercise to form the basis for instruction in the principles of technique of fire. Such subjects as the use of cover and concealment in the selection and occupation of positions, the selection and engagement of targets, and the application of fire should be included in the training in technique of fire. The instruction is progressive and is divided into six consecutive steps. Each step includes some or all of the technique learned in previous steps. The six steps are—

- (1) Range estimation.
- (2) Target designation.
- (3) Rifle and automatic rifle fire and their effect.
- (4) Application of fire.
- (5) Landscape-target firing.
- (6) Field-target firing.

*b.* It is not essential that perfection be reached in each step before proceeding to the next step. It is better to reach the required standard by repeating in succeeding steps all that has been learned before. It is necessary, however, that each step be understood before proceeding to the next. The instructor explains each step in detail. He then makes plain its relation to the subject as a whole. This is followed by a demonstration, which in turn is explained by the instructor. The men then practice the principles and methods that have been explained and demonstrated. Exercises pertaining to the various steps are described in detail in this chapter. They can be used for demonstrations and for instruction practice. Some of them can be used to test fire units, thus introducing the desirable element of competition. These exercises may be changed to conform to local conditions.

## SECTION II

### RANGE ESTIMATION

■ 99. IMPORTANCE.—In battle, the effectiveness of rifle fire depends in large measure upon the ability of riflemen to estimate ranges quickly and accurately.

■ 100. METHODS.—Only three methods of estimating ranges are taught in the technique of rifle fire. They are—

- a. Use of tracer bullets.
- b. Observation of fire.
- c. Estimation by eye.

■ 101. USE OF TRACER BULLETS.—When the range to a target is being estimated by the use of tracer bullets, one of the scouts or the leader estimates the range by eye, sets his sight for that range, and fires a tracer bullet, the path and strike of which are observed by the second scout or a designated observer. The observer announces the result of the shot to the rifleman. The rifleman corrects the sight setting according to this information and continues to fire and correct the sight setting until the observer indicates that the tracer appears to strike the target. He then announces by voice or signal the range setting required to hit the target, taking into consideration the zero of his rifle.

■ 102. OBSERVATION OF FIRE.—This method can be used when the ground is dry and the strike of the bullets can be seen. The procedure is the same as that used in determining the range by tracer bullets. The following points must be taken into consideration:

a. Dust will appear slightly above the striking point of the bullet.

b. As seen from the firing point, dust appears on the side toward which the wind is blowing; for example, if the wind is blowing from right to left, dust will appear to the left of the point of impact.

c. As seen from a point on the flank, shots that hit beyond the target appear to strike on the side on which the observer is posted; those which fall short appear to strike on the side away from the observer.

■ 103. ESTIMATION BY EYE.—*a. Necessity for training.*—In combat, ranges are usually estimated by eye. Untrained men make an average error of 15 percent of the range when estimating by eye. Hence a definite system of range estimation, coupled with frequent practice on varied terrain, is essential to accuracy with this method.



*b. Unit-of-measure method.*—(1) Ranges less than 500 yards are measured by applying a mental unit of measure 100 yards long. Thorough familiarity with the 100-yard unit and its appearance on varied terrain and at different distances is necessary if the soldier is to apply it accurately.

(2) Ranges greater than 500 yards are estimated by selecting a point halfway to the target, applying the unit of measure to this halfway point, and then doubling the result.

(3) The average of a number of estimates by different men is usually more accurate than a single estimate. This procedure may be used when time permits.

*c. Appearance of objects.*—In some situations, much of the ground between the observer and the target is hidden from view, which makes the application of the unit of measure impossible. In that event, the range is estimated by the appearance of objects. Whenever the appearance of objects is used as a basis for range estimation, the observer must make allowance for the following effects:

(1) Objects seem nearer—

(a) When the object is in a bright light.

(b) When the color of the object contrasts sharply with the color of the background.

(c) When the observer is looking over water, snow, a wheat field, or any uniform surface.

(d) When the observer is looking downward from a height.

(e) In the clear atmosphere of high altitudes.

(f) When the observer is looking over a depression most of which is hidden.

(2) Objects seem more distant—

(a) When the observer is looking over a depression most of which is visible.

(b) When there is poor light or a fog.

(c) When only a small part of the object can be seen.

(d) When the observer is looking from low ground toward higher ground.

*d. Exercises.*—(1) *No. 1.*—(a) *Purpose.*—To familiarize the soldier with the unit of measure—100 yards.

(b) *Method.*—The unit of measure (100 yards) is previously staked out on one or more courses over varied ground (fig. 64), using markers that will be visible up to 500 yards.

In order to familiarize the men with the appearance of the unit of measure, they are conducted to a starting point, which should be centrally located if more than one course is to be practiced. They are then moved to a point within 100 yards (400-yard marker) of the selected 500-yard marker and are formed approximately on a line facing that marker. Then they are required to move back toward the starting

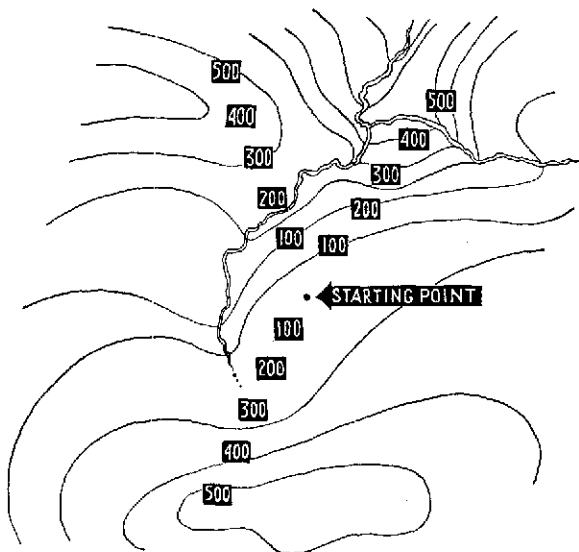

FIGURE 64.—Area used for teaching the 100-yard unit of measure—schematic diagram.

point until all are on line with the 300-yard marker, thus actually being 200 yards from the 500-yard marker. Successively, they are moved to a point on line with the 200- and 100-yard markers, thence to the starting point. At each of the stopping points, men are required to study the appearance of the unit of measure and to apply it successively up to 500 yards. This exercise should be practiced at each of the several ranges in the prone, sitting, squatting, kneeling, and standing positions. The unit receiving instruction

may be divided into two or more smaller groups, each practicing successively on the several courses. The exercise is repeated until the desired proficiency is attained.

(2) *No. 2.—(a) Purpose.*—To illustrate the application of the unit of measure.

(b) *Method.*

1. Ranges up to 900 yards are measured accurately and marked at every 100 yards by large markers or target frames, each bearing a number to indicate its range. Men undergoing instruction are placed about 25 yards to one side of the prolonged line of markers and are directed to use a hat or some other object as an eye cover to exclude from view all of the markers. They are then directed to apply the unit of measure five times along a straight line parallel to the line of markers. When they have selected the final point, the eye cover is removed, and the estimations of the successive 100-yard points and the final point are checked against the markers. Accuracy is gained by repeating the exercise.

2. Ranges greater than 500 yards are then considered. With the markers concealed from view, men estimate the ranges to points which are obviously more than 500 yards away and a little to one side of the line of markers. As soon as they have announced each range, they remove their eye covers and check the range to the target and to the halfway point by means of the markers. Prone, sitting, kneeling (or squatting), and standing positions are used during this exercise.

(3) *No. 3.—(a) Purpose.*—To give practice in range estimation.

(b) *Method.*—From a suitable point, ranges are measured to objects within 1,000 yards. The men are required to estimate the ranges to the various objects as they are pointed out by the instructor, writing their estimates upon paper or range cards previously issued (par. 161b). At least one-half of the estimates are made from the prone or sitting (squatting) positions. Thirty seconds are allowed for each esti-

mate. When all ranges have been estimated, the papers are collected and the correct ranges are announced to the class. To create interest, individual estimates and squad averages may be posted on bulletin boards.

(4) *No. 4.—(a) Purpose.*—To demonstrate a soldier's appearance at various ranges.

(b) *Method.*

1. From a suitable point, measure off 500 yards across smooth terrain; place men at 100-yard intervals and have them take concealed positions. As an introduction, the men undergoing instruction are told that they will have an opportunity to study the appearance of men at various ranges.
2. On signal, have all men stand. Instruct the group to observe the gradual disappearance of detail (facial features, helmet, belt, rifle, hands, and leggings), and the fact that men seem to get smaller and smaller as the distance increases. Call attention to distances at which various details vanish.
3. On signal, have the posted men kneel. Have the group study the appearance of the posted men. Call attention to the fact that details fade out at shorter ranges than when the men were standing.
4. On signal, have the posted men take up prone firing positions with rifles aimed at the group. Have the group study the appearance of the posted men. Call attention to the fact that details fade out at shorter ranges than when the men were either standing or kneeling.
5. This exercise should be conducted both looking into the sun and away from the sun.

### SECTION III

#### TARGET DESIGNATION

■ 104. **IMPORTANCE.**—Target designation is a vital element in the technique of rifle fire. Battlefield targets are usually so indistinct that leaders and individual soldiers must make

every attempt to designate their location and extent carefully and accurately. Enemy troops are ordinarily so well concealed that individual enemy soldiers are not visible. To cover such a target, squad leaders must be able to designate the area in which hostile troops are located, and members of the squad must be trained to place heavy fire on the designated area even though no definite targets are visible.

■ 105. TOPOGRAPHICAL TERMS.—Prior to instruction in target designation, riflemen should understand those topographical terms most frequently used in designating targets; for example, crest, military crest, hill, cut, fill, ridge, bluff, ravine, crossroads, road junction, skyline (fig. 65).

■ 106. TARGET DESIGNATION.—*a. General.*—(1) A complete target designation includes the following elements:

- (a) Range (how far to look).
- (b) Direction (where to look).
- (c) Description (for what to look).

(2) These elements are always given in the above sequence, with a slight pause between each element. An exception to this rule occurs when the target is expected to be visible for a short time only. In such cases, the target is pointed out as quickly as possible with a brief oral description as, for example, "Those men."

*b. Range.*—Range tells the man *how far* he must look to see the target when the direction is announced. It is announced first so that the man may set his sights and be ready to fire as soon as the two remaining elements of target designation are given and understood. It may be given either by voice or by arm-and-hand signal, and is determined by visual estimation or by observing the strike of bullets on the ground or the path of tracer bullets.

*c. Direction.*—Direction tells the man *where* to look and may be indicated in the following three ways, or combinations thereof:

(1) *Orally.*—The term "front" (left front, right front, left flank, right flank, right rear, left rear, and rear) may be used to indicate the general direction of the target (fig. 66).

(2) *Pointing.*—In pointing, either the arm or rifle may be used. When using the rifle to indicate the direction to a

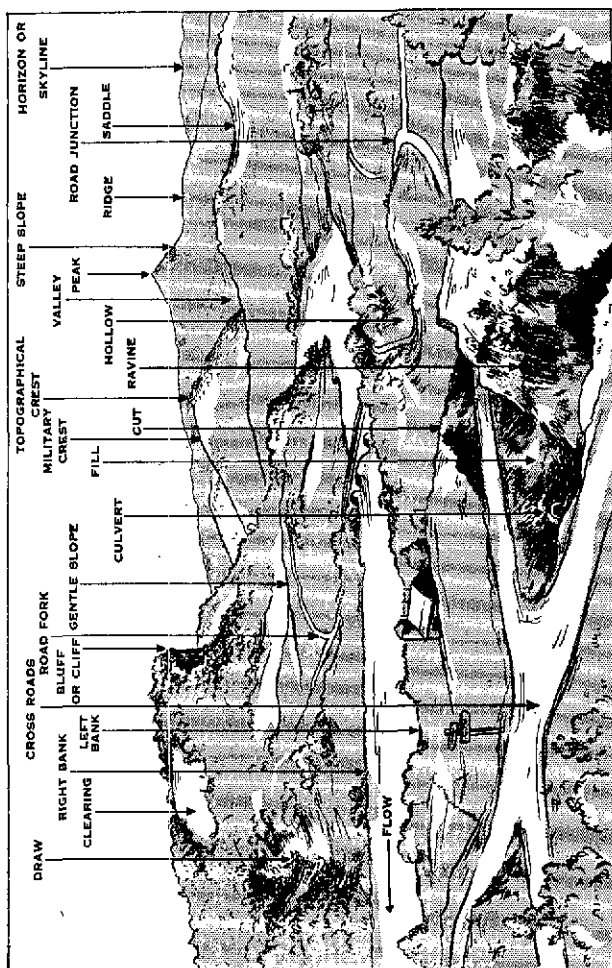

Figure 65.—Topographical terms.

target, cant the rifle to the right and aim it at the target; without moving the rifle, move the head to the left so as to permit the man behind to look through the sights and locate the target. If time permits, a bayonet may be stuck diagonally into the ground to serve as a rest for the rifle in order to keep it in place after it is laid on the target. Instead of

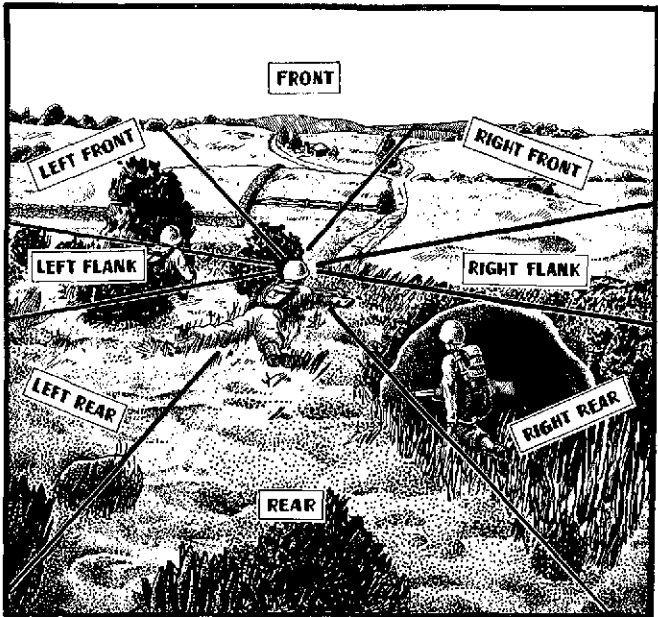

FIGURE 66.—Target designation—general direction.

the bayonet, a log, the crotch of a tree, or any other suitable rest may be used; or the automatic rifle may be pointed, using the bipod as a rest.

(3) *Tracer bullets.*—The use of tracer bullets is a quick and sure method of indicating the direction to an indistinct battlefield target and is the most accurate method of indicating the flanks of an obscure target. Tracers are invariably used when scouts or other members of the squad are already

under fire, when the squad is separated and out of range of the leader's voice or when cover is scarce so that the movement required for pointing out the target will expose personnel to hostile fire. Designating a target by tracers, notwithstanding its advantages, has certain limitations in that it may disclose the position of the rifleman and at the same time lessen the surprise effect of a sudden burst of fire laid on the enemy position. Before firing tracers it is helpful to indicate the general direction of the target orally in order that the squad members will be sure to look in the required direction to pick up the flight of the tracers.

*d. Description.*—Description tells the man *what* he is expected to see as well as the nature of his target—whether it is a point, linear, or oblique target, or one which extends in depth. Though oral designation is often used, battlefield conditions will rarely permit a leader thus to designate a target directly to all members of his unit. Therefore, when a scout or leader has preceded the squad, he frequently announces, "Range 500, right front, watch my tracer," and fires a tracer at the target. He then describes the target as "machine gun." To designate a linear target, the scout or leader indicates its limits by firing tracers at each flank. He also announces or signals any range or windage correction obtained by firing tracers.

*e. Examples of correct target designations.*—The simplest form of target designation is the most effective. The method adopted should be the one best suited to the conditions existing at the time the target appears. Troops must be trained to use all methods. The following examples illustrate how several types of targets may be designated in specific situations:

(1) *Target plainly visible, or near an easily recognized object or terrain feature.*—In such circumstances, a simple target designation will suffice, for example:

Range 425.

Left front.

Sniper at base of dead tree (point marked A in fig. 67).

(2) *Target invisible, indistinct, or not located near easily recognized object or terrain feature.*—In such circumstances, the direction to the target is indicated by the use of a ref-



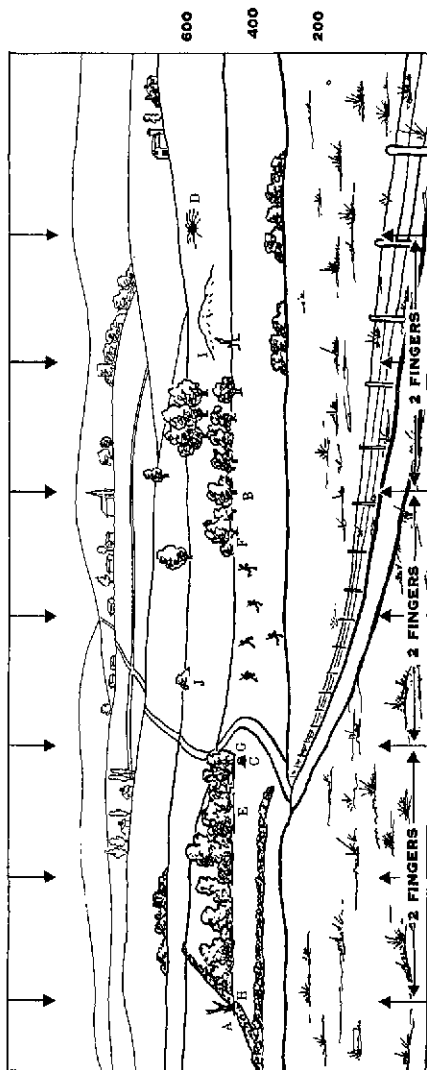

Figure 67.—Panoramic view used for teaching target designation.

erence point. The reference point selected should be one which can be easily identified by members of the squad concerned. It should not be subject to confusion with a nearby object or point. A reference point on line with and beyond the target will give greater accuracy than one located between the observer and the target. The reference point should be as near the target as practicable, in order that the target may be quickly and easily picked up by all members of the squad. For brevity, a reference point used in target designation is called "reference." The following examples indicate the use of the reference point in target designation:

(a) *Reference point on line with target.*

Range 450.

Front.

Reference: church spire.

Target: machine gun in edge of woods (fig. 67, target at B).

It will be noted that the range announced is that to the target and not to the reference point. When the word "reference" is used, the word "target" is also used to differentiate between the two objects. Another example is as follows:

Range 350.

Left front.

Reference: black stump.

Target: sniper on far side of road (fig. 67, target at C).

(b) *Reference point not on line with target—use of finger method to designate interval from reference point to target* (par. 107).—The interval to the right or left between the reference point and the target is measured in units called "fingers." If the hand is held so that the left edge of a finger is on line with the reference point and the right edge of that same finger is on line with the target, the target is one finger width to the right of the reference point. This interval is announced as "Right, one finger." If two fingers can be applied to this lateral interval, it is announced as "Right, two fingers." The following additional examples refer to figure 67 and illustrate this method:

1. *Target at D.*

Range 600.

Front.

Reference: church spire; right, two fingers.  
Target: enemy group in shell hole near crest.

2. *Target at E.*

Range 425.

Left front.

Reference: dead tree; right, 1½ fingers.

Target: sniper in edge of woods.

3. *Target at F.*

Range 450.

Front.

Reference: church spire; left, one-half finger.

Target: machine gun in corner of woods.

(c) *Use of fingers to indicate width or extent of targets (target G to H).*—The following example indicates the use of the finger method to point out the limits of a linear target:

Range 425.

Front.

Reference: church spire; left, two fingers.

Target: enemy groups in edge of woods extending left, two fingers.

(d) *Successive reference points.*—These may be used instead of finger measurements from one reference point (target at I):

Range 500.

Front.

Reference: church spire; to the right and at a shorter range, group of three trees; to the right and at the same range.

Target: machine gun at left end of mound of earth.

(e) *Combination of reference points and fingers.*—A combination of successive reference points and fingers may be used, as for example (target at J):

Range 600.

Front.

Reference: church spire; to the left and at a shorter range, lone tree; left one finger and at the same range.

Target: machine gun in clump of brush.

(3) *Variations.*—If one end of a target is considerably nearer than the other, the average range is announced, since dispersion will cover the target. Battlefield conditions impose many practical substitutions and combinations of methods in target designation. Frequently the squad leader is able to designate the target to only one or two members of his squad. Therefore, each member of the squad must be taught to assist in designating targets to other members of the squad team. At times the scouts designate the target to other members of the squad as they arrive in the vicinity. Former, long-winded, oral target designations confuse the men more often than they help.

■ 107. EXERCISES.—*a. No. 1.*—(1) *Purpose.*—To teach the use of fingers for lateral measurement.

(2) *Method.*—(a) A number of short vertical lines, 1 foot apart, are plainly marked on a wall or other vertical surface (fig. 68). At a distance of 20 feet from the wall, a testing line is drawn or marked out by stakes. The instructor explains that the vertical lines are one finger (50 mils) apart when measured from the testing line, and that they are used for the purpose of determining the distance from the eye at which the index finger must be held in order to cover the space between one of the vertical lines and the next line to the right or left.

(b) The instructor explains and demonstrates the use of the index finger in lateral measurement. First, he holds his hand, with palm to rear, index finger pointing upward, at such distance from his eye that the finger will cover the space between one vertical line and the next line to the right or left. He lowers his hand to his side without changing the angle of the wrist or elbow and notes the exact point at which the hand strikes the body. Thereafter, when measuring with the finger, he first places his hand at this point and raises his arm to the front without changing the angle of the wrist or elbow. His hand will be in the correct position for measuring fingers. The men then determine the proper distance of the finger from the eye as explained by the instructor. The men should practice until they know exactly how far from the eye to hold the finger. This should

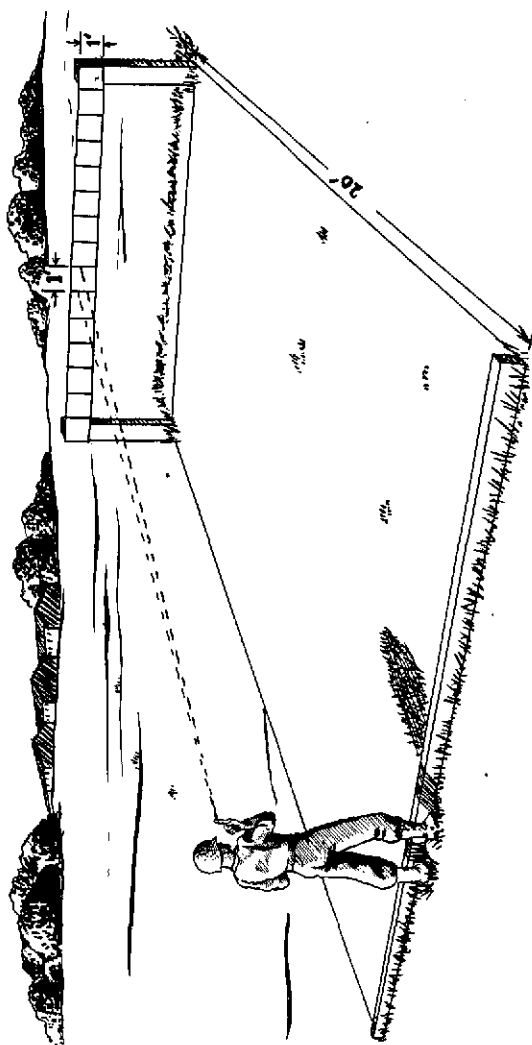

FIGURE 68.—Finger calibration court.

be done without reference to the point where the hand touched the body, so that they can use the finger measurement from any position. The instructor explains that the one-finger measurement may be repeated or two or three fingers may be used in measuring intervals between points.

(c) Using convenient objects within view, practice in making lateral measurement is given.

b. No. 2.—(1) *Purpose*.—To afford practice in target designation, indicating direction by oral description.

(2) *Method*.—(a). The squad is deployed and faced to the rear. The squad leader is at the firing point, where sandbags or bayonet rests have been provided for each rifle.

(b) At a prearranged signal, the target is indicated by displaying a flag, by firing a burst of blank cartridges from a machine gun, or by the operation of noise or smoke-producing equipment. When the squad leader states that he understands the nature and position of the target, the flag is withdrawn.

(c) The squad is then brought to the firing point and placed in the prone position. The squad leader, also in the prone position, estimates the range and gives his designation. Each man is required to set his sight, use the sandbag or bayonet rest, and sight his rifle on the point at which he believes the target is located.

(d) The instructor checks the designation given by the squad leader from a position similar to that assumed by the squad leader. The men are required to leave their rifles on the rests properly pointed until checked by the instructor or squad leader.

(e) After the rifles have been checked, the flag is waved again or another burst of blanks is fired so that all men may be given an opportunity to check on their knowledge as to the location of the target.

c. No. 3.—(1) *Purpose*.—To afford practice in target designation, indicating direction by pointing with the rifle.

(2) *Method*.—(a) The squad is formed facing the rear. The instructor points out the target to the squad leader, who takes the kneeling or prone position, estimates the range, adjusts the rear sight, alines his sights on the target, and calls "Ready."

(b) The members of the squad then move in turn to a position directly behind the squad leader and look through the sights until they have located the target. The range and a brief description of the target are given orally by the squad leader to each individual.

(c) As soon as each man has located the target, he moves to the right or left of the squad leader, sets his sight, places his rifle on a bayonet rest or sandbag, and alines his sights on the target.

(d) The instructor, assisted by the squad leader, verifies the sight setting and the alinement of the sights of each rifle.

d. No. 4—(1) Purpose.—To afford practice in target designation, indicating direction by firing tracers.

(2) Method.—(a) A concealed target representing a machine gun is placed near a pit or other bulletproof shelter. About 500 yards in front of the target, a firing position suitable for a squad is selected. The location of the target will be visible from the firing position, but the target itself may be invisible because of its concealment. This concealment should have a natural appearance in order not to attract attention.

(b) The squad is deployed along the firing position, and all except the scouts are then faced to the rear.

(c) The scouts take the prone position and are told that the waving of a red flag to their front will represent the fire and smoke from a machine gun.

(d) A man stationed in the pit waves a flag in front of the target for about 30 seconds and retires to the protection of the pit.

(e) The squad is faced to the front, and men take the prone position with their rifles loaded and locked. The scouts use tracer ammunition and the remainder of the squad use ball or armor-piercing ammunition.

(f) One scout estimates the range, adjusts his rear sight, alines his sights on the target, and opens fire. He adjusts his sights by increasing or decreasing his elevation as directed by the other scout, who observes the fire. In thus determining the correct range, the scouts have also identified the target for the remainder of the squad. The scouts then announce the range, which is passed orally from man to man.

(g) As soon as each man understands the location of the target, he sets his sight and opens fire.

(h) The instructor causes firing to cease shortly after all men commence firing.

(i) Noncommissioned officers do not participate in the fire. Squad leaders move about freely behind their men and observe the fire. The assistant squad leader assists the squad leader.

(j) After firing ceases, sight settings are checked by the squad leader, and the target is examined or the hits are signaled to the squad.

#### SECTION IV

#### RIFLE FIRE AND ITS EFFECT

■ 108. **TRAJECTORY.**—*a. Nature.*—The trajectory is the path followed by a bullet in its flight through the air. Using M2 AP ammunition, the bullet leaves the rifle at a speed of 2,800 feet per second. Because of this great speed, the trajectory at short ranges is almost straight or flat.

*b. Danger space.*—The space between the rifle and the target in which the trajectory does not rise above a man of average height is called the "danger space." Over level or uniformly sloping ground, the trajectory for a range of 750 yards does not rise above 68 inches. Therefore, it is said that the danger space for that range over level or uniformly sloping ground is continuous between the muzzle of the gun and the target. For ranges greater than 750 yards, the bullet rises above the height of a man standing, so that only parts of the space between the gun and the target are danger spaces (fig. 69).

■ 109. **DISPERSION.**—Because of differences in ammunition, in aiming, in holding, and in the wind, a number of bullets fired from a rifle at a target are subject to slight dispersion. The trajectories of these bullets form a cone-shaped figure (fig. 70) called the cone of dispersion.

■ 110. **SHOT GROUPS.**—When the cone of dispersion strikes a vertical target, it forms a pattern called a vertical shot group. A shot group formed on a horizontal target is called



(H = MAXIMUM ORDINATE - HIGHEST POINT OF TRAJECTORY)

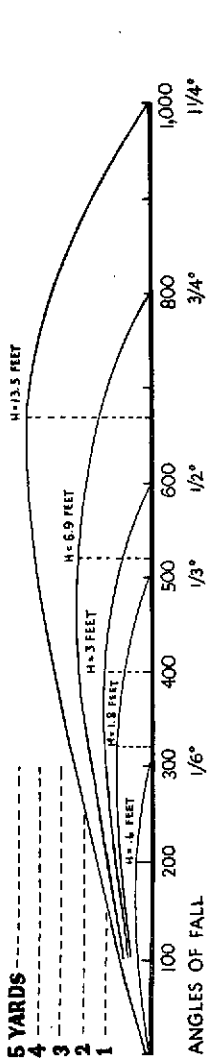

## DANGER SPACES

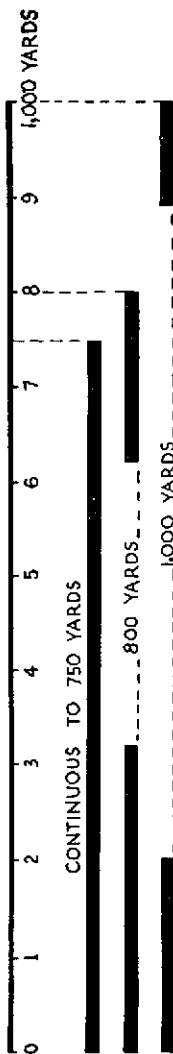

FIGURE 69.—M2 armor-piercing ammunition—trajectory diagram.

a horizontal shot group. Because of the flatness of the trajectory, horizontal shot groups on level ground vary in length from 100 yards at long ranges to 40 yards at short ranges.

■ 111. **BEATEN ZONE.**—The area on the ground struck by the bullets which form a cone of dispersion is the beaten zone. When the ground is level, the beaten zone is a horizontal shot group. The slope of the ground has great effect on the shape and size of the beaten zone. Rising ground shortens the beaten zone. Ground that slopes downward and in the approximate curve of the trajectories will greatly lengthen the beaten zone. Falling ground with greater slope

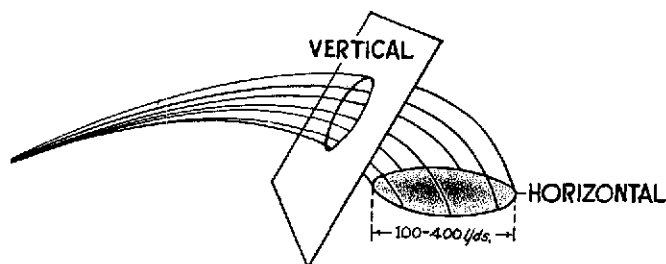

FIGURE 70.—Cone of dispersion, vertical and horizontal shot groups.

than the trajectory will escape fire and is said to be in defilade.

■ 112. **CLASSES OF FIRE.**—*a.* According to direction, fire is classified as follows (fig. 71):

(1) *Frontal.*—Frontal fire is fire delivered at right angles to the front of the target. It is least effective against a target shallow in depth, such as a line of skirmishers, because it fails to take advantage of the depth (length) of the beaten zone. It is most effective against targets which are narrow and deep; for example, a column of squads approaching the rifleman.

(2) *Flanking.*—Fire delivered against the flank of a target is called flanking fire. This type of fire (except for its surprise and moral effect) is not very effective against the flank of column targets of small width, because only a small

part of the target will be covered by the narrow beaten zone of the rifle fire. It is very effective, however, against a line target, such as a skirmish line, taken in flank, because the

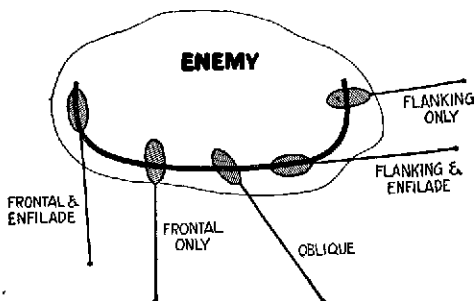
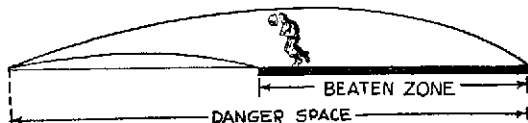

FIGURE 71.—Classes of fire with respect to direction.

long axis of the target coincides with the long axis of the beaten zone.

(3) *Oblique*.—Fire delivered from a direction oblique to the long axis of the target is called oblique fire.



①

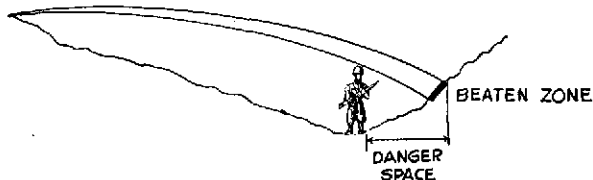

②

FIGURE 72.—Grazing and plunging fire showing beaten zones.

(4) *Enfilade*.—Enfilade fire is fire, either frontal or flanking, in which the long axis of the beaten zone coincides with the long axis of the target. It is the most effective type of fire. Columns of approaching troops engaged from the front, or line targets engaged from positions on their flanks, are said to be taken in enfilade.

b. According to trajectory, fire is classified as follows (fig. 71):

(1) *Grazing*.—Grazing fire is that fire which does not rise above the height of a man standing. Where the rifle is fired from the prone position, the trajectories of the bullets at ranges up to 750 yards over level or uniformly sloping ground produce grazing fire (fig. 72①).

(2) *Plunging*.—Plunging fire (fig. 72②) is fire in which the angle of fall of the bullets with reference to the slope of the ground is such that the danger space is practically confined to the beaten zone. The length of the beaten zone is materially lessened. Fires delivered from high ground on ground lying approximately at right angles to the cone of fire, or against ground rising abruptly to the front with respect to the position of the rifle, are examples of plunging fire. As the range increases, fire becomes increasingly plunging because the angle of fall of the bullets becomes greater.

(3) *Overhead*.—Overhead fire is fire delivered over the heads of friendly troops and may be employed when the conformation of the ground is such that the fire will not be dangerous to friendly troops.

■ 113. EFFECT OF FIRE.—a. Riflemen obtain the most decisive results when close to the enemy. The rifle squad uses the cover and concealment offered by the terrain and takes advantage of the supporting fires of artillery, mortars, and machine guns to get as near the enemy as possible without opening fire. Normally this should be at ranges of 500 yards or less. Under favorable conditions, the automatic rifle is also effective against enemy groups, or areas containing enemy groups, at ranges between 500 yards and 1,000 yards, the effectiveness of the fire being about the same as that of the light machine gun under the same conditions. In some cases it may be desirable to use the automatic rifle

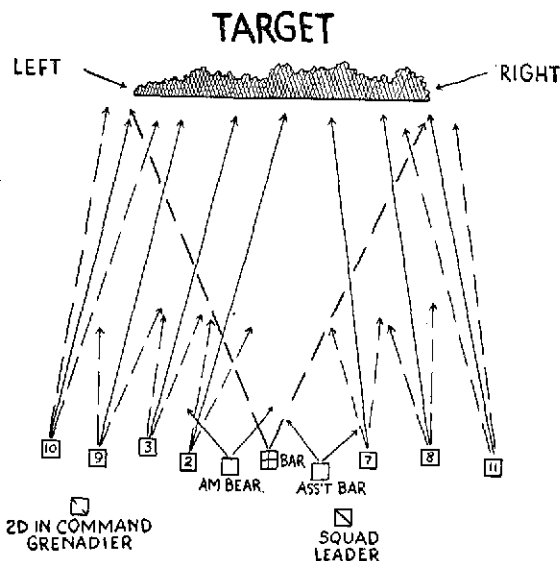

FIGURE 73.—Squad fire distribution—automatic rifleman centrally located, No. 11 on the flank.

to provide a part or all of the fire support necessary to enable the rifleman to advance.

b. Rifle and automatic rifle fire are effective against low-flying airplanes. They can be used effectively against tanks at long ranges to cause the crews to keep doors and shields closed. When armor-piercing ammunition is used, the fire is effective against lightly armored vehicles and gun shields, as well as personnel.

c. When the enemy is under cover so that hits are no longer possible, fire may be continued when the normal effect or hazard is sufficient to keep him under cover, render his fire ineffective, and maintain fire superiority. However, when opposing forces are entrenched and neither is trying to advance, fire for moral effect alone is worthless.

d. A ricochet is effective if it strikes a man soon after it leaves the ground.

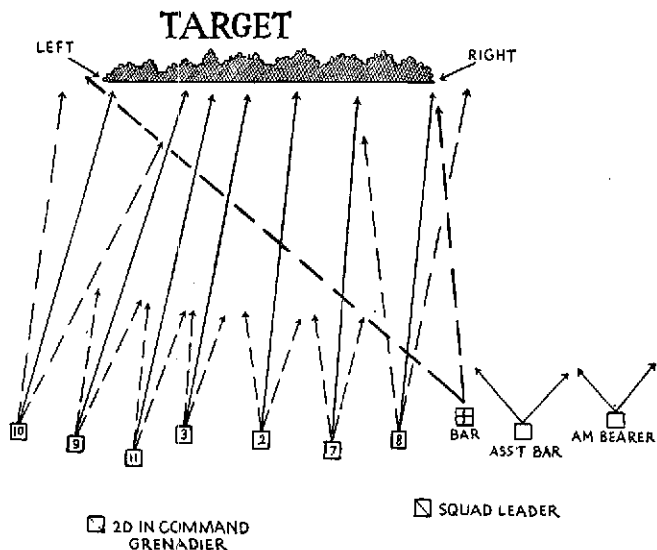

FIGURE 74.—Squad fire distribution—automatic rifle team on flank.

■ 114. EXERCISE.—*a. Purpose.*—To show trajectories.

*b. Method.*—(1) The unit under instruction watches the firing of a few tracer bullets at targets, the ranges to which are announced. Ranges of 300, 600, and 800 yards are suitable selections. The flatness of the trajectories is called to the attention of the men.

(2) The automatic rifleman fires several bursts of tracer bullets at the slow cyclic rate to acquaint the unit under instruction with the cone of fire made by the automatic rifle.

## SECTION V

### APPLICATION OF FIRE

■ 115. GENERAL.—*a. Means of action.*—Rifle units have two general means of action—fire and maneuver. Fire, maneuver, and hand-to-hand fighting are combined in the combat action of the squad and larger units. The application of fire by such units is essential to their success.

*b. Application of fire.*—(1) *In attack.*—The squad and smaller groups must be trained to place a large volume of accurate fire upon probable enemy locations and indistinct or concealed targets, such as enemy machine guns or small

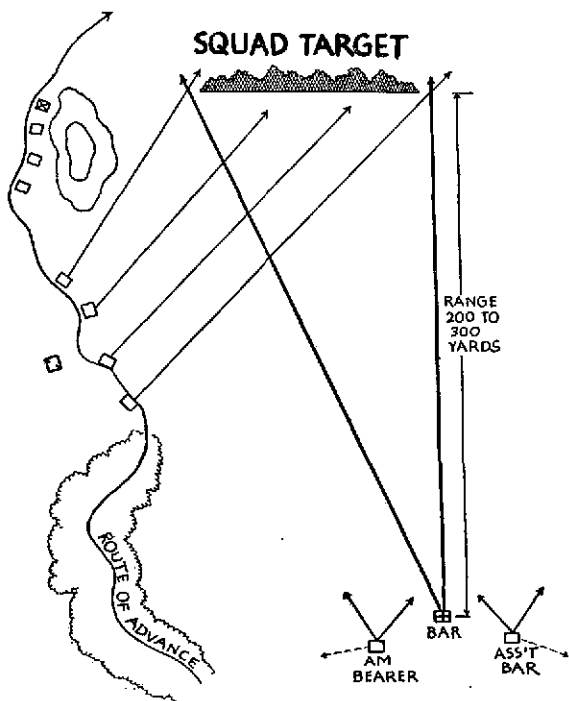
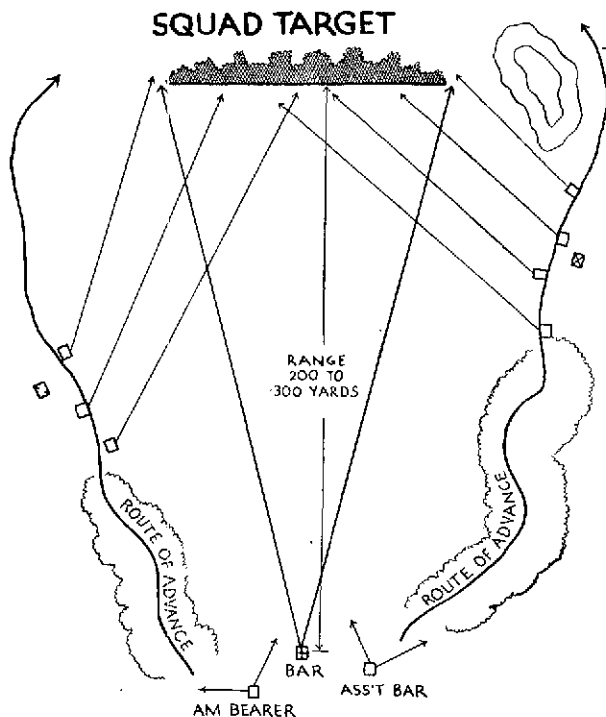

FIGURE 75.—Use of automatic rifle to support the advance of riflemen of the squad. Four riflemen are firing to give additional fire support while the remainder of the squad continue the advance.

groups. The squad and smaller groups must be trained to apply such fire quickly upon the order or signal of its leader and, in appropriate circumstances, to apply it without such order. During the fire fight, the primary duty of the squad leader is to place the fire of his squad on the target. In

accomplishing this, he keeps in mind the fire power of the automatic rifle team which he employs within the squad to place automatic fire on suitable enemy targets and to support the advance of other members of the squad. For



**FIGURE 76.**—Use of automatic rifle to support riflemen of the squad. The riflemen are divided into two groups, one on each flank. One group fires to support the advance of the other; or the groups alternately fire and advance, each supporting the advance of the other.

this reason he selects positions for the automatic rifleman from which he can deliver effective fire on any target holding up the remainder of the squad. When practicable, this position should permit the automatic rifleman to fire across



the entire squad front. The selected position will usually be the one with the best field of fire, although tactical or terrain considerations may require that fields of fire be given secondary consideration.

(2) *In defense.*—In defense, the fire of a small rifle unit, such as a squad, is delivered by small groups and individuals from positions which they must hold. They are placed where they can obtain good fields of fire and can take advantage of cover and concealment.

*c. Actions of members of automatic rifle team.*—The automatic rifle team is a fire unit within the rifle squad. This team should be kept together and duties should be alternated in all phases of training, so that each member knows all the duties of the other members. This will insure that the fire power of this weapon will not be materially affected by battle casualties.

(1) The automatic rifleman receives orders from the squad leader or the assistant squad leader (par. 121b(2)(b)). Pursuant to such orders, he takes position and brings under fire any designated targets and such other targets as may be presented by opportunity. He is ever watchful for opportunities to further the advance of the remainder of the squad by the timely use of the fire power of his automatic weapon.

(2) The assistant automatic rifleman takes position so that he can see the target, the squad leader (or assistant squad leader), and the automatic rifleman. He must not expose himself unnecessarily to any fire that may be directed at the automatic rifleman. He aids the automatic rifleman in getting on the target, transmits to him orders and signals from the squad leader (or assistant squad leader), observes for new targets, assists the automatic rifleman in the reduction of stoppages, and replaces the automatic rifleman if the latter becomes a casualty. When necessary, he participates in the fire with his rifle.

(3) The ammunition bearer's primary duty is to keep the automatic rifleman supplied with ammunition at all times. When he is not engaged in supplying ammunition, he performs the duties of a rifleman and promptly engages those targets which threaten the automatic rifle. He also aids the assistant automatic rifleman in carrying out his duties

and assumes the duties of the automatic rifleman in case both the automatic rifleman and assistant automatic rifleman become casualties.

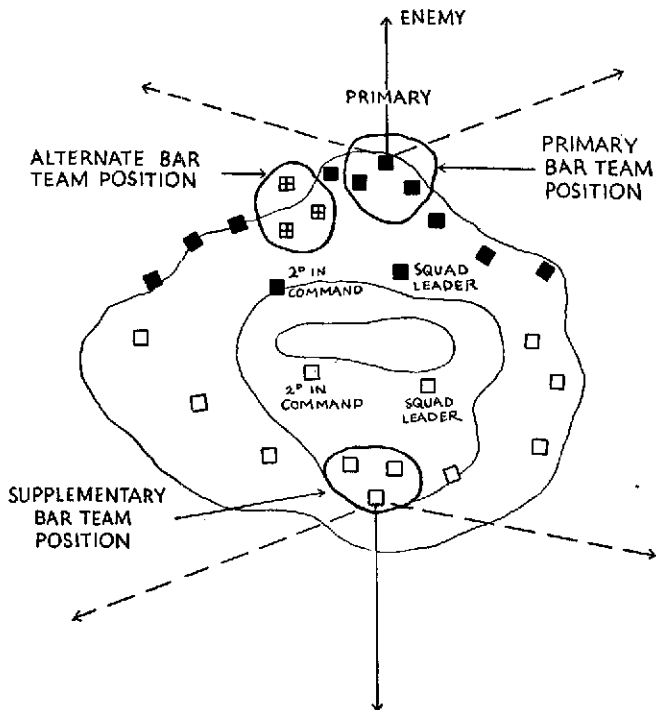
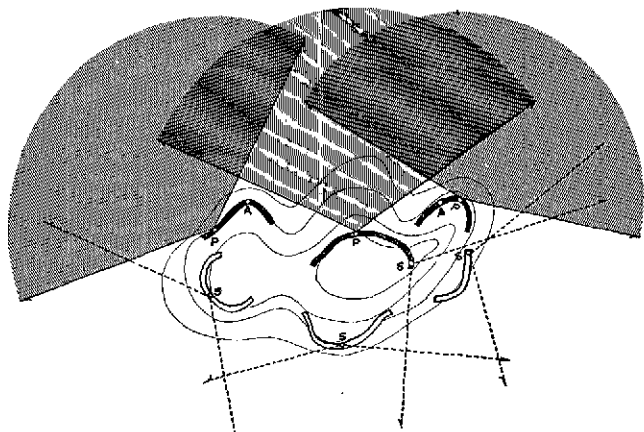

FIGURE 77.—Squad in a defensive position, illustrating the location of the automatic rifle team in primary, alternate, and supplementary positions.

*d. Requirements of position.*—In the occupation of a firing position, the location of squads in the platoon area should be made with due regard to the following requirements:

- (1) Ability to provide desired fire support.
- (2) Good field of fire to the front.
- (3) Make maximum use of available cover and concealment.

**ENEMY**

P-Primary BAR position  
A-Alternate BAR position  
S-Supplementary BAR position

① Automatic rifle sectors of fire.

**ENEMY**

P- Primary sectors of fire.....  
S- Supplementary sectors of fire.....

② Squad sectors of fire.

FIGURE 78.—A platoon in a defensive position, illustrating the location of automatic rifle teams to support adjacent squads, the location of alternate and supplementary positions, and the coordination of fire of automatic rifles with the squad sectors of fire.

(4) Facilitate exercise of fire control by unit leader.

When these requirements conflict, it is the duty of leaders to weigh the importance of each and make the best dispositions.

■ 116. **CONCENTRATED AND DISTRIBUTED FIRE.**—The size and nature of the target presented may call for the fire power of the entire group or only certain parts of it. The fire of a group must necessarily be either concentrated or distributed fire.

*a. Concentrated fire.*—Concentrated fire is fire directed at a single point. It is very effective. Machine guns and other automatic weapons are examples of suitable targets for concentrated fire.

*b. Distributed fire.*—(1) Distributed fire is fire distributed in width for the purpose of keeping all parts of the target under effective fire. It is habitually used on targets having any considerable width.

(2) The method of fire distribution employed by a squad is as follows: Each rifleman fires his first shot on that portion of the target corresponding generally to his position in the squad. He then distributes his remaining shots to the right and left of his first shot, covering that part of the target on which he can deliver accurate fire without having to change position. The portion of the target which each rifleman can cover will depend upon the range and upon the position of the rifleman. In some cases, each rifleman will be able to cover the entire target with accurate fire. Fire is not limited to points known to contain an enemy; on the contrary, riflemen space their shots so that no portion of the target remains unmolested. This does not mean that the riflemen or automatic rifleman try to cover every square foot of the target area, but rather than each rifleman searches the sector which he can cover and fires wherever and whenever he actually sees an enemy. He also fires at each likely spot where an enemy might be concealed. The flank men are taught to overlap the flanks of the target slightly to insure that both flanks are covered. This method of fire distribution is employed without command. It enables squad

leaders to distribute the fire of their units so as to cause the entire target to be kept under fire (figs. 73 to 78, incl.).

(3) From a position best suited to provide support, the automatic rifleman distributes his fire over the entire target, or on any target which will best support the advance of other members of the squad. The automatic rifleman, his assistant, and the ammunition bearer function as a team in order to keep the automatic rifle in a state of constant readiness for action.

(4) If a squad is employing this method of fire distribution and other targets appear, the squad leader announces such changes in the fire distribution as are necessary.

(5) If engaging the same target, all squads of the platoon distribute fire in the same manner.

■ **117. ASSAULT FIRE.**—Assault fire is fire delivered by a unit during its assault on a hostile position. Riflemen with bayonets fixed and the automatic rifleman, his assistant, and the ammunition bearer take full advantage of existing cover, such as tanks, boulders, trees, walls, and mounds, walk rapidly toward the enemy, and fire as they advance at areas known or believed to be occupied by hostile personnel. Rifle fire is usually delivered from the standing position and is executed at a rapid rate. This fire may also be delivered from the hip or from any other convenient position. The automatic rifleman fires from the assault fire position and at a rapid rate. (See FM 23-15.)

■ **118. RATE OF FIRE.**—The maximum rate at which any rifleman should fire the M1917 rifle is determined by his ability to work the bolt rapidly, align the sights, aim and squeeze off accurate shots. To exceed this rate is a waste of ammunition. The first few rounds, particularly in the case of surprise fire, should be delivered at the maximum rate in order to pin the enemy to the ground. Thereafter it should be slowed down to a rate which is just sufficient to maintain fire superiority. This allows for adjustment of the fire by the squad leader and conserves ammunition.

■ **119. FIRE DISCIPLINE.**—*a.* Fire discipline implies the careful observance of the instructions relative to the use of the

rifle in combat and the exact execution of the orders of the leader. When fire discipline is good, men fight as they have been trained to fight and obey orders promptly and carefully; they resist and overcome the influence of danger, excitement, and confusion. Fire discipline is necessary for proper control by leaders, and upon this control depend teamwork and effectiveness of the collective fire of the unit. The training necessary to insure good fire discipline cannot be completed during the brief period devoted to the technique of fire. Training in fire discipline starts with the soldier's first drill and continues throughout his military training. Any drill or exercise which develops alertness and the habit of obedience or other soldierly qualities will aid in developing the character essential to fire discipline.

b. Leaders maintain fire discipline chiefly by their example of coolness and courage. Replacement of casualties is an element of fire discipline which keeps the unit working as a team in spite of losses. If any group of men finds itself without a leader, it is essential that one of the group assume leadership and carry out the assigned mission or that he attach the group to the nearest organized unit. An individual separated from his squad fights on his own initiative only when he has reason to believe that his single effort will accomplish some important result. Otherwise he reports to the nearest leader at once.

c. Fire discipline in the squad is the responsibility of the squad leader. He is assisted by the assistant squad leader. The position of the squad leader during the fire fight will be where he can best control his squad. The assistant squad leader will be where he can best assist the squad leader.

■ 120. FIRE CONTROL.—*a. General.*—Fire control consists of the initiation and supervision of the fire of a unit or group by its leader. It implies the ability of the leader to have his men open fire or cease fire at the instant he desires, to adjust fire upon the target, to shift all or a part of the fire from one target to another, and to regulate the rate of fire. Fire control pertains chiefly to the squad or smaller group. The leader of the unit must supervise and control the fire of his men so that it is directed and maintained at suitable

targets. The men must understand that controlled fire is always the most effective fire. On the other hand, the irregular formations adopted for an advance will often render such control impracticable. In such case, fire must be opened and maintained on the initiative of individuals as circumstances require. However, the leader should seek to regain control of the fire of his men at the first opportunity.

*b. How exercised.*—Squad leaders and assistant squad leaders exercise fire control by means of orders, commands, and signals. The signals most frequently used are—

Signals for range.

Commence firing.

Fire faster.

Fire slower.

Cease firing.

Are you ready?

I am ready.

Fix bayonets.

■ 121. FIRE ORDERS.—*a. Purpose.*—The leader of a rifle fire unit, having made a decision to fire on a target, must give certain instructions as to how the target is to be engaged. The instructions by which the fire of a squad is directed and controlled form the fire order.

*b. Basic elements.*—A fire order contains three basic elements which are announced or implied in every case. Only such elements or parts thereof as are essential will be included. Except when the squad is to engage more than one target, in which case the fire-distribution element may be given first, the sequence is always as follows:

Target-designation element.

Fire-distribution element.

Fire-control element.

(1) *Target-designation element.*—The target may be designated by any one method or a combination of the prescribed methods. This element tells where the target is and what it is (par. 106).

(2) *Fire-distribution element.*—The fire-distribution element tells who is to fire. It may be omitted from the fire order when all members of the squad are firing at the same target.

The method of fire-distribution described in paragraph 116b is habitually employed against targets of width in the absence of instructions to the contrary. When necessary to engage more than one target, the fire-distribution element includes the subdivision of the target, in which case this element may be given first.

(a) If a squad leader desires to engage two machine-gun nests, the distribution element of his order might be as indicated by the italicized words below:

*Cooper, Emerson, Crane, Hines, Turner* (riflemen).

Range 400.

Front.

Machine gun at base of lone pine.

*Brown* (automatic rifleman), *Smith, Jones, Howard, Stone* (riflemen).

Range 500.

Left flank.

Machine gun at base of haystack.

(b) The squad leader may engage two targets by placing a number of riflemen under the orders of the assistant squad leader and directing him to engage one target while he (the squad leader) engages the other target with the automatic rifleman and other members of the squad. Or, the squad leader may place the automatic rifleman and certain members of the squad under the assistant squad leader to engage one target, while, with remaining members of his squad, he (the squad leader) engages the second target.

(3) *Fire-control element*.—The fire-control element normally consists of only the command or signal COMMENCE FIRING. It tells when to fire. It may also include the number of rounds. For the automatic rifle, it may also include the number of bursts, the number of rounds in the burst, or both. Examples are:

FIVE ROUNDS, COMMENCE FIRING.

ONE (two or more) MAGAZINE(S), COMMENCE FIRING.

BURSTS OF TWO (THREE, FOUR, or more), COMMENCE FIRING.

TWO BURSTS OF TWO (THREE, FOUR, or more), COMMENCE FIRING.



c. *Example*.—An example of a complete fire order follows:

(1) *Target-designation element*.

(Range)----- Range 600.

(Direction)----- Front (left front, etc.).

(Description of target)----- Enemy group.

(2) *Fire-distribution element*.—Implied.

(3) *Fire-control element*.—COMMENCE FIRING.

d. *Surprise fire*.—To obtain the maximum surprise and shock effect, it is important that all weapons of a unit open fire at the same instant. To insure this action the leader may preface the command or signal for commencing fire by the words "upon command" or "upon signal." Men are trained so that each one, as soon as he reaches a firing position and picks up his target, aims his rifle or automatic rifle at the target. As soon as the leader has determined that all men are in position and are aiming at the target, he gives the command or signal COMMENCE FIRING. In some situations, the leader may delay in giving the command COMMENCE FIRING until the critical moment for opening fire is at hand. In this case, to insure that all men open fire at the same time, a sufficient pause is made between the words "commence" and "firing" to give the men time to realine their sights on the target and be ready to fire at the word "firing."

e. If a surprise fire is not required, the command COMMENCE FIRING is announced immediately after the target-designation element of the fire order. Each man opens fire as soon as he is in a firing position and has picked up his target.

■ 122. *DUTIES OF LEADERS*.—The following summary of duties of leaders relates only to their duties in the technique of fire:

a. *Squad leader*.—(1) Carries out orders of platoon leader.

(2) Selects firing positions for squad.

(3) Designates targets and issues fire orders.

(4) Controls fire of squad, when possible.

(5) Maintains fire discipline.

(6) Observes targets and effect of fire.

(7) Directs the assistant squad leader to control the fire of a portion of the squad, when desirable.

*b. Assistant squad leader.*—(1) Carries out orders of squad leader.

(2) Assists squad leader to maintain fire discipline.

(3) Assumes command of squad in absence of squad leader.

(4) Participates in firing when the fire of his rifle is considered more important than other assistance to the squad leader.

(5) Controls any portion of the squad, as directed by the squad leader.

## SECTION VI

### LANDSCAPE-TARGET FIRING

■ 123. SCOPE AND IMPORTANCE.—*a.* After satisfactory progress has been made in the preceding steps, the soldier may practice what he has learned by firing at landscape targets.

*b.* Advantages of landscape-target firing are:

(1) It permits close supervision of all members of the firing unit.

(2) It clearly and quickly demonstrates the application and effect of fire.

(3) It can be conducted indoors when lack of facilities or weather conditions make this desirable.

*c.* In circumstances where there is a choice between landscape-target firing and field-target firing, the latter should be selected, since landscape-target firing is not a required part of training.

■ 124. DESCRIPTION OF LANDSCAPE-TARGET.—A landscape target is a panoramic picture of a landscape. It is so drawn that all or nearly all of the salient features are recognizable at a distance of 1,000 inches. The standard target is the series A target, consisting of five sheets in black and white.

■ 125. WEAPONS TO BE USED.—Firing at landscape targets should be conducted with caliber .22 rifles, preferably the M1922M2 equipped with the Lyman sight. If there are not enough caliber .22 rifles available, the caliber .30, M1917 rifle and the automatic rifle, caliber .30 M1918A2 may be used.

■ 126. PREPARATION OF TARGETS.—*a. Mounting.*—(1) The sheets are mounted on frames made of 1- by 2-inch dressed

lumber, with knee braces at the corners. The frames are 24 by 60 inches, and are covered with target cloth which is tacked to the edges.

(2) The target sheets are mounted as follows: Apply a thin coat of flour paste to the target cloth and let it dry for about an hour; apply a thin coat of paste to the back of the paper sheet and let it dry about an hour; apply a second coat of paste to the back of the paper and mount it on the cloth; smooth out wrinkles with a wet brush or sponge, working from the center to the edges. The frame must be placed on some surface that will keep the cloth from sagging when the paper is pressed on it. A form for this purpose can be easily constructed. It must be of the same thickness as the lumber from which the frames are built and must have approximately the same dimensions as the aperture of the target frame.

*b. Target frames.*—Panels (mounted as described above) are set in a vertical frame made of 4- by 4-inch posts sunk upright in the ground and spaced 5 feet from center to center. Horizontal 2 by 4's add stability and form a base to support the panels. Cleats and dowels hold the panels and permit easy removal (fig. 79).

*c. Range indicators.*—To permit proper designation of targets, assumed ranges must be used on landscape targets. Small cards on which are painted appropriate numbers representing yards of range are tacked along one or both edges of a series of panels (fig. 79). The riflemen must be cautioned that the range announced in any target designation is for the sole purpose of designating the target, and that the sight setting necessary to zero their rifles must not be changed.

*d. Direction cards.*—In order to provide the direction element in oral target designation, small cards on which are painted "front," "right front," "left front," "right flank," and "left flank" are tacked above the appropriate panels of the landscape series (fig. 79).

*e. Scoring devices.*—(1) Scoring the exercises tends to create competition between squads and enables the instructor to grade their relative proficiency. For a point target, a scoring device conforming in size to the 50- and 75-percent

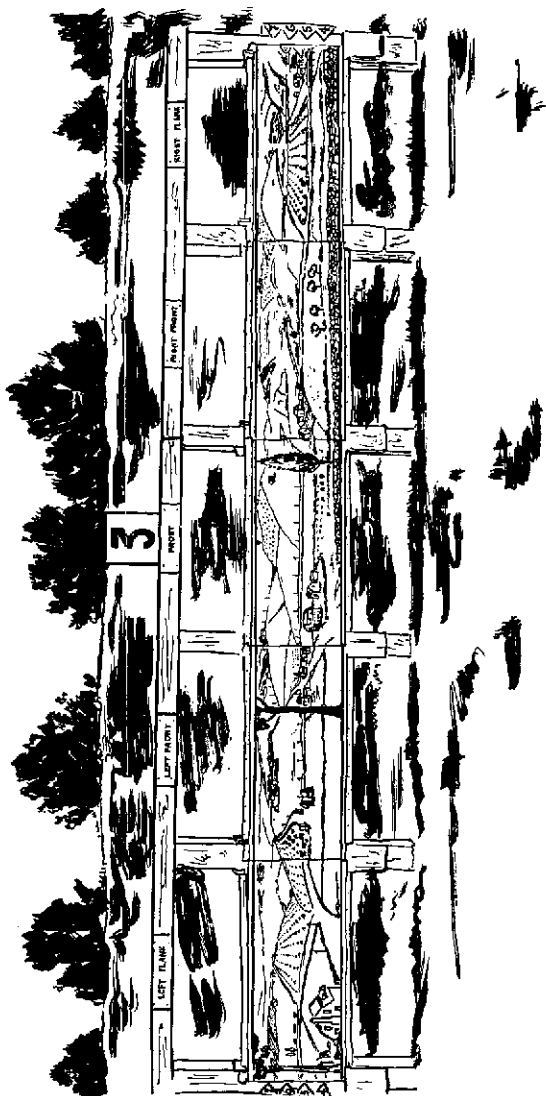

FIGURE 79—Arrangement for setting up landscape target panels.

shot groups, to be expected of average shots firing at 1,000 inches and at reduced ranges, can easily be made from wire. A better device can be prepared by imprinting a scoring diagram on a sheet of transparent celluloid. By using a scoring template constructed from celluloid, plywood, beaver-board, or any similar material, the scoring space can be outlined on the target in pencil before the target is shown to

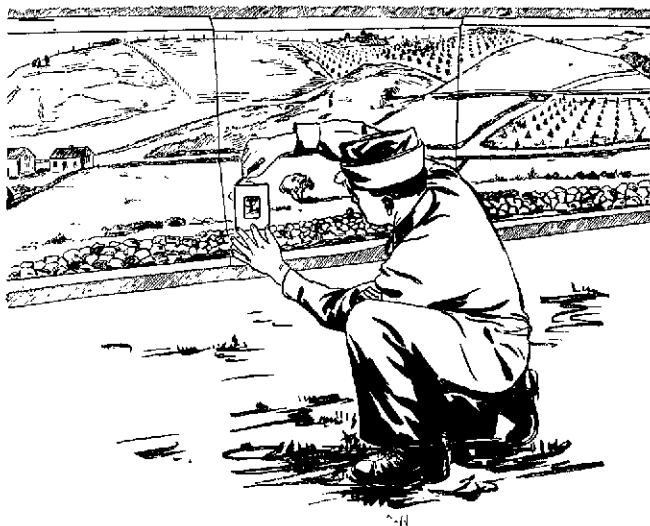

FIGURE 80.—Lining in scoring area (point target) with scoring template.

the squad leader (figs. 80, 81, 82, and 83). This procedure prevents squad leaders from misunderstanding the limits of the designated target. Upon completion of firing, the entire squad is shown the target and the results of the firing.

(2) Although shot groups take the form of a vertical ellipse, the 50- and 75-percent zones should be shown by the devices as rectangles. This is for convenience in their preparation. At 1,000 inches the 50-percent zone is a rectangle 2.5 inches high and 2 inches wide, and the 75-percent zone is a rectangle 5 inches high and 4 inches wide. At 50

feet the 50-percent zone is 1.5 inches high and 1.2 inches wide, and the 75-percent zone is 3 inches high and 2.4 inches wide. The target is at the center of the inner rectangle or 50-percent zone.

(3) For a linear target, such as a small area over which the riflemen will distribute their fire, the 50-percent zone is formed by two lines drawn parallel to the longer axis of the target (area) and with the target midway between those

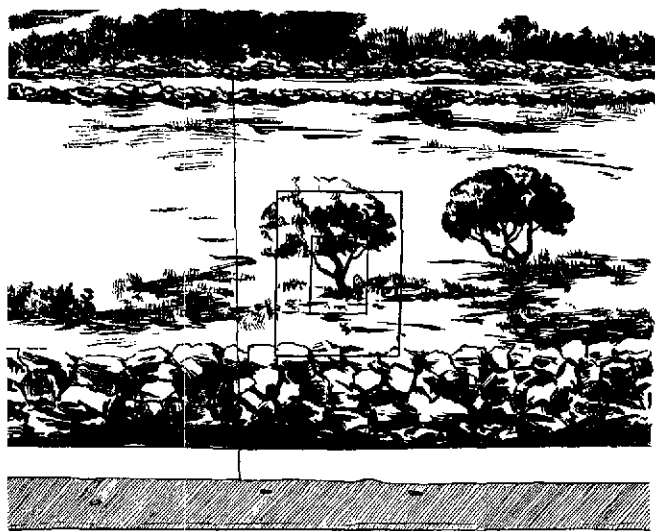

FIGURE 81.—Scoring area for a point target outlined on a landscape panel.

lines. A suitable scoring device (fig. 82) conforming in size to the 50- and 75-percent shot groups to be expected of average shots at 1,000 inches and at reduced ranges can be made for a linear or vertical target, as described above, for a point target. It is used in a similar manner (fig. 83). At 1,000 inches the lines are 2.5 inches apart; at 50 feet they are 1.5 inches apart. Two additional lines similarly drawn form the 75-percent zone. At 1,000 inches the lines are 5 inches apart; at 50 feet they are 3 inches apart. The width of the



b. The procedure is as follows:

(1) Sights of all rifles are blackened.

(2) The squad is deployed on the firing line; the squad leader takes his position in rear of the squad.

(3) The instructor causes each rifleman to set his sights at zero elevation or 200 yards for the caliber .30, M1917 rifle, or minimum elevation and zero windage for the automatic rifle, caliber .30, M1918A2, and checks each sight.

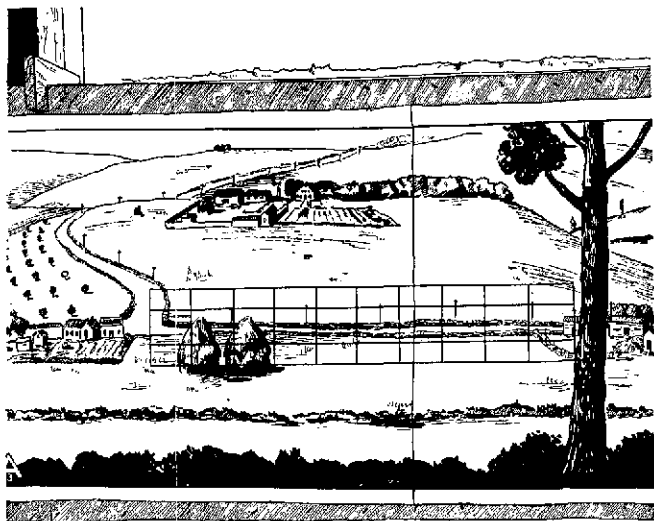

FIGURE 83.—Landscape target panel showing linear target with scoring areas and distribution spaces.

(4) Each man is assigned as an aiming point that paster which corresponds to his position in the squad.

(5) Three rounds are issued to each man on the firing point to be loaded and fired at the command of the instructor.

(6) Each man fires three shots at his paster at the command **THREE ROUNDS, COMMENCE FIRING.**

(7) The instructor commands: **CLEAR RIFLES.** The squad leader checks to see that this is done (par. 18g).



(8) The instructor and squad leader inspect the target and, based upon the location of the center of impact of the resultant shot group, give each man the necessary correction for his next shot. For example, with the caliber .22 rifle, "Up 1 minute, right one-half point;" or, with the caliber .30, M1917 rifle, "Up 100, right 1 inch."

(9) The firing continues as outlined above until all rifles are zeroed, that is, until each man has hit his aiming point.



FIGURE 84.—Using target template to divide a vertical target into spaces to give score for distribution.

c. For the caliber .22 rifle equipped with the Lyman sight:

(1) At a distance of 1,000 inches, a change of 5 minutes in elevation (10 clicks) will move the strike of the bullet about  $1\frac{1}{2}$  inches. A change of one point of windage (8 clicks) will move the strike about  $1\frac{1}{4}$  inches. A simple rule of thumb is that *one click of elevation or windage will move the center of impact of the bullet approximately  $\frac{1}{8}$  of an inch.*

NOTE.—Actually, one click of elevation moves the strike of the bullet  $\frac{3}{20}$  of an inch at 1,000 inches.

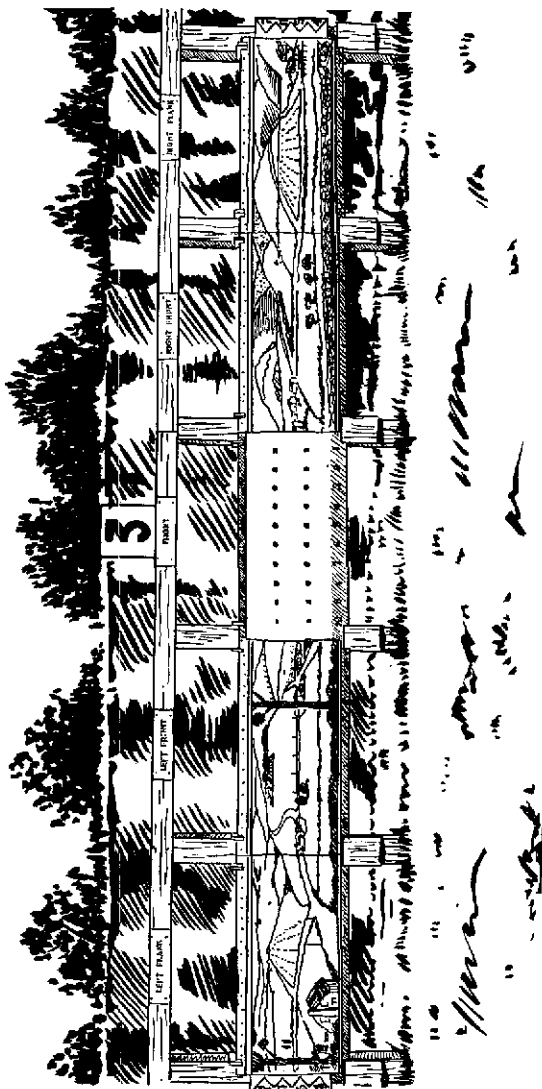

FIGURE 85.—Landscape target set up for zeroing rifles. (Note scoring panel and number bar.)

(2) At a distance of 50 feet, a change of 6 minutes in elevation will move the strike of the bullet about 1 inch, and a change of one point of windage will move the strike about  $\frac{3}{4}$  inch. (For additional details see TM 9-280.)

d. For the caliber .30, M1917 rifle:

(1) At a distance of 1,000 inches, a change of 100 yards in elevation will move the strike of the bullet about 1 inch in the changed direction.

(2) At a distance of 50 feet, a change of 100 yards in elevation will move the strike of the bullet about  $\frac{1}{2}$  inch in the changed direction.

e. For the Browning automatic rifle, caliber .30, M1918A2:

(1) At a distance of 1,000 inches, changes of one click in elevation and windage, respectively, will move the strike of the bullet about 1 inch in the changed direction.

(2) At a distance of 50 feet, a change of one click in elevation and windage, respectively, will move the strike of the bullet about  $\frac{1}{2}$  inch in the changed direction.

■ 128. FIRING PROCEDURE.—The following sequence is used in conducting firing exercises:

a. All members of the squad except the squad leader face to the rear.

b. The instructor takes the squad leader to the panels and points out the target to him. They return to the firing line; the squad leader takes charge of the squad and causes the men to resume their firing positions.

c. The squad leader gives the command LOAD, cautioning, "(No.) round." The automatic rifleman should be given more rounds than the riflemen receive. Caliber .30 as well as caliber .22 ammunition may be used.

(1) *Using caliber .30 ammunition.*—When caliber .30 ammunition is available, it is desirable to fire the automatic rifle on landscape targets so as to provide training for the automatic rifle team.

(2) *Using caliber .22 ammunition.*—When caliber .30 ammunition is not available but caliber .22 ammunition is to be had, the fire effect of the automatic rifle team may be simulated within the squad by grouping three or more rifles together when engaging targets. This group should be con-

sidered as one weapon in order to represent the fire power of the automatic rifle and to allow for proper distribution of fire.

d. The squad leader designates the target orally. Reference to panels to indicate direction should not be allowed in the designation. To complete the fire order, the squad leader adds: **COMMENCE FIRING**.

e. When the squad has completed firing, the squad leader commands: **CEASE FIRING, CLEAR RIFLES**. The squad leader checks to see that this is done. The squad then examines the target. The target panel is scored and marked with the squad number.

f. The instructor holds a short critique after each exercise.

■ 129. **SCORING.**—*a. Concentrated fire.*—In concentrated fire the sum of the value of the hits within the two zones is the score for the exercise. For convenience of scoring and comparison, 100 is fixed as the maximum score. Any method of scoring and of distribution of ammunition among members of the squad may be used. For example:

(1) Number of rounds fired, 50.

(2) Value of each hit in 50-percent zone, 2.

(3) Value of each hit in the area of the 75-percent zone outside the 50-percent zone, 1.

*b. Distributed fire.*—A suggested method of scoring for distributed fire follows.

(1) Number of rounds fired, 50.

(2) Value of each hit in 50-percent zone, 2.

(3) Value of each hit in the area of the 75-percent zone outside the 50-percent zone, 1.

(4) Value of each distribution space (if target is divided into 10 equal spaces), 10.

(5) The score for distribution, plus the value of all hits, divided by two, is the score for the exercise.

■ 130. **EXERCISES.**—*a. No. 1.*—(1) *Purpose.*—To teach target designation and to show the effect of concentrated fire.

(2) *Method.*—The squad leader directs the fire of his squad at a point target indicated to him by the instructor.

*b. No. 2.*—(1) *Purpose.*—To teach target designation and the division of the squad fire on two points of concentration.

(2) *Method.*—The instructor indicates two point targets to the squad leader, giving the nature of each. The squad leader applies the fire of his squad on the two targets in the proportions directed by the instructor. The scoring will be as for concentrated fire on each target, the several scores being combined in totals for the score of the exercise.

c. *No. 3.*—(1) *Purpose.*—To teach target designation, fire distribution, and fire control in diverting part of the fire of the squad to a suddenly appearing target.

(2) *Method.*—The instructor indicates a target of width (linear target) to the squad leader. The squad leader applies the fire of his squad to this target. After firing has commenced, the instructor indicates and gives the nature of a point target to a flank. He then directs the squad leader to shift the fire of the automatic rifle (group of three or more caliber .22 rifles) from the first to the second target. A simple method of scoring this type of exercise is to add the value of hits on the point target, the value of hits on the target of width, and the score for distribution on the target of width, and divide this sum by 2. This provides a score for the problem on a basis of a possible 100 points.

d. *No. 4.*—(1) *Purpose.*—To teach the application of fire on an enemy group marching in formation, the fire control necessary to obtain fire for surprise effect, and to show the effect of fire on troops in formation.

(2) *Method.*—The instructor indicates to the squad leader a target that represents a small group of the enemy in the approach march, on patrol, or in some other formation. It is assumed that the enemy is not aware of the presence of the squad. The squad leader applies the fire of his squad. His instructions must result in the simultaneous opening of fire of all weapons and the distribution of fire over the entire target. The assignment of half the riflemen to fire at the rear half of the target and the remaining riflemen to fire at the forward half, with the automatic rifleman covering the entire target, is a satisfactory method of distributing fire over such a target.

e. *Training of assistant squad leader.*—The assistant squad leader will be given instruction and practice in the type of exercises outlined above.

## SECTION VII

## FIELD-TARGET FIRING

■ 131. SCOPE OF TRAINING.—The training in this phase is similar to that given the soldier in landscape-target firing, but with the added features of the use of cover and concealment, range estimation, firing the caliber .30 M1917 rifle and the automatic rifle with live ammunition at field targets at unknown ranges, and fire control under more difficult conditions. Training must be progressive. The soldier should first be given an opportunity to fire at more or less exposed targets, followed by fire at targets which are concealed from view but exposed to fire. Soldiers should preferably receive this training in the squad.

■ 132. TERRAIN, TARGETS, AND RANGES.—*a. Terrain.*—(1) The availability of ground and considerations for safety determine the selection of terrain for field-firing ranges. Where possible, varied terrain suitable for the deployment of a rifle squad should be selected. It is a great advantage from the instructional standpoint to use ground that is unfamiliar to the unit to be trained.

(2) In the absence of other facilities, the known-distance ranges can be used by arranging the exercises so that they will begin off the range and require the delivery of fire on the range and in a safe direction.

*b. Targets.*—(1) Targets may be improvised from available material, or they may be obtained from the Ordnance Department (figs. 86 to 102, incl.).

(2) With the field targets furnished by the Ordnance Department, a stationary target may be represented by E or F targets placed on stakes and driven in the ground or set in sockets (fig. 89).

(3) A surprise target that can appear and disappear may be made by using either E or F targets fastened to an I-beam, rope, or pole, and operated by a man in a pit. (See figs. 90 to 101, incl.)

(4) A movable field target may be made by fastening E or F targets to a sled (fig. 42), or by suspending such targets from a wire (figs. 91, 95, and 99).

(5) In the field, targets should be placed in locations that would be used by an intelligent enemy. They should not

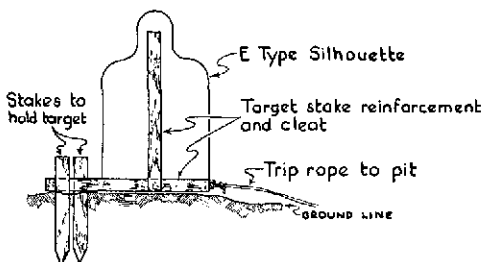

FIGURE 86.—Method of withdrawing a stationary field target.

be prominently exposed nor should they be in a regular line (figs. 89 and 93). Targets used should vary in size

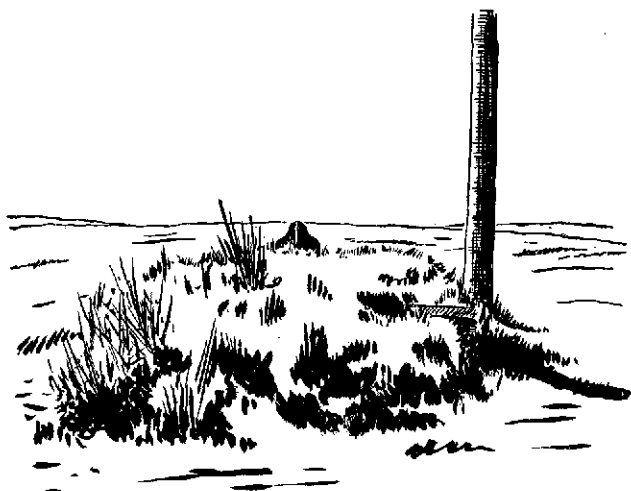

FIGURE 87.—Surprise target at pit. (See fig. 91 for details of operation.)

and the degree of concealment (at ranges unknown to the rifleman) in which they are placed. The exposure of tar-

gets kept out of sight at the beginning of an exercise may be indicated by the firing of blank ammunition or the op-



FIGURE 88.—Method of breaking outlines of silhouette targets.

eration of other noise- or smoke-producing equipment in the vicinity of the target when it does appear (figs. 100,

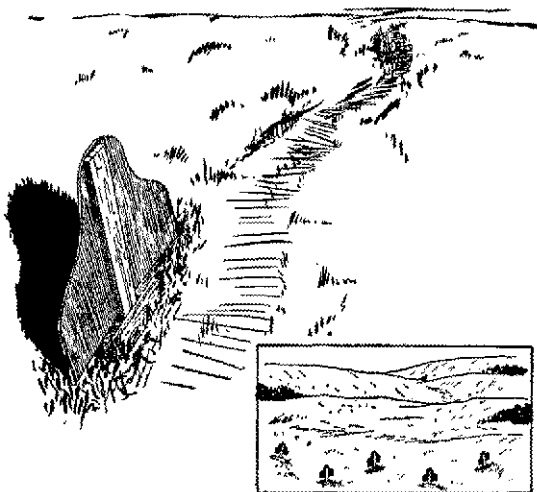

FIGURE 89.—Method of setting up targets to represent skirmishers.

101, and 102). To test the proficiency and skill of the squad leader in designating the target and adjusting fire, targets



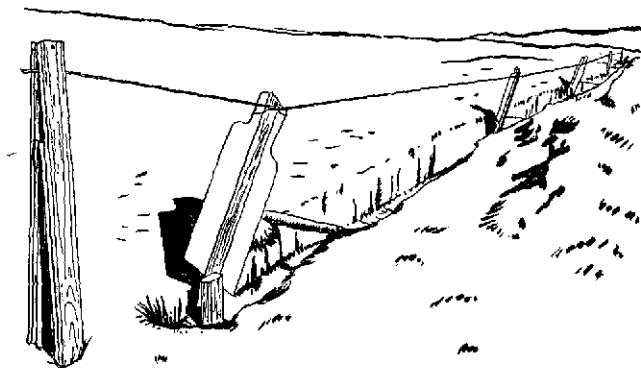

FIGURE 90.—A method of raising surprise targets (linear target).

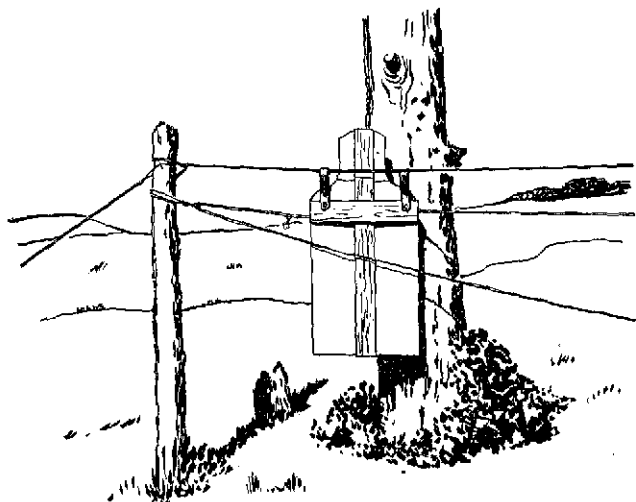

FIGURE 91.—Arrangement for moving surprise target along horizontal line (running figure).

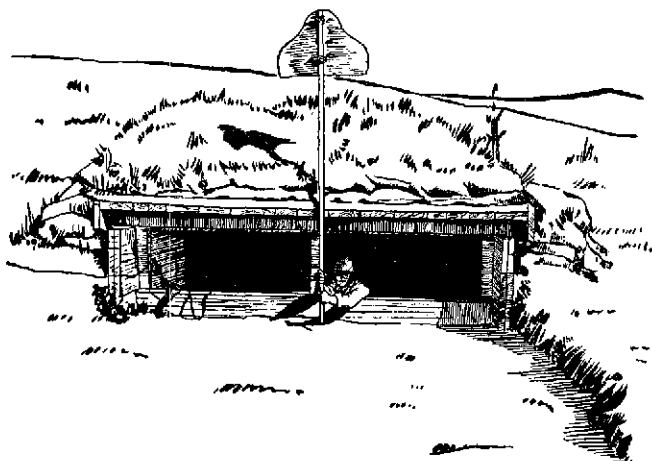

FIGURE 92.—Method of exposing surprise target. (See fig. 86 for front view.)

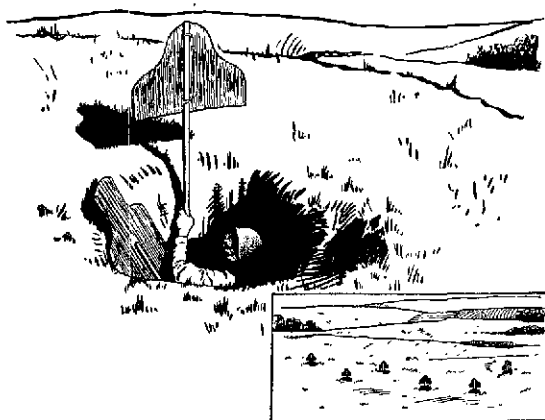

FIGURE 93.—Method of displaying surprise target to represent skirmishers. (Cutaway in rear of pit prevents ricochet rounds from rebounding into pit.)

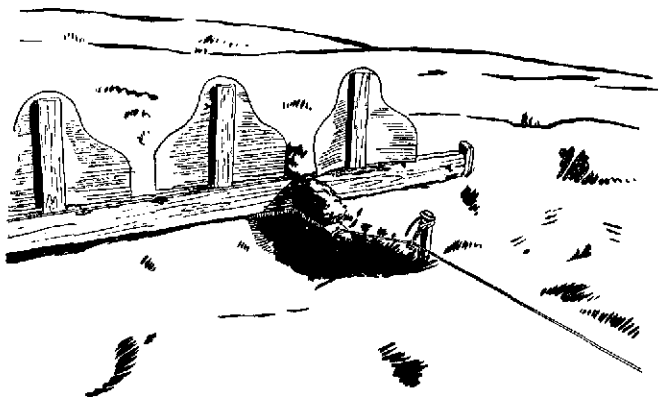

FIGURE 94.—Method of raising surprise point targets. (Note pull rope and counterweight in rear.)

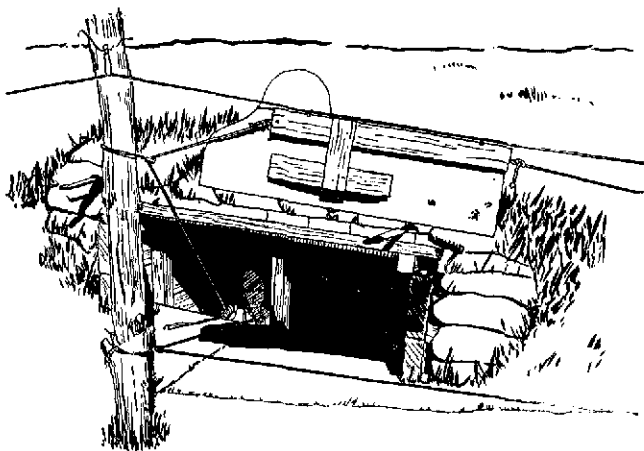

FIGURE 95.—Method of exposing surprise target moving horizontally along the ground (crawling man).

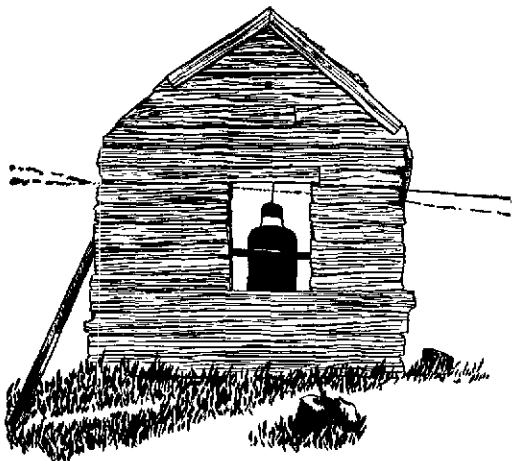

FIGURE 96.—Surprise target appearing in window.

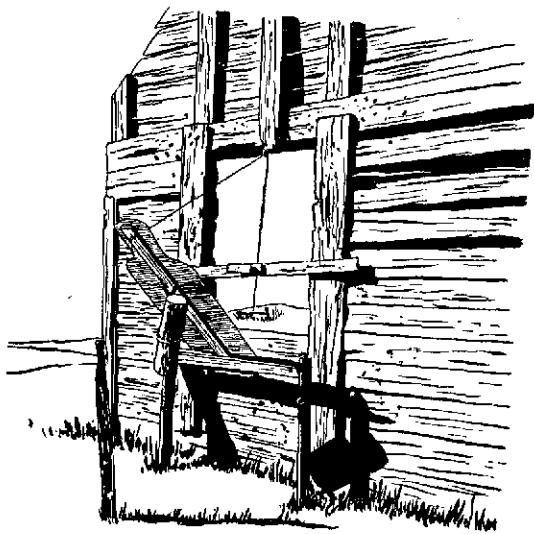

FIGURE 97.—Method of raising surprise target from pit.

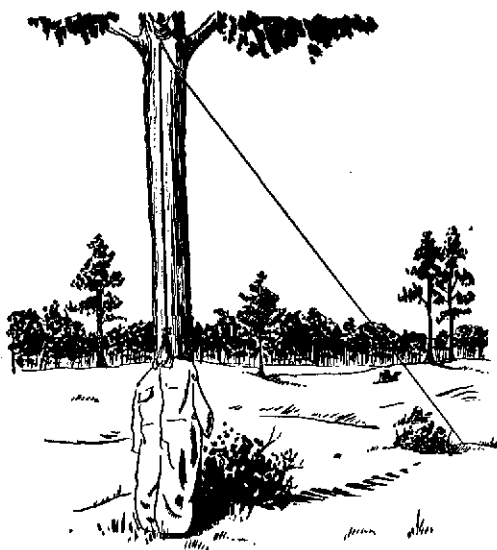

FIGURE 98.—Method of raising surprise target in tree (sniper).

may be so placed as to be visible with the binocular but entirely invisible to the naked eye.

(6) The appearance of the targets from the firing line will depend to a large extent upon the direction of the sun, the background of the targets, and the angle at which the targets are placed. These factors should be taken into consideration when placing the targets for any particular exercise.

*c. Ranges.*—(1) *Shelter.*—(a) Ranges for field-firing exercises can be efficiently operated without an elaborate system of shelters and dugouts. Simple pits to accommodate the target operators are sufficient.

(b) Every effort should be made to avoid altering the natural appearance of the terrain when locating and camouflaging targets and when locating and constructing pits (figs. 87, 88, 92, 93, and 95).

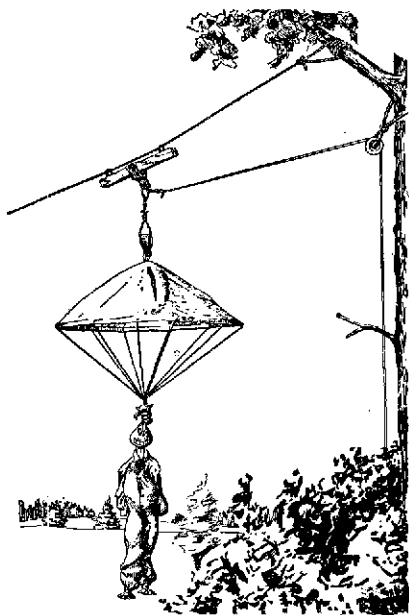

FIGURE 99.—Arrangement for raising and lowering surprise target (parachute). (Control ropes lead to pit.)

(c) When targets are placed in the rear or to one side of the pits, the likelihood of ricochets falling into the pits is minimized (figs. 96, 97, 98, and 99). If tracer ammunition is to be used, it is best to have covered pits. (See fig. 87, view from firing line, and figs. 92 and 95, rear view.) It is desirable to have all pits and the firing line connected by telephone. If available, small portable two-way voice radio sets may be used.

(2) *Safety.*—(a) In general, the safety precautions used at known-distance ranges apply with equal force to instruction in firing at any field target. (See AR 750-10.) Safety of personnel is of primary importance in conducting exercises which require the firing of live ammunition. To this end, exercises should be drawn to conform to the state of training of the units concerned.

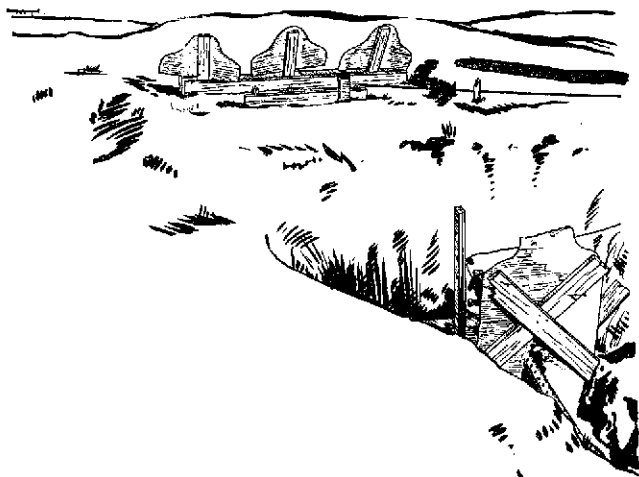

FIGURE 100.—Arrangements for raising surprise targets and producing fire to attract attention. (Cardboard shield protects light machine gun from dirt and dust.)

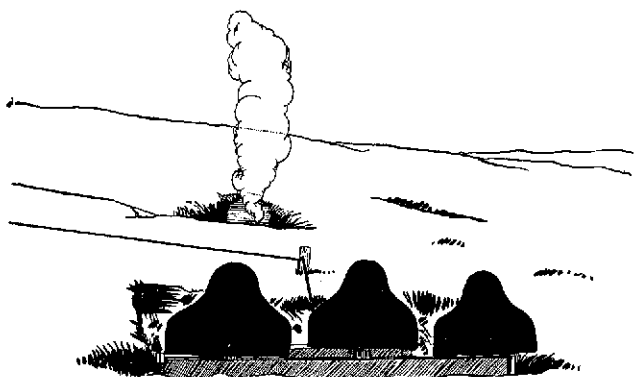

FIGURE 101.—Arrangement for showing surprise (point) target and creating machine-gun fire for sound effect. (Dust is raised by the strike of light machine-gun rounds into the earth.)

(b) The officer in charge of an exercise is responsible for the safety of the firing; it is his duty to initiate and enforce such precautions as he deems necessary under existing conditions. No other officer can modify his instructions without assuming the responsibility for the safety of the firing.

(c) Firing will not start until it has been ascertained that the range is clear, that pit details are not exposed, and that all safety precautions have been complied with. Upon completion of firing, the officer in charge will cause all rifles to

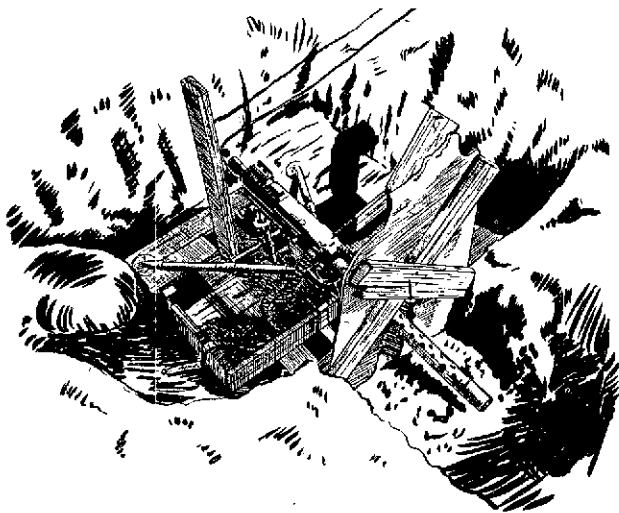

FIGURE 102.—Details showing method of installing light machine gun to produce sound effect.

be unloaded and inspected and will have all ammunition collected. After all rifles are cleared, the targets are scored for hits.

■ 133. GENERAL CONSIDERATIONS.—*a. Progressive training.*—Training in moving from an approach march formation or a place of concealment to firing positions is included under the phase of training known as field-target firing primarily for the following two purposes:



(1) To teach the soldier the proper use of cover and concealment and the intelligent selection of firing positions.

(2) To combine the technique of applying and controlling collective fire with scouting and patrolling and other related subjects.

*b. Firing positions and representation of enemy.*—In battle, a unit is not deployed with individuals abreast and at regular intervals apart. The selection of individual and group positions is governed by the field of fire, cover or concealment while firing, covered route(s) of approach to those positions, fire control, and nature of target. The representation of the enemy will conform to irregular battle formations.

*c. Use of cover.*—(1) The proper use of available cover is important because—

(a) The man who neglects the use of cover will be seen and hit.

(b) His squad not only loses the fire effect of one rifle, but its position is unnecessarily disclosed and other casualties may follow.

(2) The individual use of cover and concealment is taught in FM 21-45. For training in firing at field targets, the principles are the same.

(3) In seeking covered and concealed firing positions, men must avoid those places which mask the fire of others or cause their fire to be dangerous to other men of their unit. Also, if there is the probability of hostile detection while moving into a firing position, men should understand that a few yards' movement in any direction, if it can be made by a covered or concealed path, will permit fire from an undisclosed position. Bunching, however, must be avoided.

*d. Marksmanship applied.*—(1) The principles of rifle and automatic rifle marksmanship are followed in this training so far as they suit existing conditions.

(2) These principles should be applied to the technique of fire and to combat in a common sense way. It should be appreciated that the conditions encountered in combat situations will differ from those found on the target range. On the target range, the soldier is expressly prohibited from resting his rifle against an unauthorized rest while firing. In firing at field targets and in battle, the soldier takes advan-

tage of trees, rocks, or any other rest which will make his fire more accurate. The positions prescribed in rifle marksmanship are used whenever the ground will permit, but on rough ground it is often necessary to modify them in order to get a comfortable and steady position. To simulate actual battle conditions, some of the firing should be conducted with bayonets fixed and without the aid of the rifle sling. (See paragraph 53b(3) for information pertaining to zeroing rifle with bayonet or grenade launcher attached.) When firing without the sling, the hand is placed against or near the lower band swivel where the rifle is firmly grasped and pulled back so that the butt plate fits snugly against the shoulder.

*e. Use of battle sight.*—The battle peep sight corresponds to a sight setting of 400 yards. It is used only when time is lacking for setting the peep sight or in firing at aircraft or other moving targets. By keeping the peep sight habitually set at 300 yards when not in use, the soldier has two sights ready for emergencies.

*f. Squad members should receive individual practice in firing at field targets before firing squad problems. Most of this firing should be at ranges of 400 yards or less. Provisions for this instruction may be made on any field-target firing range. The scope and the method of conducting this training are outlined in paragraph 167.*

■ 134. EXERCISES.—*a. General.*—(1) Exercises for firing at field targets should be suitable to the actual terrain upon which they are conducted. Some of these exercises will be fired with the gas mask adjusted. *They should be repeated until all men have demonstrated their proficiency in firing the rifle, in advancing, and in engaging in hand-to-hand combat over continuous periods of several hours without appreciable discomfort.*

(2) Each exercise should be initiated by a unit in any of the following positions:

(a) Already deployed in a firing position.

(b) Halted in approach march, or in a place of concealment; with scouts present in formation, the unit either acting alone or as part of a larger force.

(c) Advancing in approach march with scouts out.

(3) Positions should be assumed as follows:

(a) In the first case (2) (a) above, each man should be in a selected firing position, special attention being paid to individual cover and concealment.

(b) In the second case (2) (b) above, when practicable, squad leaders conduct their squads forward by covered and concealed routes and send the riflemen and the automatic rifleman to their firing positions by individual directions. Occupation of the initial firing position of a unit is done with the minimum of exposure.

(c) In the third case (2) (c) above, the advance of the scouts must be checked by either represented or assumed enemy fire when they are in the vicinity of a suitable location for a firing position for the squad; otherwise, to insure their safety, the scouts may have to be withdrawn from the exercise before firing is begun by the squad.

b. *Critique.*—Upon completion of a firing exercise and when the range is clear and the targets have been scored, the instructor conducts a critique of the exercise. A suggested list of items to be covered during such a critique is shown in figure 103. Only those items are discussed which are specifically applicable to the exercise.

c. *Types of exercises.*—(1) *No. 1.*—(a) *Purpose.*—To give practice in fire orders, application of the fire of a squad in position, fire control, and proper individual concealment in the occupation of a firing position.

(b) *Method.*—The enemy is represented by one group of targets exposed to fire but partially concealed from view and requiring a simple fire order. The squad leader is shown the targets (personnel with flag) and safety limits for firing position of the squad. When the squad leader fully understands the location and nature of the target and the instructor informs him that the range is clear, he will load live ammunition, give the fire order, and fire the problem. The range should be estimated by eye, and the target should be designated by oral description.

(2) *No. 2.*—(a) *Purpose.*—To give practice in correct issuance of fire orders, application of the fire of a rifle squad on a linear target, fire control, proper deployment and individual concealment in the occupation of the firing position, and engagement of a surprise target.

## FIELD TARGET FIRING CRITIQUE

I. *Purpose of problem.*II. *Orders of squad leader.*

- a. Method of target designation (appropriate).
  - 1. Accuracy of range, direction, and description.
  - 2. Brevity—clearness.
  - 3. Use of concealment during designation.
- b. Method of completing fire order (appropriate).

III. *Approach and occupation of the firing position.*

- a. Method.
- b. Time taken (if time is a factor).
- c. Distribution on firing point.

IV. *Actions of individuals.*

- a. Use of cover and concealment.
- b. Attention to orders.
- c. Looking to leader for signals.
- d. Individual initiative.

V. *Rate of fire.*

- a. Initially rapid to pin enemy to ground.
- b. Controlled to conserve ammunition with maximum effect.

VI. *Fire control.*

- a. Position.
  - 1. Initial position of squad leader.
  - 2. Initial position of assistant squad leader.
  - 3. Movement of leaders during firing.
- b. Methods used.
  - 1. Signals.
  - 2. Verbal orders.
  - 3. Use of assistant squad leader.
  - 4. Time required to shift fire to new targets.
- c. Distribution of fire.
- d. Adjustment of fire.
- e. Teamwork developed.

VII. *Effect of fire.*

- a. Were all targets fired on?
- b. Were all targets hit?
- c. Score.

FIGURE 103.—Field-target firing exercise check list.

(b) *Method.*—Silhouette targets representing an enemy squad deployed in a firing position are partially concealed from view but exposed to fire. Squad is in rear of the firing position; squad leader (scout) is shown the linear target (by flag) and then conducts squad forward and disposes it in a concealed firing position. When squad leader (scout) is told the range is clear, he will engage the target with fire. A surprise target representing an enemy machine gun well to the flank of the first target appears shortly after the squad has engaged the linear target. The squad leader is told the amount of fire to shift to the surprise target.

(3) *No. 3.*—(a) *Purpose.*—To give practice in having a target designated by scouts with tracer ammunition and in approaching and assuming a firing position for a squad.

(b) *Method.*—The squad is in the approach march with both scouts well in advance. When the scouts reach the firing position, they are fired on by an enemy group about 400 yards to their front (burst of fire from a machine gun in a pit near the targets). They determine the range by firing on the target with tracers. The squad leader conducts his squad forward, establishes the men in firing positions, and engages the targets with the proper class of fire after the targets have been designated with tracers by the scouts. Special attention is paid to the use of cover and concealment by all men while moving up and during the selection and occupation of positions.

(4) *Additional exercises.*—Suggested subject matter for additional problems is listed below:

(a) A situation to show the action of the scouts, squad leader, and other members of the squad when the scouts discover a group of the enemy without being seen themselves.

(b) A situation which requires the leader to use his automatic rifle while keeping his riflemen, initially, under cover.

(c) A situation which initially requires the use of either a part or all of the riflemen, and which later in the exercise requires the use of the automatic rifle team against a surprise target.

(d) A situation requiring the squad to take up specific defensive positions. Suggested situations are:

1. Squad in defense of a road block.

2. Squad in defense of a stream crossing.
3. Squad in delaying action.

(e) A situation requiring the squad to deliver fire over the heads of forward defiladed elements.

(f) A situation requiring the cooperation of the riflemen and automatic rifle team with the rifle grenadier. Suggested situations are:

1. A group of the enemy in a depression, such as a quarry or narrow defile, is driven into the open by the rifle grenadier using antipersonnel grenades. The riflemen and automatic rifleman, who have been placed in position to cover all avenues of escape, establish "killing zones," assuring destruction of the enemy when he is forced into the open.
2. While the riflemen and automatic rifleman engage enemy tanks to prevent the crews from opening doors to throw grenades into fox holes or emplacements, the rifle grenadier knocks out the tanks as they come within range.
3. The use of riflemen and the automatic rifleman to prevent the escape of the crews of hostile tanks, or to prevent enemy salvage crews from rendering assistance to disabled tanks after they have been knocked out by the rifle grenadier.

(g) A situation to show the use of the squad in street fighting. Suggested situations are:

1. Use of part of the riflemen and/or automatic rifleman to establish killing zones in streets and alleys.
2. The use of part of the riflemen and/or automatic rifleman to fire on doors and windows to cover the approach of the remaining riflemen of the squad as they clear the enemy from the buildings.
3. The use of part or all of the squad to cover a street barricade with fire.

(h) A situation showing the use of the fire power of the squad in wooded areas:

1. To cover brushy areas, where the enemy is known to be concealed, with fire.

2. To fire down lanes and gaps and to cover small open areas with fire.

(i) A situation requiring the use of the fire power of the squad against aerial targets. Examples are:

1. Low-flying radio-controlled airplanes.
2. Represented enemy paratroopers.

(5) *Related training.*—Depending upon the availability of time, range facilities, and sufficient quantities of ammunition, field-target firing exercises should be extended to include tactical situations requiring actions and orders of platoon, squad, and assistant squad leaders. This type of training is referred to as "combat training exercises." At the end of this training period, higher commanders conduct their tests to determine the proficiency of rifle platoons. The tests are called "platoon combat proficiency tests."

## SECTION VIII

### DESTRUCTION OF ORDNANCE MATÉRIEL

■ 135. DESTRUCTION OF ORDNANCE MATÉRIEL IN EVENT OF IMMEDIATE CAPTURE IN COMBAT ZONE.—*a. General.*—The decision to destroy ordnance matériel to prevent its capture and use by the enemy is a command decision and will be ordered and carried out only on authority delegated by the division or higher commander.

*b. Principles governing destruction.*—The following are the fundamental principles to be observed in the execution of an order to destroy small arms:

(1) The destruction must be as complete as circumstances will permit.

(2) Lacking time for complete destruction, the parts essential to operation of the weapon must be destroyed, beginning with those parts most difficult of duplication by the enemy.

(3) *The same essential parts of each weapon must be destroyed to prevent the reconstruction of a complete weapon from several damaged ones.*

*c. Training.*—The training of individuals before they reach the combat zone will be such as to insure their ability to de-

stroy quickly and adequately the weapon(s) with which they are armed in an established and uniform sequence, based on the principles stated in *b* above. Training will not involve the actual destruction of matériel.

*d. Methods.*—Of the two methods outlined herein for the destruction of the rifle, the first is preferred.

(1) *Method No. 1.*—Grasp the butt of the rifle with both hands and smash the barrel against a tree, rock, or firm ground until it is bent. Remove and disassemble the bolt. Distort the mainspring. Insert the point of striker into the hole in the face of the bolt and break it off. Break the stock. Elapsed time required for this method: 1 minute.

(2) *Method No. 2.*—Insert the bullet end of a complete round into the muzzle and bend the case slightly, distending the mouth of the case to permit pulling out the bullet. Spill some of the powder; retain a sufficient amount to cover the bottom of the case to a depth of approximately  $\frac{1}{8}$  of an inch. Reinsert the bullet in the case, *point first*. Chamber and fire this round with the reduced charge; the bullet will stick in the bore. Chamber one complete round, lay the rifle on the ground, and fire it, using a 30-foot lanyard. (A lanyard may be improvised by tying together several thongs from oiler and thong cases.) Use the best available cover, as this means of destruction may be dangerous to the person destroying the weapon. Elapsed time required for this method: 2 or 3 minutes.

**Warning:** Do not attempt to destroy the rifle by firing it with the muzzle stuck in the ground. Destruction by this means is not assured.

*e. Destruction of ammunition.*—When time and materials are available, ammunition may be destroyed as follows: Break out all packed ammunition from boxes or cartons. Stack the ammunition in a heap. Stack or pile wood, or available gasoline and oil in cans or drums, around the ammunition. Throw onto the pile all available inflammable material such as scrap wood and brush. Pour any remaining gasoline or oil over the pile. Sufficient inflammable material must be used to insure a very hot fire. Ignite the materials and take cover. Thirty to sixty minutes will be required to destroy the ammunition carried by small combat units.



## CHAPTER 6

### ADVICE TO INSTRUCTORS

SECTION I. General.....	136
II. Mechanical training.....	137
III. Marksmanship, known-distance targets.....	138-154
IV. Marksmanship, aerial targets.....	155-159
V. Technique of fire.....	160-167
VI. Safety precautions.....	168-169

#### SECTION I

##### GENERAL

■ 136. PURPOSE.—With the exception of material contained in section VI, the provisions of this chapter are to be accepted as a guide only and will not be considered as having the force of regulations. They are particularly applicable to emergency conditions when large bodies of troops are being trained under officers and noncommissioned officers who are not thoroughly familiar with approved training methods.

#### SECTION II

##### MECHANICAL TRAINING

■ 137. CONDUCT OF TRAINING.—*a.* As a general rule, instruction is so conducted as to insure the uniform progress of the unit.

*b.* The instructor briefly explains the subject to be taken up and demonstrates it himself or has a trained assistant do so.

*c.* The instructor causes one man in each squad or subgroup to perform the step while he explains it again.

*d.* The instructor next causes all members of the squads or subgroups to perform the step under the supervision of their noncommissioned officers. This is continued until all men are proficient in the particular operation, or until those whose progress is slow have been placed under special instructors.

*e.* Subsequent steps are taken up in like manner during the instruction period.

## SECTION III

## MARKSMANSHIP, KNOWN-DISTANCE TARGETS

■ 138. GENERAL.—*a.* Training is preferably organized and conducted as outlined in paragraphs 37, 38, and 39. Ordinarily, officers are the instructors of their units. As only one step is taken up at a time and as each step begins with a lecture and a demonstration showing exactly what to do, the trainees, although not previously instructed, can carry on the work under the supervision of the instructor.

*b.* It is advisable that battalions or smaller units be relieved from routine garrison duty during the period of preparatory marksmanship training and range practice.

*c.* Although not strictly a part of instruction in rifle marksmanship, training of the soldier to wear the gas mask over extended periods without material discomfort and attendant loss of battle efficiency is considered to be directly related to proper physical conditioning for rifle marksmanship and subsequent training with the rifle—field-target firing exercises and combat training exercises. It is highly desirable that the soldier have extensive practice in wearing his gas mask while marching to and from the preparatory training field and the target range. (See FM 21-40.)

■ 139. ASSISTANT INSTRUCTORS.—*a.* It is advantageous to have all officers and as many noncommissioned officers as possible trained in advance in the prescribed methods of instruction. When units are undergoing marksmanship training for the first time, this is not always practicable nor is it absolutely necessary. A good instructor can give a clear idea of how to carry on the work in his lecture and demonstration preceding each step. In the supervision of the work following the demonstration, he can correct any mistaken ideas or misinterpretations.

*b.* When an officer in charge of rifle instruction (par. 39*d*) is conducting successive organizations through target practice, it is advisable to attach to the first organization taking the course, for the period of preparatory work and for a few days of range firing, officers and noncommissioned officers of companies that are to follow. These act as assistant instruc-

tors when their own companies take up the work. Such assistants are particularly useful when one group is firing on the range and another is going through the preparatory exercises, both under the supervision of one instructor.

■ 140. EQUIPMENT.—*a. General.*—The instructor should personally inspect the equipment for the preparatory exercises before the training begins. A set of model equipment should be prepared in advance by the instructor for the information and guidance of the organization about to take up the preparatory work.

*b. Sighting bar.*—The sighting bars must be made as described, and the hole representing the peep sight must be absolutely circular. If the sights are made of tin, the holes should be bored by a drill. Good rear sights can be made for the sighting bars by using cardboard and cutting the holes with a punch.

*c. Sighting device.*—(1) The sighting device (fig. 20) will be used in conjunction with the sighting and aiming exercises, with exercises in zeroing the rifle, and with sight-setting and sight-changing exercises.

(2) Pupils will carry the sighting device with them throughout their instruction in rifle marksmanship. At frequent intervals, the instructor will check on their ability to set a correct sight picture and to effect correct sight settings and sight changes on the sighting device. The instructor will demand absolute perfection in all these exercises (pars. 41b(2), 41c(2), and 53a).

*d. Bull's-eyes.*—When small gallery targets are not available, bull's-eyes may be painted on a white disk or cut out of black paper and pasted on white paper. These are satisfactory aiming points to use in position and trigger-squeeze exercises.

■ 141. INSPECTION OF RIFLES.—No man is required to fire with an unserviceable or inaccurate rifle. All rifles should be carefully inspected far enough in advance of the period of training to permit organization commanders to replace all inaccurate or defective rifles. Rifles having badly pitted barrels are not accurate and should not be used.

■ 142. **AMMUNITION.**—The best ammunition available should be reserved for record firing, and the men should have a chance to learn their sight settings with that ammunition before record practice begins. Ammunition of different makes and of different lots should not be used indiscriminately.

■ 143. **ORGANIZATION OF WORK.**—*a. In preparatory training.*—  
(1) The field upon which the preparatory work is to be

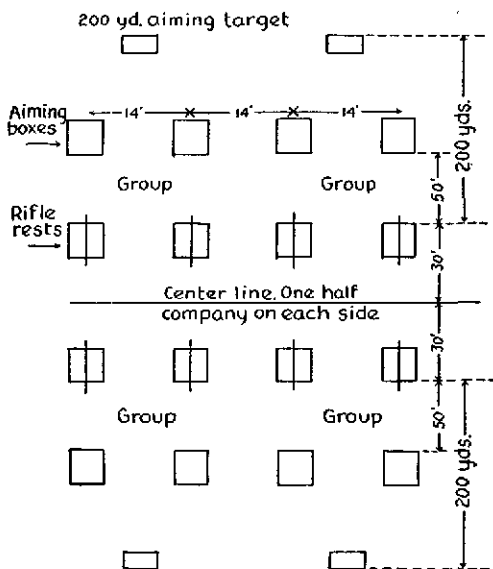

FIGURE 104.—Field lay-out for sighting and aiming exercises.

given should be selected in advance and a section of it assigned to each organization. The equipment and apparatus for the work should be on the ground and in place before the morning lecture is given, so that each organization can move to its place and begin work immediately and without confusion.

(2) Each company should be organized in two lines, facing away from each other. In this way the officers and other

instructors, whose position is normally between the lines, have all of their squads under close supervision. In figure 104 the represented groups consist of eight men each.

(3) The arrangement of the equipment is as follows:

(a) On each line are placed the sighting bars and rifle rests at sufficient intervals to permit efficient work.

(b) Fifty feet from each line of rifle rests is placed a line of small boxes with blank paper tacked on one side, one box, and one small sighting disk for each rifle rest.

(c) Two hundred yards from each line of rifle rests is placed a line of frames suitable for 200-yard shot group exercises, one frame for each squad. These frames have blank paper tacked or pasted on the front. Two 10-inch sighting disks are placed with each frame. Machine-gun target frames are acceptable for this work.

(4) In position, trigger-squeeze, and sustained-fire exercises, targets should be placed at 1,000 inches and at 200 yards from the firing lines (fig. 105). The groups represented in figure 105 consist of eight men each.

(5) When sufficient level ground is not available for the above arrangement, the organizations will have to vary from it in some particulars. It will usually be found, however, that all of the work except the long-range shot group work can be carried on in two lines.

*b. In range practice.*—(1) The range work should be so organized that there is a minimum of lost time on the part of each man. Long periods of inactivity while awaiting a turn on the firing line should be avoided. For this reason, the number of men on the range should be comparable to the number of targets available.

(2) Usually six men per target are about the maximum and four men per target the minimum for efficient handling.

(3) When four orders are designated on each target, the double coaching system may be employed. This system is particularly desirable, since all men are kept busy and additional practice ("dry" work) may be given. In this system, the first and third orders pair up in the coach-and-pupil method of instruction. The second and fourth orders do likewise. In this way, the first order is firing while being

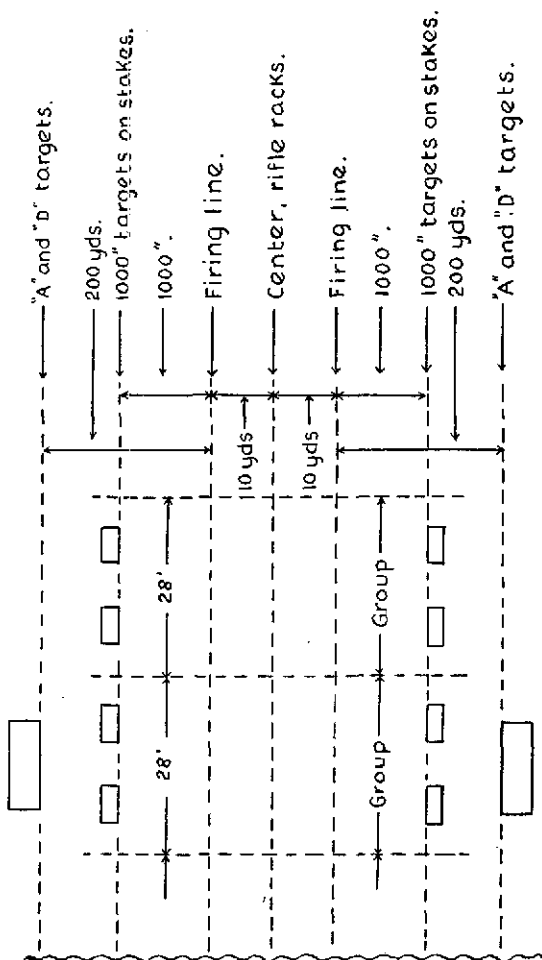

FIGURE 105.—Field lay-out for position, trigger-squeeze, and sustained-fire exercises.

coached by the third order. In the meantime, the second order, coached by the fourth order, is on the line dry-shooting. When the first order finishes firing, the second order is already on the line with the sling adjusted and in position to fire. No time has been wasted between orders. The first order, after placing rifles in rifle racks, returns to the line to coach the third order in dry-shooting while the second order is firing. This sequence is continued until each order has completed both dry-shooting and firing on the line. This system is equally applicable to sustained fire. If more than four orders are necessary, supervised preparatory work should be organized behind the line. In no circumstance should time be wasted in idleness while the men are waiting to go on the line to fire.

(4) Subject to ammunition allowances, the following method of conducting range practice has been found to produce uniformly excellent results when the full allowance of time is devoted to the training.

(a) Firing is begun by a group consisting of approximately half of each organization. This group is made up of those proved to be the best marksmen by the examination on preparatory work and those known to be "good shots." The men who are not included in this first group make up all fatigue details and undergo additional preparatory training.

(b) At the completion of instruction practice, all of the first group, except those few who have not been shooting well, fire for record.

(c) When the first group has completed firing, the second group, made up of those who have not fired and those who were rejected from the first group, begin their firing. The men who have completed record firing perform all fatigue duties.

(d) At the completion of instruction practice, all of the second group who have been shooting well and have a very good chance to qualify fire for record.

(e) During the remainder of the allotted time, the efforts of the officers and noncommissioned officers are concentrated on the men who were not ready to fire for record with the second group. This last group completes firing for record by the end of the allotted time for range practice.

(5) When range facilities are such that the entire organization can fire at one time without having more than six men per target, the same general scheme as that outlined above may be applied. The details of such plan are as follows:

(a) Firing is begun with all of the men of the organization taking part.

(b) At the completion of instruction practice, all except those who have not been shooting well fire for record.

(c) The efforts of the instructors are concentrated on the remainder of the organization for the rest of the allotted time.

(6) Another system may be employed whereby units the size of a company may be broken down so as to permit the use of the double coaching system described in (3) above. This system requires that the company be divided into three echelons. Each echelon, consisting of approximately one-third of the company, takes its turn in one of the three following stages: preparatory training; range firing; fatigue, pit details, and performance of the interior economy tasks (guard, K.P., charge of quarters, etc.) of the company. This reduces the echelons to a size which will permit four orders per target on the range per echelon and further insures that these men actually in the process of training can devote their entire time and attention to that training.

(7) In preliminary range practice, a time limit of  $1\frac{1}{2}$  minutes per shot (cumulative) may be allowed each rifleman. This time limit will not affect the good shots and may be advantageous to the poor shots. It will prevent waste of time by some men and will help the unskilled riflemen to fire their scores without becoming fatigued because it will tend to eliminate repeated efforts to fire each shot. As a whole, better shooting will be accomplished.

■ 144. SCHEDULES.—The following schedules are suggested as guides for a course in preparatory marksmanship instruction. A basic rule of instruction which should be kept in mind throughout the instructional period is that, generally, only one step is explained, demonstrated, and practiced before another step is introduced.



*a. Preparatory training—conference, demonstration, and practical work (C, D, and PW).*

		Hours	
		AM	PM
<b>FIRST DAY</b>			
C and D.....	Orientation and first sighting and aiming exercise.....		½
PW .....	First sighting and aiming exercise.....		½
C and D.....	Second and third sighting and aiming exercises .....		½
PW .....	Second sighting and aiming exercise and third sighting and aiming exercise at 50 feet.....	1½	
PW .....	Third sighting and aiming exercise at 200 yards.....	1	
C and D.....	Review of morning's work.....		½
PW .....	Continuation of third sighting and aiming exercise.....		1½
C, D, and PW..	Adjustment of sling (loop and hasty)...	1	
C .....	Safety precautions.....		½
C .....	Score book and sight changes.....		½
<b>SECOND DAY</b>			
C and D.....	Prone position, holding the breath.....		½
PW .....	Prone position, holding the breath.....	1½	
C, D, and PW..	Sitting position.....	1	
C, D, and PW..	Squatting position.....	1	
C, D, and PW..	Kneeling and standing positions.....		1
C .....	Score book and sight changes.....		½
C, D, and PW..	Trigger-squeeze exercise in all positions, including sandbag rest position.....		2½
<b>THIRD DAY</b>			
C and PW.....	Assuming position rapidly.....	1½	
C, D, and PW..	Score book and sight changes.....		½
D and PW.....	First sustained-fire (bolt manipulation and cadence) exercise.....	2	
D and PW.....	Second sustained-fire (bolt manipulation, cadence, and timing) exercise..		2
C, D, and PW..	Score book and sight changes.....		½
D and PW.....	Third sustained-fire (bolt manipulation, cadence, timing, and loading) exercise.....		1½
<b>FOURTH DAY</b>			
C, D, and PW..	Score book and sight changes.....	1	
PW .....	Trigger squeeze—review all positions.....	1½	
PW .....	Sustained-fire exercises—review all positions.....	1½	
E .....	Examination <sup>1</sup> .....		2
PW .....	Review <sup>1</sup> .....		2

<sup>1</sup> Lack of proficiency disclosed by examination will be corrected at once by additional instruction.

NOTE.—The preparatory marksmanship exercises are the same for all courses.

*b. Range practice.*—The schedule of firing should be based upon a maximum of six men for each target. The instruction practice firing outlined in paragraphs 48 to 51, inclusive, for each course is meant to serve as a guide. The amount of practice firing to be given and the number of shots to be fired at each range will be such as to obtain the maximum training in conformity with conditions and the ammunition allowance.

■ 145. LECTURES AND DEMONSTRATIONS.—*a.* The lectures at the beginning of each step are an important part of the instruction. The lectures may be given to the assembled command or group undergoing preparatory rifle training up to and including a regiment or body of untrained men of similar size. However, when a battalion takes up rifle training, the lectures and demonstrations, as a rule, are made by the captain or a lieutenant of each company. While it is not necessary that they be expert shots, it is desirable, when possible, that they be selected from among officers who are expert shots, or at least experienced riflemen.

*b.* The notes on lectures which follow are to be used merely as a guide. The points which experience has shown as those usually requiring elucidation and demonstration are placed in headings in italics. The notes which follow each heading are merely to assist the instructor in preparing his lecture. The lecturer should know in advance what he is going to say on the subject. In no circumstance will he read over to a class the outlines for lectures contained herein, nor will he read a lecture prepared by himself. During the lecture, the headlines in italics made out by himself serve as a guide to the order in which the subjects are to be discussed. If he cannot talk interestingly and instructively on each subject without further reference to notes, he should not give the lectures at all.

■ 146. FIRST HALF-DAY.—*a. General.*—(1) *Assembly.*—The class is assembled in a building, or natural amphitheater in the open where all can hear the instructor and see the demonstrations.

(2) *Equipment*.—The following equipment should be provided:

- 1 sighting bar, complete.
- 1 sighting device for each man (par. 140c).
- 1 rifle rest.
- 1 rifle.
- 1 small sighting disk.
- 1 long-range sighting disk.
- 1 small box.
- Material for blackening sights.
- 1 enlarged model of sight picture(s).
- 1 blackboard with chalk, or chart.
- Paper.
- Pencil.
- Thumb tacks.
- 1,000-inch target frame for 200-yard triangles.
- Tissue paper for transferring triangles.

b. *Orientation*.—The following subjects are usually covered in the first lecture as an orientation for sighting and aiming exercises:

(1) *Value of knowing how to shoot*.—(a) The rifle is the principal weapon of the infantry in war. Expertness in its use gives the individual confidence and high morale.

(b) Individual proficiency increases the efficiency of the infantry as a whole.

(c) Rifle firing is good sport.

(2) *Objects of target practice*.—(a) To teach the man to use the rifle so that the essentials of good shooting become instinctive (par. 32).

(b) To show the men how to teach others.

(c) To train future instructors.

(3) *Training to shoot well*.—(a) Any man can be taught to shoot well. Shooting is a purely mechanical operation which can be taught to anyone physically fit to be a soldier.

(b) Shooting requires no inborn talent such as is needed to play a violin or paint a picture.

(c) There are only a few simple things that must be done in order to shoot well, but these things must be performed with absolute precision. If they are done in a manner only approximating accuracy, the results will be poor.

(4) *Coach-and-pupil method.*—The instructor explains how the men coach each other when they are not under instruction of an officer or noncommissioned officer. He requires selected men to demonstrate to the class the role of the coach and explains that the coach and pupil exchange places from time to time.

(5) *Importance of accuracy.*—The instructor impresses the men undergoing instruction with the necessity for carefulness and accuracy in performing each step of the preparatory exercises, with emphasis laid on the fact that good shooting results from precision acquired in the preliminary training.

(6) *Progress chart.*—The instructor explains to the men undergoing instruction that each man's squad leader and his platoon leader will keep a record of his progress on the progress chart to indicate the soldier's proficiency in the use of the rifle. The marking system should be explained on a blackboard or chart.

(7) *Examination of men on preparatory work.*—The instructor explains that all men will be examined in the preparatory work before going to the range. A series of suitable questions and answers for this examination is given in paragraph 46.

*c. Sighting and aiming exercises.*—(1) *Essentials to good shooting.*—See paragraph 32.

(2) *Sight alinement.*—Show by use of the model sight picture (or by use of the blackboard) the correct sight alinement. Explain its importance.

(3) *First sighting and aiming exercise.*—Explain the purpose of this exercise and have a squad on the stage or platform to show how it is conducted.

(4) *Blackening the sights.*—Explain why and demonstrate how this is done.

(5) *Second sighting and aiming exercise.*—Assume that some of the squad have qualified in the first exercise. Put these men through the second sighting and aiming exercise and show how it is done.

(6) *Third sighting and aiming exercise.*—Assume that some of the squad have qualified in the second sighting and aiming exercise. Put these men through the third sighting

and aiming exercise and show how it is done. Show how the squad is organized by the coach-and-pupil method, in order to keep each man busy all the time.

(7) *Long-range shot group work.*—Show the class the disk for 200-yard shot group work. Explain how this work is carried on and why. Show some simple system of signals that may be used. Explain that two groups may use one 1,000-inch screen target at the same time.

*d. Instructor's procedure.*—(1) *Method of instruction.*—Instruction in the use of the rifle is the same in nature as that required for teaching any mechanical operation. The instruction is divided into several groups of exercises. The rifleman is taught each exercise and practices it before going to the next. After each phase of instruction (morning or afternoon), by means of a brief review, the instructor emphasizes the salient points covered and stresses the need for carefulness and accuracy. When the rifleman has been taught all of the exercises, he is taken to the rifle range to apply what he has learned. If he has been properly taught the essentials of good shooting (par. 32), he will shoot well from the very beginning of range practice.

(2) *Attitude of instructor.*—If the instructor is interested, enthusiastic, and energetic, the men will be the same. If the instructor (squad or platoon leader) is inattentive, careless, and bored, the men will be the same, and the scores will be low.

(3) *Class assignment.*—The members of the class should be assigned positions on the preparatory field.

(4) *Suggestions.*—Before concluding each portion of his lecture, the instructor asks whether there are any questions. He also causes all leaders to keep progress charts up to date. The work should be organized so that all men are busy at all times. The men should be allowed 10-minute breaks during each hour. Short periods of calisthenics involving stretching and suppling exercises provide relief from possible tedium and also condition men for position exercises. Do not hesitate to reassemble the class to point out or demonstrate the most frequent errors noted or to emphasize or clarify important points. Before the class is dismissed, it should be given information relevant to the next period of instruction.

■ 147. SECOND HALF-DAY.—*a. General.*—(1) *Assembly.*—The class is reassembled as for the morning period, and the instructor reviews previous work, stressing the proper procedure for making triangles, including the causes for misplaced marks. He then points out the most frequent errors which were observed during the morning's work. He indicates the methods for correcting these errors and sends the class to the preparatory field to continue the morning's exercises. Depending upon the proficiency of individuals, they are advanced until all have completed the exercise in making triangles at 200 yards.

(2) *Equipment.*—The following equipment should be provided for the remainder of the instruction to be conducted during the afternoon:

- 1 A target (rifle).
- 1 B target (rifle).
- 1 D target (rifle).
- 1 large spotter.
- 3 small spotters.
- 1 blackboard with chalk (or chart).
- 1 score book and rifle (for each man).

*b. Adjustment of sling (loop and hasty).*—Explain and demonstrate the adjustment of the loop and hasty sling. Explain their uses.

*c. Safety precautions.*—Explain the safety precautions listed in paragraphs 168 and 169.

*d. Use of score book.*—Explain the different types of targets, their dimensions, and the ranges where they are used. Explain the use of spotters, the clock system of locating hits on the target, windage, windage rules, and the elevation rule. Demonstrate these matters, step by step, and solve problems.

*e. Instructor's procedure.*—See paragraph 146d(1).

■ 148. THIRD HALF-DAY.—*a. Equipment.*—The following equipment is required for this lecture and demonstration:

- 1 rifle with sling.
- 1 box with small aiming target.

*b. Orientation.*—(1) *General.*—The instructor explains that all preparatory marksmanship training successively includes all instructional matters considered during preceding

periods and that each of the essentials of good shooting should be learned thoroughly and practiced repeatedly.

(2) *Necessity for correct positions.*—No excellent shot varies from the prescribed positions. Few men with poor positions are even fair shots. Few men with good positions are poor shots. Instruction in positions includes correct aiming but does not include trigger squeeze.

(3) *Correct manner of holding breath.*—The instructor explains, demonstrates, and causes the men individually to practice the correct manner of holding the breath. The instructor then explains how a coach should observe his pupil's breathing by watching the pupil's back.

(4) *Position of thumb and cheek.*—The instructor explains that the thumb is not placed along the side of the stock because this makes it difficult to grasp the stock securely and to apply pressure straight to the rear when squeezing the trigger. By placing the thumb over or around the stock with the cheek resting on top of the thumb, the following advantages are obtained: the eye can be placed at the same distance from the peep sight for each shot; the small of the stock can be more easily grasped; and pressure can be applied on the trigger *straight to the rear* more easily and uniformly.

(5) *Position of trigger finger.*—The position of the right forefinger on the trigger will depend upon the conformation of the rifleman's hand. No part of the finger should touch the small of the stock. This insures that all pressure, when exerted, will be applied straight to the rear.

(6) *Progress charts.*—Platoon and squad leaders are reminded that the progress charts for their men should be kept up to date and that each man should be assigned a grade for each of the items shown thereon.

(7) *Relaxation.*—The instructor explains that complete relaxation is the goal to be attained in taking all positions. He should show with each exercise how a man may test any position for naturalness and relaxation. This method is as follows: Have him take what he believes to be a correct position with his sights alined on the target correctly; have him close his eyes and consciously relax his muscles for five or six seconds; have him open his eyes and again look through

his sights. If his position is correct, his sights will still be alined correctly on the target. If the sights are not correctly alined, the position is faulty and should be corrected by moving the whole body and repeating the entire process until a correct position has been attained.

(8) *Coach*.—The instructor explains that the coach should take a position from which he can observe the trigger finger and the eyes of his pupil. He demonstrates the coach's position for each of the position exercises.

*c. Position exercises*.—(1) *Prone position*.—(a) Explain and demonstrate the correct prone position, calling attention to the elements which go toward making up a correct position: gun sling properly adjusted, body at the correct angle, legs spread apart, position of the butt plate on the shoulder, position of the hands on the rifle, position of the cheek against the stock and on top of the right thumb, and position of the elbows. Stress the fact that pupils should always take position aiming at a target, never aiming at random.

(b) Demonstrate the errors which most frequently occur in taking the prone position and illustrate the methods for correcting them.

(c) Demonstrate the correct prone position again.

(d) With a squad, show how the squad leader organizes the men by employing the coach-and-pupil method in order to keep every man occupied.

(2) *Sandbag rest position*.—Explain and demonstrate in the same manner as described above for the prone position. No practical work in this position will be taken up at this stage of the instruction (par. 42f).

(3) *Sitting position*.—Explain and demonstrate in the same manner as described in (1) above for the prone position.

(4) *Squatting position*.—Explain and demonstrate in the same manner as described in (1) above for the prone position.

*d. Instructor's procedure*.—(1) See paragraph 146d(1).

(2) Send the class to the preparatory field after each of the phases of instruction described in c(1), (3), and (4) above, where each of the positions will be practiced by all men.

■ 149. **FOURTH HALF-DAY**.—*a. General*.—The class is reassembled as for the morning period, and the instructor re-



views the previous work, stressing the need for accuracy and perfection of position to be attained in each of the exercises. As in previous exercises, the men are advanced to successive exercises as soon as they have demonstrated their proficiency in each prescribed exercise.

*b. Equipment.*—The following equipment should be provided in addition to that used during the morning period:

- 1 blackboard with chalk (or chart).
- 1 score book and pencil for each man.
- 1 sandbag.

*c. Position exercises.*—(1) *Kneeling position.*—Explain and demonstrate in the same manner as described for the prone position (par. 148c).

(2) *Standing position.*—Explain and demonstrate in the same manner as described above for the prone position.

*d. Score book, effect of light and wind.*—Explain the effect of light and wind and how to determine direction and velocity of wind. Explain and demonstrate the clock system of designating wind direction and the use of the windage diagrams shown in the score book. Solve problems.

*e. Trigger-squeeze exercise.*—(1) *General.*—Read paragraph 43. Explain that there is only one correct method of squeezing the trigger—a heavy initial pressure which is constantly increased so that the rifleman does not know when the explosion will take place. Emphasize the fact that this method of squeezing the trigger produces the best results and must be applied in sustained fire.

(2) *Machine rest example.*—(a) Regardless of how well a man may have been instructed in the sighting, aiming, and position exercises, if he fails to apply the correct method of squeezing the trigger when firing a shot, all of this instruction will have been of no avail. Consequently, the instructor should demonstrate that in the final analysis the accuracy of rifle fire—all other things being favorable—depends upon correct trigger squeeze. This may best be accomplished by using a machine rest or by placing the rifle on a table, with temporary supports to hold the rifle in a given position, to illustrate the several points which follow.

(b) Lay the rifle on a table pointing across the room and

toward an imaginary target; assume that it is in a machine rest which runs on a track parallel to the line of targets; assume that you fire a shot which hits the left edge of a 36-inch bull's-eye 1,000 yards away; then move the rifle 36 inches to the right on the table as if it were sliding along the parallel track, and assume that another shot is fired. Where does it hit? Answer: The right edge of the bull's-eye. Move the rifle from side to side between these two positions and assume a shot is fired anytime while it is moving. Where will it hit? Answer: In the bull's-eye. Now assume that you hold the butt of the rifle still and move the muzzle slightly. Where will it hit? Answer: It will miss the whole target. It hits the target when the whole rifle moves but misses it when only one end moves.

(3) *Aim and hold.*—Any man can easily learn to hold a good aim for 15 to 20 seconds, which is a much longer period than is necessary to fire a well-aimed shot. Poor shots are usually the men who spoil their aim when they fire the rifles.

(4) *When coach squeezes trigger.*—(a) When the coach squeezes the trigger for the rifleman, the fact that the shot is almost invariably a good one proves that poor shooting is caused principally by errors in the trigger squeeze.

(b) By watching the rifleman's back, the coach knows when the rifleman is aiming. During such time, the coach presses steadily on the trigger. Demonstrate how this is done.

(5) *When rifle goes off before man is ready.*—Often a man who has been doing poor shooting will state upon firing a shot, "I cannot call that shot. It went off before I was ready." Almost invariably these shots are well placed. His poor shots have been caused by getting ready for them.

(6) *Following through.*—Explain what is meant by following through and why it is important.

(7) *Calling the shot.*—Explain the meaning of calling the shot and why this is done.

(8) *Application.*—(a) Demonstrate the duties of the coach in the trigger-squeeze exercise by calling attention to each item.

(b) The work is carried on as in position exercises, with the addition of squeezing the trigger.

(c) Practice trigger squeeze in the prone position for 45

minutes, in the sitting and squatting positions for 30 minutes each, and in the kneeling and standing positions for 15 minutes each. Only those men who are having difficulty in squeezing the trigger correctly will need to use the sandbag. The coach should assure himself that the pupil has understood the instruction as to how to squeeze the trigger properly by requiring the pupil to squeeze the trigger which the coach has engaged with his finger, that is, to squeeze the trigger through the coach's finger.

*f. Instructor's procedure.*—(1) See paragraph 146*d*(1).

(2) Do not let the class become bored with this work. It is easy to learn, but it takes much practice to train the muscles to form the habit of doing the right thing without thinking.

(3) Send the class to the preparatory field for practical work after each of the demonstrations and discussions listed under *c*, *d*, and *e* above.

■ 150. FIFTH HALF-DAY.—*a. Equipment.*—The following equipment is required for this period of instruction:

1 rifle with gun sling (for each pupil).

1 empty clip (for each pupil).

*b. Taking positions rapidly.*—(1) Explain and demonstrate the method of going into each position rapidly and firing the first shot. The time prescribed in sustained fire for assuming the prone, sitting, or kneeling positions is 11 seconds.

(2) Explain and demonstrate the duties of the coach.

(3) Send the class to the preparatory field for practical work in all positions, issuing at first a greater time interval than the 11 seconds.

*c. Score book, windage rule.*—Explain and demonstrate the windage rule formula. Require pupils to work various problems involving application of the rule and have them make comparison with the windage diagram in the score book.

*d. Sustained-fire exercises.*—The following subjects should be included in the discussion:

(1) *Sustained fire true test of good shot.*—Superiority of fire in battle depends on the ability to deliver rapid and accurate fire. Both are required and are obtained by careful training.

(2) *Trigger squeeze.*—Trigger squeeze is applied the same as in slow fire.

(3) *Keeping eye on target.*—Explain the advantages of keeping the eye on the target (how it gains time).

(4) *Application in war.*—Explain the advantage of keeping the eye on the target in combat.

(5) *Operation of bolt in sustained-fire exercises.*—(a) Show how the follower is held down by the use of an empty clip and explain why. Demonstrate the exercise.

(b) Show how the bolt is operated in the various positions (prone, sitting, kneeling, and squatting), calling attention to the details in each case.

(6) *Accuracy.*—Emphasize frequently that accuracy of performance on each shot is the chief element in the sustained-fire exercises, that speed is secondary and increases with experience, and that a coach should never urge his pupil to more speed at a sacrifice of accuracy.

(7) *First sustained-fire (cadence) exercise.*—(a) Explain cadence in firing (6 seconds for each shot) and the necessity therefor.

(b) Explain that on the preparatory field the cadence is started at 10 seconds for each shot, that this time is reduced to 8 seconds, and that it is finally decreased to 6 seconds for each shot as the men increase in proficiency.

(c) Demonstrate the cadence exercise.

(d) Keep the progress charts up to date.

(e) *Instructor's procedure.*—The instructor sends the class to the preparatory field for practical work in the cadence exercise in the prone, sitting, squatting, and kneeling positions, as described in paragraph 146d(1).

■ 151. SIXTH HALF-DAY.—a. *Second sustained-fire (bolt manipulation, cadence and timing) exercise.*—(1) Equipment needed for demonstration is the same as that for the first sustained-fire exercise.

(2) Demonstrate the exercise in all positions and indicate the duties of the coach.

(3) Re-emphasize the fact that exactness in performance is the goal and that speed is of secondary importance.

(4) Send the class to the preparatory field for practical work in all positions.

b. *Score book.*—(1) A blackboard with chalk is required

for the conduct of this period of instruction. Each student should have his rifle, score book, and pencil.

(2) Explain what is meant by the zero of the rifle.

(3) Present several examples involving zeroing a rifle on a day with no wind and on days when there is a wind. Pupils should be required to make the changes on their rifle sights and in their score books as the examples proceed. The sighting device (fig. 20) can also be used.

*c. Third sustained-fire (bolt manipulation, cadence, and loading) exercise.*—(1) The following equipment is needed for demonstration purposes:

1 box with 1,000-inch D target (rifle).

1 rifle with sling.

2 clips of corrugated dummy cartridges.

(2) Explain that in this exercise the pupil is required to fire nine dummy rounds at the sustained-fire cadence, respectively (six seconds per shot), going from the standing to the prescribed position and reloading from the belt (par. 44).

(3) Demonstrate loading from the belt in all positions.

(4) Demonstrate the exercise in each position, pointing out the duties of the coach.

(5) Emphasize the fact that smoothness and accuracy are more important than speed.

(6) Send the class to the preparatory field for practical work in all positions.

■ 152. SEVENTH HALF-DAY.—*a. Use of score book on range.*—

(1) The following equipment is needed:

1 blackboard with sheet from score book reproduced thereon, and chalk.

Rifle, score book, and pencil for each pupil.

(2) Explain and demonstrate the use of the score book on the range.

(3) Require each pupil to follow the instruction by making entries in his score book and by setting the necessary changes on his sight.

(4) Give ample opportunity for pupils to ask questions.

*b. Review of trigger-squeeze exercises.*—Briefly review the proper method of squeezing the trigger, emphasizing the

salient points as described originally. Send the class to the preparatory field for additional practice in all positions and insure that squad and platoon leaders have given each of their men an appropriate grade on the progress chart.

*c. Review of sustained-fire exercises.*—Conduct this period of review of sustained-fire exercises in a manner similar to that described above for trigger-squeeze exercises.

■ 153. EIGHTH HALF-DAY.—*a. Examination.*—See paragraph 46.

*b. Review.*—This period may be used to give additional instruction to men who did not receive a satisfactory grade in the examination or who need instruction in some particular phase of marksmanship. Other men may be excused.

■ 154. RANGE INSTRUCTION.—This period of instruction should immediately precede range firing. (See paragraph 53*a* for explanation of use of sighting device prior to range firing.) The instruction is best conducted on a firing point of the rifle range.

*a.* The following equipment is required for the demonstrations:

1 rifle with sling.

1 sandbag.

Material for blackening sights.

Dummy cartridges.

*b.* The following subjects should be discussed prior to slow-fire instruction firing.

(1) *Preparatory work applied.*—Range practice is carried on practically the same as a trigger-squeeze exercise, except that live ammunition is used.

(2) *Coaching.*—The coach watches the man, not the target. The coach sees that the pupil makes his own entries in the score book; the coach makes no entries. Officers and non-commissioned officers supervise and prompt the men acting as coaches and personally coach pupils who are having difficulty.

(3) *Spotters.*—Explain use of spotters in slow fire.

(4) *Disks.*—Explain value and use of disks in slow fire.

(5) *Sandbag rest.*—(*a*) Explain why it may be used in special cases.

(b) Demonstrate a coach adjusting the sandbag to a pupil who requires special instruction.

(6) *Watching the eye.*—Explain how this indicates whether or not the pupil is squeezing the trigger properly.

(7) *Position of coach.*—Demonstrate in each position.

(8) *Coaching in slow fire.*—(a) Place a man on the firing point and, by calling attention to each item, show what a coach does (par. 53e(7)).

(b) Demonstrate the use of dummy cartridges in slow fire.

(c) Demonstrate how the coach squeezes the trigger for the pupil.

(d) Explain that if the pupil has not fired a slow-fire shot within 10 seconds after he has begun to hold his breath and started his trigger-squeeze, his coach should require him to release the pressure on the trigger, breathe, look away from the target, and then start over. Shots which take a long time to "get off" are seldom good.

(9) *Use of telephone.*—Explain its use by the telephone operator, the rifleman, noncommissioned officers, and officers in charge of firing (par. 54h).

(10) *Final precautions for slow fire.*—See paragraphs 53, 168, and 169.

c. Individuals who are not proficient in slow fire should be given further instruction before they are allowed to proceed with sustained fire. If given before correct slow fire is mastered, sustained-fire instruction is a waste of time and ammunition and fixes bad shooting habits.

d. The following subjects should be discussed after completing slow-fire instruction firing and prior to sustained-fire instruction firing.

(1) *Spotters.*—Explain use of spotters in sustained fire.

(2) *Disks.*—Explain value and use of disks in sustained fire.

(3) *Use of dummy cartridges in sustained fire.*—Show how dummy cartridges are mixed with live ammunition for sustained-fire training and explain why this is done.

(4) *Demonstration of coaching in sustained fire.*—Same procedure as in paragraph 53f(2).

(5) *Shot group.*—Explain what is meant by shooting for a

group and how this grouping of shots is an indication of correct and expert shooting ability.

(6) *Accuracy before speed.*—Explain that sustained fire is identical to slow fire in all respects except for the fact that the time interval between successive shots is reduced and that all shots should be fired within a given time limit (par. 44). This requires that a fire cadence be established through smooth and rapid bolt manipulation, rhythmic sight alignment and trigger-squeeze, elimination of waste motion, and avoidance of loss of time.

## SECTION IV

### MARKSMANSHIP, AERIAL TARGETS

■ 155. PRELIMINARY PREPARATION.—*a.* The officer in charge of rifle antiaircraft training should be thoroughly familiar with the subject, should have an adequate number of officers detailed as assistant instructors, and should train the assistant instructors and a demonstration group before the first training period.

*b.* He should inspect the range and equipment in sufficient time prior to the first training period to permit correction of deficiencies.

■ 156. DESCRIPTION OF MINIATURE RANGE.—*a. Targets.*—(1) *Horizontal.*—This target is designed to represent a sleeve target towed by an airplane flying parallel to the firing point.

(2) *Double diving and climbing.*—This target is in two sections. The right section is designed to represent a sleeve target towed so as to pass obliquely across the front of the firing line in the manner of an airplane diving, if run from left to right, or climbing, if run from right to left. The left section is the same, but represents an airplane diving from right to left and climbing from left to right.

(3) *Overhead.*—This target is designed to represent a sleeve target towed by an airplane which is approaching the firing line and will pass overhead. When run in the opposite direction, it represents a sleeve that has passed over the firing line.



(4) *Parachute*.—This target is designed to represent a parachute descending vertically.

*b. Size and speed of silhouette*.—(1) The black silhouette of the horizontal and the climbing and diving targets is a representation at 500 inches of a 15-foot sleeve at a range of 330 yards. It is 7.5 inches long. The speed of the silhouette should be not less than 15 feet per second. This speed represents that of an airplane flying 245 miles an hour at a range of 330 yards. The size and speed of the silhouette are based upon the time of flight of the caliber .22 bullet for 500 inches. This time of flight is approximately 0.04 of a second. When the target is moving at a speed of 15 feet or 180 inches per second, it will move 180 times .04 or 7.2 inches. Therefore, in order to hit the silhouette, the aim must be directed approximately one silhouette length (lead) in front of it. If two or three leads are used, the shot will hit in the appropriate scoring space. This does not hold true on the overhead target. If the shot is fired when the range is less than 500 inches from the rifleman, the required lead will be less than one target length.

(2) The black silhouette of the parachute target at 500 inches represents a parachutist at a range of 300 yards. The target is operated at a speed of descent of 1 foot per second, which corresponds approximately to the angular travel of a parachutist descending 17 feet per second at a range of 300 yards. No leads are required to obtain hits on the black silhouette.

■ 157. PREPARATORY EXERCISES.—*a.* A method of conducting the preparatory exercises is given in paragraph 79.

*b.* Each assistant instructor is assigned a target and conducts the preparatory training and firing of all groups on his target.

*c.* In preparatory training, coaches and pupils should change places frequently.

*d.* Forty-five minutes at each type of target should be sufficient to train each soldier in the preparatory exercises.

*e.* A detail of one noncommissioned officer and four or six men should be provided to operate each type of target except the parachute, which requires only one man,

**■ 158. MINIATURE RANGE PRACTICE.—a. (1) Caliber .22 rifle.—**

(a) The .22 caliber rifle, as issued, is equipped with a Lyman sight. Upon request, ordnance personnel will replace the Lyman sight with an open sight which is more practicable for antiaircraft firing (par. 77c). However, the replacement of the sight is not necessary. If the aperture of the Lyman sight is unscrewed and removed from its frame, the frame itself can be used as a peep sight. This procedure is recommended as a time- and labor-saving expedient.

(b) Two magazines for each caliber .22 rifle should be provided.

(c) Ammunition should be available immediately in rear of the firing line at each type of target.

(d) Coaches should load magazines as they become empty.

(e) Scorers should be detailed for each type of target. After each score is fired, they score the target. They call off the number of hits made on each silhouette and pencil or chalk the shot holes. The coaches enter the scores on the score cards.

(f) A platform permitting the scorer to score the target should be provided for each type of target.

(g) To stimulate interest, the instruction can be concluded with a competition between individuals, squads, or training groups.

(h) If available, targets shown in figure 50 may be used on nonoverhead targets for group firing or competitions. One lead should be used in firing on this target.

(i) Close supervision is required in order to maintain target operation at the proper speed. Correct operation is required because the lead is based upon a speed of 15 feet per second.

(j) Safety precautions must be constantly observed.

(2) *Caliber .30, M1917 rifle.*—If the size of the danger area permits, the caliber .30 rifle may be fired on the miniature range. With the following exceptions, such firing may be conducted in the same manner as that prescribed for the caliber .22 rifle.

(a) Sight over the top of the battle sight and front sight. In sighting over the top of the battle sight and front sight, the line of aim is lower than the trajectory of the bullet.

Therefore, it will be necessary to aim low in order to hit the silhouette.

(b) The lead necessary to hit the black silhouette is approximately 2.5 inches. This is caused by the difference in the time of flight of the caliber .30 and caliber .22 bullets for 500 inches. The time of flight of the caliber .30 bullet for 500 inches is 0.015 of a second. When the target is operated at the speed of 15 feet per second, the silhouette will move approximately 2.5 inches during the time of flight of the bullet.

(c) Preparatory exercises using the caliber .30 rifle should precede firing that weapon. These exercises are conducted in accordance with the procedure explained for the caliber .22 rifle.

(d) The interval between individuals on the firing line should be increased. This may be accomplished by placing only one-half the group on the firing line at one time.

b. When using the kneeling position, men must be constantly cautioned to keep the weight of the body forward and to continue, without hesitation, the tracking of the target after the rifle has fired.

■ 159. TOWED-TARGET (SLEEVE OR FLAG) AND RADIO-CONTROLLED AIRPLANE-TARGET FIRING.—*a. Range organization.*—

(1) Firing at a towed-sleeve (flag) target or a radio-controlled airplane target by an individual is impracticable and uneconomical. All firing is done by a unit of such size that its fire can be readily controlled and directed. The platoon is the most convenient unit for such firing.

(2) An *ammunition line* should be established 5 yards in rear of the firing line. One small table for each ten men in a firing group is desirable.

(3) Immediately in rear of the ammunition line the *ready line* should be established.

(4) The first platoon or similar group to fire is formed along the ready line with each individual in rear of his place on the firing line. In the same manner, other platoons or similar groups are disposed in a series of lines in rear of the first unit to fire.

(5) Upon command of the officer in charge of firing, the group on the ready line moves forward to the firing line, securing ammunition en route; other groups close up.

(6) Upon completion of firing by one group, it moves off the firing line, passing around the flanks of the ready line so as not to interfere with the group moving forward.

(7) An ammunition detail sufficient to issue ammunition to groups as they move forward to the firing line and collect unfired ammunition from the group which just completed firing should be provided. These two operations should be performed simultaneously. Unfired ammunition is delivered to the statistical officer.

(8) The officer in charge should have at least three assistants—two safety officers and one statistical officer.

*b. Ammunition.*—(1) Live ammunition may be used. Tracer ammunition is useful to show the groups waiting to fire the size and density of the cone of fire delivered by the firing group.

(2) Tracer ammunition will assist the officer in charge of firing in verifying the lead announced in the fire order. It also provides a means of checking the rifleman's estimate of the lead ordered.

*c. Technique of fire.*—(1) *Leads.*—(a) The lead used in the technique of fire described in paragraph 76 is the average of two theoretical extremes. For example: If the maximum slant range to a passing airplane is 600 yards and the minimum slant range is 300 yards, the lead used would be that required for a slant range of 450 yards. Fire is delivered with one fixed lead in order to simplify the procedure. Such a technique is readily taught, and it is effective.

(b) The lead table given below may be helpful. It is based upon a 15-foot sleeve towed at 140 miles an hour and armor-piercing, caliber .30, M2 ammunition. Since the average speed of the radio-controlled airplane target is 95 miles an hour, and its length is approximately 10 feet, the leads listed below are equally applicable to this target.

Slant range	Lead required
100-----	2
200-----	3
300-----	5
400-----	7
500-----	10
600-----	12

The average of these is between six and seven leads. To hit a flag target 40 feet long being towed at a speed of 165 miles an hour requires an average of three leads.

(2) *Methods.*—(a) *Normal.*—The normal method of fire distribution is given in chapter 4. This method will be taught in towed-target range practice. If time and ammunition allowances permit, other methods may also be taught.

(b) *Variable lead.*—Using this method, the individual rifleman fires each shot with a different lead. The maximum lead is used as the target enters and leaves the firing area. The minimum lead is used when the target is directly opposite the firing line. Example: If three rounds are to be fired as the target passes across the front of the firing line, the first round is fired shortly after the target enters the firing area; the second round is fired when the target is near the center of the firing area; the third shot is fired shortly before the target leaves the firing area. The fire order given by the officer in charge is: 1. TARGET FROM THE LEFT (RIGHT); 2. THREE ROUNDS, LOAD; 3. TEN—FIVE—TEN LEADS; 4. COMMENCE FIRING. In this example it is expected that the three shots will be fired at slant ranges of approximately 500 yards, 300 yards, and 500 yards, respectively.

(c) *Combined lead.*—Using this method, all men of each squad fire each shot with the same lead but each squad uses a different lead. Example: The first squad uses four leads, the second squad uses six leads, and the third squad uses eight leads. The leads used by each squad must be designated in advance. The fire order given by the officer in charge of firing is: 1. TARGET APPROACHING FROM THE LEFT (RIGHT); 2. THREE ROUNDS, LOAD; 3. COMBINED LEADS; 4. COMMENCE FIRING.

(d) *Effectiveness.*—The variable lead method and the combined lead method have given good results but are more difficult to apply than the normal method. Simple methods are best for combat.

(e) *Precautions.*—Safety precautions as given in paragraphs 168 and 169 must be rigidly enforced. This requires constant supervision by the officer in charge.

(f) *Record.*—The results of all firing should be recorded and analyzed. The statistical officer should record the total number of rounds fired and the hits obtained on each target. If the number of hits falls below the number expected, the reason should be sought and explained to the men. On the other hand, when results are satisfactory, the men should be impressed with the value of rifle anti-aircraft fire.

## SECTION V

### TECHNIQUE OF FIRE

■ 160. **GENERAL.**—The instructor should obtain necessary equipment, inspect ranges, and detail and train necessary assistants, including demonstration units, prior to the first period of instruction. Instructors should use their initiative in arranging additional exercises in the application of the principles herein contained. It should be explained to trainees how the exercises illustrate the principles in the technique of fire. Good work in the conduct of the exercises as well as errors should be called to the attention of all trainees.

■ 161. **RANGE ESTIMATION.**—*a.* A number of ranges to prominent points on the terrain should be measured so that a few minutes of each period can be devoted to range estimation.

*b.* Range cards as shown below will be of assistance in figuring percentage of errors.

## RANGE ESTIMATION

Name.....

Company.....

Squad.....

Number	Estimate	Correct	Per cent	Remarks	Number	Estimate	Correct	Per cent	Remarks
1					21				
2					22				
3					23				
4					24				
5					25				
6					26				
7					27				
8					28				
9					29				
10					30				
11					31				
12					32				
13					33				
14					34				
15					35				
16					36				
17					37				
18					38				
19					39				
20					40				

(Front)

TABLE FOR COMPUTING ERRORS IN RANGE ESTIMATION

Range, in yards	Error, in yards										
	5	10	15	20	25	30	35	40	45	50	100
250.....	2	4	6	8	10	12	14	16	18	20	40
275.....	2	4	5	8	9	11	13	15	16	18	36
300.....	2	3	5	7	8	10	12	13	15	17	33
330.....	2	3	5	6	8	9	11	12	14	15	30
350.....	1	3	4	6	7	9	10	11	13	14	29
380.....	1	3	4	5	7	8	9	11	12	13	26
400.....	1	3	4	5	6	8	9	10	11	13	25
420.....	1	2	4	5	6	7	8	10	11	12	24
440.....	1	2	3	4	6	7	8	9	10	11	23
460.....	1	2	3	4	5	7	8	9	10	11	22
480.....	1	2	3	4	5	6	7	8	9	10	21
500.....	1	2	3	4	5	6	7	8	9	10	20
520.....	1	2	3	4	5	6	7	8	9	10	19
540.....	1	2	3	4	5	6	7	8	9	10	19
560.....	1	2	3	4	4	5	6	7	8	9	18
580.....	1	2	3	3	4	5	6	7	8	9	17
600.....	1	2	3	3	4	5	6	7	8	8	17
620.....	1	2	2	3	4	5	5	6	7	8	16
640.....	1	2	2	3	4	5	5	6	7	8	16
660.....	1	2	2	3	4	5	5	6	7	8	15
680.....	1	1	2	3	4	4	5	6	7	8	15
700.....	1	1	2	3	3	4	5	6	6	7	14
720.....	1	1	2	3	3	4	5	6	6	7	14
740.....	1	1	2	3	3	4	5	6	6	7	14
760.....	0	1	2	3	3	4	5	5	6	7	13
780.....	0	1	2	3	3	4	4	5	6	6	13
800.....	0	1	2	3	3	4	4	5	6	6	13
850.....	0	1	2	2	3	3	4	5	5	6	12
900.....	0	1	2	2	3	3	4	4	5	6	11
950.....	0	1	2	2	3	3	4	4	5	5	10
1,000.....	0	1	2	2	3	3	4	4	5	5	11

NOTE.—Example of the use of this table: Suppose the correct range to be 695 yards and the estimated range to be 635. The "error in estimate" is consequently 60 yards. Select two "errors in estimate" in the 700-yard space (the nearest to the correct range given in the table) of which the sum is 60 yards, as 50 and 10. Add the percentages shown thereunder, and the result will be approximately your error. In this case

$$7+1=8 \text{ percent}$$

(Back)



■ 162. TARGET DESIGNATION.—*a.* The major portion of the time devoted to target designation should be spent on oral description. Simple designations should be required at first. This instruction should not be confined to the landscape panels.

*b.* An explanation should be made to the trainees as to why an angle of 50 mils will be subtended by 1 foot at 20 feet.

■ 163. RIFLE FIRE AND ITS EFFECT.—This step of instruction can best be covered by the use of a blackboard and several riflemen firing tracer bullets to demonstrate the trajectory, danger space, dispersion, classes of fire, and related matters.

■ 164. APPLICATION OF FIRE.—*a.* Sufficient time and explanation should be devoted to the method of fire distribution to insure that all men fully understand it and can explain it in their own words.

*b.* A demonstration squad firing tracer ammunition is a satisfactory method of showing the technique employed in assault fire.

■ 165. LANDSCAPE-TARGET FIRING.—*a.* An explanation and demonstration will be necessary to show the technique and procedure of zeroing rifles and the firing of exercises on the landscape targets.

*b.* Units should be given practical work in writing fire orders for targets on the landscape panels prior to firing any exercises.

■ 166. FIELD-TARGET FIRING.—*a.* The most difficult factor in the preparation of problems for field firing is the selection of the terrain which complies with the safety regulations contained in AR 750-10. A drawing should be made on a map showing all safety angles, target positions, and other important details.

*b.* The appearance of the ordinary prone or kneeling silhouette depends a great deal upon the direction of the sun, the background of the targets, and the angle at which the targets are placed. The effect of solidity can be obtained by using two figures placed at right angles to each other.

c. Maximum use should be made of the available terrain to permit the firing of as many squads from one firing position at one time as is possible. This firing should be controlled from a central position. Telephone communication between the firing point and the pits will facilitate this instruction. During this type of training, individuals and units should approach and occupy their firing positions with due regard to cover and concealment, after which men are rearranged on the firing position according to the requirements of safety.

d. When sufficient time and ammunition are available, platoon exercises should be conducted.

■ 167. TRANSITION FIRING.—*a. General.*—This phase of training gives the individual rifleman practice in searching for targets, in estimating ranges, in setting his sights for each range, and in firing an accurate shot quickly. It emphasizes the necessity for the continued application of the principles of rifle marksmanship in firing at field targets, and prepares him for combat-firing exercises which follow later in his training.

*b. Use of ranges.*—(1) Ranges will vary greatly due to local conditions of space and terrain. There is no prescribed or exact arrangement of the lanes which constitute the range for transition firing. Each range will require an organization for use adapted to its particular lay-out.

(2) A suggested arrangement provides five lanes, as shown in figure 106: three lanes for firing the exercises in table VI, and two lanes for firing the exercise in table VII (par. 48*d*). If the above arrangement is impracticable, one or more lanes may be constructed, in each of which all exercises of tables VI and VII are fired. This may be accomplished by combining the set-up in lanes 1, 2, and 3 and adding the extra pits as indicated by the broken lines in figure 106.

(3) For the protection of the pit detail, individual open pits of the fox hole type (fig. 107) should be used. However, for lanes 1, 2, and 3, trenches 18 feet long may be used.

(4) To control the raising and lowering of targets, communication between the firing points and pits is necessary. For lanes 1, 2, and 3, a telephone connection or radio is

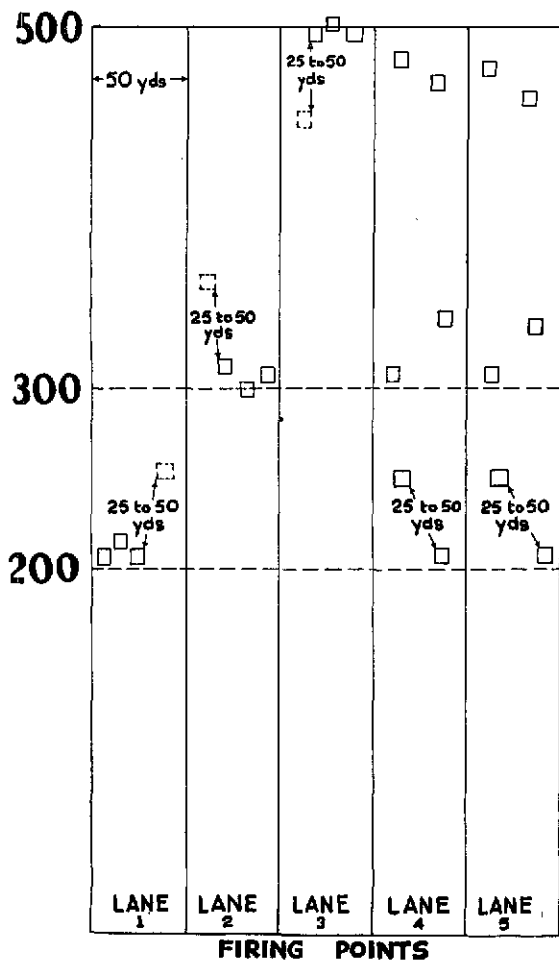

FIGURE 106.—Suggested lay-out for transition firing.

necessary for the center pit only. Targets operated from the pits in lanes 1 and 3 can be controlled from the center pit either orally or by attaching pieces of twine or wire to the arms of the operators in lanes 1 and 3, and extending them to the operator in the center pit. The wires are pulled when

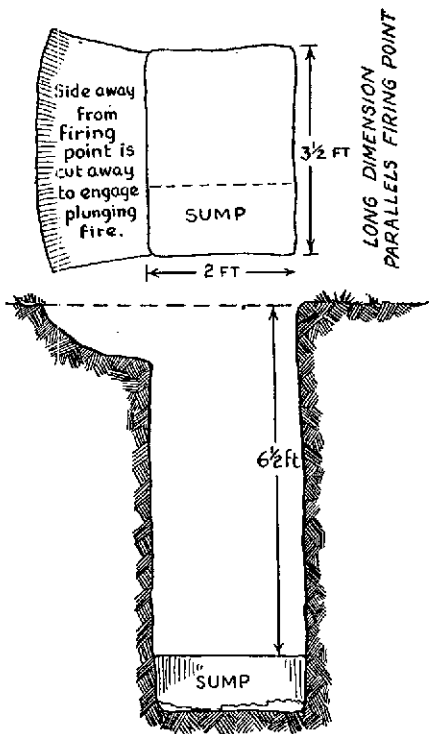

FIGURE 107.—Construction of open pit.

the targets are to be raised or lowered. If the trench is used instead of individual pits, the control of targets is simplified. Three telephones or radios each will normally be required for lanes 4 and 5, one for each set of two pits. However, by judicious location of the pits, this number may be reduced to two.

*c. Personnel.*—Two officers should be used to control the firing at the firing points—one at the three firing points for the exercises of table VI, and one at the two firing points used in firing the exercises of table VII. One coach for each firing point, necessary pit details, and telephone orderlies or radio operators are required.

*d. Procedure.*—(1) See paragraph 48*d*. After the command *LOAD*, the officer in charge of firing gives the signal for raising the targets. The three lanes for table VI may be operated together, and the two lanes for table VII may be operated together. If this is not possible, lanes are operated independently of each other. When the signal is given, all targets are raised. Unless hit, they remain up until the signal to withdraw them is given.

(2) Riflemen should fire the exercises in table VI first and then progress to the exercise in table VII. It is not necessary that the exercises in table VI be fired in the order listed. In table VII the rifleman may select any one of the three groups of two targets to fire on first. However, it is suggested that the course be fired by having the men start in lane 1 and progress through lanes 2 and 3 to either lane 4 or lane 5. This method permits the use of two men on the firing point in lane 1. One man fires while the other man goes through a dry run. Another arrangement would be to have three men fire the exercises in lanes 1, 2, and 3 simultaneously, change places progressively until they have fired in all three lanes, and then move to lane 4 or lane 5 where they fire the exercise in table VII.

*e.* When all targets are hit, or when the time limit has expired, the coach records the score of the rifleman. Since a hit is indicated by the lowering of the target, no extra credit is given for more than one hit on a target. However, if two targets are hit by one bullet, both targets are scored.

## SECTION VI

### SAFETY PRECAUTIONS

■ 168. *INDIVIDUAL RESPONSIBILITY.*—The soldier must be impressed with the fact that the rifle is safe only when it is

cleared (par 18g). In other words, the rifle is never *known* to be *safe* when the bolt is closed.

■ 169. SAFETY PRECAUTIONS.—*a. General.*—Range officers, the officer in charge of firing, and the commander responsible for the location of ranges and the conduct of firing thereon must have a thorough knowledge of AR 750-10. Before firing is commenced, all officers and men who are to fire or who are concerned with range practice will be familiarized with the safety precautions listed in *b* below.

*b. Known-distance ranges.*—The following safety precautions are specifically applicable while firing on the known-distance range:

(1) Danger flags will be displayed at prominent positions on the range during firing. Do not fire unless such flags are displayed.

(2) Upon arrival at the range, the rifles of an organization will be inspected by the officers to see that chambers and barrels are free from obstruction and that all bolts are opened.

(3) Consider every rifle to be loaded until it is examined and found to be unloaded. Never trust to memory.

(4) Firing will not begin on any range until the officer in charge of firing has ascertained that the range is clear and has given the commands LOAD and COMMENCE FIRING.

(5) At least one officer will be present at all firing.

(6) Rifles will be pointed down range at all times while riflemen are on the firing line.

(7) Rifles not in use will be neatly arranged on rifle rests, bolts open, bolt handle up. Frequent inspections will be made to insure that all bolts are open.

(8) No rifle will be removed from the firing line until an officer or specially selected noncommissioned officer has inspected it to see that it is clear and that the bolt is open.

(9) All firing will immediately cease and the safety of each rifle will be set in its safe position (or the rifles will be cleared, if ordered) at the command or signal CEASE FIRING. Riflemen should remain in position until all rifles are cleared.

(10) In no circumstance should the striker be let down by hand on a cartridge in the chamber.

(11) Cartridges will not be left chambered in hot barrels.

(12) Care should be taken to avoid undue exposure of ammunition to the direct rays of the sun. This creates hazardous chamber pressures.

(13) Never grease or oil the ammunition or the walls of the rifle chamber.

(14) See that the ammunition is clean and dry. Examine all live and all dummy cartridges. Turn in all live or dummy cartridges with loose bullets and any rounds which appear to be defective.

(15) Never fire a rifle until it has been inspected to see that there is no rust-preventive compound, cleaning patch, dust, dirt, mud, snow, or other obstruction in the bore or chamber. Firing the rifle with any obstruction in the bore may burst the barrel.

(16) Before leaving the range, all rifles and belts will be inspected by an officer to see that they do not contain ammunition, and men in ranks will be questioned as to whether they have any ammunition in their possession.

*c. Moving-target ranges.*—The following safety precautions are specifically applicable while firing on the moving target range.

(1) Firing at moving targets will not be permitted on any range until the safety angles have been carefully checked and markers have been placed to define clearly the right and left limits of fire.

(2) Personnel of trucks towing moving targets will operate at such distance from the line of fire as to be protected from direct hits and ricochets.

(3) Trucks used when replacing targets on the course or personnel effecting repairs will be equipped with red flags.

(4) Target personnel will not leave the designated safety area until the signal or command to do so has been given.

(5) The officer in charge of firing will be responsible that—

(a) Rifles are not pointed in such a direction that the target detail will be endangered.

(b) Rifles are not pointed in such a direction that the fire will extend outside the prescribed limits outlined on the range.

(c) Firing ceases immediately upon the command **CEASE FIRING.**

(d) Rifles are clear and bolts are open before the target detail is permitted to move onto the range.

(e) The range is clear before giving the command **LOAD**.

*d. Antiaircraft ranges.*—The following safety precautions are specifically applicable while firing on antiaircraft ranges.

(1) The safety precautions given in *b* above are applicable to this type of firing and will be observed.

(2) If riflemen are permitted to go forward to inspect their targets, rifles will be left on the firing line with the bolts open.

(3) If the caliber .22 rifle is used, the bolt will not be closed forcibly if difficulty in feeding is experienced. Attempting to close the bolt forcibly may result in igniting the rim-fire cartridge before it is seated in the chamber.

(4) Towed-target firing will be conducted with due regard for the safety of the pilot of the towing airplane, the personnel engaged in the firing, and all spectators.

(5) All firing must be controlled by suitable signals or commands. The commands **COMMENCE FIRING** and **CEASE FIRING** must be given in such a manner as to be understood clearly and promptly by everyone engaged in firing.

(6) The signals and commands **COMMENCE FIRING** and **CEASE FIRING** will be given at such time during the course of the flight of the target as to prevent any bullets from falling outside the danger area.

(7) In firing at towed targets on overhead flights, the signal or command **COMMENCE FIRING** will not be given until the towing plane has reached a point 50 yards or less (measured horizontally on the ground) from the firing line and until there is no danger that bullets will strike the airplane. The signal or command **CEASE FIRING** will be given before the sleeve target is 100 yards (measured horizontally on the ground) in advance of the firing line in order that there will be no danger that bullets will drop outside the firing area.

(8) All personnel will be warned that in case a towing cable breaks and the towing airplane is on a course which passes near the firing point, they must lie flat on the ground until danger from the loose cable and the release is passed.



(9) In firing at towed targets, no rifle will be pointed at or near the towing airplane. All tracking will be on the towed target. Muzzles will be depressed during leading.

(10) At least two safety officers will be designated to assist the officer in charge of firing in carrying out safety precautions.

(11) Firing at towed targets will be permitted only when the angle target-gun-airplane exceeds 300 mils or 17° (AR 750-10).

(12) For the purpose of giving supplemental instruction and checking the safety measures taken, an Army Air Forces officer should be at the firing point during an organization's initial practice for the season in towed-target firing.

*e. Combat ranges.*—The following safety precautions are specifically applicable while firing on the combat range.

(1) No provision in this manual will be interpreted to prohibit overhead or flanking fire or forward movement in combat problems and exercises. Exercises should be drawn to conform to the state of training of the units concerned.

(2) The officer in charge of an exercise is responsible for the safety of the firing. It is his duty to initiate and enforce such precautions as he deems necessary under existing conditions. No other officer can modify his instructions without assuming responsibility for the safety of the firing.

(3) Firing will not start until it has been ascertained that the range is clear and that the pit details are not exposed.

(4) Upon completion of the day's firing, rifles and belts should be inspected by an officer to insure that no ammunition remains in the possession of the men returning to camp or barracks.

## INDEX

	Paragraph	Page
Accessories .....	21	27
Advice to instructors.....	136-169	269
Aerial targets. (See Marksmanship: Antiaircraft Marksmanship)		
Aiming.....	41, 146, 149	48, 278, 284
Aiming device.....	21	27
Aiming and leading exercises.....	79, 81	167, 175
Ammunition.....	23-29, 47, 55, 135, 142	37, 117, 140, 267, 272
Ballistic data.....	28	41
Blank.....	29	41
Care, handling, and preservation.....	27	40
Classification.....	24	34
Dummy.....	18, 53	21, 127
Grade.....	26	40
Lot number.....	25	38
Antiaircraft marksmanship. (See Marksmanship: Antiaircraft marksmanship)		
Appendages.....	20	25
Application of fire.....	115, 122, 164	226, 237, 301
Assault fire.....	117	233
Assembly of rifle.....	7	7
Assistant instructors.....	139	270
Attack.....	115	226
Automatic rifle team.....	115	226
Ballistic data.....	28	41
Battle sight.....	133	260
Bayonet.....	20, 53	25, 127
Beaten zone.....	111	222
Binocular.....	22	33
Blackening sights.....	40	48
Blank ammunition.....	26, 29	40, 41
Bolt-manipulation exercise.....	44	89
Breathing.....	42	61
Bullets. (See Ammunition.)		
Cadence.....	44	89
Care and cleaning of rifle.....	8-17, 55	11, 140
After firing.....	12	15
Before storage.....	14	17
In extreme climates.....	17	19
On range or in combat.....	13	16
Preparatory to firing.....	11	14
When no firing is done.....	10	13
When received from storage.....	15	18
When subject to gas attack.....	16	18
Cartridge. (See Ammunition.)		
Cartridge extractor.....	21	27
Classes of fire.....	112	222

INDEX

	Paragraph	Page
Cleaning rifle.....	8-17, 55	11, 140
Clear rifle.....	18	21
Clip.....	2	1
Coaching.....	42-44, 53, 55, 79, 81, 82	61, 127, 140, 167, 175, 179
Collective fire.....	96	202
Combat proficiency tests.....	134	262
Combat range.....	132	250
Combat training exercises.....	134	262
Commanders, duties.....	87	44
Concealment.....	134	262
Course:		
Qualification.....	47-51	117
Radio-controlled-airplane target.....	87	187
Small-bore.....	62	150
Towed-target.....	87	187
Cover.....	133	260
Defense.....	115	226
Demonstrations.....	145	278
Destruction of ordnance matériel.....	135	267
Dispersion.....	109	220
Disassembly and assembly of rifle.....	5-7	4
Dry cleaning solvent.....	9	11
Dummy cartridges.....	18, 53	21, 127
Elevation (sight).....	45	100
Equipment.....	38, 56, 57, 140, 146-152, 154	45, 144, 149, 278, 289, 290
Estimation, range.....	99-103, 161	203, 298
Examination of men before range practice.....	46, 146, 153	111, 278 290
Field firing, aerial targets.....	92	198
Field-target firing.....	131-134, 166	250, 301
Exercises.....	134	264
Ranges.....	132	250
Targets.....	132	250
Finger (designation of target).....	107	218
Fire (see also Technique of fire):		
Application.....	115-122, 164	226, 301
Assault.....	117	233
Classes.....	112	222
Collective.....	96	202
Concentrated.....	116, 130	232, 248
Control.....	120, 121, 130, 134	234, 235, 248, 262
Delivery.....	77	165
Discipline.....	119	233
Distribution.....	76, 116, 121, 130	163, 232, 235, 248
Effect of rifle.....	108-114, 163	220, 301
Grazing.....	112	222
Observation of.....	102	204
Orders.....	121, 134	235, 262

INDEX

Fire (see also Technique of fire)—Continued.	Paragraph	Page
Rate.....	77, 118	165, 233
Slow.....	44, 48-51, 53, 54, 62	89, 118 127, 134, 150
Surprise.....	121, 130	235, 248
Sustained.....	44, 48-51, 53, 54, 62	89, 118, 127, 134, 150
Unit.....	96	202
Firing:		
Aerial targets.....	92	198
Field target.....	131-134, 166	250, 301
Group (antiaircraft).....	85	185
Instruction.....	84	182
Known distance. (See Marksmanship.)		
Landscape-target.....	123-130, 165	238, 301
Line.....	54	134
1,000-inch range.....	54	134
Positions.....	115, 133, 134	226, 260, 262
Radio-controlled-airplane-target.....	86-89, 159	186, 295
Towed-target.....	86-89, 159	186, 295
Transition.....	48-51, 167	118, 302
Flinching.....	53	127
Functioning of rifle.....	18	21
Fundamentals of good shooting.....	32	42
Grade of ammunition.....	26	40
Grazing fire.....	112	222
Grenade launcher.....	20, 53	25, 127
Group firing (antiaircraft).....	85	185
Hold-off.....	68	156
Holding breath.....	42	61
Inspection of rifles.....	141	271
Instruction.....	136-169	269
Firing.....	53, 84	127, 182
Marksmanship, antiaircraft (See Marksmanship.)		
Marksmanship, known-distance targets. (See Marksmanship.)		
Mechanical training.....	1-29, 137	1, 269
Organization for.....	3	3
Practice.....	53	127
Range.....	154	290
Instruments.....	22	33
Known-distance firing. (See Marksmanship.)		
Known-distance range.....	30-58	42
Known-distance targets.....	57, 138-154	149, 270
Landscape-target firing.....	123-130, 165	238, 301
Description of target.....	124	238
Exercises.....	130	248
Firing procedure.....	128	247
Preparation of targets.....	126	238
Scope and importance.....	123	238

## INDEX

	Paragraph	Page
<b>Landscape-target firing—Continued.</b>		
Scoring.....	126, 129	238, 248
Weapons to be used.....	125	238
Leads.....	64, 65, 68, 74, 81	154, 155, 156, 162, 175
Leaders.....	37, 122	44, 237
Lectures.....	145	278
Loading.....	18, 55	21, 140
Lot number of ammunition.....	26	38
Lubricants.....	9	11
Machine rest.....	149	284
Marking targets.....	54	134
<b>Marksmanship:</b>		
<b>Antiaircraft marksmanship.....</b>	<b>71-95, 155-159</b>	<b>161, 292</b>
Aerial targets.....	71, 72, 155-159	161, 292
Classification.....	72	161
Instructions to pilots for towing mis- sions.....	94	200
Signals.....	95	200
Suitable for rifle fire.....	71	161
Aiming and leading exercises.....	79, 81	167, 175
Miniature range practice.....	83-85, 158	182, 294
Position exercises.....	80	173
Preparatory exercises.....	79	167
Radio-controlled-airplane-target firing.....	86	186
Scoring.....	89	191
Technique of fire.....	73-77	161
Delivery of fire.....	77	165
Fire distribution.....	76	163
Leads.....	74	162
Target designation.....	75	163
Towed-target (sleeve or flag) firing.....	86-89, 159	186, 295
Trigger-squeeze exercise.....	79	167
<b>Known-distance firing.....</b>	<b>30-62, 138-154</b>	<b>42, 270</b>
Ammunition.....	142	272
Assistant instructors.....	139	270
Equipment.....	140	271
First half-day to eighth half-day.....	146-153	278
Lectures and demonstrations.....	145	278
Organization of work.....	143	272
Range instruction.....	154	290
Rifle inspection.....	141	271
Schedules.....	144	276
<b>Moving ground targets.....</b>	<b>63-70</b>	<b>154</b>
Fundamentals of engaging.....	64	154
Leads, use of.....	64, 65	154, 155
Personnel.....	68, 69	156, 158
Vehicles.....	65-67	155
<b>Preparatory marksmanship.....</b>	<b>38-46, 56, 138-154, 157</b>	<b>45, 144, 270, 293</b>
First step: Sighting and aiming.....	41	48
Second step: Positions.....	42	61
Third step: Trigger squeeze.....	43	84
Fourth step: Sustained fire.....	44	89

## INDEX

	Paragraph	Page
Marksmanship—Continued.		
Preparatory marksmanship—Continued.		
Fifth step: Effect of wind, sight changes, use of score book.....	45	102
Sixth step: Examination of men before starting range practice.....	46	111
Training.....	143	272
Fundamentals.....	32	42
Individual.....	36	44
Necessity for.....	31	42
Phases.....	33	43
Practice.....	35	43
Transition firing.....	48-51, 167	118, 302
Matériel.....	135	267
Mechanical training.....	1-29, 137	1, 269
Miniature range.....	83-85, 91, 156, 158	182, 192, 292, 294
Group firing.....	85	185
Instruction firing.....	84	182
Range officer.....	90	192
Score card.....	91	192
Misfires.....	29, 55	41, 140
Model sight picture device.....	41	48
Moving ground targets. (See Marksmanship.)		
Moving-target range.....	70	158
Nomenclature.....	5	4
Observation of fire.....	102	204
1,000-inch range.....	47, 54	117, 134
Operation of rifle.....	18	21
Pit.....	52, 54, 56	125, 134, 144
Positions.....	42, 44, 80, 133, 134, 148	61, 89, 173, 260, 262, 282
Positions, firing.....	115	226
Practice:		
Continuous.....	35	43
Instruction.....	53	127
Range.....	46, 52-55, 83-85, 158	111, 125, 182, 294
Record.....	54, 55	134, 140
Seasons.....	34	43
Small-bore.....	59-62	150
Preparatory marksmanship training. (See Marks- manship.)		
Progress chart.....	39, 146	45, 278
Qualification courses.....	47-51, 62	117, 150
Radio-controlled-airplane-target firing.....	86-89, 159	186, 295
Courses to be fired.....	87	187
Procedure of firing.....	88	188
Scoring.....	89	191
Range.....	52-54, 58, 90, 91, 154	125, 150, 192, 290
Antiaircraft. (See Marksmanship: Antiaircraft marksmanship.)		
Equipment.....	56	144

INDEX

Range—Continued.	Paragraph	Page
Estimation .....	99-103, 161	203, 298
By observation of fire .....	102	204
By eye .....	103	204
By use of tracer bullets .....	101	204
Importance of .....	99	203
Field-target firing .....	132	250
Instruction .....	154	290
Known-distance .....	30-58	42
Miniature. (See Miniature range.)		
Moving-target .....	70	158
Officer .....	52, 90	125, 192
1,000-inch .....	47, 54	117, 134
Practice .....	46, 52-55, 83-85, 143, 144	111, 125, 182, 272, 276
Precautions. (See Safety precautions.)		
Rate of fire .....	118	233
Rear sight .....	2	1
Record practice .....	54, 55	134, 140
Reference point .....	106	209
Rifle:		
Bore cleaner .....	9	11
Clear .....	18	21
Description .....	2	1
Fire:		
Effect .....	103-114, 163	220, 301
Importance .....	97	202
Inspection .....	141	271
Loading .....	18, 55	21, 140
Safe, to set at .....	18	21
Squad .....	96-134	202
Unloading .....	18	21
Zeroing. (See Zeroing.)		
Ruptured cartridge extractor .....	21	27
Rust preventives .....	9	11
Safety (lock) of the rifle .....	18	21
Safety precautions .....	29, 58, 168, 169	41, 150, 305, 306
Score:		
Book .....	45	100
Card .....	54, 91	134, 192
Qualification .....	47-51	117
Scoring .....	48-51, 54, 89, 126, 129, 167	118, 134, 191, 238, 248, 302
Shot group .....	110	220
Shooting, fundamentals of good .....	32	42
Sights .....	2, 40, 45, 133	1, 48, 100, 260
Sighting and aiming .....	41, 146	48, 278
Sighting bar .....	56, 140	144, 271
Sighting device .....	53, 140	127, 271
Sighting disks .....	56	144
Signals, aerial-target firing .....	95	201
Sling .....	21, 42, 55	27, 61, 140

INDEX

	Paragraph	Page
Slow fire.....	44, 48-51, 53, 54, 62	89, 118, 127, 134, 150
Small-bore practice.....	59-62	150
Spare parts.....	19	24
Squad, rifle.....	96-134	202
Surprise fire.....	121, 130	235, 248
Sustained fire.....	48-51 53, 54, 62	118, 127, 134, 150
<b>Targets</b> .....	57, 132	149, 250
Aerial.....	71, 72, 79, 93, 155-159	161, 167, 200, 292
Designation.....	75, 104-107, 121, 130, 134, 162	163, 208, 235, 248, 264, 301
Field-target firing.....	126, 131-134, 166	238, 250, 301
Known-distance.....	56, 138-154	144, 270
Landscape.....	123-130, 165	238, 301
Marking.....	54	134
Moving personnel.....	68, 69	156, 158
Moving vehicles.....	65-67	155
Radio-controlled-airplane targets.....	86, 89, 159	186, 291, 295
Scoring. (See Scoring.)		
Towed.....	86-89, 159	186, 295
<b>Technique of fire</b> .....	160-167	298
Aerial targets.....	73-77	161
Definitions.....	96	202
Moving personnel.....	68	156
Moving vehicles.....	66	156
<b>Telephone</b> .....	54	134
<b>Terrain</b> .....	132	250
<b>Topographical terms</b> .....	105	209
<b>Towed-target firing</b> .....	86-89, 94, 159	186, 200, 295
Courses to be fired.....	87	187
Procedure of firing.....	88	188
Scoring.....	89	191
<b>Tracer bullets</b> .....	106	209
<b>Trajectory</b> .....	108, 114	220, 226
<b>Transition firing.</b> (See Marksmanship.)		
<b>Trigger pull</b> .....	2, 55	1, 140
<b>Trigger squeeze</b> .....	43, 82	84, 179
<b>Unit of measure</b> .....	103	204
<b>Unloading the rifle</b> .....	18	21
<b>Wind (windage)</b> .....	45	100
<b>Zeroing rifle</b> .....	45, 53, 127	100, 127, 243

