

MHI  
Copy 3

*cc*

**FM 21-10**

**WAR DEPARTMENT**

**BASIC FIELD MANUAL**

*\**

**MILITARY SANITATION  
AND FIRST AID**

*31 July 1940*

FM 21-10

**BASIC FIELD MANUAL**



**MILITARY SANITATION AND  
FIRST AID**

---

**Prepared under the direction of  
The Surgeon General**



**UNITED STATES  
GOVERNMENT PRINTING OFFICE  
WASHINGTON : 1940**

---

**For sale by the Superintendent of Documents, Washington, D. C. - Price 25 cents**

WAR DEPARTMENT,  
WASHINGTON, *July 31, 1940.*

FM 21-10, Basic Field Manual, Military Sanitation and First Aid, is published for the information and guidance of all concerned.

[A. G. 062.11 (8-6-40).]

BY ORDER OF THE SECRETARY OF WAR:

G. C. MARSHALL,  
*Chief of Staff.*

OFFICIAL:

E. S. ADAMS,  
*Major General,*  
*The Adjutant General.*

## TABLE OF CONTENTS

	Paragraphs	Page
<b>CHAPTER 1. GENERAL.</b>		
Section I. General.....	1-4	1
II. Responsibility for sanitation....	5-6	2
<b>CHAPTER 2. COMMUNICABLE DISEASES.</b>		
Section I. Nature and principles of transmission.....	7-8	5
II. Control of communicable diseases.....	9	9
<b>CHAPTER 3. RESPIRATORY DISEASES.</b>		
Section I. General.....	10	13
II. Control measures.....	11-13	13
<b>CHAPTER 4. INTESTINAL DISEASES.</b>		
Section I. General.....	14	21
II. Control of intestinal diseases....	15	21
III. Field water supplies.....	16-20	22
IV. Disposal of wastes.....	21-33	27
V. Fly control.....	34-35	53
VI. Mess sanitation.....	36-44	64
<b>CHAPTER 5. INSECT-BORNE DISEASES.</b>		
Section I. General.....	45-48	76
II. Mosquito control.....	49-53	78
III. Control of lice.....	54-67	91
IV. Control of ticks.....	68-70	103
V. Control of bedbugs.....	71-73	105
VI. Control of roaches and ants.....	74-75	107
VII. Control of fleas.....	76-77	107
<b>CHAPTER 6. VENEREAL DISEASES.....</b>	78-80	110
<b>CHAPTER 7. MISCELLANEOUS DISEASES.</b>		
Section I. Lockjaw (tetanus).....	81-82	115
II. Gas gangrene.....	83-84	116
III. Rabies.....	85-86	116
IV. Scabies.....	87-88	117
V. Ringworm "dhobie itch" (trichophytosis).....	89-91	119
VI. Poison ivy, poison oak, poison sumac (plant dermatitis).....	92-93	123
<b>CHAPTER 8. MARCH HYGIENE AND SELECTION OF CAMP SITES.</b>		
Section I. March hygiene.....	94-99	126
II. Selection and sanitation of camp sites.....	100-103	132
<b>CHAPTER 9. PERSONAL HYGIENE.</b>		
Section I. General.....	104-106	136
II. Measures to protect and improve health.....	107-111	137

## TABLE OF CONTENTS

	Paragraphs	Page
CHAPTER 10. FIRST AID.		
Section I. General .....	112-113	144
II. Treatment of wounds .....	114-116	145
III. Shock .....	117	154
IV. Fractures, dislocations, and sprains .....	118-119	155
V. Artificial respiration .....	120-122	162
VI. Gas casualties .....	123-124	165
VII. Injuries due to heat and cold .....	125-127	169
VIII. Poisonous bites and stings .....	128-130	172
IX. Common emergencies .....	131-138	173
X. Transportation of wounded .....	139-140	178
APPENDIX. References and bibliography .....		185
INDEX .....		187

# BASIC FIELD MANUAL

## MILITARY SANITATION AND FIRST AID

(The matter contained herein supersedes BFM, Vol. I, ch. 2, April 28, 1936.)

### CHAPTER 1

#### GENERAL

	Paragraphs
SECTION I. General -----	1-4
II. Responsibility for sanitation-----	5-6

#### SECTION I

#### GENERAL

■ 1. GENERAL.—*a.* Military sanitation comprises the application in the military service of practical measures for the preservation of health and the prevention and control of disease. Its primary purpose is to maintain the maximum effective strength of the military personnel. In most wars of the past the loss of military manpower from disease has far exceeded battle casualties, but with the intelligent enforcement of modern sanitary measures losses from disease in recent wars have been greatly reduced. However, continued diligent attention to sanitation is necessary since the same potential threats of disease persist.

*b.* The underlying fundamentals of military sanitation are the same as those of preventive medicine in civil life, but the military environment often demands very different sanitary measures than would be applicable in civil communities. Military establishments differ markedly from the average civil community in the close crowding of groups of individuals incident to military organization, and in the primitive and changing environment often encountered. Sanitary measures must at all times be adapted to the environment and to the military mission of each command. It is, therefore, of vital importance that all officers and enlisted men be conversant with the fundamentals of sanitation and that they cooperate in observing and carrying out the measures

prescribed by regulations or orders regarding sanitation. All officers should be competent to initiate and maintain adequate routine sanitary measures in their commands.

■ 2. PURPOSE.—The purpose of this manual is to furnish such basic information relative to the fundamentals of sanitation and sanitary measures applicable in the military service as is essential to officers and enlisted men of all grades and in all arms and services.

■ 3. SCOPE.—The scope of this manual includes the basic considerations in communicable disease control, housing of troops, methods of waste disposal, the purification of water, mess sanitation, the control of disease-bearing insects, personal hygiene, and first aid. Chapters 9 and 10 on Personal Hygiene and First Aid are particularly adapted for the instruction of enlisted men.

■ 4. REFERENCES.—For source of material and references, see Appendix.

## SECTION II

### RESPONSIBILITY FOR SANITATION

■ 5. RESPONSIBILITY FOR SANITATION.—*a. Commanding officers.*—Commanding officers of all grades are responsible for sanitation and for the enforcement of the provisions of sanitary regulations and orders within their organizations and the boundaries of areas occupied by them. Generous use should be made of the technical knowledge and advice of Medical Department officers but commanding officers retain full responsibility for the initiation and enforcement of suitable measures for the correction of sanitary defects.

*b. Medical Department.*—(1) *General.*—The Medical Department is responsible for investigating, reporting on, and making recommendations relative to all matters affecting the health of the Army, including the location of camps and stations, the source and methods of purification of the water supply, the methods and efficiency of waste disposal, the food supply and the sanitation of messes, the suitability of clothing and housing of troops, efficiency of training in personal hygiene and sanitation, the elimination of insects, and all

other measures for the prevention or control of disease. The functions of officers of the Medical Department in the realm of sanitation are, therefore, mainly of an inspectorial and advisory nature. Recommendations submitted by them constitute a basis for the initiation of sanitary measures by appropriate higher military authority. When practical these recommendations should be submitted in form suitable for issue as a sanitary order if and when approved. Medical Department officers exercise no command except in Medical Department installations. When, however, a commanding officer authorizes a medical officer to give orders in his name for the correction of sanitary defects, as is advisable under proper limitations, the duties and responsibilities of the latter are correspondingly increased. The Medical Department is responsible for the execution of health measures which require skilled technical training, such as artificial immunization, inspection of food, and physical examination. It does not furnish labor, funds, or equipment for such activities as water purification, waste disposal, or insect control.

(2) *Medical inspectors.*—The senior medical officer of a command under the commanding officer is charged with general supervision of Medical Department activities within the command. The medical inspector is an assistant to the surgeon, and under him is charged especially with the supervision of the sanitation of the command. The veterinarian of a command is in like manner considered a medical inspector as regards animal sanitation, inspection of foods of animal origin, and dairy hygiene.

c. *Quartermaster Corps.*—In peace or in the zone of the interior in war the Quartermaster Corps is normally responsible for the conduct of such sanitary measures as the operation of water systems, sewage disposal systems, delousing plants, camp or station incinerators and dumps when two or more units have common disposal, and for the actual work connected with control of mosquito breeding places. If for any reason the Quartermaster Corps does not carry on these activities, the work is performed by the units concerned.

d. *Corps of Engineers.*—In a theater of operations the Corps of Engineers assumes responsibility for the procurement and purification of water and for the disposal of wastes when



it is practicable to install and operate water works, water distributing points, sewage disposal systems, dumps and incinerators, or similar utilities to serve several units. When such is not the case, these activities are carried on by the units concerned.

■ 6. SANITARY ORDERS.—*a. General.*—Army Regulations constitute the general sanitary code of the Army. The exact sanitary measures to be observed and executed by any command are directed by orders issued by the headquarters of that command. Such orders, termed "Sanitary orders," conform to the general provisions of Army Regulations but represent adaptation of sanitary measures to the specific environment encountered. They may be published in various forms. For divisions or smaller units they are usually published either as a general order or as an annex to an administrative order. Changes, corrections, or initiation of sanitary measures may often best be directed by brief memoranda, especially in well-trained units smaller than a regiment. The headquarters of organizations larger than a division exercise control of sanitation by the publication of brief general policies. In whatever form issued, sanitary orders apply with equal weight to all concerned. Their provisions must be practical and clearly stated but not so restrictive as to hamper the exercise of proper initiative by subordinate commanders.

*b. Preparation and issue.*—The senior medical officer of a command is responsible for the preparation of the draft of a sanitary order. He submits the draft to the appropriate headquarters for consideration and publication, if approved. The unit commander is responsible for issuing and enforcing the provisions of the order.

## CHAPTER 2

### COMMUNICABLE DISEASES

	Paragraphs
SECTION I. Nature and principles of transmission.....	7-8
II. Control of communicable diseases.....	9

#### SECTION I

##### NATURE AND PRINCIPLES OF TRANSMISSION

■ 7. GENERAL.—*a. Definition.*—Communicable diseases are those diseases which can be transmitted from one person to another. The term “communicable disease” is synonymous with “infectious,” “contagious,” or “epidemic disease.” A few diseases are usually classified as communicable which are not as a rule transmitted from one person to another. Among these are tetanus, tularemia, and food infections acquired from diseased animals. These diseases are, however, preventable and hence may properly be grouped with communicable diseases.

*b. Importance.*—Communicable diseases as a group account for a considerable part of the admissions to sick report both in peace and in war. The experiences of well-disciplined military forces have shown that by the intelligent application of modern measures communicable diseases can be controlled to the extent that, while they may occur sporadically, they will rarely assume epidemic form.

*c. Cause.*—Communicable diseases are caused by the growth on or within the body of certain organisms or viruses commonly called “germs.” There is a specific organism or virus for each disease. These organisms or viruses produce poisons (toxins) which result in symptoms characteristic of the diseases of which they are the specific causes.

*d. Classification.*—Communicable diseases are best classified for control purposes according to the manner in which the causative organisms or viruses leave the body and are transferred to other persons. The groups are—

(1) *Respiratory*.—Those diseases in which the causal agents are eliminated in discharges from the mouth, nose, throat, and lungs.

(2) *Intestinal*.—Those diseases in which the causal agents are eliminated in the urine and feces.

(3) *Insect-borne*.—Those diseases which are transmitted by bloodsucking insects. In these diseases the causal organisms or viruses are contained in the blood and cannot escape from the body except in the blood.

(4) *Veneral*.—Those diseases which are usually transmitted during sexual intercourse.

(5) *Miscellaneous*.—Those diseases which are preventable but which do not readily fall into the above groups. Among these are tetanus (lockjaw), rabies, scabies, trichophytosis (ringworm), and anthrax.

■ 8. SPREAD OF COMMUNICABLE DISEASES.—Three factors are essential to the spread of any communicable disease: a source, a means of transmission, and a group of susceptible individuals.

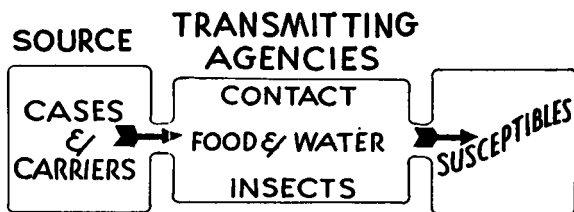

FIGURE 1.—Factors in the control of communicable diseases.

a. *Sources*.—(1) *Cases*.—A person who is actually ill with a disease is spoken of as a *case*.

(2) *Carriers*.—A person who, although not ill, is giving off from his body organisms or viruses capable of causing disease is known as a *carrier*. Some of the diseases known to be spread frequently by carriers are typhoid fever, diphtheria, meningococcic meningitis, and various types of dysentery.

(3) *Animals*.—In certain diseases, such as bubonic plague and Rocky Mountain spotted fever, the source may be an infected animal.

*b. Transmitting agencies.*—(1) *By contact.*—Transmission of a communicable disease by contact is accomplished either by direct contact or by close association between a case or carrier of the disease and one who is susceptible to the disease. Transmission by close association is accomplished by the causal agent being transferred within a relatively short period of time from a case or carrier to a susceptible person by means of the air, hands, eating utensils, or other objects.

(a) Respiratory diseases are usually transmitted by contact. In this group the organism or virus is usually eliminated from the body of a case or carrier in small fluid droplets contained in the exhaled breath, and these droplets carried by the air are inhaled by other persons. This is commonly termed "droplet infection." Hence, sneezing, coughing, and talking increase the number of organisms discharge and transmitted in this manner. In this group the organism or virus may also be contained in the fluid secretions from the mouth and nose and contaminate the hands, eating utensils, common drinking cups, towels, or other objects which serve to transport it to the mouth of another.

(b) The venereal diseases are transmitted solely by contact and usually by direct contact during sexual intercourse.

(2) *By water and food.*—The diseases transmitted by water and food are mainly those in which the causal organisms are eliminated from the body in feces and urine of the case or carrier. These infected excreta carry the organisms to food and water, which in turn serve as the medium for transporting them to the intestinal tract of persons who are susceptible to the disease concerned. The excreta containing the organisms may reach the water supply of the troops through drainage, or the food may be contaminated with the infected excreta by the hands of food handlers or by flies. The diseases which are usually transmitted by food and water are the intestinal diseases.

(3) *By bloodsucking insects.*—Certain of the bloodsucking insects, notably mosquitoes, lice, and ticks, can transmit the causal agent of disease from person to person. When the insect bites the individual having the disease, it ingests blood containing the organisms and afterward, when biting another person, injects the organisms into his blood.

(4) *By unusual or multiple agencies.*—Many of the diseases which are usually transmitted by indirect contact are also transmissible, but to a lesser degree, by food, and in some instances by water. Likewise, those diseases which are usually transmitted by food and water may also be transmitted by indirect contact.

(a) Some of the diseases generally transmitted by contact but which may also be transmitted by food are diphtheria, septic sore throat, scarlet fever, and tuberculosis.

(b) Typhoid and paratyphoid fevers, dysentery, and diarrhea which are generally transmitted by food and water are also easily transmissible by indirect contact through the medium of the hands, eating utensils, or any other object that will carry the infected material to the mouth.

*c. Susceptibility and immunity.*—(1) A susceptible person is one who is not immune to a given disease; that is, one who will develop the disease if infected with specific organisms or viruses.

(2) A person is immune to a given disease when the tissues of his body have developed the power to combat and overcome the specific organisms or viruses, or the poisons produced by them, thus preventing the occurrence of the symptoms of the disease.

(3) The individual may be rendered immune or nonsusceptible to certain diseases by an attack of the disease. An attack will confer a more or less permanent immunity to chickenpox, measles, mumps, scarlet fever, smallpox, typhoid fever, and a few other and less common diseases.

(4) An immunity to typhoid fever and smallpox can be conferred by vaccination, and vaccination against these diseases is required by Army Regulations.

(5) Nearly all persons possess some degree of natural resistance or immunity to communicable diseases which enables them to overcome small doses of the organisms or viruses and their poisons, so that slight infections therewith do not always produce symptoms of the disease. Natural resistance to disease is frequently transient in character and varies in degree from time to time. It may also be conferred or enhanced by improvement in the general health and physical fitness of individuals and by the adjustment of

environmental conditions such as housing, ventilation, and drainage so as to approach the ideal conditions for the existence of the individual. This is one of the reasons why physical training, good housing conditions, good messes, and suitable clothing are of great importance to military forces.

(6) In many of the communicable diseases an attack or vaccination will confer only temporary or transient immunity to future attacks, and an individual may, therefore, have repeated attacks of these diseases if subjected to repeated exposures to the infection.

## SECTION II

### CONTROL OF COMMUNICABLE DISEASES

■ 9. CONTROL MEASURES.—*a. General.*—Control measures may be directed against any one or more of the three basic factors necessary to the spread of communicable diseases. Complete elimination of any one of these three factors would theoretically entirely stop the spread of a communicable disease. Practically, this is possible in but few diseases. Due to the incompleteness of knowledge about many diseases, it is necessary to direct efforts at control against more than one factor. Control of the transmitting agent or agencies is most often the main objective of the control program. Specific measures for the control of various communicable diseases are outlined in later sections of this manual. The following listed measures are routine ones which should be observed at all times:

(1) *Control of sources.*—Supervision of cases and carriers with a view to preventing the transference of the causal agents to others.

(2) *Control of transmitting agencies.*—(a) Proper ventilation of barracks and tents.

(b) Prevention of overcrowding.

(c) Purification of water.

(d) Proper sanitation of messes.

(e) Proper waste disposal.

(f) Control of disease-bearing insects.

(3) *Protection of susceptibles.*—(a) Use of all possible measures for improvement of the general health of all individuals.

(b) Vaccination against smallpox, typhoid fever, and such other diseases as may be directed by competent authority.

(4) *Individual education.*—Instruction of all individuals in the fundamentals of personal hygiene, and the rigid observance by them of its rules.

b. Definition of special terms.—In the application of control measures against communicable diseases the following terms are frequently used:

(1) *Contact.*—A person who has been closely associated with a sick person is known as a contact.

(2) *Suspect.*—A person who has been exposed to a communicable disease and is ill, but in whom the symptoms and signs present are insufficient to warrant a diagnosis of the particular disease, is spoken of as a suspect.

(3) *Isolation.*—In the Army, cases of communicable diseases are hospitalized if possible, and are there segregated from other persons. This is termed “isolation.”

(4) *Incubation period.*—The incubation period of a disease is the time between exposure and the earliest symptoms of the disease. It varies with different diseases and in different persons.

(5) *Carrier.*—See paragraph 8a (2).

c. Quarantine is the segregation of carriers or of the contacts of a case of communicable disease to prevent the spread of the disease to the unexposed members of the command. Quarantine may be applied to one or to a large number of persons. It may be absolute or modified.

(1) In absolute quarantine the carriers and contacts of a communicable disease are completely isolated or confined so that they are entirely separated from all other persons. This type of quarantine is seldom employed in the Army.

(2) Modified quarantine, termed “working quarantine,” is ordinarily employed. In this the group involved are messes and quartered together and are separated from all other persons but continue to carry on such training or other activities as do not bring them into close association with persons outside the contact group. All members of the quarantined group are examined once or twice daily by a medical officer. Any individuals showing suspicious symptoms are immediately isolated.

(3) Quarantine is continued until a time equal to the longest usual incubation period of the disease concerned has elapsed since the last case developed in the group.

(4) Enforcement of the quarantine measures is a responsibility of the unit commander. He is also responsible for detecting and promptly reporting any case of illness occurring among members of his command between inspections by a medical officer. Usually quarantine is directed and removed by higher authority on recommendations of the responsible medical officer.

(5) Quarantine has its greatest value in the control of certain respiratory diseases. Intestinal and insect-borne diseases cannot be controlled by quarantine alone.

*d. Detention camps for recruits.*—When large numbers of recruits are being received at a camp or station it is highly probable that some of them either have or are about to develop communicable diseases. To prevent these diseases being spread throughout the command a detention camp or barracks may be established. All recruits on arrival enter the detention camp and remain there at least 2 weeks. Their status is that of working quarantine. They are examined daily by a medical officer. If communicable diseases develop it may be necessary to establish small quarantine camps within the main detention camp for contacts and suspects. If recruits are arriving in comparatively small numbers they may be assigned directly to organizations. However, they should be examined daily by a medical officer for at least 2 weeks.

*e. Vaccination.*—There are certain specific procedures, the immediate and primary purpose of which is to increase the resistance of the individual to infection. These are termed vaccinations and their use renders the individual immune to that specific disease.

(1) Army Regulations prescribe that every member of the military force is vaccinated against typhoid fever and smallpox immediately on entry into the service. In time of peace, and in the zone of the interior in time of war, all troops are vaccinated against smallpox every 3 years and are given the second course of the typhoid vaccine 3 years after the first, and thereafter as determined necessary by the War Depart-



ment. Troops leaving the zone of the interior for the theater of operations are revaccinated against typhoid fever and smallpox if more than 12 months have elapsed since their last vaccination.

(2) Smallpox vaccination gives protection against smallpox for a period of at least 3 years. The typhoid vaccine will confer immunity to at least moderate doses of the causal organism, and will completely protect most individuals against small doses, for a period of at least 3 years.

(3) There are several other diseases against which vaccination may be employed. Cholera vaccination gives protection against cholera for about 1 year and would be administered to troops going to a region where cholera is present. Vaccination against tetanus is also of value and would probably be employed in time of war as a routine measure.

(4) The administration of vaccination is a function of the Medical Department. Unit commanders are responsible that members of their command report for vaccination as required by Army Regulations or as directed by higher authority, and that proper record of the vaccination is made in the individual's service record.

*f. Sera and antitoxins.*—These are preparations which are used in the treatment of certain communicable diseases, or in conferring temporary immunity to them. The two most commonly used ones are tetanus antitoxin and diphtheria antitoxin. It is an entirely different preparation than that used in tetanus vaccination, which confers much more lengthy immunity. All sera and antitoxins have certain dangers and are administered only by the Medical Department.

## CHAPTER 3

### RESPIRATORY DISEASES

	Paragraphs
SECTION I. General.....	10
II. Control measures.....	11-13

#### SECTION I

#### GENERAL

■ 10. GENERAL.—Respiratory diseases occupy first place as a cause of admission to sick report. They are particularly prevalent during the winter and spring and when large groups of recruits are assembled. They are spread in the secretions of the respiratory tract, and may be transmitted through the media of air, hands, food, mess equipment, or any other substances which come in contact with secretions from the mouth or nose. The principal respiratory diseases are—

Bronchitis, acute.	Pneumonia.
Chickenpox.	Poliomyelitis.
Coryza (common cold).	Scarlet fever.
Diphtheria.	Septic sore throat.
Influenza.	Smallpox.
Laryngitis, acute.	Tonsillitis, acute.
Measles.	Tuberculosis, pulmonary.
Meningitis, epidemic.	Vincent's angina.
Mumps.	Whooping cough.
Plague, pneumonic.	

#### SECTION II

#### CONTROL MEASURES

■ 11. GENERAL.—The control of respiratory diseases is difficult because of their easy transmission, the rather general susceptibility to them, and the scarcity of specific protective measures. Vaccination confers specific immunity against

smallpox which is the only disease of this group which can so positively be controlled. Vaccines or sera are available for several other diseases of this group but they are not practical of application on the large scale necessary in the Army. In like manner, survey for carriers of diphtheria and meningitis is generally impractical if the group concerned is a large one. Group quarantine is of value in the control of certain diseases, among them measles, mumps, and scarlet fever. It is, however, of no practical value in the control of influenza or common respiratory diseases. Control measures are chiefly directed at the transmission agencies and at increasing and maintaining the group resistance.

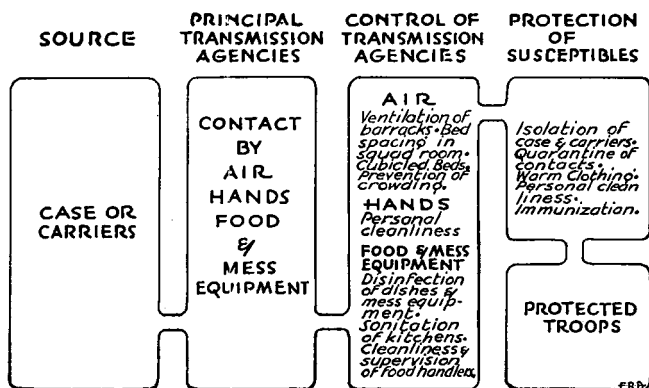

FIGURE 2.—General factors in the control of respiratory diseases.

■ 12. ROUTINE CONTROL MEASURES.—The principal routine measures to decrease the incidence of respiratory diseases are—

*a. Proper ventilation.*—(1) Ventilation is the adjustment of atmospheric conditions so as to promote health, comfort, and efficiency. Poor ventilation with the resultant increase in humidity or atmospheric temperature or both favors the spread of respiratory disease by interfering with the heat regulating mechanism of the body, thereby decreasing the resistance of the tissues of the respiratory tract to infection

and decreasing general physical efficiency. Poor ventilation of barracks or quarters causes the occupants to exchange micro-organisms by rebreathing their expired air, the germ content of which has been increased by coughing and sneezing.

(2) The ill effects of poor ventilation alone are due to heat, moisture, and stagnation of the air surrounding the body. By stagnation of the air is meant a deficiency of air movement. The effect is the same as the increasing discomfort experienced when an individual is exposed to high atmospheric heat. The air in sleeping quarters should have a movement easily felt on the back of the hand and a flow through the room amounting to 1,800 cubic feet per hour per occupant. A properly ventilated room will not feel stuffy or hot when entered.

(3) The proper ventilation of an occupied barracks or quarters requires that the air be moved through the room, that is, admitted and removed in such volume and with such velocity that the atmospheric temperature and relative velocity will remain approximately constant within certain limits, and without the production of uncomfortable drafts. For practical purposes, the existing air conditions of a barracks or quarters may be determined by the temperature as shown on the thermometer, and by the effect of air movement on one's senses. The temperature range should be 64° to 70° F. Overheating, as shown by the thermometer, means poor ventilation regardless of its cause. With a satisfactory thermometer reading, a sense of discomfort due to excessive warmth or stuffiness of the air is indicative of high relative humidity, insufficient air movement, or both, and again means poor ventilation. Thus, there must be a proper balance between these three factors, heat, moisture, and air movement, to effect good ventilation.

(4) There are two methods of ventilation, natural and mechanical. Natural ventilation depends upon an interchange of indoor and outdoor air through openings in the walls. In barracks or quarters it is usually easy to control the volume of air required, but the control of its velocity and the prevention of drafts may be difficult. It may also be difficult to secure an equal distribution throughout the room. Natural ventilation is easily and adequately obtained by open-

ing windows at the bottom on the windward side and at the top on the other side. The area of these openings depends upon the number of occupants, the velocity and direction of the wind, the difference in temperature between the indoor and outdoor air, and the construction of the building. As a working basis 1.5 square feet of inlet and of outlet surface is required for every 10 men in sleeping quarters when the outside temperature is about 50° F. If the windows are on one side only, or if the inlet and outlet are at the same level, the air will be short-circuited with an uneven distribution in the room. Drafts are prevented by having several small inlets rather than a few large ones. Also, the use of deflectors in the window openings aids in decreasing drafts.

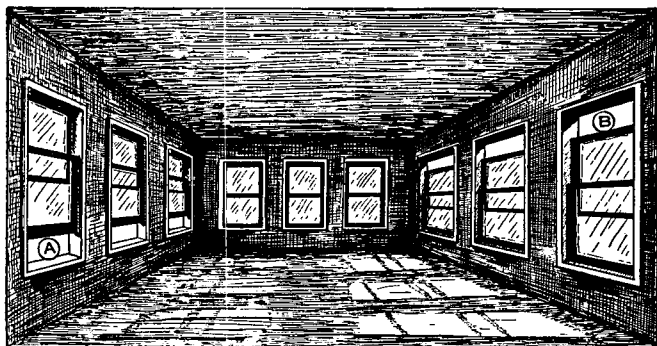

FIGURE 3.—Ventilation of squad rooms showing method of arranging window openings. A—Inlet. B—Outlet.

(5) If troops are quartered under canvas, the sides of the tent should be rolled up daily and the hoods opened, weather permitting. In temporary buildings provided with single sash windows, provision should be made for such numbers of windows for entrance of air as the weather conditions permit. In rooms which have been ceiled, there should be openings in the ceiling to permit the escape of air to ridge ventilators.

(6) The ventilation of barracks, tents, and other places in which troops are quartered is the responsibility of the

company or other similar unit commander, and satisfactory results are obtained only by careful and constant attention on the part of commissioned officers. Noncommissioned officers must be instructed in the essentials of and necessity for obtaining good ventilation. Noncommissioned officers in charge of quarters should check the window ventilation several times each night, especially during the respiratory season, November to April.

*b. Proper bed spacing.*—(1) In barracks, each man should have a floor space of 60 square feet and air space of 720 cubic feet. In extreme emergencies the minimum allowance may be reduced to 50 square feet of floor space and 500 cubic feet of air space per man. With double decker bunks the standard should be 100 square feet of floor space and 1,400 cubic feet of air space per bed. Beds must be so placed that under average conditions the deep breathing of sleeping occupants will not spray secretions from the nose and throat into the air to be inhaled by those in nearby beds. With an allowance of 60 square feet per man, there exists 6 feet distance between the heads of the men. This distance is adequate to prevent the usual contamination through droplet infection. Bunks should at all times be so arranged that there is head to foot sleeping. When necessary, staggering of beds will aid in securing the desired distance between men.

(2) All squad rooms should have the authorized capacity, based on the allowance of 60 square feet per man, posted on the entrance door. With an increased number of men the probabilities of having a carrier of respiratory diseases present is increased. Also, the number of contacts that occur is increased, should a case of respiratory disease develop. Tentage should supplement inadequate barrack space, assigning 6 men to a pyramidal tent, provided the troops will not be subjected to adverse weather conditions. Wide spacing of beds will not compensate for poor ventilation. If beds are too close together the air has to move at such a velocity that undesirable drafts are produced in providing proper ventilation. Decreasing of bed space should not be permitted as it increases contacts, should cases or carriers, of disease be present. More beds mean more men exposed to respira-

tory disease with a resultant higher noneffective rate and probably an epidemic. If head to foot sleeping and staggering of beds still allow less than 5 feet between the heads of the men, the beds in the squad rooms should be separated by screens to convert each bed space into a cubicle. The cubicle screen is readily made from an ordinary shelter tent half, blanket, sheet, or boards. The screen made from a

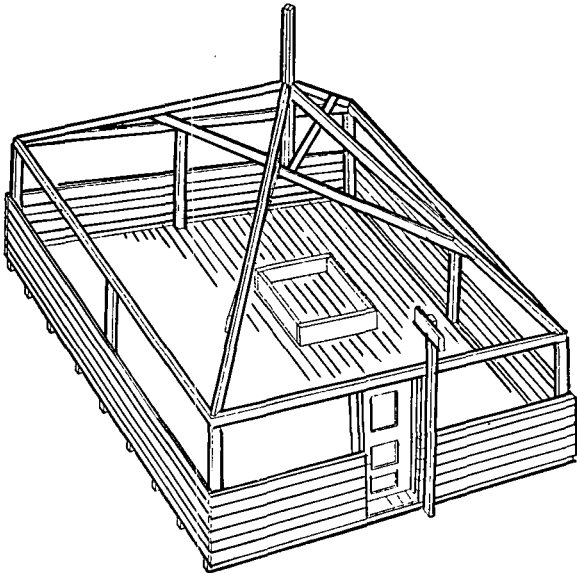

FIGURE 4.—Floor and frame for pyramidal tent.

shelter half may be fixed on a bed or cot by tent poles. The screen extends 2-4 feet above the surface of the head of the bed, the height decreasing toward the foot, and extending 1 foot below the cot or bed. If the screen is too short, too low, or does not extend below the bed, air currents may carry the infectious secretions of an occupant to adjacent occupants. If cubicles are too high or extend too far beneath the bed, they interfere with the movement of the air and cause im-

proper ventilation. Head to foot sleeping is essential. Cubicles should be used for all recruits during the respiratory disease season and for all troops in the presence of or during a threatened epidemic.



FIGURE 5.—Method of constructing cubicles in squad rooms by the use of shelter tent halves with head and foot arrangement of beds.

*c. Prevention of overcrowding.*—The rate of spread and the extent of an epidemic of any respiratory disease are largely dependent upon the closeness of contact between infected and susceptible persons. The control of crowding or close contact is, therefore, the most important factor in the control of respiratory diseases. This is accomplished only by constant supervision by commissioned personnel. It is aided by proper ventilation, proper bed spacing, occupying alternate seats at mess halls and theaters, minimizing close-order drill, and limiting gatherings in the squad or day room by providing diversified entertainment. The closing of theaters and the discontinuance of military training only cause idleness among the troops, and under such conditions they naturally congregate in service clubs, day or squad rooms, post exchanges, and offices, which nullifies the objective being sought. Fur-



ther, idle troops have poor morale and the discipline necessary to enforce proper control procedures is more difficult to obtain. Notwithstanding these facts, it may at times be necessary to close theaters and discontinue most military activities.

*d. Barracks and tent cleanliness.*—Proper barracks sanitation means cleanliness and, like ventilation, is a responsibility of organization commanders. Certain sanitary precautions, however, are essential to cleanliness. Spitting on the floors, dry sweeping of the floors careless coughing, sneezing, and the use of common drinking cups and towels must be prohibited. An ample supply of cuspidors containing a 2 per cent solution of cresol to a depth of 1-2 inches is important. Cuspidors must be cleaned daily. Bedding should be aired twice weekly. Beds should be cleaned with soap and water at frequent intervals.

*e. Measures to improve general resistance.*—See paragraph 107.

*f. Mess sanitation.*—Mess gear and utensils should be thoroughly sterilized. Any food handlers showing evidence of respiratory disease should be promptly relieved from duty.

*g. Recruits.*—Incoming recruits should be kept apart from other troops for at least 2 weeks, either in detention camps or in separate squad rooms.

*h. Hospitalization.*—Cases of respiratory disease should be promptly reported to a medical officer. This aids in early recognition of the more serious diseases.

■ 13. EPIDEMICS.—In the presence of a threatened or actual epidemic of respiratory diseases attention to the foregoing measures should be increased. The surgeon may also recommend part or all of the following program, dependent largely on the characteristics of the disease in question.

- a.* Hospitalization or absolute quarantine of suspects.
- b.* Group quarantine of contacts.
- c.* Hospitalization of carriers, if known.
- d.* Closing of theaters and recreational buildings (rarely advisable).
- e.* Restriction or even cessation of training activities.

## CHAPTER 4

### INTESTINAL DISEASES

	Paragraphs
SECTION I. General.....	14
II. Control of intestinal diseases.....	15
III. Field water supplies.....	16-20
IV. Disposal of wastes.....	21-33
V. Fly control.....	34-35
VI. Mess sanitation.....	36-44

#### SECTION I

##### GENERAL

■ 14. **GENERAL.**—*a.* The intestinal diseases are those in which the causal agents are eliminated from the body in the feces and urine. They are usually transmitted by contaminated food and water which may be transmitted by the hands or by eating utensils. Their causes and modes of transmission are well understood, and they can be prevented by proper sanitation. The principal intestinal diseases are—

Amebic dysentery.	Helminthic infestations
Bacillary dysentery.	(worms).
Cholera.	Paratyphoid fever.
Diarrhea.	Protozoal dysenteries.
Food infection.	Typhoid fever.
Food intoxication.	Undulant fever.

*b.* Carriers of typhoid fever, amebic dysentery, or other of the intestinal diseases are relatively common. This fact must be kept in mind in considering the control of the intestinal disease group.

#### SECTION II

##### CONTROL OF INTESTINAL DISEASES

■ 15. **CONTROL MEASURES.**—*a. General.*—Effective control of intestinal diseases is chiefly dependent on control of the transmission agencies. There are two notable exceptions to this general statement; typhoid vaccination confers a high degree of immunity to typhoid fever for nearly 3 years, and cholera vaccination will protect an individual against cholera for

about 1 year. However, no practical specific immunizing measures are available for the majority of the intestinal diseases. Thus, reliance must be placed on measures designed to prevent exposure to infection. Fortunately, such measures are both effective and readily practicable.

*b. Routine measures.*—The following measures are essential to the control of intestinal diseases:

- (1) Purification and protection of water supplies.
- (2) Proper inspection and protection of food supplies.
- (3) Proper mess sanitation.
- (4) Proper waste disposal.
- (5) Fly control.
- (6) Immunization (routine only for typhoid).
- (7) Rigid personal hygiene of all individuals.

(8) Rigid discipline in matters of sanitation, particularly as regards avoiding unauthorized sources of water and food.

*c. Importance of early diagnosis.*—Should cases of intestinal disease occur, their early diagnosis and isolation together with disinfection of any objects possibly contaminated by the infected individuals will greatly lessen the possibility of an epidemic.

### SECTION III

#### FIELD WATER SUPPLIES

■ 16. AMOUNTS REQUIRED.—Water requirements vary under different conditions. Individuals cannot maintain good health in active field service with less than 1 gallon of water per day for drinking and cooking. Troops on field service and in temporary camps will ordinarily use 2 to 5 gallons of water per person per day for all purposes. In semi-permanent camps the per capita consumption varies from 20 to 40 gallons per day. In permanent stations the per capita consumption may vary from 50 gallons to as much as 200 gallons per day. Animals ordinarily require 10 gallons of water per day each, but in combat conditions, may be reduced to 5 gallons each per day.

■ 17. WATER SOURCES.—Practically all sources of water in the field must be considered as contaminated. Thus, all water should be properly treated before use unless the Medical De-

partment has established definite proof that the source is not contaminated. Some sources of water are, however, better than others. Surface water (ponds, rivers, or small streams) is generally more heavily contaminated than ground water (wells or springs). The factors considered in selecting a water supply are—

- a. Quantity available.
- b. Accessibility of the source.
- c. Type (surface or ground).
- d. Probable extent of contamination.

■ 18. RESPONSIBILITY FOR WATER SUPPLIES.—*a.* The Quartermaster Corps is responsible for the procurement and treatment of water for all stations and camps in time of peace, and in the zone of the interior in war, except in the case of smaller units, when supply of water by the Quartermaster Corps may be impracticable.

*b.* The Corps of Engineers is responsible for all water supplies in a theater of operations except at times, in the case of smaller units, when supply by the Corps of Engineers may be impracticable.

*c.* If for any reason the Quartermaster Corps or the Corps of Engineers do not supply treated water, unit commanders are responsible for the procurement and treatment of water supplies. Unit commanders are at all times responsible for the protection and control of the use of water supplies within their organizations.

*d.* The Medical Department is responsible for making recommendations as to the most satisfactory source and method of treatment of water supplies, and for supervising the treatment.

■ 19. PROTECTION OF WATER SUPPLY.—*a. General.*—Every source of water supply should be carefully guarded against pollution by human or animal wastes. Pollution can occur either by surface or subsurface drainage. Latrines and kitchen soakage pits should be located so that drainage is away from the water source. If a stream is to be used as the source of the water supply of an organization, it should be marked off in zones, indicated by markers, and water guards should be posted.

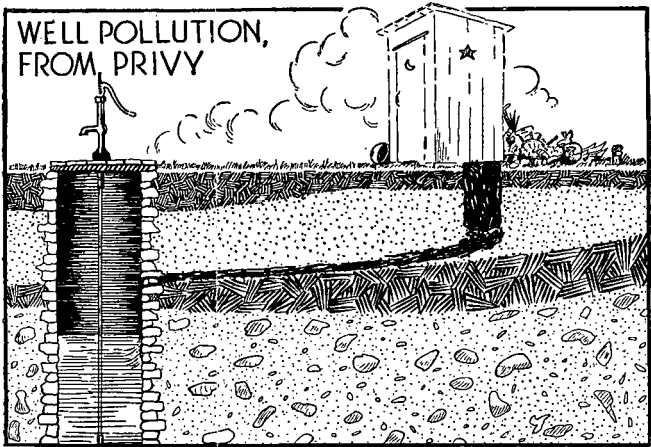

FIGURE 6.—Pollution of a well by seepage from a pit privy.

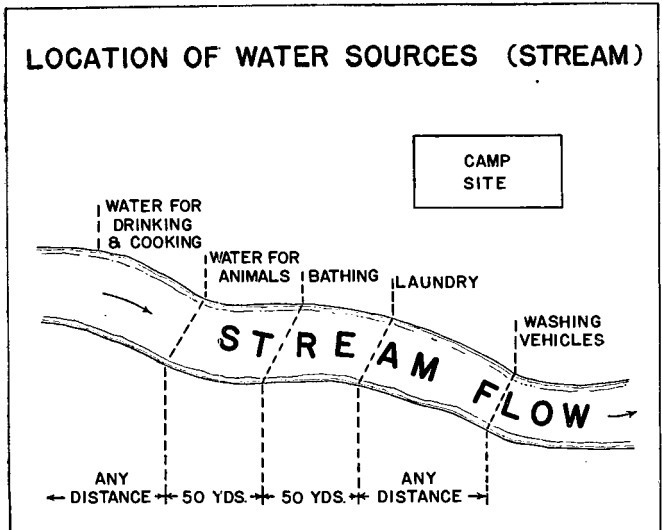

FIGURE 7.—Protection of water supply by proper use of stream from which water is taken for various purposes.

*b. Responsibility.*—Protection of water supplies both before and after treatment is the responsibility of commanding officers.

■ 20. METHODS OF PURIFICATION.—*a. Preliminary treatment.*—The water selected should be as clean as possible, and the heavier organic matter removed by straining or settling. A pit dug 4 to 5 feet from the edge of a stream or pond and 3 to 4 feet below the stream level makes a satisfactory settling basin. Another method is to remove both ends from a panel or oil drum and sink one end into the bottom of a shallow stream or pond, dipping water from inside the barrel.

*b. Boiling.*—Boiling is the safest method, but is undesirable, because of the flat taste and because of the lack of containers for boiling other than small quantities. Five minutes of boiling is required for sterilization of water.

*c. Chlorination.*—(1) *General.*—Chlorination is the method of choice and may be carried out in the water sterilizing bag (Lyster bag), in water carts, in small reservoirs, or by the mobile purification units operated by the Corps of Engineers. The exact amount of chlorine required will vary with the characteristics of the water being treated. Water containing considerable organic matter requires considerably more chlorine than does clear water.

(2) *Water sterilizing bag method.*—The procedure is as follows:

(a) Suspend the bag on a tripod. Fill it with water to the mark 4 inches from the top, straining the water through cheesecloth. The capacity is 36 gallons.

(b) Draw a small quantity of water through one of the faucets into a canteen cup.

(c) Break a tube of calcium hypochlorite into the canteen cup, stir with a clean stick, then fill the cup two-thirds full of water.

(d) Empty this solution into the water bag and stir thoroughly with a clean stick which is long enough to reach to the bottom of the bag.

(e) Draw at least one-half canteen cup of water from each of the faucets and pour it back into the water bag. This serves to sterilize the faucets.

(f) Wait 10 minutes, then wash out one of the faucets by allowing a small amount of water to run through onto the ground. Fill a clean canteen cup two-thirds full of water from the same faucet. Add one cc. (15 drops) of orthotolidine testing solution to the water in the cup. Wait 5 minutes

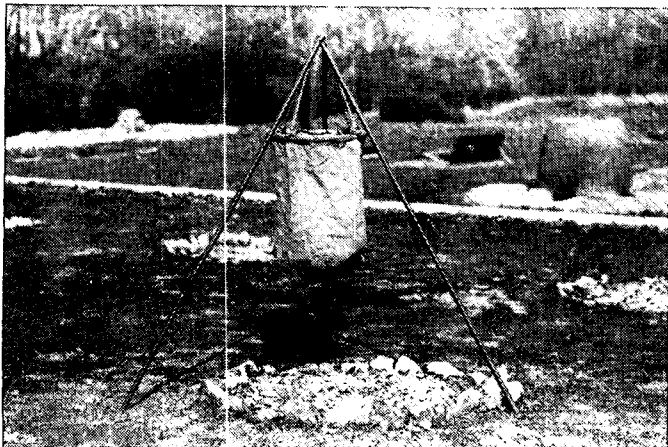

FIGURE 8.—Water sterilizing bag.

and note the color produced. Below is a guide for reading the color reaction between the free chlorine and orthotolidine:

1. *No color.*—Insufficient chlorination. Add more calcium hypochlorite.
2. *Canary yellow.*—Insufficient chlorination. Add more calcium hypochlorite.
3. *Deep yellow.*—Satisfactory chlorination. This represents about one part per million (ppm) of chlorine.
4. *Orange red.*—Overchlorinated. Add more water and re-test.
5. *Bluish green.*—Alkaline or hard water. Add a few more drops of orthotolidine to get a correct color reading.

(g) Wait 30 minutes after satisfactory chlorination has been accomplished before using the water. The cover should be kept on the bag to prevent recontamination. The unpleasant taste of chlorine is diminished by allowing chlorinated water to stand several hours before use. It is a good plan to chlorinate water in the evening for the next morning's use.

(3) *Water cart method.*—Chlorination may be done directly in water carts, stirring in calcium hypochlorite at the rate of about one tube to each 36 gallons of water. The exact amount needed can be determined by the orthotolidine test. These carts must be thoroughly cleaned at frequent intervals.

(4) *Canteen method.*—Fill a canteen with water and dissolve into it the contents of one tube of calcium hypochlorite, being sure that it is evenly mixed throughout. Add one canteen cap (6 cc.) of this solution to each canteen of water. Wait 30 minutes before drinking the water. This method is less accurate than chlorination in the water sterilizing bag and requires very close supervision of all individuals. The concentrated calcium hypochlorite solution may be prepared in a 1-quart bottle instead of in a canteen.

*d. Use of iodine for purification of water.*—In the absence of calcium hypochlorite, tincture of iodine may be used as a temporary expedient. Two or three drops of tincture of iodine will purify one canteenful of water. Thirty minutes should be allowed before the water is used. This method is rarely practicable in combat since all available iodine will generally be needed for treatment of wounds.

*e. Water systems.*—In semipermanent or permanent camps water requirements are so great that the preceding methods are impracticable. Pipe lines, pumps, and reservoirs become necessary. The construction and operation of such installations are ordinarily functions of either the Quartermaster Corps or the Corps of Engineers.

#### SECTION IV

#### DISPOSAL OF WASTES

■ 21. WASTE DISPOSAL.—*a. General.*—The disposal of waste materials in such a manner that they are eliminated as factors in the spread of disease is an essential feature in the control



of communicable diseases, especially those belonging to the intestinal group.

*b. Classification.*—The wastes which must be disposed of are—

(1) *Human wastes.*—Excreta, solids and liquid, and bath water.

(2) *Kitchen wastes.*—Liquid and solid.

(3) *Animal wastes* (manure).

(4) *Rubbish.*

■ 22. DISPOSAL OF HUMAN WASTES.—Human wastes play the most important role in the transmission of intestinal diseases because they are frequently carried from cases or carriers into water which is to be used for drinking and cooking, or are conveyed to food by the hands or by insects, rats, and mice. The problem of disposal of human wastes is increased in bivouacs and in temporary or semipermanent camps.

■ 23. LATRINES.—The following general guides apply to latrines constructed in camps of those types:

*a.* Latrines are company installations, maintained by the personnel of the company concerned.

*b.* Latrines seats or space are provided to accommodate 8 percent of the command at one time, each man being allowed 2 lineal feet of latrine space.

*c.* Latrines should be flyproofed.

*d.* Latrines should not be dug below the ground water level.

*e.* Latrines dug in clay are unsatisfactory since liquids will not be absorbed.

*f.* Latrines should be placarded when closed, showing the date and the organization.

*g.* Latrines should be located at least 100 yards from any mess, and so that drainage into a source of water supply is impossible. The preferable location is about 30 yards from the end of the company street.

*h.* A lighted lantern should be hung at each latrine at night unless the military situation demands concealment.

■ 24. CONSTRUCTION AND CARE OF LATRINES.—*a. General.*—The types of latrines used in temporary and semipermanent camps differ in construction, but their care is similar. The primary

objectives in all types of latrines are to control nuisances and to prevent access of flies to human excreta.

*b. Straddle trench.*—(1) Straddle trench latrines are used for the disposal of feces and urine in bivouac, in camps of less than 1 week, and at the noon halt on a march. They may also be used until deep pit latrines can be constructed in camps of longer duration than 1 week. The straddle trench latrine is usually constructed by digging a trench 1 foot wide, 2 feet deep, and 8 to 10 feet long. Sometimes, however, it may be desirable to dig small units of straddle trenches, each 2 to 4 feet long. The earth removed should be piled at one or both ends of the trench, and be used by each man to cover his excreta. Boards placed along the edges of the trench provide better standing.

(2) Straddle trenches should be closed by refilling with earth when the contents have reached within 1 foot of the surface of the ground. The trenches should, if practicable, be sprayed with crude oil daily.

*c. Deep pit latrines.*—(1) When troops are in camp 1 week or longer, deep pit latrines and urinal troughs or urine soakage pits are constructed. Deep pit latrines may be used even in camps of rather permanent nature. The deep pit latrine is used in conjunction with the standard quartermaster latrine box, and must be dug of exact dimensions to conform to the size of the box.

(2) The latrine pit is dug 2 feet wide, 8 feet long, and 4 to 10 feet deep. The depth is dependent on the character of the soil and the length of time the latrine is to be used. A latrine to be in use 1 week is dug 3 feet deep, and 1 foot is added for each additional week the latrine is to be used. For example, if a latrine is to be in use 4 weeks, it should be dug 6 feet deep, and if for 8 weeks, it should be 10 feet deep. Striking rock or ground water may limit the possible depth. A company of 100 men requires 16 feet of latrine space (2 standard latrine boxes). The latrine boxes may be of knock-down type to facilitate transportation.

(3) Pit latrines must be flyproofed to prevent access of flies to fecal material, and to prevent the escape of larvae in case flies have gotten into the pit and breeding has taken place. Flyproofing is accomplished in the following manner: An

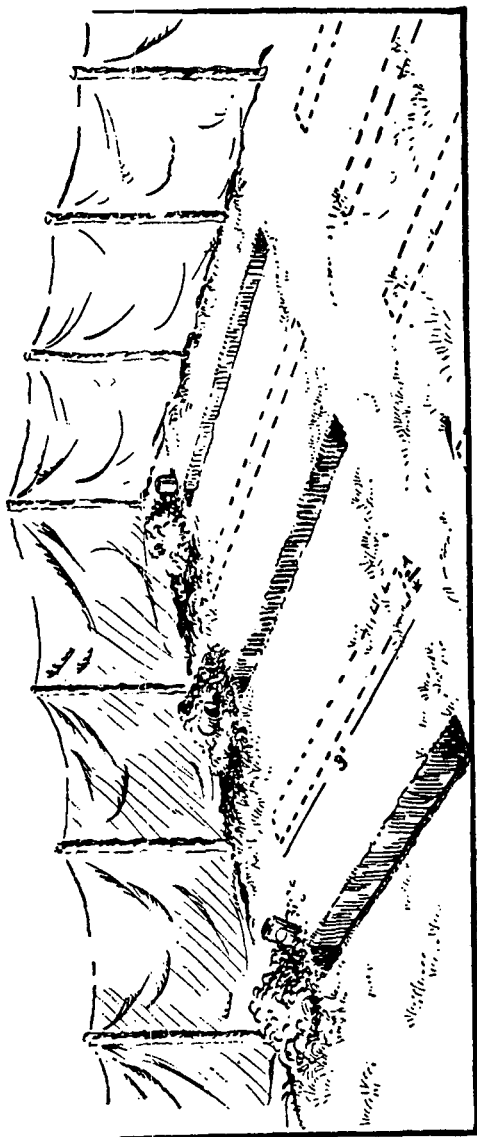

FIGURE 9.—Trench latrine.

area 4 feet wide surrounding the pit is excavated to a depth of 6 inches. This area is then covered with burlap and soaked with crude oil. This burlap hangs down the walls of the pit to

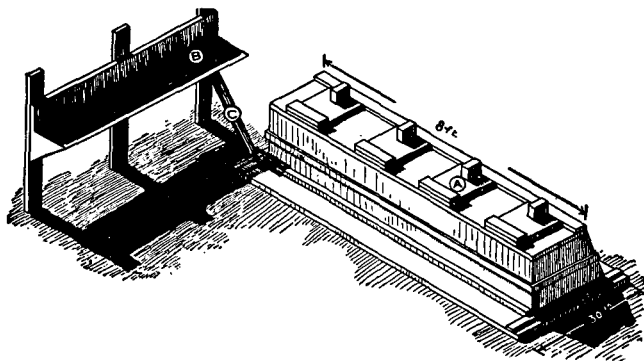

FIGURE 10.—A—Standard latrine box. B—Trough urinal. C—Pipe leading from urine trough into latrine pit.

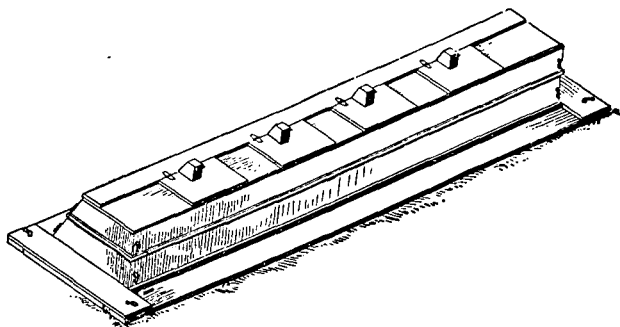

FIGURE 11.—Knockdown latrine box showing position of tail nuts and rods which permit the box to be taken apart.

a depth of 18 inches and is turned down into the ground at the outer borders of the area. The earth is replaced, tamped down, and more oil added. If burlap is not available, oil alone may be used, and if oil is not obtainable, the earth may

be hardened by moistening with water and tamping. Earth should be tightly packed around the edges of the box to seal all openings to the pit.

(4) The latrine should be enclosed by a canvas screen. If this is not available, a brush screen should be used. A large wall tent may be used to enclose a latrine. A drainage ditch, 6 inches deep, should be dug outside the latrine enclosure to carry surface water away from the pit.

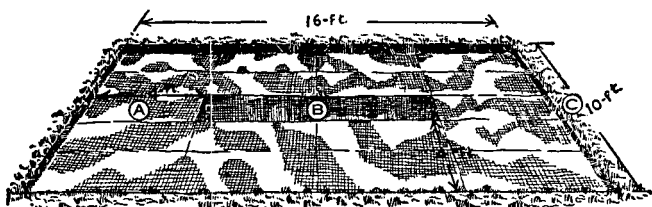

FIGURE 12.—Flyproofing latrine pit. A—Oil-soaked burlap extending completely around pit. B—Opening of pit. C—Sidewall of excavation in which burlap is placed.

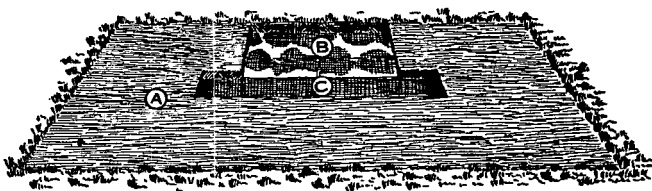

FIGURE 13.—Method of flyproofing latrine pit with oiled burlap. A—Layer of earth replaced and tamped down over oil-soaked burlap. B—Oiled burlap exposed before replacement of earth. C—Opening of pit.

(5) Latrines must be kept clean and free from odors and flies. Crude oil or a mixture of crude oil with fuel oil or kerosene applied to the interior of pits and boxes is of value in eliminating odors and repelling flies. Crankcase drainings may be used but they are less satisfactory. Lime is of no practical value in latrine pits except as a deodorant. The burning out of latrine pits is not advisable since it does not accomplish incineration of excreta and does interfere with

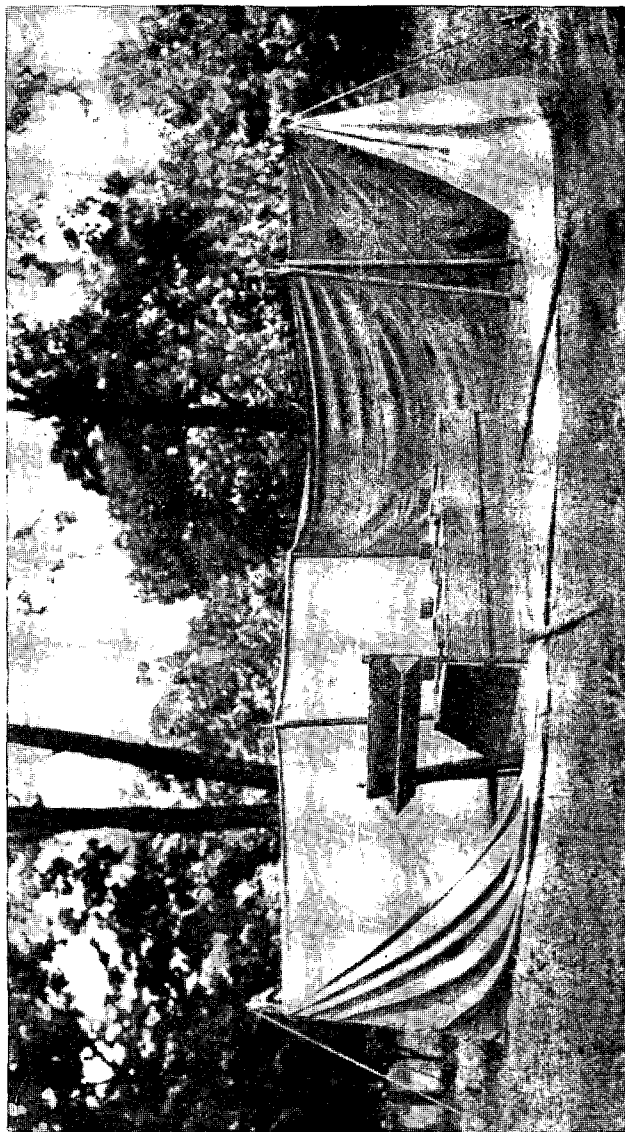

FIGURE 14.—Latrine with screen dropped on one side to show box and urine trough.

measures taken for making the pit and box flyproof. Special attention must be given to the cleanliness of urine troughs. Constant attention by a latrine orderly is necessary for proper care of latrines. The following points are particularly important:

(a) The contents of the pit, the sides of the pit, and the interior of the box should be sprayed with crude oil daily.

(b) The seats should be scrubbed daily with soap and water, and twice a week should be scrubbed with a 2-percent cresol solution. They should be dried after cleaning.

(c) The urine troughs should be scrubbed daily with soap and water.

(d) The seat covers should be kept closed when not in use.

(e) The box should be kept flytight by repairing it as necessary.

(f) Fly traps should be placed near each latrine.

(g) An ample supply of toilet paper should be available.

(6) *Closing latrines.*—Deep pit latrines should be closed when filled to within 2 feet of the surface. The box should be removed; the pit contents sprayed with crude oil and covered with burlap; and the pit filled with dirt domed 12 to 18 inches above surface. The site should be placarded with the date of closure and the name of the organization. The same spot should not be used again for at least 1 year.

*d. Pail latrines.*—If the character of the soil or any other reason makes it impracticable to dig deep pit latrines, a pail latrine may be substituted. By placing hinged doors on the rear of, and a floor in the standard latrine box, it may be used for a pail latrine. The pail is placed directly below the seat and, if located in a building, the hinged doors should open directly to the outside. The latrine seats and rear doors should be self-closing and the box made as nearly flyproof as possible. The floor should be waterproof, concrete if possible, and have sufficient slope to promote rapid and thorough drainage of the wash water. A trough urinal may be installed within the latrine building with a drain pipe leading into a container outside the building. The pails must be removed and emptied daily, being replaced by clean pails, the bottom of which should contain about 1 inch of a 2 percent solution of cresol. The latrine box must be cared

for as described under deep pit latrines. The disposal of the excreta from pail latrines may be accomplished by burial or incineration. It may be possible at times to empty the pails into a manhole of a nearby sewer.

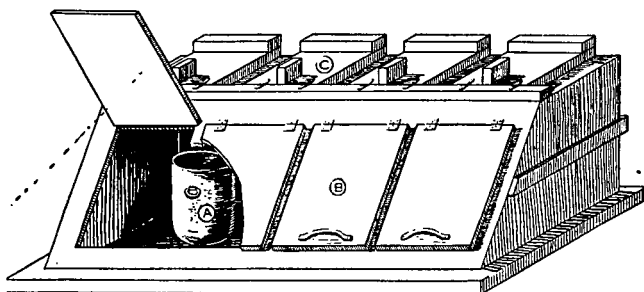

FIGURE 15.—Method of adapting standard latrine box for use as pail latrine. A—Latrine pail. B—Hinged doors. C—Self-closing lids.

■ 25. URINE TROUGHS AND SOAKAGE PITS.—*a. Urine trough.*—

If a deep pit latrine is dug in ground which will absorb liquids well, a urine trough drains into the pit and is included within the latrine enclosure. This trough is constructed from tin, galvanized iron, or wood. If from wood, it should be lined with tar paper. The trough should be U- or V-shaped, and 5 feet in length. It is connected to the pit by short sections of pipe.

*b. Urine soakage pit.*—If the latrine pit is in ground having poor absorbing qualities, a urine soakage pit should be used for the disposal of urine. This consists of a pit 4 feet square and 4 feet deep, which is filled with pieces of broken rock, flattened tin cans, brick, or broken bottles. Urinals made of 2-inch pipe are placed at each corner of the pit extending 8 inches below the surface and 30 inches above. A tar-paper funnel containing grass or straw is placed in the upper end of each pipe. Important precautions in the proper operation of such a soakage pit are—the changing of the grass or straw in the funnels daily; cleaning the funnels daily with soap and water; changing funnels weekly;



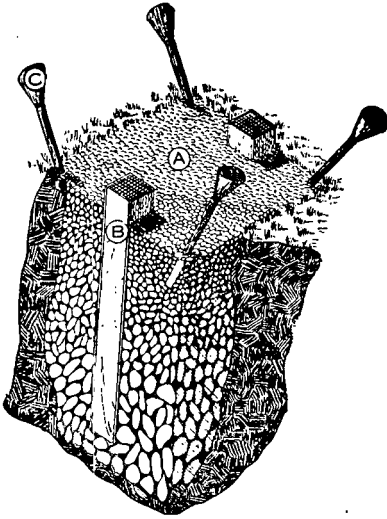

FIGURE 16.—Urine soakage pit.

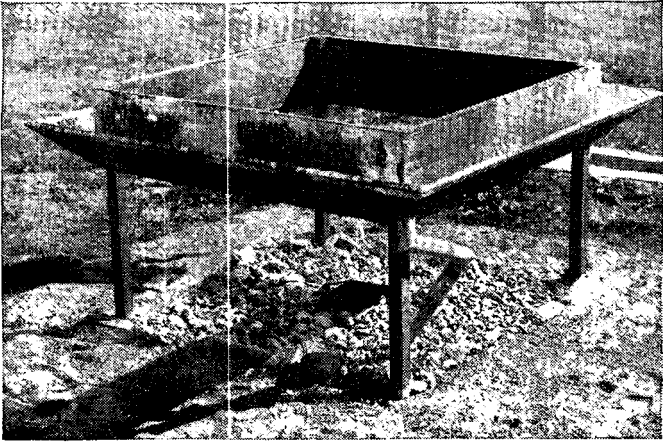

FIGURE 17.—Urinal and urine soakage pit.

and keeping the pit surface free from debris, oil, or any substance which might clog it. The soakage pit may receive urine from a trough urinal located within the latrine enclosure, the pit itself being outside the enclosure. Urine pipes or spaces at a urine trough should be provided at the rate of 5 per 100 men. A soakage pit should serve 200 men indefinitely. When it is closed, the pipes should be removed and the pit covered with dirt and sod.

■ 26. NIGHT URINAL CANS.—If the distance to the latrines is considerable, a large can or pail with 1 inch of 2 percent cresol solution should be placed at the end of each company street at night, for use as a urinal. Each morning the contents of the cans should be poured into the latrines or soakage pits, and the can should then be washed.

■ 27. DISPOSAL OF WASH WATER AND BATH WASTE.—See paragraphs 29 and 110.

■ 28. ANIMAL WASTES.—*a. General.*—Horse manure is an ideal breeding place for flies. Thus, proper disposal of manure is an important feature in field sanitation. The amount of manure to be disposed of averages 10 pounds per animal per day if animals are on a picket line, and 25 pounds if the animals are kept in stables.

*b. Care of picket lines.*—Picket lines should be thoroughly swept each morning and the manure removed for disposal. The area about the picket lines should be firmly tamped and sprayed with crude oil at least twice a week.

*c. Disposal by drying.*—In a locality which is consistently dry, manure from picket lines may be scattered and dried in the sunlight. The manure is spread 1 to 2 inches thick and should be raked over daily for from 4 to 7 days. When thoroughly dry, the manure may be removed and either burned or used to fill low areas. An area about 25 feet square is needed to dry the manure produced by 100 animals in 1 day.

*d. Disposal by gift or sale.*—The more commonly used methods of disposal are either by sale or gift to civilians, or disposal by composting. If disposal is by sale or gift, care must be taken that the manure is properly collected

and transported, and that it is finally disposed of far enough away from the camp that a fly menace will not occur. This method is satisfactory in any type of camp if properly supervised.

*e. Composting.*—Disposal by composting is recommended in semipermanent camps. (Par. 35 b.)

*f. Burning.*—In temporary camps manure may be disposed of by burning, but enormous amounts of wood and oil are required unless the manure is thoroughly dried beforehand. This method is impracticable in a wet climate.

■ 29. DISPOSAL OF KITCHEN WASTES.—*a. General.*—Kitchen wastes consist of the food remnants accumulated after meals and in the preparation thereof, as well as the water in which kitchen utensils and mess gear have been washed. The amount of kitchen wastes varies considerably, especially the liquid portion. However, the solids average about  $\frac{1}{2}$  pound per person per day and the liquids average 200 to 1,000 gallons per company of 200 men per day. These wastes must be disposed of to prevent giving rise to offensive odors and attracting flies and rats to the mess area. Solid kitchen wastes may be disposed of relatively easily, but the disposal of liquids becomes increasingly difficult as larger quantities of water are used. For camps of short duration, 1 night to a few days, both liquids and solids may be disposed of by burial, either in deep pits or in trenches about 2 feet deep. At least 1 foot of earth should be refilled over the garbage. The scattering of lime over garbage is of no practical value.

*b. Disposal of garbage.*—Garbage is often disposed of by sale or gift to civilians to be used as food for hogs, and it may be used on military reservations for the same purpose. Its disposal by sale or gift to civilians may lead to insanitary conditions about a camp through spilling in transfer from garbage cans to other containers, leakage of containers, failure of collection, or unsatisfactory cleaning of cans. When thorough cooperation with the contractor can be maintained so as to insure cleanliness in the procedure, there is no objection to this method of disposal. However, the site of final disposition should be far enough removed from the camp that odors and flies will not become a nuisance in the camp area. Garbage should not be transferred from one

container to another within the camp area. When garbage is to be used as food for swine, it is necessary to separate it into edible and nonedible portions, the latter being disposed of by incineration. Except when it is disposed of by burial, it is necessary that garbage be separated into liquid and solid portions by passing it through a strainer.

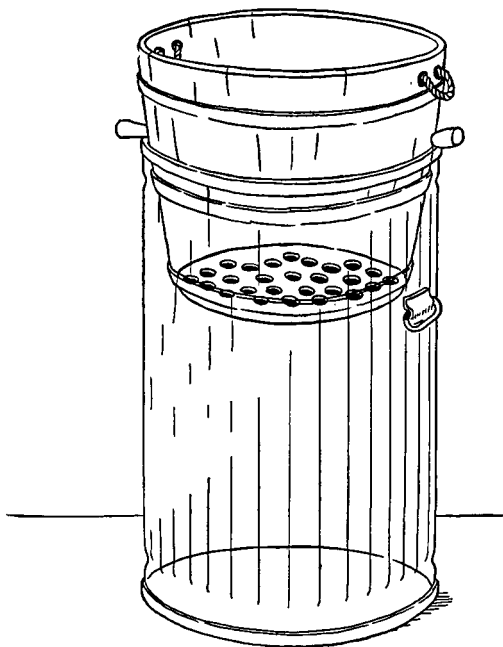

FIGURE 18.—Garbage drainer.

■ 30. SOAKAGE PITS AND TRENCHES.—*a. Soakage pits.*—Liquid kitchen wastes in amounts not in excess of 200 gallons per day are best disposed of by a soakage pit similar in construction to a urine soakage pit. A hole 4 feet deep and 4 feet square is filled with broken rock, varying in size from about 3 inches in diameter at the bottom of the pit to 1 inch at the top. Tin cans or broken bottles may be substituted

for the broken rock. Ventilating shafts similar to those in the urine soakage pit are advisable but not essential. A grease trap is necessary in conjunction with a soakage pit as grease, if not removed from the liquid waste, will soon clog the soakage pit. Two such pits should be constructed for each kitchen if the camp is to last several weeks. A daily rest period of several hours will increase the efficiency of soakage pits. If two pits are available, they should be used on alternate days. In camps of long duration each

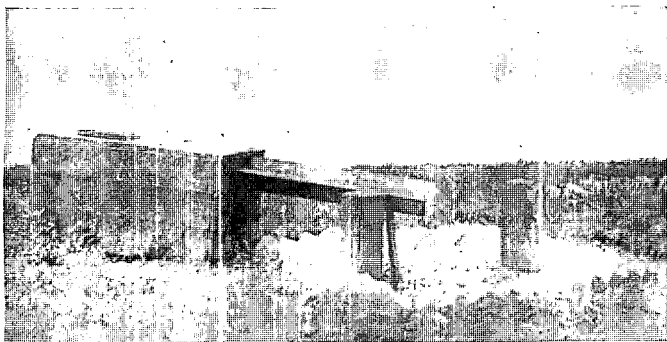

FIGURE 19.—Box grease trap with outlet trough.

soakage pit should be given a rest period of 1 week every month. If, in spite of these precautions, the pit becomes clogged with organic material, the application of 5 gallons of 10 percent solution of either calcium hypochlorite or caustic soda may clear it. It is desirable to locate soakage pits near to the kitchen if suitable soil can be found there. If not, they must be located where satisfactory drainage can be secured.

*b. Soakage trenches.*—If the ground water level or a rock stratum is encountered near the surface of the ground, a soakage trench may be substituted for the soakage pit. This trench consists of a central pit 2 feet square and 1 foot deep, from each corner of which a trench radiates outward for a distance of 6 feet. These radiating trenches are 1 foot wide and vary in depth from 1 foot where they leave the

central pit to 18 inches at the outer end. The central pit and the radiating trenches are filled with broken rock. A grease trap must be employed in conjunction with this trench.

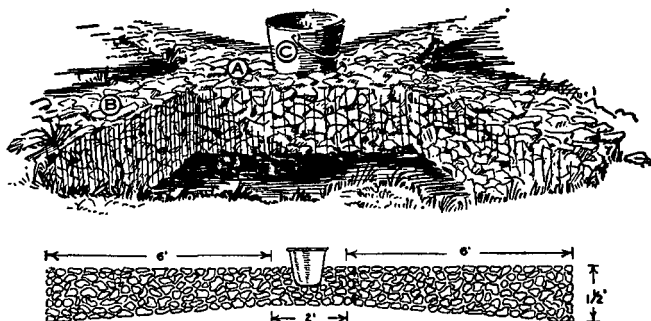

FIGURE 20.—Soakage trench. A—Central square area. B—Radiating lateral trenches. C—Pail grease trap.

*c. Soakage pit under field range.*—Another optional method is to construct a soakage pit under the firebox of a field range. Liquids are thus disposed of by evaporation as well as by soakage.

*d. Sullage pit.*—Attempts to dispose of liquid wastes by merely digging a deep hole in the ground into which liquids are poured will meet with little success. Filling with rock or similar material is necessary to secure efficient operation of a soakage pit.

■ 31. GREASE TRAPS.—*a. General.*—The water before being placed in the soakage pit must be passed through a grease trap to remove food particles and as much grease as possible; otherwise, the side walls of the pit will soon become coated with grease and debris and the leaching of water into the soil is prevented.

*b. Baffle grease trap.*—(1) The baffle grease trap is made of a half barrel or a box divided into unequal chambers by a wooden baffle extending to within 1 inch of the bottom, the larger chamber, two-thirds of the barrel, being the influent and the smaller, the effluent chamber. The trap is provided

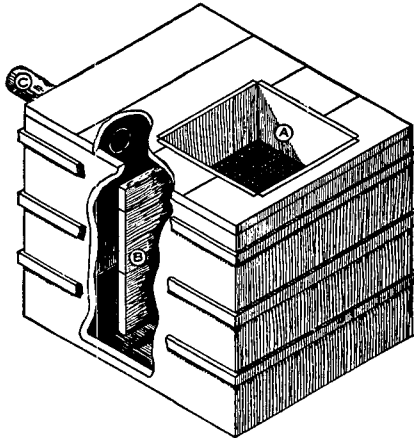

FIGURE 21.—Baffle grease trap. A—Strainer. B—Baffle. C—Outlet.

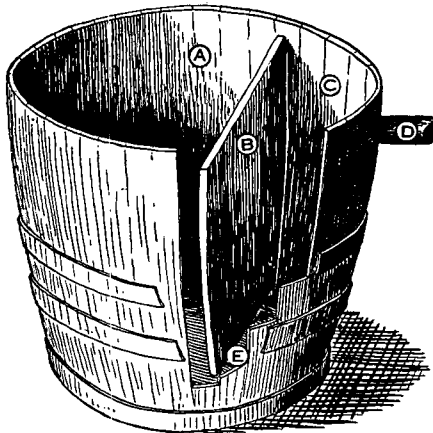

FIGURE 22.—Baffle grease trap made of a half barrel. A—Influent chamber into which the greasy fluid is emptied. B—Baffle. C—Effluent chamber. D—Outlet pipe. E—Space under baffle leading from the influent chamber to the effluent chamber.

with a hinged removable lid. A metal strainer 8 inches square and 6 inches deep, the bottom of which contains many perforations and which is filled with straw to prevent the coarser solids from entering the trap is inserted into the lid of the influent chamber. The strainer is made removable to facilitate cleaning. A 1-inch pipe is inserted in the upper third

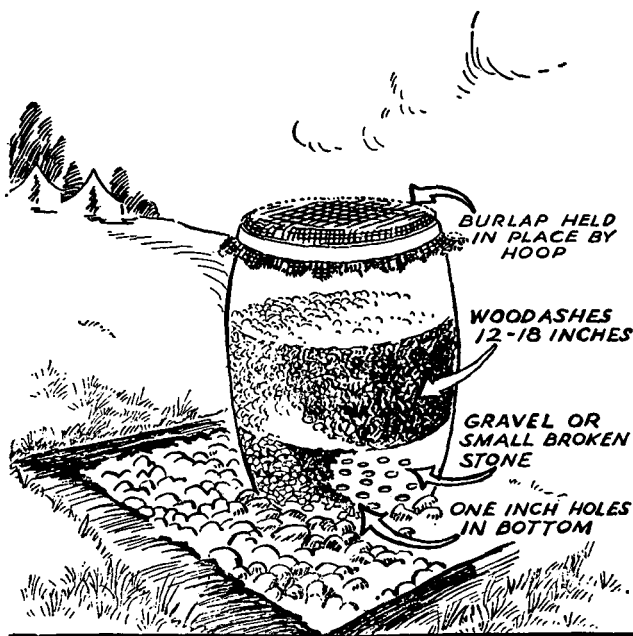

FIGURE 23.—Ash barrel grease trap.

of the effluent chamber leading to a V-shaped trough which carries the effluent to the soakage pit. In operating the trap, both chambers are filled with cool water. When the warm liquid waste meets the cool water in the influent chamber, the grease congeals and rises to the surface and is prevented by the baffle board from reaching the outlet to the soakage pit.



(2) Meticulous attention is necessary in order to prevent such a trap from becoming a nuisance. The trap should be drained daily, the sediment removed and burned, and the

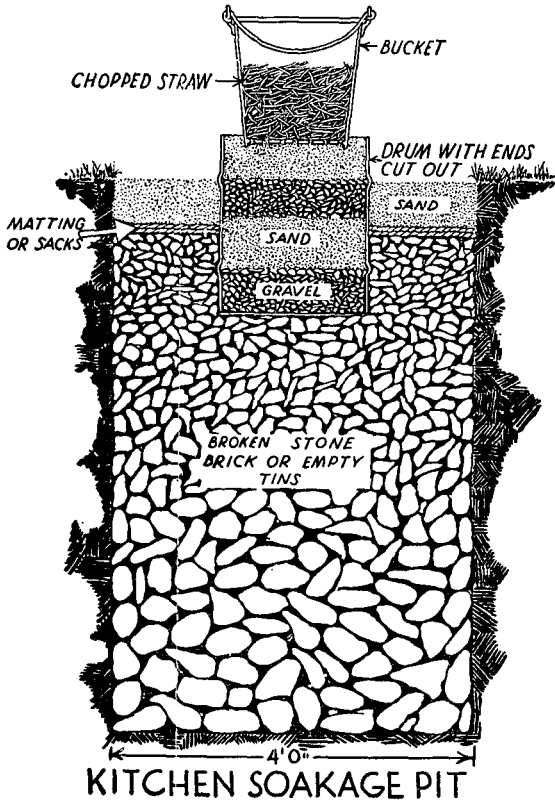

FIGURE 24.—Pail grease trap.

trap including the removable strainer thoroughly cleaned with soap and water.

*c. Ash barrel grease trap.*—An ash barrel grease trap is prepared by taking a barrel of 30- to 50-gallon capacity and

boring thirty 1-inch holes in the bottom. Place about 8 inches of gravel or small stones in the bottom, and over this place 16 inches of wood ashes. Fasten a piece of burlap over the open end of the barrel as a strainer. This trap may be placed either directly on a soakage pit or on a platform with a drainage pipe or trough to the pit. It is necessary to empty this type of grease trap, wash or throw away the ashes, and refill with ashes at least every 2 days. The burlap covering should be washed or renewed each day. This type of trap is generally less satisfactory than a baffle grease trap.

*d. Pail grease trap.*—An old metal pail or can with perforations in the bottom, filled with hay, grass, straw, or an old blanket, will remove food particles and part of the grease from liquid wastes. However, much of the grease will pass through. This type of trap should never be used except while waiting for a better grease trap to be constructed.

■ 32. INCINERATORS.—*a. General.*—In bivouacs solid wastes are generally disposed of by burial in shallow trenches. These trenches should be dug 1 foot wide and 2 feet deep.

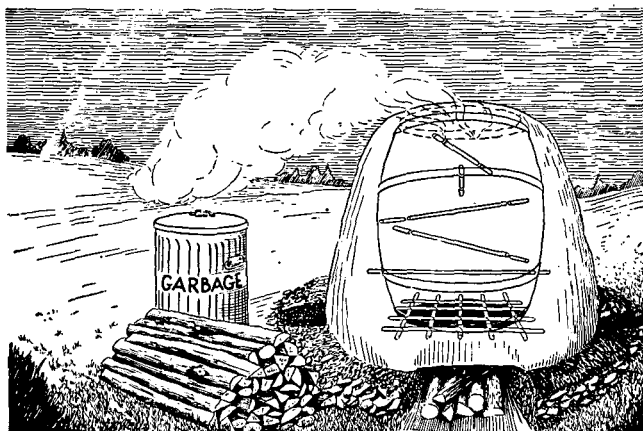

FIGURE 25.—Barrel and trench garbage incinerator.

In temporary camps solid wastes are best disposed of by incineration by individual companies. In semipermanent camps common incineration for several or all units may be desirable.

*b. Cross trench incinerator.*—(1) The cross trench incinerator is the most satisfactory company incinerator. It is constructed by digging two trenches, each 8 feet long, 1 foot wide, and 1 foot deep, crossing at their centers. A grate of pieces of scrap iron is constructed over the intersection of the two trenches. Over the grate is erected a stack which may be constructed in many ways. The simplest stack is an old galvanized iron can, the bottom of which has been removed. Such an incinerator is satisfactory for camps of less than a month duration. Cross trench incinerators work better when three of the trenches are closed off, leaving the one open toward the direction from which the wind is blowing. Properly fitted pieces of tin may be used to temporarily block off the trenches. The incinerator should be stoked from the top only, the rubbish, flattened cans, and wood mixed with the drained garbage acting as fuel. It is also necessary to keep the burning mass loosened. The fire is built on the grate.

(2) A more efficient incinerator may be constructed on the same principle but using stone or bricks instead of the galvanized can and plastering puddled mud or clay on the outside.

(3) A still better incinerator stack may be built by setting a wooden barrel, both ends of which have been removed, over the grate and covering the outside of the barrel with several inches of puddled clay. A slow fire is kept under the barrel for several hours to bake the clay. Then a brisk fire is built to burn out the barrel and the incinerator is ready for use. Carefully built, such an incinerator will last for several weeks.

*c. Rock pit incinerator.*—The simple rock pit incinerator commonly used in the past is very inefficient and extravagant of fuel. Its use is never advisable.

*d. Inclined plane incinerator.*—(1) The inclined plane incinerator is the most efficient of the smaller improvised incinerators for use in semipermanent camps. Its capacity is suitable either for a company or for a battalion. In such an

incinerator the garbage is fed into the upper end of an incline and is gradually pushed down to the lower end, drying and burning as it progresses, final combustion taking place on

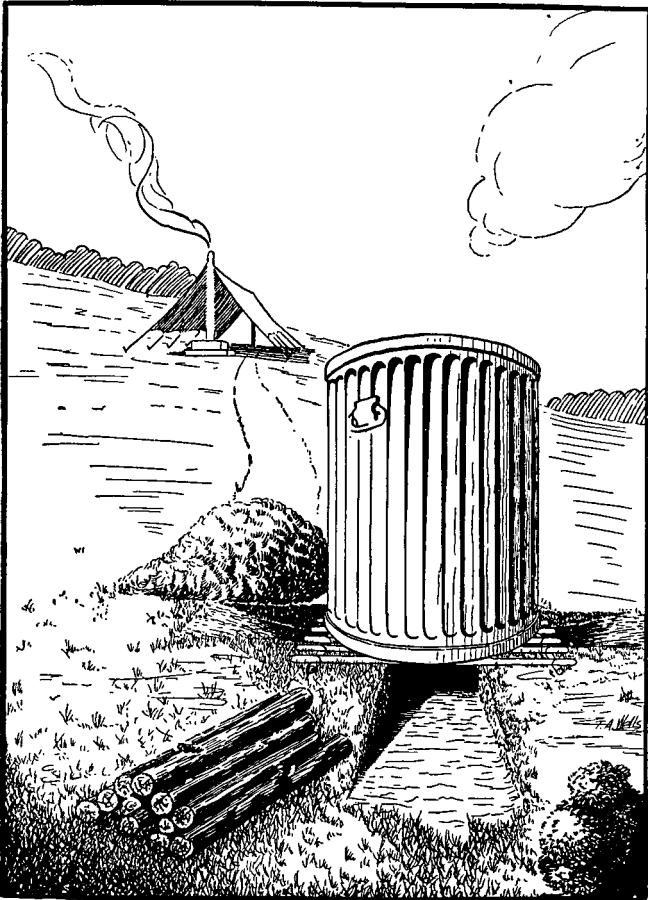

FIGURE 26.—Cross trench incinerator with stack made from galvanized iron garbage can the bottom of which has been removed.

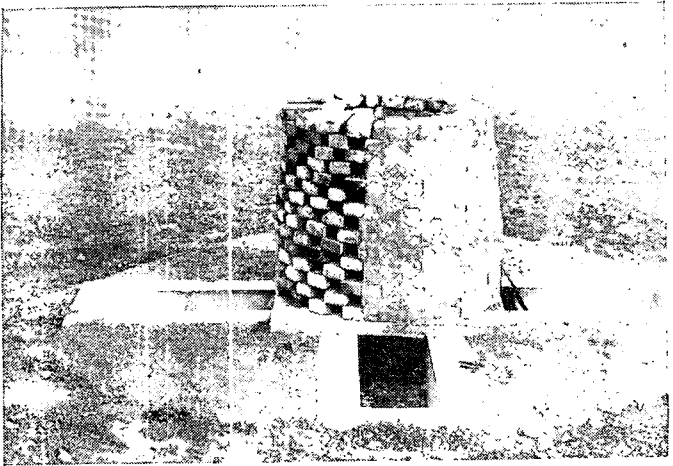

FIGURE 27.—Barrel and trench incinerator.

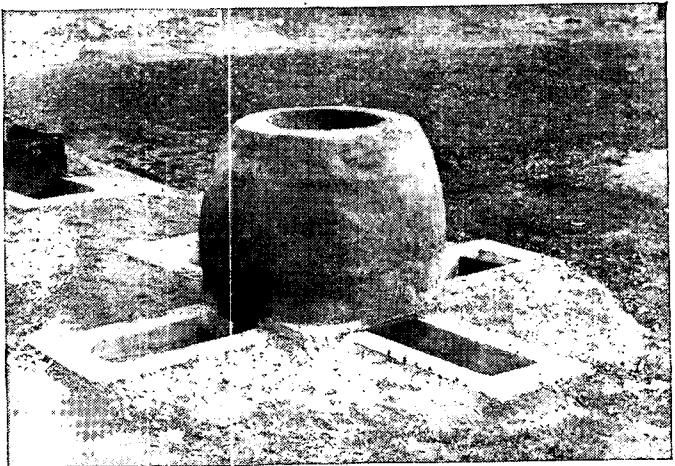

FIGURE 28.—Barrel and trench incinerator with the barrel made of packed clay molded over a wooden barrel.

a grate at the lower end. The incline is closed over so as to retain the heat and direct it onto the mass of drying garbage. In the incinerator shown in figure 30, the incline is made of corrugated iron resting upon a rock bed and the incline is covered over with portions of steel oil drums. There is a loading and stoking area at the rear and a grate area at the front. The stoking area is closed over with a hinged iron cover, a vent 5 by 16 inches for draft being left at the outlet of the incline, and the grate covered with a door which may be opened as desired for draft.

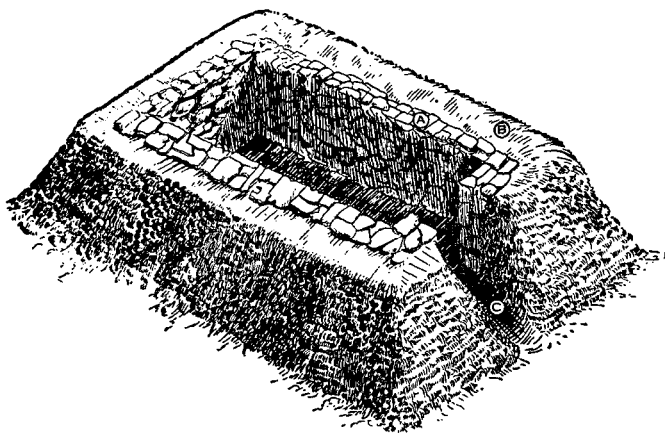

FIGURE 29.—Rock pit incinerator (schematic). *A*—Rock wall. *B*—Earthen embankment to support rock walls. *C*—Open end to permit draft.

(2) The walls of the incinerator may be laid up with stone, brick, or concrete. Sections of two oil drums are used to form the cover, the drums being cut longitudinally 4 inches above the center and the smaller sections used, the ends being left in place. These sections are placed end to end, supported on the side walls 8 inches above the inclined floor. Puddled clay to a depth of 2 inches is placed over the top of the drums.

(3) In use, a fire of wood and rubbish is built on the grate, and, after the incinerator has become hot, a canful of drained garbage is emptied onto the stoking area, some being pushed part way down the incline. As the garbage dries on the incline it is pushed farther down until it burns, being replaced by

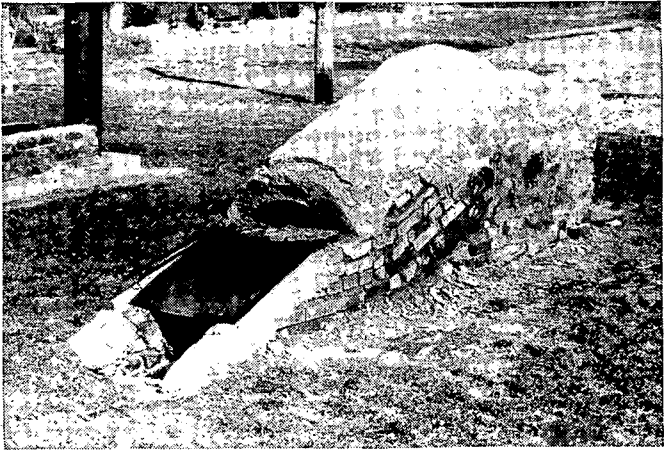

FIGURE 30.—Incline plane incinerator.



FIGURE 31.—Incline plane incinerator, side view.



FIGURE 32.—Rock pile incinerator.

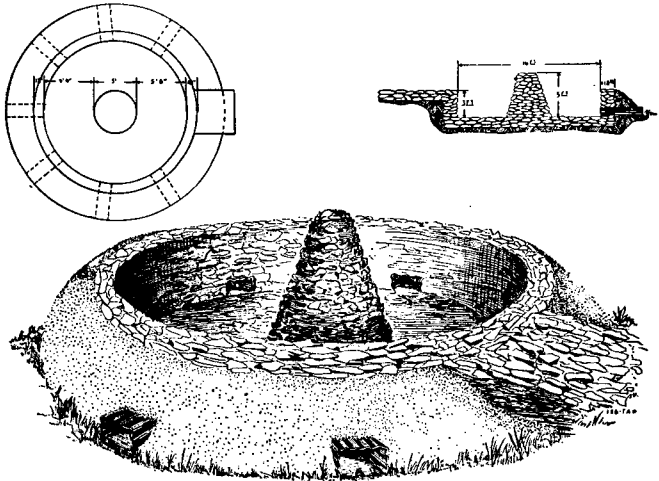

FIGURE 33.—Rock pile incinerator showing draft holes at the junction of the wall and bottom of the pit.



other garbage from the stoking area. The cover over the stoking area serves to retain heat, so that considerable drying and even burning takes place. The ends of the sections of oil drums serve as baffles which give rise to swirling of the burning gases and apparently aid greatly in the drying and combustion.

*e. Rock pile incinerator.*—The rock pile incinerator may be employed for the disposal of the garbage of organizations up to the size of an infantry regiment. It is very extravagant of fuel but is relatively simple of construction. It consists of a circular pit in the center of which is a cone to divert the air currents upward and thus create a draft. The wall, bottom, and cone are made of loose rock. The pit is about 16 feet in diameter and 24 to 30 inches in depth. The floor and walls should be 12 to 18 inches thick. The draft may be improved by installing draft holes at the junction of the wall and bottom of the pit. The fire is built about the base of the cone. Garbage is placed between the fire and the side wall and, after partial drying, is gradually pushed onto the fire. This incinerator requires on the average about 1 cord of wood to burn 2 tons of garbage.

*f. Closed and semiclosed incinerators.*—In camps of several months' duration incineration in large central incinerators is often advisable. These are much more elaborate in construction than those described above. Closed or semiclosed types are usually constructed. These are the responsibility of the Quartermaster Corps or the Corps of Engineers. Details of their construction may be found in FM 8-40 and Army Medical Bulletin No. 23.

*g. Burning of tin cans.*—Tin cans or similar noninflammable kitchen wastes should be burned out thoroughly in incinerators, pounded flat, and then disposed of either by burial or on a dump.

■ 33. RUBBISH.—Accumulations of rubbish attract flies and rats, which in turn act as the transmitting agents of certain diseases to which man is susceptible. All rubbish, not garbage, should be collected daily in containers such as gunny sacks which are placed on poles at both ends of the company street and in latrines. It should then be transferred to com-

pany incinerators and burned. In semipermanent camps it may be disposed of on a dump, being burned there daily. Care should be taken that no unflattened tin cans or boxes remain on the dump to permit accumulation of water with the resulting possibility of mosquito breeding. Dumps should preferably be located several hundred yards from the tents occupied by troops.

## SECTION V

### FLY CONTROL

■ 34. GENERAL.—*a. Importance.*—Flies, especially the ordinary housefly, frequently transmit intestinal diseases. This transmission is accomplished in a mechanical manner. If the fly has access to human excreta it collects small amounts of excreta on its legs and body and in its digestive tract. If it later has access to food or eating utensils, some of the excreta is deposited on the food by defecation, regurgitation, and contact of food with the legs and body of the fly.

*b. Development and characteristics.*—(1) A brief description of the development of the housefly and some of its characteristics are essential to the understanding of the control procedures recommended. In its development the fly passes through four stages—the egg, the larva, the pupa, and the adult. The eggs are oval, white, glistening bodies about  $\frac{1}{20}$  inch in length. They are deposited by the adult female in masses of 150–200 in warm, moist organic materials, preferably horse manure. The egg stage lasts about 12 hours, varying considerably with the temperature. The larvae (maggots) are cylindrical, whitish, segmented, wormlike creatures about  $\frac{1}{3}$  inch in length. They are very motile and feed upon the surrounding organic material, reaching maturity in 2 to 8 days. When mature the larvae migrate to a dry cool place and pupate. The larvae are quickly killed by a temperature of 115° F. The pupa is dark brown in color, has a hardened outer surface, and is about  $\frac{1}{4}$  inch in length. The stage lasts 2–8 days. The adult fly emerges from the pupal case and is ready to fly as soon as its wings harden. The female reaches sexual maturity and begins to deposit eggs in 3 to 20 days after emerging from the pupal case. Under favorable conditions the period from the egg to adult may be as short as 1 week.

Thus material in which the immature forms develop may produce flies if neglected for longer than 1 week.

(2) The characteristics of the fly which are important in its control include—

(a) Their breeding places of choice, which are horse manure, human excreta, and fermenting vegetable wastes.

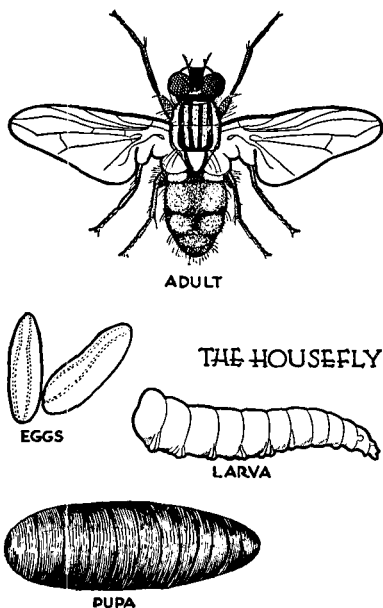

FIGURE 34.—Housefly; stages in development.

(b) The necessity of moisture, warmth, and soluble food for the development of the larvae.

(c) The fact that temperatures of 115° F. or above will kill the eggs and larvae.

(d) The tendency of the larvae to migrate from the breeding material prior to pupation.

(e) The ability of the larva and adult to crawl through loose manure or earth.

- (f) The attraction of adult flies to food by odor.
- (g) Their tendency to go toward light.
- (h) Their tendency to rest on vertical surfaces and hanging objects.
- (i) The optimum for breeding is 80-95° F.
- (j) The range of flight is 200-1,000 yards.
- (k) The number is greatest in the late summer and early fall.
- (l) Continuous breeding may occur during the winter in heated buildings.

■ 35. CONTROL MEASURES.—*a. General.*—The control of flies depends upon a knowledge of the characteristics enumerated above and the necessary measures to render the customary breeding places unfavorable for breeding, to kill the larvae by use of larvicides, to kill the adult flies, to dispose of human excreta in such a manner (pars. 22 to 26, inclusive) that it will be inaccessible to flies, and to protect food from flies. Prevention of fly breeding is the most effective part of a fly control campaign. Constant vigilance is necessary.

*b. Control of breeding places.*—The control of breeding places is essentially the problem of the proper disposal of horse manure, human excreta, and garbage. The disposal of horse manure in temporary camps is considered in paragraph 28, and its disposal in semipermanent camps may be accomplished by *composting*, which is the close packing of manure on a platform. In properly composted manure a temperature of 140-160° F. is reached at a depth of 1 foot below the surface; such a temperature will quickly kill the fly egg and larva. By the use of larvicides the fly larvae on the surface can be destroyed. Figures 35 and 36 illustrate the proper construction of a compost platform. The compost pile should be located over 1,000 yards from the camp and where it will not be an unsightly nuisance. A compost platform is constructed by leveling off an area of ground 50 feet long and 20 feet wide, digging a trench around the area 12 inches wide and 12 inches deep with vertical sides, and constructing a second trench, very shallow, not over 3 inches deep and 4 inches wide, located just within the edge of the platform. The manure is placed on the platform as follows: Beginning

at one corner, place the manure on an area  $3\frac{1}{2}$  feet long and 10 feet wide, piling it to a height of 4 to 5 feet, packing it down very tightly, and dressing the sides neatly. The sides must at



FIGURE 35.—Manure compost pile with ditches for the control of migrating larvae.

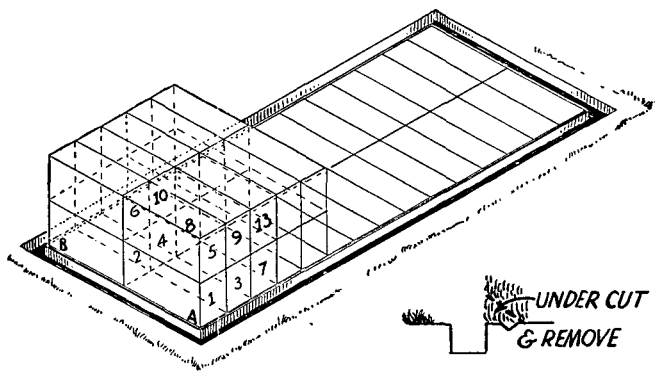

FIGURE 36.—Compost pile. Scheme for placing manure on pile. Numbered spaces each represent 1 day's accumulation of manure.

all times be kept vertical. The second day's supply of manure is placed on the adjacent corner in a similar manner. On the third day the supply of manure is placed immediately adjacent to the first pile and on the fourth day, adjacent to the second pile, and on the fifth day the supply is piled on top of the first pile. The manure is thus placed on the platform in the succeeding small sections as shown in the diagram. This is done for the purpose of confining the fly breeding to the smallest possible area. The manure should be kept moist so as to promote decomposition. The sides of the pile should be sprayed daily with a mixture of cresol, kerosene, and fuel oil. Crude oil or a light road oil is used in the trenches, the earth in the trench being kept visibly moist with oil. In the preparation of the platform all vegetation should be removed for a distance of 2 feet from the edges, the earth here tamped down firmly and oiled thoroughly; similarly, the earth beyond the trenches should be freed from vegetation, packed down, and oiled. The trenches are to be kept clean at all times. A platform this size should care for the manure of 100 animals for 2 months.

c. *Larvicides*.—Larvicides are used chiefly in connection with compost piles and latrines. The following larvicides are effective in destroying fly larvae and are listed in order of efficiency:

- |                      |           |
|----------------------|-----------|
| (1) Cresol .....     | 2 parts.  |
| Kerosene.....        | 20 parts. |
| Fuel oil.....        | 78 parts. |
| (2) Cresol .....     | 2 parts.  |
| Soap suds.....       | 98 parts. |
| (3) Waste motor oil. |           |
| (4) Crude oil.       |           |

The above larvicides have the disadvantage that they render the compost somewhat unsatisfactory as fertilizer. The following larvicide, while not rapid in action, is very efficient and has the added advantage that it does not render the compost unsatisfactory for fertilizer:

Commercial sodium arsenite.....	4 pounds.
Molasses.....	2 quarts.
Water.....	50 gallons.

*d. Destruction of adult flies.*—(1) *Swatting.*—Swatting is one of the essential methods of destruction of flies which have entered a screened building. It is, however, labor consuming.

(2) *Poisons.*—Poisons are easy to use and effective. Formaldehyde and sodium salicylate are efficient fly poisons. The formulas for preparing them are—

- (a) Commercial formalin ..... 2 parts.  
Milk or sweetened water or milk and 50  
percent lime water ..... 98 parts.
- (b) Sodium salicylate ..... 1 part.  
Sweetened water (1 teaspoonful brown  
sugar to 1 pint water) ..... 100 parts.

A satisfactory method of using poisons is to fill a drinking glass  $\frac{2}{3}$  full of the solution, place over the top of the tumbler a circular piece of blotting paper the diameter of which is 2 inches more than the diameter of the tumbler, and cover with an inverted saucer. The whole apparatus is then inverted and a match is inserted under the edge of the glass. The liquids seep out, keeping the blotting paper moist.

(3) *Fly sprays.*—Fly sprays are useful in mess halls, especially when applied to groups of flies on the wall. The standard quartermaster insecticide is satisfactory for this purpose. Another satisfactory spray may be made as follows: Soak 1 pound of crude pyrethrum powder in 1 gallon of kerosene for 2 or 3 days. Then pour off the fluid for use as a spray.

(4) *Flypaper and wire.*—Flypaper and wire are very useful when hung from the ceiling of mess halls. Commercial types are of course easiest to use but satisfactory ones can be made. The mucilage on the wire or paper is prepared by heating (without boiling) together one part by weight of castor oil and two parts white rosin. The wire used consists of ordinary bailing wire, several 18- to 36-inch pieces being twisted together and coated with the mucilage by dipping the wire into the mucilage container. The flypaper consists essentially of narrow strips of paper, wrapping or glazed,

18 to 36 inches in length, each side of which is coated with fly mucilage. When they have become covered with flies the wires are wiped with a cloth to remove the flies and mucilage and are recoated. The used paper is burned.

(5) *Fly traps.*—(a) *General.*—Fly traps are the most valuable means for destruction of adult flies in camps. Many types are used but all consist of two main parts—the bait chamber and the trap chamber. The former is the lower and darker part into which the flies are attracted by the odor of the bait. The upper and lighter part is the trap chamber and is connected with the bait chamber by a small opening through which the flies crawl toward the light after having fed on the bait. The construction of fly traps is simple.

(b) *Square traps.*—A square fly trap such as shown in figure 37 is made 12 to 18 inches square and 18 to 24 inches high. The corner uprights and connecting lateral strips are made of boards 1 inch thick and  $1\frac{1}{2}$  inches wide. The framework is covered with No. 14 mesh wire screening tacked to the corners and connecting strips. The lid is a screen frame which fits down over the top. The bait chamber is inside the trap and is made of screening tacked to the edges of the lower lateral strips and terminating in an apex 10 to 14 inches above the bottom of the trap. At the apex is a  $\frac{1}{4}$ -inch hole through which the flies enter the upper chamber. The corner uprights extend 1 inch below the lower edge of the trap to form the supports for the traps.

A box fly trap is made essentially as above except the sides are made of wood. It is constructed as follows: Make a closely fitting top for an ordinary packing box 12 by 18 by 11 inches, and cover with screen. Cut a 6- to 8-inch hole in the bottom of the box, over which a wire cone about 10 inches high with a  $\frac{1}{4}$ -inch hole at the top is tacked. The corners are raised from the ground by 1-inch blocks.

(c) *Triangular traps.*—A triangular fly trap such as shown in figure 39 is the most satisfactory for use in camps because of its simple and durable construction, but it is less efficient than the square trap. They should be about 18 inches long and 12 inches high. A hole 1 to 2 inches in diameter, covered



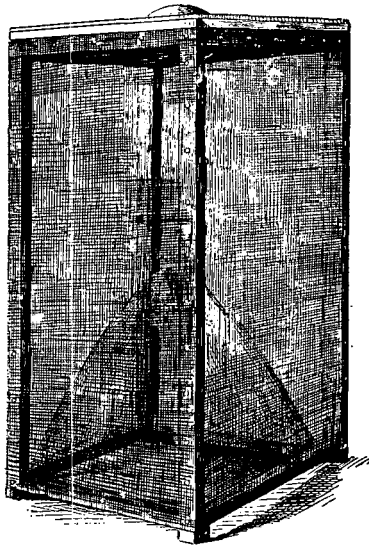

FIGURE 37.—Square fly trap with removable top and pyramidal bait chamber.

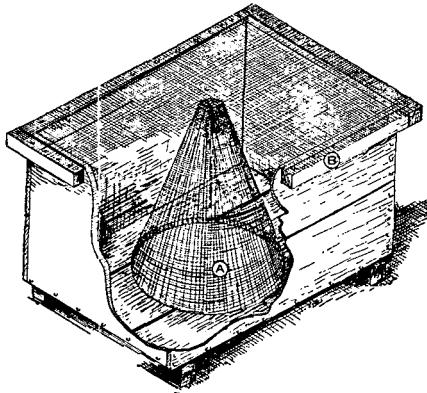

FIGURE 38.—Fly trap constructed of packing box. Corner cut away to show method of installing cone.

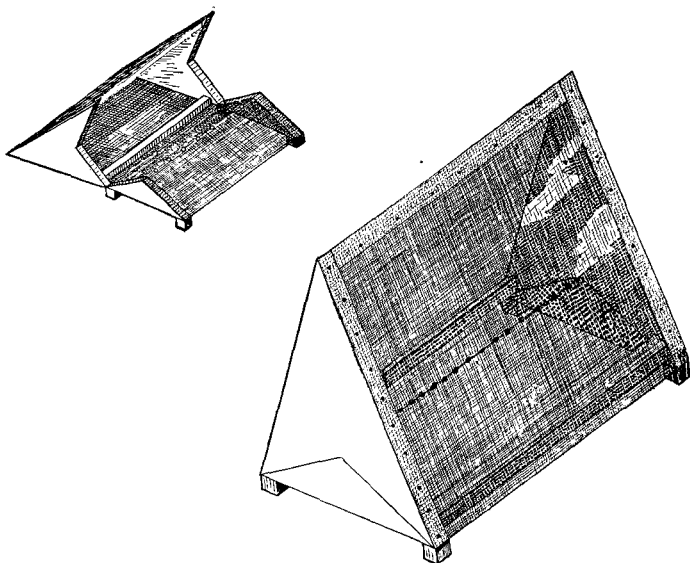

FIGURE 39.—Triangular fly trap with cone-shaped bait chamber. Single opening at apex of cone leading into trap chamber. The small tin disk covers an opening through which flies may be removed from the trap chamber.

by a tin flap, is cut in one end of the trap for the removal of dead flies.

(d) *Pail fly trap*.—A trap may be constructed from an old 3- to 5-gallon metal bucket. The bottom of the bucket is cut out except for 1 inch around its outer border, to which a wire cone is soldered. A top is made which fits down into the bucket a distance of 1 inch and is screened except for 1 inch of metal around the outer border. The top is held in place by three pieces of copper soldered to the outer side of the bucket so that they may be bent over the cover. The bucket is supported by three pieces of metal 1 inch high.

(e) *Fly baits*.—A satisfactory bait must have an odor attractive to flies, and in turn not be offensive in appearance

or odor to people in the vicinity. Fermented baits are generally very satisfactory. The best fermented bait is—

Cornmeal.....	1 pound
Molasses.....	½ pint
Water.....	1 quart
Yeast.....	¼ ounce

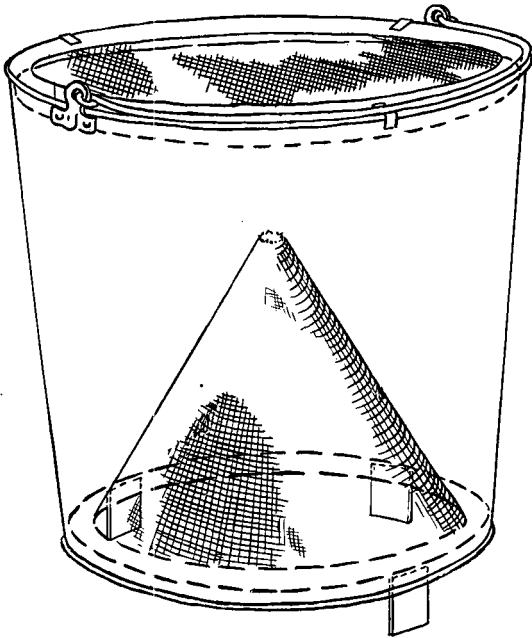

FIGURE 40.—Fly trap, showing method of construction, using ordinary metal bucket.

Mix the water and molasses and heat to boiling. Stir in the cornmeal and allow the mixture to cool. Then add the yeast and allow to stand in a warm place 1 or 2 days. It is then ready to use.

Other fermented baits are two parts molasses and one part vinegar, crushed over-ripe bananas in milk, brown sugar, and sour milk.

(f) *Location of fly traps.*—Traps in sufficient number should be located near manure piles, latrines, in vicinity of kitchens, mess halls, dumps, and other buildings or areas where flies congregate. They are more efficient if placed in

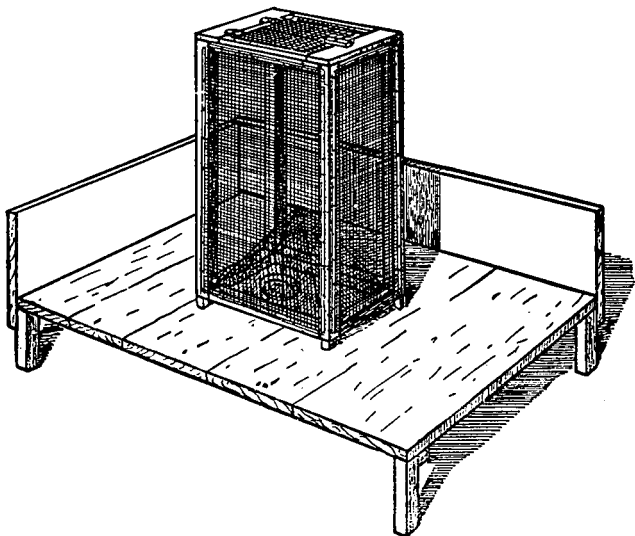

FIGURE 41.—Square fly trap with board windshield to protect the trap from the wind.

groups of two or three. Traps should be protected from the wind, and this may be done by utilizing a fly trap stand provided with a windshield. Also, traps may be placed behind objects such as buildings, boxes, and garbage cans which protect them from the wind. If placed on a stand the trap should be at least 12 inches away from the sides of the stand so as not to exclude the light from any side of the trap. Traps placed in dark corners or under shade are practically useless.

(g) *Care of fly traps.*—Liquid fly bait should be placed in wide shallow containers with at least 2 inches between the edges of the bait pan and the edges of the trap. The baits should be inspected daily, the containers kept filled to the desired level, cleaned and refilled whenever a scum forms or sediment accumulates, and should be kept free from dirt and dust. The traps should be emptied whenever a sufficient number of flies accumulate to interfere with the admission of light to the trap chamber. The captured flies may be killed by immersing the trap in soap suds. Practically constant attention is necessary if fly traps are to be effective in the control of flies. Necessary care includes not only cleaning and replenishing bait but also moving the traps about to conform to changes in wind and sunlight.

## SECTION VI

### MESS SANITATION

■ 36. **GENERAL.**—The company mess is a very potent factor in the transmission of intestinal diseases, and to a lesser degree, of respiratory diseases. Furthermore, the character of the mess has a decided influence on the morale, physical fitness, and natural resistance of the individual. The basic consideration of mess sanitation is cleanliness. The essential features in proper mess sanitation are inspection and supervision of food handlers; inspection, protection from dirt and flies, storage, and preparation of food; cleansing and protecting from dirt and flies of mess gear and kitchen utensils; control of flies; and exclusion from the vicinity of the mess of any factors which might result in the contamination of food.

■ 37. **FOOD HANDLERS.**—*a. Food handler examination.*—The personnel of a mess consists of both permanent food handlers and temporary kitchen police. The dividing line is not a sharp one, but as a working basis, mess sergeants, cooks, butchers, bakers, and mess orderlies assigned for duty in excess of 3 days should be considered permanent food handlers. Army Regulations require that such permanent food handlers be examined by a medical officer before beginning

duty in the mess, and each 6 months thereafter. The purpose of the examination is to detect cases or carriers of communicable diseases. Those individuals found to be free from communicable diseases will be so certified to the company commander by the examining medical officer. These certificates should be posted in a conspicuous place in the mess.

*b. Daily observation.*—Temporary kitchen police are not routinely required to have food handler examinations. However, it is vitally important that both the temporary kitchen police and the permanent food handlers be closely observed at all times for evidence of communicable diseases. This is a responsibility of company commanders. Any food handler temporary or permanent showing evidence of an illness, particularly of a cold or other respiratory disease, or of diarrhea or other intestinal disease, should be promptly relieved from duty.

*c. Cleanliness.*—It is equally important that all mess personnel wear clean clothing and have clean hands at all times. The fingernails should be cut short. The hands should be washed immediately after visiting the latrine. Convenient facilities for washing the hands must be provided. In addition to washing the hands in soap and water, rinsing in a 2 percent solution of cresol is a valuable precaution.

■ 38. INSPECTION OF FOOD.—*a.* All food should be inspected for freshness and quality when received at the mess and, if stored, again while in storage and before being prepared for consumption.

(1) Canned goods should be inspected for leakage and for gas formation within the can, as evidenced by swelling of the can. When a can is opened, the contents should be inspected for abnormal odor or color and, if found, the contents should be discarded.

(2) Fresh meats should be inspected for slimy deposits on the surface, or indications of decomposition in or near the joints or along the bones. The affected portions should be cut away and discarded. If this is not practicable, the proper Medical Department officer should be notified with the view of having it rejected.

b. Fresh meats, meat products, and canned foods are materials in which micro-organisms tend to grow steadily, and for this reason they may if contaminated be dangerous to the health of the troops. Spoiled meats and canned food products may produce serious illness due to organisms or to the poisons formed by the organisms growing therein.

c. The inspections outlined above are the responsibility of company commanders, and are in addition to previous inspections by representatives of the Medical Department and the Quartermaster Corps.

■ 39. STORAGE OF FOOD.—*a. General.*—Food supplies should be protected from insects such as flies and roaches, from dust and dirt, and from rats and mice. Perishable foods should

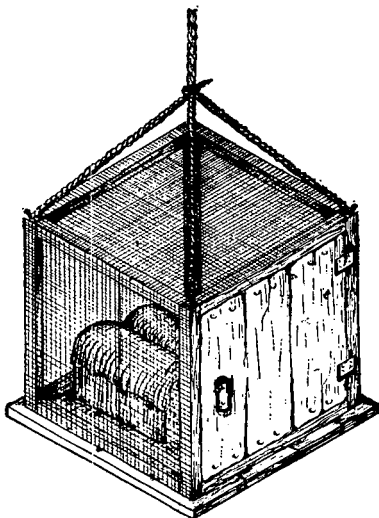

FIGURE 42.—Suspended food container.

be stored at a temperature that will inhibit the growth of molds and disease organisms. Refrigeration at a temperature of 55° F. or less is desirable for meat and dairy products and for some vegetables and fruits. An important point in the

storage of foods, particularly meat, is to avoid packing or hanging so closely that ventilation is impaired. Various devices may be improvised for the storage of food in temporary and semipermanent camps.

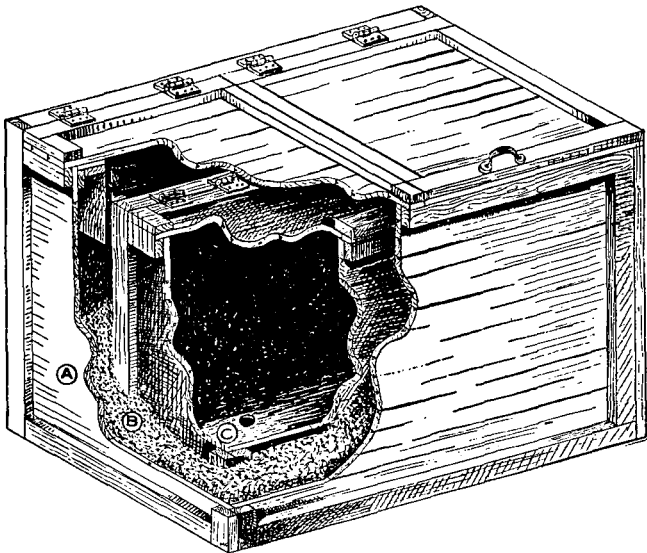

FIGURE 43.—Underground ice or cooling box. A—Outer wall. B—Insulating material. C—Inner wall.

*b. Storage in temporary camps.*—(1) In temporary camps food may be stored in watertight containers and immersed in springs or streams, care being taken to prevent contamination. Food may be buried below the surface of the ground where the temperature is lower, lining a pit with burlap, and placing boards on the bottom.

(2) A suspended food container consists of a screened box that permits free circulation of air but prevents contamination by insects. The cooling effect may be increased by wrapping the box in burlap which is kept damp. Fresh meat, bottled milk, and vegetables may be temporarily stored



in such a container. It should not be used where there is much dust in the air.

(3) The underground ice box or cooling box is a simple device consisting of a double-walled box. It is constructed by

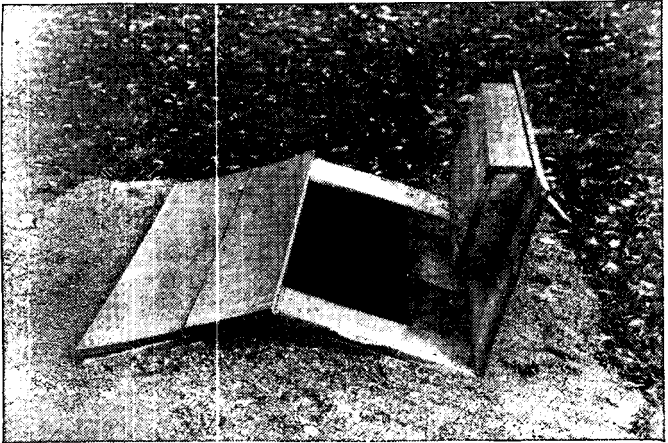

FIGURE 44.—Underground food box:

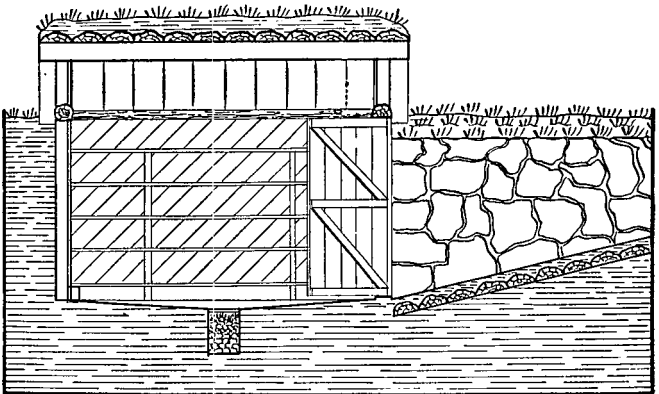

FIGURE 45.—Underground storeroom, longitudinal section.

placing a packing box within a large one, sunk into a pit in the ground so that the outer lid is slightly above the surface of the ground. A space 3 to 6 inches wide, filled with

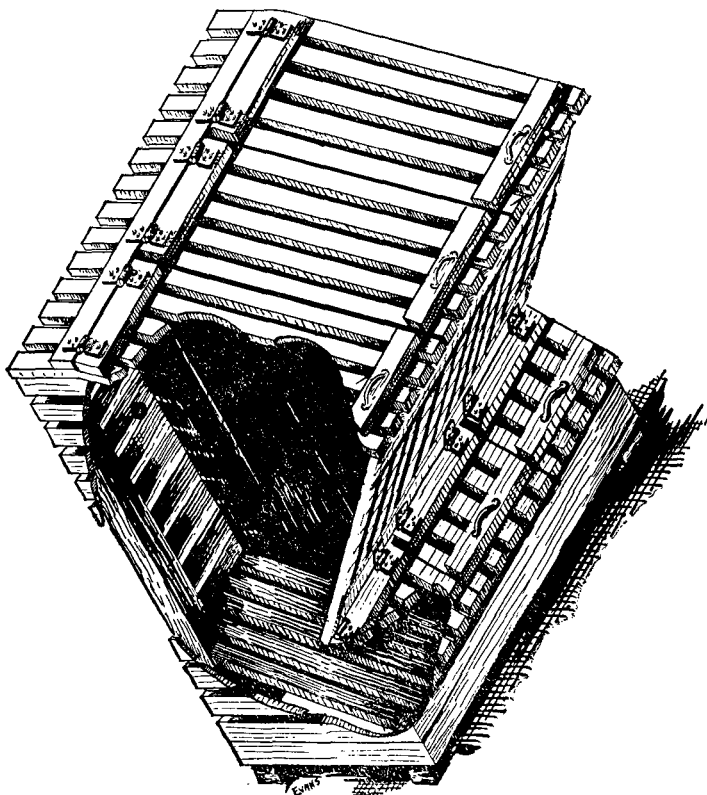

FIGURE 46.—Vegetable bin.

sawdust, grass, hay, or straw, separates the outer walls and the two bottoms. Two lids are necessary, one for the inner and one for the outer box. A drainage ditch should be dug around the box and a drain pipe should lead through the

bottom of the box to a small soakage pit below. A box 4 feet long, 3 feet wide, and 3 feet deep, inside measurements, has sufficient capacity for the average company mess. If ice is available, an ice compartment should be constructed at the end containing the drain pipe. Also the box may be used above ground as an ice box. The cooling effect is increased by dampening the packing material between the walls or wetting down the earth around the box. To facilitate cleaning, the inner box should be easily removable. Meat, milk, vegetables, or other perishable foods may be stored in such an ice or cooling box.

(4) In semipermanent camps fresh or cured meats, milk, and vegetables may be kept in underground storage rooms constructed similar to an old-fashioned root cellar. The floor consists of well tamped earth or boards. The walls should be boarded. Ventilation is secured by windows at the ends or an outlet through the roof. Vegetables should be kept in vegetable bins. The bins are made of spaced slats to permit the circulation of air. The bottom should slope sufficiently to permit the older vegetables to be used first.

(5) Bread boxes or storage cabinets should be well ventilated but screened to prevent access of flies to the food.

■ 40. PREPARATION OF FOOD.—*a.* If the mess is to fulfill to the best advantage its function in the promotion of physical fitness and the maintenance of morale, the menus must cater to the group appetite of the company and monotony must be avoided. This requires that the food be properly prepared and served and that attention be given to providing suitable variety.

*b.* Thorough cooking and immediate serving after cooking are the best safeguards against the transmission of communicable diseases by food, provided care is taken not to contaminate the food after cooking.

*c.* Disease-producing organisms will multiply rapidly in many cooked foods even when placed in the ordinary ice box. This is particularly true in the case of meat hash, sausage, fresh pork, veal, meat broth or soups, or dishes containing a preponderance of these materials. These foods should not be served as left-overs without adequate reheating.

*d.* All vegetables that are to be eaten raw, and which cannot be peeled, should be thoroughly washed in running water before serving. This applies particularly to leafy vegetables such as lettuce, greens, and radishes which may have become contaminated with disease-producing organisms from materials used as fertilizers, especially in the Tropics.

■ 41. CARE OF EATING AND COOKING UTENSILS.—*a. General.*—All eating and cooking utensils should be sterilized immediately after use by washing in hot soapy water, followed by rinsing in hot clear water. This is necessary to destroy disease

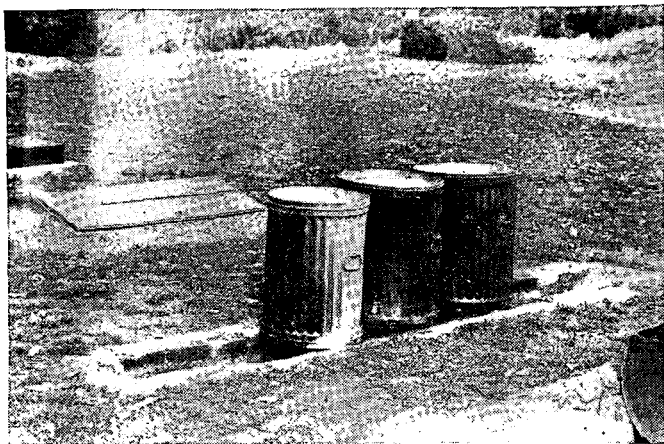

FIGURE 47.—Fire trench and cans for washing mess kits.

organisms. The utensils should then be air-dried. Dish-towels should never be used. When not in use all utensils should be protected from dust and flies.

*b. Mess kits.*—(1) If mess kits are used, they must be sterilized by each individual. Fragments of food should be scraped from mess kits into a can or pit in the ground before washing. Washing of mess kits is usually done in galvanized iron cans. A trench 8 feet long, 1 foot wide, and 1 foot deep is dug near the kitchen. A fire is built in this trench. Over

it are placed three galvanized iron cans, preferably supported by strips of metal. Two of the cans contain hot soapy water, and the third hot clear water. The water in all three cans should be kept close to boiling while in use. Each man thoroughly washes his mess equipment in each of the two cans of hot soapy water, then rinses it in the hot clear water, and permits it to air-dry. The cans must be emptied of water and thoroughly cleansed after each meal. The food particles are disposed of by burial or incineration. The water is disposed of in the soakage pit or trench.



FIGURE 48.—Washing mess kits.

(2) In semipermanent camps a different apparatus for washing mess kits may be used. It consists essentially of a fire trench with a stack at one end, built over a soakage pit. The pit is 11 feet long, 4 feet deep, and 2 feet wide and is filled to within 1 foot of the surface with varying size stone. Along the two sides and one end a wall of stone, brick, or concrete is built extending 2 feet above the ground level, forming a firebox. The water containers are made from 50-gallon oil drums cut along the longitudinal axis, 4 inches

above the center line. Drums with bungs should be used and so cut that the bungs will be dependent when placed on the fire. Pieces of iron pipe of sufficient length are threaded at one end to fit the bung holes and drilled at the other end to receive an iron rod used to turn them in or out. After the drums are placed on the firebox the space between the drums and walls, between the ends of the drums, and between the rear drum and the stack should be filled with clay. This device will require a relatively small amount of fuel to boil the water. The draft will be such that it will be found

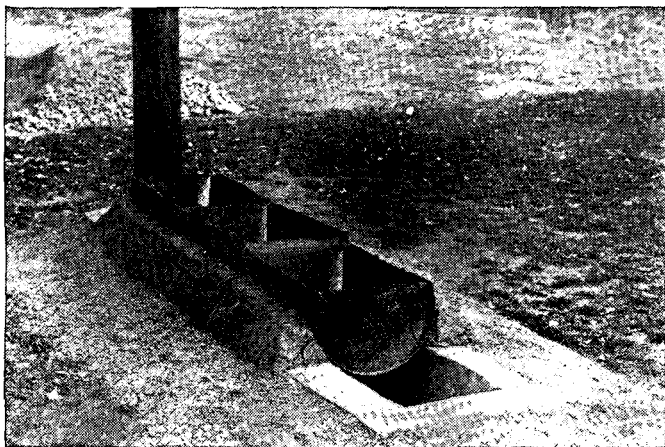

FIGURE 49.—Device for washing mess kits in the field.

desirable to place a damper in the stack. The men can wash their mess equipment without being bothered by flames and smoke. When the washing is completed, the iron pipes are removed and the water escapes into the soakage pit.

■ 42. MESS TABLES.—Where tables are available, they should be so constructed that the middle leaf or board can be removed to permit cleaning the space between the boards, and removal of food particles. Tables should be scrubbed with soap and water after each meal.

■ 43. FLY CONTROL IN MESSES.—If the mess is housed in a screened building, the screening must be kept in repair. Screen doors should be kept closed when not in use. Flies gaining entrance into the mess hall should be destroyed by the use of traps, flypaper, sprays, and by swatting.

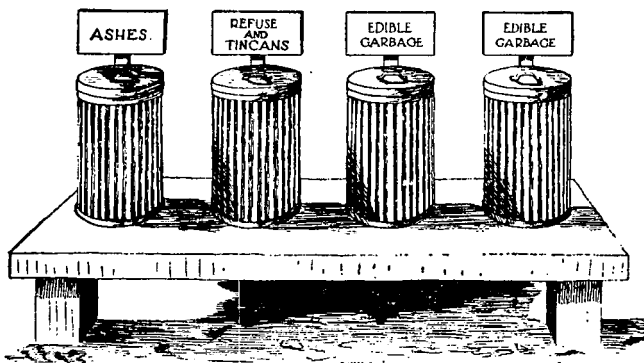

FIGURE 50.—One method of labeling garbage cans for the collection of classified garbage. Concrete garbage stand.

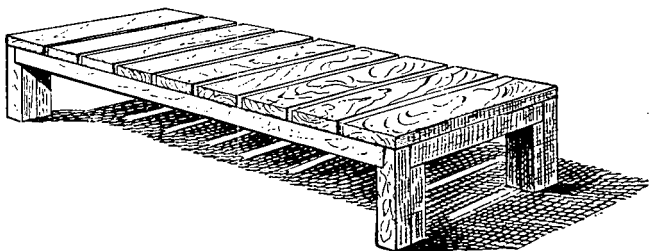

FIGURE 51.—Garbage stand made of planks.

■ 44. DISPOSAL OF GARBAGE.—All garbage and liquid wastes should be promptly disposed of so as not to attract flies to the vicinity of the mess. Constant police of the mess is necessary to prevent accumulation of fragments of food. Where practicable, all garbage should be collected, as produced,

in garbage cans equipped with well-fitted lids. These cans should be kept outside the mess, either on a garbage stand or on firm, well-tamped soil. Garbage stands if used should not be screened as this increases the difficulty of keeping them clean and serves to attract flies. Garbage should be removed from garbage cans for incineration or burial at least twice daily, and preferably after each meal. This is done by personnel of the mess unless garbage is being hauled away for disposal outside the company area. The garbage cans should be scoured with hot soapy water and lye at least once each day.



## CHAPTER 5

### INSECT-BORNE DISEASES

	Paragraphs
SECTION I. General.....	45-48
II. Mosquito control.....	49-53
III. Control of lice.....	54-57
IV. Control of ticks.....	68-70
V. Control of bedbugs.....	71-73
VI. Control of roaches and ants.....	74-75
VII. Control of fleas.....	76-77

#### SECTION I

#### GENERAL

■ 45. GENERAL.—*a.* A disease is classified as insect-borne when a bloodsucking insect is the only agent, or the usual one, by which the causal organisms are transmitted from person to person or from animal to man.

*b.* Malaria and bubonic plague may be considered as typical examples of insect-borne diseases. The causal organisms of malaria are transmitted from the blood stream of one person to the blood stream of another by the mosquito. The causative agents of bubonic plague are transferred from the tissues of an infected rodent to the tissues and body fluids of man by the flea.

*c.* Diseases of this class are infrequent in the northern United States. In the South they are quite prevalent, malaria in particular being of military importance. In many parts of the world insect-borne diseases are responsible for a great amount of illness and numerous deaths. Insects which transmit disease to human beings or animals are known as vectors.

■ 46. TABULATION OF VECTORS.—The following tabulation of insect-borne diseases with their vectors includes those diseases of particular interest to the Army:

<i>Disease</i>	<i>Principal vector</i>
Malaria.....	Anopheles mosquito (several species).
Yellow fever.....	Aedes egypti mosquito.
Dengue.....	Aedes egypti and aedes albopictus mosquitoes.
Tularemia.....	Flies, ticks, lice, and fleas. (Also contact with infected material.)
Rocky Mountain spotted fever.	Tick.
Relapsing fever.....	Lice and ticks.
Typhus fever (epidemic) _	Body louse.
Typhus fever (endemic) _	Fleas (usually).
Trench fever.....	Body louse.
Bubonic plague.....	Rat flea.
Filariasis.....	Several varieties of mosquitoes and biting flies.
Epidemic encephalitis....	Aedes and probably other mosquitoes.

■ 47. PREVALENCE.—*a.* The geographical and local prevalence of an insect-borne disease is governed by the distribution and prevalence of the insect host. Consequently these diseases can prevail only in districts where environmental conditions are favorable for their continued maintenance. For example, those species of mosquitoes which are capable of transmitting disease can survive and breed only under favorable climatic conditions and, consequently, mosquito-borne diseases are most prevalent in tropical and subtropical regions and in the warmer portions of the temperate zones. Louse-borne diseases, on the other hand, occur most frequently in cold and temperate regions, as the conditions produced by cold weather favor breeding and spread of human lice.

*b.* Where the cycle of transmission includes an animal host of the infectious agent, or of the transmitting insect, the prevalence of the disease concerned is modified or entirely governed by the accessibility of the animal hosts. For example, bubonic plague occurs in man only when plague-infected rodents are present, and Rocky Mountain spotted fever prevails only where suitable animal hosts are accessible to the transmitting tick.

c. Those insect-borne diseases transmitted by insects which are only incidentally or occasionally parasitic on man, including the diseases transmitted by mosquitoes, fleas, or ticks, are not military diseases in the sense that a military environment, as distinguished from a civilian environment, facilitates their spread, or that their incidence is usually greater in a military population than in the civilian population generally. But trench fever, typhus fever, and relapsing fever are true military diseases in the sense that they tend to prevail to a much greater extent among troops than in civilian communities. This is due to the fact that the insect host, the human louse, is an absolute parasite on man and that a military environment, especially under combat conditions, favors its continued propagation and spread. Consequently, of the insect-borne diseases the louse-borne diseases are potentially the most dangerous to military forces.

■ 48. TRANSMISSION.—*a.* Transmission of insect-borne diseases is accomplished by the vector first sucking blood from an infected person or animal and later biting a susceptible individual. Infection may occur either from the insect's act of injecting salivary fluid as it bites, or by the feces, glandular secretions, or bodily fluids of the insect being ground into the skin in the act of scratching.

*b.* Some of the organisms which cause insect-borne diseases must pass through a stage of development of several days in the body of the insect host before the insect can infect another person. There is thus an incubation period. This is called "biological transmission." Malaria is an example of this type of transmission.

*c.* The organisms of certain other diseases such as bubonic plague may be transferred to susceptible individuals without undergoing any change within the body of the insect. This is termed "mechanical transmission." There is no incubation period.

## SECTION II

### MOSQUITO CONTROL

■ 49. GENERAL.—Mosquitoes are of importance to health, not only as transmitting agents of disease but also as sources of

discomfort. Among the diseases known to be transmitted by mosquitoes are malaria, dengue, yellow fever, and filariasis. The most important of these from a military viewpoint at this

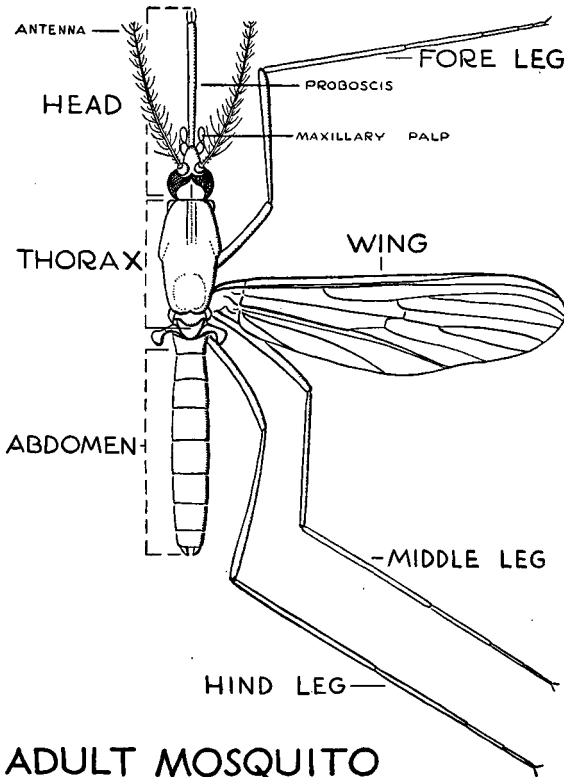

## ADULT MOSQUITO

FIGURE 52.—Mosquito, gross anatomy.

time is malaria. Not all species of mosquitoes are vectors, and the habits of various species and groups differ. It is therefore essential to know the specific vector or vectors before starting an antimosquito campaign, otherwise, much money and effort may be wasted.

■ 50. **RECOGNITION.**—In some instances mosquitoes may be difficult to recognize, but one can be fairly sure that an insect is a mosquito if it has a long slender body divided into three parts—the head, thorax, and abdomen; two thin transparent wings with a fringe on the rear edge, six long slender legs, two antennae or “feelers,” a proboscis which is about the length of the head and thorax, and two palpi (mouth parts). The larval stage, commonly called wigglers, are easily detected in water.

■ 51. **LIFE CYCLE.**—There are four stages in the life cycle of the mosquito: the egg, the larva, the pupa, and the adult. The first three stages are passed in water, while the adult is a free-flying insect. Males are vegetarians, while females are bloodsuckers and thus act as transmitters of disease. The time for the development of the egg is about 3 days, the larva about 10 days, and the pupa about 3 days.

■ 52. **HABITS AND DISTINGUISHING CHARACTERISTICS.**—*a. Breeding places.*—Mosquitoes may breed in practically any collection of water which persists longer than 10 days. Most types prefer slow-moving streams, ponds, swamps, drains, water receptacles, and roof gutters. Various species differ in their preferences for types of breeding places. Some prefer breeding in and around habitations and are termed domestic. Some prefer to breed in sunlit places, while others prefer shady places. Some prefer fresh water, and others water containing organic material. Detailed discussion of these characteristics may be found in Army Medical Bulletin No. 23.

*b. Range of flight.*—Some mosquitoes, including the Anopheles, can fly at least 1 mile and with a favorable wind possibly several times that distance.

*c. Group characteristics.*—The three groups of mosquitoes which are concerned in the transmission of disease are Anopheles, Aedes, and Culex. Each of these groups contains several species whose characteristics vary somewhat. It is sufficient in the scope of this manual to list the general characteristics of the three main groups.

(1) *Anopheles.*—(a) Transmits malaria (not all species of Anopheles).

(b) Bites at dusk, night, and dawn.

(c) Breeds chiefly in water away from habitations, preferring ponds, streams, and swamps.

(d) Eggs are boat-shaped, are laid singly, and tend to collect on the water in triangular patterns.

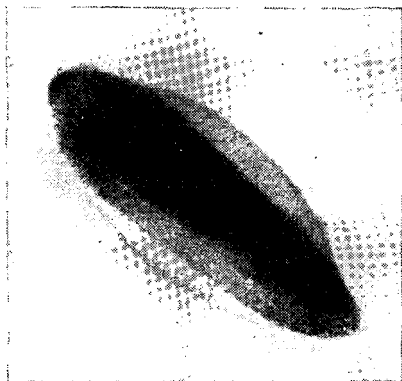

① Showing floats.

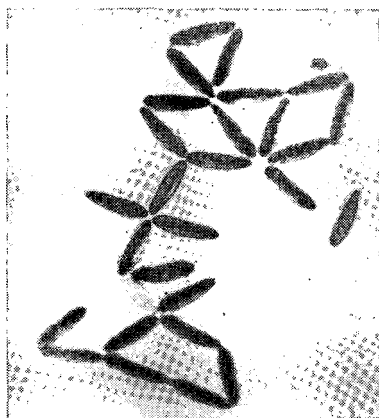

② Typical arrangement in geometrical patterns in water.

FIGURE 53.—Anopheles mosquito eggs.

The adult may live 1 to 3 months.

(e) Larvae lie parallel to the surface of the water and feed at the surface.

(f) Adults have long palpi and spotted wings and rest at an angle of  $45^{\circ}$  to the surface.

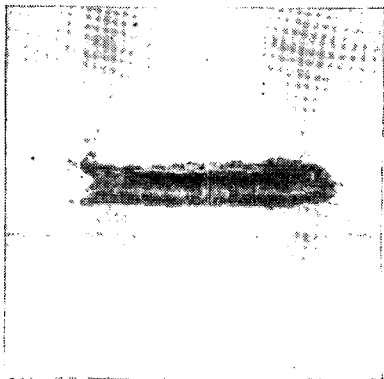

① Showing typical horizontal position in water.

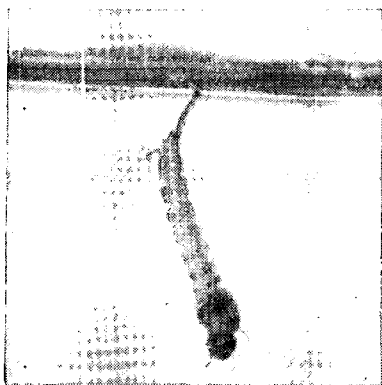

② Culex larva in typical position in water.  
FIGURE 54.—Larvae of Anopheles mosquito.

(2) *Aedes*. (a) Transmits dengue, yellow fever, and filariasis.

(b) Bites during the day.

(c) Breeds chiefly in collections of water in and about habitations (rain barrels, buckets, gutters).

(d) Eggs are slender and are laid singly on water.

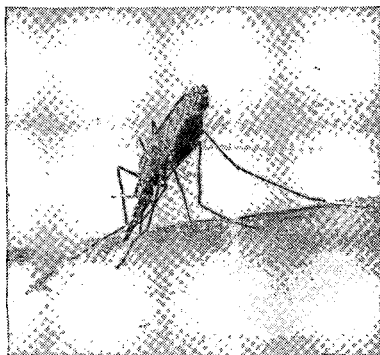
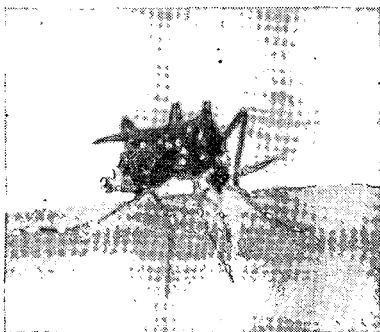

FIGURE 55.—Mosquitoes, resting position.

(e) Larvae hang at an angle in the water, feed below the surface of the water, and breathe at the surface.

(f) Adults have short palpi, wings clear of spots, and bodies striped with silver color. They rest parallel to the surface.



- (3) *Culex*.—(a) Transmits filariasis.  
(b) Bites at dusk, night, and dawn.  
(c) Breeds chiefly in and about habitations, but also in stagnant water in swamps and cesspools.  
(d) Eggs are cemented in rafts on surface of water.  
(e) Larvae hang at an angle in the water but have longer breathing tube than *Aedes*.  
(f) Adults have same resting position and same short palpi as *Aedes*, but their bodies have no stripes.

■ 53. MOSQUITO CONTROL MEASURES.—*a. General*.—The control of mosquito-borne diseases is based upon the following procedures:

- (1) Elimination of breeding places.
- (2) Destruction of mosquito larvae and adults.
- (3) Protection of man from the bites of mosquitoes.
- (4) Isolation of cases and carriers to prevent infection of mosquitoes.
- (5) Treatment of cases and carriers.

*b. Responsibility for mosquito control measures*.—(1) *Mosquito surveys*.—Mosquito surveys are ordinarily a function of the Medical Department. They are conducted for the purpose of determining the most feasible and usually the quickest and least expensive procedures for mosquito control in the definite situation encountered. The points considered include the military situation, the funds and labor available, the species of mosquitoes present, the types and location of breeding places, and the presence or absence of insect-borne diseases. It must always be kept in mind that complete eradication of mosquitoes will require several weeks' time. In war the military situation will often be such that only partial control will be obtainable. However, in peace, or in the communications zone and zone of the interior in war, adequate control can usually be obtained.

(2) *Execution of control measures*.—Commanding officers are responsible for the execution of mosquito control measures. Their decisions may be based on recommendations submitted by Medical Department officers upon completion of mosquito surveys. The actual labor required is performed either by the Quartermaster Corps or by labor details from

the command involved. These labor details may be supervised by representatives of the Medical Department. Unit commanders are responsible only for the control measures executed within the areas occupied by their organizations.

*c. Control measures.*—(1) *Elimination of breeding places.*—These measures are applicable only in semipermanent and permanent camps. They are highly effective when possible of execution.

(a) *Filling.*—This is effective. It is practical for small depressions where streams overflow or storm water collects. Earth, rocks, garbage, cinders, ashes, rubbish, and old manure may be used as a fill.

(b) *Drainage.*—This is applicable in the case of small ponds of water or swamps. It may be accomplished either by surface or by subsurface drainage. Surface drainage can be

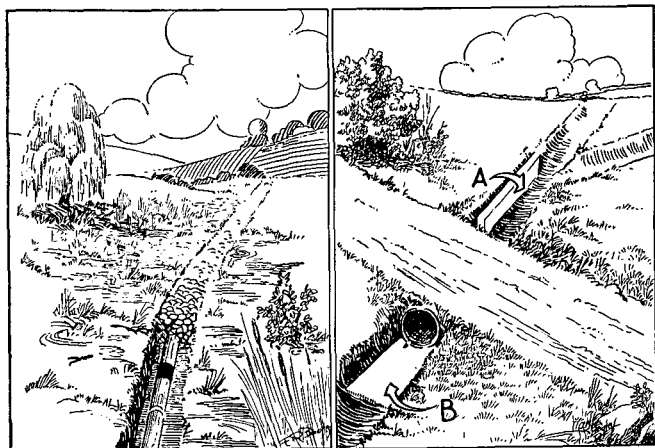

FIGURE 56.—Drainage ditches. A—Showing splash board for ditch junction. B—Showing splash board at ditch junction and culvert under roadway, with concrete slab at down stream end of culvert.

accomplished by open U-shaped ditches. These ditches may be lined with tile or cement. Unless lined, attention is required to keep out vegetation. Subsurface drainage can be

accomplished either by a trench filled with small rocks or by a line of loosely joined tile just under the surface of the ground.

(c) *Stream training.*—This is effective but requires considerable labor. The stream edges should be straightened, pot holes removed, and grass and underbrush removed for a distance of 4 feet from the edge of the stream. If time, labor, and material permit, stone or cement walls may be constructed to retain the stream.

(d) *Emptying water containers.*—All water containers should be emptied weekly. Frequent inspections should also be made for collections of water in tin cans, flower pots, old automobile tires, or gutters.

(2) *Destruction of larvae.*—These measures are all of a temporary measure and must be repeated at least every 7 to 10 days. The most common larvicides are crude oil, waste motor oil, kerosene, paris green, and Panama larvicide.

(a) *Oiling.*—A continuous film of oil must be maintained on the surface of the water for 2 or 3 hours in order to kill



FIGURE 57.—Knapsack oil sprayer.

the larvae. About  $\frac{1}{2}$  pint of oil is required for each 100 square feet of water surface. Crude oil, fuel oil, waste motor oil, or various mixtures of these oils may be used. The heavy

grades of oil must be thinned in order to obtain a film, especially in cool weather. The killing effect is caused by the toxic action of the volatile gases after inspiration by the

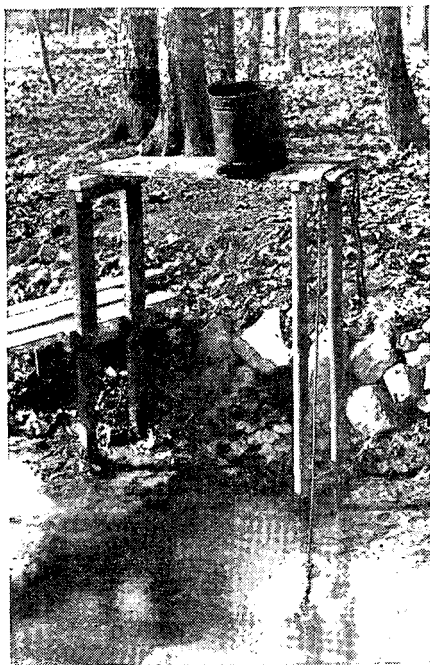

FIGURE 58.—Drip oiler made from 5-gallon oilcan. Regulator consists of nail and cotton plug. Suitable for oiling water in a small ditch.

larvae. Nonvolatile oils are ineffective. There are various methods of applying oil:

1. The knapsack sprayer consists of a container for oil, a pump, and a spray nozzle. It holds about 5 gallons and is operated by one man who carries it strapped on his back. Its range is up to 25 feet. It is used for small ponds, pools, ditches,

and the banks of streams. Larger sprayers may be used for larger bodies of water.

2. A watering can may be used but it is a slow method.
3. A drip oiler may be used in slow moving streams. It will maintain a film of oil over indentations in stream banks and over stream eddies. It requires little attention. The oil must be adapted to the temperature. The oiler is made from a container such as a galvanized iron can, a 5-gallon oilcan, or a bucket. A small hole is made in the bottom. In this is inserted a regulator or wick consisting of a nail wrapped in gauze. The oiler is set on boards over the stream. The rate of flow should be regulated to about 20 drops per minute for each foot width of the stream.
4. A submerged oiler may be used either in streams or ponds. One method is to fill a burlap sack with oil-soaked sawdust, weigh it down with rocks, and place it in the stream. Oil will gradually come to the surface. Another method is to anchor to the bottom of the stream a tin can of oil with small holes in the top and bottom.

(b) *Paris green*.—This is mixed with 100 parts of road dust or fine ashes before application. It is useful only against the *Anopheles* mosquito which feeds on the surface. The mixture may be applied by hand, by hand blowers, or by spreading from an airplane. One-half ounce of paris green diluted with 100 times its volume of road dust will be sufficient for 1,000 square feet of water surface. In this amount it will not harm fish.

(c) *Panama larvicide*.—This is a phenol larvicide. It is made by heating 5 gallons of crude carbolic acid until it is steaming hot, stirring in 6 pounds of crushed rosin, then stirring in 1 pound of caustic soda dissolved in 1 pint of water. This larvicide is mixed with five parts of water and is ready for use. In treating bodies of water enough of the larvicide is added to form an emulsion of about 1 to 5,000. It is thus necessary to know the volume of the water being treated. This may be applied with a spray or may be poured into the water. It will not destroy fish.



FIGURE 59.—Equipment for mixing and applying paris green larvicide.



FIGURE 60. Method of producing dust cloud of paris green larvicide with hand-operated dust blower.

(d) *Destruction by natural enemies.*—Many fish will eat mosquito larvae. The most efficient of these is *Gambusia Affinis*, a top feeding minnow. These are particularly valuable in small ponds or slow flowing streams.

(3) *Destruction of adults.*—(a) *Swatting.*—This is the simplest means of disposing of mosquitoes which have entered buildings. It can be more easily accomplished at twilight and just after daybreak, at which time mosquitoes collect on screens, doors, and windows. An ordinary fly swatter or folded paper may be used.

(b) *Spraying.*—This is of value in buildings. The ordinary pyrethrum spray is effective for the purpose. The spray should be directed at the walls and ceilings.

(c) *Hand catching.*—This method is slow and difficult. Its main value is to secure specimens for identification. Use a large test tube 6 by 1 by 1 inch with an easily removed cork. Fill the bottom of the tube with rubber bands or cotton saturated with chloroform. To operate remove the cork and place the tube over the resting adult. Mosquitoes will be found under window ledges, in closets, behind objects hung on the wall, and in other darkened places.

(4) *Protection of the individual.*—(a) *General.*—Protection from mosquitoes is necessary both for patients under treatment for insect-borne diseases and for healthy individuals. Its object is both control of disease and freedom from discomfort.

(b) *Screening.*—This is of value only if maintained in perfect repair. A mesh of 18 wires to the inch is necessary to exclude *Anopheles*. Vestibules with double screen doors are of value in excluding mosquitoes from buildings. Screen doors should open outward and should have strong springs.

(c) *Mosquito nets.*—Mosquito nets or bars are to be used on beds in all areas when mosquito-borne diseases are endemic. Their use must be enforced by the unit commander. They may be used on T bars or suspended from the inside or over the outside of the shelter tent. No part of the net should touch the sleeper. They must be tucked in on all sides while in use. During the daytime they must be rolled. They should be inspected regularly for holes, ripped

seams, and tears. Nets are to be carried as part of the soldier's equipment in malarial countries.

Where Anopheles are prevalent, head net and gloves should be used for members of the guard and others on outside duty.

(d) *Repellents*.—These are mixtures which when daubed on the skin partially or completely repel mosquitoes. They are for the most part difficult to secure and keep. The following ones are easy to prepare:

1. Melt 60 grains of white petrolatum and add 15 cc. citronella oil, 8 cc. of spirits of camphor, and 8 cc. of oil of cedar wood. Stir well, pour into jars, and cool rapidly. This must be kept cool and tightly capped. A small amount applied to the face and neck will last through the night.
2. A mixture of 1 part Epsom salts and 10 parts water daubed on the skin is moderately effective in repelling mosquitoes.

(5) *Medicinal prophylaxis*.—Quinine or atabrine are valuable means of preventing the development of malaria among troops serving in a region where malaria is highly prevalent and where satisfactory protection from mosquitoes cannot be secured. Such prophylaxis should, however, be used only as a temporary emergency measure. The dose of quinine should be 5 to 10 grains each day. Close supervision is necessary. Each company should be lined up by roster, and an officer of the company concerned should watch each individual actually swallow the medicine.

### SECTION III

#### CONTROL OF LICE

■ 54. GENERAL.—*a. Diseases transmitted*.—Lice transmit typhus fever, trench fever, and relapsing fever.

*b. Classification of lice*.—The species of lice which infest man are—

(1) *Pediculus humanus corporis* ("body louse," "cootie"). This species is the one chiefly responsible for the transmission of louse-borne diseases.



- (2) *Pediculus humanus capitis* (head louse).  
(3) *Phthirus pubis* (crab louse).

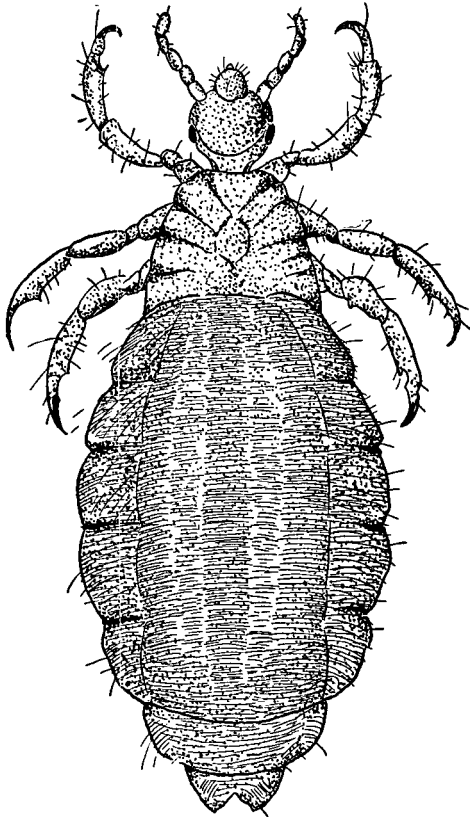

FIGURE 61.—*Pediculus humanus corporis* (body louse).

*c. Military importance.*—The louse-borne diseases are particularly important to the Army in time of war since lice thrive in conditions of crowding and difficulty of personal cleanliness.

■ 55. LIFE CYCLE.—The life cycle of the louse consists of three stages; the egg, larva, and adult.

*a. Egg stage.*—The eggs are attached to the hairs of the body or head, or the fibers of clothing, by a cement excreted by the female. They are opaque, yellowish, ovoid in shape, and pin point in size. The egg hatches in about 8 days at a temperature of 86° to 90° F. At a lower temperature the egg stage may be prolonged several weeks.

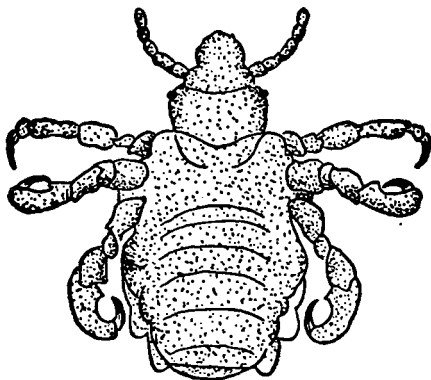

FIGURE 62.—Phthirus pubis (crab louse).

*b. Larval stage.*—The larvae are whitish in color and pinhead in size. Their physical characteristics are similar to the adult except that they are smaller. This stage lasts about 9 days.

*c. Adult stage.*—The adult female starts to lay eggs within a day after development. Eggs are laid at the rate of 5 to 10 per day, and under favorable conditions of food and temperature, she will continue to lay eggs for 30 days. The adult is almost  $\frac{1}{16}$  inch in length.

■ 56. CHARACTERISTICS OF LICE.—*a.* All three types of lice are dependent on human blood for existence and will die in a short time if deprived of an opportunity to feed. The higher the temperature, the more food lice require and the quicker they will die if unable to feed. At 98° F. they are very active

and can live but 2 days without food. At 104° F. they will die in 12 hours without food. At low temperatures they may live much longer.

b. The head louse ordinarily remains attached to the hairs of the head. The crab louse is found mainly about the genital region but may be found attached to the hairs of any part of the body. The body louse, however, remains attached to the clothing except when feeding.

c. Lice are disseminated by adult lice or eggs being dropped off the body in straw, debris, blankets, clothing, or latrine seats. Crab lice may also be disseminated by sexual intercourse.

d. Lice and their eggs are killed in 5 minutes by dry heat of 131° F. and in 1 minute at 155° F. They are killed in 30 seconds in boiling water.

e. Lice do not transmit disease by the act of biting. They defecate as they feed. The disease viruses are contained in their excreta and are scratched into the skin by the human host.

■ 57. **DELOUSING PROGRAM.**—*a.* Delousing must be universally effective throughout the unit. All individuals, their clothing, and their equipment should be disinfested simultaneously. If one individual is missed, reinfestation of the entire unit will soon occur. Unit commanders may prevent infestation of their organizations by insisting on frequent bathing, change of clothing, and inspection for evidence of lice. Prompt action should be taken at the first indication of lice.

*b.* Delousing of a unit includes the following procedures:

(1) All individuals to bathe thoroughly and to shave various parts of the body if necessary.

(2) Clothing and equipment to be deloused.

(3) Latrines, beds, and any objects possibly harboring lice to be disinfested or destroyed.

(4) Clean clothing to be issued to all individuals.

*c.* Louse control is essentially a responsibility of unit commanders except at places where large bathing and delousing plants are operated by the Quartermaster Corps.

■ 58. **BATHING.**—*a. General.*—Bathing is an essential part of any delousing program and should be performed while

clothing and equipment are being deloused. It may be carried on either in a fixed installation such as a quartermaster bathing and delousing unit or by means of improvised shower baths. An excellent soap to use is made as follows:

Boil one part of ordinary issue soap in four parts of water.

Add two parts of kerosene.

Mix with four parts of water.

*b. Improvised shower bath.*—(1) A simple device for bathing can be made from a water sterilizing bag suspended from a scaffold on a tree limb. One faucet of the bag is replaced

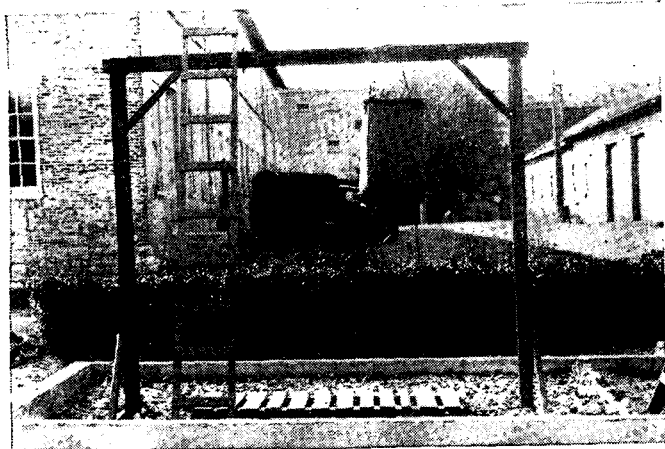

FIGURE 63.—Shower bath made from water sterilizing bag.

by a rubber tube, in the end of which is placed a short section of pipe closed at one end and perforated in numerous places to act as a shower head. A stone-filled soakage pit should be constructed underneath the shower, being covered with boards on which the men may stand. A grease trap should be installed if the pit is to be in use for more than 2 days.

(2) A large tin can, such as a gasoline can, with a perforated bottom may be suspended from a tree or platform. It is operated by one man pouring water through the can while another bathes.

(3) A more elaborate device may be made by inserting a small perforated tin can into a hole cut in the bottom of a barrel. The valve is constructed of a plunger which fits into the can. This plunger is controlled by means of a lever and handle within reach of the bather.

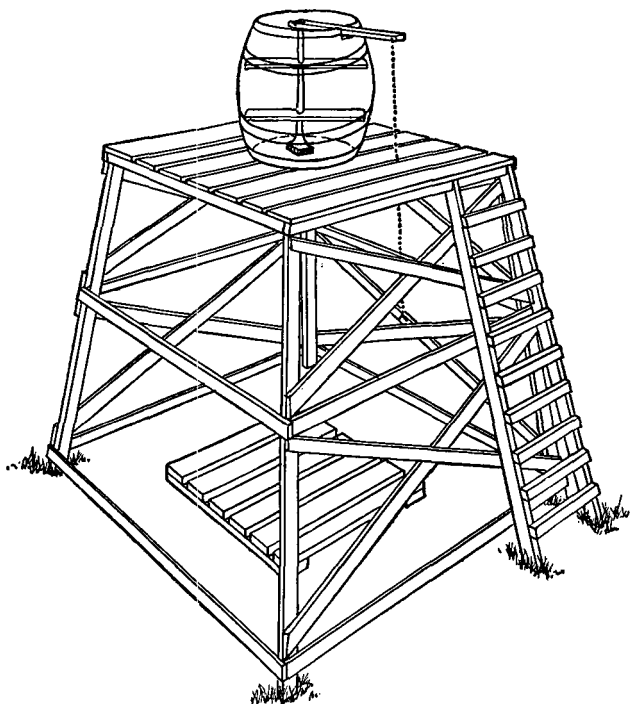

FIGURE 64.—Improvised shower bath.

*c. Shaving.*—Bathing with soap will not always destroy all of the eggs attached to the hairs of the body. When infestation is evidenced by the presence of eggs on the hairs or by indication of louse bites, the hair in the armpits, about the genitals, and if necessary on the chest and legs should

be shaved or clipped. In peacetime, shaving should be routinely employed for the removal of crab lice. If at any time shaving or clipping is not practicable, the infested parts of the body should be thoroughly scrubbed with vinegar, kerosene, or gasoline. This will remove the eggs as well as the adults.

*d. Sprays.*—The use of insecticides such as the pyrethrum spray has been used for the destruction of crab lice, but it is an uncertain method and must be repeated several times. It is not advisable.

*e. Head lice.*—If head lice are present, disinfestation can be accomplished by loosening the eggs from the hairs by the thorough application of vinegar followed by shampooing the scalp with hot, soapy water containing 25 percent of kerosene. This removes the detached eggs and kills the adult and larval forms. After shampooing, the hair should be combed with a fine-toothed comb to remove any nits not removed by washing. Where practicable the hair should be clipped short.

■ 59. **DISINFESTATION OF CLOTHING AND EQUIPMENT.**—*a. General.*—Improper treatment will damage certain materials. Steam will not seriously affect cotton or woolen cloth but will seriously damage articles made of leather, felt, or webbing. Boiling water will shrink woolen cloth. Dry heat is practically harmless for all articles except wool, which it will damage somewhat.

*b. Available methods.*—Outside of permanent installations and delousing units, the disinfestation of clothing and equipment is done by means of one of the following methods:

- (1) Mobile disinfestor (quartermaster function).
- (2) Serbian barrel type of disinfestor.
- (3) Improvised hot air disinfestors.
- (4) Hot irons.
- (5) Hot water.
- (6) Storage.
- (7) Chemicals.

■ 60. **MOBILE DISINFESTORS.**—These are of the four-wheeled trailer type and are usually steam pressure disinfestors although a continuous current steam disinfestor is manu-

factured. They weigh about 11 tons and are thus restricted in mobility. The pressure type consists of a horizontal steam chamber around which there is an outer jacket which is assembled as a unit with a boiler. After the clothing is placed in the disinfestor, a vacuum of 10 to 15 inches is created, after which steam is turned into the inner chamber until a positive pressure of 15 pounds is obtained. This pressure is held for

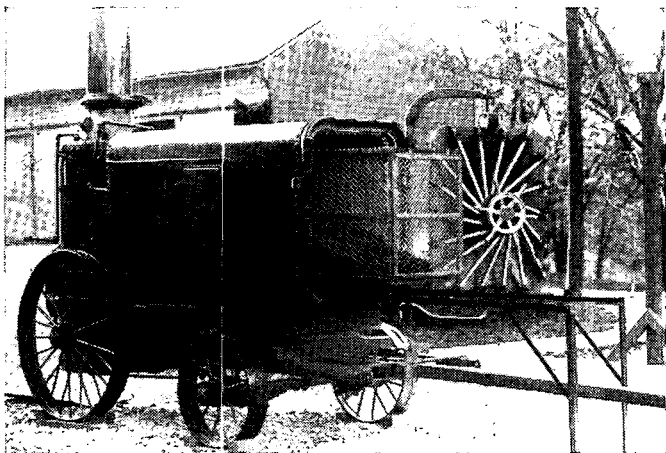

FIGURE 65.—Portable pressure disinfestor.

20 minutes. The steam is then released and a vacuum of 10 to 15 inches is held for about 5 minutes to dry the clothing. Clothing should be packed loosely in order that the steam will penetrate.

■ 61. SERBIAN BARREL.—*a.* Serbian barrel type disinfestors are company installations. They consist of a barrel or a similar container for the material to be disinfested, below or in the lower part of which there is a receptacle for water and an improvised furnace or firebox.

*b.* The galvanized iron garbage can is usually the most practicable, and no separate container for water is necessary. Water to a depth of about 2 inches is placed in the bottom

of the can, which is placed over the fire. A wooden or metal grate supported on sticks about 1 foot in length should be placed in the bottom of the can to hold the clothes above the water. Hooks on which to hang the clothes may be bolted or riveted into the lid, or S-shaped wire hooks may be hung over the edge of the can. Clothing should be left in the can for 45 minutes after steam commences to escape. Air-dry after removal and reissue to the men. This method will kill all the eggs, larvae, and adult lice.



FIGURE 66.—Disinfestor, Serbian barrel type.

c. This type of disinfestor may be made from a barrel with a water pan beneath it, or it may be constructed of knock-down type.

■ 62. IMPROVISED HOT AIR DISINFESTORS.—Clothing and equipment may be placed in ovens, boxes, or cans and subjected to dry heat. Small buildings or dugouts may be converted into hot air disinfestors by installing heating apparatus which will heat the air to 160° F. Clothing should be hung loosely and exposed for about 30 minutes.



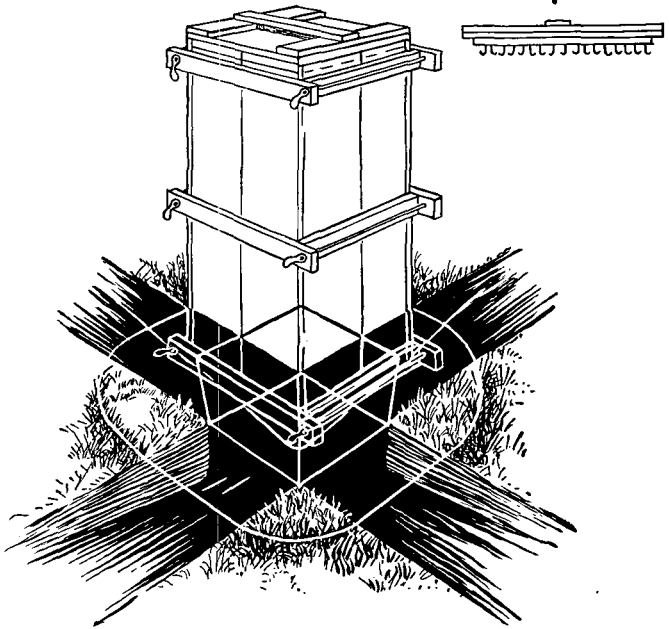

FIGURE 67.—Disinfestor, Serbian barrel, knock-down type.



FIGURE 68.—Hooks for suspending material in Serbian barrel.



FIGURE 69.—Disinfecter, Serbian barrel type, showing water pan and the wire netting across lower opening of the steamer.

■ 63. **HOT IRONS.**—Clothing can be partially deloused by removing the adult lice by hand and then killing the eggs by ironing the cloth, especially the seams and folds, with a hot iron. An ordinary sadiron or a piece of iron pipe or scrap iron with a wooden handle may be used for this purpose. This method is laborious and uncertain.

■ 64. **HOT WATER.**—Cotton, linen, or silk clothing may be disinfested by immersion in boiling water for 1 minute. This will kill the virus of the insect-borne diseases as well as the lice. A temperature of 135° F. for 5 minutes will kill lice but will not destroy the viruses. This method should not be used for wool, leather, felt, or web material.

■ 65. STORAGE.—Storage of infested clothing and equipment will accomplish disinfection by depriving the lice of a food supply. The exact time required is dependent on the temperature. A safe rule is to keep articles in storage at least 30 days. In this time successive batches of eggs will have hatched, and the larvae and adults will have died. This method is frequently very practical for disinfecting clothing and blankets in hospitals and camps, providing storage facilities are available and clean clothing and equipment are available. The storage rooms should be kept dry. Freshly infested articles should not be placed with those that have been in storage for some time. No article should be removed from a room until all articles have been in storage at least 30 days.

■ 66. CHEMICALS.—Leather, web materials, shoes, and hats which cannot be disinfested by other means should be immersed in a 5 percent solution of cresol for 30 minutes. Clothing may be disinfested in 2 percent cresol, but this is rarely advisable.

■ 67. OPERATION OF DELOUSING PLANT.—*a.* Certain fundamentals should be observed in the installation and operation of delousing plants, regardless of size:

(1) There must be no mixing of clean and infested men.

(2) The plant should be definitely divided into two parts, a clean and an infested side, connected only through the showers for the men and through the disinfestors for clothing and equipment.

(3) Adequate lighting should be provided for physical inspection of the men and inspection of clothing. Inspection of the men is usually done by representatives of the Medical Department.

(4) Separate toilet facilities should be provided for infested men and clean men.

(5) The buildings or shelters used as a plant should be frequently cleaned to prevent infestation of clean individuals.

*b.* The minimum divisions for a large plant are listed below. Some of these may be combined in smaller plants.

(1) A receiving room large enough to care for an excess number of men if troops are sent to the plant too rapidly.

- (2) A disrobing room.
  - (3) A checking room where valuable, shoes, belts, and other articles which do not require disinfestation may be checked.
  - (4) Shower baths.
  - (5) A disinfestor room or shelter.
  - (6) A dressing room.
  - (7) A barber shop.
  - (8) A physical inspection room.
- c. The standard quartermaster delousing plant can handle about 2,500 men in one working day.

#### SECTION IV

#### CONTROL OF TICKS

■ 68. GENERAL.—The common wood tick is the most important tick found in the United States insofar as transmission of disease to man is concerned. This tick is the

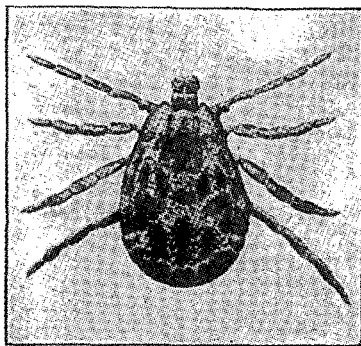

FIGURE 70.—*Dermacentor andersoni* (wood tick).

vector for Rocky Mountain spotted fever. In endemic areas it is estimated that 1 percent of wood ticks harbor the spotted fever virus. It is also one of the agents by which tularemia is transmitted from animal to animal and from animal to man. It is found quite generally throughout the United States. The rabbit tick and dog tick are also con-

cerned in the transmission of Rocky Mountain spotted fever. Ticks have been found to be the transmitting agent of relapsing fever in Central America, Venezuela, and Colombia.

■ 69. HABITS AND CHARACTERISTICS.—*a.* The developmental forms of the tick consist of the egg, larva, nymph, and adult. The tick deposits several thousand eggs in a mass on the ground. The egg stage lasts from 3 to 4 weeks to several months, depending on the temperature. The larvae as they emerge seek a warm-blooded host upon which they feed for 2 to 4 days. They then drop to the ground where they remain dormant for several weeks. They molt and become nymphs which again seek a warm-blooded animal upon which to feed for 4 to 8 days. The nymph then drops to the ground where, after a lapse of several weeks, molting occurs and the adult emerges. The adult searches for a host, finds one, attaches itself, feeds for a while, then copulates. After 10 days to 2 weeks the gravid female drops to the ground, deposits her eggs, and dies.

*b.* Adult ticks can live for 2 years without food. Cold delays the development of the immature forms but extremely cold weather will not kill ticks in any stage, nor will it destroy the virus of Rocky Mountain spotted fever.

*c.* Ticks are able to transmit the etiological agents of Rocky Mountain spotted fever, relapsing fever, and tularemia through the egg stage to the progeny, any stage of which is capable of inoculating the host with the causative organism.

■ 70. CONTROL MEASURES.—*a.* Control of tick-borne diseases by the eradication of the tick is difficult to achieve and is in many instances impracticable. Buildings of little value infested with ticks should be burned. If found desirable, a kerosene or cresol insecticide may be applied to tick-infested floors, walls, ceilings, or furniture. It should be applied in the same manner as described under control of bedbugs. Control of the tick must be attained mainly by control of its wild animal hosts. As the larval and nymph forms feed principally on the smaller animals such as squirrels, rabbits, prairie dogs, or woodchucks, the eradication of these animals from an infested area is an important factor in tick control. This may be done by trapping, shooting, and

poisoning of wild rodents. Where practicable, burning of the underbrush will reduce the number of animals and will also destroy some of the ticks. Sheep grazing is also a valuable means of reducing the number of ticks.

b. All individuals in tick-infested localities should frequently examine their exposed skin areas and promptly remove any ticks found. This may prevent disease since ticks may not infect a person until some time after they have attached themselves to him.

#### SECTION V

#### CONTROL OF BEDBUGS

■ 71. GENERAL.—Bedbugs exist wherever they can live in close association with man. They frequently become a serious pest in barracks and guardhouses. While it has not been proved

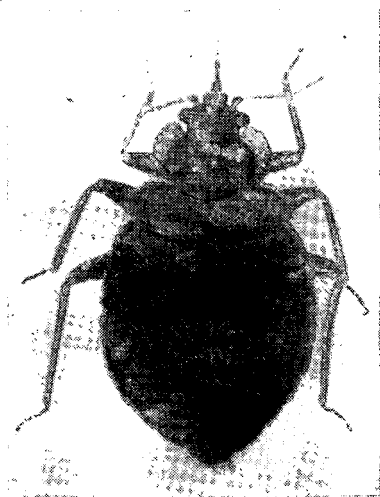

FIGURE 71.—*Cimex lectularius* (common bedbug of temperate zone).

that bedbugs transmit any disease to man, they have been suspected of transmitting relapsing fever and leishmaniasis. Because they are blood-sucking insects, however, it is possible

that they may transmit any disease in which there is a blood stream infection.

■ **72. HABITS AND CHARACTERISTICS.**—*a.* Bedbugs develop through the egg, larva, and adult stages. The eggs are white, oval in shape, and about 1 millimeter long. They are deposited in cracks, crevices, and any place which affords protection and concealment. In warm weather the eggs hatch in 4 to 10 days but development may be prolonged or prevented by cold. The larvae are yellowish white in color and resemble the adult except in size and color. Blood is required for the development of the larvae. Time for development is 6 to 11 weeks dependent upon food and temperature.

*b.* Bedbugs are nocturnal in their feeding habits. They are capable of surviving for 6 months or more without food. They are very sensitive to high temperatures, and all forms including the eggs are killed in a few minutes by exposure to a temperature of 123° F. in a humid atmosphere. They are killed by prolonged exposure to a temperature below freezing.

*c.* Bedbugs are usually spread from place to place in clothing, bedding, baggage, or furniture. They hide in the seams of mattresses and pillowcases and in cracks and crevices of any wooden or metal structure.

■ **73. CONTROL MEASURES.**—*a. Fumigation.*—Fumigation is the most effective bedbug control measure provided a gas is used which will penetrate into the depths of the cracks and crevices in the walls, floors, and furniture. Hydrocyanic acid gas is penetrating and, when properly used as a fumigant, it will destroy all forms of the bedbug. However, the gas is fatal to humans as well and unless a rigid guard is maintained at all times, its use is impracticable and dangerous. Sulphur dioxide may be used but because of its low penetrating power and destructive action upon fabrics, it is not particularly satisfactory. Fumigation should not be attempted by untrained personnel.

*b. Liquid insecticides.*—Liquid insecticides are effective if thoroughly and repeatedly used. An effective mixture for this purpose is kerosene containing 10 percent of cresol or 5 percent of turpentine. Kerosene alone may be used. A kerosene or alcoholic extract or pyrethrum is also effective. A paint

brush should be used in the application of the liquid insecticide. A spray is not as effective. This procedure should be repeated three or four times at intervals of 1 week to kill all developing eggs. Steam should be used to eradicate bedbugs from mattresses, blankets, and other bedding. Dry cleaning with gasoline and washing in hot water will usually get rid of them. Hand picking, brushing, and shaking is recommended. Flaming the cracks of steel cots with a blowtorch is quite effective. Kerosene may be used as a repellent by saturating with it wicks of woolen material placed in the coil springs of metal cots. Fresh applications of kerosene should be made weekly.

#### SECTION VI

#### CONTROL OF ROACHES AND ANTS

■ 74. GENERAL.—Roaches and ants are not transmitting agencies for any insect-borne diseases. They are, however, serious nuisances in messes and may transmit intestinal diseases by contamination of food.

■ 75. CONTROL MEASURES.—*a.* The most important measure is to deprive ants and roaches of an available food supply by cleanliness of the mess and by protection of food supplies by refrigerators and screened cabinets. The placing of table and refrigerator legs in cans containing water will protect food from ants.

*b.* Sodium fluoride should be placed in cracks, corners, and about water pipes 2 or 3 times a week. Spraying of cabinets, corners, and cracks in the wall with the issue liquid insecticide will destroy many roaches. This is best done at night.

*c.* Complete eradication of ants can only be accomplished if their nest is found and destroyed. Once located, the nest may be destroyed by pouring boiling water or kerosene into it.

#### SECTION VII

#### CONTROL OF FLEAS

■ 76. GENERAL.—*a.* Several varieties of fleas are vectors of bubonic plague and endemic typhus fever. Various small animals, particularly rodents, serve as reservoirs of infection



from which fleas may transmit bubonic plague or endemic typhus fever to man. The rat flea is the most common vector. Fleas rarely select man as the host of choice, but they may transfer themselves to man whenever he comes in association with their usual small animal hosts.

b. Endemic typhus fever differs from the epidemic louse-borne typhus fever only in severity. Actually, it is probably a milder form of the same disease.

■ 77. CONTROL MEASURES.—*a. Elimination of animal hosts.*—This is the essential control measure. It must include attention not only to rats and squirrels but also to pet dogs and cats.

(1) Pet animals may be freed of adult fleas by a variety of commercial preparations. Washing in 3 percent solution of cresol or 10 percent emulsion of kerosene, followed by thorough rinsing, will also destroy fleas. While pets are being treated, blankets or beds occupied by them should simultaneously be disinfested.

(2) Rats are not only important as reservoirs of infection of bubonic plague and typhus fever but are also factors in the spread of several other diseases. Control of rats is a difficult problem. The supervision of rat-control campaigns is a normal function of the Medical Department. The principal control measures are as follows:

(a) *Trapping.*—This is an effective method but requires considerable skill since rats quickly become suspicious of traps. It is very important not to leave the odor of human hands on trap or bait. A snap type of trap is preferable to a cage trap. The bait may be fried bacon, fish, cheese, liver, fresh bread, doughnuts, cantaloupes, or tomatoes. The bait must be securely fastened to the trap. The trap should be located at points normally frequented by rats. Traps may be deodorized by flaming or by dipping in hot paraffin.

(b) *Poisoning.*—This is the most valuable control measure. It is, however, a rather complicated procedure if properly done. It, as well as the measures in (c), (d) and (e) below, is adequately discussed in FM 8-40 and Army Medical Bulletin No. 23.

(c) Ratproofing of buildings.

(d) Fumigation.

(e) Use of natural enemies (other animals).

*b. Destruction of fleas.*—(1) *Fumigation.*—This method is the same as for bedbugs.

(2) *Spraying and scrubbing.*—Fleas in buildings may be destroyed by scrubbing the interior of the rooms with soapy water containing 10 percent kerosene and 5 percent cresol. The floor should be thoroughly wet. Barns and barnyards may be disinfested by spraying with a creosote oil containing 10 percent tar acids.

## CHAPTER 6

### VENEREAL DISEASES

■ 78. GENERAL.—*a.* Venereal diseases are by far the most important cause of noneffectiveness among troops. Cases of respiratory diseases are usually more numerous than cases of venereal diseases, but the average time lost per case of venereal disease is much longer.

*b.* Venereal diseases are in no sense military diseases. Their prevalence among civilian populations is difficult to determine but is probably greater than in the Army. Studies have shown that at least 60 to 70 percent of prostitutes in the United States are infected, and it is probable that the actual incidence is much higher.

*c.* The four diseases classed as venereal are—

(1) *Gonorrhoea*—caused by the gonococcus.

(2) *Syphilis*—caused by a corkscrew-shaped organism; the *Treponema pallidum*.

(3) *Chancroid*—caused by the bacillus of Ducrey.

(4) *Lymphogranuloma inguinale*—caused by a filterable virus.

*d.* These diseases are usually transmitted during sexual intercourse. Gonorrhoea is always transmitted in this manner. Both chancroid and lymphogranuloma inguinale are almost invariably so transmitted. Syphilis is most commonly transmitted during sexual intercourse, but the primary lesion, the chancre, may occur on any part of the body. Infection may result from using a common drinking cup, from kissing, or from being bitten by a woman who has open lesions of syphilis in her mouth.

■ 79. PRINCIPLES OF CONTROL.—*a.* The venereal disease rate of an organization is usually a rather close index of the state of discipline, training, and administration of that organization. The responsibility for venereal disease control rests primarily on unit commanders. The principles of trans-

mission of venereal diseases are simple and are easily understood by all persons.

b. The most important fact to be kept in mind by all individuals is that almost all women who will permit promiscuous sexual intercourse are infected with venereal disease. Frequent sexual intercourse is not essential to health, and efforts should be directed toward preventing exposure to infection. This may be accomplished to a considerable degree by control of prostitution, educational measures, suitable recreation, and by punitive measures.

c. In spite of warning, many individuals will expose themselves to infection. Mechanical and chemical means of preventing the development of infection give a fairly high degree of protection, but only so when promptly, intelligently, and thoroughly applied.

d. Control of venereal diseases depends on the actions of each individual. It would be theoretically possible to wipe out venereal diseases if all persons observed the basic principle of control which is, to avoid sexual intercourse with prostitutes, either professional or clandestine.

■ 80. CONTROL MEASURES.—*a. Educational.*—(1) AR 40-235 directs that a course in sex hygiene be given in all troop schools. Special emphasis is to be placed on the responsibilities of unit commanders in the prevention and control of venereal diseases.

(2) At least every 6 months the commanding officer of each basic unit and detachment is required to arrange and personally supervise instruction in sex hygiene and the prevention and control of venereal diseases for all enlisted men of his command. This instruction is to be given to recruits as soon as possible after enlistment. The instruction is divided into three parts:

(a) The unit commander discusses the effect of venereal diseases on military efficiency and outlines the possible punitive measures.

(b) A medical officer discusses the nature of venereal diseases, the necessity for prompt treatment, the danger of self-treatment, and the means of avoiding disease.

(c) A chaplain discusses the moral aspects of the venereal disease problem.

*b. Recreational.*—Adequate recreational facilities are an essential factor in the control of venereal diseases. Athletics, libraries, movies, and organized entertainments will encourage many men to avoid recourse to liquor and prostitutes as means of passing their free time. Physical activity with its resulting fatigue is of itself an excellent means of reducing exposure to venereal disease.

*c. Prostitution.*—No method of regulation of houses of prostitution has proved successful. No city in the United States legalizes such houses, but they are numerous. Every effort should be made toward the suppression of such houses and of individual prostitutes. The cooperation of civil authorities should be sought to this end.

*d. Prophylactic measures.*—(1) *Mechanical.*—The condom affords the only practical mechanical protection against venereal infection. Post exchanges are required to stock condoms of approved quality. A condom will prevent gonorrhoeal infection which must enter the urethra. It is not certain protection against syphilis, chancroid, or lymphogranuloma inguinale which may enter the skin and tissues about the genitals. Consequently, chemical prophylaxis must be given even after a condom has been used.

(2) *Chemical.*—(a) *Prophylactic stations.*—The Medical Department is responsible for operating sufficient prophylactic stations to serve adequately each command. In many situations it is advisable to establish such stations in civilian communities adjacent to Army stations or camps. Prophylactic stations may be established even in bivouacs. Chemical prophylactic treatments are given in these stations by trained enlisted men of the Medical Department. Any soldier may apply for a treatment regardless of the hour. The chemical prophylaxis given is highly effective if administered within 30 to 60 minutes of the time of exposure. Its effectiveness decreases rapidly after that time. The attendant at the station gives each soldier a signed record of the treatment, showing the date, hour, and place of treatment. This treatment cannot be satisfactorily administered to a man who is drunk because individual cooperation is necessary.

(b) *Prophylactic tubes.*—There are several individual prophylactic tubes manufactured commercially. Some one of these will be stocked by post exchanges. They are not as efficient as the treatment given in prophylactic stations but are of great value for soldiers who are unable to get to a station within an hour after exposure. Even after using one of these tubes, a soldier should report to a prophylactic station if possible.

(c) If a soldier has exposed himself and has neither a prophylactic tube nor access to a station, he should empty his bladder, and then scrub his genitals and the surrounding skin areas with soap and water. This may serve to prevent infection.

*e. Punitive measures.*—(1) Any individual who knows or believes that he has contracted a venereal disease must report that fact to his immediate commanding officer without delay. Trial by court martial or other disciplinary action is discretionary with the commanding officer. No disciplinary action is authorized for failure to take prophylaxis or for having contracted a venereal disease.

(2) Any person in the military service who loses time from duty because of a venereal disease forfeits his pay during the time so lost and must make good the time lost.

*f. Physical inspections.*—The periodical physical inspections which are conducted at least once each month for all enlisted men below the first three grades include inspection for evidence of venereal disease. Additional inspections may be arranged if it is believed that some men may be concealing venereal disease. These are most effective if conducted early in the morning or just after return from outdoor activity.

*g. Treatment.*—All cases of venereal disease should be promptly sent to the hospital or dispensary for treatment. Early treatment offers far better chances of cure than does delayed treatment. Self-treatment or treatment by unskilled individuals are both ineffective and dangerous.

*h. Action to reduce high venereal rate.*—In case a command has an excessively high venereal rate at any time, stringent control measures may be necessary. These may include all or part of the following:

(1) Placing red light districts and all places selling liquor out of bounds.

(2) Patrolling of restricted districts by military police.

(3) Limit all passes to 4 hours and grant no passes after 9 p. m.

(4) Classify passes.

(5) Routine bed check.

## CHAPTER 7

### MISCELLANEOUS DISEASES

	Paragraphs
SECTION I. Lockjaw (tetanus)-----	81-82
II. Gas gangrene-----	83-84
III. Rabies-----	85-86
IV. Scabies-----	87-88
V. Ringworm "Dhobie itch" (trichophytosis)-----	89-91
VI. Poison ivy, poison oak, poison sumac (plant dermatitis)-----	92-93

#### SECTION I.

#### LOCKJAW (TETANUS)

■ 81. GENERAL.—Tetanus is commonly called "lockjaw." It is a serious disease, having a mortality which may be as high as 80 percent. It is caused by the tetanus bacillus which is an anaerobic organism (one which lives in the absence of oxygen). Tetanus bacilli enter the body by way of wounds. The size and appearance of the wound bear no relation to the severity of the illness which may develop if tetanus bacilli are present. These organisms are most apt to appear in wounds which have been contaminated with soil or road dust, especially deep puncture wounds in which foreign bodies have lodged, or wounds entering joints. These are among the common types of wounds encountered in war. The tetanus bacillus is easily destroyed by ordinary antiseptics but, in the "spore" or resting form, it may live for a long time in the soil, withstanding wide ranges of temperature. Thus any wound unless superficial and clearly inflicted must be considered a possible source of tetanus.

■ 82. CONTROL OF LOCKJAW.—*a. Treatment of the wound.*—Any wound other than small, superficial scratches should be treated by skilled medical personnel. This is especially true of puncture wounds from nails or from spikes on athletic shoes. The treatment should be obtained promptly so that wounds may be cleaned out before tetanus bacilli gain a foothold.

*b. Specific measures.*—(1) Tetanus antitoxin has been routinely administered to all cases incurring wounds in war,



or under circumstances which suggest the possibility of tetanus. The dose is 1,500 units for adults and 750 units for children. It should be given as soon as possible after the wound is incurred. It gives a fairly high degree of protection against tetanus but has the important difficulty in use that many persons have severe reactions. These are termed serum reaction or anaphylactic shock. A medical officer can determine with reasonable certainty by a preliminary test whether antitoxin may be safely given. It is important for any person to inform the medical officer as to whether he has had asthma, hay fever, or reaction to any previous dose of an antitoxin.

(2) A form of vaccine called "tetanus toxoid" has been developed. This gives better protection than tetanus antitoxin and is also safer in use. In time of war it may be given to all soldiers either at the time of enlistment or before they enter a theater of operations. Any man wounded will then be given additional injection of the toxoid as directed.

## SECTION II

### GAS GANGRENE

■ 83. GENERAL.—Gas gangrene is an acute infection occurring in large, crushed wounds contaminated with human or animal wastes found in soil. The infection is usually associated with compound fractures and large wounds that come in contact with the soil, but it has occasionally followed puncture wounds. Once the disease develops it is extremely difficult to control. The mortality is very high.

■ 84. CONTROL.—Control depends on early and proper surgical treatment and the use of sera. The first aid precautions are the same as those for tetanus.

## SECTION III

### RABIES

■ 85. GENERAL.—*a.* Rabies is a communicable disease of animals transmissible to man. It may occur in any animals but is most prevalent among dogs. In the dog it may occur in a furious and excited form, or in a dumb and depressed form

in which the animal is very weak and finally becomes paralyzed. The excited form is more common.

*b.* Usually the virus or organism of rabies is transmitted by inoculation of saliva through a wound or abrasion of the skin or mucous membrane. The saliva is injected into the skin by biting but it may be transmitted by the licking of injured skin surfaces or by handling sick animals. The organism cannot be transmitted through unbroken skin, by ingestion of contaminated food or drink, or by contaminated fomites. While the disease occurs in cats, squirrels, rats, wolves, coyotes, foxes, horses, cattle, sheep, and swine, these animals are not common sources of infection for man. An average of 50 per cent of persons bitten by a mad dog will develop rabies unless properly treated.

■ 86. CONTROL MEASURES.—*a.* Control of rabies depends on the prevention of the disease in dogs, treatment of wounds, and prophylactic treatment to prevent the development of the disease.

*b.* Dogs can be protected against rabies by specific vaccination which should be repeated each year. A metal tag giving the date the treatment was given should be attached to the collar of the dog.

*c.* When a case of rabies develops in a dog or when a dog is exposed or suspected of being exposed to the infection, two doses of the vaccine should immediately be given and the animal held in quarantine for 1 month. When dogs cannot be vaccinated, those exposed or suspected of being exposed to the rabies infection should be held in quarantine for at least 6 months.

*d.* A person bitten by a mad dog, or by a strange and unknown dog, should report to a medical officer for treatment of the wound and a course of prophylactic vaccination. This vaccination is highly effective. If possible the dog which bit the individual should be captured and observed to determine whether it had rabies.

#### SECTION IV

#### SCABIES

■ 87. GENERAL.—*a.* Scabies, also known as seven-year itch, is an acute inflammatory condition of the skin due to the pres-

ence of the *Sarcoptes scabiei* or itch mite. The female is responsible for the disease as she burrows into the skin in order to lay her eggs, while the male remains on the surface. After laying from 25 to 50 eggs she usually dies. The eggs hatch in about 5 days. The larval and nymphal forms pass through four stages to become adults in about 3 weeks. The larvae also bore into the skin to find protection and food. The activity of the mites is greatly influenced by the temperature. Active burrowing takes place only when the skin is warm. The newly matured females and the males are found under the scales and crusts of the skin.

b. Scabies is an important condition because of its adverse affect on the morale and efficiency of the individual or groups. It entails an average loss of time of about 10 days in cases admitted to quarters and hospital. Complicated cases are frequently in hospital for several weeks.

c. The source of infestation is the person with scabies. Direct body contact is the common mode of transfer but indirect contact through clothing, blankets, or equipment may occur. Clothing from infested individuals may harbor the live parasites for at least 11 days.

d. Itchiness between the fingers and upon the back of the hands is usually the first symptoms. The parts most affected are the webs of the fingers, backs of the hands, occasionally the palms, flexor surfaces of the wrists and arms, lower part of the abdomen, the buttocks, the inner surfaces of the thighs, and the genitals. The lesions are rare upon the feet. The primary lesion is a vesicle or papule. Burrows are not found in all cases; they are most common between the fingers. They consist of straight or tortuous lines from  $\frac{1}{8}$  to  $\frac{1}{2}$  inch in length and ending in a slight elevation. Along the lines are numerous black dots, the excreta of the female. The itching is usually intense, and is especially bad at night.

e. The diagnosis should be confirmed by a medical officer, but company commanders should be able to recognize the condition. A positive diagnosis can be made by finding the mites in the burrows. A hand lens is an aid in this search. The location of the lesions on the hands, wrists, elbows, knees, and genitals aids in differentiating scabies from the scratch marks due to body lice.

■ 88. CONTROL MEASURES.—*a. General.*—A medical officer should supervise the disinfection of a group of individuals having scabies. Hospitalization is not essential except for single or scattered cases. Eradication of existing infestation depends on proper diagnosis, disinfection of skin, clothing, and blankets. The spread of scabies from infested recruits or isolated cases is controlled by securing body cleanliness, cleanliness of clothing and blankets, and by preventing overcrowding.

*b. Special measures.*—Group quarantine should be established for all patients until treatment is completed. Men who have received treatment should be reinspected 10 days after completion of the treatment to be sure all infestation is destroyed. The clothing and blankets of men having scabies should be disinfested by the method employed for delousing. This should include gloves and shoes.

*c. Disinfection of the skin.*—Disinfection of the skin is accomplished only by treatment that destroys all forms of the parasite. Bathing with hot water and free use of green soap well scrubbed in for 10 or 15 minutes is essential to remove the crusts and scales. The soap is then removed with hot water and the body thoroughly dried. Sulphur ointment is then thoroughly applied to the entire body, from the neck to the tips of the fingers and toes. It should be well rubbed in. This treatment is repeated on each of the following 2 days. On the fourth day a cleansing bath concludes the treatment. All clothes, blankets, and equipment used during the period of treatment are then disinfested. Individuals should be carefully inspected about 1 week following treatment since sometimes it is necessary to repeat the treatment. Itching may continue for several days after treatment, even in successfully treated cases.

## SECTION V

### “RINGWORM” “DHOBBIE ITCH” (TRICHOPHYTOSIS)

■ 89. GENERAL.—The terms “trichophytosis” or “ringworm” comprise a group of skin infections due to parasitic fungi. Numerous different fungi may be responsible for these infections, and all parts of the human body may be involved. All

of these infections tend to become chronic, and all thrive in warm weather or under other conditions which result in perspiration. They are very common in all walks of life. They may be so mild as to be barely noticeable, or so severe as to be completely disabling.

■ 90. TYPES OF RINGWORM INFECTION.—The principal forms in which ringworm appears are—

a. *Tinea tonsurans*.—*Tinea tonsurans* or ringworm of the scalp is a very persistent form of infection. It is characterized by one or more rounded, scaly, grayish-colored patches through which project dry, brittle, broken-off hairs. The patches are not well circumscribed; they spread peripherally and often coalesce to form large areas, often as large as the hairy scalp. Slight itching may be present.

b. *Tinea barbae*.—*Tinea barbae* or ringworm of the beard is a contagious disease manifesting itself by follicular lesions upon the chin, neck, and submaxillary regions. The individual follicles are small and usually superficial; the hair over them is stubby and bathed in a discharge of pus. The nodules tend to be arranged in groups, each group separate from the other. The disease is very chronic, tends to cure spontaneously with the loss of hair, and when cured leaves no traces.

c. *Tinea circinata*.—*Tinea circinata* or ringworm of the body develops as one or more rounded, red, slightly elevated, scaly patches which on close examination reveal minute vesicles or papules. The typical advance is from the periphery, while the central portion clears up. There is often considerable itching. Ammoniated mercury ointment will usually terminate the infection promptly.

d. *Tinea cruris*.—*Tinea cruris*, commonly known as “dhubie itch,” is a fungus infection chiefly involving the skin about the genitals. The inner sides of the thighs, the groin, the cleft between the buttocks, and the skin between the toes are the common sites for the infection. The armpits, the abdomen, and the skin of the chest may be involved. The lesions are usually two or more in number, large in size, brownish in color, with an elevated edge which is covered with scales. Itching is very severe. This infection may dis-

appear during cool weather only to reappear during the next hot season. The causal agent of *tinea cruris* is transmitted from person to person by contact, chiefly by the hands, clothing, towels, bathroom floors, or toilet seats.

*e. Ringworm of the extremities.*—(1) Ringworm of the extremities is variously called "dermatomycosis," "epidermophytosis," "trichophytosis," and "athlete's foot." It consists chiefly of an inflammation of the skin between the toes and on the soles of the feet, but it may also occur on the hands. The lesions may appear in various forms, including thickening and scaling of the skin, excoriation of inflamed areas, fissures, and vesicles (blisters). Usually there is considerable itching. The infection tends to recur when the feet perspire, even after lengthy treatment. Complete cures are very difficult to obtain.

(2) Ringworm of the extremities is one of the most prevalent of all skin diseases, although many cases may pass undiagnosed unless their presence is revealed as the result of examination. The presence of this condition in an organization has an adverse effect on the morale of the troops. The infection if untreated may become so severe as to incapacitate the individual.

(3) The causal agents of ringworm of the extremities are most commonly spread by contact of the bare feet with the floors, mats, benches, and chairs in the bath rooms of gymnasiums, clubs, and swimming pools. Towels, slippers, shoes, or other articles worn next to the skin may also transmit the fungi. The fungi may persist for a long time in or on these various objects.

■ 91. CONTROL OF RINGWORM INFECTIONS.—*a. General.*—The control measures for all the forms of ringworm infection are essentially the same. The main objective is to prevent the bare skins of noninfected individuals coming in contact with any objects which may have been contaminated by infected persons.

*b. Treatment.*—All cases of trichophytosis should be promptly and adequately treated. Hospitalization is not necessary in all cases, but treatment should be administered under the close supervision of a medical officer. Self-treat-

ment will often aggravate rather than improve the infection. The feet of all men should be carefully inspected at the regular monthly inspection and at other foot inspections. All cases of trichophytosis should be promptly reported for treatment. If numerous cases are found, careful inspection should be made to determine whether there has been some slip in sanitary precautions.

*c. Care of the feet.*—Proper care of the feet, as outlined in chapter 9 is particularly important in the prevention and control of trichophytosis. It is especially important to keep the feet dry. Men should be instructed to dry carefully the areas between the toes before putting on socks and shoes after a bath. If the feet tend to perspire excessively, the issue foot powder should be applied twice daily. Formaldehyde or other drying solutions should not be applied to the feet unless advised by a medical officer.

*d. Foot baths.*—If ringworm of the extremities is prevalent in a command, all bathhouses should be equipped with foot baths. The tubs should be located at the entrances to the showers and should be broad enough so that all individuals will have to step in them going both to and from the showers. They should be at least 6 inches deep, and should be constructed of concrete or rubber. They should contain a solution of grade A calcium hypochlorite in the proportion of 1 ounce of the dry chemical to each gallon of water. This yields 0.5 percent of available chlorine. A fresh solution should be prepared daily. The reason for these baths should be carefully explained to all members of the command.

*e. Disinfection.*—The most effective control measure is disinfection of bathhouse floors and equipment, and by the disinfection of towels, swimming or gymnasium suits, and similar articles. Bathhouse floors and equipment, including mats, benches, and chairs, should be scrubbed daily with soap and water. It is also advisable to scrub them with a disinfectant such as 2 percent cresol, or a solution of calcium hypochlorite, 1 ounce to the gallon of water. There should be removable duckboards in shower baths. These should be thoroughly scrubbed and then exposed to the sunlight for several hours each day. Individual slippers of rubber are useful in preventing contact of the bare feet with infected sur-

faces. The exchange or common use of towels, gymnasium suits, slippers, shoes, or gloves should be avoided unless they have been thoroughly disinfected after use. All articles that will not be damaged by boiling should be sterilized in that manner. Leather and rubber goods can be disinfected with a cresol solution. Shoes can be disinfected by a 1 percent solution of thymol in gasoline or alcohol. This solution is poured into the shoes and allowed to evaporate.

*f. Swimming pools.*—Swimming pools constitute a potent means for transmission of fungi unless properly operated. Regulations should be drafted for swimming pools providing for—

- (1) Restriction on the number of bathers to be allowed in the pool at any one time, and also between periods of cleaning of the pool.
- (2) A thorough bath with soap and water before entering the pool.
- (3) Continuous disinfection of the pool, preferably with a chlorine solution.
- (4) Foot baths of calcium hypochlorite before entering the pool.
- (5) Exclusion of those who are ill.

## SECTION VI

### POISON IVY, POISON OAK, POISON SUMAC (PLANT DERMATITIS)

■ 92. GENERAL.—*a.* The poison ivy, poison oak, and poison sumac are the common plants that produce skin irritation in susceptible persons. The poison ivy is distinguished from other suspected creepers of a similar appearance by its possession of three leaves instead of five. The poison oak which grows especially in the western part of the United States is a shrub or small tree. The poison sumac, also known as poison elder or dogwood, is a shrub or small tree growing in swampy places.

*b.* The harmful part of these plants is the resinous sap which exudes from all injured surfaces. It is now certain that the poison is not volatile as was once supposed. Actual contact with the sap is necessary; however, contact with the



plant may not be essential as the sap can be carried on clothing, tools, and hands, or transmitted on the bodies of insects or in the smoke coming from fires burning the plants. Sap particles carried in any of these ways soon lose their toxic properties by oxidation. This loss is more rapid at body temperature and in a moist atmosphere. The poison is soluble in alcohol and alkalies.

c. The clinical manifestations appear within a few hours after exposure and within 24 hours there is a marked cutaneous irritation. The lesions are most marked on the back of the hands and forearms; the face is usually involved, either primarily or secondarily. In men the penis is often involved, due to the poison being conveyed by the hands. At first there is a marked erythema with some swelling, but in a short time numerous tiny vesicles appear. These may coalesce to form large vesicles. Often they are in rows, due to scratching. Within 2 to 4 days the lesions rupture leaving a weeping raw surface which goes on to form a dry crust. As the vesicles are superficial, complications seldom occur and the patient is usually well in 2 weeks. The subjective symptoms are generally severe with intense burning and itching and a feeling of increased tension of the skin.

■ 93. CONTROL MEASURES.—*a. General measures.*—Learn to recognize the plants and avoid them when possible. Destroy the plants in occupied areas. Avoid contamination in camps by requiring all men working in or about the plants to—

- (1) Wear gloves while at work.
- (2) Change outer clothing and gloves before associating with the other men in the camp.
- (3) Keep contaminated tools and implements separate.
- (4) Burn poisonous vegetation at a considerable distance from the camp site and always at such time and place that the wind will carry the smoke away from the camp.
- (5) If possible, choose camp sites where poisonous plants are not present.

*b. Personal measures.*—(1) Contaminated clothing and implements should be well washed with water (soda water if possible) or exposed to the direct rays of the sun for several hours.

(2) All parts of the body that have been exposed to the plants should be well washed with a strong soap solution or alcohol. Gasoline or kerosene may be used. The washing must be prompt and thorough or else it will tend to spread the poison.

(3) Skilled medical treatment should be promptly sought if the skin eruption appears.

## CHAPTER 8

### MARCH HYGIENE AND SELECTION OF CAMP SITES

	Paragraphs
SECTION I. March hygiene.....	94-99
II. Selection and sanitation of camp sites.....	100-103

#### SECTION I

#### MARCH HYGIENE

■ 94. GENERAL.—In spite of the great extent to which motor transportation is employed by modern armies, marching remains an essential part of service in the field. Proper attention to hygiene and sanitation contributes greatly to the ability of troops to march and to tolerate the physical exertion incident to field service.

■ 95. CONDITIONING OF TROOPS.—It is of great importance that all individuals be properly conditioned before starting on a march of more than a few hours' duration, or taking the field for maneuvers or actual combat. This can be accomplished by progressive and systematic training including practice marches of gradually increasing length. Overtraining can be avoided by well-spaced periods of mental and physical relaxation. During the period of training it is possible to weed out those individuals who are physically unfit for strenuous field service.

■ 96. INSPECTION PRIOR TO MARCH.—Prior to starting on a march, company or similar unit commanders should make a thorough inspection of all members and matériel of their commands. This inspection should include a detailed foot and footwear inspection; an inspection of clothing and equipment; and a consideration of the physical fitness of each individual. For inspection of animals, motors, and matériel see FM 25-5, 25-6, 25-10, and manuals of arms and services. Immediate steps should then be taken to correct any defects

noted. The correction of improperly fitting clothing is important because constricting clothing markedly impairs an individual's activity and stamina. Any individuals appearing to be ill or physically unfit should be reported to the hospital or dispensary.

■ 97. CONDUCT OF THE MARCH.—*a.* An average distance for foot troops to march per day is 12 miles for large commands and 15 miles for small ones. During hot seasons marches should be conducted in early morning or late afternoon hours. The meal served before beginning a march should not be a heavy one but should include energy-producing foods such as sugars and fats.

*b.* Halts are made at regular intervals to rest the men and animals, to service motors, to adjust equipment, and for other purposes. Regular halts are usually made according to standing procedure. Notification relative to halts not foreseen in the march order is conveyed to unit commanders during the course of the march with the least practicable delay.

(1) A halt of 15 minutes is usually made at the end of the first 45 minutes of march for the purpose of permitting the troops to relieve themselves, adjust equipment, and inspect motors, vehicles, and loading.

(2) After the first halt, columns including foot or mounted troops usually halt 10 minutes each hour. The halts of motor columns are usually made every 2 or 3 hours and are regulated with reference to the location of facilities for servicing vehicles and making adjustments. The vehicles of each march unit close on the leading vehicle in order to facilitate inspection and supervision.

(3) The march units of a column halt and resume marching simultaneously, regulating the time by the watch. At the signal for the halt, units bear to the side of the road and troops fall out or dismount to rest.

(4) Shortly before the termination of the halt, the commander of each march unit gives the preparatory signal for the resumption of the march; foot troops fall in, mounted men remount, drivers resume their seats. Each unit moves out at the signal of execution of the march-unit commander.

(5) If possible, all halts should be made in shade. All individuals should remove or loosen their packs, lie down, and relax during rest periods. When necessary at rest periods, human excreta should be disposed of in small pits dug by each individual and immediately refilled after use. Straddle trenches should be dug at the noon halt.

(6) It is generally desirable to finish the day's march as soon as practicable; long halts in the course of a daily march are not made unless special conditions require it. The length of the march or the desirability of avoiding excessive midday heat may, however, render it advantageous to make a long halt toward the middle of the day. Except for the purpose of avoiding excessive heat, long halts are not ordinarily made during marches of less than 8 hours' duration for foot troops; 10 hours' duration for mounted troops; and 12 hours' duration for motorized and mechanized columns.

(7) Columns execute long halts by units or tactical groupings which decrease their march depth and extend their frontage. Each unit or grouping moves to a previously reconnoitered location in proximity to the route of march. Mounted units are located near sources of water supply. Concealment from air reconnaissance and the comfort and security of troops are considered in selecting the locations for the halt. At night, troops rest along the route of march.

c. Unit commanders should closely observe members of their commands while marching and at rest periods for evidence of fatigue or illness. Prompt attention to such matters as treating blisters or other minor foot injuries, relieving a soldier of his pack if he shows evidence of excessive fatigue, and securing medical attention for any soldier showing evidence of illness may save many march casualties. The disposition of march casualties is a responsibility of the Medical Department. However, a medical officer may at times recommend that certain soldiers be permitted to ride either on an ambulance or on transportation of the unit concerned for a part or all of the remainder of a day's march.

d. The hardships caused by cold weather can be mitigated by taking proper precautions and providing troops with suitable winter clothing. Ears, face, and hands must be protected. Mounted troops stimulate circulation by dis-

mounting and leading. Foot troops sling their weapons over the shoulder to free their arms. Snow and ice greatly reduce the rate of march. To equalize the exertion of breaking the way, leading elements of a column are frequently changed. In deep snow, it may be necessary to break the way for foot troops with a vehicular drag or a tractor plow.

e. Troops are not kept in column or under arms any longer than necessary. Many of the discomforts, annoyances, and hardships of marching can be mitigated by the exercise of foresight and good judgment. On going into shelter, the care of animals is given first consideration when the tactical situation permits. Transportation is kept in good condition by regular care on the road and thorough cleaning and overhauling in shelter.

f. Water discipline is essential. No water should be drunk from springs, wells, or other unauthorized sources along the route of march. The amount and rate of consumption of water should be controlled by company officers. During a march of 15 miles in average summer temperature, about 2 quarts of water and considerable salt are lost from the body in perspiration. Unless these are replaced there is marked thirst and exhaustion, the loss of salt being equal in importance to the loss of water. Replacement of salt can be accomplished by adding 1 teaspoonful of common table salt to each canteenful of water. This is advisable during hot weather, it is not necessary in cool weather. Men are encouraged to drink all the water they need before starting a march; they are cautioned to drink sparingly during the course of the march. Canteens should be completely filled at the start of the march, and provision made for refilling them at about the midpoint of the day's march. During very hot weather, too rapid consumption of water which does not contain salt will result in excessive perspiration, diarrhea, nausea, and fatigue. Thirst may be relieved somewhat by chewing gum or keeping a pebble in the mouth while marching. Some individuals find that a canteenful of weak tea quenches the thirst more satisfactorily than does plain water. This custom has some merit but hardly enough to justify the trouble involved in preparing the tea. Commanders are required to have all water for drinking and

cooking purposes chlorinated unless procured from a source found to be safe by the medical service. They make the necessary arrangements for the replenishment of canteens in accordance with anticipated needs; they permit no straggling from the column for this purpose. In large commands, replenishment of canteens from local sources is often impracticable, therefore, water must be transported in water vehicles or tank trucks. Troops exercise economy in the use of water in order to make the available supply suffice for the march. When combat is in prospect, the replenishment of water consumed during the march requires special attention. Animals suffer more from lack of water than from lack of food. If insufficiently watered, they rapidly lose condition. The times of watering are largely dependent upon march conditions and available facilities.

*g.* When necessary, the routes are reconnoitered and marked prior to the commencement of the march; timely measures are taken for preparation of stream crossings and for the removal of obstacles and other possible causes of delay. Suitable rest areas along the route of march with cover from air reconnaissance are selected. Careful examination is made of fords, bridges, ice, etc., before attempting a stream crossing. Sources of water supply are examined and marked as good or bad. This measure is imperative in countries infected with water-borne diseases. If water is bad or water sources insufficient, potable water is supplied in the same manner as rations.

*h.* The surgeon attached to a troop unit marches at the tail of the unit. He examines men authorized to await his passage by the officers of troop units; according to their condition, he gives them a permit admitting them to the ambulance or authorizing them to place arms and equipment (in whole or in part) on the ambulance or other transportation provided for that purpose, or after treatment directs them to report to the guard at the tail of the regiment. One or more ambulances march at the tail of each regiment and similar unit for the transportation of men who become sick or disabled during the course of the march. For instructions concerning collection and evacuation of casualties, see FM 100-10.

■ 98. **ADVANCE QUARTERING PARTY.**—*a.* A quartering party composed of a staff officer, a medical officer, necessary assistants, and representatives of subordinate units makes preparations for quartering a command. The staff officer is the chief quartering officer.

*b.* Quartering arrangements are completed prior to the arrival of the troops. Quartering parties proceed separately to their assigned areas prior to the commencement of the march or from positions in the column, depending upon whether areas are assigned before or during the march.

*c.* In general, quartering parties facilitate the occupation of a shelter area and insure that all agencies of command, administration, and supply function with minimum interruption. Subject to the approval of the area commander, quartering parties select the area unless it has already been selected; make detailed arrangements for its occupancy; apportion areas to subordinate units and allot to each the available facilities; and reserve those facilities essential for the administration and supply of the whole command (headquarters, infirmaries, message centers, etc.).

Essential sanitary installations should, if possible, be completed prior to the arrival of the main body. It is especially important that the source and method of treatment of the water supply be promptly determined and that water guards be posted to prevent contamination of the water or the use of unauthorized sources. Straddle trench latrines and trenches for the burial of garbage should be dug initially, even if the camp is to be of several days' duration. Deep pit latrines and incinerators can be constructed on the following day.

■ 99. **PROCEDURE ON ARRIVAL AT CAMP SITE.**—Foot troops on arrival at the camp site should proceed immediately to their bivouac areas, unslung packs, and pitch tents. The following steps should be taken as soon as possible after arrival at camp:

*a.* A hot meal should be served.

*b.* Orders regarding sanitation should be announced to the entire command.



c. All individuals should wash their feet and change their socks and shoes.

d. Organization commanders should conduct an inspection of their organizations and arrange for the treatment of injuries or the correction of any other defects noted.

e. Sick call should be held.

f. Commanding officers should verify the posting of water guards and the method of treatment of the water supply.

g. Organization commanders should consult appropriate medical officers regarding any members of their organizations who appear to be physically incapable of continuing the march on the following day. It may be practicable to permit certain of these individuals to continue the march by riding.

## SECTION II

### SELECTION AND SANITATION OF CAMP SITES

■ 100. GENERAL.—a. The selection of camp sites is governed by both military and sanitary considerations. As far as the tactical situation permits, security, supply, sanitation, administration, and the comfort of troops govern the *selection of bivouac sites*. At times the military situation may necessitate the selection of a camp site which is not entirely desirable from a sanitary standpoint. However, full weight should be given to sanitary considerations when the military mission will not be interfered with by so doing. Area commanders are responsible for the selection of camp sites and for protecting the health of the command by promptly initiating and strictly enforcing adequate sanitary measures. Medical officers are responsible for making sanitary surveys of prospective camp sites, and making recommendations as to their suitability. Area commanders of large units may also request the recommendations of representatives of the Corps of Engineers or Quartermaster Corps.

b. Improper disposal of human excreta may cause serious epidemics. Adequate and suitable latrines are constructed in appropriate places *immediately* upon going into bivouac; in billets, additional latrines are generally necessary. Latrines for the men are always located on the opposite side of the camp from the kitchens and so sited that their drainage

cannot pollute the water supply of the area. Officer latrines are constructed on the basis of one per battalion or similiar unit.

*c.* Areas are kept policed at all times. Refuse and garbage are burned or buried. Upon the evacuation of a shelter area, fires are extinguished, latrines and kitchen pits filled and marked, and the site left in thorough police.

*d.* Troops will be informed where water for drinking and cooking, animals, bathing, and washing clothes may be obtained. If the water supply is a small stream, these places are designated in the sequence given, beginning upstream. Watering places are clearly marked and guards posted to insure proper use of the water supply. Unless water is known to be pure, it is chlorinated or boiled, then cooled and aerated.

*e.* In billets it may be necessary to designate medical and veterinary officers on the staff of the area commander as public health officers of the community to regulate all matters affecting public health and sanitation. Sources of drinking water are tested and marked; additional latrines are constructed; effective measures are taken for the disposal of refuse and garbage; good order and cleanliness are enforced on all persons in the shelter area; a dispensary is established; and, in general, all requisite measures are taken to protect the health of the command.

■ 101. DESIRABLE SANITARY FEATURES OF CAMP SITES.—From a sanitary standpoint the following features are desirable in a camp site:

- a.* Accessibility to a supply of good water and fuel.
- b.* Sandy loam or gravel soil, favorable to waste disposal.
- c.* Firm, grass-covered turf.
- d.* Elevated, well-drained site.
- e.* Sufficient space to avoid crowding and to permit proper spacing of kitchens and latrines.
- f.* Shade trees as protection from sun in hot weather.
- g.* Protected slope or trees as windbreaks in cold weather.
- h.* Firm ground for vehicle standing.
- i.* A good road net.
- j.* Concealment from air observation and protection against the elements.

■ 102. UNDESIRABLE FEATURES OF CAMP SITES.—Sites with the following characteristics should be avoided if possible:

*a.* Dry beds of rivers, ravines, or the base of a hill if there is likelihood of rain.

*b.* Clay soil or loose, dusty soil.

*c.* Marshy ground or areas near stagnant water courses which may constitute sources of mosquito-borne diseases and be subject to mist or heavy dew.

*d.* Ground water less than 4 feet from the surface of the ground.

*e.* Steep slopes.

*f.* Location close to native villages, especially in malarial regions.

■ 103. REFERENCE DATA RELATING TO SANITARY INSTALLATIONS IN CAMPS.—*a. Latrines.*—(1) Locate on side of camp opposite to prevailing wind at least 100 yards from kitchen and 30 yards from tents, and so that they will not drain into water supply.

(2) Sixteen feet of straddle trench, or two standard quartermaster latrine boxes with deep-pit latrines for each 100 men (space for 8 percent of command).

(3) Five urine pipes for each 100 men, and one urine soakage pit for each 200 men if urine pipes do not enter latrine pits.

*b. Kitchen installations.*—Kitchen wastes may be buried if camp is to last less than 1 week.

(1) Locate at opposite end of company street from latrines.

(2) One soakage pit with barrel or baffle grease trap for each 200 men. Install second soakage pit if camp is to last over 2 weeks.

(3) One barrel and cross trench incinerator for each kitchen.

(4) Three cans for mess-kit washing for each company.

*c. Wash benches and shower baths.*—(1) Locate between company street and latrines.

(2) Ten feet of wash bench to each 100 men.

(3) One or two shower heads to each 100 men if possible

*d. Water supply.*—(1) Locate water sterilizing bags between kitchen and company street.

## (2) Average total consumption per person per day:

Semipermanent camps .....	20-40 gallons.
Temporary camps.....	5 gallons.
Bivouac or marching.....	2 gallons.
Minimum in combat.....	1 gallon.

(3) Animals require an average of 10 gallons per day normally. The absolute minimum in combat is 5 gallons per animal per day.

*e. Dump and compost pile.*—(1) Locate at least 1,000 yards from tents.

(2) Size is dependent on size and duration of camp.

*f. Closing camp.*—Prior to leaving a camp site all sanitary installations should be closed. Latrines and kitchen soakage pits should be filled in and the spot indicated by a marker showing the organization, the nature of the installation, and the date it was closed. *Remember that today's camp may be tomorrow's line of communication.*

## CHAPTER 9

### PERSONAL HYGIENE

	Paragraphs
SECTION I. General.....	104-106
II. Measures to protect and improve health.....	107-111

#### SECTION I

#### GENERAL

■ 104. GENERAL.—Personal hygiene deals with the efforts each individual must put forth to keep in good physical condition, and with the precautions he must take to protect himself from disease. Before being allowed to enlist in the Army, the soldier is given a thorough physical examination to determine the absence of disease. It then becomes his duty to keep himself in the best possible physical condition. In so doing, attention to personal hygiene is of great importance.

■ 105. IMPORTANCE OF EARLY MEDICAL TREATMENT.—If at any time a soldier feels sick or for any reason believes that he has contracted a disease, he should report at once to his first sergeant or to the noncommissioned officer in charge of quarters, who will send him to a medical officer for examination. Soldiers should never try to treat themselves since nearly all medicines may be harmful or possibly even fatal in unskilled hands. Furthermore, a sick person may be a source of danger to his associates.

■ 106. CAUSES OF DISEASE.—Most acute diseases and many chronic ones are caused by micro-organisms or viruses commonly called "germs." The usual ways in which disease-producing germs gain entrance to the body are as follows:

*a.* By eating food or by drinking water or other liquids which contain the germs.

*b.* By breathing in certain germs which float in the air.

*c.* Through the skin, the germs having been injected into the body by the bites of mosquitoes, lice, ticks, or fleas, or introduced through cuts, scratches, or abrasions.

*d.* By contact with diseased persons.

## SECTION II

## MEASURES TO PROTECT AND IMPROVE HEALTH

■ 107. MEASURES TO IMPROVE GENERAL HEALTH.—Every individual has some degree of natural resistance to infection. This natural resistance is improved by any measures which serve to improve his general health. Among measures serving that purpose are the following:

*a.* Protection from cold and chilling by suitable clothing, blankets, and housing facilities.

*b.* Adequate and proper food.

*c.* Physical training, including athletics.

*d.* Sufficient sleep (at least 7-8 hours each night).

*e.* Avoidance of undue fatigue. (This is particularly important in training camps in the presence of epidemics of respiratory diseases.)

*f.* Recreation of suitable nature. (The morale of an organization has a very definite relation to the physical condition of its members.)

■ 108. CARE OF THE BODY.—*a. General.*—(1) An unclean body may favor the entry of disease germs. Therefore the entire body should be bathed at least twice a week, and oftener if possible. The hands should always be washed before eating and after going to the toilet. When facilities for a complete bath are not available, the body should frequently be scrubbed with a wet cloth, paying particular attention to the arm pits, crotch, and feet. The destruction of lice and other vermin is discussed in chapter 5.

(2) Underwear and shirts should be changed and washed at least twice a week. If water is not available, clothing should be crumpled up, shaken well, and exposed to the sun for at least 2 hours.

*b. Mouth.*—It is very important to brush the teeth at least twice a day, one of these brushings to occur before going to bed. In cleaning the teeth, brush the inside and outside surfaces away from the gums and toward the cutting surfaces. Particles of food between the teeth should be promptly removed, care being taken not to injure the gums.

*c. Feet.*—The most important factor in the marching ability of the soldier is the care of the feet. Serious defects of the feet can be prevented by properly fitted shoes and socks and by proper care of the feet.

(1) *Shoes.*—Only field shoes issued by the Quartermaster Corps should be worn in the field by enlisted men. Company commanders are responsible that all men of their commands are equipped with properly fitted shoes. Each shoe is fitted to the foot of the wearer so that no undue constriction or pressure will occur at any point when the foot is expanded by the weight of the body and pack. It is equally important that shoes not be so large as to permit friction. Because of the structural irregularities of the foot, shoes can be properly fitted only by actual test. This testing can be done either by shoe-fitting machine or by hand.

(a) The shoe-fitting machine is a device for measuring the size of the foot when bearing weight and for proving that the size selected is the proper one. These machines together with instructions for their operation are issued as needed. Selected noncommissioned officers should be trained in their use.

(b) *Fitting without shoe-fitting machine.*—The shoe is laced snugly and the wearer with a 40-pound burden on his back places his entire weight on the foot wearing the shoe. The leather of the shoe in front of the instep above the ball of the foot should then be grasped between the fingers and thumb. As the finger and thumb are brought together, the leather should be loose enough to prevent the fingers slipping easily over the surface but not sufficiently lax to produce a wrinkle. If it wrinkles under the grasp, the shoe is too wide, and if there is no looseness apparent, it is too narrow. The proper length of the shoe is determined by measuring the space between the end of the great toe and the end of the shoe. This space should be not less than  $\frac{3}{4}$  inch when all the body weight plus that of a 40-pound burden is borne by the foot being fitted. This space is measured by pressing down the leather with the thumb. The width of the thumb may be considered as representing the desired width between the toe and the end of the shoe. All shoes should be well broken in and adjusted to the feet before being used for marching.

Shoes may be rapidly adjusted to the feet by thoroughly wetting the leather and then walking on a level surface until they become dry. After this the leather should be softened by greasing.

(2) *Socks*.—Only woolen socks (light or heavy) should be worn for marching. Cotton socks should never be worn unless ordered by a medical officer. Socks should be large enough to permit free movement of the toes but not so loose as to permit wrinkling. Woolen socks should be one-half size larger than cotton socks in order to allow for shrinking. Darned socks or socks with holes in them should never be worn on the march since they will cause abrasions and blisters. Wearing two pairs of socks will aid in preventing friction between the shoes and the feet.

(3) *Care of feet*.—(a) Clean feet are as important to the avoidance of foot defects as are properly fitted shoes and socks. The feet should be washed and the socks changed each day. This is especially important on a march. As soon as possible after reaching camp after a march, the feet should be washed (not soaked) with soap and water and the soldier should then put on clean socks and change his shoes. Until the feet are hardened they should be dusted with foot powder before and after each day's march. Applying lard to the feet before a march may prevent irritation of the feet.

(b) If blisters have appeared on the feet they should be painted with iodine and emptied by pricking them at the lower edge with a pin which has been passed through a flame. The skin should not be removed. The blister should then be covered with zinc oxide plaster. Serious abrasions on the feet, corns, bunions, and ingrowing nails should be treated at the dispensary or aid station.

(c) The toenails should be kept short and clean. They should be cut straight across, and not on a curve. If this precaution is observed, most of the troubles from ingrowing nails will be avoided.

(d) Ringworm of the feet or "Athlete's foot" is a common and frequently incapacitating foot infection. Diligent attention should be directed toward its prevention, and toward prompt and thorough treatment of all cases developing. (See pars. 89 and 90.)



(4) *Foot inspection.*—The feet of the men should be inspected periodically by a company officer, and a careful inspection should always be made before a march of more than a few hours' duration. This inspection should be made sufficiently far in advance of the march to permit obtaining proper shoes and socks and the correction of defects found. At this inspection, attention should be given to improperly trimmed toenails and to the detecting of reddened areas which are evidence of either poorly fitting shoes or poorly repaired socks. The early signs of such foot defects as ingrowing nails, callouses, and corns should also be sought. If the inspection is made preparatory to a march, particular care should be taken that all men have properly fitting shoes and woolen socks, and that none are wearing repaired socks or socks with holes.

■ 109. RULES FOR AVOIDING DISEASE DURING FIELD SERVICE.—

The following general rules apply particularly to service in the field, but most of them apply equally in permanent camps or stations:

*a.* Do not drink water which has not been declared potable by a medical officer unless it has been purified by boiling or chlorination. Do not take water from a water sterilizing bag by dipping a cup into the bag or putting your mouth to the faucet.

*b.* Do not soil the ground with stools or urine. Always use the latrine or the night urine can provided in the company street.

*c.* Be sure that the mess kit, knife, fork, and spoon are thoroughly washed in soapy water and rinsed in boiling water after they are used.

*d.* Use a mosquito bar in regions where mosquitoes are prevalent. See that it is well tucked in and is free from holes.

*e.* Do not sit or lie directly on the damp ground. Avoid drafts when perspiring or while the clothing is damp.

*f.* Ditch the tents as soon as put up, even if the camp is only for one night.

*g.* Prepare the beds before dark. In temporary camps or bivouac, raise the beds if suitable material such as straw,

leaves, or boughs can be obtained. The raincoat should be used as a ground sheet.

*h.* Never use a cup which is used by others. Do not exchange pipes, cigars, musical instruments played with the mouth, gas masks, handkerchiefs, towels, or shaving outfits.

*i.* In camp where water is plentiful, drink plenty of water at intervals during the day but do not drink a large amount at one time either in camp or on the march, especially when overheated after exertion. On the march do not drink water every time you feel thirsty. The rule should be to drink as little as possible at a time and endeavor to arrive at the end of the march with some water still left in the canteen.

*j.* Acquire the habit of having the bowels move regularly once each day and at as nearly the same time as possible.

*k.* Wear clothing of proper weight for the climate. Clothing should fit loosely. Wet clothing, particularly shoes and socks, should be changed as soon as opportunity permits.

*l.* Keep the hair cut short and the fingernails clean.

*m.* Never throw pieces of food or refuse around the camp or in the trench. Such debris attract flies, and flies carry disease organisms.

*n.* If possible, avoid all contact with diseased persons.

*o.* Avoid venereal diseases. These diseases are almost always contracted by sexual intercourse with an infected woman. If sexual intercourse is had, report as soon as possible (should be within hour after exposure) to the hospital or other designated place for "prophylaxis." This prophylactic treatment must be carried out thoroughly and the directions followed exactly if its full protective value is to be obtained.

■ 110. IMPROVISED BATHING FACILITIES.—*a.* Wash benches should be constructed in any camp lasting more than 1 day. They should be located at the end of the company street nearest the latrine. The wash water may be disposed of in shallow trenches or even onto the surface of the ground if the camp is to be of brief duration. Otherwise, a grease trap and soakage pit or trench should be installed, since accumulation of a soap film will eventually prevent soakage into the ground. (See par. 30.)

b. Bathing in streams is an excellent solution to the problem of personal cleanliness, providing a reasonably clean stream is convenient to the camp. The part of the stream to be used should be designated by markers or flags.

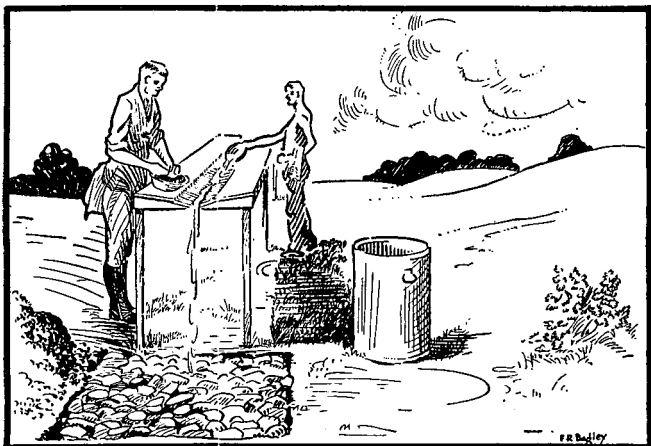

FIGURE 72.—Wash bench showing center trough draining into a soakage pit.

■ 111. MONTHLY PHYSICAL INSPECTION.—a. Paragraph 1, AR 615-250, requires that a physical inspection of all enlisted men be made at least once each month. Noncommissioned officers of the first three grades may be excused from this inspection at the discretion of the commanding officer. The inspection is conducted by a medical officer but it is required that an officer from each company be present when his company is being inspected. The company officer should note and promptly arrange for correction of any defects found. In the absence of a medical officer or contract surgeon, this inspection is conducted by an officer of the company concerned.

b. This examination is not, as often erroneously believed, for the sole purpose of detecting venereal disease. It should include—

(1) An examination of the feet and footwear, the mouth and teeth, and the state of personal cleanliness.

(2) Investigation for evidence of communicable diseases, including venereal disease and vermin infestation.

(3) Inspection for evidence of any chronic disease.

## CHAPTER 10

### FIRST AID

	Paragraphs
SECTION I. General.....	112-113
II. Treatment of wounds.....	114-116
III. Shock.....	117
IV. Fractures, dislocations, and sprains.....	118-119
V. Artificial respiration.....	120-122
VI. Gas casualties.....	123-124
VII. Injuries due to heat and cold.....	125-127
VIII. Poisonous bites and stings.....	128-130
IX. Common emergencies.....	131-138
X. Transportation of wounded.....	139-140

#### SECTION I

#### GENERAL

■ 112. **GENERAL.**—First aid consists of the temporary emergency treatment given in a case of sudden illness or accident before the services of a medical officer can be secured. This temporary care if intelligently given will often save a life. In all cases first aid, properly administered, will reduce mental and physical suffering and thereby place the patient in the medical officer's hands in a better condition to receive further treatment. Very often the only first-aid care that is necessary is to prevent further injury to the patient by well-meaning but ignorant meddlers. Unit commanders are responsible that members of their units receive adequate training in first aid.

■ 113. **GENERAL DIRECTIONS.**—The following precautions apply to the application of first aid in any situation:

*a.* Do not move the patient until the extent of the injury is determined. Keep the patient lying in a comfortable position, with the head level with the body. Many types of injuries require skilled preparation before they can be safely transported to a hospital. Hurried transportation by unskilled persons may aggravate injuries or even prove fatal to the patient.

*b.* Keep cool; do not handle the patient hurriedly or roughly; keep bystanders away from the injured.

*c.* Keep the patient warm; be sure he is covered and is not being chilled from contact with the ground.

*d.* Do not give liquids to an unconscious patient; they may enter the windpipe and strangle him.

*e.* Do not try to do too much; if the injury appears to be a serious one, bring medical assistance to the patient rather than transporting the patient to a hospital.

## SECTION II

### TREATMENT OF WOUNDS

■ 114. GENERAL.—*a.* A wound is a break in the skin or in the mucous membrane of one of the body cavities. Incised wounds are made by sharp cutting instruments such as knives, razors, and broken glass. Lacerated wounds are irregular and torn. They are caused by contact with angular surfaces such as shell fragments or by machinery. Puncture or stab wounds are caused by penetrating objects such as nails, wire, or bullets.

*b.* Infection and severe bleeding are the principal dangers from any type of wound. Rapid bleeding requires immediate attention. In most cases bleeding is readily controlled if fundamentals are known and applied. Infection can occur whenever the skin surface is broken. The size or location of the wound is not related to the possibility of infection; a skin puncture with an ordinary pin may become infected. A wound should never be touched with anything except sterile dressings or instruments. The contact of unclean hands, bandages, or instruments may infect a wound that otherwise is relatively clean.

■ 115. APPLICATION OF FIRST-AID TREATMENT.—*a.* Steps in treatment:

(1) Expose the wound completely by removing, cutting, or ripping the clothing or footwear.

(2) If an antiseptic such as iodine is available, apply it to the wound and to the skin for 1 inch around the wound. If no antiseptic is available, this step is omitted.

(3) Apply a sterile dressing to the wound, preferably one from a first-aid packet.

(4) Take additional steps to control bleeding if necessary. (See par. 116.)

(5) Try to prevent shock by keeping patient warm and quiet (par. 117).

(6) Have the wound re-dressed by a medical officer as soon as possible. Special surgical treatment or the use of sera against tetanus and gas gangrene may be necessary.



FIGURE 73.—First-aid treatment.

*b. Precautions.*—In order to avoid infection or aggravation of the injury, the following precautions should be observed:

(1) Do not touch the wound with the hands, mouth, clothing, or other unclean object.

(2) Do not wash the wound with any solutions such as soap and water.

(3) Do not massage or squeeze the wound. This might start severe bleeding and certainly will injure the tissues.

(4) Do not attempt to explore the wound or remove blood clots.

(5) Never use iodine in or around the eyes, or in a body cavity.

*c. Use of the first-aid packet.*—(1) The first-aid dressing is carried by all military personnel. It is contained in a sealed metal container, whose seal must be broken to remove the dressing. The dressing consists essentially of a thick pad of absorbent material to which are attached two double-tailed rolls of bandage. When removing the wrapper and applying the dressing, the hands should touch only the bandage and the papered side of the dressing. The paper is colored to aid in its recognition.

(2) The unpapered side of the dressing is applied to the wound. The bandage is then snugly secured about the limb or part by tying or pinning the ends. If a missile has gone completely through an arm or leg, a dressing should be applied to one of the wounds without unrolling its bandage. A second dressing is then applied to the other wound, and its bandage used to secure both dressings.

(3) It may be necessary to use the contents of several packets to cover very large wounds.

■ 116. HEMORRHAGE.—*a. Varieties.*—There are three varieties of hemorrhage (bleeding) as follows:

(1) *Arterial.*—An arterial hemorrhage is bleeding from an artery. The loss of blood may be very rapid. The blood spurts from the wound with each pulsation of the heart beat and is bright red in color.

(2) *Venous.*—A venous hemorrhage is bleeding from the veins. The flow of blood is steady and the color is dark red.

(3) *Capillary.*—A capillary hemorrhage means bleeding from very small blood vessels and is manifested by oozing of blood from the wound. It is ordinarily not severe.

*b. Control of hemorrhage.*—Most mild hemorrhages will cease by natural means. This results from a blood clot forming in the wound, preventing the further escape of blood. More severe hemorrhages, particularly arterial and venous ones, usually require one or more of the following artificial measures for control:



(1) *Elevation.*—Elevating a wounded extremity will aid in the control of hemorrhage by decreasing the volume of blood in the injured part and thereby encouraging the natural tendency to cessation of bleeding.

(2) *Pressure.*—(a) *Direct pressure.*—Direct pressure is the most common and safest method for the control of bleeding. If sterile gauze or bandage material is available, it can be

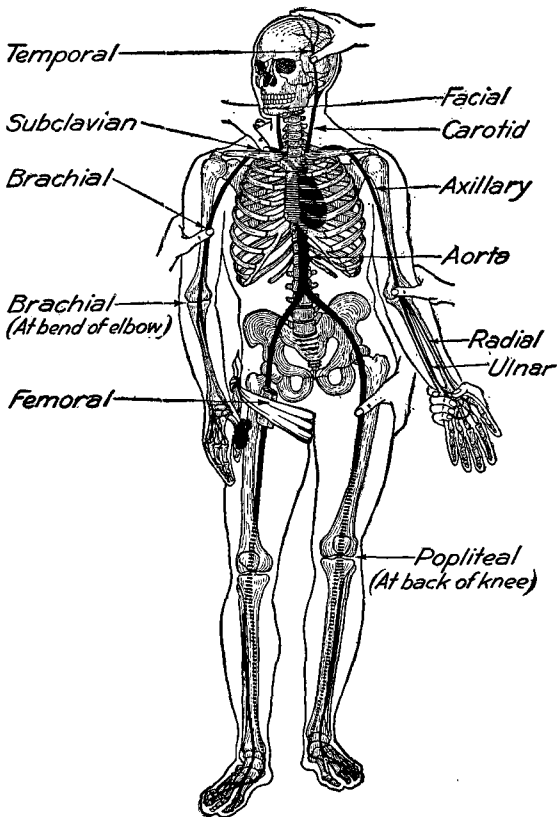

FIGURE 74.—Course of arteries and pressure points.

used for direct pressure on the wound and held in place until a dressing is applied or a tourniquet adjusted. The dressing itself can be adjusted so as to exert some pressure.



FIGURE 75.—Course of arteries and pressure points—head and neck.

(b) *Pressure with the fingers.*

1. When direct pressure on the wound does not control the bleeding, pressure upon the blood vessel between the heart and the wound is necessary. At certain places in the body, large arteries lie near bones and may be compressed to decrease the flow through them. Pressure may be applied with the fingers until a tourniquet can be applied.
2. The following are the principal pressure points:
  - (a) *Scalp.*—Apply pressure with the tips of the fingers in front of the ear just above where the lower jaw can be felt working

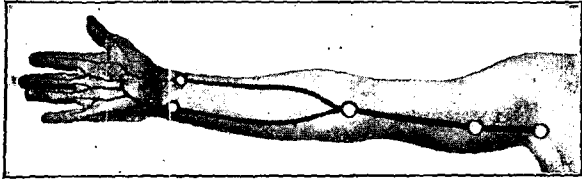

FIGURE 76.—Course of arteries and pressure points—upper extremity.

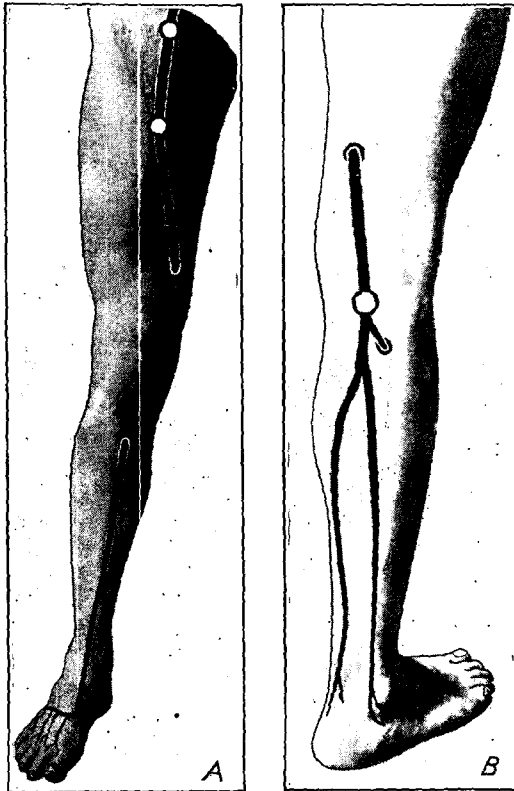

FIGURE 77.—Course of arteries and pressure points, lower extremity:  
*A*, front view; *B*, back view.

in its socket. A branch of the temporal artery crosses the temple on the line between the upper border of the ear and the upper border of the eyebrow.

- (b) *Neck and head.*—Press the thumb and fingers deeply into the neck in front of the strongly marked muscle which reaches from behind the ear to the upper part of the breastbone.



FIGURE 78.—Pressure points: A, temporal pressure point; B, carotid pressure point; C, brachial pressure point; D, femoral pressure point.

- (c) *Shoulder and armpit.*—Press the thumb deeply into the hollow behind the middle of the collar bone. This compresses the large subclavian artery.
- (d) *Arm or hand.*—Press outward against the bone just behind the inner border of the large muscle (biceps) of the arm. This compresses the brachial artery.

(e) *Thigh, leg, or foot.*—Press strongly with the thumbs at the upper part of the inside of the thigh where the large artery passes over the bone. This compresses the femoral artery.

(c) *Tourniquet.*

1. The use of a tourniquet is a dangerous procedure. One should not be employed if bleeding can be stopped by any other means. A tourniquet consists of a pad which is pressed against an artery, and a strap which is used to obtain pressure on the pad. Medical Department personnel carry issue tourniquets as part of their equipment, but satisfactory ones can be improvised. The pad may consist of a roll of bandage, a stone wrapped in a handkerchief, or any other hard, smooth object. The strap may consist of a bandage, a cravat, a belt, or a handkerchief. The strap should be at least 1 inch wide so that it will not cut into the skin.
2. For the arm and hand the tourniquet pad is applied about a hand's breadth below the armpit. For the thigh and leg it is applied about a hand's breadth below the groin. After tying the strap loosely around the limb, the required degree of pressure is made by passing a stick or bayonet under the hand but opposite the pad, and twisting it so that the pad is pressed down firmly. The stick is anchored with a bandage. The pressure exerted should be as light as will stop the hemorrhage.
3. Since a tourniquet cuts off the entire blood supply to the injured part, precautions must be taken that the tourniquet is not left on too long or the limb will die (gangrene). It should be loosened at least every 20 or 30 minutes. It should not be covered with a bandage or splint or it may be forgotten. Some sort of tag should be attached to the man marked "tourniquet" and giving the date and hour when applied.

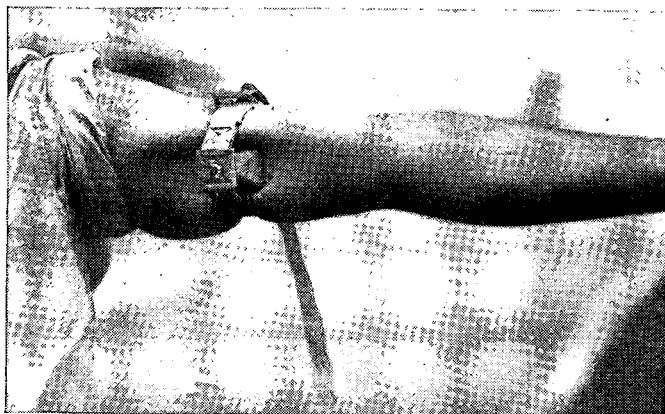

FIGURE 79.—Use of tourniquet application.



FIGURE 80.—Application of tourniquet to thigh.

## SECTION III

## SHOCK

■ 117. **SHOCK.**—*a. General.*—Shock is a profound depression of all physical and mental processes. This condition usually results from injury, but it may be caused by exposure, bleeding, fatigue, hunger, or extreme emotion. Some degree of shock follows all injuries; it may be slight, lasting only a few minutes, or it may be prolonged and end fatally. Where an injury is severe it can safely be assumed that a corresponding degree of shock will be present. Even if evidence of shock has not appeared after severe injury, it is well to anticipate it and to help prevent it by instituting shock treatment.

*b. Symptoms of shock.*—Part or all of the following symptoms may be present:

(1) The patient feels weak, faint, and cold, and may feel nauseated.

(2) The face is pale and pinched, and has an anxious and frightened appearance.

(3) There is listlessness and possibly a general loss of sensation with beginning stupor.

(4) The skin is cold and clammy.

(5) The breathing is irregular and sighing.

(6) The pulse is weak and rapid.

*c. Treatment of shock.*—(1) Place the patient flat on his back with the head low.

(2) Control the hemorrhage if any is present.

(3) Loosen all constricting clothing.

(4) Avoid unnecessary movement of the injured part or of the patient; pain will result and shock will increase. Move patient no more than absolutely necessary before medical assistance arrives. If movement is necessary, apply the other shock treatment measures before moving the patient.

(5) Apply heat to the body. This is the most important factor in preventing and treating shock. Additional clothing and blankets may be used. External heat may be applied by means of bottles or canteens filled with hot water, hot stones, or hot bricks. These hot objects may be placed between the legs, under the armpits, and beside the waist. They should not be placed directly against the bare skin or against very

thin clothing as a burn may result. Care should be taken not to expose the patient to chilling while he is being examined and treated.

(6) Stimulants given by mouth are valuable but cannot be used in all cases. They should never be given to unconscious patients, patients who are bleeding, or patients with skull fracture, apoplexy, sunstroke, or a wound of the abdomen. The best stimulants are hot drinks such as water, coffee, tea, or chocolate. A teaspoonful of aromatic spirits of ammonia in water is also valuable.

(7) Treatment of shock must be continued for a considerable period of time. The patient should be watched constantly until evidence of shock has disappeared.

## SECTION IV

### FRACTURES, DISLOCATIONS, AND SPRAINS

■ 118. FRACTURES.—*a. General.*—(1) A fracture is a break in a bone. A simple fracture is one in which there is no wound extending from the broken bone through the skin. A compound fracture is one in which the wound extends from the broken bone through the skin and therefore is exposed to the dangers of infection from the outside. A complicated fracture is one where there is damage to adjoining large vessels, nerves, or muscles which is a contributing factor in causing shock.

(2) In no injury is the ultimate outcome more influenced by the character of first-aid treatment than in fractures. Improper handling or immediate transportation prior to immobilization of the limb may produce or aggravate shock and deprive the patient of a chance for recovery. All fractures or suspected fracture cases should be handled gently. It is equally as important to know what not to do as to know what to do. In splinting, two mechanical principles are involved:

(a) *Fixation* to obtain rest for the injured parts, to retain them in proper alinement, and to favor their union.

(b) *Traction* to obtain muscular relaxation with the object of diminishing pain and overcoming muscular contraction which might result in faulty position of the injured parts, to



secure proper alinement by a pull in the direction of normal anatomical lines, and to prevent the displacement of bony fragments with consequent injury to nearby nerves, muscles, and blood vessels.

(3) In certain cases, immediate movement of the patient is very detrimental. The first-aid treatment should be administered where the patient lies; medical assistance should be brought to the patient rather than the patient transported to the medical officer. This is especially true of fractures of the thigh, pelvis, or back and in all cases when there is evidence of shock. In any event, depending on the severity and nature of the case, one or more of the general first-aid measures are usually indicated.

*b. Signs and symptoms of fracture.*—Part or all of the following signs and symptoms may be present:

- (1) Pain and tenderness at the point of fracture.
- (2) Partial or complete loss of motion.
- (3) Deformity.
- (4) Swelling and later, discoloration.
- (5) Crepitus or grating may be felt, but no attempt should be made to produce this sensation.

*c. First-aid treatment.*—(1) *General.*—Splint the patient where he is. Do not transport or move him about until some type of splint is in position. Except where the bone is protruding, straighten the limb by pulling gently but steadily upon the lower end of the extremity. Maintain this steady traction and support the limb on either side of the fracture until a splint is applied. A splint should be as wide as the limb, and long enough to immobilize the next joint in either direction from the fracture. If no issue splints are available, temporary splints may be improvised from many common materials such as shingles, pieces of board, bayonets or scabbards, pieces of tin, mesh wire, bundles of twigs, rifles, folded blankets, pillows, or any other rigid or semirigid materials. It is important that splints be well padded on the side toward the skin, and that they be securely bound by bandaging or tying them at several points above and below the fracture but not over the fracture. Caution must be exercised that they are not so tightly bound as to cut off the circulation as swelling of the limb occurs. The splint and limb should be

examined at least every 30 minutes to be sure the circulation is not cut off.

(2) *Treatment of fractures with wounds.*—In fractures with wounds or hemorrhage, the wound should be dressed and hemorrhage controlled before a splint is applied. Even



FIGURE 81.—Sling made from ordinary bandages.

if bleeding is slight, it is a safe precaution to place a tourniquet loosely about the part so that, if bleeding should start, it can be quickly controlled. If the bone is protruding through the skin, it should not be pushed back with the hands. Apply iodine to the exposed bone and to the wound. Place a sterile dressing over the wound. Then apply traction to the extremity.

(3) *Slings*.—Fractures of the upper extremities should be supported by a sling after splinting. A triangular bandage makes the best sling. However, arm slings may be made from ordinary bandages, or may be improvised from the ordinary clothing by using safety pins to fasten the coat sleeve to the



FIGURE 82.—Sling made from ordinary clothing.

front of the coat to support the arm. The coat flap may be used for the same purpose by pinning it, or by punching a hole through the lower edge of the flap and buttoning this to a coat button.

(4) *Application of splints*.—(a) *Fracture of the forearm*.—With the forearm flexed to a right angle, thumb up, apply a splint to the inner surface, extending to the tips of the fin-

gers, and another to the outer surface, extending to the wrist.

(b) *Fracture of the upper arm.*—Apply two splints from the shoulder to the elbow, one in front and the other behind, if the lower part of the bone is broken; apply to the inner



FIGURE 83.—Splints for forearm.

and outer sides, if the fracture is in the middle or upper part; support by a sling.

(c) *Fracture of the collar bone.*—Flex the forearm to a right angle in front of the body and place in a sling.

(d) *Fracture of the leg or ankle.*—Apply two splints, one on the outside, the other on the inside of the limb, extending from the knee to beyond the foot.

(e) *Fracture of the thigh.*—Administration of first-aid treatment where the patient lies is the method of choice. Splinting should not be attempted by the inexperienced

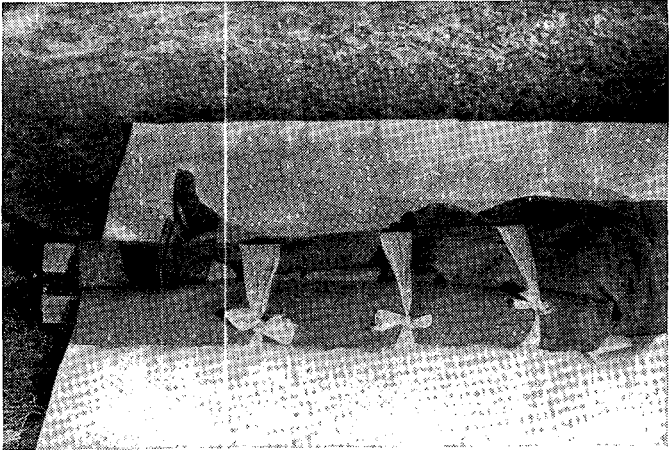

FIGURE 84.—Splints for leg or ankle.

unless unusual circumstances make it necessary that the patient be moved some distance at once. Proper traction applied to the limb below the fracture is absolutely essential to provide effective first-aid treatment which will permit transportation without danger of producing further injury and shock. To do this requires a special splint applied by one experienced in its application. If the patient must be moved, carry gently as possible, paying special attention to the support of the injured limb in the extended position.

(f) *Fracture of the hip or pelvis.*—The patient should be prepared for transportation by a medical officer. If absolutely necessary to move him, a splint should be applied, extending from the armpit to the foot. This should be securely anchored at several points.

(g) *Fracture of neck or back.*—The patient should not under any circumstance be moved except by skilled medical personnel. In fracture of the neck the head should be gently

straightened and steadied by the hands or by pads on either side of the neck. In fracture of the back it is best to lay the patient flat on his stomach.

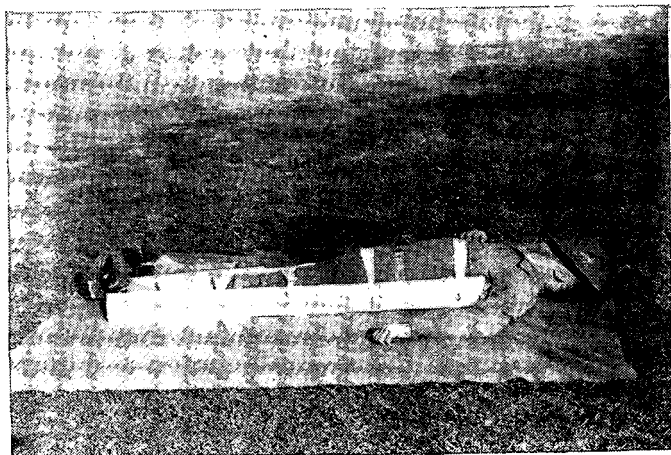

FIGURE 85.—Splints for hip or pelvis.

■ 119. DISLOCATIONS AND SPRAINS.—*a. General.*—When a bone gets out of place at a joint, the condition is called a dislocation. When the ligaments about a joint are torn or bruised, the condition is called a sprain. In these conditions the pain is usually severe, marked swelling rapidly occurs, and shock may be present. It is often impossible to distinguish a sprain or dislocation from a fracture without an X-ray examination.

*b. Treatment.*—(1) Elevate the part. If this is an upper extremity, elevate by means of a sling. If it is the lower extremity, have the patient in the prone position with pillows, coats, or other support under the raised leg.

(2) Apply cold applications to the site of injury early to retard swelling. If the injury is over 2 hours' old, hot applications are more valuable. Plain hot water is as efficient as any solution for this purpose.

(3) Keep the patient warm. If shock is present, treat it (par. 117).

(4) When in doubt, treat the case as a fracture and apply splints, especially if the patient must be transported.

(5) Never attempt to reduce a dislocation as permanent damage may be done.

## SECTION V

### ARTIFICIAL RESPIRATION

■ 120. GENERAL.—Asphyxia, suffocation, or cessation of breathing occurs most frequently in drowning, electrical shock, and gas poisoning. The safest and most effective method of applying artificial respiration is the prone pressure or Schaefer method. Oxygen respirators, which are available at many bathing beaches and military stations, are very efficient in trained hands, but for unskilled personnel, are less satisfactory than the Schaefer method.

■ 121. DROWNING.—*a. General.*—Being under water for over 5 minutes is usually fatal, but an effort to revive the apparently drowned should always be made unless it is known that the body has been under the water for a long time. It is very important that artificial respiration be started at the earliest possible moment after the patient has been removed from the water.

*b. Technique of resuscitation.*—(1) Lay the patient face down, force his mouth open, pull the tongue forward, and remove false teeth, juice, vomitus, or debris from his mouth and throat.

(2) Raise him by the hips in order to drain the water from his lungs.

(3) Lay him on his belly, preferably at a spot where his head will be lower than his feet. One of his arms should be extended over his head, the other bent at the elbow so that his face can be turned to the side and rest on the hand.

(4) Kneel astride the patient's thighs, with your knees placed at such a distance from his hips as will allow you to exert the pressure on his lower ribs as described below. Place the palms of your hands on the small of his back with your

fingers on his lower ribs, your little fingers just touching his lowest rib, with your thumbs and fingers in natural position and the tips of your fingers out of sight just around the sides of his chest wall. The heels of the hands should be placed as far from the backbone as possible without slipping off.

(5) With your arms held straight, swing forward slowly so that the weight of your body is gradually brought to bear upon the patient. Do not bend your elbows. This operation should take about 2 seconds.



FIGURE 86.—Artificial respiration, first position.

(6) Now immediately swing backward so as to remove all pressure completely and suddenly. Leave the hands in place if possible.

(7) After about 2 seconds repeat the operation. The cycle of compression and release should take about 4 or 5 seconds and should be repeated at the rate of 12 to 15 times per minute.

(8) Continue the operation without interruption until natural breathing is restored, or until the subject is unquestionably dead. Remember, many patients have died because arti-



ficial respiration has been stopped too soon. Always continue the operation for 2 hours or longer.

(9) Aside from the resuscitation, the most valuable aid that can be rendered is keeping the patient warm. After artificial respiration has been started, have an assistant loosen the clothing and wrap the patient in any clothing that is available. Use hot brick, pads, heaters, or similar means, but be sure the person is not burned by your treatment.



FIGURE 87.—Artificial respiration, second position.

(10) When the patient revives he should be kept lying down and not allowed to stand or sit up; this will prevent undue strain on the heart. Stimulants such as hot tea or coffee, or aromatic spirits of ammonia, can be given as soon as the patient is perfectly conscious.

(11) At times a patient, after temporary recovery of respiration, stops breathing again; artificial respiration should be resumed at once.

(12) Due to the length of time this operation may be kept up, one, two, or more operators may be necessary. A change of operators can be made without loss of rhythm of respira-

tion. If this point is remembered no confusion will result when the change occurs and the respiratory count will be kept even. The great danger is stopping artificial respiration prematurely. In many cases, breathing has been established after 3 or 4 hours of artificial respiration, and there are instances where normal breathing has been reestablished after 8 hours. The ordinary and general tests for death should not be accepted; a medical officer should make several careful examinations at various intervals before the procedure is allowed to be stopped.

■ 122. ELECTRICAL SHOCK.—The rescue of the victim from a live wire is always dangerous. If the switch is near, turn the current off, but lose no time in looking for the switch. Use a dry stick, dry clothing, dry rope, or some other dry non-conductor in removing the victim from the wire. Start artificial respiration immediately. Do not regard early stiffening as a sign of death; always keep up the artificial respiration for several hours.

## SECTION VI

### GAS CASUALTIES

■ 123. PEACETIME GASES.—The chief poisonous gases encountered in civil life are illuminating gas, carbon monoxide (motor exhausts), charcoal, and mine gases. The first thing to do in all of these gases is to get the patient into fresh air. The fresh air of a warm room is preferable to extremely cold air. If breathing is weak or irregular or has stopped, artificial respiration should be started and continued until normal respiration has been established. A medical officer should always be called, since the patient may die even after breathing is apparently normal.

■ 124. GASES IN WARFARE.—*a. General.*—Prompt and proper first-aid treatment for gas casualties is of vital importance. Proper treatment will minimize the effects of the gas and will often prove the deciding factor in the outcome of the case. There are certain simple rules which all individuals must know. Unit commanders are responsible for the training of members of their commands in first aid for gas casualties.

They are also responsible for the intelligent early handling of gas casualties prior to evacuation.

*b. First-aid rules.*—The detailed protection against and treatment for the various gases used in warfare are given in FM 21-40. The following simple general rules should be understood by all individuals:

(1) Wear mask and gloves when handling a gassed man. If gloves are not worn, wash hands thoroughly with soap and water, or rub them with dry lime, after handling such cases.

(2) Remove the casualty or the suspected casualty from the contaminated area as quickly as possible.

(3) Remove the patient's clothing and equipment unless undue exposure to cold will result, but leave his mask on until certain that the air is free from gas.

(4) If possible, remove all gassed cases from woods or low ground to knolls or hillsides. Do not carry them into dugouts or cellars, since most war gasses are heavier than air.

(5) Do not allow cases affected by lung-irritant gasses to walk or talk. The apparent mildness of these cases is often misleading.

(6) Remember that the clothing, equipment, or bodies of cases gassed with vesicants may contaminate anything with which they come in contact. Thus blankets, litters, or areas on the ground occupied by such cases should be avoided by ungassed persons.

(7) Prevent patients with vesicant-gas injuries from rubbing their eyes, mouths, or genitals. Do not bandage the eyes.

*c. Special measures.*—See FM 21-40.

(1) *Lacrimators.*—Men who are lacrimated do not require evacuation as casualties. They only need to leave the contaminated atmosphere and face the wind, allowing it to blow into their eyes. They should not rub their eyes; their clothing and equipment should be loosened so as to get rid of entrapped gas. Bathing the eyes in cold water or with a weak boric acid or sodium bicarbonate solution will aid.

(2) *Irritant gases (sternutators).*—These agents, such as DM, are not lethal in field concentrations. They may, however, cause such disability as to require evacuation.

(a) Remove patient from the contaminated atmosphere, keep away from heat, and remove outer clothing. Flush the nose and throat with a weak solution of sodium bicarbonate (baking soda) or of ordinary salt.

(b) Breathing chlorine in low concentrations tends to alleviate the irritation. In lieu of other facilities, this may be accomplished by breathing from a bottle containing bleaching powder (chloride of lime), or from a mixture of alcohol, chloroform, and ether. The exposed surface of the body should be washed with soap and water.

(3) *Lung irritants*.—In order to reduce his oxygen requirements to the minimum possible, a lung irritant casualty should be made to lie down and not allowed to walk to an aid station even though he insists that he is able to do so. He should, as soon as possible, be removed from the contaminated atmosphere, his equipment removed, his clothing loosened, and he should be kept warm. In addition to wrapping him in blankets, nonalcoholic stimulants such as hot coffee or tea should be given; and he should be evacuated as soon as possible as an absolute litter case.

(4) *Vesicants*.—All of the agents classed as "vesicants" have also a powerful lung irritant action.

(a) *Mustard gas*.—The casualty should be immediately taken out of the contaminated atmosphere or area and his contaminated clothing removed. Should only portions of the clothing be splashed with liquid mustard, these can be cut away. If the face has been exposed, wash the eyes and rinse the nose and throat with a saturated boric acid, weak sodium bicarbonate, or common salt solution. If the vapor has been breathed, the individual should be treated and handled as a lung irritant casualty. First aid must be prompt for little can be done later than 30 minutes after exposure.

Vapor burns on the skin may be lessened or even prevented by thorough cleansing with soap and water (preferably hot) immediately after exposure. Cleansing the exposed parts with gasoline or kerosene prior to the use of soap and water will facilitate the removal of all traces of the gas.

Mustard burns or skin areas wet with liquid mustard should be immediately and repeatedly swabbed with a solvent such

as kerosene, gasoline, any oil, alcohol, or carbon tetrachloride (pyrene).

Fresh cloths should be used and the spreading of the contamination should be avoided. After cleansing with the solvent, the affected parts should be thoroughly washed with soap and hot water. Cloths used in removing the liquid mustard will be contaminated and should be burned or buried after use. A weak, freshly prepared solution of chloride of lime in water may be used in place of the oily solvent; this solution is itself very irritating to the skin and must, therefore, be removed by subsequent washing with soap and water.

Fresh, uncontaminated clothing must be supplied where necessary. All casualties should be evacuated as soon as possible.

(b) *Lewisite*.—To be of any value against lewisite, first aid measures must be instituted almost immediately. The treatment is similar to that for mustard.

In lewisite burns, whether from vapor or liquid, the danger of poisoning from absorbed arsenic far overshadows the effect of the actual burn; it is, therefore, imperative to neutralize, if possible, any arsenic present and not yet absorbed. This may be accomplished by the immediate application of some hydrolyzing agent. A 5-percent aqueous solution of sodium hydroxide (caustic soda) has been found very efficient if applied soon enough.

Following this, or in the absence of the hydroxide solution, vapor burns should be thoroughly cleansed with soap and water and then dressed with a ferric hydrate paste. The paste should be spread on thickly, covered with gauze, and allowed to remain for 24 hours. Following the hydroxide solution and cleansing with soap and water, liquid burns should be repeatedly swabbed with some oily solvent as suggested for mustard, again washed with soap and water, and dressed.

Fresh, uncontaminated clothing must be supplied where necessary. All casualties should be evacuated as soon as possible.

(5) *Incendiaries*.—(a) For burns from incendiaries other than white phosphorus, treatment and handling are the same as for ordinary heat or fire burns.

(b) For phosphorus burns, immerse the affected part in water to stop the burning of the phosphorus and pick out the solid particles from the flesh. Wet cloths, mud, or damp earth may serve the purpose if immersion in water is not possible. As phosphorus melts at approximately 111° F., if hot water is used, the melted particles may be removed with a cloth or sponge.

The prompt application of an approximately 2- or 3-percent solution of copper sulphate in water will form a thin coating of copper phosphides on the phosphorus particles, which will stop their burning at once. The coated particles can then be picked out from the flesh. The copper sulphate solution should be applied by soaking a pledget of cotton, a sponge, or a piece of cloth in the solution and then placing it on the phosphorus. A minute or two is sufficient time for the formation of the metallic covering coat. After removal of the phosphorus, the burns should be dressed. All severe cases should be evacuated.

## SECTION VII

### INJURIES DUE TO HEAT AND COLD

■ 125. BURNS.—*a. General.*—Burns may be caused by dry or moist heat, electricity, and chemicals. They are classified in degree according to the depth to which the tissues are injured. Shock and infection are to be feared in dry burns.

(1) *First degree.*—The skin is reddened but there is no blister.

(2) *Second degree.*—The skin is blistered.

(3) *Third degree.*—The skin is destroyed or charred, as from contact with flames.

*b. Treatment of burns.*—(1) *General rules.*—The following general rules apply to the first-aid treatment of all burns:

(a) Do not pull the clothing from the burned part; snip or cut it off.

(b) Do not break or prick blisters if present.

(c) Treat shock early in all severe burns.

(d) When possible, protect the burn quickly with a sterile dressing, applying medication as indicated in (2) to (5) below.

(2) *First-degree burns*.—The treatment is directed toward the relief of pain since the skin is unbroken and there is no danger from infection. Any substance that will relieve the pain is satisfactory. An oily substance such as petrolatum (vaseline), olive oil, or castor oil is usable. Cold water or soda in water is soothing when immediately applied. It must be remembered that if the burn is at all serious, such as encountered in second- or third-degree burns, oily substances are not to be applied.

(3) *Second-degree burns*.—Here the injury must be regarded as an open wound; only material that is known to be clean can be used. Remove the loose clothing, but do not try to remove material that adheres to the skin. The application of sterile gauze soaked in a solution of Epsom salts (2 tablespoonfuls to a pint of boiled water) is very good. The dressings should be kept moist and warm until further aid is obtained. The best treatment is application of gauze saturated with 2-percent picric acid solution applied securely but not tightly. A 5-percent tannic acid solution similarly applied is of equal value. Never apply iodine or similar substances to a burn, and never apply absorbent cotton to a burned surface. Shock is always present to some degree in every case.

(4) *Third-degree burns*.—These are always serious and require medical attention promptly. The first-aid treatment consists chiefly of keeping the patient warm and treating shock. If medical attention can be obtained promptly it is best merely to lay a sterile dressing lightly on the wound. If over 30 minutes will elapse before help can be obtained, one of the dressings used for second-degree burns should be applied.

(5) *Chemical burns*.—Burns caused by acids or alkalies should be washed with large quantities of water, preferably lukewarm, until the chemical is thoroughly removed. All clothing should be cut away with scissors. Apply a salve dressing after the chemical is completely removed, and secure a medical officer's services. Phenol or carbolic acid burns should first be washed with alcohol if available. Eye burns require careful attention. The best first-aid treatment is to

flush the eye thoroughly with clean olive oil, mineral oil, or castor oil. If these are not available use water; a drinking fountain that throws a stream is excellent for this purpose. After washing, the eye should be covered with a moist dressing and further medical aid secured.

■ 126. **SUNSTROKE AND HEAT EXHAUSTION.**—Both these conditions are caused by excessive heat, but they differ entirely in their symptoms and treatment.

*a. Sunstroke.*—(1) *General.*—Sunstroke is a very dangerous condition usually caused by direct exposure to the rays of the sun, especially when the air is moist. The symptoms are headache, dizziness, oppression, and sometimes vomiting; the skin is hot and dry, and the face flushed; the pulse is rapid and full; the temperature is high, often ranging between 107° and 110°. Unconsciousness usually occurs and the body becomes relaxed; however, convulsions may occur.

(2) *Treatment.*—Remove the person to a shady, cool place if possible and loosen or remove the clothing. Lay the patient on his back with shoulders elevated. Apply cold to the head by means of wet cloths, ice bags, or ice. The brain cannot withstand the effects of high temperatures. Cool the body by giving cold baths for 20 minutes at a time combined with brisk massage of the limbs and trunk. Cold wet cloths or ice bags may be used. Wrapping the body in a sheet and pouring on cold water every few minutes is very effective. Do not overdo any of these procedures. Stop every few minutes to observe the effects on the patient. If the skin again gets hot repeat the treatment. Give no stimulant by mouth while unconsciousness lasts:

*b. Heat exhaustion* is caused by exposure to high temperature as encountered in boiler rooms, foundries, bakeries, and similar places. The first signs of heat exhaustion are dizziness, nausea, and uncertain gait. The face is pale, the body is covered with a profuse perspiration, and the skin is cold and clammy. Breathing is shallow, the pulse is weak, and the temperature may be normal or somewhat elevated. Fainting may occur, or prostration may become severe. Remove the patient to circulating cool air, place him in a supine position, and let him drink freely of cool salt water (1 teaspoonful of



table salt in a pint of water). Call a medical officer if the patient does not recover promptly.

■ 127. FREEZING.—*a. Frostbite.*—(1) The symptoms of frostbite are cold in the part, then pain, and finally, loss of sensation. The affected part becomes white or bluish white.

(2) Slowly thaw the frozen part by using extra clothing, applying it to another part of the body, or wrapping it in cloths soaked in cool water. Do not expose frozen tissues to a hot stove or radiator. Do not rub the frozen part either with the bare hands or with snow; the tissues will be bruised and torn, and gangrene may result. Medical attention is usually necessary after frostbite.

*b. Unconsciousness.*—When a man becomes unconscious from cold, if possible, carry him into a cool room, cover him well with blankets, and move his arms and legs gently but steadily. When consciousness returns, give him warm drinks and let him lie quietly.

## SECTION VIII

### POISONOUS BITES AND STINGS

■ 128. SNAKE BITE.—Treatment for snake bite should start immediately. The main effort is to prevent the poison entering the general blood circulation. If on a limb, a tourniquet should be tied around the limb just above the bite to increase the bleeding. A necktie, handkerchief, or bandage can be used as a tourniquet. It should be tight enough to prevent the blood flowing back through the veins, but not tight enough to prevent the blood flow in the arteries. In any event it should not be left on for a period greater than 1 hour. Whether or not the bite is on a part of the body where a tourniquet can be used, a cross incision,  $\frac{1}{2}$  by  $\frac{1}{2}$  inch, should be made over each fang mark, and preferably one to connect the two fang punctures. The cut must be deep enough,  $\frac{1}{4}$  to  $\frac{1}{2}$  inch, to insure free bleeding. Suction must then be applied for short intervals during at least  $\frac{1}{2}$  hour. This may be applied by the mouth, glass breast pump, or by heating a bottle and applying its mouth tightly over the wound. The cooling of the bottle will produce considerable suction. Snakes' venom is harmless

in the mouth unless there are cracks or wounds of the lips or inside of the mouth. The patient should be kept quiet and medical attention obtained as quickly as possible. Anti-venom may be given him, but the free bleeding produced by incision and suction is of far greater value. Whisky is not only useless in the treatment of snake bite but it is distinctly harmful because of its depressing effect. Cauterization of the wound and the use of various drugs, such as potassium permanganate, are also useless.

■ 129. INSECT BITES AND STINGS.—*a.* The proper removal of the stinger is important. This should be done by grasping the stinger with a pair of small forceps and removing it in its entirety. A paste made of baking soda, or a cold, moist dressing, using a dilute solution of salt, soda, or ammonia, is helpful.

*b.* Poisonous spider and insect bites should be treated in a manner similar to snake bites. A cross incision should be made and a loose tourniquet applied. Cauterization of the wound with a mild acid or with a hot implement is recommended. Shock, if present, should be treated and a medical officer called.

*c.* For the itching of mosquito or chigger bites, calamine lotion is very soothing. For extreme irritation 2 percent phenol may be added to the lotion. These preparations can be obtained at most dispensaries.

■ 130. ANIMAL BITES.—The first-aid treatment is the same as that for ordinary wounds. However, medical advice should be sought even if the wound seems trivial, since animal bites are commonly infected, unless dressed properly. If possible, the animal should be captured and examined to be certain that it does not have rabies.

## SECTION IX

### COMMON EMERGENCIES

■ 131. POISONS.—*a. General.*—The two principal points to be remembered in the treatment of poisoning are—(1) Poisons when diluted are not absorbed in as great quantities as when they are in a concentrated form.

(2) The stomach can be cleaned out by causing vomiting or by washing. Washing the stomach with a stomach tube should be attempted only by experienced personnel.

*b. Treatment.*—(1) Vomiting is the first step in treatment. The following fluids are useful in producing vomiting. From four to seven glassfuls should be given, preferably lukewarm. Tickling the throat with the finger will then usually induce vomiting:

- (a) Soap suds from any type of soap.
- (b) Salt water or soda water.
- (c) Lukewarm water.
- (d) 1 tablespoonful of mustard in warm water.

(2) Additional first-aid treatment for specific poisons is as follows:

(a) For carbolic acid (phenol) poisoning, give soap suds or milk.

(b) For the corrosive poisons such as bichloride of mercury, give milk or the whites of eggs.

(c) For iodine poisoning give starch in water.

(d) For strychnine poisoning, keep the patient quiet and call a medical officer.

(e) For overdoses of sedatives, keep the patient on his feet and make him walk. Give strong coffee and get him to medical attention.

(f) For wood alcohol, shoe dye, or like poisons, induce vomiting and get medical attention.

(g) For acute alcoholism (drunkenness) treatment is usually unsatisfactory and unnecessary. Inducing vomiting and giving strong coffee will speed recovery. Cold baths are dangerous and without value.

■ 132. REMOVAL OF FOREIGN BODIES.—*a. Foreign bodies in the eye.*—(1) Close the eye and allow the tears to accumulate. Do not rub the eye. After a few minutes open it again and the foreign body may be washed out by the tears. If the foreign body is under the lower lid, pull the lid down and have the patient roll the eye up and the foreign body may be easily brushed out by the corner of a clean handkerchief or a small swab made by wrapping a little cotton around the end of a match.

(2) If, as usual, the foreign body lies under the upper lid, grasp the eyelashes of the upper lid with the index finger and thumb of the left hand; place a match or pencil held in the right hand over the middle of the upper lid; then turn the lid over the match and the foreign body may be seen and removed. The corner of a clean handkerchief may be used, or the eye may be irrigated with clean water, using a small sterile syringe.

(3) If the object is embedded in the eyeball or eyelid, close the eye, apply a bandage lightly, and consult a medical officer. Never attempt to use a knife, toothpick, or pin to remove a foreign body.

(4) When acid is splashed into the eye an alkaline preparation made from soda, magnesia, chalk, or lime should be used.

(5) When strong alkalies get into the eye, weak acid solutions such as diluted vinegar or lemon juice are employed.

*b. Foreign bodies in the ear.*—The only safe method is to syringe the ear canal with lukewarm water. If the object does not come out, consult a medical officer. Never use pins or wire to dislodge these objects, as there is great danger of seriously injuring the eardrum. Insects in the ear can usually be killed by dropping in a little oil, and then washing the ear canal with a syringe.

*c. Foreign bodies in the nose.*—These usually present no immediate danger. Gentle blowing of the nose may be tried; if unsuccessful, drop in a little olive or mineral oil and consult a medical officer. Any attempt to remove the object with forceps or wire usually causes more swelling and lodges the foreign body more securely.

*d. Foreign bodies in the throat.*—(1) As the result of sudden interference with the breathing, the person clutches at his throat and gasps for air. There may be violent coughing or attempts to vomit, the face becomes blue, and the eyes stick out of their sockets.

(2) If another person is at hand, have him go or telephone for the nearest medical officer, notifying him of the nature of the accident so that he may bring the proper appliances. In the meantime attempt to dislodge the foreign body by slapping the back violently between the shoulder blades. If

this is not successful, hold the patient by his feet with the head down and have someone slap his back between the shoulder blades.

(3) If a foreign body such as a safety pin or a dental bridge has been swallowed, the patient should be promptly but gently transported to a hospital.

■ 133. PAIN IN THE ABDOMEN.—Pain in the abdomen may be due to a variety of causes, many of which may be serious. In any case where there is nausea and vomiting, accompanying or following pain over all or any part of the abdomen and with pain and tenderness in the lower right part of the abdomen, appendicitis should be suspected. Appendicitis may also occur without nausea. Always put suspected cases to bed and call a medical officer. As a general working rule, never give cases with abdominal pain or tenderness food, water, a laxative, or an enema unless ordered by a medical officer.

■ 134. UNCONSCIOUSNESS. — *a. General.* — Unconsciousness may be complete or partial. Frequently it is impossible to determine the cause, and treatment must be along general lines. An unconscious person with an odor of alcohol on his breath should not always be considered drunk. An intoxicated person may not have an alcoholic breath. It is always wise to consider the possibility of apoplexy and skull fracture in every case of unconsciousness. In examining an unconscious patient, look carefully for the cessation of breathing and for symptoms of poisoning, bleeding, or sunstroke, as special treatment for these must be given at once.

*b. Treatment.*—Lay the patient on his back with the head and shoulders slightly raised. Apply cold cloths or an ice pack to the head. Insist on absolute quiet; do not move the patient unless urgent and then do so very carefully. Have sufficient cover to keep him warm. Use no stimulants until the patient is awake and some cause for the condition is found. Call a medical officer.

■ 135. FAINTING.—Usually allow the patient to lie where he falls if he can be made comfortable. Lower the head and shoulders by elevating the hips. Loosen the tight clothing.

Sprinkling the face with cold water and inhalations of ammonia or smelling salts are beneficial.

■ 136. CONVULSIONS OR FITS.—*a. General.*—Convulsions may be due to a variety of causes, among them being epilepsy, hysteria, poisoning of various kinds, and various illness. The diagnosis is often difficult. A medical officer should be called promptly. The first aid treatment of convulsions consists essentially in loosening the patient's clothing, avoiding violent restraint, and protecting him from biting his tongue or doing himself bodily injury by threshing about.

*b. Epilepsy.*—(1) Epileptic fits may consist merely of momentary unconsciousness with slight muscular twitching, or they may be very serious. In the severe form, with or without premonitory sign, the subject usually utters a peculiar cry and falls into a convulsion. At first the entire body is rigid; then there is generalized jerking of limbs, contortions of the face, and foaming at the mouth. The eyeballs roll upward, and the pupils of the eyes are dilated (enlarged). The patient may bite his tongue and may have involuntary evacuation of his bowels and bladder. After a few minutes the convulsions are followed by profound stupor, and this generally merges into deep sleep. During the attack the patient usually is insensible to pain.

(2) The patient should be placed flat on his back, preferably on a mattress or other soft material, so that he cannot injure himself in tossing about. Force a rolled handkerchief or towel between his teeth to prevent his biting or swallowing his tongue. Do not use any more force than absolutely necessary to keep him from injuring himself. "Epileptic fits" are sometimes feigned. The feigned attack usually occurs at night when no one can see the patient. The man does not fall so as to hurt himself and does not bite his tongue. He flinches when the eyeball is pressed.

■ 137. HEAD INJURIES.—*a. General.*—(1) Comparatively mild blows on the head may cause concussion of the brain. This means actual bruising of the brain itself. This is the condition present when we say a man has been "knocked out" or "stunned." The usual symptoms are unconsciousness, pallor of the face, and quick and shallow breathing. The pupils

of the eyes are of equal size and are usually small. The degree of insensibility varies. Sometimes the patient can be aroused but is irritable and lapses again into unconsciousness. The duration of symptoms is dependent largely on the severity of the injury.

(2) More severe blows or falls on the head may cause fracture of the skull, hemorrhage within the skull, or compression of the brain. In these more severe injuries the patient cannot be roused. There may be bleeding from the nose or ears. The breathing is deep and snoring. There may be paralysis of part of the body.

*b. Treatment.*—It is often impossible to determine the severity of head injuries early. Therefore extreme caution should be observed. The patient should be laid flat, with the head slightly raised. He should be kept warm. No violent efforts to rouse him should be made. Shaking his head or slapping his face and neck are very dangerous procedures, since they may increase the injury. A medical officer should be called promptly. No stimulants should be given by mouth, but in the milder injuries aromatic spirits of ammonia may be inhaled with benefit.

■ 138. **APOPLEXY.**—Apoplexy is a condition due to sudden rupture or blocking of one or more blood vessels within the brain. It is most common in persons past 50 years of age, but may be seen in younger persons. The onset is sudden. Consciousness is usually lost. The face is flushed, one or both pupils dilated, the breathing is abnormal, and the cheeks puff out with each expiration. There is usually paralysis of one side of the body; this may be determined by lifting up the hands and legs and allowing them to fall slowly to the side. The one that is paralyzed will be cold and lifeless and will drop like a dead weight. The first-aid treatment is essentially the same as that for head injuries, rest and quiet.

## SECTION X

### TRANSPORTATION OF WOUNDED

■ 139. **TRANSPORTATION WITH LITTERS.**—*a. Service litter.*—The service litter is the most satisfactory means of transporting

patients over difficult terrain. It may be carried by two or four men, or may be attached to a wheeled field carrier.

*b. Improvised litters.*—Many objects and materials may be used to construct improvised litters:

(1) Camp cots, window shutters, doors, benches, and ladders, properly padded.

(2) Litters may be made with sacks, bags, or bedticks, by ripping the bottoms or snipping off the corners, passing two poles through them and tying crosspieces to the poles to keep them apart.

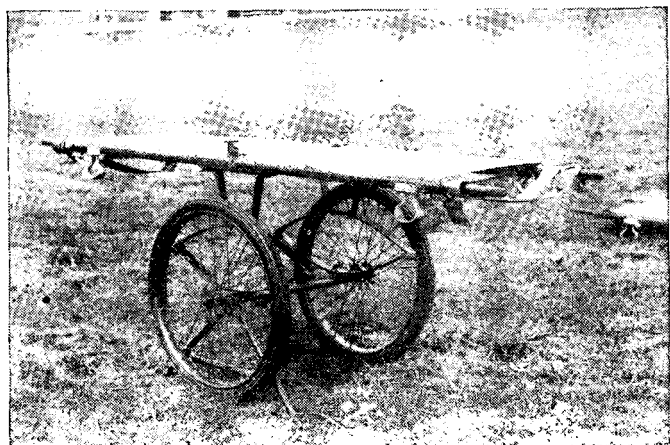

FIGURE 88.—Service litter.

(3) A shelter half, a blanket, a piece of matting, or carpet may be fastened to poles by tacks or twine.

(4) Hay, straw, or leafy twigs over a framework of poles and cross sticks make an efficient litter.

(5) Rope, wire, or rawhide may be woven between poles and this network covered with a blanket.

(6) The usual military improvisation is with blankets or shelter tents, and poles about 7 feet long. The blanket is spread on the ground. One pole is laid across the center of the blanket which is then folded over it. The second pole



is placed across the center of the new fold and the blanket is folded over the second pole as over the first and the free end of the blanket fixed.

(7) A litter also may be prepared by turning two or three blouses inside out and buttoning them up, sleeves in, then passing poles through the sleeves, the backs of the blouses forming the bed.

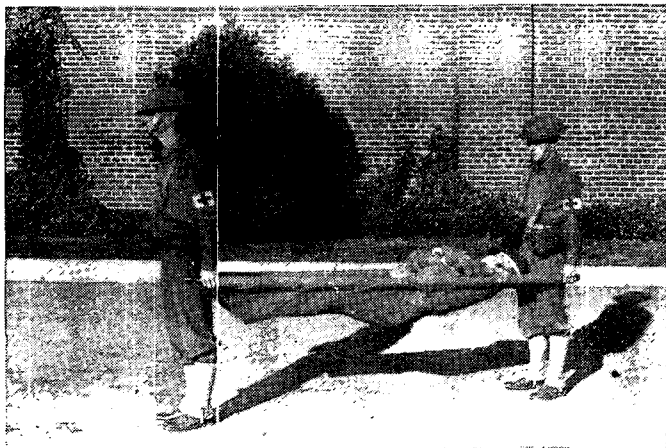

FIGURE 89.—Litter improvised with blankets.

#### ■ 140. METHODS OF REMOVING WOUNDED WITHOUT LITTER.—

*a. Rifle coat seat.*—A good seat may be made by running the barrel of a rifle through each sleeve of an overcoat, turned inside out and buttoned up, sleeves inside, so that the coat is back up, collar to the rear. The front bearer rolls the tail of the coat tightly around the barrels and takes his grasp over them; the rear bearer holds the rifles by the butts, trigger guards up.

*b. Rifle blanket seat.*—First a blanket is folded once from side to side, and a rifle laid transversely upon it across its center so that the butt and muzzle project beyond the edges. Next one end of the blanket is folded upon the other end and a second rifle laid upon the new center in the same manner as

before. The free end of the blanket is then folded upon the end containing the first rifle so as to project a couple of inches beyond the first rifle. The seat so formed is raised from the ground with trigger guards up.



FIGURE 90.—Rifle coat seat.

*c. One bearer.*—A single bearer may support a slightly injured man, or carry a patient in his arms, or on his back, or across his shoulders. If the patient is helpless, the last method is best. This is effected as follows:

(1) The bearer, turning the patient on his face, steps astride his body, facing toward the patient's head and, with hands under his armpits, lifts him to his knees. Then, clasping hands over the abdomen, he lifts the patient to his feet.

Next he seizes the right wrist of the patient with his left hand and draws the arm over his own head and down upon his left shoulder. He now shifts himself in front of the patient, stoops, and passes his right arm between the legs and grasps the patient's right wrist. Lastly, with his left



FIGURE 91.—Patient carried on back.

hand he grasps the patient's left hand and steadies it against his side as he rises.

(2) In lowering the patient, the motions are reversed. Should the patient be wounded in such a manner as to require these motions to be conducted from the right side instead of the left, as described, the change of method is

simply one of hands, the motions occurring as directed, substituting right for left and vice versa.

*d. Two bearers.*—The bearers take their positions with one man between the patient's legs and the other at his head, both facing toward his feet. The rear bearer, having raised



FIGURE 92.—Patient carried in arms.

the patient to a sitting posture, clasps him from behind around the body under the arms; the front bearer passes his hands from the outside under the flexed knees; then both raise the patient to the carrying position. This method requires no effort on the part of the patient. It should not be used in severe injuries of the extremities.

*e. Horseback.*—(1) The assistance required to place a disabled man on a mount will depend upon the site and nature of his injury; in many cases he will be able to help himself materially. The horse, blindfolded if necessary, is held by an attendant.



FIGURE 93.—Patient carried across shoulders.

(2) Once mounted, the patient should be made as safe and comfortable as possible. A comrade may be mounted behind him to guide the horse. A lean-back may be provided, made of a blanket roll, a pillow, or a bag filled with leaves or grass. If the patient is very weak, the lean-back may be made of a sapling bent into an arch over the cantle of the saddle, with its ends securely fastened thereto.

## APPENDIX

## REFERENCES AND BIBLIOGRAPHY

- 1. **ARMY REGULATIONS.**—Instructions relating to military sanitation are found in AR 40-205 to 40-245, inclusive, 40-270, 40-275, 40-2010, 40-2080, and 40-2150.
- 2. **TECHNICAL MANUALS.**—TM 8-255 (now published as Army Medical Bulletin No. 23) covers the subject of military sanitation in a comprehensive manner. It is adapted in scope to Medical Department officers or others who may have need of detailed knowledge of sanitation.
- 3. **FIELD MANUALS.**—FM 8-40 presents the subject of military sanitation in a comprehensive though condensed form. It is designed primarily for the use of Medical Department officers but is a valuable reference for any officers who desire more detailed information than is found in this manual.
- 4. **BIBLIOGRAPHY.**—The use of figures 53, 54, and 71 is by permission and courtesy of Lt. Col. James P. Crawford, M. C.



## INDEX

	Paragraph	Page
Abdomen, pain in.....	133	176
Advance quartering party.....	98	131
Amounts of field water required.....	16	22
Animal bites.....	130	173
Animal wastes.....	28	37
Ants.....	74	107
Control of.....	75	107
Apoplexy.....	138	178
Application of first-aid treatment.....	115	145
Artificial respiration.....	120	162
Bathing facilities, improvised.....	110	141
Bedbugs.....	71	105
Control of.....	72	106
Habits and characteristics.....	73	106
Bibliography.....	App.	185
Body, care.....	108	137
Burns.....	125	169
Camp sites:		
Desirable features.....	101	133
Procedure on arrival at.....	99	131
Sanitation.....	100, 101	132, 133
Selection.....	100	132
Undesirable features.....	102	134
Care of eating and cooking utensils.....	41	71
Care of the body.....	108	137
Causes of disease.....	106	136
Characteristics:		
Bedbugs.....	72	106
Lice.....	56	93
Mosquitoes.....	52	80
Ticks.....	69	104
Chemical disinfestor.....	66	102
Clothing, disinfestation.....	59	97
Communicable diseases.....	7	5
Control.....	9	9
Spread.....	8	6
Conditioning of troops.....	95	126
Conduct of the march.....	97	127
Construction and care of latrines.....	24	28
Control:		
Ants and roaches.....	75	107
Bedbugs.....	73	106
Diseases:		
Communicable.....	9	9
Epidemics.....	13	20
Intestinal.....	15	21
Respiratory.....	11, 12	13, 14
Venereal.....	79, 80	110, 111



## INDEX

	Paragraph	Page
Control—Continued.		
Fleas .....	77	108
Flies .....	34, 35	53, 55
In messes .....	43	74
Gas gangrene .....	84	116
Lockjaw .....	82	115
Mosquitoes .....	53	84
Poison ivy, oak, and sumac .....	93	124
Rabies .....	86	117
Ringworm .....	91	121
Scabies .....	88	119
Ticks .....	70	104
Convulsions .....	136	177
Cooking utensils, care .....	41	71
Delousing .....	57, 58	94, 94
Delousing plant, operation .....	67	102
Desirable features of camp sites .....	101	133
Disease:		
Causes .....	106	136
Rules for avoiding during field service .....	109	140
Diseases:		
Communicable .....	7	5
Control .....	9	9
Spread .....	8	6
Insect-borne .....	45	76
Prevalence .....	47	77
Transmission .....	48	78
Vectors .....	46	76
Intestinal .....	14	21
Control .....	15	21
Respiratory .....	10	13
Control .....	11, 12	13, 14
Epidemics .....	13	20
Venereal .....	78	110
Control .....	79, 80	110, 111
Disinfestation, clothing and equipment .....	59	97
Disinfestors:		
Chemical .....	66	102
Hot air .....	62	99
Hot iron .....	63	101
Hot water .....	64	101
Mobile .....	60	97
Serbian barrel .....	61	98
Storage .....	65	102
Dislocations .....	119	161
Disposal:		
Garbage .....	44	74
Kitchen waste .....	29	38
Drowning .....	121	162
Eating utensils, care .....	41	71
Electrical shock .....	122	165
Epidemics .....	13	20
Equipment, disinfestation .....	59	97

## INDEX

	Paragraph	Page
Fainting .....	135	176
Field water supplies:		
Amount required .....	16	22
Protection .....	19	23
Purification .....	20	25
Responsibility for .....	18	23
Sources .....	17	22
First aid .....	112, 113	144, 144
First-aid treatment, application .....	115	145
Fits .....	136	177
Fleas .....	76	107
Control .....	77	108
Fly control .....	34, 35	53, 55
In messes .....	43	74
Food—		
Handlers .....	37	64
Inspection .....	38	65
Preparation .....	40	70
Storage .....	39	66
Foreign bodies, removal .....	132	174
Fractures .....	118	155
Freezing .....	127	172
Garbage, disposal .....	44	74
Gas gangrene .....	83	116
Control .....	84	116
Gases:		
Peacetime .....	123	165
Warfare .....	124	165
Grease traps .....	31	41
Habits:		
Bedbugs .....	72	106
Mosquitoes .....	52	80
Ticks .....	69	104
Head injuries .....	137	177
Health, general, measures to improve .....	107	137
Heat exhaustion .....	126	171
Hemorrhage .....	116	147
Hot-air disinfestors .....	62	99
Hot-iron disinfestors .....	63	101
Hot-water disinfestors .....	64	101
Human waste disposal .....	22	28
Hygiene, march .....	94	126
Importance of early medical treatment .....	105	136
Improvised bathing facilities .....	110	141
Incinerators .....	32	26
Insect bites and stings .....	129	173
Insect-borne diseases .....	45	76
Prevalence .....	47	77
Tabulation of vectors .....	46	76
Transmission of .....	48	78
Inspection of food .....	38	65
Inspection prior to march .....	96	126

INDEX

	Paragraph	Page
Intestinal diseases.....	14	21
Control.....	15	21
Kitchen wastes, disposal.....	29	38
Latrines.....	23	23
Construction and care.....	24	27
Lice.....	54	93
Characteristics.....	56	93
Delousing.....	57, 58	94, 94
Disinfection of clothing and equipment.....	59	97
Disinfestors.....	60-66	97-107
Life cycle.....	55	93
Life cycle:		
Lice.....	55	93
Mosquitoes.....	51	80
Litters, transportation with.....	139	175
Lockjaw.....	81	113
Control.....	82	113
March hygiene.....	94	120
Advance quartering party.....	98	131
Arrival at camp site.....	99	131
Conditioning of troops.....	95	126
Conduct of march.....	97	127
Inspection prior to march.....	96	122
Measures to improve general health.....	107	137
Medical treatment, importance of early.....	105	136
Mess—		
Sanitation.....	36	64
Tables.....	42	75
Messes, fly control in.....	43	77
Methods of removing wounded without litter.....	140	180
Methods of water purification.....	20	25
Mobile disinfestors.....	60	97
Monthly physical inspection.....	111	142
Mosquitoes.....	49	77
Control.....	53	81
Habits and characteristics.....	52	80
Life cycle.....	51	80
Recognition.....	50	80
Night urinal cans.....	26	37
Operation of delousing plant.....	67	107
Orders, sanitary.....	6	9
Pain in abdomen.....	133	170
Peacetime gases.....	123	165
Personal hygiene.....	104	136
Physical inspection, monthly.....	111	142
Poison ivy, oak, and sumac.....	92	123
Control.....	93	124
Poisons.....	131	170
Preparation, of food.....	40	70

INDEX

	Paragraph	Page
Prevalence of insect-borne diseases.....	47	77
Procedure on arrival at camp site.....	99	131
Protection of water supply.....	19	23
Rabies.....	85	116
Control.....	86	117
Recognition of mosquitoes.....	50	80
References.....	App.	185
Removal of foreign bodies.....	132	174
Removing wounded without litter.....	140	180
Respiration, artificial.....	120	162
Respiratory diseases.....	10	13
Control.....	11, 12	13, 14
Responsibility for field water supplies.....	18	23
Responsibility for sanitation.....	5	2
Ringworm.....	89	119
Control.....	91	121
Types of infection.....	90	120
Roaches.....	74	107
Control.....	75	107
Rubbish.....	33	52
Rules for avoiding disease during field service.....	109	140
Sanitation, responsibility for.....	5	2
Sanitation of camp sites.....	100, 101	132, 133
Sanitary—		
Installations in camps, data relating to.....	103	134
Orders.....	6	4
Scabies.....	87	117
Control.....	88	119
Selection of camp sites.....	100	132
Serbian barrel disinfestor.....	61	98
Shock.....	117	154
Electrical.....	122	165
Snake bite.....	128	172
Soakage, pits.....	25, 30	35, 39
Soakage trenches.....	30	39
Sprains.....	119	161
Spread of communicable diseases.....	8	6
Storage:		
Clothing for disinfestation.....	65	102
Food.....	39	66
Sunstroke.....	126	171
Tables, mess.....	42	73
Tabulation of vectors.....	46	76
Tetanus.....	81	115
Control.....	82	115
Ticks.....	68	103
Control.....	70	104
Habits and characteristics.....	69	104
Transmission of insect-borne diseases.....	48	78
Transportation with litters.....	139	178
Trenches, soakage.....	30	39
Types of ringworm infection.....	90	120

## INDEX

	Paragraph	Page
Unconsciousness .....	134	176
Undesirable features of camp sites .....	102	134
Urinal cans, night .....	26	37
Urine troughs .....	25	35
Utensils, eating and cooking, care .....	41	71
Vectors, tabulation .....	46	76
Venereal diseases .....	78	110
Control .....	79, 80	110, 111
Warfare gases .....	124	165
Waste disposal .....	21	27
Human .....	22	28
Water—		
Purification .....	20	25
Sources .....	17	22
Supplies:		
Protection .....	19	23
Responsibility for .....	18	23
Wounded, method of removing without litter .....	140	180

