

MHI
Copy 3

FM 21-10

WAR DEPARTMENT FIELD MANUAL

MILITARY SANITATION

WAR DEPARTMENT • JULY 1945

WAR DEPARTMENT FIELD MANUAL
FM 21-10

This manual supersedes FM 21-10, Military Sanitation and First Aid, 31 July 1940, including C 1, 14 Feb 42; C 2, 13 Jul 42; C 3, 16 Jan 43; C 4, 5 Feb 43; C 5, 24 Apr 43; C 6, 15 Nov 43; and C 7, 17 Feb 44; and FM 8-40, Field Sanitation, 15 August 1940, including C 1, 12 Jun 42; C 2, 9 Jul 42; C 3, 22 Dec 42; C 4, 16 Mar 43; C 5, 30 Apr 43; and C 6, 15 Jan 44.

MILITARY
SANITATION



WAR DEPARTMENT • JULY 1945

WAR DEPARTMENT

Washington 25, D. C., 5 July 1945

FM 21-10, Military Sanitation, is published for the information and guidance of all concerned.

[AG 300.7 (1 Jul 45)]

BY ORDER OF THE SECRETARY OF WAR:

G. C. MARSHALL
Chief of Staff

OFFICIAL:

EDWARD F. WITSELL
Brigadier General
Acting The Adjutant General

DISTRIBUTION:

OSW (1); OUSW (1); C of S (1); AC of S (1); AAF (4); AGF (4); ASF (2); AAF Comds (4); Arm & Sv Bd (1); Def Comd (Hq) (1), (Surg) (4); Tech Sv (Hq) (2), Tng Div (4) except 8 (Tng Div) (25); SvC (Hq) (2), (Surg) (2), (Dir of Tng) (6); Class I, II, III & IV Instls (1); Div Eng (2); GH (6); RH (6); SH (3); Conv H (6); Gen Disp (CZ & ZI) (3); Gen & Sp Sv Sch (12); USMA (6); ASTU 8 (2); OCS (6) except 8 (50); EM Techn Sch 8 (12); ASF Tng C (10) except 8 (200); AAF Redist Cen (Hq) (2), (Surg) (2); Labs 8 (4); A (Hq) (6), (Surg) (12); CHQ (Hq) (2), (Surg) (4); D (Hq) (2), (Surg) (4); B (Hq) (1), (Surg) (2); R (Hq) (2), (Surg) (2); Bn (Hq) (1) except 8 (Hq) (4), (Surg) (2) except 7 (Surg) (6); C (2) except 8 (6); AF (Hq) (3), (Surg) (1); W (Hq) (2), (Surg) (3); G (Hq) (2), (Surg) (3); S (Hq) (1), (Surg) (1). T/O & E: 8-117 (6); 8-497 (3); 8-500 (25); 8-510 (4); 8-534 (2); 8-537 (6); 8-572S (1); 8-580 (4); 8-581 (4); 8-591T (6); 8-595T (6).

Refer to FM 21-6 for explanation of distribution formula.

CONTENTS

		<i>Paragraphs</i>	<i>Page</i>
CHAPTER 1.	GENERAL		
<i>Section</i> I.	Introduction	1-3	1
II.	Responsibility for Sanitation	4-9	2
CHAPTER 2.	CONTROL OF COMMUNICABLE DISEASES		
<i>Section</i> I.	General	10-11	7
II.	Control Measures	12	9
III.	Respiratory Diseases	13-14	12
IV.	Intestinal Diseases	15-24	16
V.	Venereal Diseases	25-30	22
CHAPTER 3.	FIELD WATER SUPPLIES		
<i>Section</i> I.	General	31-38	28
II.	Water Reconnaissance	39-43	32
III.	Water Purification in the Field..	44-55	34
CHAPTER 4.	WASTE DISPOSAL		
<i>Section</i> I.	General	56-57	45
II.	Human Wastes	58-66	46
III.	Garbage	67-72	58
IV.	Liquid Wastes	73-75	69
V.	Manure	76-78	76
VI.	Rubbish	79	80
CHAPTER 5.	MESS SANITATION		
<i>Section</i> I.	General	80-83	81
II.	Inspection of Food	84-90	84
III.	Handling and Storage of Food ...	91-98	87
IV.	Preparation and Serving of Food	99-103	93
V.	Cleaning of Cooking, Serving, and Eating Utensils	104-107	98
CHAPTER 6.	FLY CONTROL		
<i>Section</i> I.	General	108	105
II.	Development and Characteristics of Flies	109-110	105
III.	Control Measures	111-115	107
CHAPTER 7.	MOSQUITO CONTROL		
<i>Section</i> I.	Characteristics of Mosquitoes.....	116-118	114
CHAPTER 8.	CONTROL OF LICE		
<i>Section</i> I.	General	127-130	129
II.	Delousing	131-139	131

	<i>Paragraphs</i>	<i>Page</i>
CHAPTER 9. CONTROL OF MISCELLANEOUS INSECTS		
<i>Section</i> I. Ticks	140-143	149
II. Bedbugs	144-146	152
III. Roaches and Ants	147-148	154
IV. Fleas ..	149-150	155
V. Chiggers (or mites)	151-155	156
VI. Stableflies or Dogflies	156-157	158
VII. Eye Gnats ..	158-160	159
VIII. Biting Midges and Blackflies ..	161-163	160
CHAPTER 10. RAT CONTROL		
<i>Section</i> I. Characteristics of Rats	164-166	164
II. Control Measures	167-171	165
CHAPTER 11. MISCELLANEOUS DISEASES		
<i>Section</i> I. Tetanus	172-173	169
II. Rabies	174-175	169
III. Scabies ..	176-177	170
IV. Dermatophytosis	178-179	171
V. Plant Dermatitis	180-181	174
CHAPTER 12. ACCLIMATIZATION, MARCH HYGIENE AND CAMP SITES		
<i>Section</i> I. Acclimatization	182-190	177
II. March Hygiene	191-196	183
III. Selection and Sanitation of Camp Sites	197-201	188
CHAPTER 13. PERSONAL HYGIENE		
VII <i>Section</i> I. General	202-203	192
II. Measures to Protect and Improve Health	204-210	193
CHAPTER 14. DDT AND ITS USE AGAINST INSECTS	211-216	203
APPENDIX I. SOLUBILITY OF DDT IN COMMON ORGANIC SOLVENTS		220
APPENDIX II. TABLE: DDT IN INSECT CONTROL		224
INDEX		231

This manual supersedes FM 21-10, Military Sanitation and First Aid, 31 July 1940, including C 1, 14 Feb 42; C 2, 13 Jul 42; C 3, 16 Jan 43; C 4, 5 Feb 43; C 5, 24 Apr 43; C 6, 15 Nov 43; and C 7, 17 Feb 44; and FM 8-40, Field Sanitation, 15 August 1940, including C 1, 12 Jun 42; C 2, 9 Jul 42; C 3, 22 Dec 42; C 4, 16 Mar 43; C 5, 30 Apr 43; and C 6, 15 Jan 44.

CHAPTER 1

GENERAL

SECTION I. INTRODUCTION

1. GENERAL. a. Military sanitation is the Army way of keeping soldiers healthy, and preventing the spread of disease. Its primary aim is to keep as many men as possible in fighting trim, physically and mentally.

b. In other wars, disease knocked out more soldiers than battle casualties. Now, fewer man-days are lost because increased use of vaccinations and strict sanitary rules prevent disease from spreading. However, the danger of disease is always around the corner, and only constant attention to preventive medicine and sanitation can give protection against it.

c. The basic principles of sanitation are the same in military as in civilian life. However, in the Army, soldiers are subjected to greater physical strain and more changes in surroundings, in climate, and in living habits than in civilian life. Coming from every section of America, men from farms, mountains, cities, deserts, and seashores are crowded together in camps. Changes in surroundings are frequent. Naturally, military life brings them into contact with strange diseases to which their systems have built up no resistance. This tends to break up the "group immunity,"

which is the resistance of each member against germs constantly present in the group.

d. Officers and enlisted men alike must be able to understand certain basic sanitary rules. They must learn how to carry out health regulations and orders, as well as to cope with unforeseen situations.

e. It is the duty of company officers, assisted by Medical Department personnel, to instruct enlisted men in the basic principles of hygiene and sanitation.

2. PURPOSE. This manual teaches fundamentals of sanitation, disease prevention and control including control of communicable diseases, troop housing, waste disposal, water purification, mess sanitation, insect control, and personal hygiene. This instruction applies to all officers and enlisted men of all grades in the arms and services throughout the Army.

3. REFERENCES. Information contained in this manual is based on the following Army Regulations:

- a. AR 30-2135, 30-2210, 30-2220, 30-2260.
- b. AR 40-200, 40-205, 40-210, 40-270, 40-2010.
- c. AR 100-70, 100-80, 100-90.

SECTION II. RESPONSIBILITY FOR SANITATION

4. COMMANDING OFFICERS. The commanding officer is responsible for enforcing sanitary regulations within his organization and the boundaries of his unit's area. He will take every practicable step to correct sanitary defects.

5. MEDICAL DEPARTMENT. The Medical Department is charged with the responsibility of investigating sanitary conditions in the Army, and of making recommendations about camp locations, water supply and purification, methods of waste disposal, prevention of disease, and all means of effecting immunity among military personnel. Other responsibilities of the Medical Department include recommendations for—

Personal hygiene and sanitation training.

Sanitary facilities.

Control of rodents, vermin, and disease-bearing insects.

a. *The senior medical officer or surgeon* of a command is responsible, under the commanding officer, for general supervision of Medical Department personnel. Medical officers, as technical advisers to their commanders, point out insanitary conditions and make recommendations to correct them, but the direct responsibility for sanitation rests with the commanding officer. Medical officers have advisory supervision over hygiene and sanitation. Inspections and reports should always be made carefully, and watchfulness over sanitation must be constant. The commanding officer should receive an immediate report of any insanitary condition with recommendations for improvements. The medical officer states *what* should be done, but only on a question that calls for technical medical advice does he specify *how* it should be done. A commanding officer may authorize a medical officer to give orders in his name for correction of sanitary defects.

b. *Medical inspectors* act as assistants to the senior medical officer or surgeon in supervising sanitation and preventing communicable diseases. The veterinarian has duties similar to those of the medical inspector with respect to animal sanitation, and meat and dairy hygiene.

c. (1) *Sanitation details* are organized from Medical Department personnel by the senior medical officer or surgeon of each post, camp, or station large enough to warrant it. A convenient number of men are assigned to each detail, under the direction of medical inspectors. Their duties are to—

(a) Assist medical inspectors.

(b) Inspect sanitary appliances and measures in use, and report violations to the medical inspector.

(c) Inspect and report on methods used to dispose of human and animal waste, and garbage; bathing and disinfestation facilities; safety of water supply and puri-

fication apparatus; and the general efficiency of all other means used to maintain health.

(d) Instruct troops on technical matters of sanitation.

(2) *Sanitation details* perform duties separate and distinct from police details. Except for Table of Organization sanitary companies, enlisted men of the Medical Department will not form labor details outside their own medical units, except as above.

d. *Sanitary technicians* in the field, whenever necessary and available, may be assigned on temporary duty from the Medical Department one to a company or similar unit to assist unit commanders in sanitary matters and supervise the establishment and maintenance of field sanitary methods and appliances. Unit commanders will furnish the necessary labor details to accomplish this work.

e. *Theaters of operation* are divided and subdivided into convenient sanitary areas in the interest of system and supervision. One officer of the Medical or Sanitary Corps, under the medical inspector, will have charge of each designated area. A sanitation detail (see c above) is assigned to each such officer and he in turn assigns enlisted men to each subarea.

(1) The officer in charge of a sanitary area will instruct enlisted men in the sanitary principles they are to enforce, distribute them among subareas, and supervise their work. He will also keep informed of all matters of sanitary importance within his area (water supply, disease, etc.), and inform new organizations. He must make sure that outgoing organizations leave their area in sanitary shape. Further, he will make required reports to medical inspector and perform any other specially authorized duties.

(2) Enlisted men assigned to each subarea will keep subarea maps with detailed locations of all sanitary facilities, make regular inspections of sanitary appliances, report sanitary conditions to officer in charge, supply all necessary sanitation data to incom-

ing troops, and perform any other specially authorized duties.

6. CORPS OF ENGINEERS. *a. Building and grounds* are the responsibility of the Corps of Engineers. This includes construction, maintenance, repair, lighting and heating of buildings, structures, grounds, and utility systems at all Army posts, camps, and stations.

b. Water for all posts, camps, and stations is procured and treated by engineers, and they are responsible for construction, maintenance, and operation of the entire water supply system. The one exception is the smaller installation where it is impractical for engineers to undertake supply.

c. Waste disposal includes collection and disposal of all refuse and garbage. When this material is salable, it is disposed of by the post supply officer, but otherwise the responsibility rests with engineers. Construction, maintenance, repair, and operation of sewage collection, pumping, treatment, and disposal systems are included in this duty.

d. Insect and rodent control, as applied to real property, is recommended by the Medical Department but the actual work is carried out by the Corps of Engineers. Engineers oil, dust, spray, fill and drain water collections; screen, ratproof, and fumigate buildings; but they are not responsible for ordinary house-keeping. Any of the duties listed above which are not handled by engineers become the responsibility of the unit commander.

7. QUARTERMASTER CORPS. Procurement and distribution of supplies for unit sanitation and personal hygiene is a quartermaster function. Quartermasters are also responsible for sanitary operation of laundries, delousing plants, mobile shower units, and bakeries. In contracts with civilians, the Quartermaster Corps makes sure that sanitary regulations are met in removal of garbage and waste.

8. SANITARY ORDERS. a. The exact sanitary measures to be observed and executed by any command are directed by orders. These are prepared by the senior medical officer or surgeon, but issued and enforced by the commanding officer. "Sanitary Orders" conform to the general provisions of Army Regulations but are mainly valuable in adapting measures to the specific surroundings.

b. These orders may be published in various forms. For divisions or smaller units they are usually published in a general order or an appendix to an administrative order. However, in well-trained units, changes, or new instructions may appear as brief memoranda. In organizations larger than a division, headquarters will control sanitation by the publication of brief general policies. Whatever the form of sanitary orders, they apply with equal weight to all concerned. Instructions should be practical and clearly stated but not so restrictive that they interfere with the initiative of subordinate commanders.

9. SANITARY REPORTS. The surgeon of each station or command will make a complete sanitary report within 3 days after the end of the month. By this means, the commanding officer and higher authorities are kept in touch with health and sanitation conditions, and with any defects which may lower the health of the command. The surgeon uses the prescribed form to comment on irregularities and to recommend remedial action.

CHAPTER 2

CONTROL OF COMMUNICABLE DISEASES

SECTION I. GENERAL

10. DEFINITION. a. Communicable diseases are those which can be transmitted from man to man or from animal to man. The term includes "contagious" diseases, which spread by direct contact or close association. From the standpoint of control, communicable diseases are classed in five groups.

(1) *Respiratory*. Usually transmitted by discharges from the nose, mouth, throat, or lungs. Examples: common colds, pneumonia, scarlet fever, and tuberculosis.

(2) *Intestinal*. Usually transmitted by food or water contaminated with feces or urine. Examples: typhoid fever and dysentery.

(3) *Insect-borne*. Transmitted by blood-sucking insects. Examples: malaria and typhus fever.

(4) *Venereal*. Usually transmitted during sexual intercourse. Examples: syphilis and gonorrhoea.

(5) *Miscellaneous*. Those communicable diseases which do not readily fall into the above groups. Examples: tetanus, rabies, scabies, dermatophytosis, and anthrax. (See ch. 11.)

b. Communicable diseases are caused by the growth within the body of certain germs or organisms, including a wide variety of bacteria (microbes), certain yeasts and molds, parasitic worms, and viruses. Taken as a group, these diseases make up a large share of the sick report in both war and peace. Therefore, to raise the entire level of Army efficiency, modern measures must be applied constantly to prevent their spread.

11. SPREAD OF COMMUNICABLE DISEASES.

There are three links in the chain of spread of communicable diseases: the source, the means of transmission, and the susceptible persons (see fig. 1).



Figure 1.

a. Sources. (1) *Cases.* A person who is actually ill with a disease is called a *case*. A person who presents evidence of a disease is termed a *suspect* until a definite diagnosis can be made. A *contact* is one who has been in recent and close association with a source of a communicable disease. The *incubation period* is the length of time between exposure to disease and the appearance of its first symptoms. Some diseases can be transmitted by a person during the latter part of the incubation period, and before he himself develops any symptoms.

(2) *Carriers.* A person whose body gives off organisms capable of causing disease when he himself is not ill is known as a "carrier." In some diseases a carrier may be as dangerous as a case in spreading infection. Some of the diseases spread by carriers are typhoid fever, diphtheria, and various kinds of dysentery.

(3) *Animals.* In some diseases, the source is an infected animal. An example is plague, which fleas carry from infected rats to man.

b. Means of transmission. (1) *Contact.* Transmission of a communicable disease by contact is a result of physical contact or close association between a case (or carrier) of the disease and a susceptible person.

Venereal diseases are transmitted only by contact and usually by direct contact in sexual intercourse. Respiratory diseases are usually spread by close association, the organisms leaving the body of a case or carrier in small droplets of moisture carried in the exhaled breath, or in secretions from the mouth and nose.

(2) *Water and food.* Diseases transmitted by water and food are mainly those in which the organisms causing the disease are eliminated by the case or carrier in the feces or urine. If food or water are contaminated by such excreta, these harmful germs may easily infect susceptible persons. Epidemics of these diseases are commonly caused by faulty waste disposal and the preparation of food by infected food handlers (cases or carriers). Among the intestinal diseases which are usually transmitted by food or water are typhoid fever and dysentery.

(3) *Blood-sucking insects.* Mosquitoes, lice, and ticks are among the blood-sucking insects which spread disease germs from person to person and from animal to man. When the insect bites a person having the disease, it takes blood containing the organisms into its body, and the organisms may be transmitted to another person bitten by the same insect. Malaria and typhus fever are spread in this manner.

c. Susceptibility and immunity. A *susceptible or nonimmune person* is one who will develop a disease if infected. An immune person is one whose body has developed the power to overcome the causal organism and who is therefore not susceptible to the disease. Immunity to a disease may be the result of a previous attack of that disease or in the case of certain diseases, immunity may be produced by vaccines. The duration of immunity depends on the disease and can vary from a few weeks to many years.

SECTION II. CONTROL MEASURES

12. GENERAL. Control measures may be directed

against sources, transmitting agents, or susceptible persons (see fig. 1). Specific measures for control are outlined in later sections; however, the general measures are as follows:

a. *Control of sources (cases, carriers, or animals)* should be carried out to prevent the transfer of causal organisms.

(1) *Isolation.* Cases and suspects should be separated from other troops and every precaution taken to prevent transmitting the disease. Carriers may not require isolation but should have their activities restricted to the extent the medical officer believes necessary.

(2) *Physical inspection.* When cases of communicable disease are occurring in a unit, it is important to detect and isolate each new case as soon as possible. For most communicable diseases, daily inspection of all contacts (and in some instances of the whole unit) during the incubation period should be performed by a medical officer.

(3) *Quarantine.* This is the restriction of activities of those who have come in contact with cases of communicable diseases. It is used in certain special situations but relatively little importance can be placed upon it as a control measure as applied to large bodies of troops. The only diseases for which Army Regulations require quarantine of contacts are pneumonic plague, cholera, and, under certain conditions, small-pox.

b. *Control of transmitting agents* includes the following general measures which should be enforced at all times:

- (1) Prevention of overcrowding.
- (2) Correct ventilation of barracks and tents.
- (3) Purification of water.
- (4) Careful selection and preparation of food.
- (5) Good sanitation of messes.
- (6) Effective disposal of waste.
- (7) Control of disease-bearing insects.
- (8) Personal cleanliness.

c. *Protection of susceptibles* calls for every possible measure to improve general health. Among the most important are instruction in the fundamentals of personal hygiene and close supervision of the way rules for health are observed. Immunization (vaccination) against certain disease can be carried out by the injection of vaccines or other substances. Army Regulations prescribe that every member of the military forces receive routine immunization against smallpox, typhoid fever and the paratyphoid fevers, and tetanus.

(1) *Smallpox*. Troops are vaccinated against smallpox on entry into the service and every 3 years thereafter.

(2) *Typhoid fever and paratyphoid fevers*. Three injections of triple typhoid vaccine are given to each man on entering the service; a single injection is given once a year after the initial series.

(3) *Tetanus*. (a) Three injections of tetanus toxoid are given when the soldier enters the Army and a single stimulating dose is given 1 year later. These injections are recorded on the soldier's identification tags. An additional stimulating dose is usually given following a wound or burn.

(b) During epidemics and when troops are in areas where these diseases are prevalent, it may become necessary to revaccinate them more often.

(c) Special immunizations are given to troops going overseas if their travel includes areas where louse-borne typhus fever, cholera, plague, or yellow fever are prevalent. In some instance troops are immunized against influenza, Rocky Mountain spotted fever, or diphtheria. Except for influenza, these are rarely done on a large scale.

(d) The Surgeon General prescribes general immunization policy, and immunizations are given by Medical Department personnel. It is the responsibility of unit commanders to make sure that all troops in their command receive the required immunizations, and that proper record is made on both copies of each

individual's immunization register and elsewhere as prescribed by Army Regulations.

d. *Special control measures* are measures specially adapted to the control of particular diseases. For example, malaria control demands attack on mosquitoes by destruction of breeding places, killing of adult mosquitoes, use of repellents, bed nets, and, at times, the use of antimalarial drugs by the troops. Dysentery control calls for strict supervision of mess sanitation, disposal of human waste, fly control, personal hygiene, detection and treatment of carriers.

SECTION III. RESPIRATORY DISEASES

13. **CAUSES.** a. Respiratory diseases are the greatest causes of sickness in the Army. They exact the greatest toll during winter and spring and are most common among newly inducted troops. These diseases are spread by secretions from the mouth and nose and usually are transmitted through close association with infected persons. The disease-producing organisms leave the body of a case or carrier in small droplets of moisture carried in the exhaled breath, and may be inhaled by other persons. Sneezing, coughing, and talking increase the number of organisms transmitted in this manner. Harmful organisms from the mouth or nose may contaminate food, eating utensils, cups, hands, or towels from which they may easily be carried to the mouth of others.

b. The principal diseases spread by respiratory secretions are:

Chicken pox	Mumps
Common respiratory diseases (common cold, acute laryngitis, acute bronchitis, etc.)	Pneumonia
	Pulmonary tuberculosis
	Scarlet fever
	Smallpox
Diphtheria	Streptococcus sore throat
German measles	Vincent's infection
Influenza	(trench mouth)
Meningococcus meningitis	Whooping cough

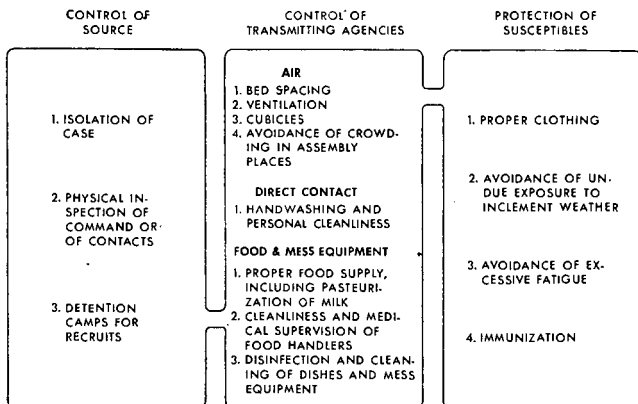

Figure 2. Factors in control of respiratory diseases.

14. CONTROL. Some of the respiratory diseases are extremely hard to control because they are easily transmitted, most people are susceptible to them, immunity is only temporary, and there are no effective vaccines against most of these diseases. Surveys to find carriers of the bacteria causing diphtheria and meningitis are of little practical value. Group quarantine as a control measure is of questionable value in most situations. Routine control measures should include—

a. Isolation of case. Cases should be removed from contact with healthy persons and given hospital treatment unless the medical officer recommends otherwise.

b. Physical inspections. For cases of any of these diseases (except common respiratory diseases, pneumonia, meningitis, tuberculosis, and whooping cough), the medical officer should inspect contacts or the entire command to find and isolate new cases without delay. Incoming recruits and troops from stations where there is an outbreak of a communicable disease should be inspected before assignment of quarters. If

a large number of recently inducted troops is reporting in, special detention areas may be established.

c. Prevention of overcrowding. The danger of respiratory disease can be reduced by cutting down frequent or prolonged close contacts between individuals. One routine measure is to provide ample barrack space for each man since association here during hours of sleep is so prolonged. Normally, 60 square feet of floor space should be allowed for each man, though in an emergency 50 will suffice; seasoned troops can be housed for limited periods with 40 square feet per man. Uncrowded quartering in tents is preferable to overcrowding in barracks.

(1) *Bed spacing* should be arranged to get the greatest distance between beds. When the side bars of beds are less than 5 feet apart, beds should be head to foot (with the head of each bed opposite the foot of each adjacent bed). If space permits, beds may be staggered out of their usual alignment. When double-decked bunks are used, the same amount of floor space per man as stated in c above should be allowed.

(2) *Bed cubicles* are made by converting each bed space into its own compartment with screens. They are used when a number of men have colds, or when overcrowding cannot be avoided. The common method is to attach a shelter half pole to the head of the bed. A shelter half is then rigged to extend about 4 feet above the head of the bed, the lower edge being folded under the mattress as shown in figure 3. Blankets, sheets, or even boards may be used equally well.

(3) *Places of assembly*, like mess halls, theaters, and post exchanges serve to promote the spread of respiratory diseases. At times when these diseases are common, officers should take every sensible step to prevent overcrowding. Alternate seats in theaters may be kept vacant, or post exchanges may admit no more than a specified number of men at any one time. Rarely is it advisable to close places of entertainment because

of the effect on morale and the fact that then the men tend to congregate in other places.

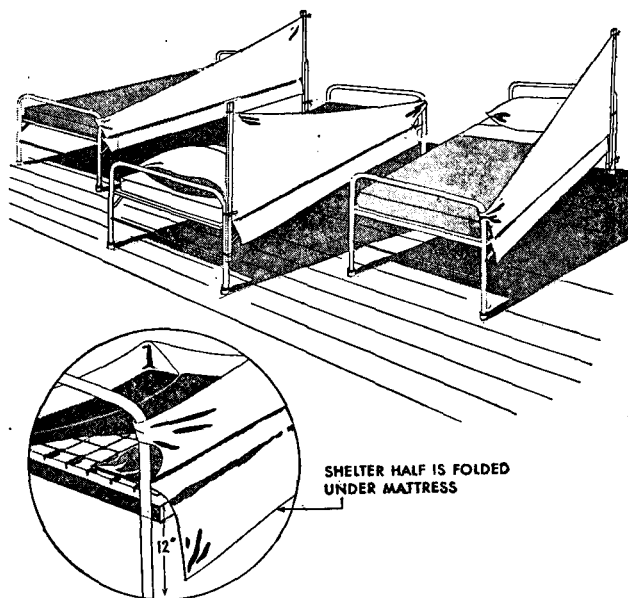

Figure 3. Constructing cubicles in squad rooms.

(4) *Ventilation and heating.* The circulation of fresh air through barracks, classrooms, and other gathering places is important. Men in poorly ventilated quarters rebreathe the exhaled air of their companions which may contain disease-producing organisms. Fresh air from the outside is always desirable as long as strong drafts are avoided. A temperature of 70° F. is desirable indoors during the day. During sleeping hours, 55° to 60° F. is recommended.

(5) *Mess sanitation* calls for constant watchfulness. Dishes, utensils, and mess equipment must be cleaned and disinfected. Food handlers must be inspected often

and men with symptoms of respiratory disease relieved from duty at once. Raw (unpasteurized) milk is often the means of spreading disease and its use is forbidden by Army Regulations. Men should be prohibited from patronizing eating and drinking places considered unsanitary by military authority.

(6) *Dust control* is best accomplished indoors by scrubbing floors frequently with hot, soapy water. Because droplets of moisture from the nose and throat cling to dust particles, dry sweeping should be avoided. Oiling of floors when feasible is an effective method of dust control. Treatment of blankets and other bedding with dust preventives is also of value.

(7) *Instruction in personal hygiene* should be given to each individual in every unit. Men should thoroughly understand the danger to themselves of respiratory disease and they should be taught how to prevent the spread of germs to others. Individuals should be trained always to cover the nose and mouth with a handkerchief when coughing or sneezing. Spitting on the floor should be strictly banned. Respiratory diseases may be transferred directly when men use common drinking cups, canteens, towels, and other personal items such as pipes or cigarettes. Personal cleanliness, including frequent hand washing, should be stressed.

(8) *General resistance* can be maintained by wearing clothing suited to weather conditions. Excessive fatigue and chilling should be avoided when possible.

SECTION 4. INTESTINAL DISEASES

15. CAUSES. a. The principal intestinal diseases are common diarrhea, bacterial food poisoning, bacillary dysentery, amebic dysentery, paratyphoid fever, typhoid fever, helminth infections (worms), and cholera. They are sometimes called "filth" diseases since they are caused by food or water contaminated by human excretions. Food may be contaminated by infected food handlers who are careless or dirty in their per-

sonal habits or by the housefly which carries germs directly from the latrine to the mess hall or kitchen. Again, organisms may be carried directly to the mouth by soiled fingers. The usual means of transmission of these diseases are often expressed as "feces, fingers, flies, and food."

b. Natural sources of water such as rivers, lakes, and springs are often polluted by drainage from latrines and sewers. In the field, careless disposal of human waste is a frequent source of danger. Such deposits may drain into a nearby water source or they may furnish breeding places for flies. Thus, prevention of intestinal diseases becomes simply a matter of cleanliness, strict sanitary discipline, and close attention to food and water sources.

16. PREVALENCE. a. Carelessness in the mess or a single breach of sanitary discipline can easily cause an outbreak of serious illness. Sources of infection are constantly present in Army organizations, though not to the same extent as among native populations. Whenever sanitary discipline is relaxed, epidemics of diarrhea or other intestinal diseases are almost sure to follow. Unlike respiratory infections, such as the common cold, epidemics of intestinal diseases rarely occur in the Army as long as sanitary rules are carefully enforced. In temperate climates, intestinal diseases offer their greatest threat in summer. In the Tropics, however, the problem is always present and requires constant vigilance, especially if native sanitation is at a low level.

b. The group of diarrheal diseases which comes under the heading of "common diarrhea" is very important from the Army standpoint because of its influence on the noneffective rate. Other names for this condition are "GI's" and "gypsy tummy." It is the direct result of faulty sanitation and not, as is often thought, due to changes in climate, GI soap, or unusual food. It occurs in explosive epidemics which can incapacitate large groups at one time.

17. MEANS OF CONTROL. a. The most effective means of cutting down intestinal diseases is the control of the agencies which transmit them—human waste, flies, food, and water. Triple-typhoid vaccination gives excellent protection against typhoid fever and the paratyphoid fevers, and cholera vaccination gives limited protection against cholera. However, since there is not practical means of building up immunity against the other intestinal diseases, close attention must be paid to the following measures:

(1) Mess sanitation, including careful selection and supervision of food handlers.

(2) Waste disposal.

(3) Fly control.

(4) Personal cleanliness, paying particular attention to the washing of hands immediately after visiting the latrine.

(5) Careful selection, inspection, and protection of food supplies.

(6) Purification and protection of water supply.

(7) Avoidance of unauthorized water and food sources.

(8) Rigid sanitary discipline.

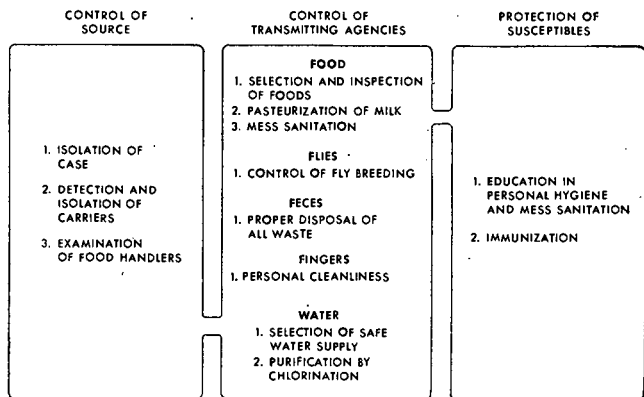

Figure 4. Factors in control of intestinal diseases.

b. When cases of intestinal disease occur, they should be reported to the medical officer at once to avoid the danger of an epidemic. Surveys of food handlers to detect carriers should be carried out when indicated and may be of considerable value (see fig. 4).

18. RESPONSIBILITY FOR CONTROL. Commanders of all grades, platoon leaders, and noncommissioned officers are responsible for taking all necessary precautions against intestinal disease and enforcing each specified sanitary regulation. From the training stage onward, troops must know field sanitation both in principle and in practice as it is only in this way that epidemics of intestinal disease can be avoided. Past experience has shown that organizations which cannot control intestinal diseases in training are hopelessly handicapped in the theater of operations. Epidemics of these diseases are usually a sign of poor sanitary discipline within the command.

19. DISEASES FROM BITING INSECTS. In addition to the germs which the insect may carry on his body, and which may spread disease, the bite of insects can carry disease from man to man or from animals to man. Found in most parts of the world, these insect-borne diseases can cripple the Army by causing illness and death, and this is especially true of malaria and typhus fever. In order to spread, insect-borne diseases need a source of infection, a transmitting insect, and a susceptible victim. Figure 5 shows how thoroughly the Anopheline mosquito works to spread malaria.

20. CONTROL. This is similar to the control of other types of insects. However, in addition to controlling the disease-carrying insects, control must also be directed toward the source of the infection. (See ch. XIV.)

21. CLASSIFICATION. The insect-borne diseases of

military importance are spread by a variety of insects.

<i>Disease</i>	<i>Transmitting insect</i>
Malaria	Mosquito
Yellow fever	Mosquito
Dengue	Mosquito
Filariasis	Mosquito
Typhus fever:	
Endemic typhus	Fleas
Epidemic typhus	Lice
Scrub typhus	Mite (chigger)
Trench fever	Lice
Relapsing fever	Lice and ticks
Rocky Mountain spotted fever	Ticks
Tularemia (rabbit fever)	Ticks and the deer fly
Bubonic plague	Fleas
Sandfly fever	Biting flies (<i>Phlebotomus</i>)

22. PREVALENCE. Tropical and subtropical climates are almost invariably favorable for mosquito breeding. Unless these mosquitoes are under control, they can strike enough men to change the course of an entire campaign. In temperate and colder climates, typhus and trench fever can be quickly spread by body lice, which thrive on insanitary conditions.

23. MALARIA. a. The only way to prevent the spread of malaria is to protect men from the bites of infected mosquitoes. This depends completely on effective mosquito control. (See ch. 7.) One measure of control is the so-called suppressive treatment which consists of taking regularly small doses of a drug such as atabrine or quinine. These drugs do not *prevent* malaria but offer protection in malarial regions where complete mosquito control is impossible. Atabrine and quinine only serve to delay the infection and prevent the symptoms which would otherwise make men ill. Men who are bitten by infected mosquitoes develop malaria after they stop taking the drug—usually in 2

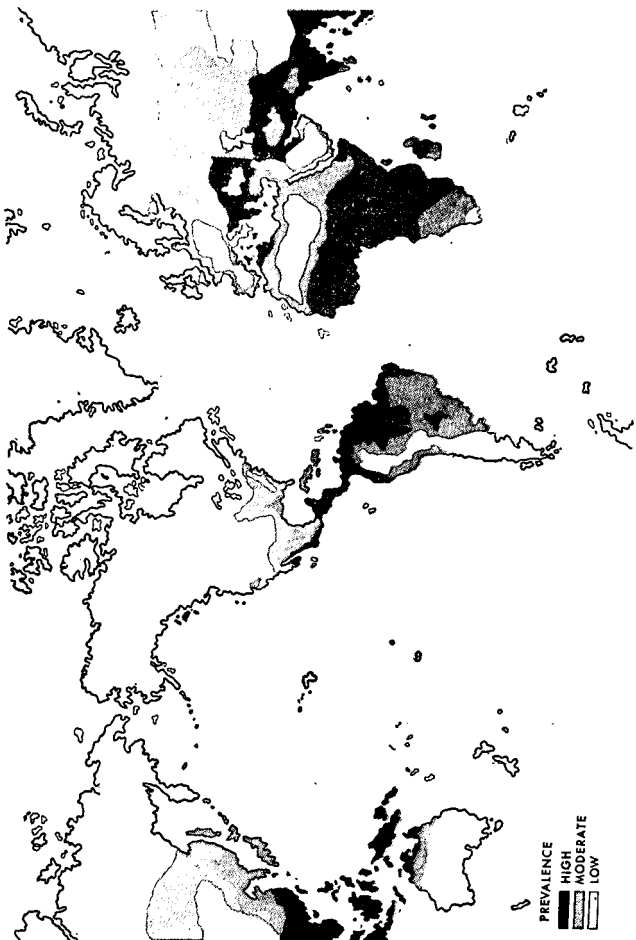

Figure 5. Distribution of malaria.

to 4 weeks after stoppage.

b. For suppressive treatment to be effective, the drug must be taken regularly and in the exact doses prescribed by the medical officer. This is the responsibility of the unit commander and can be done best by making a roster check with each dose. When men are away on patrol in a malarious area, they should carry enough tablets to last them until their return to base. Furthermore, the men should be disciplined to take the tablets regularly while away from base.

24. OTHER INSECT-BORNE DISEASES. **a. Yellow fever.** This disease can be prevented by protective vaccination, (see par. 13) but mosquito control as outlined in chapter 7 must be carried on.

b. Other diseases. Protective vaccination is available against typhus and plague but since it does not offer complete protection, other standard control measures should be rigidly followed. Beyond insect control, there are no effective measures which give protection against dengue, filariasis, trench fever, relapsing fever, tularemia, or sandfly fever. (See chs. 6 to 9.)

SECTION 5. VENEREAL DISEASES

25. RESPONSIBILITY. Venereal disease (VD) control is the responsibility of the unit commander, who must initiate and maintain the VD control program. The Medical Department supplies him with information and advice as to suitable control measures. The individual soldier, in turn, is responsible for carrying out measures designed to protect his own health and in turn that of his unit. The venereal disease rate of a unit therefore is a fair index of its discipline, training, and administration.

26. KINDS AND CAUSES. **a.** There are five recognized venereal diseases, each caused by a different germ:

<i>Disease</i>	<i>Germ</i>
Gonorrhoea (clap, dose, gleet)	Gonococcus germ
Syphilis (pox, bad-blood, lues)	Spiral-shaped germ, treponema pallidum
Chancroid (soft chancre, buboes)	Bacillus of Ducrey
Lymphogranuloma venereum (tropical bubo)	Filterable virus
Granuloma inguinale (tropical sore)	Donovan body

b. With rare exceptions, all of these diseases are acquired through sexual intercourse. The number of cases of venereal disease in any unit depends on two factors:

(1) The number of sex contacts with infected women.

(2) The number of these exposures that are unprotected by adequate prophylaxis.

27. CONTROL MEASURES. The VD rate can be cut down effectively by carrying out the following measures:

a. Reduce sex exposures. The only completely satisfactory way to prevent venereal disease is to avoid promiscuous sexual intercourse altogether. Avoidance of sex relations is not harmful to the soldier's health or well-being. The fact cannot be overlooked, however, that in any unit there will be some men who will have promiscuous sex relations. The degree of promiscuity that is carried on will depend to a large extent on the backgrounds of the men in the unit, and on the particular Army environment in which they find themselves. It is, of course, impossible to do anything to change the backgrounds of the men, but it is possible to do something about the environment. The following measures will help to reduce the number of sex exposures:

(1) Provision of substitute activities on the post, such as athletics and wholesome recreation of other

kinds. These will catch the attention and interest of the men, and help to occupy off-duty time.

(2) Limitation of the activities of professional prostitutes and pick-ups. Commanding officers can do much in this respect by working with the civilian authorities.

(3) Declaring houses of prostitution and establishments which serve as places of pick-up or exposure "off limits."

b. Increasing the use of prophylaxis. When properly used, venereal prophylaxis offers a good protection against infection. The following equipment and facilities will be made available to all men in the Army with full explanation of how they are to be used:

(1) *Mechanical prophylaxis.* The condom or rubber offers considerable protection against infection if used properly. It helps to prevent the transfer of the germs from one sex partner to another, but it must be applied before contact and worn throughout the exposure. Condoms are provided free through medical supply channels and must be made easily available to the unit at all times. They can also be purchased at Army exchanges.

(2) *Chemical prophylaxis.* This helps to destroy germs after they have been transferred from one person to another. It is most effective when used *within 1 hour* after exposure, and becomes progressively less effective after that. Drugs for destroying gonorrhea germs must be injected into the urinary canal while drugs to kill the germs of other venereal diseases are applied externally. Chemical prophylaxis may be supplied in two forms: the individual PRO-KIT, and by the official prophylactic stations. PRO-KITS are provided free through medical supply channels and should be made available to each unit at all times. They should also be stocked by Army exchanges. Prophylactic stations are maintained on every military installation and in adjacent communities where there are enough troops to warrant them. They should be conveniently placed and their locations posted in the

unit area. They must be kept clean and operated by well-trained attendants.

c. Reduction in sources of infection. Ordinarily the sources of infection are not under military control. Therefore, the problem of reducing their number is primarily a function for civilian health and law enforcement authorities. This does not mean, however, that the Army can do nothing about them. The cooperation of the Army in working with the civilian authorities is of great importance. It may be carried out in the following ways:

(1) Information about the probable source of infection should be obtained from each soldier who has a venereal disease, and should be recorded on WD AGO Form 8-148. This form should then be sent immediately to the health officer in the area where the suspected source lives. Special attention should be given to sources of infection from syphilis. The purpose of obtaining this information should be explained carefully to the soldier in order to secure his cooperation. He should be assured that the information will be treated confidentially and that no mention of his name will be made to his contact.

(2) Encouragement of civilian health departments to provide adequate facilities for finding, treating, and, if necessary, quarantining infected girls.

(3) Protection of civilians against infection by military personnel. This places an additional responsibility upon the Army to find, treat, and restrict, if necessary, personnel with venereal diseases.

28. ADMINISTRATION OF CONTROL PROGRAM.

The commanding officer of a unit is responsible for the promotion and execution of a venereal disease control program, but experience has shown that the responsibility should generally be delegated to and centralized in one officer who is competent to study the problem and adapt a program to meet local needs. Therefore, all posts, camps, and stations are required to have a medical officer designated as VD control offi-

cer. He may serve in this capacity either full or part time. In divisions, the medical inspector performs the duties of the VD control officer. His duties include the following:

a. Analysis of VD rates in the command in order to give special attention to those units with high rates.

b. Keeping an up-to-date spot map from data obtained at prophylactic stations and from WD AGO Form 8-148 showing places of pick-up and exposure. Furnishing this information to the civilian authorities concerned.

c. Making sure that there are enough prophylactic stations and that individual prophylactic materials are distributed properly.

d. Whether or not he has immediate supervision over all diagnosis and treatment of VD, these aspects of control, particularly those related to administrative problems, should rightly concern him.

e. Detect early infected personnel by supervising routine physical inspections, as required by section VII, AR 40-210, and special inspections when circumstances warrant. In neither case should advance notice of the inspection be given.

f. Collaboration with civilian and governmental agencies which are interested in the VD control problem.

g. Education of noncommissioned officers. Because of the importance of getting the cooperation of the enlisted men themselves, every effort should be made to interest the noncommissioned officers in the VD control program. Special attention should be given to educating the noncommissioned officers in every detail of the program so that they will be able to pass on the information to the enlisted men under them.

h. Promotion of an adequate educational program.

29. EDUCATIONAL PROGRAM. a. Since the success of the Army VD control program is dependent largely on each soldier's knowledge of these diseases and their prevention, the education of the soldier in this sub-

ject must be an important part of his training. The instruction is designed to accomplish two purposes: avoidance of exposure, and proper use of prophylactic measures. It should include the following points:

(1) Names and characteristics of the different venereal diseases.

(2) Manner of transmission; dangers of promiscuous sex relations.

(3) Chief symptoms, especially those at the start of the disease.

(4) Methods of prevention.

(5) Fundamentals of treatment; and the dangers of neglect, self-treatment, or improper treatment; dangers of neglect or improper treatment which may result in such complications as heart disease, insanity, arthritis, or sterility.

b. Training aids like films, film strips, charts, and pamphlets help a great deal. Posters, short bulletins, etc., can serve as "reminders."

c. Whether the men respond depends to a great degree upon whether the knowledge about VD and its prevention has been so firmly impressed on their minds that they will use it when the need arises. It depends also upon an appeal to every man's character, pride, patriotism, and competitive spirit.

30. DISCIPLINARY MEASURES. The standard of discipline in a unit is very important in a VD control program. It reflects the ability and attitude of the commanding officer. A good commander probably will not have to make much use of punishment, but will depend more upon instruction and morale. However, in certain cases, it may be necessary to use punishment in the VD control program. If a soldier fails to report for treatment promptly, for example, when he knows or suspects that he has a venereal disease the commanding officer can, at his discretion, have the man court martialed. However, no disciplinary action is authorized for failure to take a prophylaxis or for having contracted a venereal disease.

CHAPTER 3

FIELD WATER SUPPLIES

SECTION I. GENERAL

31. NECESSITY FOR PURE WATER. Impure water may serve as a means for the transmission of various diseases, including dysentery, diarrhea, cholera, schistosomiasis, and typhoid fever. Water from streams, shallow wells, ponds, swamps, and lakes is especially likely to carry such disease organisms. All water supplies should therefore be treated with sufficient chlorine to kill all disease organisms, and troops should be trained not to drink unchlorinated water. Each soldier is provided with water purification tablets for canteen treatment and each unit with ampules of Grade A hypochlorite for use with Lyster bags. The proper use of these and other water purification methods and equipment is described in this chapter.

32. AMOUNTS REQUIRED. a. Climate, types of work, and general camp conditions regulate the amount of water men need. In permanent stations, the average requirement per man is 70 gallons a day, though in semipermanent camps, it varies from 20 to 40 gallons. The quantity used in the field is generally much less, but this depends on availability and restrictions. Men in the field cannot be kept in good health with less than 1 gallon a man, each day, for drinking and cooking.

b. When water is distributed to temporary camps by truck, 5 gallons for each man will take care of daily cooking, drinking, and washing. Animals need 10 gallons a day. Troops on the march or on bivouac

need 2 gallons a day. Under average conditions of combat, men can get along for as long as 3 days with $1\frac{1}{2}$ to 2 quarts a day. Animals in combat zones require 3 to 5 gallons. (See par. 38.)

33. SOURCES OF WATER. At semipermanent camps, water is supplied by surface sources as streams and lakes, or from underground sources as deep wells. In the field, water is supplied by streams, lakes, springs, or shallow-dug wells. The desirability of a water supply depends upon—

- a. Quantity available.
- b. Accessibility of source.
- c. Type (surface or underground).
- d. Probable degree of contamination.

34. QUALITY OF WATER. All field sources of water must be considered unsafe for drinking until properly treated. Some sources are safer than others. Rivers and lakes are usually preferred to streams and ponds because there is a greater dilution of the contaminating material.

35. PROTECTION OF WATER SUPPLY. a. Every

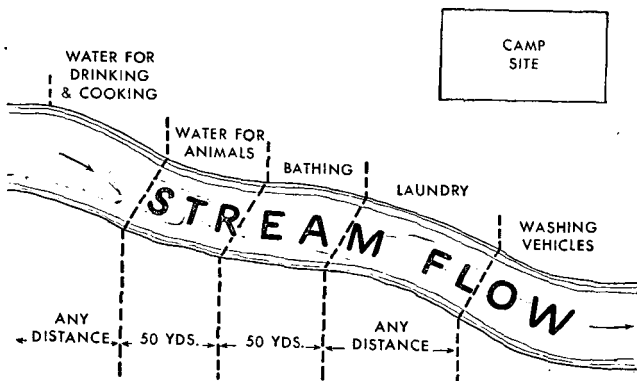

Figure 6. Protection of water supply by proper use of stream.

water source must be carefully guarded against pollution by human or animal waste. Pollution can take place by invisible subsurface drainage as well as by surface contamination. Latrines and soakage pits should be located so that drainage is away from the water source. If a stream is used for supply, it should be marked off in zones, posted by markers, and should be protected by water guards (see fig. 6).

b. Containers used to deliver water must be thoroughly clean. "Other-purpose" containers are prohibited except where absolutely necessary, then must be thoroughly cleaned, steamed if possible, air dried, and disinfected before use.

36. RESPONSIBILITY FOR SUPPLY. a. The Corps of Engineers is responsible for procuring and treating water. This includes construction, maintenance, and operation of all facilities to collect, purify, and distribute the water supply. In very small units, however, engineers are not called on to handle this detail.

b. Unit commanders are responsible for procuring and treating water if the work cannot be done by the engineers. In either event, it is the unit commander's duty to protect approved water sources, to control their use in his organization, and to guard against any possible pollution in his command.

c. The Medical Department is responsible for making surveys, inspections, and examinations of water supply, together with any recommendations necessary to protect health. In any phase of water handling regarding protection of health, the Medical Department acts in full cooperation with the Corps of Engineers.

37. SANITARY CONTROL. The Medical Department's control over water sanitation includes the following:

a. Surveys of existing or proposed water supplies for actual or potential sources of contamination, also sufficiency of supply if it affects the health of troops.

b. Study of plans for proposed installations used in treating water. Particular attention must be paid to sanitary features before the final plan is adopted.

c. Inspection of existing water supply, including sources, installations, appliances, distributing system, and water treatment methods.

d. Bacteriological and chemical analyses of water as delivered to troops.

e. Technical supervision over procuring and purifying supply in emergencies that call for devices like the water-sterilizing (Lyster) bag.

38. WATER DISCIPLINE. a. The unit commander should never permit water drinking unless the supply has been approved by a medical officer or the water has been properly treated as outlined in this manual. In the field, it should become routine procedure to fill canteens each night as a preparedness measure. During the day, canteens should be refilled whenever the chance is presented.

b. A fully equipped soldier expends 90 calories or heat units for every mile of march, and requires 180 cc of water to dissipate as heat. For $2\frac{1}{2}$ miles or 1 hour, his system needs 450 cc of water, or a fraction under 1 pint. In 2 hours, a soldier can lose a quart of water through evaporation. There are too many variations of heat and energy to standardize water intake, but one simple rule should be useful: when water is plentiful men should drink when thirsty—and drink enough to satisfy their thirst.

c. Even though men stay away from water during hard physical work, no great saving will result. Men may be deprived of water as an economy measure, but unless the deficit is made up within 12 hours, their efficiency is bound to be reduced. If water rations are short, the best means of saving is to reduce the amount of hard work done during the heat of the day.

SECTION II. WATER RECONNAISSANCE

39. IMPORTANCE. Sources of water supplies for troops on the move are usually located by reconnaissance. The success of campaigns over mountains, deserts, and occupied areas often depends on the single factor of water supply. When water sources are not known beforehand, reconnaissance should locate them well in advance of the arrival of troops.

40. RESPONSIBILITY. Since the Corps of Engineers procures and purifies water for major units in combat, it is also responsible for water reconnaissance. The Medical Department gives all necessary help and advice. When units are too small or isolated for engineers to assist, attached personnel of the Medical Department take over the reconnaissance duty.

41. LOCATING WATER SOURCES. Information on water sources is found in geologic or topographic maps, aerial photographs, Government reports, reports of local inhabitants, or ground reconnaissance. Once a source has been found, it should be analyzed from the standpoint of the amount available, the time and labor needed to develop it, and the extent of purification that will be needed. In cities, reconnaissance may consist merely of a study of waterworks systems.

42. RECONNAISSANCE CHECK LIST. The following table shows most points covered in a careful water reconnaissance. Naturally, not all points will apply to a single situation, and in some cases, additional data will be desirable.

1. TYPE OF SUPPLY—Well, spring, stream, lake, or pond.
2. LOCATION—Sources of supply, facilities, and equipment should be shown on map or accurately described.
3. SOURCE OF CONTAMINATION—Char-

- acter of contamination, location in relation to supply, control measures needed.
4. **QUANTITY AVAILABLE**—Minimum, maximum, and average flow of streams, wells, and springs. Dimensions and depth of lake or pond, with rate of outflow.
 5. **QUALITY**—Turbidity, color, odor, taste. Result of bacteriological examination, or of chlorine demand tests.
 6. **ACCESSIBILITY**—Nearness of supply to troops by rail or road. Conditions of access roads.
 7. **WELLS**—Diameter, depth of well and water, distance below ground; type, condition, and depth of lining; geological formation and nature of impervious strata; method of raising water.
 8. **SPRINGS**—Type; protection by coping, watertight basin, ditching.
 9. **STREAMS**—Minimum, maximum, and average figures for rate of flow, width, and depth; nature of stream bed; height of banks above water. Access of water trucks or carts.
 10. **EXISTING SOURCES**—Purifying facilities such as chlorination and filters. Type, size, speed, and capacity of pumps and engines; electrical equipment, storage facilities, pipe lines; description of general condition of all facilities.
 11. **PLANS FOR POSSIBLE DEVELOPMENT**—Description; time required; materials available and required.

43. MAPS AND CONVENTIONAL SIGNS. The information gathered from water reconnaissance should be recorded on a map with conventional signs, some of the more common of which are shown below. (See FM 21-30 for additional signs.)

PIPE LINE OR AQUEDUCT (DIAMETER MAY BE SHOWN)		Blue
TEES (WITH SIZE)		
WYES		
ELBOWS		
VALVES		
CHECK VALVES		
LABORATORY		Lab (Name)
WELL		
SPRING		
WATER POINT		
WATER POINT, ANIMALS ONLY (NUMBER OF ANIMALS)		
RAILWAY WATER POINT		
ENGINEER WATER SUPPLY BATTALION		
WATER TANK TRAIN		
WATER CART OR TRUCK (GIVE CAPACITY)		
MOBILE PURIFICATION UNIT		
PORTABLE PURIFICATION UNIT		
PUMP		P.
WATER WORKS		W. W.

SECTION III.

WATER PURIFICATION IN THE FIELD

44. FIELD MECHANICAL PURIFICATION EQUIPMENT. Engineer organizations are equipped with filters and other purification devices; and with canvas storage tanks, pumps, railroad tank cars, tank trucks,

and semitrailer water tanks. All are designed to supply treated water to large field units. More complete descriptions of the equipment will be found in TM 5-295.

a. Sand filters. (1) *Mobile purification unit.* All equipment is mounted on a 2½-ton, 6-wheel drive truck chassis. It includes a self-priming centrifugal pump with gasoline engine, a 42-inch pressure sand filter, a dry-feed chlorinator, alum and soda feed pots, a venturi meter, and a simple test kit for determining pH and residual chlorine. Safe operating rate is 75 gallons per minute.

(2) *Portable purification unit.* This smaller unit is divided into sections. One consists of a gasoline-driven centrifugal pump, a hypochlorinator, and chemical feed pots. The other is an 18-inch pressure sand filter. If a larger quantity of water can be produced safely the usual rates for sand filters can be exceeded, even though physical appearance of the water is sacrificed. The safe operating rate is 12½ gallons per minute.

b. Diatomite filters. The water purification equipment diatomite consists of a pressure filter built differently from the aforementioned sand filters, diatomite slurry feeding apparatus, gasoline-engine-driven pumping sets, fabric water tanks, test kits for determining residual chlorine and pH, and auxiliary equipment. There are two sizes of this equipment. The 15 gallons per minute unit is known as the *pack filter* because it can be moved to the water point by pack animal or by individual man packs. Where used, it will supplant the portable sand filter equipment described above. It is furnished with a hand pump for emergency use. The 50 gallons per minute unit is known as a *portable filter* and is a replacement for the present truck mounted mobile sand filter equipment described above. The filter elements of either unit, in operation, are coated with a slurry of diatomaceous silica which is more efficient than sand in removing very fine particles of suspended matter from water. The filter will remove the cysts which cause Amebiasis, and

blood flukes which cause Schistosomiasis. It is most important, however, to treat the water by means of chemical coagulation and sedimentation before filtration. This type of filter is particularly useful in tropical areas where the above-mentioned diseases are found.

c. Distillation equipment. Distillation is used when the usual means of getting the water supply fail, or where only brackish water or sea water can be found. Portable equipment of this kind is being made available as part of engineer supply and for engineer operation. The distilling process destroys all germs but recontamination is a source of possible danger, because a chlorine residual is not present as with other purification units. Distilled water should be handled with special care and when transferred to other containers should be chlorinated before distribution.

45. EMERGENCY PURIFICATION. When separated from the usual source of purified water, troops must treat and test their own drinking water with disinfecting and testing agents which have been issued to them. It should be emphasized that these measures are only for emergencies and unit commanders should not allow them to be used when approved water supplies are available. In regions where there is danger from water-borne diseases, only water which has been completely treated should be used. (See pars. 52, 53, and 54.)

a. Collection. Water should be as clear as possible before treatment. Heavier solid matter can usually be removed by settling or straining: A good settling basin can be made by digging a 4-foot pit a few feet from the edge of a stream. If the soil is not porous enough for the basin to fill by itself, dig a shallow connecting trench. One method of straining is to use a thoroughly clean barrel or drum. Remove the ends of the barrel and sink it into the bed of a shallow stream, letting one end extend above the water surface. Once the turbid water has been removed from the inside, the barrel will fill up with clean water.

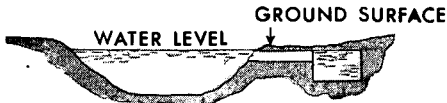
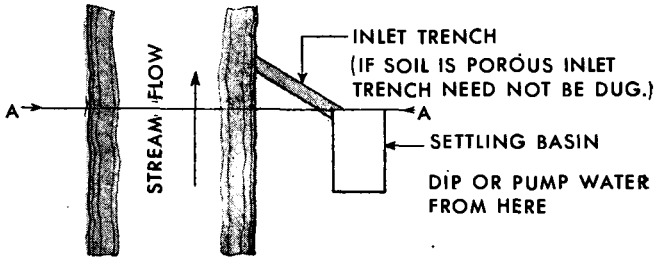

SECTION A-A

THIS ARRANGEMENT RECOMMENDED FOR PORTABLE PURIFICATION UNITS AND STREAMS WITH DEEP WATER.

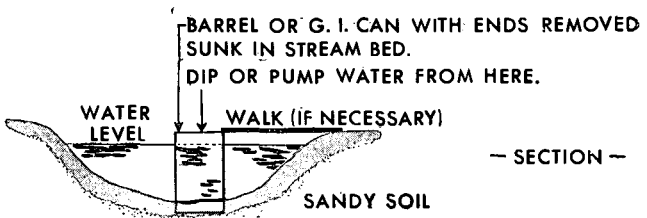

SECTION --

(WATER FILTERS THROUGH SOIL BEFORE ENTERING BARREL)

THIS ARRANGEMENT RECOMMENDED FOR SMALL SHALLOW STREAMS WHERE QUANTITIES OF WATER TO BE PUMPED ARE NOT EXCESSIVELY LARGE

Figure 7. Types of settling basins.

b. Boiling. Boiling is a sure way of purifying water but the water will have a flat taste and the method may be impracticable without proper containers. To be sterilized, water should actually boil for 1 minute. Overnight storage or pouring water from one receptacle to another will take away the flat taste. Boiled water, unless very carefully protected, can be recontaminated.

46. CHLORINATION. Chlorine added to the water is the most practicable of all field means of purification. It is valuable not only following filtration in mobile and portable units, but also for untreated water in containers like Lyster bags and canteens. The necessary amount of chlorine varies with water characteristics, and in proportion to the organic or solid matter in the water. Water containing considerable organic material requires more chlorine. Permanent camps and mobile purification units use chlorine gas, but calcium hypochlorite powder or water purification tablets (Halazone) are usually used in the field. Chlorination must always be directly supervised by trained officers or noncommissioned officers.

47. LYSTER OR WATER STERILIZING BAG. This is a 36-gallon bag made of heavy canvas or rubberized cloth and issued at the rate of one for each 100 men. Its main use is to distribute water treated by a water purification unit or otherwise made safe. Chlorination is the only purifying treatment that can be used with the Lyster bag. Since it is difficult to disinfect small amounts of water when the organic content is unknown, this method is used only when other means are not available (see fig. 8). Water is treated in a Lyster bag as follows:

a. Suspend the bag on a tripod or other support, making sure that the inside is entirely free of dirt. Strain the water through a clean cloth and fill to the mark 4 inches from the top.

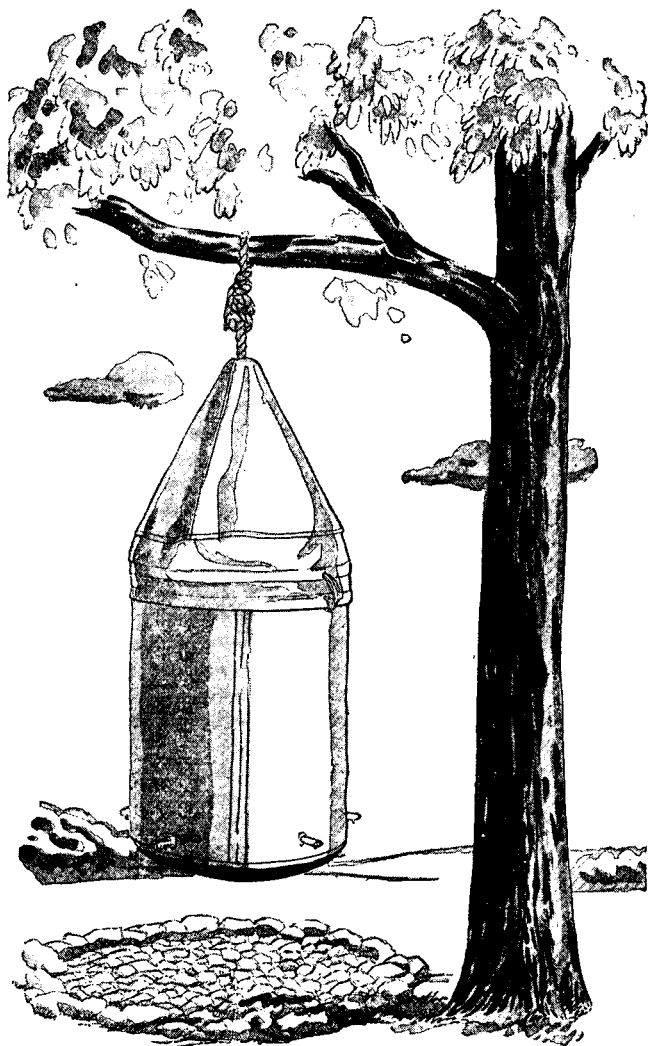

Figure 8. Lyster bag.

b. Break a tube of calcium hypochlorite into the bag and empty the entire contents in the water. Stir thoroughly with a clean paddle long enough to reach the bottom. (This dose of chlorine is about 2.5 parts per million, or 0.5 gm of hypochlorite to 36 gallons of water.)

c. To disinfect faucets, draw half a canteen cup of water from each one, pouring it back into the bag. Then close the top of the bag with a cover.

d. After the calcium hypochlorite has been in the water for 10 minutes, flush one of the faucets by letting a small amount of water run to waste. Test for residual chlorine according to the method outlined in paragraph 50.

e. Keep the cover on the bag to prevent recontamination. Do not use the water until 30 minutes after the hypochlorite has been added.

48. CANTEEN METHOD. Fill the canteen with water. Dissolve one tube of calcium hypochlorite into it, making sure that it is evenly mixed. Add one canteen cup (6 cc) of this solution to each canteen of water and mix thoroughly by shaking. (A small air space in the canteen makes mixing easier.) Wait 30 minutes before drinking the water. This method is less accurate than chlorination in the Lyster bag and therefore it requires close supervision.

49. OTHER CONTAINERS. Water can be sterilized in containers other than Lyster bags and canteens if the proper proportion of calcium hypochlorite is used. The quantity of calcium hypochlorite needed can be figured on the same basis as for the Lyster bag (that is, one tube of hypochlorite for each 36 gallons). If the container holds as much or more water than the Lyster bag, it should be tested for residual chlorine. All containers should be cleaned thoroughly before use.

50. TESTING RESIDUAL CHLORINE. After the

10-minute contact period, water samples should show a chlorine residual; otherwise, there is no assurance that the water has been correctly treated. The following means are used to prove that water is properly chlorinated:

a. Liquid orthotolidine method. Put $\frac{1}{2}$ -inch of water from the Lyster bag into a clean canteen cup. Add 15 drops (or 1 cc) of orthotolidine and mix thoroughly. Keep the solution out of direct sunlight, let it stand for 5 minutes, and then note the color. The guide below shows how to adjust the dosage by the color reaction.

(1) No color—not enough chlorination. Add another tube of calcium hypochlorite to the Lyster bag and mix thoroughly. Retest after 10 minutes.

(2) Canary yellow—not enough chlorination. Add about one-quarter tube of calcium hypochlorite and mix thoroughly. Retest in 10 minutes.

(3) Deep yellow—satisfactory. This indicates that there is a residual of at least one part per million of chlorine.

(4) Orange red—more chlorine than necessary, but the water is entirely safe to drink. It is preferable to drain some from the bag and refill with fresh water to dilute the mixture and improve taste. Mix thoroughly, then retest after 10 minutes.

(5) Bluish green—alkaline or hard water. This may require an addition of as much as 30 drops (or 2 cc) of orthotolidine solution to get the desired color reading.

b. Orthotolidine tablet method. Remove inner vial from the testing kit. Fill the outer vial with sample of water to the bottom of the colored band. Drop one of the orthotolidine tablets from the inner vial into the sample. Shake until dissolved and note the color, using the color list below as a guide:

(1) No color—not enough chlorination. Add one tube of hypochlorite to Lyster bag and mix thoroughly. Retest after 10 minutes.

(2) Lighter yellow than color band—not enough chlorination. Add one-quarter tube of hypochlorite and mix thoroughly. Retest after 10 minutes.

(3) Equal or darker yellow than band—satisfactory. This shows a residual of at least one part per million of chlorine.

(4) Orange color—too much chlorine. Treat the same as with the liquid orthotolidine in a(4) above.

51. WATER PURIFICATION TABLETS. Water in issue canteens can be easily disinfected with issued purification tablets. Two tablets are needed for every quart or canteenful of clear water, though four tablets should be used if the water is muddy or off-color. Shake well to dissolve tablets. In 30 minutes all the bacteria will be destroyed, then the water will be safe to drink.

52. PURIFICATION FOR SPECIAL PURPOSES. In some areas, certain disease organisms cannot be entirely destroyed by the usual means of purification. It then becomes necessary to use extra control measures to make water safe enough for drinking and bathing.

53. AMEBIC DYSENTERY (Amebiasis). This disease is most often found in the tropics though cases have been reported in temperate climates. It occurs most often where lack of sanitation permits transfer of infected human waste by contact, food, or water. In areas where this disease is a problem, surface drinking water should be purified by these means:

a. Sedimentation. Settling tanks are placed between the point where chemicals are added and the filter. The coagulant dosage should produce a heavy, rapidly settling floc and the sedimentation period should last 60 minutes.

b. Filtration. (1) *Diatomite filter.* The use of this unit, as described in paragraph 44, is the best method

for this special purpose. No restriction in the usual filter rate is necessary.

(2) *Sand filter.* The filter rate must not exceed 6 gallons a minute for every square foot of sand area. This means a maximum filter rate of 10 gallons a minute with the portable unit, and 60 gallons with the mobile unit.

c. Disinfection. After filtration, standard field chlorination is followed (that is, getting one part per million of residual chlorine after 10 minutes standing, then waiting an additional 20 minutes before using).

d. Emergency water treatment. When small units must treat their own drinking water, boiling is one sure method. The use of the Lyster bag is also safe when special added steps are taken. First apply the required dose of calcium hypochlorite to get one part per million of residual chlorine after 10 minutes' contact. Then add another tube of calcium hypochlorite immediately after the first test. A further contact period of 30 minutes should be allowed before using the water. To disinfect water in individual canteens, follow the same directions previously given for water purification tablets unless an increase is directed by the medical officer.

54. BLOOD FLUKES. (Schistosomiasis). This disease is caught in tropical waters containing the tiny larvae of worm parasites called blood flukes. The organisms penetrate the skin while men are wading or bathing in contaminated water, or enter the body through impure drinking water. In areas where the disease occurs, use wells and springs rather than surface water, such as ponds and sluggish streams. The following precautions should be taken in areas where there are blood flukes:

a. Water treatment. If possible drinking water should be treated in the same way as described for amebic dysentery. Diatomite filtration is best. Sand

filtration can not be depended upon to remove all of the larvae, even at lower filter rates. It is absolutely necessary, therefore, whether or not the water is filtered, to apply a sufficient amount of chlorine to give a residual chlorine content of one part per million after a 30-minute contact period. (It must be carefully noted here that the chlorine contact time, before making the test, differs from the ordinary procedure for the Lyster bag.) To disinfect water in individual canteens, follow the same directions previously given for water purification tablets, unless an increase is directed by the medical officer.

b. Water handling protection. Troops who handle water supplies should wear rubber gloves and boots whenever they touch untreated water containing blood flukes. Parts of the body which touch untreated water should be rubbed briskly with a coarse towel or cloth.

c. Bathing and swimming. Swimming or wading should never be allowed in natural bodies of water which contain these blood flukes. The same measures that apply to drinking water apply with equal force to water for portable bathing units. If filtered and chlorinated water cannot be furnished for bathing, surface water should be treated with 10 parts per million of copper sulphate. This can be done by filling a cloth sack with copper sulphate crystals and dragging it through a storage tank. After such treatment, the water must not be used for at least 48 hours.

55. WATER FOR BEVERAGES. Any water used in the preparation of a beverage must be as pure as that used for other drinking. If the water requires disinfection with chlorine, the proper contact time must elapse before any other flavoring ingredient is added. It is completely wrong to assume that any beverage preparation can purify water.

CHAPTER 4

WASTE DISPOSAL

SECTION I. GENERAL

56. NEED FOR WASTE DISPOSAL. In order to control intestinal disease, waste must be gotten rid of safely. In general, incineration or burial is the means of disposal; however, wastes of economic value may be sold. The wastes which present a disposal problem are human excreta (feces and urine), garbage, rubbish, liquid waste, and animal wastes (manure).

57. RESPONSIBILITY. a. *Commanding officers* are responsible for disposing of wastes as directed by higher echelons, and for enforcing existing regulations within their own organizations and areas.

b. *Medical Department* is responsible for making any recommendations for collection and disposal that may affect health.

c. *Corps of Engineers* constructs and operates waste disposal systems and plants; is responsible for collection, incineration, conversion to sanitary fill, or other waste disposal methods at permanent or semipermanent camps. At temporary field installations, these duties become the responsibility of unit commanders.

d. *Quartermaster Corps* disposes of salvage waste, including garbage. Contracts for disposal should provide that the contractor collect waste at its source; or that the Corps of Engineers collect and deliver it to the contractor at a specified place. Units on the post using salvage waste (like garbage for hog food) collect and dispose of it. (See AR 700-25 and TM 38-505.)

SECTION II. HUMAN WASTES

58. DISPOSAL. Of all types of waste, human waste is the most frequent carrier of intestinal disease germs and special precautions must be taken in its disposal. In many permanent and semipermanent camps, human waste may be carried off by a waterborne sewerage system. When this empties into a municipal system, disposal is not an Army responsibility. However, it is often necessary for the Army to construct its own sewage disposal plants. On the march, in bivouac, or in temporary camps, disposal becomes a problem of the unit or the individual.

a. *On the march*, men fall out during brief halts, dig a hole (cat hole) about 1 foot deep, and then cover the feces completely with earth. Although more difficult to dig, the same applies to frozen ground covered with snow. During a halt for a meal, a straddle trench can be dug. When picking the site for a halt, the unit commander should keep this need in mind.

b. *On bivouacs*, straddle trenches are used to dispose of feces and urine.

c. *In temporary camps*, deep pit latrines and urinal troughs or soakage pits are built. Until deep pit latrines are finished, straddle trench latrines can be used. Where construction of deep pit latrines is not practicable, straddle trenches (with frequent changes of location) or pail latrines are used instead.

59. LATRINE CONSTRUCTION. **a.** Latrines are used to bury excreta away from flies and to prevent fly breeding, soiling of the earth, and contamination of water supplies. They belong to the individual companies and are taken care of by them. There should be enough latrine seats or spaces to accommodate 8 percent of the command at one time. Two linear feet are allowed for each man.

b. Latrines are located at least *100 yards* away from the company kitchens and at least *100 feet* away from any well or spring. Drainage must be away from any

water supply. Latrines should not be dug below ground-water level. Clay or other tight soil will absorb liquids poorly. Latrines should be dug in porous, well-drained soils and should not extend below ground-water level. A good latrine location is about 30 yards from the end of the company streets, within easy reach. It should be lighted at night unless military security demands concealment. If there is no light, a piece of cord fastened to stakes or trees will serve as a guide.

c. Latrines should be inclosed by canvas or brush screens or a large wall tent. A drainage ditch is dug around the latrine inclosure to carry off surface water. Hand-washing facilities should be placed at all latrine exits. These may be made by running rods through two cans and supporting each rod on two forked stakes. (See fig. 9.) The cans tip. One may be filled with soapy water, and the other with clear water.

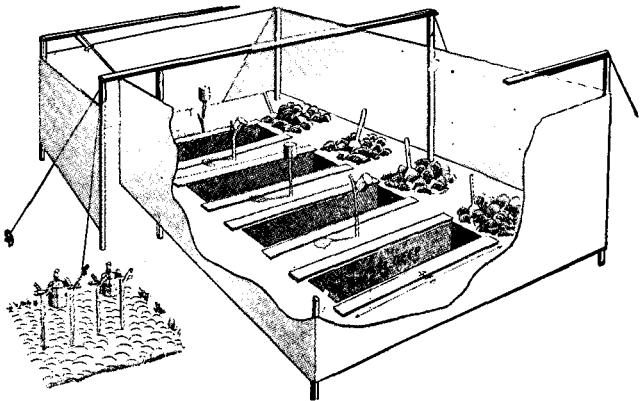

Figure 9. Hand-washing device.

60. STRADDLE TRENCH LATRINES. a. A trench is dug 1 foot wide, $2\frac{1}{2}$ feet deep, and 4 feet long. Two feet of length are allowed per man for at least 8 percent of the command. For 100 men, there will

be four such 4-foot trenches. There are no seats in this type of latrine. Boards may be placed along both sides of the trench to provide sure footing. Unless there is natural concealment, a brush or canvas screen is provided.

b. The earth removed while digging is piled at one or both ends of the trench. A paddle or shovel is placed in each pile so that every man can promptly cover his excreta and paper. This is to keep the flies away and reduce odors. Toilet paper rolls should be placed nearby on pegs or other holders and protected from the rain by a wooden covering or tin can. Again, a means of washing hands must be provided. If necessary, a latrine orderly is assigned to make certain that excreta is covered, that there is enough toilet paper and sufficient water for men to wash their hands.

c. Straddle trench latrines are closed before they are abandoned or when they are filled to within 1 foot of ground level. Earth is domed over the pit and tightly packed. If the soil is loose or sandy, it should

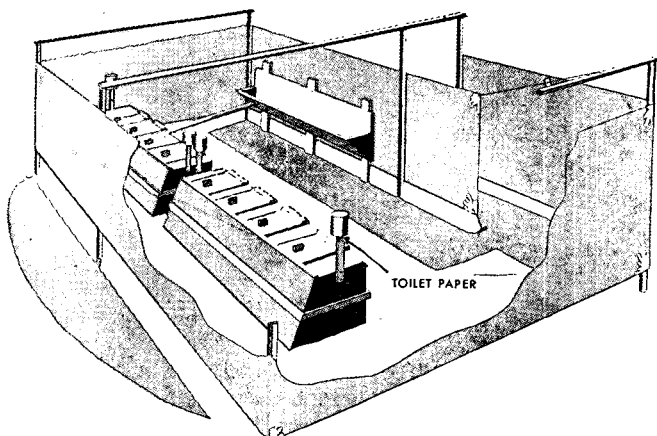

Figure 10. Straddle trench latrines for 100 men.

be mixed with oil. The site is then marked by a sign, "CLOSED LATRINE."

61. DEEP PIT LATRINE. a. This type of latrine is used with the standard latrine box and must conform to it in size. The standard box which takes care of four men, is 8 feet long, and 30 inches wide at the base. (A company of 100 men requires 16 feet of latrine space: 2 standard latrine boxes.) The four holes have flyproof covers. Blocks or bars installed to prevent the covers from opening to a vertical position will also insure self-closing after use. All cracks are made fly-proof by nailing strips of wood or tin over them. The deep pit latrine is built with a urine trough or soakage pit (see par. 66). A metal deflecting strip is placed where it will keep urine from soaking into the wood. Then the whole unit is inclosed by brush or canvas screening, or a large wall tent. (See figs. 11 and 12.)

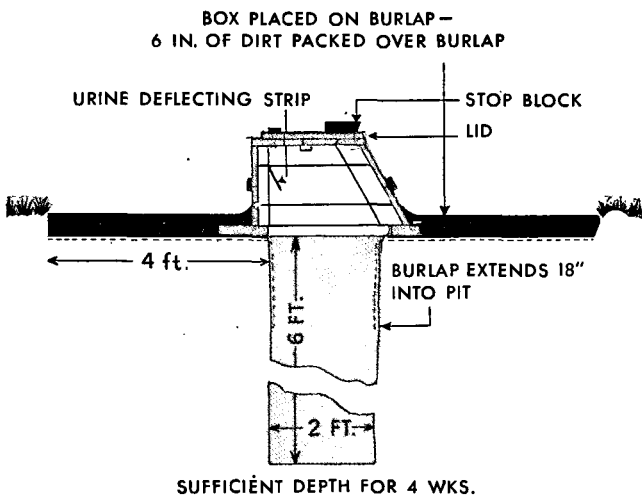
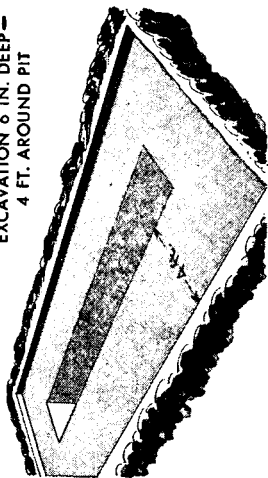
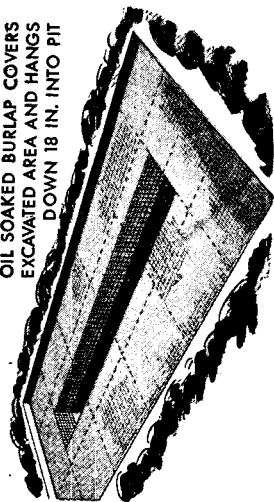

Figure 11. Deep pit latrine arrangement for 100 men.

EXCAVATION 6 IN. DEEP -
4 FT. AROUND PIT



OIL SOAKED BURLAP COVERS
EXCAVATED AREA AND HANGS
DOWN 18 IN. INTO PIT



LATRINE BOX DIRECTLY
ON BURLAP

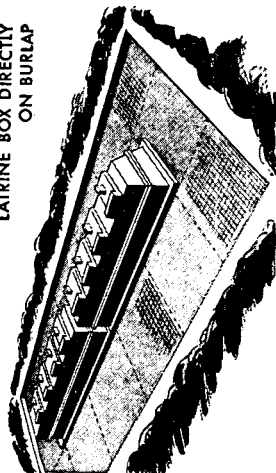

REMOVED EARTH PACKED OVER
OILED BURLAP

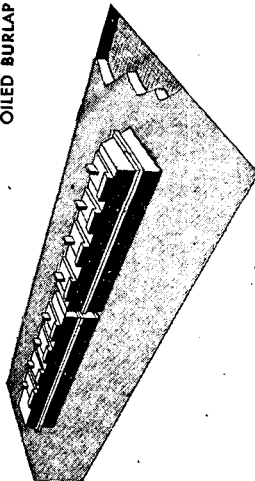

Figure 12. Cross section of standard latrine pit.

b. The pit is dug 2 feet wide and $7\frac{1}{2}$ feet long. This gives the latrine box 3 inches of support on all sides. The depth of the pit varies with the length of time the latrine will be used. As a guide, allow 2 feet for cover and 1 foot additional for each week of use. (A latrine to be used 1 week will be dug 3 feet deep.) These measurements are for average soil. In clay or tight soil where absorption is poor, the depth should be increased in proportion. However, rock or high ground water levels may limit the depth. In sandy soil, a support of planking or sandbags may be necessary to keep the sides of the pit from caving in. Drainage ditches are dug to lead rain water away from pit.

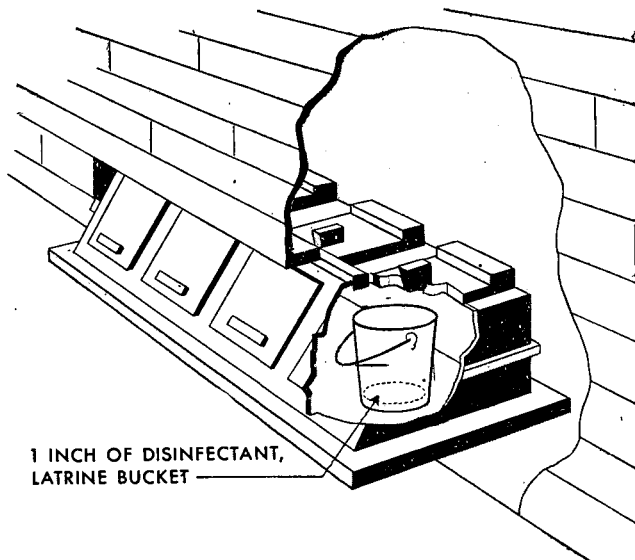

Figure 13. Flyproofing deep pit latrine.

c. Unless the pit is in tight clay soil or has been blasted from rock, it has to be flyproofed (to keep fly larvae from getting out). This is done by digging

around the pit an area 4 feet wide and 6 inches deep. This area is covered with burlap and then soaked with waste motor oil. The burlap hangs over into the pit, extending 18 inches down the walls. The earth is then replaced over the area, tamped down, and more oil added. If burlap is not available, oil is mixed with the earth alone which is tamped down. If there is no oil, use clay or other well compacting soil moistened with water. The latrine box is then carefully fitted over the pit and earth packed tightly around the edges of the box to seal any remaining cracks. (See fig. 13.)

d. The only practical way to lessen odors and to prevent fly breeding is to keep the latrine clean, lids closed, cracks sealed and make sure that the fly-proofing seal is not broken. Lime or oil are of little help. Burning out the latrine is of no value and will spoil the flyproofing. Once flies have gotten in they can be prevented from breeding by using powdered borax or other approved preparations. One pound of powdered borax is used for every 8-hole latrine every 5 days. The powder should be distributed equally over the contents of the pit. If the pit is dry, add enough water to dissolve the borax, but not enough to carry it away. The use of powdered borax likely will be replaced by DDT.

e. Latrines should be policed daily. There should always be enough toilet paper and enough water for hand washing. A holder should be provided with a covering to keep it dry. When flies are around, place baited fly traps outside each latrine inclosure. The box itself and the seal at its earthen base should be kept fly tight and repaired. The seats should be scrubbed daily with soap and water and dried after cleaning. The seat covers should always be kept closed when not in use. They should not be propped open when cleaning or for drying.

f. Deep pit latrines are closed when abandoned or when filled to within 2 feet of the surface of the pit. The box is removed; the pit is sprayed with oil and covered with burlap when it is available. Next, it is

filled with dirt (oil-soaked if the soil is loose or sandy), and tamped and domed 12 to 18 inches above the surface. If hogs or dogs are in the vicinity, cover the pit with heavy stones, logs, brush, broken glass, etc., to keep them from unearthing the contents. The site should not be used again so it is marked with a sign, "CLOSED LATRINE."

62. MOUND LATRINE. This type of latrine is used where there is a problem of high ground water. The earthen mound makes it possible to construct a deeper pit.

a. A mound with a top 6 feet wide and 12 feet long (minimum) is built for a standard four-seat latrine box. It should be high enough to meet the pit's requirements for depth, allowing 1 foot from the base of the pit to ground water. First, the area where the mound is to be raised is ploughed or dug up. Then layers are built up, each not more than a foot in depth. Each layer is packed solid and the surface is roughed before the next is added. If the earth is dry, sprinkling each layer will make it stick together and pack down more firmly. Where longer or wider pits are used, the mound must be correspondingly larger. It may be necessary to use revetment or bracing to keep the walls of the pit from caving. The size of the base of the mound depends upon the kind of soil used. A relatively flat slope is preferred. Advice from a soils engineer and extra equipment like bulldozers will speed up the work.

b. The mound latrine is flyproofed in the same way as the deep pit latrine. However, it will be necessary to extend the tamped area 2 feet down the slope of the mound in order to get 4 feet from the edge of the pit. Directions for closing the mound latrine are the same as for the deep pit latrine.

63. BORED-HOLE LATRINE. This type of latrine is used for sentry stations and other small isolated

posts. It is a round hole $1\frac{1}{2}$ feet in diameter and 15 or 20 feet deep, covered by a one-hole box latrine or by an improvised seat such as an oil drum sunk into the ground with one end removed, the other cut out to the shape of a standard latrine box seat hole and fitted with a flyproof lid. The depth and darkness of the pit generally will keep flies away from the bottom. A urinal consisting of 1-inch or larger pipe, similar to that used in a urine soakage pit (see par. 66), can be placed at one side of the seat. The lower end of the pipe extends to the hole, but must not protrude enough to be soiled by feces: Do not use in shallow well areas with hole extending to ground water level.

64. PAIL LATRINE. Where the soil makes a deep-pit latrine impracticable, a pail latrine is substituted.

a. A standard latrine box may be used as a pail latrine if hinged doors are placed on the rear, a floor added, and a pail placed under each seat. If the box is located in a building, it should be placed against the outer wall of the building so that the hinged doors of the latrine open directly on the outside. The latrine seats and rear doors should be self-closing, and the box

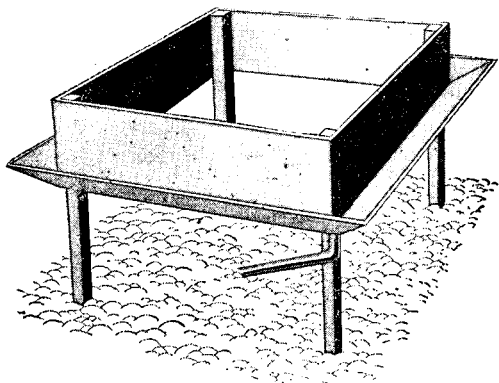

Figure 14. Pail latrine in building.

made flyproof. The floor of the box should be waterproof concrete if possible, and should slope toward the rear enough for wash water to drain rapidly.

b. A trough urinal may be installed inside the latrine building, with a drain pipe leading into a container outside the building.

c. Pails must be removed and emptied daily (more frequently if necessary). They should be replaced by clean pails containing 1 inch of quartermaster disinfectant (disinfectant, latrine bucket). The care of the latrine box is described in paragraph 61. The contents of the pail latrines may be disposed of in an Otway pit (see par. 65), by burial or by incineration. Sometimes it is possible to empty the pails into a nearby man-hole or sewer. (See fig. 14.)

65. OTWAY PIT. a. This pit is a type of septic tank used for dumping latrine buckets or hospital bedpans. Disinfectants other than those in the latrine buckets should not be used.

b. The pit is 10 feet long, 3 feet wide, and 6 to 8 feet deep. It should be located where there is no danger of contaminating water supply—at least 100 yards away from the kitchen, company streets, and water supply. The Otway pit is covered with timber on which is spread oil-soaked earth to make it flyproof and lightproof. A hole with a flyproof and lightproof cover is left at one end of the roof into which to dump excreta. There is another hole 6 inches in diameter at the other end of the roof and a standard flytrap is fixed over it. The only way light enters the pit is through the hole under the flytrap; newly hatched flies making for the light are caught in this trap.

66. URINE FACILITIES. In semipermanent stations, urinal space should be provided on the basis of 5 percent of the company.

a. **Urine trough.** If a deep pit latrine is dug in ground which absorbs liquids, a urine trough draining into the pit is included within the latrine inclosure.

This trough may be built of tin, galvanized iron, or wood. If it is made of wood, it should be lined with tarpaper. The trough is U- or V-shaped, 10 feet in length for every 100 men, and slopes to one end. At the lower end, it is connected to the pit by a short section of pipe fitted with fine-mesh fly screen. However, the pipe may be omitted and the trough may extend directly into the pit if the point at which it enters is flyproof. This trough must be washed daily with soap and water.

b. Urine soakage pit. If the latrine pit is in soil which absorbs liquids poorly, a separate urine soakage pit should be built. This pit is about 4 feet square and 4 feet deep. It is filled with pieces of broken rock, flattened tin cans, brick, broken bottles, and other contact material. (See fig. 15.)

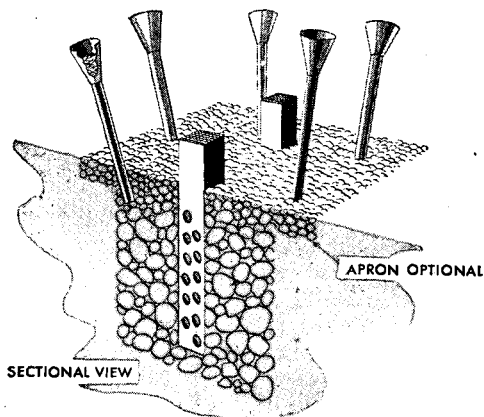

Figure 15. Soakage pit with trough urinal (without ventilating shaft).

(1) Two ventilating shafts, 4 to 6 inches square, are inserted to lessen odors. These shafts extend from about 1 foot above the surface to within 6 inches of the bottom of the pit and contain a number of holes

along their sides. The tops of the shafts are covered with fine screen, straw, or grass to keep out the flies.

(2) Urinals made of pipe 1 inch in diameter or larger are placed at each corner of the pit and along the sides. (There should be at least five for every 100 men.) The pipes reach 8 inches below the surface. In the upper end of each pipe is placed a funnel of sheet metal, tarpaper, or similar material. The rim

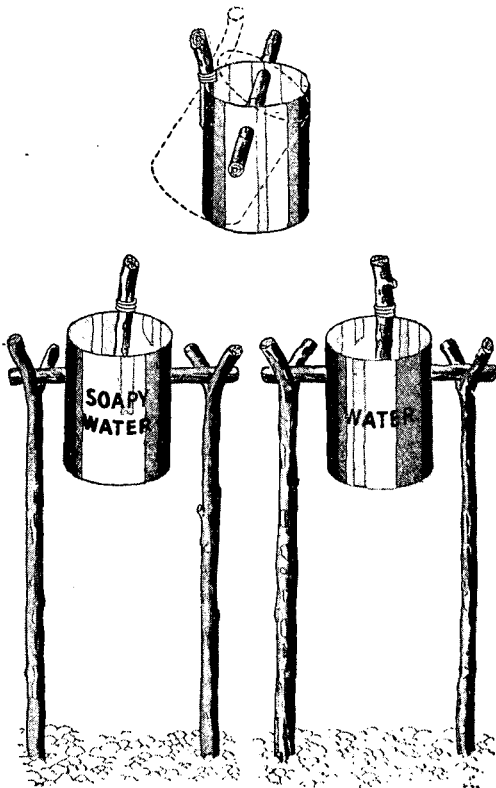

Figure 16. Soakage pits with pipe urinals (and ventilating shafts).

of the funnel should be about 26 inches from the ground. These funnels are filled with grass or straw to keep out flies and to keep the pipes from getting clogged with cigarette butts, etc. (See fig. 16.)

(3) Since a soakage pit can usually accommodate 200 men indefinitely, it is better to surround it with a square trough urinal instead of using individual funnels. The trough is 6 feet square with a drain pipe extending from the lowermost corner to 8 inches below the surface in the center of the pit. Care must be taken in leveling the trough to assure good drainage and to prevent pooling of urine. The pipe reaches below the surface to prevent contamination and to lessen odor. The urinal trough may be located within the latrine inclosure, with the pit outside.

(4) Special precautions to take for urine soakage pits are: Don't let the men urinate on the pit itself; change the grass or straw in the funnels daily; clean the funnels with soap and water; change funnels when necessary; and keep the pit free from oil or any other substance which might clog it.

(5) When the pit is to be closed, withdraw the pipes and cover the pit with earth.

c. Night urinal cans. If the latrines are located out of the way, a large can or pail containing 1 inch of quartermaster disinfectant (disinfectant, latrine bucket) can be placed at the end of each company street at night for use as a urinal. Each morning the contents of the cans will be poured into the latrines or urine soakage pits, and the cans washed thoroughly.

SECTION III. GARBAGE

67. GARBAGE. Garbage is the solid and semisolid waste produced in the preparation or serving of food and is divided into two classes: *edible* garbage is suitable for animal food; *nonedible* garbage is worthless as animal food and is made up of such items as coffee grounds, tea leaves, citrus fruit rinds, banana peels and stalks, fish heads and scales. It does not however

include ashes, street sweepings, rags, boxes, tin cans, or paper. For a company of 200 men, solid garbage averages from 300 to 400 pounds a day. This garbage must be removed from the mess area before it causes offensive odors and attracts flies and rats. Garbage will be collected from company kitchens and hauled away for disposal at least once a day. It will not be transferred from one can to another or from a garbage can to a vehicle during collection with one exception (see par. 68e). Transfer always results in spilling, which in turn pollutes the soil and attracts flies.

68. COLLECTION. a. Salvage. The number of cans used to collect garbage at the kitchen depends upon the method of disposal. Few are needed when all the garbage is buried or incinerated; more, when parts of the garbage are salvaged and sold (see b below). If garbage is to be used for animal food, the edible portion should be extracted in the kitchen. Coffee grounds, tea leaves, egg shells, banana peels and stalks, citrus rinds, tin cans, paper, and other rubbish are nonedible. Some items of garbage like fats should be kept in separate containers for collection as part of a salvage program.

b. Garbage cans. Each mess hall must be supplied enough garbage cans to store the garbage from one collection to the next and to permit separation as prescribed at the particular installation. These cans must have well-fitted covers which are kept on the cans at all times except when garbage is being deposited or emptied. No can will be filled higher than 4 inches from the top; this lessens the possibility of spilling when the cans are moved from the garbage stand (see d below). Garbage cans should not be stacked on a truck because the covers get mashed and then will no longer fit properly. However, if the garbage collector furnishes flat wooden covers for the cans while they are being hauled away, the cans may be stacked without spilling. Then each mess hall can retain its own can covers. These lids should be washed

in hot soapy water and replaced on the cans as soon as they are returned. Cans are always kept on the garbage stand except when they are removed by the collector. They should not be kept in the kitchen.

c. Washrack. There should be a central garbage can wash rack on the post, preferably at the incinerator, garbage transfer station, or sanitary fill. It should be of concrete and big enough to handle the necessary number of cans each day. There should be a sufficient hot and cold water supply and, where possible, facilities for steaming the cans to remove accumulated grease.

d. Stands. In permanent or semipermanent camps, the stands should be placed near the kitchens. The best garbage stands are built of solid concrete or concrete blocks with an 18-inch apron of concrete at the base.

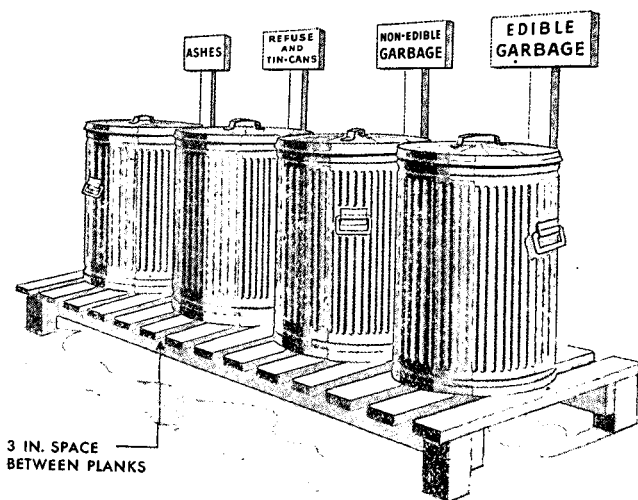

Figure 17. Garbage stand.

The stand may be from 12 inches to truck floor level in height. Steps may be necessary for the higher stand, but it has the advantage of being level with the

truck floors for easier loading. When concrete is not available, the stands may be made of wood. The boards are laid crosswise and spaced 3 inches apart so that spilled garbage is not retained between the boards. However, there is no more reason for spilling garbage on the stand than on the kitchen floor. Washing it off the stand will only build up an unsanitary condition on the nearby ground. Oiling this area will not remedy the condition. The only solution is to handle the garbage carefully. The stands will not be screened. If the stands are kept clean, and if the cans are clean and tightly covered, flies will not be attracted. (See fig. 17.)

e. Transfer at kitchens. If there is a shortage of garbage cans, garbage may be transferred from cans at the kitchen to watertight containers or other cans on the collecting vehicle. In such cases, a can-washing trough will be made a part of each rack, and it must be equipped with drain to sewer system, and hot and cold water taps.

69. SALE OR GIFT. Garbage is often sold or given away to civilians to feed hogs. Unless the contractor cooperates fully, spilled garbage, leaky containers, and late collections will cause unsanitary conditions at the camp and make other means of disposal advisable. Moreover, the site of final disposition should be far enough away from the camp so that odors and flies will not become a nuisance. The contract should require compliance with all Army regulations and all local and State health laws on garbage disposal.

70. HOG FEEDING. Unless there are at least 500 troops in a camp for a considerable time, this method of disposal is not practicable because each hog requires about 50 pounds of garbage a day, of which 15 to 20 pounds are eaten. The rest must be removed from feeding areas and disposed of in a sanitary manner. Garbage alone does not produce a satisfactory grade of pork, consequently other food will be necessary if the hog farm is to supply meat for the post.

Hog raising on a military reservation is not recommended because of the fly and odor nuisance.

71. BURIAL. a. Sanitary fill. This approved method is used to get rid of garbage and rubbish in some large camps where collection and disposal of waste is handled by the Corps of Engineers. It requires the use of heavy machinery like draglines or tractors with bull-clam attachments, and also calls for careful supervision of technique. The garbage and rubbish are placed in a trench and compacted. The top is covered with about 2 feet of firmly packed earth and it is not necessary to seal the end each day. Within 4 days, the end is closed to form a compartment or cell. No burning is done at sanitary fills. (See fig. 18.)

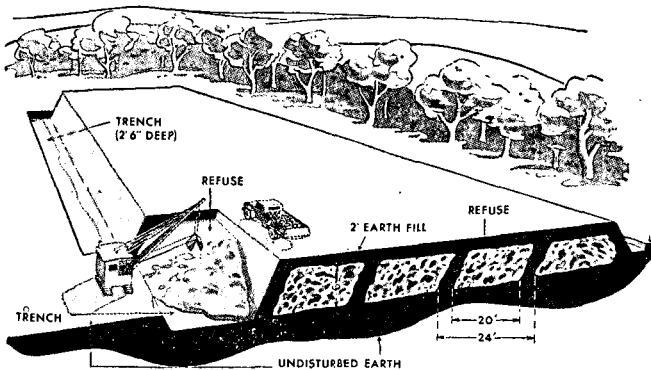

Figure 18. Garbage and rubbish disposal by sanitary fill.

b. Garbage pit or trench. When a unit is on the march, in bivouacs, or in camps of less than 1 week, kitchen wastes are buried in pits or trenches 3 to 4 feet in depth. (A pit for 100 men per day is usually 4 feet square and 4 feet deep.) Trenches are about 2 feet wide; their length can be varied to meet the need. When a trench is filled to within 2 feet of the top, it is back-filled and then domed with earth. If

the trench is not domed for 12 to 18 inches, the garbage may be uncovered by storms or animals and create a fly and odor nuisance. A continuous trench may be used. Each day's garbage can be covered by the excavation made for the following day. The trench or pit should not be within 100 yards of any source of cooking or drinking water; but it should be within 30 yards of the kitchen.

72. INCINERATION. Burning is a frequent means of destroying material.

a. Closed type incinerators. Permanent camps may use large closed type incinerators. These consist of burning grates, fire box, and chimney and need trained engineer personnel for construction and operation.

b. Cross trench and stack incinerator. (1) An efficient type of company field incinerator is the stack or barrel cross trench incinerator. This type consists of a barrellike stack which is placed over the intersection of crossed trenches. Two trenches, 1 foot wide and 10 feet long, are built so that their centers cross at right angles. Each trench slopes from the surface of the ground at each end to a depth of 18 inches at the center of the intersection. A grate made of small iron pipes or bars 2 or 3 inches apart is placed on the ground at the intersection. Over it is the stack which preheats and partially dries the garbage before it is burned.

(2) The stack may be made of a GI can or oil drum with the ends removed, or of brick, stone, or clay. Stone is most efficient and durable (see fig. 19); however, an oil drum can be set up quickly (see fig. 20). The choice of material depends upon what is available locally. If the stack is made of clay, use a wooden barrel as a mold. Remove the ends of the barrel and place it over the intersection of the trenches. Mold puddled clay around the barrel about 18 inches thick at the bottom and tapered to 8 inches at the top. Insert the grate irons into the clay, through holes in the barrel, about 6 inches above the surface of the

ground and 4 inches apart. Make a small fire in one of the trenches and let the clay dry slowly for 6 or 8 hours without burning the barrel since rapid drying will crack the clay.

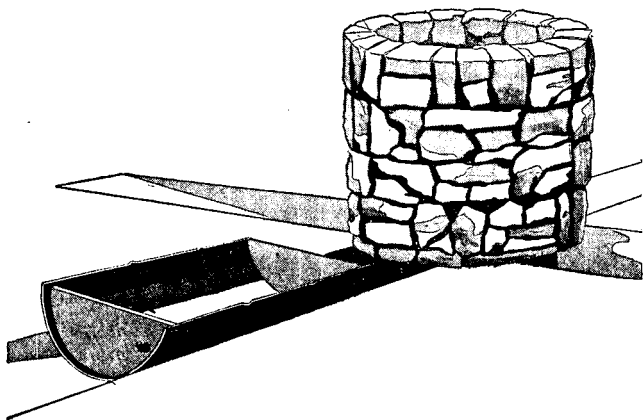

Figure 19. Cross trench and stone stack incinerator.

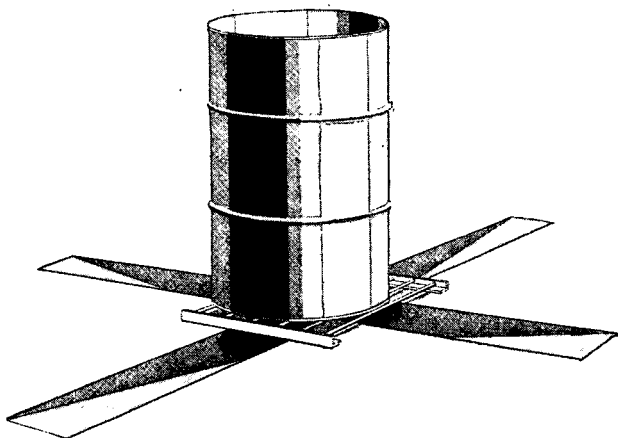

Figure 20. Cross trench and oil drum stack incinerator.

(3) Cross trench incinerators operated properly will take care of the garbage produced by one infantry company. Start the fire on top of the grate. If it is hard to keep this fire going when the garbage is deposited, reinforce it with another fire under the grate in the trench. Be careful not to smother the fire by dumping all the garbage in at once. Drain it first. Wet garbage may be partially dried in a metal trough (cut from an oil drum) placed over one branch of the fire trench (see fig. 19). If garbage is mixed with dry combustible rubbish and tin cans it will burn more readily. Remove ashes frequently.

c. Inclined plane incinerator. This is the best of the small, improvised incinerators, used in semipermanent camps. Its size makes it suitable for a company, battalion, or a mobile hospital.

(1) The incinerator is illustrated in figure 21. It has an incline of corrugated iron which rests upon a rock bed and is covered with portions of steel drums. There is a loading and stoking area at the rear and a grate area at the front. The stoking area has a hinged iron cover. A vent 5 by 16 inches is left for draft at the outlet of the incline. Besides, the grate is covered with a door which may be opened for a draft.

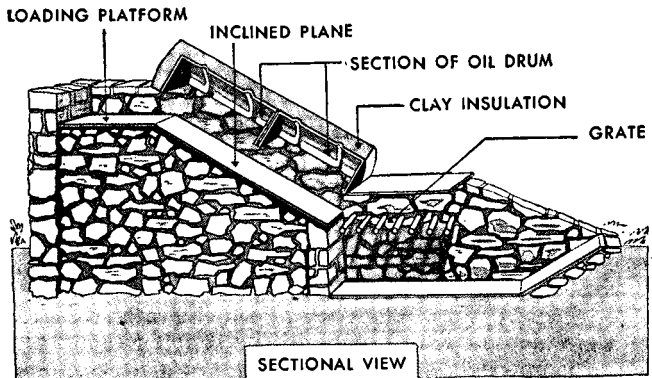

Figure 21. Inclined plane incinerator.

(2) Sections of two oil drums are used to cover the incline; and are cut lengthwise 4 inches above the center. The smaller sections are used with the ends left in. These sections are placed end to end like a tunnel on the side walls, 8 inches above the inclined floor. The side walls may be built of stone, brick, or concrete. Then puddled clay is placed 2 inches thick over the top of the drums.

(3) When there are no suitable materials for building side walls, the incinerator may be built on any sloping hillside or ditch bank. The fire pit is excavated at the lower end. The inclined plane is made of flat stones or tamped earth (clay preferred). The cut-oil drums cover the inclined plane and extend over the fire pit far enough for the flame to be drawn up the incline. A stoking area for the garbage is dug at the upper end and the removed earth can be used to cover the oil drums to retain heat in the incinerator.

(4) A fire of wood and rubbish is built on the grate. After the incinerator becomes hot, empty a canful of drained garbage on the stoking area. Push some part way down the incline. As the garbage dries on the incline, it gradually slips down to the grate and is pushed along by more garbage from the stoking area. The cover on the stoking area retains heat which makes considerable drying and even burning take place on the incline. The ends of the oil drum sections serve as baffles which cause swirling of burning gases and aid drying and combustion.

d. Rock pile incinerator. This type of incinerator is generally used to dispose of garbage and combustible rubbish from several companies up to a regiment. It is simple to build but wasteful of fuel. Because of the odor nuisance, it should be located on the leeward side as far practicable from the barracks and no closer than 500 yards. (See fig. 22.)

(1) *Construction.* The rock pile incinerator consists of a circular pit with a cone in the center to send air currents upward and create a draft. The wall, bottom, and cone are made of loose rock. The pit is about 16

feet in diameter and 2 to 2½ feet deep, with floor and walls up to 18 inches thick. The draft may be improved by installing draft holes where the wall and bottom of the pit meet. These holes are 6 to 12 inches in diameter and are spaced equally around the pit.

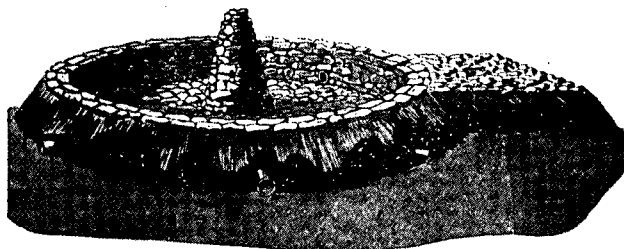

Figure 22. Rock pile incinerator.

(2) *Operation.* A fire is built around the base of the cone and on its wind side. Garbage is placed between the fire and the walls. After the garbage is partially dry, it is gradually pushed on the fire. This incinerator requires about 1 cord of wood to burn 2 tons of garbage.

e. Oil-water flash burner. This type of incinerator can be used under field conditions for heating and for burning garbage, rubbish, hospital dressings, and human wastes. The principles of its operation are simple: a mixture of oil and water drops onto a metal burner plate which has been preheated to the flash point of the oil. When the water hits the hot burner plate, it forms steam which thoroughly atomizes the oil. The hot plate causes the oil to burst into a brisk, cracking fire. The oil-water flash burner consists of a metal burner plate, feed pipe, and water and oil containers equipped with a means for slow controlled discharge. There is also a suitable grate and inclosure for holding the material to be destroyed, and a pan or other arrangement to hold excess water and oil below the burner plate. (See fig. 23.)

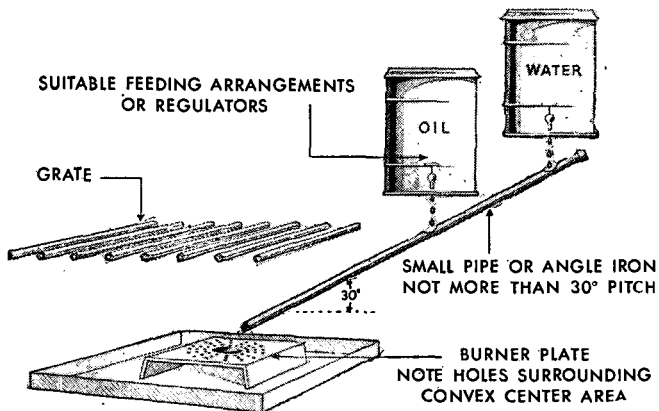

Figure 23. Elements of oil-water flash burner.

(1) The waste motor oil should be free from water and large particles of suspended matter that might interfere with uniform flow. Therefore, it may be necessary to strain the oil through a screen or cloth. If the oil is too heavy to flow readily, thin it out with a lighter oil, kerosene, or gasoline. Less than 1 gallon of oil is used to maintain a large fire for an hour. Oil and water for combustion are placed in suitable sized containers (usually 5-gallon cans) fitted with taps, valves, or other arrangements for slow, continuous feeding. The mixture is carried by gravity through a $\frac{3}{4}$ -inch pipe to a point about 2 inches above the center of the burner plate.

(2) Figure 24 shows a typical burner adapted to destroy garbage or human wastes. It consists of fuel supply arrangement, burner plate assembly, combustion chamber, and stack. The heavy-gauge metal burner plate should be about 8 inches square. The center area is slightly raised (convex) and outer portion of the plate is punched with a number of small holes which increase air supply for burning. The burner plate must be preheated before the oil-waste feed is turned on.

This can be done by setting the plate about 3 inches above the bottom of the burner housing. That leaves enough room for a small pan of gasoline to be placed under the plate. It is important that the burner plate be protected from strong drafts, rain, or anything else that would cool it off. (See fig. 24.) The combustion chamber is built from an oil drum with its size depending on desired capacity. A drying pan or hearth is placed upon supports. The cover plate, pan, hearth, supports, and other parts should be completely demountable for cleaning. The stack on the end of the drum which controls the drafts and carries the smoke away should be provided with a damper. If possible, a stovepipe about 8 feet long should be used, but in the field the stack can be improvised from stone or other material.

(3) Make sure that the oil-water mixture is properly regulated and that the burner plate is adequately preheated. The proportion of oil to water varies but the mixture is generally 4 parts oil to 1 part water. When the burner is properly operated, it produces very little smoke or odor. It may be helpful to apply draft control arrangements like shields in bad weather. The speed of destroying garbage will depend on how wet it is to begin with, how porous the material, and how fast the incinerator is fed.

SECTION IV. LIQUID WASTES

73. KITCHEN WASTES. In permanent or semipermanent camps where sewers are available, liquid kitchen wastes drain through grease traps directly into the sewer lines. In temporary camps, they must be disposed of in the soil. To make absorption easier and to prevent clogging of the soil, always remove grease from liquid kitchen wastes before emptying into any kind of pit or trench.

a. Soakage pits. (1) If the liquid kitchen wastes from a company of 200 men (or not more than 200 gallons per day) must be disposed of, a soakage pit

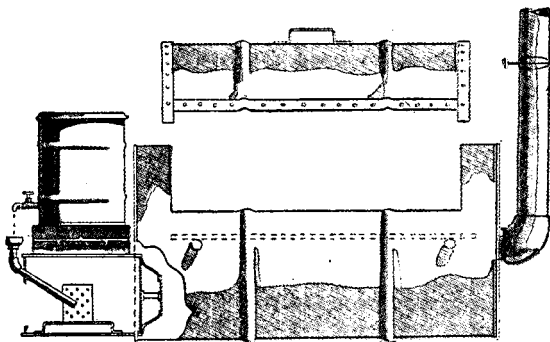
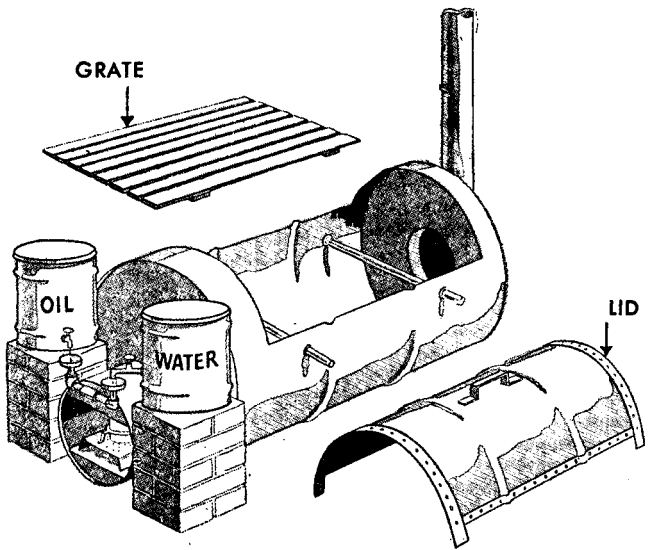

Figure 24. Oil-water flash burner destructor.

similar in construction to the urine soakage pit is used. Fill a hole 4 feet square and 4 feet deep with broken rock. The pieces of rock should vary in size from about 3 inches in diameter at the bottom to 1 inch at the top of the pit. Tin cans or broken bottles may be substituted for the rock. Ventilating shafts similar to those in the urine soakage pit are used.

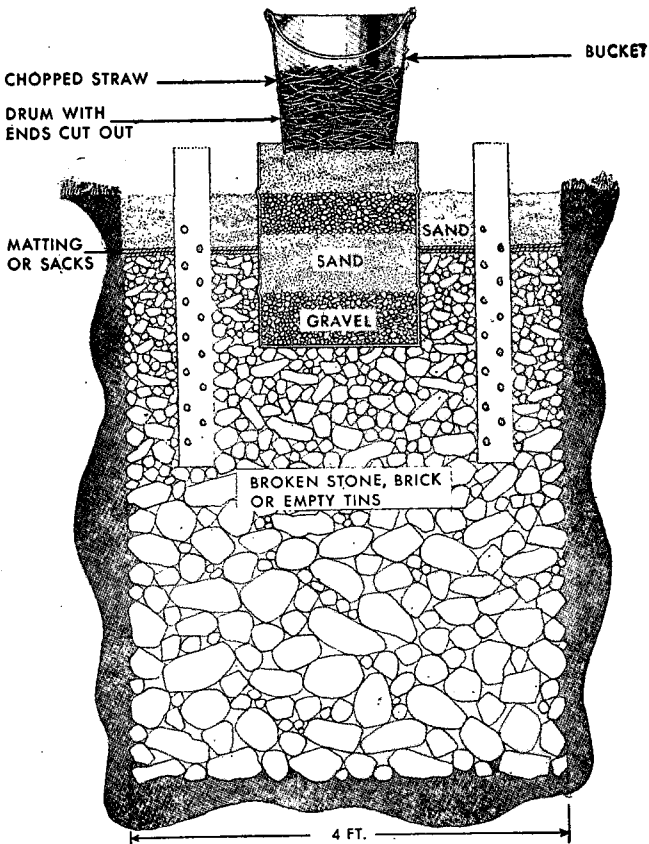

Figure 25. Kitchen soakage pits and baffle grease trap.

A grease trap is necessary to prevent clogging. (See par. 74.)

(2) There should be two soakage pits for each kitchen if the camp is to last several weeks. A daily rest period of several hours will increase their efficiency. When two pits are available, they should be used on alternate days. In camps of long duration, each soakage pit should be given a rest period of 1 week every month. If, in spite of these precautions, the pit becomes clogged with organic material, the addition of 5 gallons of 10 percent solution of either calcium hypochlorite or caustic soda may clear it.

(3) The best location for soakage pits is near the kitchen if suitable soil can be found. Otherwise, they should be located where there is satisfactory drainage. (See fig. 25.)

b. Soakage trenches. If ground water level or a rock stratum is near the surface of the ground, substitute a soakage trench for the soakage pit. This trench consists of a central pit 2 feet square and 1 foot deep, with a trench radiating outward from each corner for a distance of 6 feet. These radiating trenches are 1 foot wide and vary in depth from 1 foot where they leave the central pit to $1\frac{1}{2}$ feet at the outer end. The central pit and radiating trenches are filled with broken rock. A grease trap must also be used with this trench. (See fig. 26.)

c. Sullage pit. Getting rid of liquid wastes by merely digging a hole in the ground (sullage pit) and pouring them in will meet with little success. If the soil is loose, it will cave in and fill the hole; if it is tight, it will absorb very little fluid and the hole will soon fill up. Any attempt to close the filled hole will cause an overflow and pollution of the surrounding area.

74. GREASE TRAPS. Before liquid wastes are placed in the soakage pit, they must be passed through a grease trap to remove food particles and as much

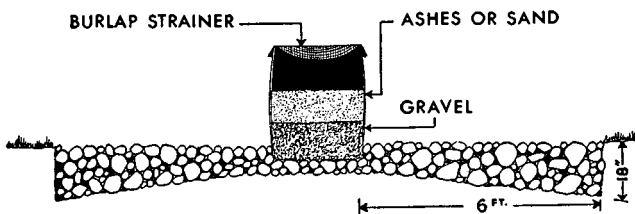
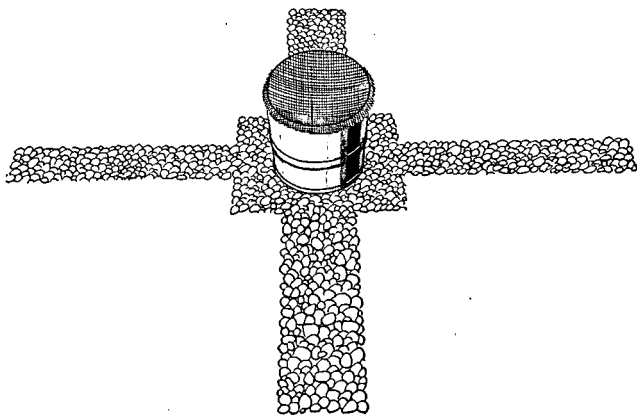

CAPACITY—2 PER COMPANY EACH USED ON ALTERNATE DAYS

Figure 26. Soakage trench with barrel grease trap.

grease as possible. Otherwise, the side walls of the pit soon get coated with grease, and keep the soil from absorbing the water.

a. **Baffle grease trap.** (1) This trap can be made of a half barrel or box divided into unequal chambers by a wooden baffle which extends to within 1 inch of the bottom. The larger chamber, two-thirds of the

barrel, is where the liquid is poured in; the smaller chamber is where it flows out. The trap has a hinged removable lid and a removable strainer in the lid of the larger chamber. This strainer, which is about

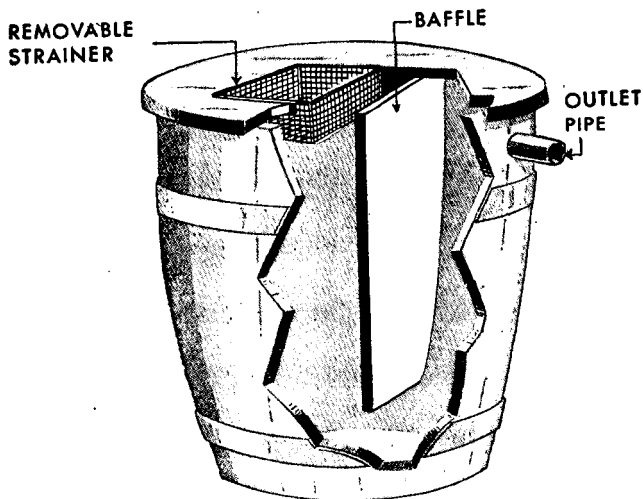
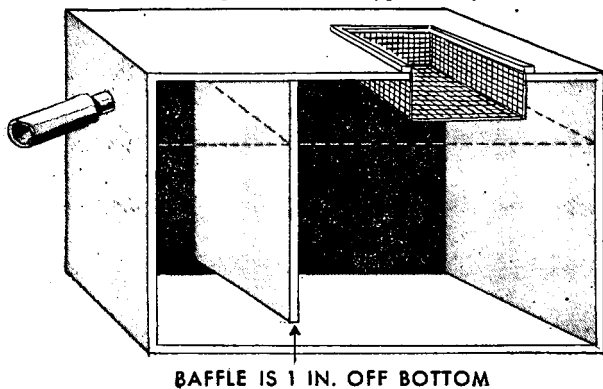

Figure 27. Baffle grease traps
(barrel type above; box type below).



8 inches square and 6 inches deep, is filled with straw to keep the coarser solids from entering the trap. Because the strainer is removable, it is easy to clean. A 1-inch pipe is inserted near the top of the smaller chamber to lead to the soakage pit.

(2) To operate the trap, fill both chambers with cold water. When the warm liquid waste meets the cold water in the large chamber, the grease congeals and rises to the surface. The baffle board prevents the grease from reaching the outlet to the soakage pit. The grease trap must be big enough so that the hot greasy water passing through will not heat it. Otherwise, the grease will remain in solution instead of congealing and rising to the surface. It may be necessary to make two or more grease traps so that one can cool while the other is in use.

(3) To prevent the trap from becoming a nuisance, remove grease, drain trap, remove and burn sediment, and clean removable strainer thoroughly with soap and water whenever necessary. (See fig. 27.)

b. Ash barrel grease trap. This type requires more attention than the baffle grease trap. It may be prepared from a barrel of 30- to 50-gallon capacity. Bore about thirty 1-inch holes in the bottom. Place about 8 inches of gravel or small stones in the bottom of the barrel and cover these with 16 inches of wood ashes. Fasten a piece of burlap over the open top of the barrel to act as a strainer. This trap may be placed either directly over a soakage pit or on a platform with a drainage pipe or trough leading to the pit. This grease trap should be emptied, washed, and refilled with fresh ashes at least every 2 days. The discarded ashes should be burned or buried. The burlap covering should be washed or renewed every day. (See fig. 28.)

c. Pail strainer. An old metal pail or can with perforations in the bottom, filled with hay, grass, straw, or an old blanket, will remove food particles and a small part of the grease from liquid wastes. However, most of the grease will pass through. This type of strainer should never be used except while waiting

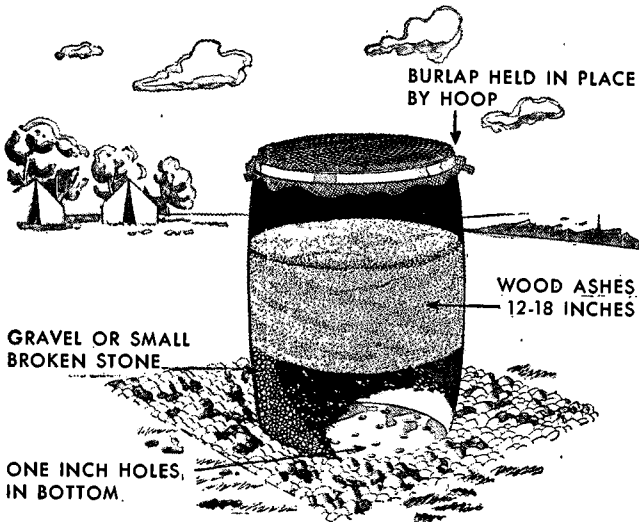

Figure 28. Ash barrel grease trap.

for a grease trap to be built.

75. BATH AND WASH WATER. Where sewers are not available, it may be necessary to pass bath and wash water through a grease trap and dispose of it in soakage pits or trenches. Facilities for washing hands and faces may have to be improvised. Usually, a wash bench like the one in figure 29 is installed at one end of the company street.

SECTION V. MANURE

76. GENERAL. Manure is one of the most fertile breeding places for flies, therefore special care must be taken to dispose of it. The quantity of manure to be gotten rid of will vary with the kind of care animals get. Animals kept on picket lines without bedding can each be expected to produce 10 pounds per day. Where bedding is used, there will be from 2 to 3 cubic feet of manure from each animal every day. This manure should be collected early in the morning. All sweep-

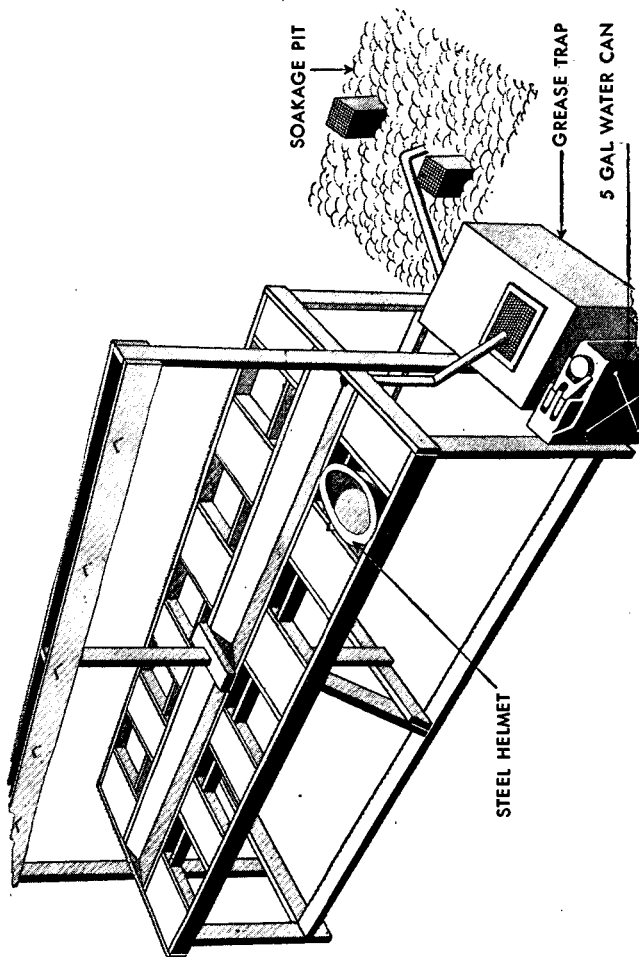

Figure 29. Washing device with soakage pit.

ings from picket lines or stables should be included in the collections and no manure should be spilled in hauling to the place of disposal.

77. DISPOSAL BY CONTRACT. The contractor may collect the manure at the stables or picket line, or it may be delivered to him at a transfer point. The contractor should be bonded and the contract worded so that flybreeding will be prevented within the military reservation no matter how the collection is made. When a contractor disposes of manure, he should be required to take special measures to prevent flybreeding. Local laws and regulations should be observed in making the contract.

78. COMPOSTING. When manure is composted or closely packed in a heap, bin, or other container, fermentation raises the temperature in the center of the mass to from 140° to 160° F. Since fly larvae are killed at 115° F., within a few minutes all except those in the outside of the heap will be destroyed.

a. Compost area. The method outlined below will care for manure accumulated from 100 animals for a period of 6 weeks to 2 months. It consists of carefully preparing a trenched earthen area, spreading manure on it in a systematic manner, and treating it properly.

(1) The compost area should be 60 feet long and 20 feet wide, nearly level, and surrounded by a vertical-walled, flat-bottomed trench which is 12 inches wide and 12 inches deep. (The area may be enlarged for more animals or a longer period of time.) On both sides of the trench, the vegetation is removed for a distance of 2 feet. Then the exposed ground is treated with oil, preferably road oil, and tamped firmly. It should take eight men about 4 hours to do the whole job, depending on the type of soil. (For the application of DDT, see ch. 14.)

(2) Manure is heaped on the compost area as shown in figure 30. Beginning at corner "A", spread the first day's manure over half the width of the area. Extend it 4 feet lengthwise and pile it to a height of 4 or 5 feet. Pack the manure tightly and keep the side of the pile vertical. The second day's manure should be similarly

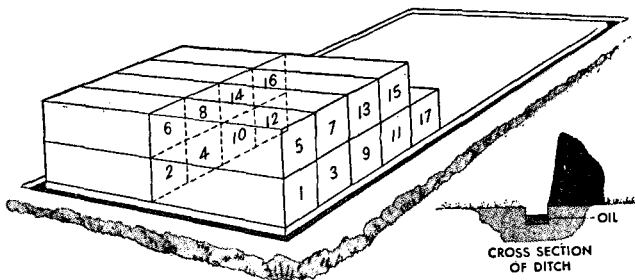

Figure 30. Compost pile.

placed on the adjacent corner "B" and tightly packed against the end of the first pile. The third day's manure is tightly packed against the first day's; the fourth day's against the second day's. On the fifth day, the manure should be placed on the top of the first pile. The sixth pile goes on top of the second pile; the seventh on top of the third; the eighth on top of the fourth. The procedure for the succeeding days follows the routine for the first 8 days. Keep the top of the pile concave or depressed. The idea is to catch rain rather than shed it.

(3) The composted manure should be kept wet enough to promote active decomposition. Spray the sides of the heap daily with QM insecticide to control fly breeding. (See ch. 14.) If the insecticide is poisonous to poultry and the compost is accessible to the birds, fence the pile in with poultry wire. Saturate the sides of the trench with oil and place a small amount in the bottom. Use an oil that will kill the larvae of flies. Heavy road grade is satisfactory. (See ch. 14.) A number of well-baited flytraps should be kept near the pile. Taking care of a pile this size should occupy one man's entire time.

b. Compost bin. Manure may also be composted in a flyproof concrete or wooden bin; but this may be practical only in semipermanent camps. From $\frac{1}{2}$ to 1

cubic foot of space can be allowed daily for each animal.

c. Fertilizer. Only composted manure may be used on Army posts for fertilizer. Manure plowed under, without being dried, results in fly nuisance because it is always full of fly eggs.

SECTION VI. RUBBISH

79. GENERAL. Rubbish consists of material such as waste paper, wood, metal, glass, and crockery. It is classified as combustible or noncombustible, depending on whether or not it can be burned in an incinerator.

a. At permanent or semipermanent posts, combustible rubbish is either burned in an incinerator or deposited in a sanitary fill. Noncombustible rubbish, but not rubbish which rots or burns, may be disposed of on dumps. At permanent or semipermanent installations, rubbish disposal is the responsibility of the Corps of Engineers.

b. At temporary camps or bivouacs, combustible rubbish is burned, or buried as described in paragraphs 71 and 72. Noncombustible rubbish should be buried or covered with 2 feet of compacted earth to prevent fly and mosquito breeding and to eliminate rat harborage. Tin cans should be burned first to remove remaining food and then flattened before burial. Rubbish disposal at temporary camps or bivouacs is the responsibility of the unit commander.

CHAPTER 5

MESS SANITATION

SECTION I. GENERAL

80. IMPORTANCE. a. No part of the soldier's everyday life is more important than a good mess. Good food can contribute much to morale and efficiency but clean food is absolutely necessary for the Army's health. Contaminated or infected food is the main cause of intestinal diseases.

b. Mess sanitation calls for constant vigilance over the food supply, in cleanliness, in cooking, and in refrigeration. Other important features discussed later in this chapter include supervision of food handlers, kitchen cleanliness, care of equipment, and control of insects and rodents.

c. It should be remembered that this manual is *basic* only. Ingenuity can develop numerous devices and methods to reduce the causes of infection from food. Continuing inspection of every phase of the mess, from the time food is received, through its preparation to its consumption, is a rule which will pay dividends in the health of the men. Messes of other organizations and camps should be visited and ideas interchanged. The *good* mess officer is one who devotes his best efforts to improving *all* the conditions of his mess—not simply applying the basic rules.

81. ADMINISTRATION AND RESPONSIBILITY.

a. **Commanding officer.** An Army mess is administered by or under the supervision of the unit commanding officer. He is responsible to higher authority for mess operation, and though he may appoint a subordinate

for duty as mess officer, he cannot delegate his mess responsibility. Mess officers are responsible only to their commanding officer for mess management but seek and follow the advice of medical inspectors on matters dealing with sanitation and nutrition, subject to the commanding officer's approval.

b. Medical Department. Inspections, reports, and recommendations regarding such matters as personal hygiene of food handlers, general sanitation of the mess, sanitary preparation of food, and the nutritional value of the food served are made by the Medical Department. The commanding officer has direct responsibility for these matters but the Medical Department supervises them and advises him.

c. Quartermaster Corps. The Quartermaster Corps is responsible for the purchase, storage, and issue of food and preparation of master menus. It also conducts schools for the training of mess personnel and recommends measures for the proper preparation and serving of food. The quartermaster representative of a military installation or unit supervises these matters for the commanding officer. The actual preparation and serving of the food in an Army mess is the responsibility of the particular unit commander.

82. FACILITIES. Cleanliness of the mess depends on a hundred small details. All mess buildings should be screened. Screen doors and windows must be tightly fitted. Doors should open outward and close automatically, so that they will never be permitted to stand open. All food containers should be insectproof. Ice boxes and refrigerators should be placed so that they can be kept clean underneath. Complete facilities should be set up for cleaning mess cans and collecting garbage. Table tops in the mess hall should be of a single piece. If more than one board is used, the middle board or boards should be removable to allow thorough cleaning of all edges. Tables should be scrubbed with soap and water after each meal.

83. FOOD HANDLERS. There are two classes of food handlers: "permanent" and "temporary." Permanent food handlers include all men regularly assigned to mess duty and all Medical Department personnel who inspect meat and dairy products. Rotating kitchen police detailed by daily roster do not fall into this class and are called "temporary" food handlers. In parts of the world where sanitation is primitive and intestinal and other communicable diseases prevalent, natives should not be employed in Army messes to handle food or water.

a. Men are not assigned as permanent food handlers until the surgeon has given them a physical examination and reported that they are physically fit to handle food. Unit commanders and officers in charge of special messes must make monthly written reports to the surgeon, naming all permanent food handlers under their control. The surgeon takes necessary steps to have the men examined and to keep a permanent record of the findings. Results of examinations are reported to the organization commander without delay and men found unfit for the work will be relieved at once. A list of permanent food handlers with the date of their last physical must be kept posted in their mess.

b. Men in the transmitting stage of a communicable disease or known carriers of the germs of such diseases cannot be employed as food handlers. Mess officers and responsible noncommissioned officers must watch food handlers constantly and if they show any evidence of a communicable disease, order them to leave the mess at once and report to the surgeon. They will not be reemployed as food handlers without specific approval by the surgeon.

c. The mess sergeant or the ranking noncommissioned officer in the mess at the time should inspect all food handlers daily when they report for duty, and this applies to temporary food handlers as well. The inspection should be thorough enough to show that food handlers have no sign of illness; that their hands, fingernails, and clothes are clean; and that they have

no boils or other skin infections. Personal cleanliness of food handlers will be given careful attention during hours of duty, and maintained by disciplinary action if necessary. Facilities for washing hands must be provided and washing hands after visiting latrines must become an unailing routine.

SECTION II. INSPECTION OF FOOD

84. GENERAL PRECAUTIONS. Although Army food is inspected a number of times along the line, it must be given a final inspection when issued to the consuming unit. This is an extra precaution to make sure that none of the food has become spoiled or contaminated since the last inspection. The inspection of company mess should include checking products for official inspection stamps and for possible adulteration or other signs of tampering as well as spoilage. Any sanitary defects found in fresh meats will be brought to the attention of the Medical Department officer before the meat is prepared for serving. Inspecting officers should know enough about appearance, color, odor, flavor, and consistency of meats to pass judgment on sanitary acceptability.

85. FRESH AND CURED MEAT. **a. Color.** The color of fresh meat depends on the kind of animal, age, condition at slaughter, and the part of the carcass from which the meat is taken. Choice fresh beef should be bright cherry red; veal, a pinkish brown; mutton, dark pink or red; lamb and pork, light pink.

b. Odor. Meat should be free from any abnormal odor. The odor from an absolutely clean knife or trier, which has been passed into the meat near the bone, will give evidence of decomposition in the deeper parts of the meat.

c. Consistency. Sound meat should be firm to the touch and should barely moisten the finger; it should not be flabby or retain dents on pressure. If the meat has been only mildly affected on the surface, the in-

spector may consent to trimming or wiping portions of the cut, after which it is thoroughly reexamined. Slight surface spoilage and mold can be removed by wiping with diluted vinegar or baking soda solution. However, if a considerable part of the cut is unsound or of questionable freshness, it must not be used as food.

86. POULTRY. The term *poultry* includes chickens, ducks, geese, turkeys, and any other birds used for food. Poultry can spoil in the same way as meat products, but their tissues are even more likely to be contaminated with germs. Poultry is usually received freshly killed, chilled, or frozen and should be undrawn with head and feet intact. The single exception is that they may be accepted fully drawn when inspected and passed by Federal inspection agencies. Any evidence of decomposition, slimy or sour carcass, or other unsoundness will prevent poultry from being used as food.

87. EGGS. Disease germs are seldom transmitted by eggs, though some can pass through porous or cracked shells. All eggs should be inspected particularly for cleanliness, freshness, and soundness. Those found to be unsatisfactory should not be used for food. If many eggs are to be broken into a dish, they should be broken and dropped into a saucer first, one by one, so that any bad eggs will not spoil the whole batch. If a large part of a shipment is unsatisfactory, the entire lot should be returned at once to the supply agency. Duck eggs are not to be used by troops unless thoroughly cooked, since they may be contaminated without apparent change in color, odor, or appearance.

88. FISH AND OTHER SEA FOOD. a. All sea food must be carefully handled, transported, and stored from the time it is taken out of its natural water element until it reach the mess table. Otherwise, decomposition sets in rapidly. Certain signs should be

watched for in the inspection of fresh chilled fish to be sure they are edible and the following are the most important:

(1) *Gills*. Bright red; usually closed; no abnormal odor.

(2) *Eyes*. Prominent appearance; transparent cornea (window of the eye).

(3) *Scales*. Adherent with no loose scales.

(4) *Skin*. Free from malodorous slime; not discolored.

(5) *Flesh*. Firm; only temporary denting by finger pressure.

(6) *Body*. Stiff; sinks in water, tail rigid.

b. Any fish which seems to be injured, contaminated, or otherwise unsound is not to be used for food. Since oysters may spoil during shipment or shortly after, they should be inspected closely for spoilage, staleness, or adulteration. Whether oysters are shelled or unshelled, they are so perishable that they should be kept in original containers until used. Oysters which have been improperly handled may give off a disagreeable odor. Pink discoloration indicates the oysters are not fresh and makes them undesirable to eat. Usually only canned crabs, clams, shrimps, and lobsters are used in Army messes but when they are received fresh they are to be inspected and should have a bright, normal color and no off odor.

89. DAIRY PRODUCTS. **a.** *Milk* in the raw state frequently transmits certain diseases. This is so because milk is ideal food for germs and is readily contaminated in handling. Extreme care must be taken in every stage of milk handling. When possible, milk should be purchased only from places which are supervised by the Army veterinary inspection service. Milk issued to troops for beverages and cooking should always be pasteurized. Pasteurization kills those germs harmful to man. Raw milk is forbidden and the issue of pasteurized milk in bulk is discouraged. Milk for drinking should be served in the original container.

b. *Butter* is the fat which is churned from sweet or sour cream. Butter, like milk, must be closely safeguarded in every stage of its handling.

90. CANNED FOODS. All types of canned foods should be examined carefully for faulty containers. Contaminated or improperly processed containers can cause spoilage which is dangerous to health. It is easy to detect defective cans and to classify them into the three groups listed below. All three of these should be rejected for food.

a. A *leaker* is a sealed can with a defect which allows air to enter or the contents to escape. When a leak is small, the inside vacuum of the can will be lost and this may cause both concave ends to disappear.

b. A *springer* is a sealed can whose ends show loose tin or one end bulging. Outside pressure on the bulging end will cause the other end to bulge. There are many causes for this condition. Sometimes it can be traced to gas-producing organisms which were not killed in sterilization of the filled can after sealing.

c. A *sweller* is a sealed can in which gases resulting from any cause produce bulging of sides and ends. The causes are the same as those which produce the springer.

SECTION III.

HANDLING AND STORAGE OF FOOD

91. GENERAL PRECAUTIONS. As far as possible, food will be protected against sun, heat, dust, insects, rodents, and any other factor which causes germs to multiply in food or which contaminates food. Perishable fresh vegetables, meats, dairy products, and bread should be issued every day and preferably early in the morning. Vehicles handling exposed food supplies like fresh meats must be kept scrupulously clean. Every organization must provide tarpaulins, cloths, or bags for proper protection of its own supplies in order to prevent contamination from handling, exposure, or

contact with the vehicle. The officer who issues food supplies must report any organization which fails to comply with this instruction. The inside of ice boxes and refrigerators must be kept scrupulously clean. Highest temperature for mechanical refrigerators is 42° F. and for ice boxes 50° F.

92. FACILITIES. When an organization uses mess buildings, complete refrigeration and storage facilities are usually provided. Some of these may be furnished in the field but if not, each unit should devise its own substitutes. Material available will usually determine the method. The following devices for storing and preserving food in temporary camps have proved useful and may be adapted to the particular situation.

a. The *suspended food container* is a screened box that cools by free circulation of air and may easily be hung from a tree branch, cross pole, or tripod. It is not very satisfactory if there is much dust in the air. In dry climates, food may be kept cooler by wrapping the box in damp burlap and this will also cut down dust. Such containers are suitable for fresh meat, vegetables, bottled milk, and other perishable foods. Use only as a very temporary measure for the meat and milk. During warm weather, meat and milk will not keep longer than one day in this container.

b. *Watertight containers* containing perishable food may be immersed in cold water springs or streams, taking care to prevent contamination.

c. *Underground storage pits* may be used to take advantage of lower temperatures below the ground surface. This is done by digging a pit, lining it with burlap or other suitable material, and building a floor with boards, rocks, branches, or palm leaves.

d. *Underground cooling boxes* are used when ice is not available. Cooling is dependent entirely upon the lower temperatures below the level of the ground. This device is constructed as a single walled box with only the lid insulated.

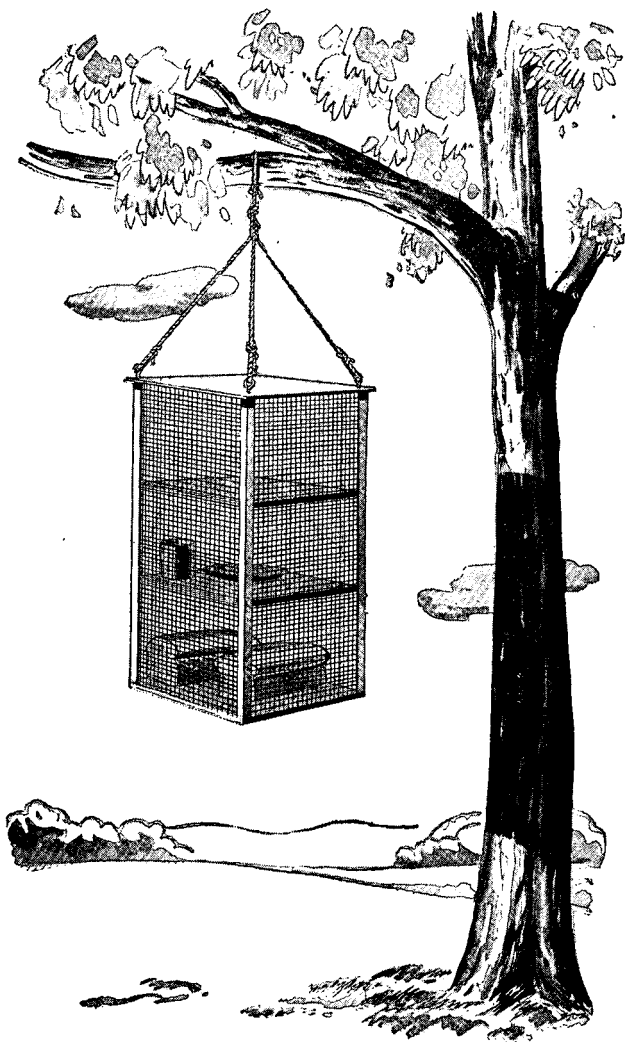

Figure 31. Suspended food container.

e. *Underground ice boxes* are simple devices which are nothing more than double-walled containers. They are made by placing one box within a larger one, with a 3- to 6-inch space separating the walls and bottom of the inner and outer box. This space is filled with sawdust, grass, hay, or straw and a separate lid is made for each box with the outer lid insulated. An inner box with inside measurements of 4 by 3 by 3 feet will be large enough to handle the average company mess. A drain pipe is made to lead through the bottom, or a perforated bottom is used. A compartment for ice is made adjoining the drain pipe. To seat the underground ice box, dig a hole preferably in a shady place and just deep enough so that the outer lid of the box will be slightly above the surface of the ground. Put enough gravel or stone in the bottom of the hole to

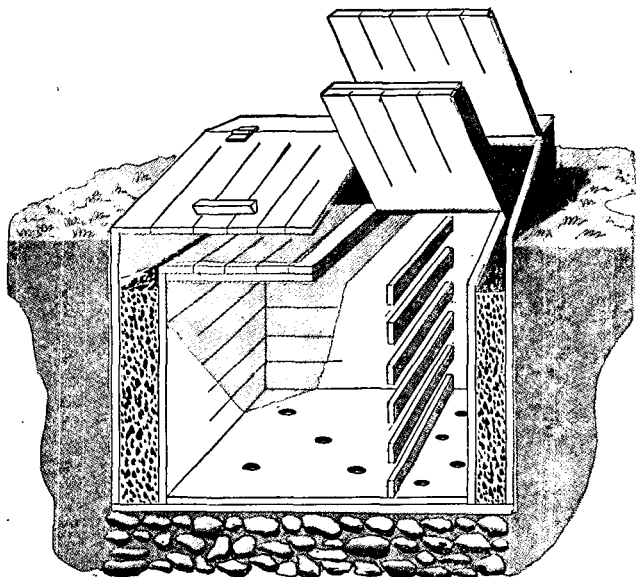

Figure 32. Underground ice box.

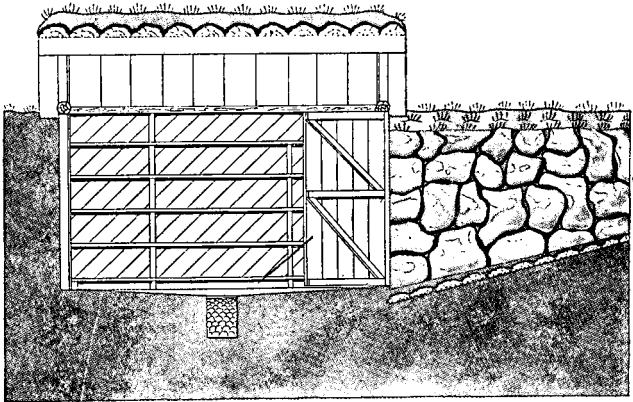

Figure 33. Underground storeroom.

allow for drainage. Lower the box into position, pack earth against it, and provide for draining off rain water around the box. When necessary, the underground ice box can be removed and mounted on a kitchen truck to use as a portable ice box until installed in the next camp.

f. *Underground storage* rooms can be built for semipermanent camps. These are similar to the old-fashioned root cellars. The floor is made of well-tamped earth or boards, and the walls should be boarded. Windows at the ends or a roof outlet will provide ventilation.

g. *Vegetable bins* can be made of spaced slats for storage of vegetables. Such bins will permit free circulation of air around the vegetables and thus help preserve them. The bottom of the bins should slope sufficiently to allow the oldest vegetables to be used first.

93. BREAD. Bread should be stored in a screened cabinet to protect it from flies and crawling insects. Bread bins with solid walls are not desirable since they prevent free circulation of air and thereby hasten

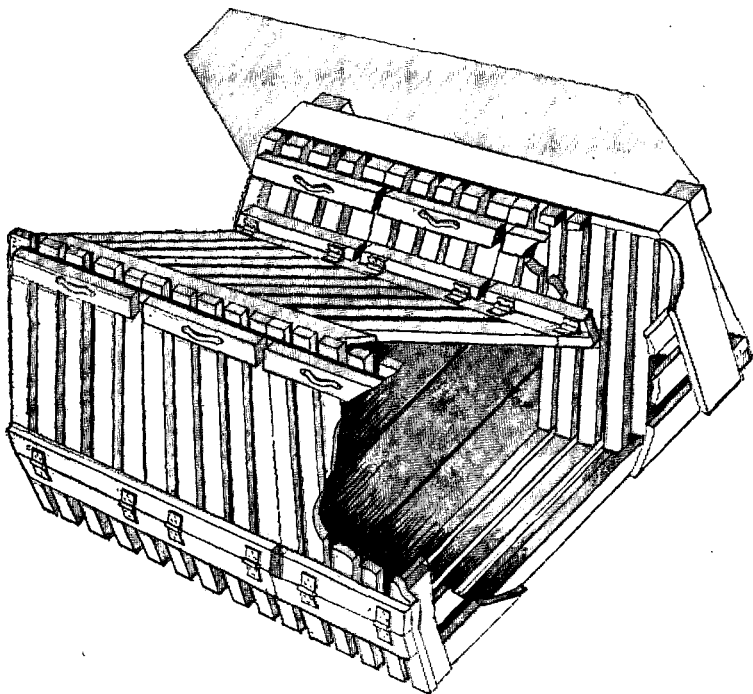

Figure 34. Vegetable bin.

the development of mold. Screened bread cabinets should not be placed close to the floor or ground where dust and dirt can be swept or kicked into them.

94. MEAT AND POULTRY. All meat should be stored in a mechanical refrigerator or ice box. If its condition is good at the time of storage, it will not start to decompose for several days. In general, meat should not be stored for more than 72 hours. It is extremely important that refrigerated meat be hung so that air can circulate freely around it. Except for frozen boneless beef or poultry received in their original containers, all coverings and wrappings should

be removed to hasten the chilling process.

95. FISH AND SEA FOODS. Fresh, sound fish and other sea food can be kept for several days if held at temperatures below freezing. Variation in temperature, however, should be avoided and if the food becomes defrosted, it should be consumed at once.

96. MILK. As soon as milk is received, it should be stored in a clean refrigerated space at a temperature of 50° F. or lower. In the field, ice boxes and underground cooling boxes may not give the desired temperatures. In these cases, it should be remembered that bacteria multiply very rapidly without proper refrigeration. Bottled milk should not be submerged completely in water because contaminated water may seep in through the cap. Milk containers should be made as nearly airtight as possible because storage near other food with absorption of their odor may cause a disagreeable taste.

97. BUTTER. Like milk, butter will absorb the odors and tastes of other foods. Thus, fish, cheese and some vegetables, such as fresh onions, must be kept away from the butter storage space. Butter should be stored at the lowest possible temperature and always in a covered container.

98. VEGETABLES. Leafy green vegetables should be stored in a refrigerator or other cool place. Other vegetables like potatoes, carrots, and dry onions should be kept in slatted bins to allow air circulation, (See fig. 34.)

SECTION IV.

PREPARATION AND SERVING OF FOOD

99. GENERAL. In preparing food, it is highly desirable to make it attractive, but special care must be given also to sanitation to both remove and prevent

contamination. Spoons and forks should always be used for serving food in order to prevent direct contact with the hands. There are two general ways of serving food in messes: line or cafeteria service, and table service. In the field it is usually necessary to use line service because no other facilities exist. However, table service has a more favorable effect on morale and should be used wherever possible.

100. RAW VEGETABLES AND FRUIT. a. All vegetables and fruit which are to be eaten raw or unpeeled must be thoroughly washed in potable running water before serving. This applies especially to leafy vegetables like lettuce, celery, and cabbage, and to other greens such as carrots, radishes, and fresh onions, all of which may have become contaminated with disease organisms in the soil. It is important also for fruit, since fruit may be handled by many persons before it reaches the table. Vegetables and fruit should not be cut up long in advance of the meal, as this reduces the vitamin content and also increases the chance for contamination.

b. In some parts of the world, vegetables and fruit are fertilized with human feces or handled by natives with intestinal disease. If necessary to use such local produce, it must be washed and either thoroughly cooked or disinfected before serving. Fresh vegetables or fruit may be disinfected by immersing for 1 minute (60 seconds) in actively boiling water. Placing the vegetables or fruit in net bags will afford convenience in handling and ready access and drainage of the water. Suspending the filled bags from sticks will safeguard personnel from the splash of hot water. All vegetables and fruit which are to be disinfected by this method will be unrefrigerated for at least 24 hours prior to the treatment. The volume of material treated will not exceed the volume of the boiling water in which they are immersed; for example, 15 inches of water will not be raised beyond a 30-inch mark after immersion of the vegetables or fruit.

c. Leafy vegetables which are treated in the above manner will show only slight wilting of the outermost leaves. The palatability of other vegetables such as carrots, and the larger fruits will not be affected.

d. Another method for disinfecting vegetables and fruit is by using the quartermaster issue *Compound Germicidal Rinse*. Mix 1 unit with every 8 gallons of water, and place vegetables and fruit in the solution to soak for 30 minutes. A fresh solution should be prepared for each new batch to be treated. This solution contains approximately 75 ppm. available chlorine and is three times the strength used for rinsing dishes. Solutions should be about 75° F. The damaged outer leaves should be removed but the vegetable should not be broken apart or cut up, nor fruit peeled before soaking, because further contamination will result. After soaking, vegetables and fruit are rinsed in potable water to remove the solution and are then ready for any further preparation necessary in serving raw. Guard against recontamination by handling as little as practicable and only after carefully cleaning hands.

101. SALADS, HASH AND CHOPPED MEATS.

Salads, hash and chopped meats furnish an excellent place for germs to grow. This is especially true of salads containing mayonnaise or other dressing. The preparation of these foods requires considerable handling and greatly increases the chances for contamination. Handling with hands should be held to an absolute minimum, making certain the hands are spotlessly clean. Such food should be prepared immediately before serving and not allowed to stand at room temperature for a long time. Left-overs should be placed back in refrigerator immediately and served within 24 hours; otherwise placed in garbage. Mess sergeants must see that these instructions are carried out. Hash coming in cans as part of the soldier's field ration has been prepared under extreme care and sterilized after sealing the can. This hash may be eaten

without danger, but any left over should be thrown away and not kept to eat later.

102. MILK. a. Milk is an excellent food used widely throughout the Army, and if from an approved source and handled properly can be used with safety. Three main types of milk are bought by the Army: pasteurized milk, evaporated milk, and powdered milk. *Pasteurized milk* is raw milk which has been heated to 142° F. or more for 30 minutes, or to 160° F. for not less than 15 seconds in order to destroy germs. *Evaporated milk* is pasteurized milk with about half of the water removed and the milk sterilized after the can is sealed. *Powdered milk* is pasteurized milk with practically all water content removed by further heating, making it a dry powder.

b. When used for drinking, milk should be served in the original container. If pasteurized milk is not available, evaporated or powdered milk can be used. Evaporated milk should be diluted with an equal amount of potable cold water just before serving. For powdered milk, use 4½ ounces of powder to each quart of potable water. The quartermaster issues this item under the name of *Milk, dry, whole* and packaged in 4½-ounce and several other size containers. Sprinkle the powder on the surface of the water. Stir or shake vigorously until powder is dissolved and then it is ready to drink. Placing in a refrigerator for 30 minutes will improve the taste. It may be practicable in some cases to issue powdered milk to combat troops at the same time they receive their daily ration. Milk has been found to be a considerable morale factor. Two heaping mess kit spoons of the powder to two-thirds of a canteen cup of potable water is all that is necessary for an individual serving. Storage for long periods causes the powder to become rancid and for this reason is not included in all rations. It is placed in the B Ration under Expeditionary Force menu No. 1.

103. COOKED FOODS. The following suggestions in preparing cooked foods should be followed carefully:

a. *Thorough cooking and immediate serving is the best safeguard against the transmission of disease by food.* Food can be made free from disease germs by several minutes of boiling, especially when cut into small pieces so that the heat penetrates. Some organisms are able to produce a certain toxin which boiling will destroy; cooking for 5 to 15 minutes at 176° F. or for 30 minutes at 150° F. will also destroy it. If improperly cooked foods containing these toxins are consumed, severe food poisoning can result. This may be prevented by handling food carefully enough to prevent contamination, or cooking the food thoroughly before growth of such organisms can take place.

b. For baked or roasted foods, internal temperatures of 160° F. to 180° F. should be maintained for at least 1/2 hour. Large roasts will require several hours of cooking at 325° F. In general, beef roasts require 25 minutes per pound and pork roasts 30 minutes per pound. Thorough cooking is very important for all pork and pork products to destroy small parasitic worms called *trichinae* which may be buried in the meat. Undercooked pork can cause a serious infection known as trichinosis. An easy guide is that properly cooked pork is never pink.

c. Meat should be cooked at low temperatures. The slow oven (325° F. to 350° F.) preserves vitamin values and produces a juicy, flavorful roast. When juices and drippings are saved, they should be placed in the refrigerator and used by the end of the next day.

d. Left-over perishable food presents an important problem since such food is a frequent cause of diarrhea. Care should be taken to have very little left-over food. That which is left over should be promptly and properly refrigerated and used preferably within 24 hours. Extraordinary precautions are necessary in using left-over hash or chopped meat, sausage, fresh pork, meat broth, or soups; none should be served until thoroughly reheated.

e. Dressing for fowl should be prepared just before the fowl is to be cooked and not allowed to stand around at room temperature. Handling with the hands should be reduced to a minimum, and hands should be scrupulously clean. Mess sergeants must pay particular attention that these precautions are carried out to avoid diarrheal outbreaks.

SECTION V.

CLEANING OF COOKING, SERVING, AND EATING UTENSILS

104. **GENERAL.** a. The method outlined in paragraph 105 is for use in all installations where mess equipment is collected and stored in a location protected from contamination between meals. Under these conditions, all eating and serving utensils are thoroughly washed, rinsed, and disinfected immediately following each meal. These utensils must be air-dried—never wiped with dish towels. Care must be taken to keep solutions at required temperatures. Cooking utensils are scraped and then washed separately from eating utensils in fresh hot soapy water. They must be washed free of all remaining food particles and then rinsed with scalding hot water. Mess equipment should be protected from all contamination, such as dust and insects, between meals. Care should be taken to avoid touching the food surface of mess equipment with the hands.

b. The method outlined in paragraph 106 is for use in installations under field conditions where the troops retain their mess gear between meals during which interval it may be assumed that fly and other contamination will occur. Under these conditions, the mess gear must be immersed in boiling water *before* each meal as well as after.

105. **COLLECTED WASHING.** When all eating and serving utensils of a company, detachment, or other

unit are collected, washed, and stored under flyproof conditions, the cleaning operations described below are used.

a. By dishwashing machines. (1) *Wash* for 40 seconds or more in approved detergent (dishwashing compound) solution kept at 140° F.

(2) *Rinse* and *disinfect* for 20 seconds with hot clear water kept at 180° F.

(3) *Air-dry*.

b. By hand. (1) *Wash* clean in hot soapy water or other approved detergent solution kept as hot as hands can withstand.

(2) *Rinse* and *disinfect* by spraying all surfaces for 30 seconds with hot clear water kept at 180° F.; or *rinse* briefly with hot clear water (120° to 140° F.) and *disinfect* by immersing for 20 seconds in clear boiling water, or for 30 seconds in hot clear water kept at 180° F.

(3) *Air-dry*.

106. INDIVIDUAL WASHING. When necessary, soldiers in the field must wash and retain their own mess kits. Just before each meal the mess kits are disinfected as described in a below. After the meal, remaining food is scraped off as completely as possible into a garbage can or pit, using the spoon. The washing, rinsing, and disinfection after use is done in a series of three containers (usually GI cans) by the method described in b below:

a. Disinfection before use. Before each meal, the mess gear with the exception of the canteen will be disinfected by immersing for not less than 3 seconds in clear boiling water. All of this equipment including cutlery may be assembled by hanging it on the meat can. Wire hooks or other suitable holders may be improvised to avoid too close contact with the steam.

b. Washing, rinsing and disinfection after use. (1) *Wash* thoroughly in first container, filled with *hot soapy water* (120° F. to 140° F.) or other approved

detergent solution. A long-handled brush is used for washing.

(2) *Rinse* by dipping several times in second container, filled with *clear boiling water*.

(3) *Disinfect* by immersing for not less than 3 seconds in the third container filled with clear boiling water.

(4) *Air-dry* after shaking off excess water.

Note. Unless the boiling water containers are kept practically full, men will shy away from the live steam and the mess kits will not be thoroughly disinfected.

107. HEATING WATER. a. The best method for heating water in the field is by using standard quarter-master heating units. Figure 35 demonstrates the use of the water heater with the field range M-1937.

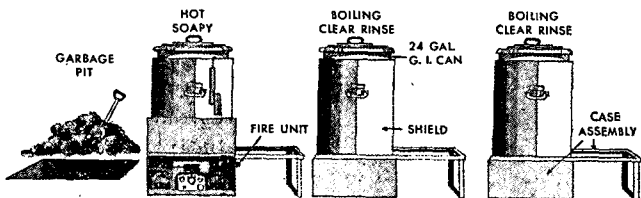

Figure 35. Mess kit, washing, using heater, water, range, field, M-1937.

b. This method has been modified and simplified so that it is possible to use one heating unit to do the work of three. There are no burners to clean, there is no maintenance problem, and red gasoline can be used as well as white gasoline. The water in the cans may be used as well as white gasoline. Two gallons of gasoline are sufficient to heat all the water required for mess kit washing for one meal. This represents a saving of 4 gallons of gasoline per meal.

c. The modification referred to consists of using a U-shaped pipe arrangement set up as shown in figure 36. The M-1937 heating unit is connected to the upper

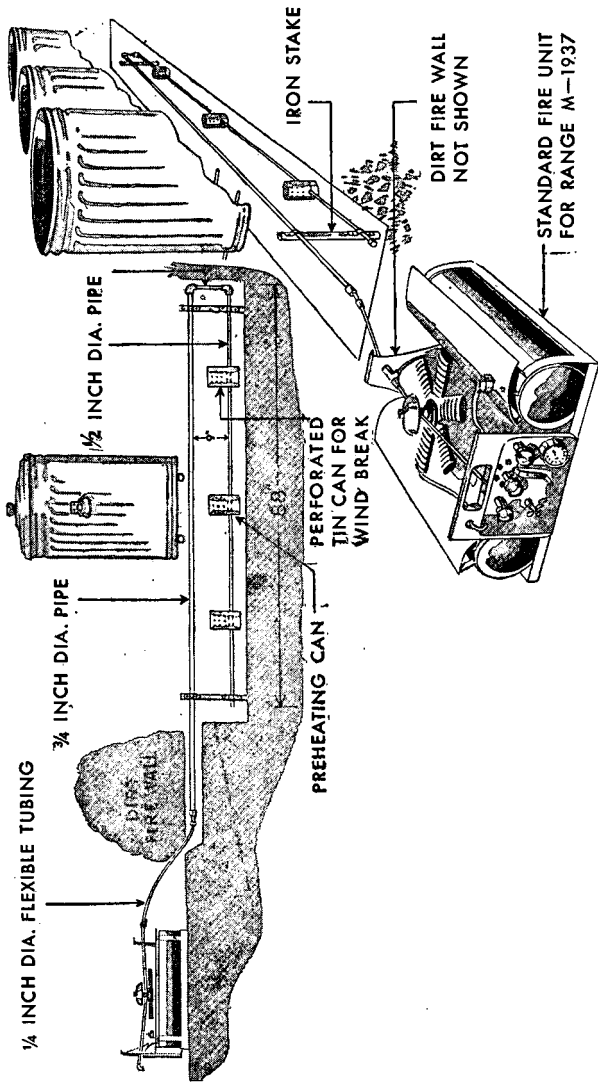

Figure 36. Improved gasoline burner for washing mess kits.

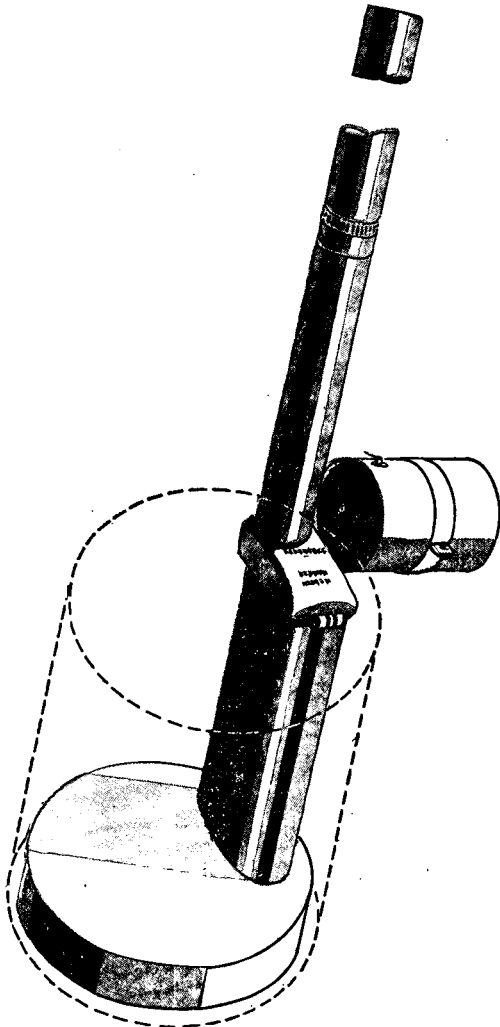

Figure 37. Immersion type heater for corrugated cans.

pipe by using suitable fittings. At intervals of about 24 inches (sufficient to permit cans to be set up over them) three very small holes are drilled in the lower pipe. These holes should be about the size of a bristle in a wire brush. It is important to provide perforated shields around the holes as shown. These are readily made from No. 2 tin cans.

d. In operation, the gas tank in the heating unit should be filled approximately three-quarters full and the air pressure in the pressure tank pumped to 70 pounds per square inch. The portions of the lower pipe inside the shields and around the small holes should be preheated by igniting about a cupful of gasoline underneath them. This will also serve to preheat the upper pipe. Then the control valve on the gas tank is opened about one-quarter turn and ignition will occur. In from 2 to 3 minutes a steady blue flame will result. The burner control and air valves on the M-1937 unit remains closed.

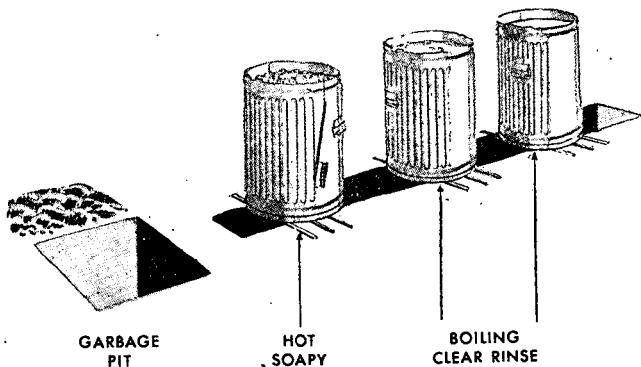

Figure 38. Fire trench and cans for washing mess kits.

e. Another standard quartermaster water heater is the very effective immersion heater.

f. When these devices are not available, water for mess kit washing may be heated by digging a fire trench 8 feet long, 1 foot wide, and 1 foot deep. A fire

is built in this trench and over it are placed three galvanized iron cans or other suitable containers, preferably supported by strips of metal. These cans should not be in contact with each other for, while this may be economical of fuel, it leads to crowding of men when in use and consequent inadequate mess kit washing. The water in the first can should be kept hot but not so hot that the men are unable to immerse their hands in it while washing their mess kits. The water in the second and third cans should be kept actively boiling.

CHAPTER 6

FLY CONTROL

SECTION I. GENERAL

108. INTRODUCTION. Intestinal and other diseases are most often spread by flies, and the common housefly is by far the most dangerous offender. To the fly, manure, feces, and food are all equally appetizing. Flies transmit disease germs in three different ways: by vomiting, by excretion, and by actual body contact. Thus when flies go directly from a pile of human waste to the food we eat, they have a triple chance of transferring the tiny germs of infection. The only practical ways to keep flies from spreading disease are to kill them, to prevent them from breeding, and to keep them away from food and eating utensils.

SECTION II. DEVELOPMENT AND CHARACTERISTICS OF FLIES

109. DEVELOPMENT. There are four stages in the life cycle of the common housefly (*Musca Domestica*). (See fig. 39.)

a. Eggs. The eggs of the housefly are white, glistening ovals about the size of the period at the end of this sentence and they are deposited in clusters of about 150 in manure or decayed vegetables. A fly can lay as many as 2,000 eggs in her lifetime. The length of the egg stage varies from 8 to 24 hours under favorable conditions.

b. Larva. Newly hatched larvae (maggots) are about twice the length of the egg. They move about, feed on organic matter, grow rapidly, and reach the

pupal stage in 4 to 5 days under average conditions. Cold, or lack of food and moisture, will prolong the larval stage. (See fig. 39.)

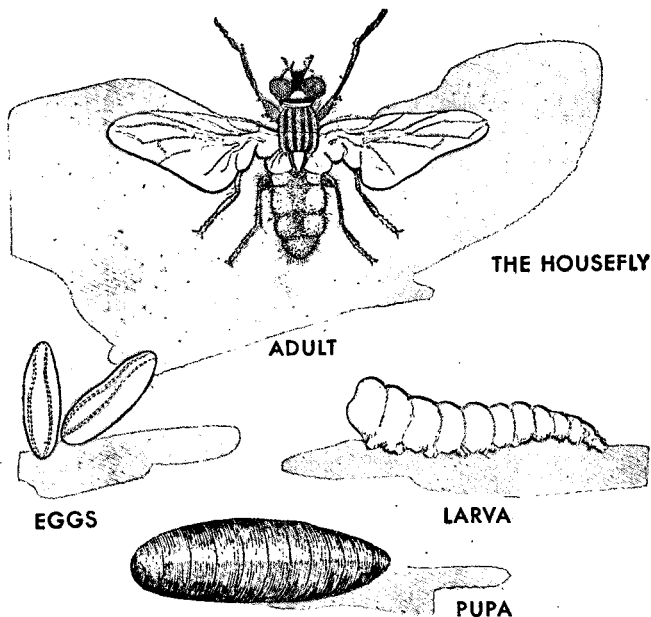

Figure 39. Stages in development of housefly.

c. Pupa. The pupae are of dark color and about $\frac{1}{4}$ inch long. Unlike maggots, pupae do not feed or move about. They usually remain in this stage 5 to 10 days.

d. Adult. The fly emerges from the pupal stage as a full grown adult and crawls upward through the loose soil, manure, or other material to the surface. As its wings dry and harden, the fly becomes a full-fledged disease carrier. The female starts to lay eggs 5 to 20 days after leaving the pupal stage.

110. CONTROL. Certain characteristics of flies give us clues on how to control them. These are:

a. Houseflies prefer animal manure as a breeding place, but also breed in human waste and decaying vegetable or organic matter.

b. Warmth, moisture, and suitable food are required for growing maggots (larvae).

c. The most favorable temperature for breeding is 80° to 95° F.

d. Temperatures of 115° F. or above will kill both egg and larvae.

e. Maggots travel from the feeding material to a cooler, drier area before going into the pupal stage.

f. Both larvae and the newly emerged adults crawl through loose earth and manure toward light.

g. Adult flies are attracted by odors.

h. Flies tend to rest on vertical surfaces and hanging objects.

i. The range of flight is usually 200 to 1000 yards but may extend to 13 or 14 miles.

j. Their number is greatest in late summer and early fall.

k. In warm climates and in heated buildings, breeding may take place throughout the year.

SECTION III. CONTROL MEASURES

111. GENERAL. Control of flies depends on knowing their habits, ruining their breeding places, destroying their larvae, and killing adults. Prevention of breeding is the most effective part of a fly control program. Continuing attention is a "must" if the fly control program is to succeed.

112. CONTROL OF BREEDING PLACES. To control breeding places, all human waste, animal manure, and garbage must be covered, disposed of or treated promptly and effectively. Flyproofing, screening, trapping, and killing can be used in some cases to prevent many flies from reaching breeding places. The use of

DDT to kill both flies and fly larvae has made fly control much easier. (See ch. XIV.)

113. FLY TRAPS. a. General. Fly traps alone must not be depended upon to control flies, but should always be used in any fly-control program. There are many types but all have two main parts in common—the bait chamber and the trap chamber. The *bait chamber* is the lower and darker part into which flies are attracted by the odor of the bait. The *trap chamber* is the upper and lighter part into which flies crawl after feeding on the bait. Sides and top should contain as little solid material as possible since shade in the trap section will decrease the catch from 50 to 75 per-

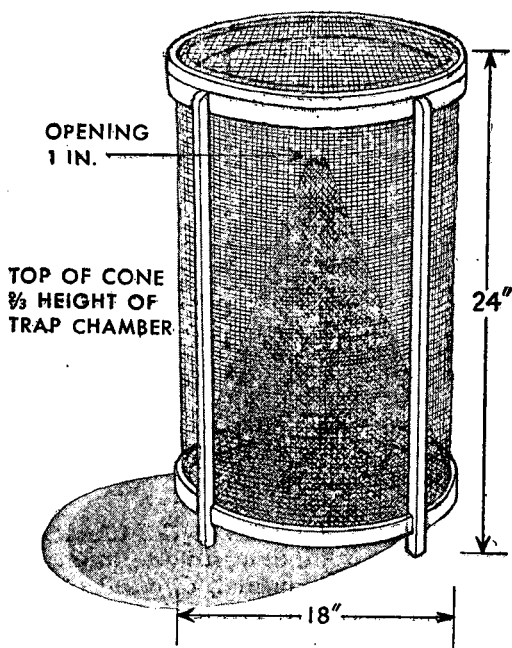
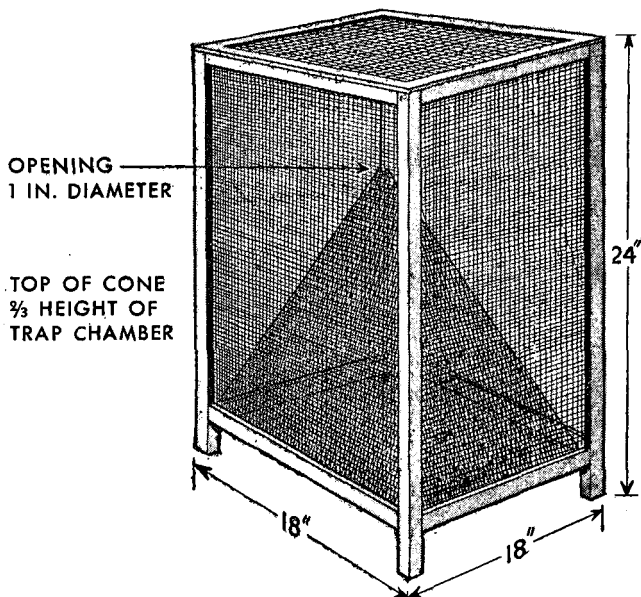

Figure 40. Conical hoop fly trap.

cent. Some types of traps are inefficient because they are too small and let too little light into the trap chamber. One large trap, carefully tended, is as efficient as several smaller traps. An excellent type is the conical hoop trap issued by the Corps of Engineers (see fig. 40). If this is not available, the following two types can be easily made in the field:

(1) *Square traps*, as shown in figure 41, are made 12 to 18 inches square and 18 to 24 inches high. The corner uprights and connecting lateral strips are made of boards 1 inch thick and $1\frac{1}{2}$ inches wide. The frame-



work is covered with No. 14 or finer mesh wire screening tacked to the corners and connecting strips. The lid is a removable screen frame which fits down tightly over the top. The bait chamber inside is made of

screening tacked to the edges of the lower side strips and ending in a point two-thirds the height of the trap. At the point is a 1- to 1½-inch hole through which flies enter the upper chamber. The corner uprights extend 1 inch below the lower edge of the trap to provide legs.

(2) *Triangular traps*, as shown in figure 42, are less effective than the square trap, but are of such simple design that they can be built easily and quickly. The traps should not be less than 12 inches high and 18 inches long. (If less than 18 inches in length, the solid ends will exclude too much light.) The bait chamber is in the shape of a pyramid two-thirds the height of the trap chamber with an opening at the top. An opening is made also in one end of the trap chamber for removing dead flies; it is covered with some nonwarp-

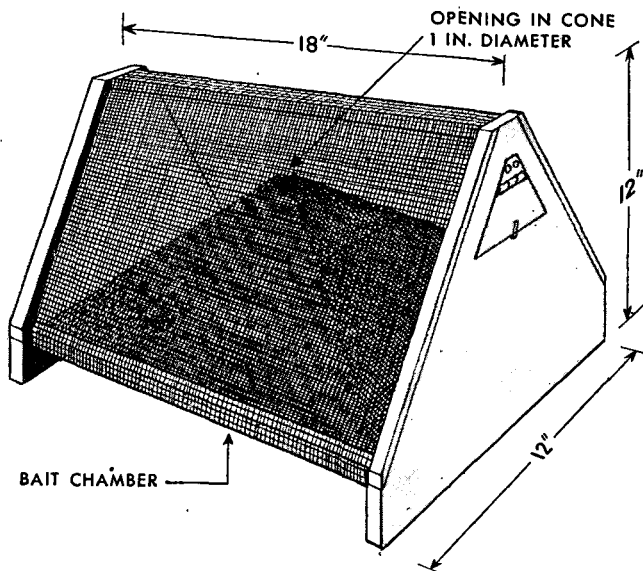

Figure 42. *Triangular fly trap.* (Apex of cone is three-quarters the height of trap.)

ing material, such as tin, so that the opening will shut completely.

b. Location of fly traps. Traps should be located on smooth areas near manure piles, latrines, kitchens, mess halls, garbage stands, dumps, and any other places where flies congregate. Traps must be protected from the wind. This can be done with a windshield attached to the fly trap stand; or buildings, boxes, and garbage cans serve as windbreaks. If placed on a stand, the trap should be set far enough away to admit necessary light. Generally, flies congregate in the warmth of the sun in cool weather, and in the shade during hot weather. The catch may be increased by changing the location of traps at intervals during the day.

c. Care of fly traps. Liquid fly bait should be placed in wide shallow containers with at least 2 inches between the edges of the bait pan and the edges of the trap. Baits should be inspected daily. They should be cleaned and refilled whenever a scum or sediment forms, or when bait gets dry or dirty. Traps should be emptied whenever there are enough flies to interfere with light in the trap chamber. Captured flies can be killed by soaking the trap in hot soapy water. Painting the screening on the trap with DDT residual spray before placing in use may make this unnecessary. Fly traps need constant attention if they are to be used effectively.

114. FLY BAIT. Bait must have an odor attractive to flies, yet not too offensive to people. For houseflies, fermented baits are generally very satisfactory. A good fermented bait is stale beer. Another is a mixture of—

Corn meal.....	1 pound	Water	1 quart
Molasses	1/2 pint	Yeast.....	1/4 ounce

Mix the water and molasses, and boil. Stir in corn meal and allow to cool. Then add yeast and allow to stand in a warm place until fermenting. Other fermented baits are two parts molasses and one part vinegar; crushed overripe bananas in milk; and sour milk. Some

kinds of flies are attracted to putrefying meats like fish heads but these can be used only where the odor is not objectionable.

115. OTHER FLY KILLING METHODS (Also see ch. XIV). a. **Residual sprays.** DDT residual spray applied to surfaces upon which flies' rest is very effective in killing them. This spray should be used extensively and will give long-term control. (See ch. XIV.)

b. **Ordinary fly sprays.** Fly sprays of the "flit-gun" type are useful in mess halls, especially when directed at flies on the wall. The standard "Insecticide liquid, finished spray" supplied by the Quartermaster which now contains DDT will kill most of the flies hit by the spray. Once flies are knocked down they should be swept up and burned.

c. **Poisons.** Poisons are effective and easy to use.

(1) Two of the best poisons are—

(a) Formaldehyde poison composed of commercial formalin, 3 teaspoonfuls; milk and sweetened water (equal parts), 1 pint.

(b) Sodium salicylate poison composed of 1 percent solution of the drug with a small amount of brown sugar added.

(2) Poison baits using DDT should also be tried.

(3) A good method of using poison is to fill a drinking glass two-thirds full of the solution, placing over the top a piece of blotting paper 2 inches wider around than the tumbler. Cover with an inverted saucer and turn the whole thing upside down. By inserting a match under the edge of the glass, enough liquid will seep out to keep the blotting paper moist.

d. **Flypaper.** Ribbons of flypaper supplied by Quartermaster Corps are useful when hung from the ceiling of mess halls or kitchens. However, they should not be hung directly over mess tables or stoves.

e. **Impregnated cloth strips.** Cloth strips similar to the flypaper ribbons can be soaked in DDT residual spray and hung from ceilings. These, too, should not be hung over mess tables or stoves since flies may drop

off into food. It is not necessary for these strips to be moist to be effective.

f. Swatting. Swatting is an effective method of destroying a limited number of flies which have entered a screened building. If shades are closed on most of the windows, flies will congregate near the light of the unshaded windows where they can be more effectively swatted or sprayed.

CHAPTER 7

MOSQUITO CONTROL

SECTION I.

CHARACTERISTICS OF MOSQUITOES

116. GENERAL. Mosquitoes transmit malaria, dengue, yellow fever, and filariasis. Of these diseases, malaria is the worst handicap to military operations. Different kinds of mosquitoes transmit different diseases, therefore before an effective antimosquito campaign can be started in a region, the habits and characteristics of the local mosquitoes should be known.

117. DEVELOPMENT. Mosquitoes go through four stages of growth: egg, larva, pupa, and adult. It takes the egg about 3 days to develop, the larva about 10 days, and the pupa about 3 days. (The number of days depends upon the temperature.) The first three stages are passed in water where the larvae, or wrigglers, are easily detected. In the adult or flying stage certain mosquitoes, including the malaria-spreading *Anopheles*, can fly at least a mile. Male mosquitoes are harmless vegetarians, but the females are blood-suckers and disease spreaders.

118. HABITS AND CHARACTERISTICS. a. Breeding places. Mosquitoes will breed in practically any collection of water which stands longer than 10 days. Different kinds of mosquitoes vary in their choice of breeding places. Those breeding in and around dwelling places are called domestic. Some like sunlit places, others prefer the shade. Some breed in fresh water,

others in water containing organic matter. Most types prefer ponds, swamps, slow-moving streams, drains, water receptacles, tree holes, and roof gutters. However, stagnant water in bomb craters, road puddles, borrow pits, and other man-made holes are popular breeding places.

b. Group characteristics. The three groups of mosquitoes which transmit disease are *Anopheles*, *Aedes*, and *Culex*. Each group contains many species. The general characteristics of the three main groups are given below:

(1) *Anopheles* (malaria carrier). Bites mainly at dusk, night, and dawn. Breeds chiefly in water away from dwellings in ponds, streams, swamps, and man-made collections of water. Adult lives 1 to 3 months.

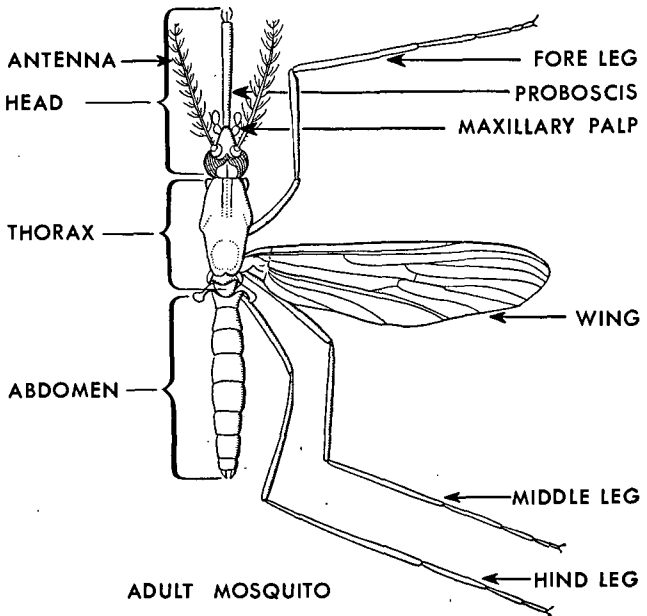
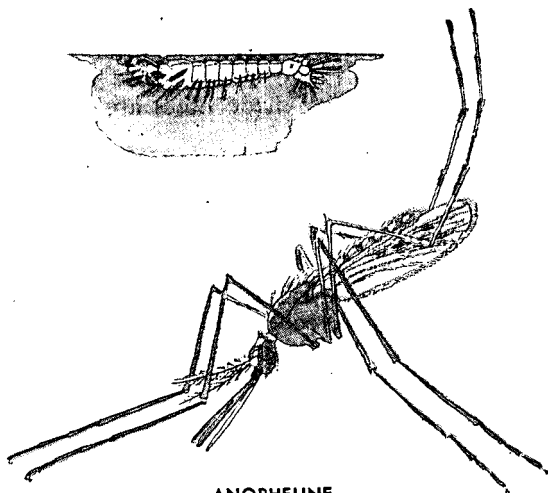
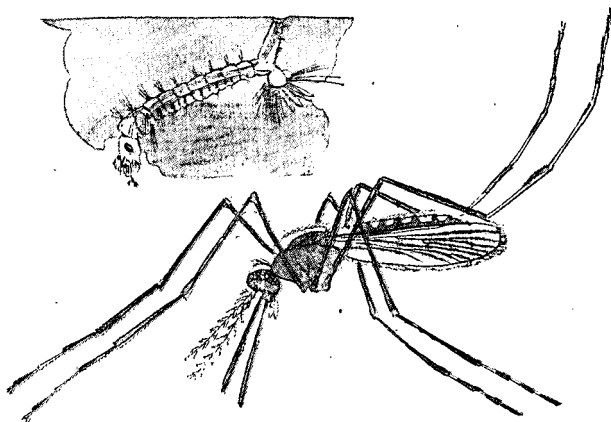

Figure 43. Adult mosquito.



ANOPHELINE



OTHER MOSQUITOES

Figure 44. Resting positions of Anopheles and Aedes larva and adult.

Larvae lie parallel to surface and feed on the surface of water. Adults have spotted wings and usually rest and feed with the body at an angle of 45°.

(2) *Aedes*. Transmits dengue, yellow fever, and filariasis. Bites at almost any time, especially inside shelters. Breeds chiefly in water in and around dwellings in rain barrels, buckets, gutters, Lyster bags, discarded oil drums, etc. Eggs are slender and laid singly on water. Larvae hang at an angle in the water, feed below the surface, and breathe at the surface. Adults have wings clear of spots, and silver-striped bodies. They rest and feed with the body parallel to the surface.

(3) *Culex*. Transmits filariasis. Bites at dusk, night, and dawn. Breeds chiefly in and about dwellings, but also in stagnant water in swamps and cesspools. Eggs are cemented in groups on surface of water. Larvae hang at an angle in the water but have longer breathing tubes than *Aedes*. Adults have same horizontal resting and feeding position as *Aedes*. Their bodies are not striped.

SECTION II. CONTROL MEASURES

119. CONTROL. a. Responsibility. Commanding officers are responsible for carrying out mosquito-control measures. (See AR 40-205 and 40-210.) They are advised by Medical Department officers who conduct surveys and recommend kinds of control for each particular situation. The actual labor is performed by units of the special medical malaria control organizations, by engineer troops, native labor, or labor details from regular units—all supervised by medical personnel. Each company, battery, squadron, or similar unit, must have an antimosquito detail of at least one noncommissioned officer and two enlisted men. The men are picked by the unit commander and trained in the use and repair of screening and bed nets; hand-killing and spray-killing of adult mosquitoes; individual protective measures; identifying mosquito

breeding areas; and ditching, draining, and oiling. These groups carry out the control measures around their own unit areas.

b. Camp site. The ideal location for a camp is on high dry ground, at least a mile away from important breeding places of mosquitoes and from native villages, where the infection rate is usually high. Infected natives should not be allowed within a mile of camp after dark.

c. Methods of control. Control measures can be divided into those directed against larvae and those against adult mosquitoes.

120. OILING. Oil spread over bodies of water produces a film which kills mosquito larvae. Diesel oil No. 2, or fuel oil FS2 are best. Waste motor oil and crude oil diluted with kerosene (in ratio of one part oil, five parts kerosene to three parts oil, one part kerosene) can be used but are not very good substitutes. It is better to use them with DDT (see ch. 14). Oiling should be repeated about once a week and the way it is applied is extremely important. The amount of oil necessary varies with conditions of vegetation, weather, and kind of water. However, it is generally 10 to 14 gallons per acre of water. The best appliance is the knapsack sprayer, consisting of an oil container, hand pump, and spray nozzle, which is carried and operated by one man. (The best type of nozzle is the disk type with a hole in the center.) The ordinary knapsack sprayer carries 5 gallons and has a spray range of about 25 feet. It is most practical and economical to use on ditches, small ponds, and other water collections that can be reached by spray. Larger sprayers, power operated, and mounted on a vehicle may be used to oil extensive areas like borders of large lakes or large swamps. Other ways of applying oil can be improvised to good advantage. For small collections of water, use an oil-soaked broom or mop, oil "squirt" cans, or ordinary watering pots.

121. PARIS GREEN LARVICIDE. a. Usually 1 pound of paris green is required per acre when used as a dust. Commercial paris green can be diluted with a dust like hydrated lime, road dust, ashes, powdered limestone, talc, or condemned flour (concentrations used are from 1 part paris green and 99 parts dust, to 5 parts paris green and 95 parts dust by weight). Mix the ingredients thoroughly in a keg or drum, then spread it on the water surface with a suitable duster or by hand. For airplane dusting, concentrations of 25 percent paris green or more are used.

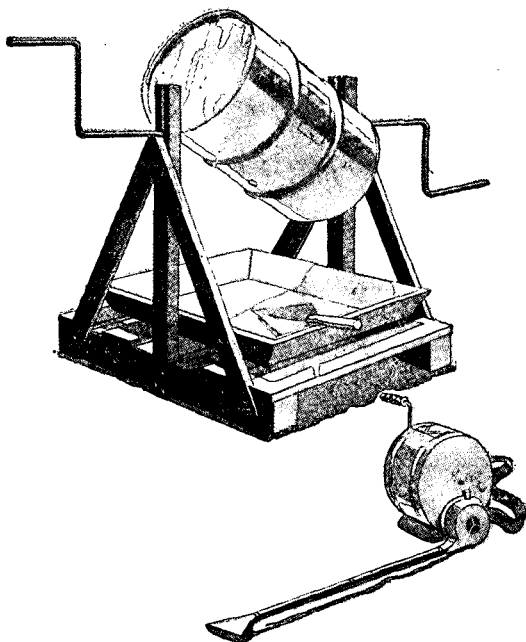

Figure 45. Mixing paris green larvicide.

b. Paris green can also be applied by a wet method: mixed with kerosene and water and sprayed on the

water surface like oil. An effective mixture consists of $\frac{1}{2}$ gallon kerosene, $2\frac{1}{2}$ pounds paris green, 1 ounce castor oil, whites of from 4 to 6 eggs (or 1 teaspoonful dried egg albumen). The man assigned to spraying carries as many as twenty-five 1-ounce vials of this stock mixture in his cartridge belt along with a 1-quart tin measuring can, a tin funnel, and a wire gauze sieve. When ready to apply the larvicide, he pours 2 quarts of water into his sprayer, using the funnel and sieve to remove the debris. Then he vigorously shakes one vial of the stock mixture and adds it to the water. He washes out the vial and empties the rinsings into the sprayer, adding more water until he has 4 quarts. (Swinging from the hips will keep the final mixture in the tank of the sprayer shaken up while the spraying is going on.) A 1-ounce vial of the stock mixture will be enough to spray 500 square feet of water surface (equals about $2\frac{1}{2}$ pounds paris green per acre).

122. DDT LARVICIDE. A new and highly effective substance for mosquito control is DDT, which may be used in an oily spray, or as an emulsion or dust for killing larvae. It is simple to apply and therefore saves labor and equipment. (See ch. 14.)

123. DITCHING AND DRAINAGE. a. Antimosquito drainage can be accomplished by surface ditches (either unlined, lined, or rockfilled) or subsurface drains. No matter what type is chosen, careful planning will increase its effectiveness. Grade lines should be established for at least the main ditches or drains. Sometimes the drainage system can be set up so that all the water will collect in one area and then larvae can be killed more easily. Open ditches should be built so that standing water is carried off and storm water drained from the ground and the ditches within 5 days after a storm. Ditches should be wide and steep enough to carry all the water away, but not forceful enough to wear potholes in unlined ditches. If a ditch is too wide and flat, water may remain in small depressions.



Figure 46. Applying paris green larvicide.

No more ditches than are necessary to accomplish the job should be built. Don't create breeding sites while trying to fill or drain old ones.

b. Ditches should have narrow bottoms, smooth sloping sides (slope depends on kind of soil), as few curves as possible, and no sharp turns. The bottoms should be U-shaped, not V-shaped. However, in large ditches, a small V-shaped ditch may be dug along the center line to drain seepage water. Ditches built on hillsides should have upper sides flatter than lower sides to prevent erosion. In general, dig the main ditch first and add lateral branches only where necessary. Side ditches should join the main one at an acute angle or gentle curve to prevent deposit of debris or erosion of the opposite bank. Take care that dirt removed does not obstruct proper drainage. Line the downstream outlet of a pipe or culvert with stone or concrete to prevent erosion. Concrete or stones set in cement mortar make a permanent and ideal lining for ditches. If there is a chance that water will accumulate or flow behind the lining, make seepage holes in the lining.

c. Subsurface drainage is used where permanent measures are warranted. Ditches should be made with rockfill or with tile varying in size from 3 to 12 inches. Average depth below the surface is 2 to 4 feet. Use logs, waste piping, or any other means to maintain channels of flow under the surface.

d. Stream training is an effective but laborious means of mosquito control. It involves straightening stream edges and removing potholes and all grass or underbrush within 5 feet of the stream edge. When there is enough time, labor, and materials, masonry or concrete walls may be built to retain the stream.

e. Eliminate all containers like discarded tin cans, oil drums, pails, barrels, and coconut shells which allow water to gather. When it is impossible to get rid of them completely, treat these breeding sites with a larvicide at least once a week. Otherwise, disease-carrying mosquitoes like the *Aedes* will multiply. The responsibility for cleaning up such nuisances should be clearly assigned and there should be frequent check-ups to see it is not neglected.

f. At permanent installations, it is usually advisable to fill nearby depressions and low areas which may become breeding sites. Man-made breeding sites like ruts, bomb craters, and fox holes can be filled; and the area of water surfaces can be reduced so that it is easier to spray with larvicide. Filling is slow and expensive, but it is one certain and permanent way of controlling the mosquito menace. The bulldozer and disk harrow can be used for this operation. In getting material to use as filling, be careful not to create new depressions or water catchers for breeding sites.

124. PROTECTION FOR INDIVIDUALS. The best means of protection from mosquito bites include protective clothing, bed and head nets, repellents, and aerosol "bombs" accompanied by strict attention to malaria discipline. Since bites are often painless and leave no mark to show the presence of mosquitoes,

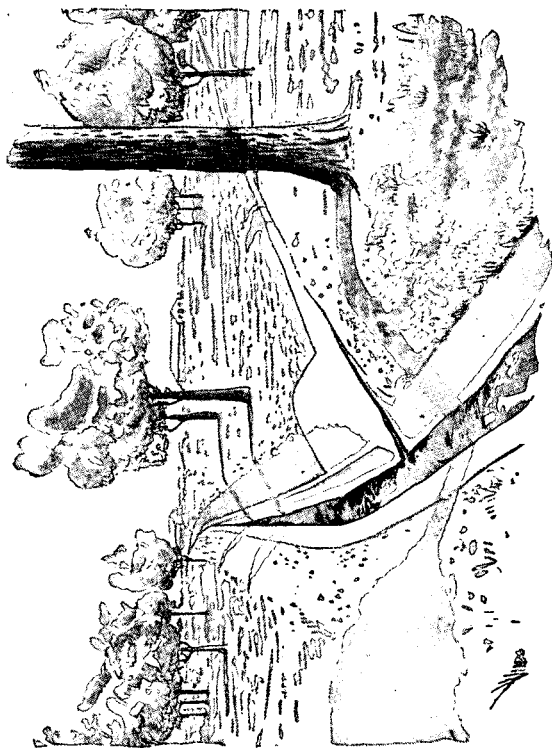

Figure 47. Ditching and drainage.

these measures should become an unfailling routine in malarious country.

a. Clothing. This includes leggings, impregnated anklets or boots, gloves, and rolled-down sleeves. The wearing of just shorts should be prohibited, especially at night or in the jungle. After dark, men should not be exposed outdoors without shirts. This type of control can be made effective only by strict discipline and frequent inspection.

b. Nets. Except when combat makes it impossible, men's faces and necks should be fully protected by head nets when they are exposed after sundown. Bed nets or "mosquito bars" protect men during sleep. The malaria-carrying mosquito usually bites at night,

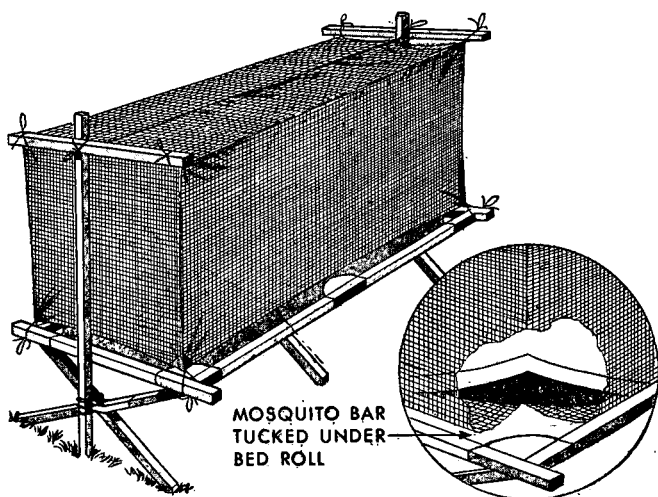

Figure 48. Mosquito bar on folding canvas cot.

therefore the nets must be arranged so that mosquitoes can't bite men through the screened net. Before getting under a net at night, men should hunt for any stray mosquitoes inside the netting and kill them.

Cots and beds should be provided with overhead frames which have no sharp points to tear the netting. (See fig. 48.) Repair holes in the net promptly with needle and thread, adhesive tape, or string tied around the pinched-up torn part. Nets in small tents should conform to the shape of the interior. Hang shelter tent nets inside, not outside. Nets should always be carried as personal equipment by all troops entering a malarious area, even in forward combat areas. Their importance cannot be overemphasized. There are places in the Tropics where 20 percent of the troops have caught malaria because of a single night's exposure without nets.

c. Repellents. These substances are smeared on the skin and clothing to keep mosquitoes from biting. Standard quartermaster insect repellent furnishes protection for 2 to 4 hours after application to the skin. It should be applied freely especially where other protective measures are not practicable. Sprinkle about 12 drops in the palm of the hand and rub on skin, avoiding mouth, eyes, or forehead. Also apply to close-fitting parts of clothing. Since some repellents dissolve plastics, don't touch watch crystals or fountain pens. At gatherings such as open-air movies, repellents can be dispensed automatically using a soap dispenser or similar means. Clothing may be sprayed with repellent, using a spray gun or knapsack sprayer. Two or 3 ounces are enough for shirt and trousers or fatigues and will last for several days. In general, repellent applied to clothing lasts much longer than on skin, but both skin and clothing should be treated to give complete protection.

d. Insecticide sprays. Spraying is used not only in buildings but also in fox holes, dugouts and shelter tents. Dispensers are supplied to men in combat areas along with food, ammunition, and first-aid supplies. Shelter tents and dugouts are sprayed at dusk and other times when mosquitoes bite, not only to kill insects that have gotten in but also to keep others out. A few seconds spraying is enough for an ordinary

shelter. The aerosol insecticide dispenser is described in paragraph 125b.

125. GROUP PROTECTIVE MEASURES. Clearing away resting places of mosquitoes like grass, brush, and leafy vines and bushes; spraying with insecticide; and mosquitoproofing will all help keep adult mosquitoes from biting.

a. Spray killing. Hand sprayers can be used to kill mosquitoes that get indoors in the daytime. In malarious areas, the insecticide is sprayed in resting places of adult mosquitoes: latrines, storehouses, stables, barracks, tents, messes, and empty boxes. When possible, native villages within a mile of camp should be sprayed. Abandoned villages to be used or visited by troops should be sprayed twice a week before dawn or after sunset; otherwise they should be avoided altogether. Any military installation in a highly malarious area should get a daily spraying. When antitank gun emplacements, pillboxes, and sentry huts are occupied at night they need spraying every 3 hours, or at dusk and midnight.

b. Aerosol killing. Aerosol insecticide comes in a 1-pound dispenser or "mosquito bomb" which sprays about 150,000 cubic feet taking 12 to 14 minutes to exhaust. Four seconds of spraying per 1,000 cubic feet (for example, 10 feet long by 10 feet wide by 10 feet high) is usually enough for a military hut, but a little more time is required for the same space in a native hut. Spray the eaves of the hut before entering. Inside, carry the dispenser rapidly toward all corners while the aerosol escapes. Don't aim at mosquitoes because it wastes the spray. This insecticide is so effective, it should be used sparingly. Since it acts like a gas it stays in the air and is effective for 2 to 4 hours in still air.

c. DDT residual spray. The use of DDT as a residual spray for killing adult mosquitoes in living quarters and in their outdoor resting places is an important addition to present methods of mosquito



Figure 49. Aerosol insecticide dispenser.

control. (For details see Chapter 14.)

d. Mosquitoproofing. All buildings where men gather should have fine mesh screening (18 to 24 mesh per square inch) on the doors and windows. Doors should open outward and close automatically. They should be strongly built so as not to warp or sag and reinforced with cross strips of wood or metal, where pushed at hand and foot level. Strips of wood or metal should block any space where mosquitoes might enter between the frame and the door. In highly malarious country, entrances should have double screen doors at least 6 feet apart. All openings in screened buildings like cracks, knotholes, spaces in flooring or walls or corner joints should be plugged with pieces of tin cans, shingles, or a plastic made by boiling shredded paper and flour into a doughy mass and adding sand and cement. Repair tears in screening promptly. The Engineer Corps does major mosquitoproofing but occupants of each barracks are responsible for minor repair. Because this measure is so important to the health and comfort of all the men, it should be strictly supervised. It may be necessary to assign an enlisted man to make regular inspections, to repair whatever he can, and to report other needs for repair to the commanding officer.

126. MALARIA DISCIPLINE. Men should regard the malaria mosquito like any other enemy, and screens, protective clothing, bed nets, repellents, sprays, and suppressive drugs as weapons. The closer a man gets to combat, the more important it is that he knows how to use and take care of these weapons. Troops full of malaria cannot fight. Instruction given in training periods should be repeated when necessary and applied on field maneuvers. Commanders should enforce measures for malaria control strictly. A man in a fox hole in malarious territory can protect himself reasonably well if he knows how to avoid infection and appreciates the importance of what he himself can do.

CHAPTER 8

CONTROL OF LICE

SECTION I. GENERAL

127. MILITARY IMPORTANCE. Lice transmit typhus fever, trench fever, and relapsing fever. These diseases are particularly dangerous to the Army because lice can spread disease quickly when men are crowded together in close quarters with few chances to bathe or change clothes.

128. CLASSIFICATION OF LICE. The three kinds of lice that infest men are:

a. *Body louse*, also known as "cootie," or "seam squirrel" (*Pediculus humanus corporis*), is chiefly responsible for transmitting louse-borne diseases.

b. *Head louse* (*Pediculus humanus capitis*).

c. *Crab louse* (*Phthirus pubis*) (see fig. 50).

129. LIFE CYCLE. Lice have three stages of growth: egg (nit), nymph, and adult.

a. **Body louse.** (1) Eggs (nits) are attached to the fibers of clothing, especially along the seams, and occasionally on body hair. They are oval-shaped, have a lid on one end, and are very small. Eggs hatch into nymphs about 8 days at a temperature of 86° to 90° F.; but at a lower temperature may take a few weeks.

(2) Nymphs (larvae) are similar to the adults except that they are much smaller (pinhead size) and are colorless. Unless they obtain a meal of blood within 24 to 48 hours of hatching, nymphs die. This form lasts about 9 days, after which the louse is mature and is able to reproduce.

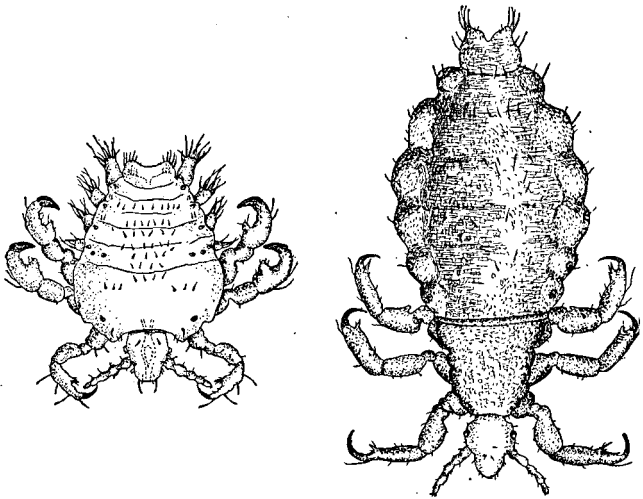

Figure 50. Crab louse (left); body louse. (right).

(3) Adult females begin to lay eggs 4 days after maturity, at the rate of 5 to 10 a day, and under favorable conditions continue for 30 days. The adult louse remains attached to the clothing except when feeding.

b. Head louse. This species, which is a close relative of the body louse, prefers hairy parts of the body, particularly the head, where it attaches its eggs to the hair.

c. Crab louse. This species, which has a short body with long legs ending in claws, infests the coarse hair around the groin, armpits, beard, eyebrows, and eyelashes. Females lay about 10 to 15 eggs which are attached to hairs and hatch in 7 to 10 days. The young become old enough to reproduce in 15 days.

130. CHARACTERISTICS OF LICE. **a.** Lice live on human blood as their food and die in a short time if unable to feed. In higher temperatures, lice require more food and die even more quickly if deprived of it.

b. Lice are spread by contact with infested persons or when adult lice or eggs drop off into straw, debris, blankets, clothing, or on latrine seats. Crab lice are frequently acquired during sexual intercourse.

c. Disease is hardly ever transmitted by the louse bite. The germs (*Rickettsiae*) of typhus fever are contained in the gut of the louse and are passed out when the louse defecates as it feeds. Louse bites itch, and when scratched, the germ-loaded feces are rubbed into the tiny skin abrasions. Scratching may also crush the louse and rub the germs it contains into the wound, as in the case of relapsing fever.

SECTION II. DELOUSING

131. LOUSE CONTROL. Lice are not easy to find and chances are they have become quite numerous before they are detected. When louse bites itch, the irritation may be blamed on some other cause. Men should be taught to look for lice and be able to identify them, reporting infestation immediately. Medical officers conducting physical inspections should have enlisted assistants examine the clothing of the men for the presence of lice. Whenever the skin of a man shows evidence of scratching or insect bites, examine his clothing closely for lice, particularly the seams where eggs and young lice are most likely to be found. When an infested individual is found, his roommates should be examined too. If during any inspection, 5 percent or more of a unit is found infested, the entire unit should be deloused at the same time without delay. In all areas where the natives are known to carry lice, soldiers must use louse powder routinely to prevent becoming infested.

132. INSECTICIDES. Three quartermaster insecticides are used: insecticide, powder, louse, 2 ounce can; insecticide, powder, delousing; (bulk) and insecticide, spray, delousing. All of these now contain DDT as the active ingredient. (See also ch. XIV.)

a. Insecticide, powder, louse, or insecticide, powder, delousing, is used by individuals and units for delousing clothing and equipment. The 2-ounce sifter cans are supplied for individual use, and the 1 pound or larger packages for group delousing. Louse powder is injurious to men if eaten and therefore should not be allowed to contaminate food. Powder dusted into clothing will not destroy eggs, but will continue to kill any lice that may be hatched or acquired in the next 3 or 4 weeks, if clothes have not been changed or laundered meanwhile. Insects are killed by the powder on mere contact, even though they do not eat it. The powder does not irritate the human skin.

b. Insecticide, spray, delousing is supplied mainly to fumigation and bath units operating in the field or delousing plants at ports. It is used in connection with methyl bromide or steam disinfection methods. After individuals have had a shower, the hairy parts of their body are sprayed with this insecticide. The spray is also effective against scabies.

133. HEAD LICE AND CRAB LICE. To get rid of these types of lice, dust the hairy portions of the body with the louse powder and let it stay on at least 24 hours (2 or 3 days will be even better). Since the powder does not kill eggs, reapply it after 1 week, and again in 2 weeks, to kill lice that may have hatched in the meantime. If louse spray is available, use it instead of powder because it will kill both eggs and lice. Examine hairy parts of the body closely at the end of a week or 10 days to be sure no live lice are present. One more application of powder will destroy any survivors. Cutting the hair short makes it more difficult for lice to settle and also makes powder and spray easier to apply. Shorn hair should be collected and burned.

134. USE OF DUST GUN FOR BODY LICE. a. Fill powder compartment of quartermaster dust gun (duster, powder, insecticide or a power duster) three-

quarters full of the louse powder. Test delivery of powder in the open and adjust duster to get a heavy cloud of powder and air from outlet tube.

b. When dust guns are used, delousing is done without removing clothes and in such a manner that the powder covers the inside of garments next to the skin, as well as the skin itself. (See fig. 51.) Operators doing this work for the first time should observe how well they applied the powder by examining the skin and garments of first few men dusted. If dusting was done properly, powder should entirely cover the underwear and be visible on the body hairs of the chest, back, armpits, crotch, and thighs. Since body lice are most often found in the seams of clothes, particular attention must be paid to the neck, armpits, waist, shirt tail, and crotch of clothing when powdering. The routine given below for powdering is effective. The men are told to loosen their collar and tie, to loosen belt, and then to stand or sit (whichever is most suitable) with hat in hand. Dusting is done as follows:

(1) Dust first the head, having subject rub the powder into hair. Hair should be whitened. Then dust hat and replace on head.

(2) Insert nozzle of duster into right sleeve, next to skin, with subject's arm outstretched to side at shoulder height, and blow powder toward armpit. With power dusters, hold trigger down until powder is seen to come from loosened neck of shirt. Subject's face should be turned away from side being dusted. Repeat for left sleeve next, or after Step 4.

(3) Insert nozzle inside collar of shirt at front, next to skin, blow powder toward right armpit, toward front waistline, and toward left armpit. Operator stands in front and subject leans forward, head tipped back.

(4) Insert nozzle inside collar of shirt at back, next to skin, and blow powder toward right side, toward back waistline, and toward left side. Operator and subject remain in same relative position as in Step 3 but with head of subject bent on chest. Be sure that some

powder is dusted on collar itself, where lice frequently abound.

(5) Insert nozzle inside top of loosened drawers at front, next to skin, having subject stand (if sitting) and blow powder toward right side and leg; toward crotch, and toward left side and leg. Operator remains in front.

(6) Insert nozzle inside top of loosened drawers at back, next to skin, and blow powder toward right side and leg, toward buttocks, and toward the left side and leg. Operator remains in same position as in Steps 3, 4 and 5, having subject turn around; or walks around to back of subject.

c. When hand dusters are used, two full even strokes per dose are required. With power dusters, a momentary pressure on the trigger is usually all that is necessary. The exact timing must be learned by experience.

d. In case female military personnel are to be disinfested, the same general procedure may be followed whenever possible; otherwise, liberal use of the powder at the neck and sleeve levels next to the skin will prove satisfactory. Women operators should be used in their disinfestation.

e. Individuals and clothing can be dusted rapidly and with less powder if a power dust gun is used because it can be easily manipulated and gives a uniform cloud of dust. Since more than one dust gun can be attached to an air compressor or tank of compressed air, this is the ideal method for large groups.

135. USE OF SIFTER CAN. If no dust gun is available, the powder may be dusted on clothing from the sifter can (insecticide, powder, louse, 2-ounce can) or any improvised shaker; however, it will be necessary to remove the clothing. Powder the inside of hat. Lay coat, with sleeves turned inside out, on a table; spread coat wide open so that the whole inside can be seen, then powder inside, taking particular care to get powder along the shoulder and armpit seams and down the arms. Next, lay the trousers, turned inside

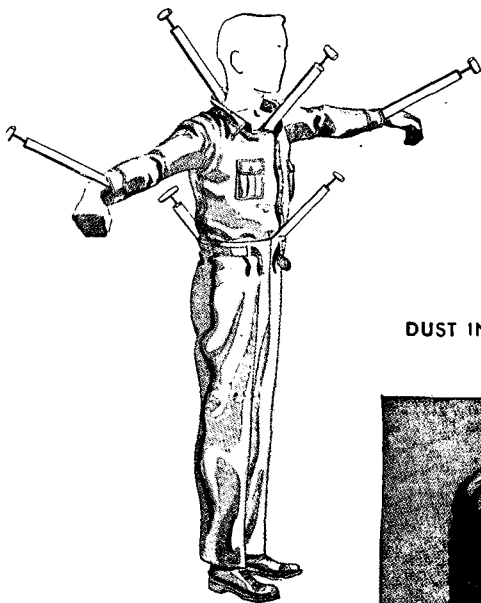

DUST INSIDE OF HAT

DUST BETWEEN SKIN AND UNDERCLOTHES AND BETWEEN UNDERCLOTHES AND NEXT LAYER

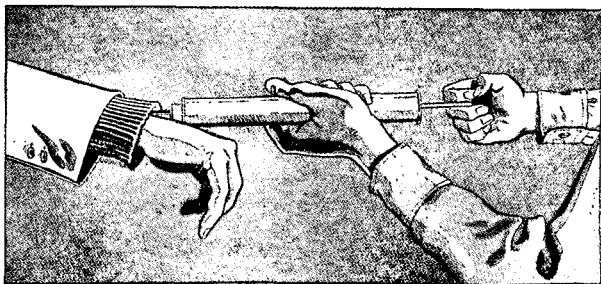
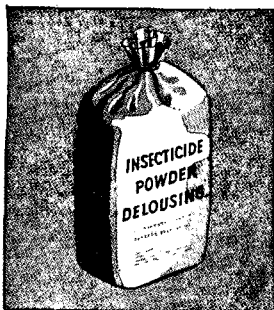

Figure 51. Use of dust gun for delousing.

out with the seat uppermost, on top of the coat. Powder all seams, particularly at the crotch, and shake powder down seams of both legs. Powder shirt like coat. The underwear should be turned inside out and powdered thoroughly, again paying particular attention to all seams. Shoes are not usually powdered. Fold the whole pile of clothes and give it a few hard blows to fluff the powder about; then the clothes are ready to wear. Repeat the powdering with each change of clean clothes before putting them on. This is necessary to keep from becoming reinfested.

136. POWDERING EXTRA CLOTHING, BLANKETS, AND BEDDING. Although 95 percent of all lice are found on a man's body or on the clothes he is wearing, infested extra clothing and bedding may cause renewed trouble.

a. When dusting extra clothing and bedding with a dust gun, place the delivery tube between two surfaces to speed the job and avoid wasting powder. Don't turn clothing inside out; instead, insert the delivery tube. If mattress covers are not in use, place a blanket over the mattress and dust between the two, taking care to reach the sides and seams. Blankets are dusted by piling one on top of another and dusting between every two blankets; by folding and dusting between two layers of same blanket; and by holding folded blankets in air if help is available, or hanging over a line and dusting between the fold. When the whole job is finished, hit each pile of blankets several times to spread the powder and work it into any seams and patches.

b. When a dust gun is not available, use the shaker can on each successive layer of bedding, then the surface of one blanket will spread powder by contact with the under surface of the next. After the pile is finished, beat it to distribute the powder evenly. Extra clothing is dusted as described in paragraph 135. Canvas packs, musette bags, boxes, foot lockers, and similar objects may also need dusting.

137. HINTS ON DUSTING. a. The amount of powder required to dust a person completely depends upon how much clothing is to be dusted. The underwear surface next to the skin is the most important to dust. From $1\frac{1}{2}$ to 2 ounces of powder are required for the average winter uniform, of which about 1 ounce should be applied to the winter underwear. The amount of powder used for bedding depends upon the type and quantity to be dusted. In estimating, allow 60 pounds for one dusting for every 250 men (4 oz. per man, to be divided evenly between his bedding and clothes). Whoever supervises the dusting should check to be sure that a sufficient amount is used.

b. The arrangements for powdering depend upon the size of the group, the lay-out of the camp, and the opportunity for getting the men and their bedding together; the object being to dust all the men and bedding at the same time. Men who are absent should be scheduled for later dusting because if any member of a unit is omitted, there is a danger that he will reinfest the group. The men can be easily trained to do the work themselves, under supervision.

c. Infested native laborers and troops who work closely with them should be given monthly dustings. This gives sufficient protection if clothes are not changed during that period.

d. The time between dusting in a prison camp or other isolated group depends upon the success of the first job and the degree of reinfestation. Most of the time, only one or two delousings a season are necessary. Before ordering the redusting of an entire group, carefully check the innermost clothing of a few members, paying special attention to seams at the arm, armpits, neck, waist, and crotch. Where 5 percent or more of those examined are lousy, redust the entire group.

138. OTHER METHODS OF DELOUSING. Measures that can be used where insecticides are not avail-

able are bathing, shaving, methyl bromide used with a delousing bag, methyl bromide gas chamber, steam applied in a Serbian barrel, steam pressure chamber, and dry storage.

a. Bathing. Baths are important for personal hygiene, whether the individual is infested with lice or not, and should be taken as often as possible in the

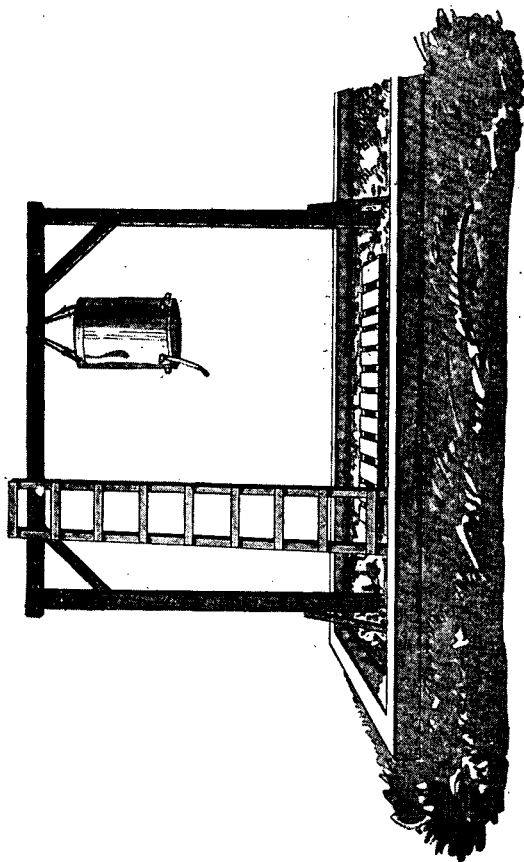

Figure 52. Shower bath made from Lyster bag.

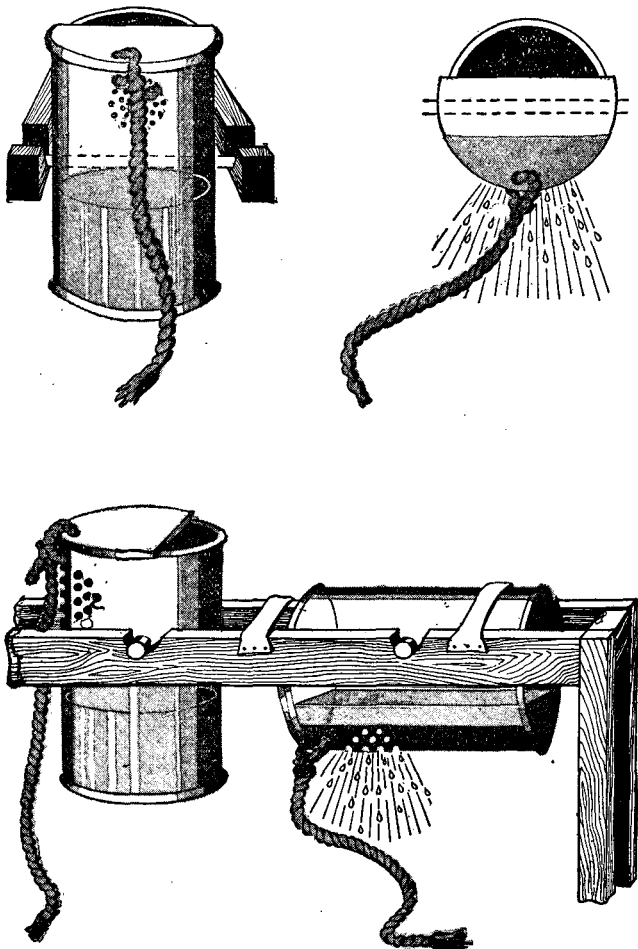

Figure 53. Use of oil drum for shower bath.

field. Water should be properly treated first whenever necessary. In every delousing program, except where powder is used, men bathe while their clothing and

equipment are being deloused. This is done in the field in quartermaster bathing units or fumigation and bath companies (see par. 139c) or in showers improvised as follows:

(1) A simple shower can be rigged up by suspending a Lyster bag from a scaffold or tree limb, and attaching a rubber tube to each faucet if necessary. The tube is fitted with a short section of pipe whose end is perforated like a shower head, or has a blind end and bent near lower end at a right angle with perforations along the under side parallel to ground. A stone-filled soakage pit is built under the shower and covered with boards for the men to stand on. A grease trap is also included if the pit is to be used for more than a few days. (See fig. 52.)

(2) A large tin container like a gasoline can is perforated at the bottom and suspended from a tree. One

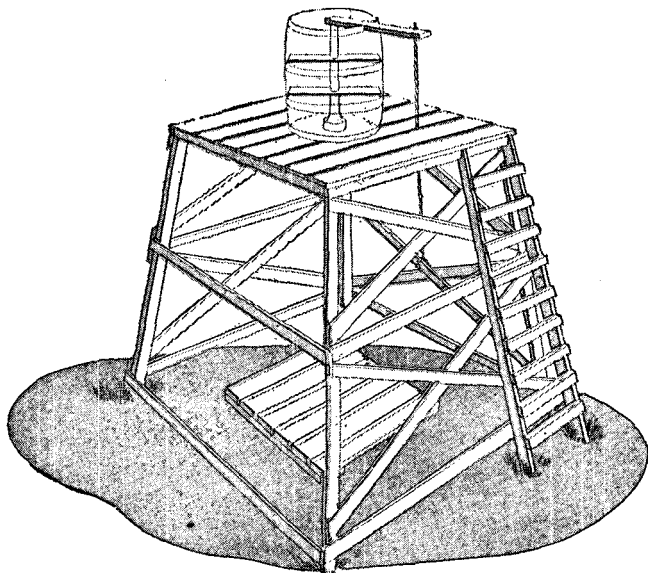

Figure 54. Shower bath made from barrel and tin can.

man can pour water through the can while the other man bathes. An oil drum used as illustrated in figure 53 does not require two men and makes it possible for the shower to be prepared, and water treated if necessary, before the men undress.

(3) A more elaborate arrangement can be made by

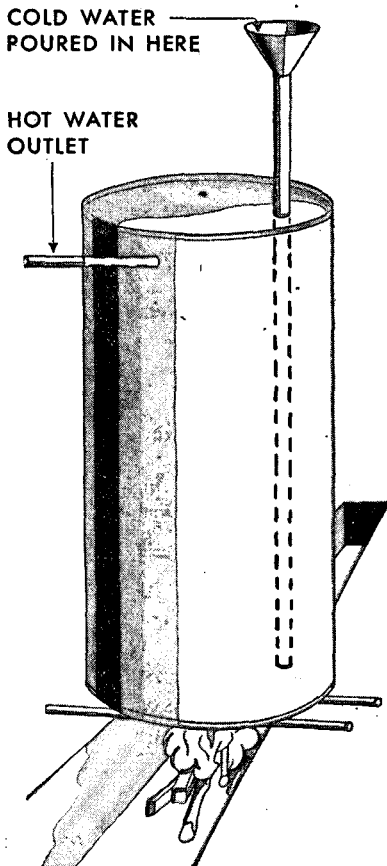

Figure 55. Heating shower water.

inserting a small perforated tin can into a hole cut in the bottom of a barrel. The valve is a plunger which fits snugly into the can. This plunger is controlled by a lever with a cord attached. (See fig. 54.)

(4) A simple heater for shower water can be made from a watertight container. One pipe, with a funnel top in which to pour cold water, runs through the top of the container to within 1 inch of the bottom. The other pipe is inserted at the upper edge of one side of the container to act as a hot water outlet. The heat source is placed directly under the container. Then the container is filled with cold water just below the level of the hot water outlet pipe. (See fig. 55.) When additional cold water is poured through the funnel, hot water comes out the other pipe.

b. Shaving. Bathing with soap will not remove all the eggs attached to the hairs of the body, so whenever eggs or louse bites are found, the hair at the armpits and genitals and, if necessary, on the head, chest and legs may be shaved or clipped. The hair removed should be destroyed, preferably by burning.

c. Methyl bromide and bag. Methyl bromide kills both the lice and their eggs. The quartermaster issue, bag, delousing, and ampules, methyl bromide 20 cc, are used as follows (see fig. 56):

(1) Place clothing, including shoes and blankets, loosely in the bag.

(2) Inclose one methyl bromide ampule (20 cc) in the special pocket inside the bag. (Do not remove cloth covering ampule.)

(3) Fold top of bag three times and tie tightly.

(4) Find ampule inside bag and break by striking it with a smooth stick.

(5) Fumigate clothes not less than 45 minutes when temperature is 60° F. or above; if below 60° F., add 1/2-hour for each 10° drop as in following table:

<i>Temperature</i>	<i>Hours fumigated</i>
50° to 59°	1¼
40° to 49°	1¾
0° to 39°	2¼

(6) After the required fumigation time has passed, stand on windward side, open bag, and dump contents loosely on the ground.

(7) Air clothing for 5 minutes and then shake each garment before putting it on.

(8) The methyl bromide treatment should not be expected to kill the lice immediately. But, even though they may remain alive for several hours or more, the eggs have all been killed. Any lice still living will not feed again before dying and whatever eggs they deposit in this period will not hatch.

(9) It is dangerous to breathe this gas for any length of time, therefore do all bag fumigation outdoors or under an open shelter. After fumigation, never air clothes in a closed room which is occupied, since the clothes may give off fumes for a short time after fumigation.

(10) A container of a special quick-drying paint comes with each lot of fumigating bags to be used for repairing leaking seams or peeling coatings. To patch rips and holes, use a piece of cloth saturated with this paint. If the delousing bags are not serviceable, fumigation can be carried out, using the same time schedule, by placing each man's belonging in his barracks bag, putting all the bags in one hole dug in the ground, and placing one ampule for each bag on the top bag. Cover hole with a raincoat or heavy piece of canvas, break the ampules, and then cover the hole completely, sealing the edges with earth. After the required time elapses, remove bags from the hole, open them, and air clothing for 10 minutes before wearing.

d. Methyl bromide gas chamber. Quartermaster personnel operate portable, gastight vaults using

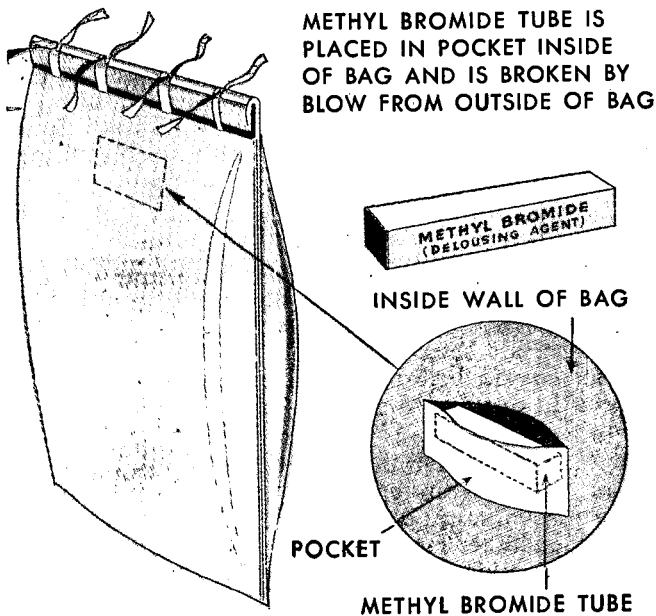

Figure 56. Delousing with methyl bromide and bag.

methyl bromide. These are operated outdoors or, if special ventilation has been provided, may be operated indoors. No chamber can be made absolutely gastight. Operating personnel should not work in an atmosphere containing more than 30 ppm of methyl bromide for long periods. The concentration can be checked with the halide leak detector. These rectangular vaults are set up in batteries, each vault having a capacity of 330 cubic feet (enough for 50 barracks bags at a time weighing 25 pounds each). Clothing is placed loosely in the bags so that the gas will penetrate throughout. Shoes and blankets are included. The total operation of loading, fumigating, airing, and unloading takes 1 hour, according to the following schedule:

	<i>Minutes</i>
Time of loading.....	10
Time for circulating gas	30
Time for venting	10
Time for unloading.....	10
Total	60

e. **"Serbian" barrel disinfector.** (1) This steam disinfector will accommodate a company and may take many forms, but the simplest is a large galvanized can or oil drum with one end removed. This container

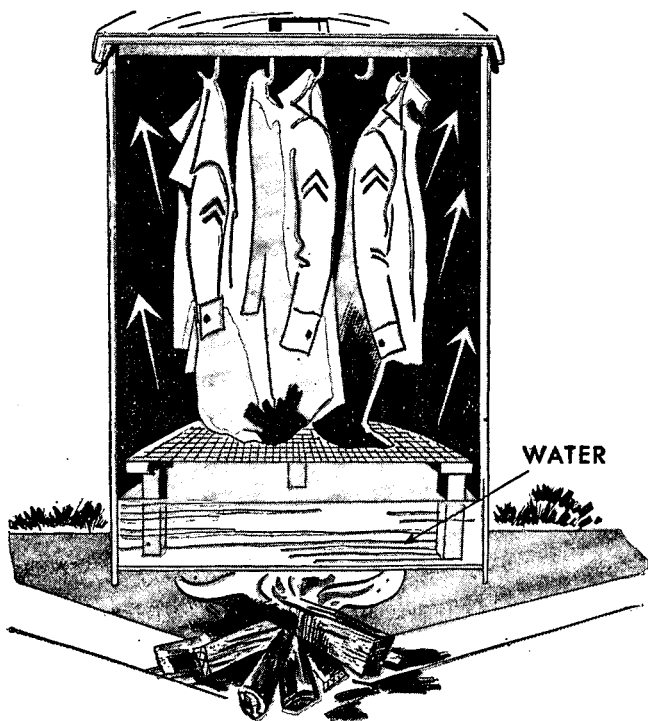
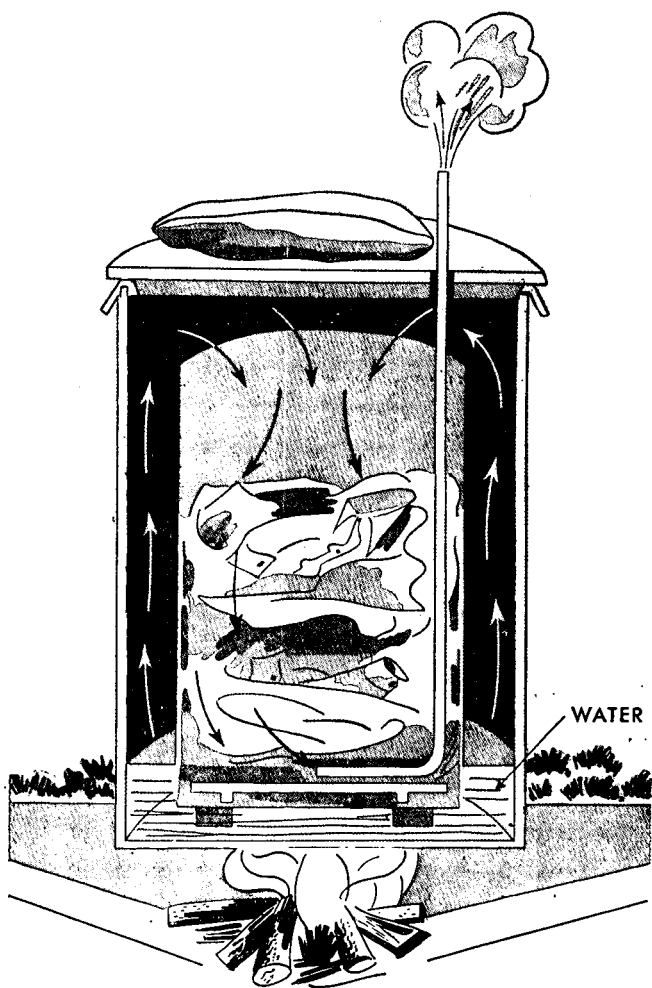

Figure 57. Serbian barrel disinfector
(upward displacement of steam).



*Figure 58. Double barrel type disinfectator
(downward displacement of steam).*

should have a tight cover fitted with hooks on which to hang clothes, and a grate 1 foot from the bottom to prevent clothing from falling into the water. After 6 inches of water are poured into it, the container is placed directly over a fire. Then the lid with the suspended clothes is held down with sufficient weight to produce pressure inside and to make sure steam penetrates into the clothing. To kill all eggs, nymphs and adult lice, keep clothes in can until 45 minutes after steam begins to escape at the edges of the lid. Clothes should then be air dried before return to wearers. (See fig. 57.)

(2) Another barrel type of disinfestor can be improvised by placing one drum inside another as in figure 58.

f. Steam sterilizer. Hospitals are provided with mobile or stationary steam sterilizers by which clothing and bedding of typhus fever cases can be disinfected, thus destroying germs as well as lice. These sterilizers are operated by trained personnel.

g. Storage. This method is sometimes used for disinfesting salvaged clothing, blankets, and other equipment. The principle of storing clothing and equipment is to deprive lice of a food supply long enough so that successive batches of eggs will hatch and larvae and adults will die. The time required depends upon the temperature, however, the safest rule is not to remove any articles from the room until *all* articles have been in storage at least 30 days. Do not add infested articles to those which have been in storage for some time, and make sure that storage rooms are kept dry.

139. DELOUSING PLANT. a. Regardless of size or methods used, these rules should be observed in installing and operating a delousing plant:

- (1) Never let clean and infested men mingle.
- (2) Divide the plant into two parts, one clean and one infested, connected only by showers for the men and disinfestors for the clothing and equipment.
- (3) Provide separate toilet facilities for each part.

(4) Provide adequate lighting to be able to inspect men and clothing.

(5) Clean plant buildings or shelters frequently to prevent infestation of clean persons.

b. Minimum divisions for a large plant are given below (some of these may be combined in smaller plants):

(1) Receiving room large enough to care for an overload if men are sent to the plant too rapidly.

(2) Disrobing room.

(3) Checking room for receiving and reissuing the barracks bags containing the clothes, and for tagging if necessary.

(4) Shower baths.

(5) Disinfestor room or shelter.

(6) Dressing room.

(7) Barber shop.

(8) Physical inspection room.

c. Quartermaster disinfestation units are sometimes available in the field. One quartermaster fumigation and bath company of 88 men using methyl bromide can delouse 300 men in an hour. One quartermaster sterilization and bath company of 159 men using steam sterilizer equipment can delouse 400 men in an hour.

CHAPTER 9

CONTROL OF MISCELLANEOUS INSECTS

SECTION I. TICKS

140. IMPORTANCE. Of the ticks found in the United States, the Rocky Mountain spotted fever tick (or common wood tick) and the American dog tick are of greatest concern because of the diseases they transmit to man. In areas where Rocky Mountain spotted fever exists, it is estimated that 1 percent of wood ticks carry the spotted fever organism. Ticks also spread tularemia from one animal to another or from animal to man and are found quite generally throughout the United States. Ticks also have been known to spread relapsing fever in Texas, Central America, Venezuela, and Colombia; Sao Paulo typhus in Brazil; African tick fever in Africa, and Q-fever in Australia.

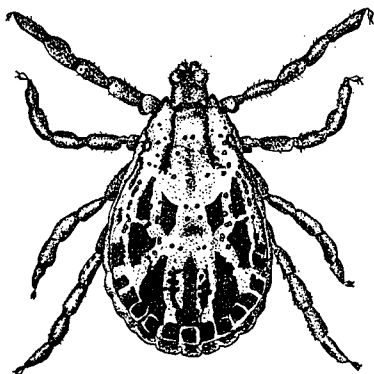

Figure 59. Wood tick.

141. HABITS AND CHARACTERISTICS. a. Rocky Mountain spotted fever ticks (*Dermacentor andersoni*) go through four stages of development: egg, larva, nymph, and adult. The last three forms are all blood suckers and will die if they cannot feed on blood. Eggs are deposited on the ground, in a protected place, during April, May, June, and July in batches of several thousand. The eggs hatch from 35 to 60 days later depending on the temperature. Upon hatching, the six-legged larvae cling to blades of grass, leaves, or twigs to seek a rodent or small animal when it brushes past. Then they attach and feed upon it for about 6 days after which they drop to the ground and go through a change in form. They are then eight-legged nymphs. In this stage, they usually do not feed during the same season but after sleeping through the winter, start feeding on rodents in the following spring or summer. After a week's feeding they again drop to the ground and change to become adults. This stage remains in hiding all summer and passes the winter (the second winter of the life cycle) as unfed adults. The following spring, the adult ticks look for man or large animals such as horses, cattle, sheep, bears, coyotes, mountain goats, and deer. They sometimes attack the large rodents such as the Jack rabbit, snowshoe rabbit, or porcupine. Once attached to the "host" the tick stays to feed for several days, during which time mating occurs, hence the eggs of the female are fertilized. Then, the female drops to the ground to lay her eggs and dies. While on the host, the males feed and continue to mate with other female ticks. Life cycle is usually two years. The most outstanding feature of this life cycle is the change of hosts from small rodents to large mammals by the adults.

b. Adult ticks can live as long as 2 years without food. Cold weather delays the development of young ticks and may kill some but not even the coldest weather will kill all adults or the organism of Rocky Mountain spotted fever which is carried in their system.

c. Ticks are able to spread the germs of Rocky

Mountain spotted fever, relapsing fever, and tularemia through the egg stage to the following generation of ticks which in turn are capable of transmitting the disease to man.

142. CONTROL OF TICKS. a. Control of rodents.

Larvae and nymphs feed primarily on squirrels, rabbits, prairie dogs, or woodchucks. Thus, one of the best ways to improve tick control in infested areas is to trap, shoot, and poison wild rodents wherever possible. Burning the underbrush should destroy a number of these animals and also destroy some of the ticks. Because sheep grazing will eliminate the food supply and housing of some small wild animals, it is an indirect means of cutting down the number of ticks.

b. Spraying camp sites. A spray for camp sites or bivouac areas may be prepared from 1.92 ounces of sodium fluoride, 0.64 fluid ounces of nicotine sulphate (40 percent nicotine), and 0.125 ounces of neutral soap to a gallon of water. At least 100 gallons are needed for each acre, but added vegetation may require more.

143. PREVENTING INFESTATION. Since it is difficult to control the number of ticks, every effort should be made to keep ticks off the body, or to remove them before they bite.

a. Repellents. Insect repellent, issued either in 2-ounce bottles or in bulk by the quartermaster, can be applied by hand or sprayed on the clothing below the knees and around the belt line. A thin layer $\frac{1}{2}$ -inch wide may be applied along both inside and outside of all openings of uniform—neck, fly, and cuffs of shirt; waist, fly, and cuff of trousers; socks above shoes; and all edges of leggings. Two ounces is normally required per treatment and is effective for 3 to 5 days. Good protection is afforded but may not be complete.

b. Removal of ticks. Men in tick infested areas should examine their bodies frequently in an effort to remove the ticks before they have been attached to

the body for 8 hours. This will often prevent disease since ticks may not spread infection for some time after attachment. To remove a tick attached to the skin, be very careful not to crush it or pull off its head. It may be removed carefully with a small pair of forceps, although it will detach itself if insect repellent or a lighted cigarette is applied. Ticks must not be killed by crushing as their bodies may contain germs that will contaminate the skin. The best method to destroy ticks after removal is by burning. Treat the bite wounds with tincture of iodine or similar antiseptic.

SECTION II. BEDBUGS (*Cimex lectularius*)

144. **IMPORTANCE.** Bedbugs survive wherever they can live in close association with man and they often become serious pests in barracks and guardhouses. While it has not been proved that bedbugs transmit any disease to man, they have been suspected of trans-

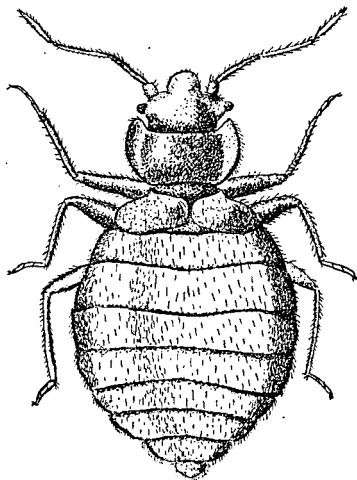

Figure 60. Common bedbug of temperate zone.

mitting relapsing fever and leishmaniasis. Because they are blood-sucking insects, it is possible that they may transmit any disease in which there is a blood stream infection.

145. HABITS AND CHARACTERISTICS. a. The bedbug goes through three stages of development: egg, nymph, and adult. The white, oval eggs which are about the size of a pinhead are deposited in cracks, crevices, or any place that offers protection and concealment. In warm weather, the eggs hatch in 1 to 2½ weeks, but this is delayed or even prevented by cold weather. Nymphs look like adults but are smaller and almost colorless. They need blood to develop and become adults which requires 6 to 11 weeks, depending on food and temperature. At the adult stage, the bedbug takes on a flat shape and turns to a reddish brown color.

b. Bedbugs feed at night. They can survive for 6 months or more without food. They are very sensitive to high temperatures and in any form are killed in a few minutes by humid temperatures above 113° F. They are also killed by prolonged exposure to temperatures below freezing.

c. Bedbugs are usually spread from place to place in clothing, bedding, beds, baggage, or furniture. They hide in the tufts and seams of mattresses and pillow cases, and in nail-holes, cracks, and crevices of wooden or metal structures or buildings.

146. CONTROL MEASURES. a. **Insecticide spray, DDT, residual effect.** For use of DDT in controlling bedbugs see chapter XIV.

b. **Fumigation.** This is an effective bedbug control measure provided the gas penetrates into the depths of the cracks and crevices in the walls, floors, and furniture. Hydrocyanic acid gas generated from an acid or from discoids is penetrating and properly used will destroy the bedbug at any stage. However, the

gas is fatal to human beings and should never be used unless a rigid guard is maintained at all times. Fumigation should not be attempted by untrained personnel. Buildings should be reentered only after a qualified medical department officer declares them safe.

c. Other control measures. Insecticide, liquid, finished spray (quartermaster general utility spray), also will kill bedbugs if it reaches cracks and crevices and comes in contact with the insect. As a repellent, kerosene applied weekly has been used with success. Either a sprayer or paint brush can be used to apply these liquids.

SECTION III. ROACHES AND ANTS

147. IMPORTANCE. Roaches and ants do not transmit insect-borne disease as mosquitoes do; however, they are a serious nuisance and may spread disease by contaminating food with germs carried on their feet and bodies.

148. CONTROL MEASURES. The most effective control is to deprive roaches and ants of food by keeping a clean mess and keeping all food in refrigerators or screened cabinets.

a. Roach control. (1) *DDT*. For use of DDT against roaches see Chapter XIV.

(2) *Roach powder and insecticide*. This powder, issued by the quartermaster, should be placed in cracks, corners, and around water pipes. It must be kept dry and allowed to remain 24 to 48 hours. Since the present powder consists of sodium fluoride, a poison, care must be taken not to contaminate food.

(3) *Poison roach bait*. Make up equal parts of boric acid powder (not borax) and powdered sugar, then add just enough evaporated milk to make a stiff paste. Roll the paste out flat, cut it in half-inch squares and place it in spots where roaches gather.

b. Ants. First of all, destroy all food scraps and protect stores.

(1) *DDT*. For use of *DDT* against ants, see chapter XIV.

(2) *Kerosene*. A good way of keeping ants away from food is to tie kerosene-soaked rags around table and ice box legs, or to place the legs in cans filled with water. Once the ant nest has been located, dig up the earth over and around it for several inches and pour in a pint of kerosene. Boiling water poured repeatedly into the nest is also effective.

SECTION IV. FLEAS

149. IMPORTANCE. Several kinds of rodent fleas are responsible for spreading bubonic plague and endemic typhus fever. Various rodents, principally rats, are reservoirs of infection from which fleas spread these diseases to man. Rodent fleas rarely select human beings to feed upon but will do so in the absence of animals.

150. CONTROL MEASURES. **a. *DDT*.** For use of *DDT* against fleas see chapter XIV.

b. Rodent control. The best way to control fleas is to get rid of the rodents such as rats and ground squirrels that they feed upon. This includes destroying their nesting places and cutting off their food supply. Rats not only contain the disease germs of bubonic plague and endemic typhus fever but they also spread several other diseases. Rat control campaigns are supervised by the Medical Department and the principal control measures are described in detail in chapter 10.

c. Other measures. Fleas may be removed from pet animals by washing them in a 3 percent solution of creosol or a 10 percent emulsion of kerosene. At the same time that pets are being treated, their blankets and beds should be disinfested.

SECTION V. CHIGGERS (OR MITES)

151. CHARACTERISTICS. Chiggers (red bugs) are the larvae of mites which live in the soil. In the adult stage, these mites live on plants and do not bite animals or man. However, the larvae or chiggers must have a blood meal in order to develop, so at this stage they attach themselves to men or animals. After feeding, they drop off and spend the remainder of their lives on the soil. The larvae or chiggers of the American and Oriental mites are the most important.

152. AMERICAN MITES (*Eutrombicula alfreddugesi*). The larvae of this insect do not transmit any disease but their bites are extremely annoying. Since the bites continue to itch after the chigger drops off, scratching often results in infection. Men not accustomed to chiggers usually suffer most. American chiggers are troublesome throughout the southern States, though they are also found in northern States. Chiggers prefer bottom lands and areas overgrown with briars or blackberry bushes, but may be found on well-kept lawns in the first few years after an area has been cleared. The number of chiggers is open to considerable local variation and is also affected by latitude and season. Chiggers may be found in small numbers throughout the winter in climates where there is no hard freezing. Farther north, they become active about the first of April when blackberry bushes start to bloom. At the latitude of Dallas, Texas, their numbers are greatest in early June and the annoyance continues until heavy frost in middle November.

153. ORIENTAL MITES (*Trombicula akamushi*). Larvae of the Oriental species, often called the kedani mites, spread a kind of typhus fever from rodents to man. This fever is known variously as scrub typhus, Japanese river fever (tsutsugamushi), and mite typhus. In Japan this chigger is found along rivers and flooded areas, especially during hemp harvesting season. In the

Tropics, the chigger is very common in jungle grass, low bush, and other uncultivated areas.

154. CONTROL MEASURES. Control measures are the same for both American and Oriental chiggers. They consist of destroying the rodents on which the larvae feed and applying sulfur to infested areas. Around bivouacs and temporary camps, chiggers can be killed by using finely powdered sulfur. Best method is to use a rotary type duster with a ratio of 15 pounds sulfur for an acre. The treatment should be repeated if rain washes the sulfur away. Information regarding the value of DDT in any form is meager. Special measures against the Oriental chigger include sleeping off the ground and burning all grass and brush in camp site areas. Sand should be spread over the camp area when available. Cots should be provided where possible and tent flooring should be raised 2 or 3 feet above ground level.

155. PROTECTIVE MEASURES. Since control is difficult, the means of preventing infestation are mainly of the protective kind. Most important precaution is to avoid mite infested areas. If this is impossible, men should fasten clothing snugly at the ankles, roll sleeves down, and button collars. Sitting or lying in these areas is almost certain to be followed by a chigger attack.

a. Insect repellent. The same insect repellent issued by Quartermaster Corps for protection against mosquitoes is also effective against chiggers. It should be applied as a moist band, $\frac{1}{2}$ -inch wide, on the inside of trouser bottoms, inside cuffs of sleeves, and between the buttoned surfaces of shirt fronts. Chiggers will not cross these protective bands. Applied to clothing of the lower arms and legs and around the neck, a single spray of this repellent offers protection from chiggers for as much as 2 weeks and some protection from ticks. Since insect repellent is a strong solvent, men

should be careful not to use it on plastic buttons, plastic watch crystals, or rayon fabrics.

b. Powder. Men should dust the inside of their clothing and bodies from the waist down with powdered sulfur, a means of protection which will prove about 70 percent effective for 1 or 2 days. Ordinary flowers of sulfur will suffice but finer sulfur (of 325-mesh) is better. Dust sulfur lightly on skin, under clothing, and inside socks before entering chigger-infested areas. Since some men are sensitive to repeated applications of sulfur and others object to its odor on skin, it should not be used if regular quarter-master repellent can be obtained.

SECTION VI. STABLEFLIES OR DOGFLIES

156. GENERAL. The stablefly (*Stomoxys calcitrans*) looks like a housefly, but has piercing mouthparts and is a severe biter of man and animals. Along coastal areas, it is often a very serious pest and is capable of stopping all outdoor work activity. Along the coast, it breeds in turtle or eel grass washed up on sheltered beaches. This fly seldom breeds on beaches which are not sheltered from the waves. Inland, the stablefly often breeds in barnyard manures that contain decaying hay, in waste feed beneath feeding troughs, beneath piled litter left in the fields, and in strippings of celery around celery washing plants. Borax treatment sometimes used to control housefly breeding is not very effective against stable fly breeding. Stableflies are best controlled by treating the breeding places with creosote oil. If one part creosote is thinned with three or four parts kerosene, it can be sprayed effectively. This treatment remains effective even though bay grasses are washed away and brought up again to the edges of the beaches. If manure is to be used in compost piles or for fertilizing crops, the spray method should not be used. Spreading the manure before it becomes infested and in such a way that it dries quickly will help to prevent fly breeding.

157. USE OF REPELLENT. Repellent, insect, is by far the most effective repellent to protect man or animals from the bites of stableflies. It can be applied to the clothing as a fine spray mist or applied from the 2-ounce bottle. It should also be applied to the face, neck, hands, and ankles just as for mosquitoes. The degree of protection will depend on the number and size of the flies. Smaller flies that develop in beach grass will be repelled for about 3 hours, and larger adult flies near celery and peanut crops may be repelled for 7 hours.

SECTION VII. EYE GNATS

158. IMPORTANCE. Small gnats (*Hippelates species*) that crawl about the eyes, nose and mouth are responsible for spreading eye infections among soldiers and at times they are numerous enough to create a serious nuisance. These gnats breed in soil that is polluted with body wastes or decayed vegetable matter.

159. CONTROL. Breeding can be controlled by proper disposal of human wastes, by plowing the soil and exposing the infestations to sun and air or to low temperatures. Drying of infested soil is very important in controlling the breeding places of gnats. Around camps and buildings, jar traps will help reduce the gnat nuisance. These traps consist of a 1/2-gallon glass jar fitted with very fine (60- to 80-mesh) screen-wire cones. The jars are laid on their sides in the forks of trees or other shady places. Bait inside the jar consists of a cube of liver about 1-inch square, with a small amount of water added to keep the liver from drying out.

160. USE OF REPELLENTS. The repellent recommended for mosquitoes is also effective in protecting men from eye gnats. It should not be applied to eyelids or above the eyes if men are perspiring freely. Applied to the face, hands, and beneath the eyes the repellent gives good protection.

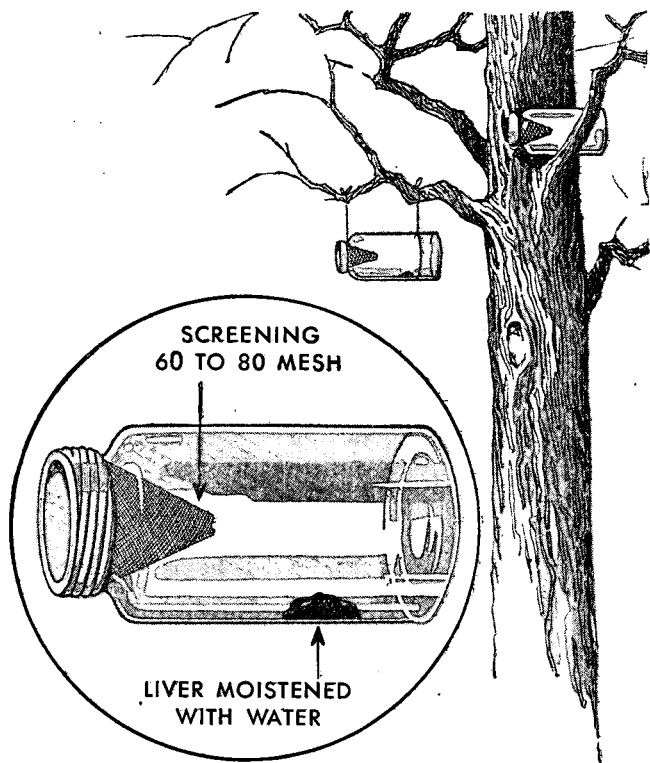

Figure 61. Jar trap for eye gnats.

SECTION VIII.

BITING MIDGES AND BLACKFLIES

161. PHLEBOTOMUS OR SANDFLY. Phlebotomus flies look like very small gnats and are rare in the United States and Australia but are common in many warm countries. They are active at night, in the evening, and at dawn and usually avoid wind, sun, and full daylight. These flies chiefly attack wrists, ankles,

or any exposed part of the body, and readily bite through thin socks. Their bite is painful and may result in marked irritation. They are attracted to artificial lights but rarely fly farther than 50 yards. Breeding occurs in slightly moist, dark places like caves, crevices, stone embankments, crumbling ruins, earth fissures, and deep canyons. The phlebotomus fly transmits sandfly fever, a denguelike disease present throughout the coastal regions of the Mediterranean, in South China, India, and Ceylon. The phlebotomus fly may also carry leishmaniasis and Oroya fever.

162. PUNKIES (*Culicoides* species and related *Chironomidae*). **a.** A small biting midge, commonly known as a "sandfly," is found in the coastal area of the Tropics. Technically the term "sandfly" should be restricted to the bloodsucking species of the family Psychodidae. This fly breeds in salt marshes where the larvae feed on dead crabs and minnows left in wet soil. When the adults emerge, they feed upon warm-blooded animals.

b. The small midges that breed in rot-holes of trees are closely related to the sandflies that breed in salt marshes. They breed upon dead insects that are covered by water in the hole of a tree. When the adults emerge they are attracted to lights and warm blooded animals.

c. Control. (1) *Aerosol insecticide* (mosquito bomb). The aerosol insecticide is recommended for controlling these insects and eliminating them from inclosures.

(2) *Insecticide, liquid, finished spray*. This preparation contains DDT and is intended for spraying with flit gun. (See further instructions ch. XIV.)

(3) *Insecticide, spray, DDT, residual effect*. This spray is designed for application by either spray or paint brush, to surfaces upon which insects crawl or rest and exerts its effect by the prolonged residual action of the DDT deposit. (See ch. XIV.)

(4) *Screening*. Punkies, like Phlebotomus flies are

so small that only a tight mesh (0.0334 inch) can keep them out. Nets with suitable mesh are available from the quartermaster in areas where such insects are found. Ordinary screening can be made to exclude sandflies by daily painting with quartermaster insecticide, spray, DDT, residual effect.

(5) *Repellents*. Repellent, insect, is quite effective in preventing bites from these insects. It may be applied from the 2-ounce bottle. It should be smeared on the face, neck and hands just as for mosquitoes. These flies are repelled for 3 or 4 hours.

(6) Electric fans directed against doors and windows are also helpful.

(7) For permanent control, remove rubbish, fill cracks in walls, tree holes and eliminate other breeding places.

163. BLACKFLIES (*Simulium* species) **a.** Blackflies (buffalo gnats) which are much larger than punkies acquire their name because of a characteristic hump-back appearance. The larvae of these flies live in fast-flowing streams where both the larvae and pupae attach themselves to rocks and spillways. Different species breed in floodwater lands and at immature stages are attached to overhanging limbs and twigs that come into contact with flood waters. The bite of these flies is not painful but can be irritating and persistent. In tropical areas they transmit the worm, microscopic in size, which causes onchocerciasis, a disease forming small lumps underneath the skin containing the parasites.

b. Control. (1) *The aerosol insecticide* (mosquito bomb) is also recommended for controlling these insects and eliminating them from inclosures.

(2) *Insecticide, liquid, finished spray*. This spray applied with a flit gun is effective for control of this pest.

(3) *Insecticide, spray, DDT, residual effect*. This spray applied by either spray or paint brush is effective.

(4) *Screening.* Although these flies are larger than *Phlebotomus* they are small enough to enter ordinary 18 by 18 mesh. By painting the screens with quarter-master insecticide, spray, DDT, residual effect, these flies will be excluded.

(5) *Repellents.* By application of insect repellent to the face, neck, and hands, as used for mosquitoes, these flies will be repelled for about 7 to 8 hours.

CHAPTER 10

RAT CONTROL

SECTION I. CHARACTERISTICS OF RATS

164. IMPORTANCE. Of all animals living at the expense of man, rats are the most costly—not only because they destroy his property but also because they transmit very serious diseases. They carry intestinal parasites like tapeworms and contaminate food with their own diseased excreta and with the germs they track from human waste. The fleas which live on rats spread bubonic plague and endemic typhus. The bite of an infected rat spreads ratbite fever. Food contaminated by the urine of infected rats gives men Weil's disease. Because of the contagious and deadly effects particularly of bubonic plague, rodent control measures should be supervised by medical officers where this disease is or has been present. This applies with special force to the handling of dead rats in plague areas.

165. CLASSIFICATION. Three species of rats live in close association with man and are of sanitary concern: brown rat (*R. norvegicus*); black rat (*R. rattus*); and roof or Egyptian rat (*R. alexandrinus*).

166. HABITS. Before rats can be successfully destroyed, it is necessary to know the habits of the different species as well as the characteristics they all have in common.

a. Brown rat (*R. norvegicus*). This rat is a poor climber and keeps mainly to lower floors and basements of buildings, wharves, and sewers. It burrows

into the hardest soil to live and breed. The brown rat is a great gnawer and will eat anything regardless of its degree of freshness or decay.

b. Black (*R. rattus*), and roof (*R. alexandrinus*) rats. The rats of both these species are excellent climbers and live in hollow walls, garrets, trees, or loose material like boxes, barrels, and rubbish. In the Tropics they frequently nest in the trunks of palm trees. They can enter buildings along clotheslines and electric wires. These rats are relatively clean in their habits and prefer grain and fresh, clean food.

c. All rats are great travelers on ships, boxcars, and other public carriers, going great distances in search of food. They can get through holes as small as $\frac{1}{2}$ -inch in diameter. Rats usually come out only at night.

SECTION II. CONTROL MEASURES

167. GENERAL. Before picking a method of control, surveys are made to find out to what extent rats infest the building or area; where the burrows or nests are located; what kinds of food the rats are getting, and how that can be prevented; and what control measures will best suit local conditions. Control procedures are either suppressive or destructive. Suppressive measures are designed to deprive rats of food and keep them out of harborages. Destructive measures include poisoning, trapping, fumigation, and hunting by animals which are natural enemies of rats.

a. Suppressive measures. As long as shelter and food are plentiful, rats breed almost as fast as they are destroyed, therefore suppressive measures must be taken first. Ratproof buildings by closing every opening $\frac{1}{4}$ -inch in diameter or more. Use hard materials like sheet metal, concrete, brick, or heavy screen with mesh less than $\frac{1}{4}$ -inch. Small buildings may be elevated on concrete piers with metal flashings. New buildings should have ratproof floors, foundations, and walls. Store all food in ratproof containers or build-

ings, keep the mess hall clean, and dispose of garbage properly.

b. Destructive measures. These measures should be carried on continuously. They are most effective at the start of the campaign before the older rats learn to avoid poison baits and traps; however, they will keep destroying young and newcomer rats.

168. POISONING. This is an effective control where there are a large number of rats, but it will not kill all of them, because some learn not to touch the bait.

a. Kinds of poisons. (1) Zinc phosphide will be used, ordinarily, to poison rats. Mix 1 ounce poison to 6 pounds of a food base like canned salmon, ground fresh meat, or rolled oats. It is better to use several different food bases because some rats like meat and others like cereals or coconut meat. The poison and the poisoned bait should not be handled with bare hands for two reasons: first, rats will avoid bait which smells of human beings; secondly, zinc phosphide and most other rat poisons are also poisonous to man.

(2) Although no longer regularly used by the Army, the following poisons will kill rats: red squill (fortified), arsenious oxide, phosphorus, strychnine, thallium sulphate, and barium carbonate.

b. Bait. (1) *Preparation.* The bait should be cut or shaped into small balls, cubes, or cakes about $\frac{1}{2}$ -inch in diameter and should be well moistened. To keep from being poisoned, mix the bait with a knife or spoon. To make it most effective, wrap it in plain squares of waxed paper with the corners brought together into a torpedo-shaped package. *Be careful not to get toxic poisons on the skin or in the mouth; use rubberized gloves or other suitable protection.*

(2) *Distribution.* Place fresh bait, either singly or in groups, in places easy for the rats to get at, especially in runways leading from their holes, alongside the walls, and on top of rafters. This should be done late in the afternoon. Several types of bait may be placed together. When baits are used in groups, do not place

them more than 20 feet apart. Put out a large number of baits from the beginning.

(3) *Prebaiting.* To accustom the rats to eating the same kind of food that later will carry the poison, place unpoisoned baits for several days, collecting the uneaten ones and replacing them with fresh baits. When the rats start eating unpoisoned baits freely, collect all the uneaten baits and distribute a large number of the poisoned baits.

169. TRAPPING. This control measure requires greater skill and labor than poisoning. If the rats have plenty of food, they will avoid the trap. Also rats soon become suspicious, especially if the trap is unskillfully set. Therefore, set a large number of traps in the beginning of the campaign. Systematic trapping is practicable in large warehouses, especially to destroy new arrivals without continued use of poison.

a. Types of traps. Traps should be strong and durable, preferably steel. There are two general types: snap (guillotine or spring), and cage. Since rats soon become suspicious of cage traps, the snap trap is better.

b. Baits. Fried bacon, cheese, and doughnuts are most attractive to rats; but fish, grain or grain mash, liver, fresh bread, cantaloupes, or tomatoes can also be used. Change the kind of bait often if trapping is continuous.

c. Trap setting. Baits should be large and securely fastened to the trigger with string or thread. Soft baits may be smeared on. Place the traps in runways frequented by rats, with the trigger end of the trap against the wall. The trap may be disguised by covering. Traps also may be prebaited, by not setting the spring of the trap the first few times the traps are placed. This accustoms the rats to the sight of the trap. When ready to do the active trapping, set the trigger so that the slightest movement of the bait will spring the trap.

170. FUMIGATION. Hydrocyanic acid gas, methyl bromide, carbon disulphide, and carbon monoxide are

the gases commonly used to destroy rats. Since these gases are highly poisonous to man, fumigation should be done only by specially trained men.

a. Rats in dumps and burrows around the outside of buildings may be killed by carbon monoxide from an automobile. Adjust the carburetor for a rich mixture and allow the engine to run at a moderate speed for 10 minutes for the average burrow. Before treating burrows, make sure they are as gastight as possible by sealing the cracks and openings of connecting burrows with earth.

b. Carbon disulphide on balls of cotton or waste may be placed in rat burrows which are then sealed. They are more effective in damp weather and when the ground is wet. This agent is a fire hazard and should not be used near buildings.

c. Calcium cyanide dust blown into burrows with special dust pumps will give off hydrocyanic acid gas. Handle the dust carefully and only in the open because it is very poisonous. HCN disks may be used in buildings but only by trained and experienced personnel.

d. A little over two teaspoonfuls (10 cc) of methyl bromide are dropped into each burrow and the opening is then closed tightly. This gives off a gas which kills the rats. It is also poisonous to man. A special apparatus is designed for this purpose.

171. HANDLING DEAD RATS. Since fleas, mites, and other insects which live on rats usually leave the body of the dead rat fairly soon and remain nearby, dead rats should be collected as soon as possible and disposed of with care. Pick them up with a tong, pitchfork, or similar instrument having a long handle. After collecting them in insectproof containers, closely woven bags, or a metal container with a tightly fitted lid, burn them in the incinerator before any remaining insects can leave the bodies. In the presence of bubonic plague, specially designed suits should be worn by those doing rat control.

CHAPTER 11

MISCELLANEOUS DISEASES

SECTION I. TETANUS

172. GENERAL. Tetanus, or lockjaw, is caused by the introduction of tetanus germs into the body through a wound or burn. A deep puncture wound is the most dangerous, but tetanus sometimes follows the most trivial-looking wound or burn. Wounds contaminated with soil or manure are especially dangerous. The toxin or poison which is produced affects the nervous system and causes spasms and convulsions. More than half of the cases result in death.

173. CONTROL MEASURES. All military personnel, on entering the service, are given three injections of *tetanus toxoid*, followed a year later by a single stimulating dose. This immunization is recorded on each man's identification tag. If a man is wounded or burned, he is given another injection of toxoid as a "booster dose." If, however, his identification tag does not show that he has received toxoid previously, a different preparation called *tetanus antitoxin* is substituted. The toxoid is much superior to antitoxin and it is therefore very important that all identification tags be stamped properly and kept up to date. Because of the Army immunization program, cases of tetanus among military personnel have become very rare.

SECTION II. RABIES

174. GENERAL. Rabies (hydrophobia) is a disease of animals which is sometimes transmitted to man. It

occurs in many wild and domestic animals but is most common in dogs. There are two forms in the dog: the furious or excited form, and the dumb or depressed form. Both types lead to paralysis and death. The organism causing rabies is usually transmitted by entrance of saliva through a wound or scratch on the skin. The incubation period of rabies is much longer than for most diseases. Once rabies has developed it is always fatal. A large proportion of persons bitten by a rabid dog will develop the disease unless promptly and properly treated.

175. CONTROL MEASURES. Control of rabies depends on prevention of the disease in dogs, treatment of bites, and vaccination of persons bitten.

a. Dogs should be given rabies vaccination each year and the date should be stamped on the dog's collar. Dogs exposed or suspected of having been exposed to the infection should be held in quarantine for as long a period as the veterinary officer recommends. Positive and suspected cases of rabies among the animals or pets of a command should be turned over to the veterinary officer for disposition.

b. Anyone bitten by a rabid dog should report at once to a medical officer for treatment of the wound and a course of rabies vaccinations (Pasteur treatment) which is very effective in preventing the disease. Stray biting dogs should be captured and kept under observation long enough to determine whether they have rabies (usually 10 days). If it can be avoided, the dog should not be killed because observation of a living dog is more conclusive than examination of its brain. If a person is bitten by a dog not definitely known to have rabies, the medical officer will decide whether or not vaccine should be given.

SECTION III. SCABIES

176. SCABIES. This disease, also known as "7-year itch," is a contagious skin infestation caused by a tiny

itch mite. It is spread occasionally by infested clothing or bedding but usually by physical contact with an infested person. Bodily contact in sexual intercourse is often the means of transferring the disease. Scabies causes intense itching which is worse at night. The parts most frequently attacked are the webs of the fingers, backs of the hands, inner surface of the wrists, arms, and thighs, lower part of the abdomen, buttocks, and genitals.

177. CONTROL MEASURES. The only way to keep the disease from spreading to others is to recognize cases immediately, and to isolate and treat them. All men who have been in daily contact with a case should be carefully examined. The underclothing of the patient preferably should be boiled or steam-sterilized. Where approved laundry or dry-cleaning facilities are available such treatment is adequate to disinfect garments. Since daily bathing with liberal use of soap and frequent changing of underwear are the main means of avoiding scabies, organizations which observe the rules of personal hygiene should not be troubled with this disease.

SECTION IV. DERMATOPHYTOSIS

178. DERMATOPHYTOSIS. a. The term "dermatophytosis" includes a group of infectious skin diseases caused by various fungi (microscopic molds) which rarely penetrate deeper than the outer layer of the skin, and may also involve the hair and nails (ringworm, tinea, athlete's foot, epidermophytosis, trichophytosis). The organisms grow best under conditions of warmth and moisture. Thus dermatophytosis cases are more common in summer, occur in the moist, sweaty parts of the body and are more likely to be a serious problem in tropical or subtropical regions. Dermatophytosis is very common; it may be so mild as to be barely noticeable or so severe as to be completely disabling and tend to persist or recur. The

organisms causing dermatophytosis are commonly spread by contact of the bare skin with contaminated surfaces such as floors, mats, benches, and chairs in the bathrooms of gymnasiums, clubs, and swimming pools. Towels, slippers, shoes, or other articles worn next to the skin may also transmit the fungi.

b. The common name for these skin infections is "ringworm," because of the tendency for many of them to form rings by circular spread of the infection at the edges while the center heals. The principal forms are ringworm of the scalp, beard, body, crotch, and feet. The common appearance is that of one or more rounded, red or brownish, slightly raised, scaly patches which may contain minute blisters. There is often considerable itching. Ringworm of the crotch, commonly known as "jock-strap itch", is likely to occur in epidemic form. It is a fungus infection chiefly involving the skin about the genitals, the inner side of the thighs, the groin, and the cleft between the buttocks; it causes severe itching.

c. Fungus infection of the extremities often is called epidermophytosis or "athlete's foot." It is the most common of all skin diseases and usually occurs as an inflammation of the skin between the toes and on the soles of the foot, but may occur also on the hands. On the feet, it frequently occurs first between the fourth and fifth toes. It may appear as thickening and scaling of the skin, raw inflamed areas, cracked skin, or blisters. Usually there is considerable itching. Additional infection with other organisms can occur, adding to the inflammation and disability. Athlete's foot tends to flare up when the feet perspire, even after lengthy treatment, and complete cures are very difficult to obtain.

179. CONTROL OF DERMATOPHYTOSIS. The control measures for all forms of dermatophytosis are much alike. The main object is to prevent contact between the bare skin and any objects contaminated by infected persons.

a. Care of feet. Proper care of the feet, especially keeping them clean and dry, is particularly important in the prevention and control of athlete's foot. Men should be instructed to dry carefully the areas between the toes before putting on socks and shoes after a bath. They should not walk barefoot on floors, even in the bathhouse except when actually in the shower room. If the feet tend to perspire a great deal, the issue foot powder should be applied lightly and evenly twice daily. Formaldehyde or other drying solutions should not be used unless advised by a medical officer.

b. Treatment of cases. All case of dermatophytosis should be treated promptly and thoroughly. Hospital care is not necessary in all cases, but treatment should be given under the close supervision of a medical officer. Self-treatment will often make the condition worse. The feet of all men should be inspected at regular intervals whenever the disease is common and all cases discovered should be promptly reported for treatment. If numerous cases are found, careful search should be made to determine whether there has been some slip in sanitary precautions.

c. Disinfection of floors and equipment. The most effective control measure is disinfection of bathhouse floors and equipment, as well as towels, swimming or gymnasium suits, and similar articles. Bathhouse floors and such equipment as mats, benches, and chairs, should be scrubbed daily with soap and water and then flushed with water under pressure. In warm weather, screened windows should remain open to permit the direct rays of the sun on the floor. In cold or inclement weather when windows must remain closed, scrub floors and equipment with a solution made of 1 ounce calcium hypochlorite to 1 gallon of water, after scrubbing with soap and water. Duckboards in shower baths should be removable so that they can be scrubbed thoroughly and exposed to sunlight for several hours each day. Two sets should be provided to permit use on alternate days. Towels, gym

suits, slippers, shoes, or gloves should not be exchanged or used in common unless thoroughly disinfected. All articles that cannot be damaged by boiling should be sterilized in that way.

d. Foot baths. Common foot baths containing germicidal material are not of sufficient value to warrant recommendation. Results achieved with their use have been disappointing, and emphasis should be placed on the other measures described.

SECTION V. PLANT DERMATITIS (POISON IVY, POISON OAK, POISON SUMAC)

180. PLANT DERMATITIS. a. The resinous sap of certain plants causes skin eruptions in susceptible people. The most common of these plants are poison ivy, poison oak, and poison sumac (also known as poison elder or dogwood). It is possible to get the eruption without touching the plant itself, because the sap may be carried on clothing, tools, or hands. Poisoning has even resulted from the smoke of fires burning the plants. Most cases however result from direct contact with the plant.

b. The skin eruption, accompanied by severe burning and itching, appears within 24 hours after exposure, usually on the hands, forearms, and face. At first there is redness and swelling, followed by tiny blisters which may later merge into larger ones. The blisters break in 2 to 4 days leaving a raw surface from which fluid escapes. This surface then becomes crusted and usually heals within 2 weeks.

181. CONTROL MEASURES. Men should be taught to recognize the plants listed in paragraph 180a, especially poison ivy which causes most cases. This plant can be distinguished from the other creeping vines because its leaves grow in clusters of three instead of five. (See fig. 62.) In the selection of camp sites, areas where these plants grow should, if possible, be avoided.



Figure 62. Poison ivy.

All men working in areas where these plants are found should wear gloves. Outer clothing and gloves should be changed upon leaving the area, and contaminated tools should be kept separate. Vegetation should be burned at a distance from the camp site and on the leeward side so that the wind will carry the smoke away from camp. If exposure has occurred, contaminated clothing and tools should be washed well with soap and hot water. All parts of the body that have been exposed should be washed thoroughly several times with a strong soap solution or with alcohol, using a fresh solution each time. If the eruption appears, a medical officer should be consulted.

CHAPTER 12

ACCLIMATIZATION, MARCH HYGIENE, AND CAMP SITES

SECTION I. ACCLIMATIZATION

182. GENERAL. In spite of the increasing use of motor transport in modern warfare, marching is still an essential part of field duty. If proper attention is paid to march hygiene (sec. II) and camp sanitation (sec. III) troops are better able to march long distances and tolerate the strain of living in the field. In addition, special attention must be paid to water and salt requirements of those men stationed in hot climates.

183. CONDITIONING. Men should be well-seasoned or conditioned before they engage in long marches, go on maneuvers, or engage in actual combat. This conditioning can be done by systematic and progressive training which includes practice marches of gradually increasing length. At the same time, men should be given periods of mental and physical relaxation at suitable intervals to avoid overtraining. Those who are found to be physically unfit for strenuous field duty should be weeded out.

a. Regardless of their physical condition, all troops who are suddenly exposed to temperatures higher than 90°F. must go through a special period of physical adaptation called acclimatization before they can do heavy duty without endangering their health. However, men who are in rugged condition will take less time to adjust themselves. The period of adaptation

to a hot climate should be from 4 to 7 days, during which the men should be carefully supervised by medical and company officers and responsible noncommissioned officers. Meanwhile, the workload should be increased gradually along with increasing exposure to intense midday heat. Strenuous work upon first exposure to the heat usually results in disability, and when continued for several days will incapacitate many men. Moreover, the few who can continue their work will be inefficient.

b. For 1 week before and after entering a hot climate, men should be given plenty of rest. Alcoholic drinks should be forbidden. Moreover, even men who are well acclimated cannot work well if they do not get enough sleep. Men who have had recent illnesses should not be allowed to work in the heat of the day until they are back in good physical condition.

c. Getting properly acclimated to hot, dry (desert) environment will make it easier to become accustomed to working in hot, moist jungles. However, the men will still need an adjustment period with regulated exercise when they actually start living under jungle conditions.

184. WATER REQUIREMENTS. Water needs vary directly with the temperature and the kind of work being done.

a. At high desert temperatures, sweat evaporation is the only means of cooling the body and preventing heat exhaustion. However, not even deserts are hot at all times and seasons; except for the Sudan and the southern Sahara, most of them are cool at night. In the jungle, where both air humidity and temperature are high, sweat does not evaporate but runs off the skin. As a result, cooling becomes less efficient and water losses may increase. In cold weather, the body loses heat into the surrounding air; while in hot weather (above 100°F.) the body may gain heat from the surrounding air, the sun, and the radiation from hot surfaces.

b. The 24-hour water requirement for each man ranges from 2 quarts per day for marching or work in cold weather to 3 gallons per day for marching or work in very hot weather. In the hottest weather, even men who are not exerting themselves may sweat out as much as a pint of water in an hour. Since water requirements vary, there must be enough water to provide for the maximum amount that the troops may need. Men on long marches and hard working units such as the engineers and labor battalions may need as much as 3 gallons of water for each man every day in the desert. With unusual exertion at temperatures above 120°F., the requirement may even be greater. In the desert, any unnecessary exposure to the sun should be avoided because it increases the need for water, adds to the threat of sunstroke, and may cause serious sunburn. When water supply is limited, a substantial amount can be saved by having men do heavy work and strenuous marching in early morning or evening, or even at night.

c. As men's bodies lose water by evaporation, the deficiency must be made up immediately. Any restriction below the necessary level not only lowers efficiency and morale, but if kept up for hours may be followed by heat exhaustion. This applies to everyone, even those who appear best adjusted to their surroundings. A gradual reduction in water produces the same final effect as sudden restriction, except that the symptoms develop more slowly. For work at high temperatures, the total amount of water consumed will vary little whether it is taken whenever thirsty or only at meals. Those who delay drinking until mealtime may suffer discomfort without any advantage in water economy or physical well-being. *The ideal practice is to drink water in small amounts whenever thirsty.* Thirst-quencherers like chewing gum and fruit drops may decrease discomfort from thirst but otherwise are of no advantage. It must be emphasized that it is impossible to condition men to work or march with less water than

their normal requirements without endangering health and reducing their efficiency.

185. SALT REQUIREMENTS. Loss of a large volume of water in the form of perspiration is always accompanied by loss of salt. The amount of salt in the normal diet is enough to make up for losses when a man's water consumption is less than 1 gallon a day. However, if more water is consumed, more salt is needed. *Salt is best taken in solution to avoid nausea.* It is particularly necessary that salt be taken during the first few days of exposure to heat since the salt losses during the first few days are greater than those after acclimatization. Again, since men depend upon food for their salt requirement, if they lose their appetite or fail to eat, it is important that they make up the salt requirement in their drinking water. This can best be done by making a solution of 1/10 percent table salt in drinking water using the following proportions:

<i>Table salt</i>	<i>Water</i>
1 pound	100 gallons
3/10 pound	Lyster bag (36 gals.)
1/4 teaspoon	Canteenful

or by dissolving two 10-grain tablets in a quart of water. Swallowing salt tablets directly is not recommended because nausea frequently results. *If no water is available, extra salt should not be taken.*

186. DANGER OF HEAT EXPOSURE. In hot climates, especially where the humidity is high, men may suffer one of three serious effects which all line officers and noncommissioned officers should be able to recognize and be able to give the victims immediate first-aid treatment: *heat stroke, heat exhaustion, and heat cramps.* The causes and methods of prevention are similar but each condition produces distinctive symptoms which should be recognized at once for prompt attention.

187. HEAT STROKE. This condition often appears suddenly with little or no warning. There is headache, dizziness (perhaps nausea and vomiting), and then collapse, delirium, and unconsciousness. The first sign that may be noticed is that sweating has stopped and the skin feels hot and dry. Collapse may follow immediately and the victim may die in a short time unless treated promptly. The body temperature goes up to 106°F. or higher.

Emergency treatment: The one measure that will save the victim's life is to lower his temperature quickly. In the field, do not wait for medical treatment but place the patient in the shade if possible and immediately remove all of his clothing. One man should do this while another is getting cool water. If possible, place patient in a stream. Sprinkle or douse his body with water from head to foot repeatedly until he revives. When water is scarce, pay most attention to the head. Rub his arms, legs, and trunk briskly to increase blood circulation to the skin. Fan patient constantly to speed up water evaporation with its cooling effect on the body. Medical attention must be secured as soon as possible, since it will be necessary to send the patient to the hospital. In the meantime, continue to take every measure to cool his body.

188. HEAT EXHAUSTION. This condition causes headache, drowsiness, extreme weakness, dizziness, and inability to walk. There may be some muscle cramps also. The important thing to remember in heat exhaustion is that the *skin is usually cool, moist, and clammy*. While men are often put out of action by this condition, it is not quite as serious as heat stroke and causes few deaths. Severe cases may die if untreated, but death comes slower than in heat stroke.

Emergency treatment: Removing the patient to a cool, shady place where he can rest and giving him large quantities of salt water by mouth will usually bring about recovery. It is not necessary to remove

patient's clothing. After first-aid treatment has been given, the patient must get medical attention and be hospitalized as soon as possible since no chances can be taken.

189. HEAT CRAMPS. Heat cramps are painful spasms of the muscles, usually the legs, arms, and abdominal wall. In result, they vary from mild annoyance to complete disability.

Emergency treatment: Cramps are directly due to lack of salt in the body and are relieved when this loss is replaced. Treatment consists of drinking salt water freely. Severe cases must be sent to the hospital as it may be necessary to inject the salt solution into the veins.

190. HOT WEATHER RULES. These rules apply to operations in hot climates above 90°F. with either low or high humidity. The latter conditions usually occur in tropical and subtropical climates. Each of the following points should be emphasized often for the benefit of all troops:

a. *If water is plentiful,* drink when thirsty and drink enough to satisfy thirst. Salt your food freely. If in 1 day you work hard and sweat profusely for over 2 hours, drink water containing 1/10 percent table salt. If you have missed a meal, start drinking salted water after 1 hour's work instead of 2. Salted water may not be pleasant to take at first but the taste can be quickly acquired. If you have the onset of symptoms of heat exhaustion, stop work and lie down in the shade.

b. *When water is scarce,* it is still unwise to deprive men of water whether for economy or in an effort to "harden" them. Reduced water rations only cause shortages which must be gained back in 12 hours. Otherwise, physical efficiency and morale are cut sharply, and heat stroke, heat exhaustion, and heat cramp become increased risks. To keep from drinking

water during work or marching in the heat does not bring about an important over-all saving. Total water consumption by troops for 24 hours is very nearly the same in the desert, whether the men have had water during an 8-hour march or not. If men are forced to live on short water rations, the best means of saving water is to cut physical effort to a minimum and to avoid all work during the hottest hours of the day. In fact, by working or marching during the coolest part of the night men have been known to save as high as 40 percent of their daily requirement of fluids. This method of water economy involves no danger to health.

c. *Reflex sweating* is the name given to a sudden outbreak of perspiration after drinking water. Men who are dry may see perspiration on their skin or clothing after taking as little as 6 ounces (less than one glass) of water at one draught. This has given rise to the opinion that the perspiration is being wasted as a result of taking so much water into the system. This is not the case. No perspiration is wasted as long as it does not run off the body. The sweat evaporates and thereby helps to cool the body, causing the men to perspire less afterward.

SECTION II. MARCH HYGIENE

191. INSPECTIONS BEFORE MARCHES. Before starting on a march, company commanders should make a thorough inspection of all men in their commands. This includes a detailed inspection of feet and footwear, of clothing and equipment, and a determination of each man's physical fitness. Immediate steps should be taken to correct all defects that impair the activity and stamina of his men. Tightly fitting footgear and other clothing will constrict the circulation and may give rise to a march casualty. Cold, wet weather conditions and terrain combined with tight footgear may result in trench foot. Men

who appear to be ill or physically unfit should be sent to the hospital or dispensary.

192. CONDUCT OF MARCH. Well-trained troops can march 25 miles in 8 hours; however, the average daily distance for foot troops is 12 miles for larger commands and 15 miles for smaller units. In hot weather, marches should be conducted in early morning, late afternoon, or at night. Meals served before the march should include energy-producing foods like sugars (carbohydrates) and fats.

193. HALTS. Halts are made at regular intervals so that men can rest, adjust equipment, and relieve themselves. These regular halts are usually made according to a set procedure. At the end of the first 45 minutes of marching it is customary to call a 15-minute halt so that squad leaders can check footgear lacings for tightness. After that, the usual halt is 10 minutes out of each hour. If halts are to be made which were not foreseen in the original march order, notice is promptly sent back through the column by unit commanders during the course of the march.

a. All march units of a column stop and start at the same time. This is regulated by watches which have been set at the same time before the march begins. At the halt signal all units bear to the side of the road and fall out to rest. When possible, all halts should be made in the shade. Men should be encouraged to remove or loosen packs and relax during these rest periods. To improve blood circulation and to keep the feet from swelling, men should elevate their feet and legs by placing them on rocks, banks, or logs. It is often necessary also to loosen shoes and leggings after a few hours' marching. At rest periods, human waste should be disposed of in small individual pits dug with an entrenching shovel and immediately covered after use. Straddle trenches should be dug at the noon halt, and at temporary bivouacs.

b. It is desirable to finish the day's march as soon as possible, therefore long halts should not be made unless special conditions require them. The time of starting march, length of march, or the desire to avoid excessive heat may make it advisable to call a long halt at midday. This will depend in large part on existing conditions and the type of troops involved.

c. Columns execute long halts by the units moving into a temporary bivouac near the route of march and previously reconnoitered. In picking the location for the halt, the comfort as well as security of the troops must be considered. The location preferably should be shady, near a safe water supply, and the ground such as to make waste disposal easy.

194. HEALTH ON THE MARCH. Many of the discomforts of marching can be reduced by foresight and good judgment.

a. Routes of march should be reconnoitered and marked before the march starts. It will be found that making adequate preparation for stream crossings and the removal of obstacles will reduce unnecessary delay. Fords, bridges, and ice-covered ponds should be carefully examined before crossings are attempted. All water sources must be considered unsafe. Water for drinking must be properly treated before use. If time has permitted checking these sources previously, they will be so labeled. When safe sources are inadequate along the route of march, drinking water will be supplied in the same manner as rations.

b. Unit commanders should watch their men closely for signs of fatigue or illness. To save march casualties, blisters and minor foot illnesses should be treated promptly. Men who are unduly fatigued should be relieved of their packs; those who become sick should be given immediate medical attention. The surgeon attached to a troop unit marches at its rear and it is his duty to examine all men who have been permitted

to lag behind (stragglers). If their condition warrants, the surgeon gives them a permit admitting them to the ambulance or authorizes them to place their equipment in one of the convoy vehicles. After treatment, he may direct them to rejoin the foot column by reporting to the guard who marches at the rear of the unit. Ambulances also follow the rear of the line of march to handle men who have become disabled and cannot continue the march on foot. Full instructions on collection and evacuation of march casualties may be found in FM 100-10.

c. Troops are not kept in column or under arms longer than necessary. On going into shelter, animals in the column should be cared for first whenever the situation permits.

d. Cold weather hardships on a march are lessened when the men are suitably dressed in warm clothing. Ears, face, hands, and feet must be especially protected. All unit commanders should be equipment conscious and see that their men are properly fitted and equipped. Every effort should be made to obtain the newest and best equipment for their men that the quartermaster issues for the type of weather expected. Mounted troops can improve their blood circulation by dismounting and leading their mounts. Men occupying cramped positions in vehicles should run along the road at short intervals whenever the chance is presented. Foot troops sling their weapons over shoulders to permit free arm movement.

e. Snow and ice make it harder to march, therefore in breaking new snow trails, the strain should be equalized by changing the leading elements frequently. In deep snow it may be necessary to break the way for foot troops with a bulldozer or plow. If such conditions are usual, troops are equipped and trained in the use of snowshoes and skis. Smoked glasses should also be provided for the eyes to prevent snowblindness.

195. ADVANCE QUARTERING PARTY. a. Quarters parties are set up to simplify occupation of a shelter area and to make sure that all command, administration, and supply units function without interruption. The party consists of a staff officer, medical officer, mess assistant, and representatives of subordinate units. The staff officer is the chief quartering officer. Arrangements should be completed before troops arrive. Quarters parties proceed separately to their assigned areas before the march starts. However, if the area is assigned during the march, they are permitted to leave their positions in the column a sufficient time in advance to stake out the area.

b. Subject to the approval of the area commander, quarters parties select the area; make detailed arrangements to occupy it; allot areas and facilities to subordinate units; and reserve special administration and supply facilities like headquarters and message centers. Sanitary plans should be completed before the main body arrives. It is especially important that the source and method of treating water be determined at once. Guards can then be posted to prevent water contamination or the use of unauthorized sources. Straddle trench latrines and garbage pits should be dug the first day even if the camp is to be of several days' or more duration. Deep pit latrines can be set up on the following day.

196. PROCEDURE ON ARRIVING AT CAMP SITE. When foot troops arrive at a new camp site they should go immediately to their bivouac areas, unslung packs, and pitch tents. The following steps should be initiated by the unit commanders as soon as possible after arrival:

- a. Serve a hot meal.
- b. Announce orders regarding sanitation to the entire command.
- c. See that all troops wash feet and change socks and shoes.

d. Inspect all organizations and arrange to treat injuries and correct any other defects.

e. Announce sick call.

f. Verify posting of water guards and treatment of water supply.

g. Consult the unit medical officer about men who seem physically unable to continue the following day's march.

SECTION III.

SELECTION AND SANITATION OF CAMP SITES

197. SELECTION. Camp sites are selected according to well-defined military and sanitary rules. As long as the tactical situation permits, security, availability of supply, sanitation, ease of administration, and comfort of troops are the determining factors in selecting bivouac areas. The military situation may make it necessary to select a site which does not fulfill all sanitary requirements. However, strict attention should be paid to all the rules which do not interfere with the military mission. Selection of a camp site is the responsibility of the area commander. However medical officers are responsible for making sanitary surveys of proposed sites, with recommendations as to their suitability. In larger units the recommendations of engineer and quartermaster officers are requested also.

198. SANITATION. a. Since careless disposal of human waste can cause serious epidemics, some type of latrine should be built immediately on going into bivouac. These are situated at the opposite end of the camp from kitchens, and so placed that drainage cannot pollute the water supply. Officer latrines are set up on the basis of one for each battalion.

b. Troops will be informed where to get water for (1) drinking and cooking, (2) animals, (3) bathing, and for (4) washing clothes, and (5) vehicles. On small streams, these places are designated in the sequence

given, working downstream. These watering places are clearly marked and guards are posted to make sure that the water supply is used as directed. Drinking and cooking water should be properly treated before use.

c. Areas must be kept policed at all times; and all refuse and garbage should be burned or buried. When a shelter area is evacuated, fires are put out; latrines and kitchen pits filled and marked; and the site left thoroughly policed.

d. In billets, medical officers on the area commander's staff may be designated as community health officers to regulate all matters of public health and sanitation. Sources of drinking water are tested and marked; additional latrines are set up; measures are taken to dispose of refuse and garbage; order and cleanliness are enforced on all personnel in the shelter area; a dispensary is established. In general, every required measure is taken to protect the health of the command.

199. DESIRABLE FEATURES FOR CAMP SITES. a. Accessibility to a sufficient amount of good water and fuel.

b. Sandy loam or gravel soil, favorable to waste disposal.

c. Firm, grass-covered turf.

d. Elevated, well-drained site.

e. Sufficient space to avoid crowding and to permit wide spaces between kitchens and latrines.

f. Shade trees as sun protection.

g. Protected slope or trees as windbreaks in cold weather.

h. Firm ground for vehicles.

i. A good road net.

j. Concealment from air observation.

200. UNDESIRABLE FEATURES FOR CAMP SITES.

a. Dry beds of rivers, ravines, or depressed areas in rainy country.

- b. Clay or loose, dusty soil.
- c. Marshy ground or areas near water which may be infested by mosquitoes and subject to mist or heavy dew.
- d. Ground water level less than 4 feet from the surface of the ground.
- e. Steep slopes.
- f. Location within a mile of native villages in tropical or subtropical climates.

201. REFERENCE DATA ON SANITARY CAMP INSTALLATIONS. **a. Latrines.** (1) Locate on side of camp opposite to prevailing wind at least 100 yards from kitchen, 30 yards from nearest tents, and so placed that contents will not drain toward water supply.

(2) Provide 16 feet of straddle trench in 4-foot sections or two standard latrine boxes with deep-pit latrines for each 100 men. Facilities should accommodate eight percent of command at any one time.

(3) Provide one urine soakage pit for each 200 men if urine pipes do not enter latrine pits.

(4) Install device for washing hands in vicinity of latrines—"tip or dip" cans.

b. Kitchen installations. (1) Kitchen wastes may be buried when the camp is to be occupied less than 1 week.

(2) Locate at opposite end of company street from latrines.

(3) Provide one soakage pit with barrel or baffle grease trap for each 200 men. If camp is occupied over 2 weeks, a second soakage pit should be installed.

(4) Install suitable incinerator for each kitchen.

(5) Set up three suitable cans per company for washing messkits.

c. Wash benches and shower baths. (1) Locate between company street and latrines.

(2) Allow 10 feet of wash bench for every 100 men.

(3) Allow one or two shower heads for every 100 men, where possible.

d. Water supply. (1) Locate water sterilizing bags between kitchen and company street.

(2) Average daily consumption per man:

	<i>Gallons</i>
Semipermanent camps	20 to 40
Temporary camps	5
Bivouac or marching	2
Minimum in combat	1

(3) Normally each animal needs 10 gallons a day; minimum in combat is 5 gallons.

e. Dump and compost pile. Locate at least 1,000 yards from tents. Size depends on the duration of the camp.

f. Closing camp. Before leaving the camp site close all sanitary installations. Fill in latrines and kitchen soakage pits and indicate by markers merely stating, "CLOSED LATRINE." *Remember that today's camp may be tomorrow's line of communication.*

CHAPTER 13

PERSONAL HYGIENE

SECTION I. GENERAL

202. RESPONSIBILITY. Before a man is accepted into the Army, he is given a thorough physical check-up to see that he has no disease. After that, it is his duty to keep himself in the best possible physical condition and to protect himself from infections. The care which a person gives his body to keep in good health is called personal hygiene.

203. EARLY MEDICAL TREATMENT. Do not make the mistake of underestimating the value of prompt medical attention. Although sick call is held at a regularly stated time, medical attention is available 24 hours a day to any man who feels sick, thinks he has acquired a disease, or who has been injured. All he has to do is report to his first sergeant or the non-commissioned officer in charge of quarters (if on duty he reports first to his immediate officer or noncommissioned officer in charge) who will then send him to the medical officer for examination. Men should not hesitate to report for fear of being accused of "goldbricking." They may have a disease which will spread to other men in the unit; or their ailment may be made worse by delay or self-treatment. Frequent visitors to the dispensary who have no discoverable disease require special attention by their medical officer, chaplain, officers, and noncoms, because these men may be having trouble adjusting themselves to their environment or duties. Frank and sympathetic discussion of their difficulties will often do away with the complaints.

SECTION II. MEASURES TO PROTECT AND IMPROVE HEALTH

204. GENERAL. Every man has some degree of natural resistance to infection. This resistance can be increased by any measures which protect or improve his general health; for example—

- a. Keeping the face, body, hands, and feet clean.
- b. Protection from cold and chilling with the help of suitable clothing, blankets, and housing.
- c. Enough of the right kind and variety of food.
- d. Physical training, including athletics.
- e. At least 7 to 8 hours sleep each day, preferably continuous.
- f. Prevention of undue fatigue. (This is particularly important in training camps where there are epidemics of respiratory diseases.)
- g. Healthful recreation. (Morale of an organization is closely related to the physical condition of its men.)

205. CARE OF BODY. a. An unclean body invites entry of germs. Therefore the entire body should be bathed not less than twice a week (daily in garrison). When facilities for a complete bath are not available, the body should at least be wiped with a clean, wet, soapy cloth, paying particular attention to the face, hands, armpits, crotch, and feet. Hands should always be washed after going to the toilet and also before eating.

b. Protection against lice and other disease-transmitting insects is discussed in chapters 8 and 9.

c. Underwear and shirts should be changed and washed at least twice a week. If water is not available, crumple clothing, shake it out thoroughly, and then air it in the sun for at least 2 hours.

206. CARE OF MOUTH. It is highly important to clean the teeth thoroughly twice a day, but especially just before going to bed. Brush the inside and outside

surfaces away from the gums and toward the biting surfaces. A small amount of table salt or soda on the toothbrush will do an excellent cleaning job in the absence of toothpaste or powder. It is important to remove food particles between the teeth promptly, taking care not to injure the gums. If dental floss is available, use this to keep spaces between teeth free of food thereby helping to prevent cavities from forming. When a cavity is first noticed, report to the dental officer at once. Don't wait until the tooth aches since then it is often too late to save the tooth.

207. CARE OF FEET. This is a most important requirement in order for any soldier to march well and keep fit to fight. Serious foot trouble can be prevented if proper footgear is worn; if shoes and socks fit properly; and if feet are kept clean, dry, and free from infection.

a. Shoes. Only those shoes and other footgear issued by the quartermaster should be worn in the field. Company commanders are responsible for having all their men equipped with the right kind of footgear and properly fitted. In fitting, there should be no binding or pressure at any point on the shoe when the foot is expanded by body weight; neither should shoes be so large that they cause rubbing. The feet often spread after drilling or marching and shoes that fit snugly in the beginning may later become too tight. If any man believes that his shoes do not fit properly, he should consult his first sergeant or unit commander. The shoes will be exchanged for a pair of proper size if found necessary. Men should be forbidden to exchange shoes among themselves. Because of the irregular shape of the foot, shoes can be fitted properly only by actual test, using a shoe-fitting machine or by hand. (See AR 850-125 for detailed instructions.)

b. Socks. Woolen socks (light or heavy) should be worn for marching. Cotton socks should not be worn on marches except on recommendation by a medical

officer. Socks should be large enough to let the toes move freely, but not so loose as to wrinkle. Woolen socks must be one-half size larger than cotton ones to allow for shrinkage. It should be kept in mind that after several washings they may shrink sufficiently to constrict circulation. Should this happen, they must be exchanged for a pair of proper size. Socks which have holes or are darned should not be worn while marching because they will cause blisters. Wearing 2 pairs of socks will help prevent rubbing between the shoes and the feet.

c. Cleanliness. Feet should be washed and socks changed each day. This is especially important after a march. As soon as possible after reaching camp, wash (not soak) feet with soap and water, drying them thoroughly; then change to clean, dry socks and if possible dry shoes. If water is not available, rub feet with a soft towel or cloth to remove excess moisture and dirt and to stimulate circulation. To avoid ingrowing toenails, keep them properly trimmed, cutting them straight across rather than on a curve.

d. Blisters. Wash carefully around the blister with soap and water. Then empty it by pricking its lower edge with a pin or knife point that has been held in a flame for 1 minute. Do not remove the skin, but cover the blister with adhesive tape extending beyond its edge. In a few days the ordinary blister will have dried up and the adhesive tape can be removed. If a blister becomes infected report to the dispensary or aid station at once.

e. Corns, bunions, ingrowing toenails, and serious abrasions. Corns, bunions, ingrowing nails, and serious abrasions should be treated at the dispensary or aid station.

f. Athlete's foot (*Dermatophytosis*). This common and frequently disabling fungus infection should be treated as soon as it is discovered to prevent spreading elsewhere on the body and to others. The instructions in paragraphs 178 and 179 should be followed.

g. Trench foot. Trench foot in severe form is a very crippling condition which may lead to gangrene and loss of the feet or toes. This condition will develop if the feet are allowed to remain cold and wet for a long time, as when many hours are spent during cold, rainy weather in muddy fox holes, shell holes and other depressions with no effort to keep feet even reasonably dry and warm. Although it is not always possible to keep feet absolutely dry and warm under combat conditions, much can be done to help prevent trench foot by sticking closely to the following rules:

(1) Never stand in water or mud if it can be avoided, even when wearing waterproof or water-resistant boots or overshoes. Wearing soaked footgear and continuing to stand in water or mud will make feet even colder and cut down the blood circulation. Therefore try to bail out any water in the trench with a helmet, or find stones, branches, or other material for making a crude floor to keep oneself above the water and mud.

(2) Remove wet socks and replace with dry ones as soon as possible, and at least once daily, wringing out the wet ones and placing them flattened out inside the outer clothing to dry (wool socks dry fairly quickly). Extra pairs of socks can best be kept dry by wearing them looped over the armpit inside the shirt sleeves. Never sleep in wet boots in order to dry them or for any other reason because the blood supply which warms the feet is much slower during sleep or rest than when walking. After removing boots and wringing out wet socks, place them both alongside the body inside the blanket or sleeping bag so that the body's warmth will help to dry them. Also, change to a dry, clean pair of socks before going to sleep when in the field.

(3) Since feet are warmed by circulation of the blood, avoid having clothing too tight around the legs and do not lace shoes tightly; otherwise circulation is cut down. Standing, or sitting with the feet hanging down for the long periods also slow the cir-

ulation. Therefore, when forced to stay in the same spot for a long time, take every opportunity to lie or sit with the feet raised just above the level of the hips, and also to wiggle the feet and toes inside the shoes. Other stationary exercises such as alternate raising of both legs together above the level of the hips for 1 minute and then lowering them for 1 minute, repeating for five or more times will help keep feet from swelling as well as warm them somewhat.

(4) Special types of footgear should be worn to help prevent trench foot. Be sure that the proper sizes and combinations of these are worn. When 2 pairs of socks are worn, the outside pair should be one-half size larger than the inside pair.

(a) The shoe-pac, 12-inch, is especially designed for wear under conditions causing trench foot. Experience in combat has shown it to be the best item so far developed for aiding in trench foot prevention. Shoe-pacs come in full sizes and three widths and are issued with 2 pairs of replaceable felt innersoles. They are designed to be worn with *only* socks, wool, ski, and should be worn with 2 pairs of these socks plus 1 pair of felt innersoles. If worn with any other type of socks the shoe-pacs will cause chafing or blistering and will not give proper support for the foot. Fitting of both shoe-pacs and the ski socks should always be done with great care or the advantage of this footgear will be lost.

(b) When shoe-pacs are not available, use overshoes, arctic with the boots, service combat or shoes, service. This will give a high degree of protection when worn with the following socks or sock combinations (listed in order of preference):

1. 2 pairs of socks, wool, cushion sole.
2. 1 pair of socks, wool, cushion sole; and 1 pair of socks, wool, light underneath.
3. 2 pairs of socks, wool, light.
4. 1 pair of socks, wool, heavy.

(c) As already stated, wool socks may shrink after several launderings. If the socks feel tight, they are certain to cut down the circulation. Do not continue to wear them but exchange them with the supply officer for socks of proper size. Leather shoes that become too tight should also be exchanged.

(5) Unit commanders must take every step possible to adequately equip and take care of their men. Clean socks should be provided by a daily exchange service. This is best done in the field at the time rations are issued. Pairing off men and holding each responsible for seeing that his partner changes to dry socks and massages and powders his feet once daily is an effective measure in trench foot prevention. When held in stationary positions under heavy enemy fire for long periods, rotation of units or at least small detachments of units a sufficient distance to the rear to give them a chance to change to dry socks and restore the temperature and blood circulation of their feet to normal is one of the best means for prevention. Frequent inspection of the men's feet and instruction in their care also should be conducted.

(6) Remember that no single type of footgear or combination of shoes alone will keep the feet dry and warm under the varying conditions met in combat areas. Proper footgear is at best only a help in keeping the feet warm and dry. The prevention of trench foot depends on the care given the feet by constant attention to *all* the rules outlined above.

h. Immersion foot. This is a foot condition resembling trench foot, caused by keeping feet immersed in cold water for long periods as occurs with survivors of shipwrecks and airplane personnel in forced landings over water. The quartermaster supplies immersion suits which are worn by combat air personnel in areas where required to prevent immersion foot and other injury to the body from such exposure. Smearing the feet and also body with a heavy grease, if available, is also helpful in preventing the harmful effects of cold water exposure.

i. Jungle foot. Jungle foot is caused by conditions similar to those of trench foot except that the water does not have to be cold. This complaint has occurred chiefly where men have been forced to wade repeatedly through tropical streams and mud without wearing waterproof or water-resistant footgear, or without stopping for several days or more to change to dry socks. It is particularly bad when complicated by fungus infection of the feet. The general principles described in preventing trench foot are equally useful in preventing jungle foot. The important thing is to keep the feet as dry and clean as possible. If you already have jungle foot, report to the aid station at once.

j. Frostbite of feet. Frostbite of feet occurs below freezing temperatures and develops much faster than trench foot. The toes are most frequently affected. The main prevention is in wearing sufficiently warm footgear to withstand the cold, and taking every opportunity to warm the feet near a fire or other heat source. Exercising the toes and feet inside the shoes and stamping on the ground stimulates the circulation thereby helping to keep the feet warm. If frostbite has already occurred, report to the aid station. It should be remembered that once frostbite occurs to a part, it will recur more easily the next time.

k. Foot inspection. Company officers should inspect feet of their men at regular intervals, and with special care particularly before long marches or before going into combat. Inspection should be made well in advance of the march or zero hour to see that each man is wearing well-fitted shoes and undamaged woolen socks. Special attention will be given to correction of improperly trimmed and ingrowing toenails, callouses, corns, and reddening of the skin, from wearing badly fitting shoes and poorly repaired socks.

208. RULES FOR AVOIDING DISEASE IN THE FIELD. No matter how strong or well-conditioned a

man may be, if enough germs enter his body his resistance will be overcome and a disease will develop. The following precautions on how to stay healthy apply particularly in the field but most of them hold good in garrison as well.

a. Don't drink water which has not been declared safe by a medical officer, unless it has been purified by water purification tablets, chlorination or boiling. Don't take water from a Lyster bag or other container by dipping a cup into it or by putting your mouth to the faucet. Do not use a drinking cup common to others.

b. Don't soil the ground with feces without burying them. In camp or garrison, always use the latrine or night urine can in the company street for disposal of body wastes.

c. Be sure mess kits, knife, fork, and spoon are thoroughly washed in hot soapy water; rinsed in boiling water; and disinfected in boiling water or a germicidal solution right after using. Keep mess gear clean between meals and again dip it in boiling water for disinfection just before using.

d. Use every means available to prevent mosquitoes and other insects from biting. (See ch. 7.)

e. Don't sit or lie directly on the damp ground if it can be avoided. Keep out of drafts when perspiring or while your clothing is damp.

f. Prepare a drainage ditch around tents as soon as they are put up, even if the camp is only for 1 night.

g. Prepare your bed before dark, and in temporary camps separate it from the cold ground with insulating material like straw, leaves, or tree branches and twigs. In the Tropics, leaves of coconut palms make a particularly fine insulation.

h. Don't exchange personal items like pipes, cigarettes, musical instruments played with the mouth, gas masks, handkerchiefs, towels, toothbrushes, and shaving outfits.

i. When water is available, drink as much as you need to quench your thirst. However, if overheated,

don't drink a large quantity of ice water at one time because it may cause stomach cramps.

j. Daily bowel movements are desirable but don't be alarmed if movements are less frequent, especially on a concentrated diet. Consult a medical officer before taking a laxative, *especially if you have a pain in the abdomen*. After emptying the intestinal tract with a laxative or enema, don't expect a normal bowel movement within 24 hours because it requires a longer time for sufficient waste products to form and cause a movement.

k. Wear loose-fitting clothing of proper weight for the climate. Change wet clothing, especially shoes and socks, as soon as possible.

l. Never throw pieces of food or other refuse around the camp or in your trench because they attract flies, rats, roaches, and ants. Instead, dispose of them in containers set up for this purpose or bury them.

m. Avoid contact with diseased persons as much as possible. This applies especially to natives in poorly sanitized areas.

n. Venereal diseases are almost always contracted by sexual intercourse with infected women. Therefore avoid the source of these diseases. If you have intercourse, use a condom and then report promptly (within 1 hour after contact if possible) to the dispensary or some other place designated for chemical prophylaxis. This prophylactic treatment must be carried out thoroughly and the directions followed exactly to get its full protective value (see par. 27). If you cannot get to a prophylactic station promptly, use the individual prophylactic kit.

209. IMPROVISED WASHING AND BATHING FACILITIES. a. Wash benches should be built in any camp lasting more than 3 days and should be located at the end of the company street nearest the latrine. Wash water may be disposed of in shallow trenches or even on the ground if the camp is of short dura-

tion. Otherwise, a grease trap and soakage pit or trench should be built since accumulated soap prevents soakage into the ground (see par. 73a).

b. If there is a running stream near camp it may be used for bathing if approved by the medical officer after checking contamination occurring upstream. The part to be used for bathing should be marked by flags and should not be used for drinking or brushing teeth. In tropical regions some streams, ponds, or lakes are unsafe for bathing and swimming. In such case, simple showers can be improvised for bathing. A Lyster bag containing treated water and hung from a limb or other high support affords one of the easiest means for taking a shower.

210. MONTHLY PHYSICAL INSPECTION. a. A physical inspection of all enlisted men is required at least once a month (AR 615-250). Noncommissioned officers are examined separately and individually. The inspection of each company is carried out by a medical officer in the presence of one of the company officers who notes and promptly arranges to correct any defects. In the absence of a medical officer or contract surgeon, an officer in each company conducts the inspection. Arrangements are made to schedule those absent from an examination, later in the month; men on furlough should be examined as soon as they return.

b. This examination is not, as is often wrongly believed, conducted solely to detect venereal disease; it should include also—

(1) Examination of feet, mouth, and teeth, and state of personal cleanliness.

(2) Search for lice.

(3) Investigation for signs of communicable diseases, such as respiratory diseases and skin infections.

(4) Inspection for evidence of any chronic disease.

(5) Observation of the nutritional state of each man to see if he is suffering from any deficiency in vitamins, minerals, or general food intake.

CHAPTER 14

DDT AND ITS USE AGAINST INSECTS

211. INTRODUCTION. a. DDT is a white crystalline substance which combines many of the qualities that one would look for in an ideal insecticide*. Many types of insects are killed by DDT either by merely coming into contact with it, or by swallowing it. Even those insects which come into a treated area 2 or 3 weeks later are killed. DDT is stable, colorless, and odorless; it may be used in a number of different forms. If used properly, DDT is not harmful to human beings; however, certain precautions must be taken which will be described. Several of the DDT insecticides should be applied only by trained personnel.

b. Despite its many desirable qualities, DDT should not be considered the answer to all insect problems. It does not relieve the Army of the need for carrying out other insect control measures already described, nor for keeping constant watch against all disease-bearing insects. However, it does provide a most effective aid against these insects, and should be used to the fullest degree. Its value will depend to a large extent on a complete understanding of the proper ways to use it.

c. Perhaps the outstanding characteristic of DDT is what is known technically as its "residual effect." This means simply that weeks, or even months, after it has been applied to clothing, a bed, wall or screen, or other surface, it will kill insects which rest or crawl

*The initials, DDT, stand for the chemical name, Dichloro-Diphenyl-Trichloroethane.

on the DDT deposited over such surfaces. Moreover, DDT requires only a brief contact with the insects to prove fatal. When swallowed by insects, DDT acts as a stomach poisoning; when insects crawl through DDT, they absorb it into their feet and other parts of their bodies which come in contact with DDT. Once in the body, DDT has a violent effect on the nervous system, paralyzing the insects until death occurs. In some cases, this may take several hours and the insects may have hidden or escaped outdoors. Death, nevertheless, is assured. For this reason the number of dead insects found on the floor should not be taken as the basis for determining how many were killed. Many others may have died unseen.

d. Another practical advantage is that when stored or exposed to high temperatures or sunlight for long periods of time DDT does not lose its effectiveness. Concentrated DDT, however, has a tendency to harden and form lumps, but this does not affect its usefulness in any way. DDT may be used in oil solutions, in emulsions, in suspensions, or in powder form in which it can be diluted with such neutral agents as pyrophyllite, talc, cement, condemned flour, road dust, or even fine sawdust.

e. DDT is practically insoluble in water. It is fairly soluble in mineral and vegetable oils, and readily soluble in many common organic solvents. Like other substances, it is more soluble at high temperatures than low ones. Its solubility in impure petroleum oils will vary with the nature of the oil.

f. The solubility of DDT in a number of common organic solvents is shown in appendix I.

212. LIST OF DDT INSECTICIDES. Because of the wide variety of uses to which DDT can be put, it is issued by the quartermaster in a number of forms. Some are finished preparations and some are stock mixtures. These are as follows:

a. **Insecticide, powder, louse, 2-ounce can.** QM No. 51-I-173, 10 percent DDT in pyrophyllite, packaged

48 cans to a carton, is intended primarily for individual use in the treatment and prevention of louse infestation.

b. Insecticide, powder, louse (bulk). QM No. 51-I-180, also 10 percent DDT in pyrophyllite, put up in 5-pound metal containers and packaged six containers to a box, is for use primarily in mass delousing with hand or power dusters. Its uses for control of other insects will be described later.

c. Larvicide, DDT, powder, dissolving. QM No. 51-L-120, a commercial grade of pure DDT put up in 10-pound metal containers packed four containers to a box, is issued for the preparation in the field of oil solutions for mosquito larviciding, or for making up residual spray and other DDT preparations when the finished product is not available.

d. Larvicide, DDT, powder, dusting. QM No. 51-L-122, 10 percent DDT in talc, put up in 5-pound metal containers, eight containers to a box, is designed for use as a dusting powder in mosquito larviciding. It can be used in place of louse powder for mass delousing when louse powder is not available as well as for the control of other insects such as roaches, ants, and fleas.

e. Insecticide, spray, DDT, residual effect. QM No. 51-I-305, 5 percent DDT in refined kerosene, put up in 5-gallon metal containers and 55-gallon steel drums, is issued primarily for fly and mosquito control and secondarily for the control of a number of other insects, such as fleas, bedbugs, roaches, and ants to mention those of military importance. It is designed for application to surfaces upon which insects crawl or rest exerting its effect by the prolonged residual action of the DDT deposit. This item probably has the widest usefulness of any of the DDT insecticides and gives long-term control in many instances. However, it should be applied by trained personnel. Extensive use of it should be made in areas where dysentery, diarrhea, and malaria rates are high. It also has an

application aboard ships to disinfect troop and other compartments such as storage spaces for dry stores.

f. Insecticide, liquid, finished spray. QM No. 51-I-169, now containing 1 percent DDT and 2½ percent thanite in kerosene and put up in 5-gallon metal containers, is for use as a general utility insecticide against all types of insects. It is applied directly to the insects in similar fashion to the common "flit-gun" type sprays. Stocks on hand of the old formula can easily be converted, if desired, by adding an equal amount of refined kerosene plus the necessary amount of DDT for a 1 percent DDT solution. Labels should be altered to indicate the DDT content.

g. Insecticide, spray, delousing. QM No. 51-I-310, containing 6 percent DDT, 68 percent benzyl benzoate, 12 percent benzocain and 14 percent Tween-80 (a hydrocarbon solvent), put up in 1-gallon and 5-gallon metal containers, is a concentrate and must be diluted one part concentrate to five parts water by volume to form an emulsion type spray. This emulsion is not stable and must be prepared just prior to use and used within 24 hours. It is employed principally in conjunction with fumigation or steam disinfection procedures for delousing and includes an effective scabidical agent.

h. Insecticide, aerosol, 1-pound dispenser. QM No. 51-I-159, containing 3 percent DDT, 2 percent pyrethrum extract (20 percent pyrethrins), 5 percent cyclohexanone, 5 percent hydrocarbon oil and 85 percent Freon-12, put up in steel cylinders under pressure, equipped with a release valve and packed 24 to a carton is designed primarily for control of adult mosquitoes. The DDT aerosol cylinders are finished in olive-drab; the old formula which depended entirely on pyrethrum for its insecticidal activity had its dispenser finished in black.

i. Insecticide, DDT, emulsion concentrate (formerly called insecticide, DDT, louseproofing, underwear). QM No. 51-I-95, containing 25 percent DDT, 10 percent Triton X-100, and 65 percent xylene, and put up

in 5-gallon metal containers, is issued primarily for impregnating underwear to make it louseproof. It must be diluted one part concentrate in eleven parts water to form an emulsion before treating underwear. After dipping and wetting the underwear, excess emulsion is squeezed or wrung out so that the weight of the underwear with the retained emulsion will be approximately twice its dry weight. In this way the recommended dosage of slightly over 2 percent DDT of the dry weight of the garment will be present in the fabric.

213. DISTRIBUTION. The allowances for distribution of the DDT insecticides are contained in War Department Circular No. 163, 1945. It must be kept in mind that other methods for insect control in use before the development of DDT should not be forgotten. These should be carried out wherever needed to supplement the use of DDT in order to provide full protection against insect-borne diseases.

214. PREPARATION IN THE FIELD. Many of the DDT insecticides are issued as finished products; others must be diluted or mixed with additional ingredients before being used. The methods of preparing the latter are given below.

a. Larvicide, DDT, powder, dissolving (Stock No. 51-L-120). (1) This is the only DDT insecticide issued which is 100 percent DDT. Before being used as a powder it usually must be reground. This concentrated DDT is issued for mixing in the field with suitable oils to make 5 percent to 0.5 percent DDT sprays for mosquito larviciding purposes by ground methods and by airplane. Use only *approved* solvents. Being straight DDT, it could also be used for making other DDT preparations when the finished product is not available. Adequate precautions must be taken in mixing and handling it to avoid harm to a person's body.

(2) To prepare a 5 percent (wt/vol) solution, this powdered DDT is dissolved at the rate of 7 ounces of DDT per gallon of No. 2 fuel oil, or similar petroleum products, such as kerosene, Diesel oil, and waste crankcase oil. The mixture is then stirred at intervals until all the DDT is in solution. This may require as long as 24 hours. If facilities are available, moderate heat may be applied to hasten the solution. Otherwise, allowing to stand in the sun will speed up solution somewhat. If the DDT contains large particles of foreign matter, the solution should be strained or allowed to stand and the clear liquid poured off after the foreign matter has settled.

(3) A 1 percent spray can be made by using one part of the 5 percent solution to four parts of larvicidal oil. A 0.5 percent spray can be made by diluting one part of the 5 percent solution with nine parts of larvicidal oil.

b. Larvicide, DDT, powder, dusting (Stock No. 51-L-122). This preparation consists of 10 percent micronized DDT in talc and should be mixed further with any available diluent such as talc, pyrophyllite, cement, condemned flour or road dust to prepare the final larvicidal dust. A final dust containing from 1 to 5 percent DDT is suitable for practical application, but 2 percent is recommended for average conditions.

c. Insecticide, spray, delousing (Stock No. 51-I-310). This item must be diluted one part concentrate to five parts water (by volume) to form an emulsion spray before use. Only a sufficient supply to meet the immediate need should be made, and it should be used within 24 hours after being mixed since the finished solution begins to lose its effectiveness after that time.

d. Insecticide, DDT, emulsion concentrate (Stock No. 51-I-95). This preparation is issued primarily for impregnating underwear in the field to render them louseproof for several months and through six to eight launderings. Before use it must be diluted one part emulsion concentrate to eleven parts water (by volume)

to form approximately a 2 percent DDT emulsion. Cover-alls, rubberized gloves, and suitable tongs should be used by those mixing the solution and treating the underwear. Only trained personnel should be employed. After garments have dried they can be handled without protection.

215. USES OF DDT. The chart given in appendix II indicates the types of DDT insecticides to be used and methods of using them against the various kinds of insects. The general discussion below of the use of DDT against each type of insect, which follows, should be supplemented by reference to the chart for additional information.

a. Mosquitoes. (1) DDT has greatly simplified mosquito control for the Army and plays a large part in keeping the incidence of malaria at a low level in highly malarious theaters. Larvicide, DDT, powder, dissolving, when dissolved in various oils and solvents makes an unusually effective mosquito larvicide, and also an adulticide. The solution should be mixed and applied by trained personnel who have been taught the precautions to observe. Solutions varying from 5 percent to 0.5 percent DDT may be used. The concentration may be varied depending on method of application. The important factor is the amount of the active ingredient, DDT, used. It is recommended that oil solutions be applied at such a rate as to give 0.1 to 0.25 pounds of DDT per acre. A 5 percent DDT solution requires approximately 1 quart per acre and a 0.5 percent DDT solution, $2\frac{1}{2}$ gallons per acre at the dose of 0.1 pound DDT per acre.

(2) Since the effectiveness of DDT depends on the material reaching the larvae, sufficient oil should be used to permit coverage. The minimum amount of DDT solution in oil which can be sprayed on an acre and obtain satisfactory results will vary with the type and DDT concentration of the spray available. The amount necessary will also depend on the density of

vegetation in the area being treated. In breeding places where the larvae are difficult to reach with a larvicide, heavier applications of DDT should be made. With such heavier applications considerable residual toxicity to larvae from the DDT may occur even after the oil has evaporated.

(3) DDT oil solutions can be applied by any of the methods used in the past for applying oils alone in larviciding. Pouring solutions from containers such as a bottle, can, or bucket where numerous, small separated areas are to be treated; application by containers of the drip-can type for flowing streams; soaking porous materials such as sawdust, sand, or wet gravel and scattering over the water surface, or placing the porous materials in a bag and submerging in ponds; spraying with various types of equipment available. All these are effective means within their proper limitations for larviciding with DDT oil solutions. Drip-cans should be checked frequently since some of the DDT may precipitate out and occlude the openings. Spray is the best method where large and fairly inaccessible areas are to be treated, taking advantage of wind drift. Nozzles of spraying equipment should be adjusted to give a fine spray depending upon the wind velocity and the area to be covered. Of the types of spraying equipment in the field the CWS decontamination sprayer (decontamination apparatus, 3-gallon) if available will prove the best. Knapsack sprayers issued by the Corps of Engineers (sprayer, insect, knapsack types, 5-gallon capacity; Stock No. 41-7839.5-5) are satisfactory but prone to spill solution on the back of the operator unless only partially filled.

(4) In running streams, open roadside ditches, and pools, a 5 percent DDT in oil solution is advised. Applications to running streams may be made at widely spaced points along the stream allowing the flow of the stream to spread the larvicide. The amount and distance between points of application will vary depending upon stream type, width, and rate of flow. For places where drip-cans and porous materials soaked

in oil have been used in the past suspended over or in streams to apply oils alone, DDT may now be added allowing a reduction in the amount of oil required. In calm waters a small amount should be poured on at different points in the breeding places. A squirt type oil can will facilitate application where several small places are to be treated. In larger places a lower percentage of DDT and a greater quantity of oil, applied with spray equipment, is recommended.

(5) Coverage can be obtained with smaller quantities of oil in area treatment if a fine spray is developed and advantage is taken of the wind drift as already pointed out. Swaths of 50 to 100 feet or more can be obtained depending upon type of spray, vegetative cover, and amount of breeze. This technique will overcome any difficulties that might be encountered caused by the nonspreading of oils. Under suitable conditions, area treatment may be used also where the breeding is in numerous disconnected places, such as for depressions, ruts, and hoofprints.

(6) As to effectiveness, an initial larvae kill of 95 percent or better is obtained from the recommended dosages. One application is usually adequate for 6 to 9 days. Heavier dosages of DDT in moderate to dense vegetation can be expected to give high residual toxicity to mosquito larvae, continuing even after the oil has evaporated. With the heavier applications, the DDT deposited on vegetation (until washed away by rains) will exert a continuing lethal effect to adult mosquitoes which rest thereon. Similarly, the larger doses of DDT in oil spread over water also will kill the adult mosquitoes which have alighted upon the water to deposit eggs. Hence, a very effective dual control, larvae and adults, can be achieved persisting 3 to 4 weeks and longer under suitable conditions.

(7) In preparation of new areas for attack and occupation by troops in highly malarious regions, the use of DDT oil solutions against adult mosquitoes is an even more important application than their use as mosquito larvicides. For this purpose, spraying of DDT

solutions from airplanes has been developed and is ideally suited. This has proved extraordinarily effective and equipment is continually being improved. Airplanes are given spraying missions just like bombing missions. This has reduced greatly the possibility of acquiring malaria in the first few days of invading such areas.

(8) Another item which is used for mosquito control is *larvicide, DDT, powder, dusting* for use on mosquito larvae as, paris green has been used in the past. The instructions for preparing the final larvicidal dust from this stock mixture are given in paragraph 212. It is applied with hand dusting equipment at a rate of 0.1 pound of active ingredient per acre, and will give practically 100 percent control for 1 week. The rotary hand duster supplied by the Corps of Engineers is suitable for this purpose.

(9) In thick vegetation, which will prevent shifting of surface dust films from wind and wave action, a residual kill for several weeks to 2 months after treatment may be expected if larger applications of 1 to 2 pounds of active ingredient per acre are made. Dusts with a percentage of DDT higher than 1 to 5 percent may then be used. In open breeding areas with relatively sparse vegetation, however, it is wasteful to apply more than 0.1 pound of DDT per acre since the treatment may become ineffective within a week due to this shifting of surface film. The time for additional treatments must be based on dipping records.

(10) The use of insecticide, DDT, residual effect for adult mosquito control is a highly effective long-term measure. When used in mosquito control, it is necessary to spray thoroughly the walls, doors, ceilings, screens, and other places in buildings, hutments, or tents where mosquitoes are prone to rest. Dark corners or other portions of sleeping quarters where mosquitoes are seen to rest in large numbers should receive an extra heavy spray application. In malarious regions, native habitations within a radius of at least 1 mile of

perimeter of the cantonment area should receive a residue spray treatment, and this may well precede spraying of military installations to kill infected mosquitoes at the source. Certain species, especially some of the anopheline mosquitoes, also rest in outbuildings such as barns, chickenhouses, and privies, and fly into human dwellings at night to feed, making it necessary to treat such buildings also. These, as well as mosquitoes that rest on the walls of living quarters either before or after feeding, will then be killed by contact with the DDT on the treated surfaces.

(11) An outdoor use is also recommended. For encampments, outdoor theaters, and other assembly places surrounded by dense vegetation in areas where the percentage of malaria infested mosquitoes is high, apply the residual spray to all vegetation in a 50-foot or wider band encircling the area to be protected. Experimentally this type of treatment has been found to cause up to a 95 percent decrease in the number of mosquitoes in the protected area up to a week and even longer. The duration of effectiveness will vary with the amount of rainfall, since rain will eventually wash the DDT deposit off the vegetation. The use of a vehicle for the DDT with greater viscosity than kerosene may prolong its effectiveness. This *barrier treatment* has proved highly effective and should be used wherever necessary.

(12) The use of DDT residual spray offers an efficient and easy procedure for continual destruction of mosquitoes over prolonged periods of time, and for protection against disease is a highly important use of DDT in destroying mosquitoes infected with malaria, yellow fever, filaria, and dengue.

(13) The *aerosol insecticide dispenser* has carved a secure place among the insect control weapons against mosquitoes. This handy, self-discharging, dispenser has proved invaluable to troops in highly malarious theaters for adult mosquito control. The addition of 3 percent DDT makes this insecticide even more ef-

fective. It is suited for use in all types of enclosures—barracks, billets, pup tents, bomb shelters, trenches, fox holes, etc. The insecticide is released in almost gaseous form (aerosol) which pervades the whole atmosphere in contrast to the ordinary sprays, and remains in a still atmosphere from 2 to 4 hours, thus giving continued protection against additional insects coming into the inclosure after time of application. It is used also in disinsection of aircraft to comply with quarantine requirements, and a few are made available for training purposes.

(14) The item, insecticide, liquid, finished spray, is a general utility spray and completes the array of DDT insecticides available for mosquito control.

b. Houseflies. (1) The control of flies depends on knowing their habits, ruining their breeding places, destroying their larvae, and killing the adults. In this, prevention of breeding is the most effective part of a fly-control program. To control breeding places, all human waste, animal manure, and garbage must be disposed of or treated promptly and effectively. The spraying of refuse piles, latrines, and the like, with DDT residual spray will be of considerable value in reducing the fly population. Neighboring native habitations in poorly sanitized areas are also frequently a major source of flies and should receive careful attention if at all possible, thereby allowing greater opportunity for contact action of the DDT.

(2) In treating latrines, the walls, ceiling, door and screens, as well as the inside walls of the latrine box, the walls of the pit, and the fecal contents should be sprayed. If use of the latrine can be spared until the spray deposit dries, the outside of latrine boxes should be treated also. Application of DDT residual spray is much more effective than the previous preparations used to kill flies breeding in the fecal material of pit latrines when flyproofing has been inadequate. On the fecal contents, the use of 2 ounces residual spray per latrine seat hole ($\frac{1}{2}$ ounce per square foot) applied

twice weekly at first is recommended. Local experience will determine if treatment need be repeated less often. The extensive use of DDT residual spray in areas with high diarrhea and dysentery rates constitutes an essential part of all fly-control programs.

(3) Larvicide, DDT, powder, dusting (10 percent DDT) may also be used for treating the pit walls and fecal contents of pit latrines. On the fecal contents, 4 ounces per latrine seat hole (1 ounce per square foot) applied twice weekly is recommended. Where temperatures are 70° or higher throughout the day and night, PDB (paradichlorobenzene) has been found highly effective also in controlling fly breeding in pit latrines. Two pounds per latrine hole is the usual initial dose with one pound per hole applied twice weekly thereafter.

(4) In mess halls and kitchens where flies are a problem, it is advisable to apply DDT residual spray thoroughly to the walls, doors, screens, ceilings, cross beams, light wires, light cords, and similar places. All food, cooking equipment, eating utensils, and table tops must be covered before spraying is begun. The application of residual spray with a paint brush to door and window screens alone sometimes will reduce the fly population considerably. However, more thorough application is advised. Cloth strips soaked in the residual spray and when dry, hung from the ceiling similar to present fly tapes are surprisingly effective. These should not be hung directly over mess tables. Application of residual spray to surfaces at the rate of 200 mg DDT per square foot will destroy flies for several weeks to several months or more, the duration of effectiveness depending on the type of surface and the degree of exposure of the treated area to weathering. At this rate, a quart of 5 percent DDT residual spray will cover approximately 250 square feet of surface. The spray should be reapplied when flies begin to show a definite increase in numbers.

(5) When immediate clearance of flies from a room

is desired, insecticide, liquid, finished spray which contains 1 percent DDT and 2½ percent thanite should be used. This is dispersed by means of the ordinary hand "flit" gun just as household type sprays in the past. No special precautions need be taken except to exclude gross contamination of food. Repeated use of this insecticide may in time result in the deposition of sufficient DDT on surfaces to obtain a slight residual action but its use for such purpose would be wasteful.

c. **Lice.** (1) The *control of lice* is of special importance particularly under combat conditions because of the seriousness of the diseases, epidemic typhus, relapsing fever, and trench fever, which they transmit. For both the treatment of lousiness and the prevention of further infestation, the application of DDT louse powder is the method of choice. For individual use, the 2-ounce cans of louse powder are available. For mass delousing with power dusting equipment, louse powder in bulk (10-pound cans) is available. In the latter, disrobing of the individual is not necessary for application of the powder. Dusting is accomplished by means of compressed air equipment (outfit, delousing, gasoline-engine driven) and a special dusting gun. This equipment is supplied by the quartermaster. For the impregnation of underwear, the DDT emulsion concentrate is issued. Thus, DDT can be used in its various forms for mass treatment, individual treatment, and for impregnation of clothing against lice. DDT louse powder dusted on garments is effective for 3 weeks to 1 month for body lice, but for head and crab lice the dusting must be repeated after 1 and 2 weeks. The powder is not effective against the eggs of lice.

(2) The residual spray will have the greatest use for control of lice in routine disinfestation of troop or other compartments aboard ship and on trains, but it is equally applicable to the eradication of such infestations in barracks or native dwellings. When used for lice disinfestation it should be applied to floors,

lower part of walls, and to bunks. Compartments may be reoccupied after drying and thorough airing for approximately 4 to 6 hours. Since this residual spray treatment gives long-term control, the need for repeated disinfestation should eventually become minimal. A routine treatment once every 2 to 6 months merely to maintain control should then be sufficient.

(3) For use in delousing centers, there is available the delousing spray (insecticide, spray, delousing) which may be safely sprayed on the hairy parts of the body and on the head. This insecticide is employed following the bath required in the fumigation or steam sterilization methods of disinfestation. The spray is both lousicidal and ovicidal and is also an effective scabicide when applied to the skin. About 20 cc ($2/3$ ounce) are required per person.

d. Mites. Mites or chiggers breed in areas of vegetation such as kunai grass and feed on rodents at a certain stage of their development. In addition to individual protective measures, control should be directed toward clearing camp areas of vegetation as well as toward the extermination of rodents. Heavy DDT spraying or dusting of the ground around beds and in camp areas may prove effective in eradicating mites but has not been fully evaluated. For individual protection, the wearing of dimethyl phthalate impregnated clothing has been used for temporary protection of troops operating in mite-infested areas. Even better and more prolonged protection is given by impregnating clothing with benzyl benzoate emulsion.

e. Fleas. (1) Fleas, important as vectors of bubonic plague and endemic typhus fever, are best controlled with DDT by treating infested human dwellings as well as the occupants and pets. In conjunction with rodent control programs, DDT louse powder or DDT residual spray may be applied to the floor and lower parts of walls of infested quarters. Dosages of 200 mgm of DDT per square foot are advised. On earthen floors the dosage must be considerably greater. Louse powder

should be used for the occupants and pets and may be applied by the same individual and mass delousing methods applicable in the control of lice to prevent epidemic typhus.

(2) For control of fleas on dogs and other pets *do not* use the DDT residual spray. A treatment using 10 percent of DDT in pyrophyllite, talc, or other dry inert diluent rubbed into the hair gives excellent results. The powder should be rubbed deep into the fur in order to minimize the danger of poisoning from the animal's licking the DDT. For average infestation, an application of DDT powder on the back of the neck may be all that is necessary.

f. Bedbugs. (1) For *control of bedbugs*, DDT residual spray has entirely replaced fumigation methods. Although a DDT dust application is effective against bedbugs, the residual spray method is recommended. The application of 4 to 6 ounces of residual spray per bed, including springs and mattress, will completely eradicate bedbug infestation for 6 or more months. Approximately 1 quart of the solution should be used for every five beds and mattresses. Spraying will be facilitated by placing mattresses eight high along the middle of the floor and standing the beds on end against the wall with the under side facing inward.

(2) In treating beds, application of the spray should be to the under side, paying attention to favorable hiding places, and allowing the surplus spray to fall on the wall behind the beds. In spraying mattresses, particular emphasis should be placed on treating all seams, crevices, and tufts. For expeditious handling, a team of two men is recommended: one to do the spraying, the other to turn over and remove each mattress after spraying. If no spraying equipment is available, application of the solution by means of a paint brush is satisfactory. A slight moistening of the surface is all that is required. The insecticide acts slowly, but when the above procedure is followed all bedbugs, as a rule, will be dead in 24 hours.

(3) No smoking or fires should be allowed in the quarters during spraying and the barracks should be aired out completely following the treatment, usually about 4 hours. Operating personnel should be required to wear suitable mask or respirators while in the barracks being treated.

g. Roaches. (1) Roaches may be controlled by the 5 percent DDT residual spray or a 10 percent DDT powder. A thorough application of DDT residual spray will give several weeks' or more protection from roaches or ants. The duration of the effect will depend to some degree on how quickly the residue is removed by the daily cleaning of the mess hall or other place of infestation. Glossy paint surfaces will have to be treated more often.

(2) The residual spray may be preferable for roach control work because treatment for control of flies and mosquitoes can be accomplished at the same time. Or, a combination of the two may be used. The spray is applied by ordinary hand sprayers or power sprayers to such resting and hiding places of roaches as under serving tables, sinks, cupboards, refrigerators, around water pipes and hot water tanks, and into cracks and crevices of the wall. It will be found that the German cockroach is more resistant than the American cockroach and an increase in dosage over 200 mg DDT per square foot when applying the residual spray may be necessary to effect its control. Areas treated should be well coated with the spray to insure maximum contact between the roaches and the DDT residue.

(3) The 10 percent DDT powder (larvicide, DDT, powder, dusting) for roach control is applied lightly with an ordinary hand-operated dust gun. Not over 10 pounds of powder is necessary to treat the largest mess hall. Application is made to the same locations one would apply residual spray. The powder is more readily removed in cleaning and may present an unsightly appearance.

h. Ants. For control of ants residual spray may be

applied to nests, door sills, window sills, foundations and other places where ants crawl. Lawns or grass plots where ants are prevalent can be treated with residual spray with the likelihood of better coverage and more prolonged action due to improved adherence of the DDT deposits to the grass, than when using DDT powder. However, "burning" of delicate grass may occur, and 10 percent DDT powder be preferable.

i. Ticks. In *control of ticks* the DDT preparations have not been found to be particularly effective and their use for this purpose cannot be recommended. The use of the standard triple-mixture repellent is the best measure available for individual protection against ticks. The wearing of clothing impregnated with an emulsion of dimethyl phthalate or sprayed with dimethyl phthalate also will give partial protection.

j. Other insects. The control of such insects as sand flies, midges, gnats, punkies, and dogflies (*Stomoxys calcitrans*) whose breeding places may be impracticable to destroy, can be controlled by the application of the DDT residual spray. Residual spray applied to screens and the outside of buildings and tents will usually reduce the number of such insects which may gain entrance. Application to the interior of the quarters as well will further enhance the effectiveness of control. The spraying of mosquito nets will fortify the protection afforded by such equipment.

216. TOXICITY. The DDT insecticides issued by the Army can be safely employed, but it must not be overlooked that DDT is a toxic material. In general, inhalation of dusts, sprays, or mists containing DDT should be reduced to a minimum. Whereas, dry DDT as used in inert powders is not absorbed through the skin, solutions of DDT in oils and organic solvents can be absorbed through the skin and, therefore, unnecessary skin contact should be avoided. For this reason, use of repellents in conjunction with DDT louse

powder is not advised; and garments, including DDT dusted or impregnated underwear, accidentally contaminated with oils in the presence of DDT should be changed as soon as practicable, the individual washing himself thoroughly with soap and water. Contamination of food with DDT must be prevented. This is especially important because DDT is a white, odorless and tasteless powder and offers no warning upon ingestion. Storage with food should be strictly prohibited to prevent mistaken identity. Symptoms of DDT toxicity in animals are anorexia, weight loss, hyperexcitability, tremor, and convulsions. Signs of liver and kidney disfunction may precede nervous manifestations. Pathological findings in fatal poisoning induced in animals consist in some evidence of degeneration of the anterior motor neurons, and may include toxic necrosis of the liver and kidneys. Anyone suspecting he is suffering from contact with DDT should report to a medical officer for examination.

APPENDIX I

SOLUBILITY OF DDT IN COMMON ORGANIC SOLVENTS (APPROXIMATE)

<i>Solvent</i>	<i>Gms. per 100 cc. of solvent at 27 to 30°C.</i>	<i>Ounces (Avoirdupois) per quart of solvent at 80 to 86°F.</i>
<i>Mineral oils:</i>		
Fuel oil No. 2	10	3.4
Fuel oil No. 1	8	2.7
Kerosene (crude)	8	2.7
Kerosene (refined, odorless)	4	1.3
<i>Vegetable oils:</i>		
Soybean oil	14	4.7
Tung oil	12	4.0
Sesame oil	10	3.4
Cottonseed oil	9	3.0
Castor oil	7	2.4
<i>Other solvents:</i>		
Cyclohexanone	100	33.6
Xylene	56	18.8
Acetone	50	16.8
Ether	27	9.1
Ethyl Alcohol (95%)	1.5	0.5
<i>Proprietary solvents:</i>		
“Kopper’s solvent No. 327” (Mixture of hydro-carbons from coal tar; boiling range from 230° to 270° C.)	63	21.2

“Velsicol AR-60” (alkylated naphthalene)	56	18.8
“Velsicol AR-70” (polymethyl naphthalene)	55	18.3
“Arcolor 1248” (chlorinated diphenyl)	29	9.7
“Stoddard solvent” (refined petroleum hydro- carbon used in dry clean- ing industry; distillation end-point 210°C.)	9	3.0

APPENDIX II DDT IN INSECT CONTROL

INSECT TO BE CONTROLLED	PLACE OF TREATMENT	DDT INSECTICIDE	AMOUNT AND METHOD USED; OTHER INSTRUCTIONS	TOXICITY TO HUMANS; PRECAUTIONS
A. FLY AND MOSQUITO ADULTS.	1. Inclosed spaces: barracks, rooms, barns, airplanes, pup tents, fox holes, etc.	<p>4. AEROSOLS or SPRAYS. (1) INSECTICIDE, AEROSOL, 1 - LB. DISPENSER. (0.4% pyrethrins + 5% DDT + 5% cyclohexanone + 5% hydrocarbon oil in Freon; finished item; QM #51-I-159.)</p> <p>(2) INSECTICIDE, LIQUID, FINISHED SPRAY. (1% DDT, 2½% thanite in refined kerosene; finished item; QM #51-I-169).</p> <p>(3) DDT SPRAY RESIDUE DEPOSIT. (a) INSECTICIDE, SPRAY, DDT, RESIDUAL EFFECT. (5% DDT mixed in crude kerosene available locally. Straight DDT, QM #51-L-120.) (5% DDT in kerosene; finished item; QM #51-I-305.)</p>	<p>Spray 4 seconds per 1000 cubic feet of space by releasing into the air of enclosure. Not necessary to spray insects directly since it acts like a gas. Effectiveness continues 2 to 4 hours after spraying. For flies use only against <i>biting</i> flies.</p> <p>General utility spray applied with ordinary flit-gun type hand sprayer. This insecticide should be sprayed <i>directly</i> on the insects to be killed, just like household type sprayer.</p> <p>Heavy wet spray (but not enough for run-off) on surfaces flies and mosquitoes rest. (1 qt. per 250 sq. ft.) One application usually eliminates flies and mosquitoes from treated building for 3 to 6 months. Highly effective for long-term control in camp or garrison.</p> <p style="text-align: center;">DON'T FORGET TO</p>	<p>Studies indicate nontoxicity when used properly at recommended dosages. Observe instructions on label.</p> <p>Studies indicate nontoxicity. No special precautions need be taken except those which will exclude the gross contamination of food.</p> <p>May be toxic if absorbed in sufficient amount. Avoid gross contamination of skin. Kerosene alone will often cause skin irritation. Coveralls and rubberized gloves should be worn when mixing or applying. Wear moistened gauze mask or suitable respirator when applying as a spray in closed</p>

T R E A T N A T I V E
S O U R C E S .

spaces. Wash skin with soap and water if contaminated. In mess halls, cover food, utensils and table tops. Bank or extinguish fires when necessary before spraying. Use only *trained personnel*.

(b) INSECTICIDE, D D T ,
EMULSION CONCENTRATED.
(25% DDT, 10% Triton X-100 + 65% xylene; stock mixture; QM #31-1-156.)

Mix one part concentrate with 4 parts of water and use same as in A1 a (3) above. Use only for flies and mosquitoes when specially required and authorized.

Studies indicate nontoxicity when used properly at recommended dosages. Observe same precautions as in A1 a (3) (a) above. Use only *trained personnel*.

2. Outdoors, by spraying from airplanes (M10 tanks, bomb bay tanks, oil drums, carried in C-47's, B-25's, etc.; or by Cub plane spray unit adaptation).

FAST MOVING PLANES (see findings AAF Board). SLOW MOVING PLANES—2 quarts of 5% DDT per acre will greatly reduce adult population and control mosquito larvae for 6 to 9 days. For a lasting spray effective over a longer period use 5 to 10 gallons of 5 to 10% DDT per acre. Material is poured or sprayed into slipstream of airplane in various ways.

Studies indicate nontoxicity when used properly at recommended dosages. Observe same precautions as in A1 a (3) (a) above. Use only *trained personnel*.

3. In jungles (ground treatment).

4. DDT SOLUTIONS. (5% DDT in kerosene or as a water emulsion).

Use 60-gauge nozzle on spray equipment. Atomize 1 quart per acre in underbrush for temporary control. Use 5 to 10 gallons per acre for a longer period of control. Around a clearing, apply

(See A1 a (1) above.)

INSECT TO BE CONTROLLED	PLACE OF TREATMENT	DDT INSECTICIDE	AMOUNT AND METHOD USED; OTHER INSTRUCTIONS	TOXICITY TO HUMANS; PRECAUTIONS
B. MOSQUITO LARVAE.	t. Rivers, lakes, swamps, pools, ruts, and water-containing receptacles around dwellings.	<p>a. INSECTICIDE, DDT, EMULSION-CONCENTRATE. (25% DDT + 10% Triton X-100 + 65% xylene. QM 51-I-156.)</p> <p>b. DDT OIL SOLUTIONS (1% DDT in kerosene or Diesel, fuel, or crankcase oil. Mix locally).</p>	<p>spray on vegetation in a 50-foot or wider band encircling area to form a barrier. Excellent reduction of mosquitoes and flies is obtained.</p> <p>Tie an aerosol bomb to end of stick and spray (bomb horizontal) 6 inches from ground. Apply in swaths at 20-foot or 7-pace intervals. One bomb per acre will control mosquitoes in jungles for about 12 hours. Temporary mosquito control in bivouac area.</p>	<p>Studies indicate nontoxicity when used properly at recommended dosages. Observe same precautions as in A1 a (3) (a) above. Use only trained personnel.</p>
B. MOSQUITO LARVAE.	t. Rivers, lakes, swamps, pools, ruts, and water-containing receptacles around dwellings.	<p>a. INSECTICIDE, DDT, EMULSION-CONCENTRATE. (25% DDT + 10% Triton X-100 + 65% xylene. QM 51-I-156.)</p> <p>b. DDT OIL SOLUTIONS (1% DDT in kerosene or Diesel, fuel, or crankcase oil. Mix locally).</p>	<p>Dilute 1 part concentrate + 24 parts water. Use 5 quarts per acre. Apply along water margins using a fine spray nozzle. Lasts 7 to 10 days.</p> <p>Prepare by adding 2 pounds DDT per 25 gallons of oil. Use 5 quarts 1% DDT per acre of water. Water-marin treatment.</p>	<p>Studies indicate nontoxicity when used properly at recommended dosages. Observe same precautions as in A1 a (3) (a) above. Use only trained personnel.</p> <p>Studies indicate nontoxicity when used properly at recommended dosages. Observe same precautions as in A1 a (3) (a) above. Use only trained personnel.</p>

<p>C. LICE (COOTIE GREY-BACK).</p>	<p>1. On body and clothing.</p>	<p>c. 5 to 10% DDT in water-emulsion, kerosene, hydrocarbon oil, Diesel oil, or combinations of these materials. Mix locally.</p>	<p>Spray from airplanes. Amount and method as listed in A2 <i>a</i> above for adults.</p>	<p>Ditto.</p>
<p>2. Body</p>	<p>DDT POWDER (10% DDT in pyrophyllite or other inert dusts). 2-ounce cans, QM #51-I-173; Bulk, QM #51-I-180.</p>	<p>INSECTICIDE, SPRAY, DELOUSING (68% benzyl benzoate + 12% benzocaine + 6% DDT + 14% Tween-80. QM #51-I-310).</p>	<p><i>Group delousing.</i> Thoroughly dust between inside garment and skin itself by applying dust gun at all openings of clothing. Apply 1.5 ounce per individual using hand dusters or power dusters. Body lice are most frequently found in the seams of clothing.</p> <p><i>Individual treatment.</i> Apply powder from sifter-top can over the entire inner surface of underwear and treat seams on the inside of shirt and trousers, use ½ to 1 ounce powder.</p>	<p>Do.</p>
<p>3. Clothes impregnation</p>	<p>INSECTICIDE, DDT, EMULSION-CONCENTRATE. (25% DDT, 10% Triton X-100 + 65% xylene; QM #51-I-156).</p>	<p>Dilute concentrate one part with five parts water and spray hairy parts of body with about 20 cc liquid. Also effective against scabies.</p>	<p>Dilute to 2% DDT with water (one part concentrate, eleven parts water). Dip underwear in prepared solution. Ordinary laundry facilities could be used. Use</p>	<p>Studies indicate nontoxicity when used properly at recommended dosages.</p>
<p>Studies indicate nontoxicity when used properly at recommended dosages.</p>	<p>Studies indicate nontoxicity when used properly at recommended dosages. Observe same precautions as in A1 <i>a</i> (3) (a) above. Use only trained personnel. Tongs</p>	<p>Studies indicate nontoxicity when used properly at recommended dosages. Protect eyes during application.</p>	<p>Studies indicate nontoxicity when used properly at recommended dosages. Observe same precautions as in A1 <i>a</i> (3) (a) above. Use only trained personnel. Tongs</p>	<p>Studies indicate nontoxicity when used properly at recommended dosages.</p>

INSECT TO BE CONTROLLED	PLACE OF TREATMENT	DDT INSECTICIDE	AMOUNT AND METHOD USED; OTHER INSTRUCTIONS	TOXICITY TO HUMANS; PRECAUTIONS
D. FLEAS.....	1. Rooms and rat burrows.....	INSECTICIDE. SPRAY, DDT, RESIDUAL EFFECT (5% DDT in kerosene; QM #51-1-305).	1 pint per suit underwear. 2% of dry weight of garment should be DDT. Renters louseproof for several months through 6 to 8 launderings.	should be provided for dipping underwear to avoid placing hands in solution.
E. BEDBUGS.....	2. On body, clothing, rooms, animal pets, and rat burrows.	DDT POWDER. (10% in pyrophyllite; QM #51-1-180 or QM #51-1-173.)	1 gallon per 1,000 square feet will give good results. In rooms, apply to floor and lower wall. Heavier dose required for earth floor. Light application over all surfaces and places to be treated. For group disinfection use hand dusters or power dusters with same technique as for group delousing.	Studies indicate nontoxicity when used properly at recommended dosages. Studies indicate nontoxicity when used properly at recommended dosages. Somewhat toxic to animals by licking coat. Treatment only to back of animal's neck will clear up average infestation.
E. BEDBUGS.....	Inclosed spaces, beds, and mattresses.	INSECTICIDE. SPRAY, DDT, RESIDUAL EFFECT (5% DDT in kerosene; QM #51-1-305.)	Thoroughly spray mattresses, beds, and into cracks and crevices in wall with particular attention to springs and the corners of beds. Residual effect of a year or more obtained.	Studies indicate nontoxicity when used properly at recommended dosages. Operators should wear moistened gauze masks or suitable respirators. Other precautions same as in A1 4 (3) (a) above. Use only trained personnel.

F. ROACHES.....	1. Inclosed spaces, under serving tables, sinks etc. including legs; along mopboards; into cracks and crevices; along border of ceiling and wainscoting; and in general, to all runways and hiding places for roaches.	a. INSECTICIDE, SPRAY, DDT, RESIDUAL EFFECT (5% DDT in kerosene; QM #51-1-305.)	Apply with sprayer or paint brush to form a film over surface. When dry, crystals of DDT will be seen adhering to surface if applied properly and thoroughly. Reapply every 2 weeks or less often if experience permits.	Studies indicate nontoxicity when used properly at recommended dosages. Observe same precautions as in A1 a (3) (a) above. Bark or extinguish fires when necessary before spraying. In mess halls, cover floors, sills, and table tops by spraying.
G. MITES.....	Damp ground and grass in camp areas.	b. DDT POWDER (10% DDT in talc; QM #51-1-122).	Apply by hand duster with particular reference to cracks, crevices, and behind objects. Reapply every 2 weeks or less often if experience permits.	Studies indicate nontoxicity when used properly at recommended dosage in mess halls, cover food and table tops by spraying.
H. ANTS.....	1. Nests and runways.....	DDT POWDER, (10% DDT in pyrophyllite or other inert dusts; 2 oz. cans, QM #51-1-173; bulk, QM #51-1-180.)	Apply liberally to damp ground and grass, paying particular attention to ground where men sleep. Order of effectiveness not completely evaluated.	Studies indicate nontoxicity when used properly at recommended dosages. No special precautions except in mess halls where one should avoid contamination of food, utensils and table tops.
		a. DDT POWDER. (10% DDT in pyrophyllite or other inert dusts.) Bulk, QM #51-1-180.	Dust is applied in a 3-inch wide strip encircling the nest; over the nest; and across or along the ants' runways.	

INSECT TO BE CONTROLLED	PLACE OF TREATMENT	DDT INSECTICIDE	AMOUNT AND METHOD USED; OTHER INSTRUCTIONS	TOXICITY TO HUMANS; PRECAUTIONS
		<p>b. INSECTICIDE, SPRAY, DDT, RESIDUAL EFFECT. (5% DDT in kerosene; QM #11-1-305.)</p>	<p>Spraying of runways and a thorough wetting of the ants' nests is very effective. On grass, lawns, spray may cause "burning," making use of 10% DDT powder preferable.</p>	<p>Studies indicate nontoxicity when used properly at recommended dosages. Precautions same as in AI a (3) (a) above. Use only <i>trained personnel</i>.</p>

REMARKS: Care should be taken that all DDT preparations are thoroughly mixed before using to assure that proper dosage is being applied. The 5 percent DDT residual spray at times will crystallize out when stored at cold temperatures. Warming will bring the DDT back into solution. The 10 percent DDT powders which are issued as finished items should be mixed thoroughly before using since stratification of active and inactive ingredients may possibly occur in repeated handling during shipment.

INDEX

	Paragraph	Page
Accessibility to water	42	32
Acclimatization	182	177
Acetone	App. I	222
Administration of VD control program	28	25
Advance quartering party	195	187
Aedes mosquito	118	114
Aerosol—		
Bomb	124, 162, 163	122, 161, 162
Insecticide dispenser	215	209
Killing	125	126
Sprays	App. I	222
Air-drying	105, 106	98, 77
Airplane dusting	121	119
Amebiasis	44, 53	34, 42
Amebic dysentery	15, 53	16, 42
Ampules methyl bromide	138	137
Animals	11	8
Anopheles mosquito	117	114
Anthrax	10	7
Antitoxin, tetanus	173	169
Ants	147	154
Aqueduct	43	33
Arcolor 1248	App. I	222
Arsenious oxide	168	166
Ash barrel grease trap	73	69
Atabrine	23	20
Athlete's foot	178, 207	171, 194
Treatment	179	172
Avoiding disease in the field, rules for	208	199
Bacillus of Ducrey	26	22
Bacterial food poisoning	15	16
"Bad blood"	26	22
Baffle grease trap	74	72
Bait:		
Fly	114	111
Mosquitoes	118	114
Rat	168, 169	166, 167
Roach	148	154
Bait chamber	113	108
Barium carbonate	168	166

	Paragraph	Page
Barrel:		
Grease trap	74	72
Serbian	138	137
Barrier treatment with DDT	215	209
Basin, settling	45	36
Bath and wash water, disposal	75	
Bathing	54, 138	76, 43, 137
Improvised facilities	209	201
Bed—		
Cubicles	14	13
Spacing	14	13
Bedbugs	144	152
Bins, vegetable	92	88
Biting—		
Flies	21	19
Midges	161	160
Black flies	161, 163	160, 162
Blisters	207	194
Blood flukes	44, 54	34, 43
Blood-sucking insects	11	8
Bodily care	205	193
Body louse	128	129
Boiling of water	45	136
Bomb, aerosol	124, 162, 163	129, 161, 162
Booster dose	173	169
Borax	61	160
Bored hole latrine	63	53
Bread	93	91
Breeding places:		
Flies, control	112	107
Mosquitoes	118	114
Bronchitis	13	12
Buboes	26	22
Bubonic Plague	21, 24, 149	19, 22, 155
Buffalo gnats	163	162
Bunions	207	194
Butter	89, 97	86, 93
Calcium—		
Cyanide	170	167
Hypochlorite	46	38
Calories	38	31
Camp site:	119, 182	117, 77
Desirable features	199	89
Procedure on arrival	196	87
Selection	197	88
Undesirable features	200	89
Canned foods	90	87
Canteen method (for chlorinating water)	48	40
Carbonate, barium	168	66

	Paragraph	Page
Carbon disulphide	170	167
Carbon monoxide poisoning of rats	170	167
Care of—		
Body	205	193
Feet	207	194
Fly traps	113	108
Mouth	206	193
Carriers	11	8
Case	11	8
Castor oil	App. I	222
Chamber, bait	113	108
Chancre, soft	26	22
Chancroid	26	22
Characteristics of—		
Bedbugs	145	153
Flies	110	107
Group	118	114
Lice	130	130
Mosquitoes	119	117
Rats	164	164
Wood ticks	141, 142	150, 151
Check valves	43	151
Chemical prophylaxis	27	23
Chickenpox	13	12
Chiggers	21, 151, 152	19, 156
Chironomidae	162	161
Chlorination	46	38
Chlorine, residual, testing	50	40
Cholera	12, 15	9, 16
Chopped meats	101	95
Cimex lectularis	144	152
Classification of		
Insect-borne diseases	21	19
Lice	128	129
Rats	165	164
Cleaning of utensils	104	98
Closed type incinerator	72	63
Cloth strips, impregnated	115	112
Clothing, protective	124	122
Coagulation	44	34
Collected washing	105	98
Collection of water	45	36
Commanding officers	4	2
Common cold	10, 13	7, 12
Communicable diseases	10	7
Compost—		
Area	78	78
Bin	78	78
Composting of manure	78	78

	Paragraph	Page
Compound germicidal rinse	100	94
Conditioning	183	179
Conduct of march	192	184
Conical hoop fly trap	113	108
Construction of latrines	59	46
Contact	11	8
Contagious diseases	10	7
Contamination, source of water	42	32
Control measures	12, 13, 27, 119	9, 12, 23 117
Control of—		
Animals	12	9
Ants	215	209
Bedbugs	215	209
Black flies	163	162
Breeding places	112	107
Carriers	12	9
Cases	12	9
Chiggers	154, 215	157, 209
Dermatophytosis	179	172
Eye gnats	159	159
Fleas	215	209
Flies	12, 17, 108, 111, 115, 215	9, 18, 05, 107, 112, 209
Intestinal diseases	17	18
Lice	127, 131, 215	129, 131, 209
Miscellaneous insects	140, 215	149 209
Mites	215	209
Other insects	215	209
Punkies	162	161
Rabies	175	170
Rats	164, 167	164, 165
Roaches and ants	148, 215	154, 209
Rodents	142, 150	151, 155
Sandflies	161	160
Scabies	177	171
Sources	12	9
Tetanus	173	169
Ticks	142, 215	151, 209
Venereal disease	27	23
Conventional signs	43	33
Cooked foods	103	97
Cootie	128	129
Corns	207	194
Cottonseed oil	App. I	222
Crab louse	128	129
Culex mosquito	118	114
Culicoides	162	161
Cyanide, calcium	170	167
Cyclohexanone	App. I	222

	Paragraph	Page
Dairy products	89	86
DDT	61, 115, 120, 122, 148, 150, 211	49, 112, 118, 120, 154, 155, 203
Larvicide	122	120
Residual spray	125, 146, 162, 163; App. II	126, 153, 161, 162, 224
Solubility in common organic solvents	App. I	222
Toxicity	216	220
Use	215	209
Deep pit latrine	61	49
Deerfly	21	19
Definition of communicable diseases		7
Delousing	131; App. II	131, 224
Plant	139	147
Dengue fever	21, 24	19, 22
Dermacentor Andersoni	141	150
Dermatitis, plant	180	174
Dermatophytosis	178	171
Development of—		
Housefly	109	105
Mosquito	117	114
Diarrhea	15	16
Diatomite filters	44, 53	34, 42
Dichloro-diphenyl-trichloroethane (DDT)		49, 112, 118,
61, 115, 120, 122, 148, 150, 211		120, 154, 155, 203
Diphtheria	11, 13	8, 12
Disciplinary measures:		
Malaria	126	128
VD control	30	27
Disease, source	11	8
Diseases:		7, 19, 22
Insect-borne	10, 19, 24	
Intestinal	10, 15	7, 16
Miscellaneous	10	7
Respiratory	10	7
Venereal	10	7
Dishwashing machines	105	98
Disinfection	53, 105, 106	42, 98, 99
Disinfestor	138	137
Disposal:		76
Bath and wash water	75	
Human waste	58	46
Manure	77	78
Rubbish	79	80
Distillation equipment	44	34
Distillation of water	44	34
Distribution of DDT	213	207

	Paragraph	Page
Ditching	123	120
Dog flies	156	158
Dogwood	180	174
Donovan body	26	22
Dose	26	22
Double barrel type disinfector	138	137
Drainage	123	120
Drinking water	55	44
Ducrey's bacillus	26	22
Dust control	14	13
Dust gun	134	132
Dusting by airplane	121	119
Dusting hints	137	137
Dysentery	11	8
Amebic	15, 53	10, 42
Early medical treatment	203	192
Edible garbage	67	58
Educational program for VD control	29	26
Eggs	87	85
Bedbug	145	153
Housefly	109	105
Louse	129	129
Mosquito	117	114
Tick	141	150
Elbows, pipe, symbol for	43	33
Emergency purification of water	43, 55	33, 44
Endemic typhus	21	19
Engineer water supply battalion	43	33
Engineers, responsibilities	6	5
Epidemic typhus	21	19
Epidermophytosis	178	171
Ether	App. I	222
Ethyl alcohol	App. I	222
Eutrombicula alfreddugesi	152	156
Exhaustion, heat	188	181
Exposure, heat, danger	186	180
Eye gnats	158	159
Facilities for mess	82	82
Fect, care	207	194
Fertilizer	78	78
Fever:		
Dengue	21, 24	19, 22
Japanese River	153	156
Oroya	161	160
Paratyphoid	12	9
Rabbit	21	19
Relapsing	21, 24, 144	19, 22, 52

	Paragraph	Page
Rocky Mountain spotted	12, 21, 141	9, 19, 150
Sandfly	21, 24	19, 22
Scarlet	10, 13	7, 12
Trench	21, 24	9, 22
Typhoid	11, 12	8, 9
Typhus	21	19
Yellow	12, 21, 24	9, 19, 22
Field mechanical purification equipment	44	34
Field water supplies	31	28
Filariasis	21, 34	19, 22
Filterable virus	26	22
Filters, diatomite	44, 53	34, 42
Filth diseases	15	16
Filtration	44	34
Fish	88, 95	85, 93
Fleas	21, 149, 215	19, 155, 209
Flies:		
Black	161	160
Dog	156	158
Sand	161, 163	160, 162
Stable	156	158
Flight range, houseflies	109	105
Fly—		
Bait	114	111
Control	12, 17, 108, 111, 115	9, 18, 105, 107, 112
Spray, ordinary	115	112
Swatting	115	112
Traps	113	108
Flypaper	115	112
Flyproofing latrine	61, 62	49, 53
Food	11	8
Handlers	17, 83	18, 83
Inspection	84	84
Poisoning, bacterial	15	16
Sea	88, 95	85, 93
Storage	91	87
Foot—		
Baths	179	172
Inspection	207	194
Formaldehyde	115	112
Frostbite of feet	207	194
Fruit	100	94
Fuel oil	App. I	222
Fumigation	138, 146, 170	137, 153, 167
Garbage	67	58
Burial	71	62
Cans	68	59

	Paragraph	Page
Edible	67	58
Nonedible	67	58
Pit or trench	71	62
Sale	69	61
Salvage	68	59
Gas chamber, methyl bromide	138	137
General resistance	14	13
German measles	13	12
Germicidal rinse, compound	100	94
Gleet	26	56
Gnats, eye	158	159
Gonococcus	26	22
Gonorrhea	10	7
Grade lines	123	120
Granuloma inguinale	26	22
Grease trap	74	72
Baffle	74	72
Barrel	74	72
Group—		
Characteristics of mosquitoes	118	114
Immunity	1	1
Protection	125	126
Gun, dust	134	132
Habits:		
Bedbugs	145	153
Mosquitoes	118	114
Rats	166	164
Halazone	46	38
Halts	193	84
Handlers, food	17, 83	18, 83
Handling—		
Dead rats	171	68
Food	91	87
Hash	101	95
HCN disks	170	67
Head louse	128	129
Health on march	194	85
Cramps	189	82
Heat—		
Exhaustion	188	81
Exposure, danger	186	80
Stroke	187	81
Heater, immersion type	107	00
Heating	13	12
Water	107	00
Helminth infections	15	16
Hints on dusting	137	37
Hippelates species	158	59

	Paragraph	Page
Hog feeding	70	18
Host	141	150
Housefly	109, 215	105, 209
Adult	109	105
Egg	109	105
Flight, range	109	105
Larva	109	105
Pupa	109	105
Hydrocyanic acid	169	167
Hydrophobia	174	169
Hygiene, personal	202	192
Hypochlorite solution	31, 46	28, 38
Immersion, foot	207	194
Immersion heater	107	100
Immunity	11	8
Group	1	1
Immunization	12	9
Impregnated cloth strips	115	112
Improvement of health, measures for	204	98
Incineration	72	63
Incinerator	72	63
Closed type	72	63
Cross trench and stack	72	63
Inclined plane	72	63
Rock pile	72	63
Inclined plane incinerator	72	63
Incubation period	11, 12	8, 9
Individual—		
Protection against mosquitoes	124	122
Washing	104, 106	98, 99
Infestation, prevention	143	151
Influenza	12, 13	9, 12
Ingrowing toenails	207	194
Insect-borne diseases	10, 19, 24	7, 19, 22
Insecticide—		
Emulsion concentrate	212; App. II	204, 224
Powder	212	204
Sprays	124, 132, 148, 212; App. II	122, 131, 154, 204, 224
Insecticides	132	131
Inspection of—		
Feet	207	194
Food	84	84
Inspection, physical	14, 210	13, 202
Intestinal diseases	10, 15	7, 16
Introduction	1	1
Introduction to fly control	108	105
Isolation	12, 13, 14	9, 12, 13

	Paragraph	Page
Itch, jockstrap	178	71
Japanese River fever	153	56
Jockstrap itch	178	71
Jungle foot	207	94
Kerosene	148; App. I	154, 22
Kitchen wastes	73	69
Kopper's solvent No. 327	App. I	22
Larva:		
Housefly	109	05
Louse	129	29
Mosquito	117	114
Tick	141	150
Larvicide	121, 214	119, 207
Laryngitis	13	12
Latrine:		
Construction	59	46
Deep pit	61	49
Straddle trench	60	47
Leaker	90	87
Leishmaniasis	144, 161	152, 160
Lice	21	19
Classification	128	129
Control	127, 215	129, 209
Life cycle of louse	129	129
Liquid waste	73	69
Location of—		
Fly traps	113	208
Water supply	42	32
Lockjaw	172	169
Louse:		
Body	128, 129	129
Crab	128, 129	129
Head	128, 129	129
Lues	26	22
Lymphogranuloma venereum	26	22
Lyster bag	31, 47	28, 38
Machines, dishwashing	105	98
Maggots	109	105
Malaria	11, 21, 23	8, 19, 20
Malaria discipline	126	128
Manure	76	76
Disposal	77	78
Maps	43	33
March—		
Conduct	192	184
Hygiene	183, 191	177, 183

	Paragraph	Page
Means of transmission	11	8
Measures to protect and improve health	204	193
Meat	85, 94	84, 92
Mechanical prophylaxis	27	23
Medical—		
Department	5	2
Inspector	5	2
Meningococcus meningitis	13	12
Mess—		
Administration	81	81
Facilities	82	82
Kit, washing	107	194
Sanitation	13, 17, 80	12, 18, 81
Methyl bromide	138, 169	137, 167
Gas chamber	138	137
Midges, biting	161	160
Military sanitation	1	1
Milk	89, 96, 102	86, 93, 96
Dry, whole	102	96
Pasteurized	102	96
Powdered	102	96
Raw	13	12
Unpasteurized	13	12
Mineral oils	App. I	222
Miscellaneous diseases	10	7
Mites	151	156
American	152	156
Oriental	153	156
Mobile purification unit	43, 44	33, 34
Molds	10	7
Monthly physical inspection	210	202
Mosquito—		
Bomb	125	126
Development	117	114
Nets	124	122
Proofing	125	126
Mosquitoes	116	114
Mound latrine	62	53
Mouth, care	206	193
Mumps	13	12
Musca domestica	109	105
Need for waste disposal	56	45
Nets, mosquito	124	122
Night urinal cans	63	55
Nit	129	129
Nonedible garbage	67	58
Nymph:		
Bedbug	145	153

	Paragraph	Page
Louse	129	129
Tick	141	150
Oil-water flash burner	72	63
Oiling of streams and ponds	120	118
Onchocerciasis	163	162
Orders, sanitary	8	6
Oriental mites	153	156
Oroya fever	161	160
Orthotolidine	50	40
Otway pit	64, 65	54, 55
Overcrowding, prevention	13	12
Pack filter	44	34
Pail—		
Latrine	64	54
Strainer	74	72
Paper, fly	115	112
Parasitic worms	10	7
Paratyphoid	12	9
Paris green	121	119
Pasteurized milk	102	96
Pediculus humanus capitis	128	129
Pediculus humanus corporis	128	129
Period of incubation	11, 12	8, 9
Personal—		
Cleanliness	17	18
Hygiene	202	192
Phlebotomus	21, 161	19, 160
Phosphorus	168	166
Phthirus pubis	128	129
Physical inspection	210	203
Pipeline	43	33
Plague:		
Bubonic	21, 24, 149	19, 22, 155
Pneumonic	12	9
Plant:		
Delousing	139	147
Dermatitis	180	174
Pneumonia	10, 13	7, 12
Pneumonic plague	12	9
Poison—		
Bait, roach	148	155
Elder	180	174
Ivy	180	174
Oak	180	174
Sumac	180	174
Poisoning food, bacterial	15	16
Poisons, fly	215	209

	Paragraph	Page
Portable—		
Filter	44	34
Purification unit	43, 44	33, 34
Poultry	86, 94	85, 92
Powder	134, 155	132, 157
Dusting, larvicide DDT	215	209
Prebaiting	168	166
Preparation of—		
Bait	168	166
Food	99	98
Prevalence of—		
Insect-borne diseases	22	20
Intestinal diseases	16	17
Prevention	29	26
Prevention of—		
Infestation	143	151
Overcrowding	14	13
Procedure on arriving at camp site	196	187
Pro kit	27	28
Prophylaxis, venereal	26	22
Protection:		
Group	125	126
Individual	124	122
Protective—		
Clothing	124	122
Measures for chiggers	155	157
Psychodidae	162	161
Pulmonary tuberculosis	13	12
Pump	43	38
Punkies	162	161
Pupa:		
Housefly	109	105
Mosquito	117	114
Purification:		
Portable unit	43, 44	33, 34
Water	12, 17, 43, 55	9, 18, 33, 44
Quality of water available	42	32
Quantity of water available	42	32
Quarantine	12	9
Quartermaster Corps, responsibilities	7	5
Quinine	23	20
Rabbit fever	21	19
Rabies	10, 174	7, 169
Railway, waterpoint	43	33
Range of flight, houseflies	109	105
Rats, characteristics	164	164
R. Alexandrinus	165	164

	Paragraph	Page
R. Norvegicus	165	164
R. Rattus	165	164
Raw milk	13	12
Raw vegetables	100	94
Reconnaissance check list for water supply	42	32
Red squills	168	166
References	3	2
Reflex sweating	190	182
Relapsing fever	21, 24, 144	19, 22, 152
Removal of—		
Roaches	147	154
Ticks	143	151
Repellents	124, 143, 155, 157, 160, 162, 163	122, 151, 157, 159, 161, 162
Reports, sanitary	9	6
Requirements:		
Salt	185	180
Water	184	178
Residual chlorine, testing	50	40
Residual sprays	114	111
Resistance, general	15	16
Respiratory diseases	10	7
Responsibility	4, 36, 40, 57, 81, 119	2, 32, 45, 81, 117
Mess operations	81	81
Waste disposal	57	45
Water reconnaissance	39	32
Rickettsia	130	130
Ringworm	178	171
Rinse, compound germicidal	100	94
Roach powder	148	154
Roaches	147	154
Rock pile incinerator	72	63
Rocky Mountain spotted fever	12, 21, 141	9, 19, 150
Rodent control	150	155
Rubbish, disposal	79	80
Rules for avoiding disease in the field	208	199
Salads	101	95
Salt requirements	185	180
Sand filter	44, 53	34, 42
Sandfly	161, 163	160, 162
Sandfly fever	21, 24	19, 22
Sanitary—		
Camp installations, reference, data	201	190
Control, water	37	30
Discipline	17	18
Fill	71	62
Orders	8	6

	Paragraph	Page
Reports	9	6
Sanitation details	5	2
Sanitation of—		188
Camp sites	198	
Mess	13, 17, 80	12, 18, 81
Scabies	10, 176	7, 170
Scarlet fever	10, 13	7, 12
Schistosomiasis	44, 54	34, 43
Screening	82, 125, 162, 163	82, 126, 161, 162
Scrub typhus	153	156
Seafood	88, 95	85, 93
Sean squirrel	128	129
Sedimentation	44, 53	34, 42
Selection of camp site	197	188
Serbian barrel disinfector	138	137
Serving of food	99	93
Sesame oil	App. I	222
Settling basin	45	36
Shaving	138	137
Shoc-pac	207	194
Shoes	207	194
Sifter can	135	134
Similium species	163	162
Site, camp	119	117
Smallpox	12, 13	9, 12
Soakage—		
Pit	66, 73	55, 69
Trenches	73	69
Socks	207	194
Sodium—		
Fluoride	148	154
Salicylate	115	112
Soft chancre	26	22
Solubility of DDT in common organic solvents	App. I	222
Sore throat, streptococcus	13	12
Source of disease	11	8
Sources of water existing	42	32
Soy bean oil	App. I	222
Spacing of beds	13	12
Sprayer, knapsack	120	118
Spraying camp sites	142	151
Sprays:		
Insecticide	124	122
QM general utility	146	153
Residual	114	111
Special control measures	12	9
Spread of disease	11	8
Springer	90	87

	Paragraph	Page
Springs, water	42, 43	32, 33
Square trap	113	108
Squills, red	168	166
Stableflies	156	158
Stack, construction of for incinerator	72	63
Stands for garbage	68	59
Sterilizer, steam	138	137
Stoddard solvent	App. 1	222
Stomoxys calcitrans	156	158
Storage	138	137
Facilities for food	92	88
Of clothing as disinfector	138	137
Of food	91	87
Straddle trench latrines	60	47
Stragglers on march	194	185
Strainer, pail	74	72
Stream training	123	120
Streams	42	32
Stroke, heat	187	181
Strychnine	168	166
Sulfur powder	155	157
Sullage pit	73	69
Surgeon	5	2
Susceptibility	11	8
Suspect	11	8
Suspended food container	92	88
Swatting of flies	115	112
Sweating, reflex	190	182
Sweller	90	87
Swimming	54	43
Symptoms	29	26
Syphilis	10	7
Tees, pipe, symbol for	43	33
Tetanus	10, 12, 172	7, 9, 169
Antitoxin	173	169
Toxoid	173	169
Thallium sulfate	168	166
Theaters of operation	5	2
Ticks	21, 140	19, 149
Tinea	178	171
Toenails, ingrowing	207	194
Toxicity of DDT	216	220
Toxoid, tetanus	173	169
Training, of streams	123	120
Transmission, means	11, 29	8, 26
Trap:		
Cage	169	167
Chamber	113	108

	Paragraph	Page
Fly	113	108
Rat	169	167
Setting	169	167
Snap	169	167
Square	113	108
Triangular	113	108
Trapping of rats	169	167
Treatment	29	26
Barrier with DDT	215	209
Of athlete's foot	179	172
Trench—		
Fever	21, 24	19, 22
Foot	207	194
Trench mouth (see Vincent's Angina)	13	12
Treponema pallidum	26	22
Trichina	103	97
Tricophytosis	178	171
Trombicula akamushi	153	156
Tropical—		
Bubo	26	22
Sore	26	22
Tsutsugamushi	153	156
Tuberculosis	10, 13	7, 12
Typhoid fever	11, 12	8, 9
Typhus fever	11, 21, 24	8, 19, 22
Underground—		
Cooling boxes	92	88
Ice box	92	88
Storage pits	92	88
Storage rooms	92	88
Unpasteurized milk	13	12
Urine—		
Soakage pit	66	55
Trough	66	55
Use of DDT	215	209
Utensils, cleaning	104	98
Vaccination	1	1
Valves, pipe, symbol for	43	33
VD control officer	27	23
Vegetable bins	92	88
Vegetables	98, 100	93, 94
Velsicol:		
AR 60	App. I	222
AR 70	App. I	222
Venereal disease	10, 25	7, 22
Ventilating shaft for urinal	66	55
Ventilation	12, 13	9, 12

	Paragraph	Page
Veterinarian	5	2
Virus	10, 26	7, 22
Wash rack for garbage cans	68	59
Washing—		
Collected	104, 105	98
Facilities improvised	209	201
Individual	104, 105	98
Mess kits	107	100
Waste—		
Disposal	12, 16, 17, 56	9, 17, 18, 45
Kitchen	73	69
Liquid	73	69
Motor oil	72	63
Water	11, 31	8, 28
Cart	43	33
Discipline	38	31
Distillation	44	34
Drinking	55	44
For beverages	55	44
Handling protection	54	43
Heating	107	100
Point	43	33
Pure, necessity for	31	28
Purification	45, 53	36, 42
Tablets	51	42
Quality	34	29
Reconnaissance	39	32
Requirements	32, 184	28, 178
Sources	33	29
Sterilizing bag	47	38
Supply battalion, engineer	43	33
Supply:		
Protection	35	29
Responsibility for	36	30
Tank train	43	33
Treatment	54	43
Truck	43	33
Watertight container	92	88
Wells	42	32
Whooping cough	13	12
Wood ticks	140	149
Worms, parasitic	10, 15	7, 16
Wyes, pipe, symbol for	43	33
Xylene	App. I	222
Yeast	10	7

	Paragraph	Page
Yellow fever	12, 21, 24	9, 19, 22
Zinc phosphide	168	166